

## Teil II: Anhang und Tafeln



































































## Legende Architekturpläne

Asche 

D Durchgang/ Tür

ZD zugesetzter Durchgang/ Tür

Fs Feuerstelle

G Gefäß

GM Gipsmulde

Kies 

M Mauer

Steine 

T Tannur

Türangelstein 

VGR Vorratsgrube

N 70,0  
O 80,0  
+

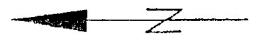

+ 65,0

N 60,0  
O 80,0  
+

75,0  
+

70,0  
+

+ 75,0

+ 70,0

N 70,0  
N 65,0  
+

65,0  
+

N 60,0  
O 65,0  
+



TALL KNĒDIĞ/ NO-SYRIEN  
GEBÄUDE I  
AUFNAHME: BODENSTEIN/ BORCHERT  
ZEICHNUNG: HINZ

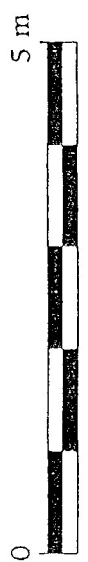

**TAFEL 1**

N 75,0  
O 60,0 +

65,0  
+

70,0  
+

75,0  
+

N 75,0  
O 80,0 +

70,0 +

+ 70,0

65,0 +

+ 65,0

60,0 +

+ 60,0

55,0 +

+ 55,0

N 50,5  
O 60,0 +

65,0  
+

70,0  
+

75,0  
+

N 50,5  
O 80,0 +

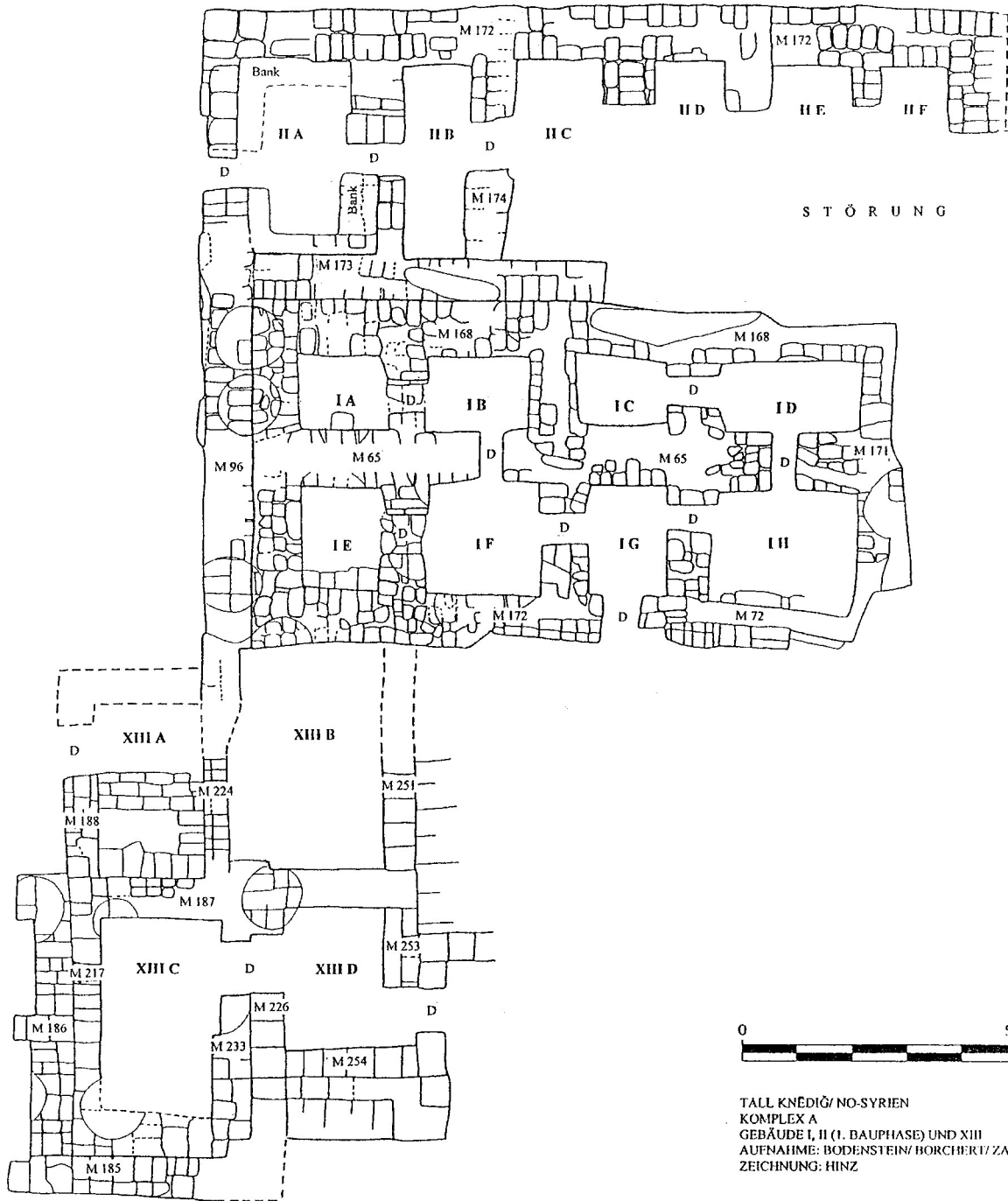

TALL KNEDIĞ/NO-SYRIEN  
 KOMPLEX A  
 GEBÄUDE I, II (I. BAUPHASE) UND XIII  
 AUFNAHME: BODENSTEIN/BORCHERT/ZART  
 ZEICHNUNG: HINZ

**TAFEL 2**

N 75,0  
O 60,0 +

65,0  
+

70,0  
+

75,0  
+

+ N 75,0  
O 80,0

70,0 +

65,0 +

60,0 +

55,0 +

N 50,5  
O 60,0 +

65,0  
+

70,0  
+

75,0  
+

+ N 50,5  
O 80,0

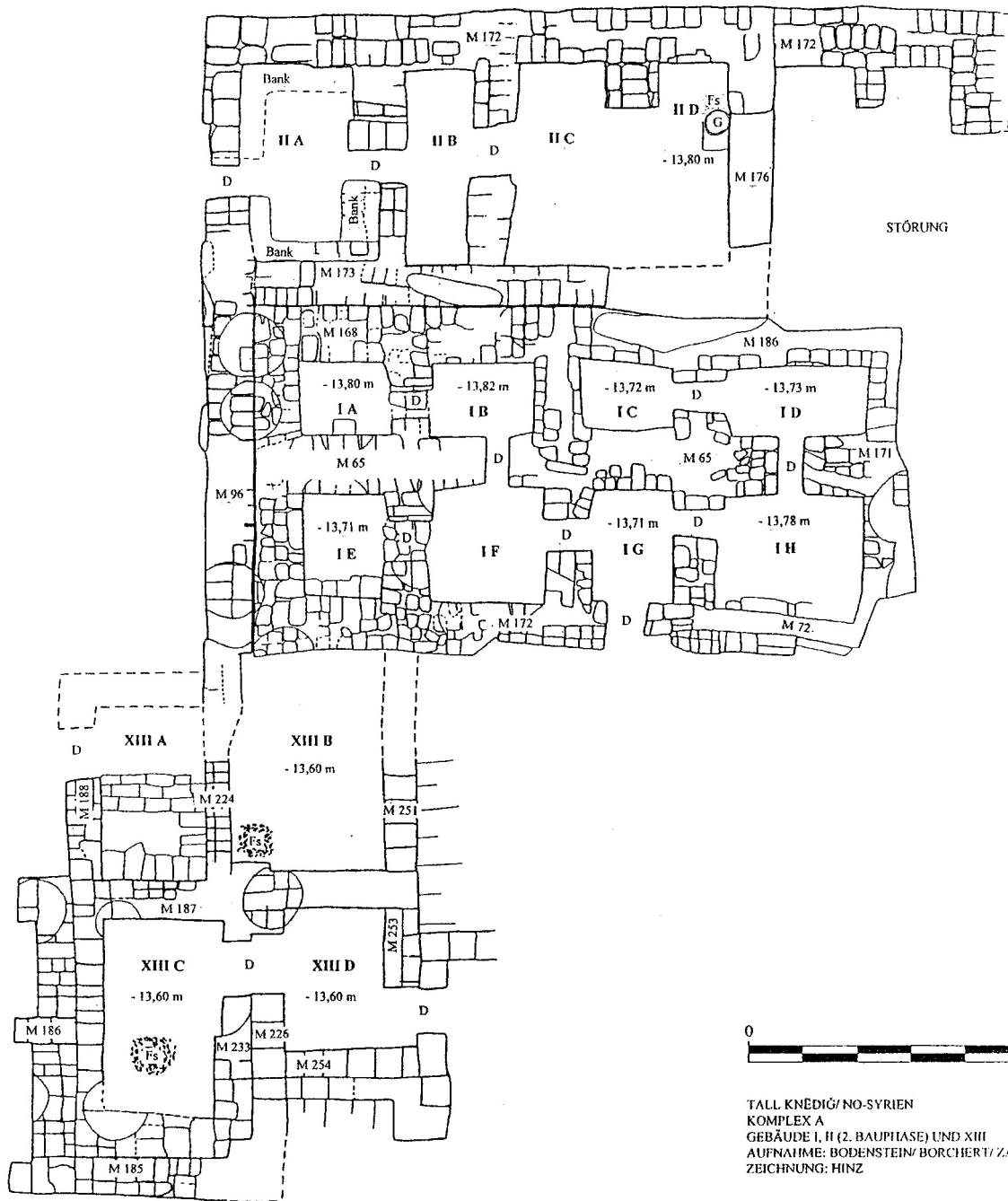

TALL KNEDIĞ/NO-SYRIEN  
 KOMPLEX A  
 GEBÄUDE I, II (2. BAUPHASE) UND XIII  
 AUFNAHME: BODENSTEIN/BOCHBERT/ZARI  
 ZEICHNUNG: HINZ

**TAFEL 3**

N 75,0  
O 55,0

60,0

65,0

70,0

75,0

N 75,0  
O 80,0

70,0

+ 70,0

65,0

+ 65,0

60,0

+ 60,0

55,0

+ 55,0

N 50,5  
O 55,0

60,0

65,0

70,0

75,0

N 50,5  
O 80,0

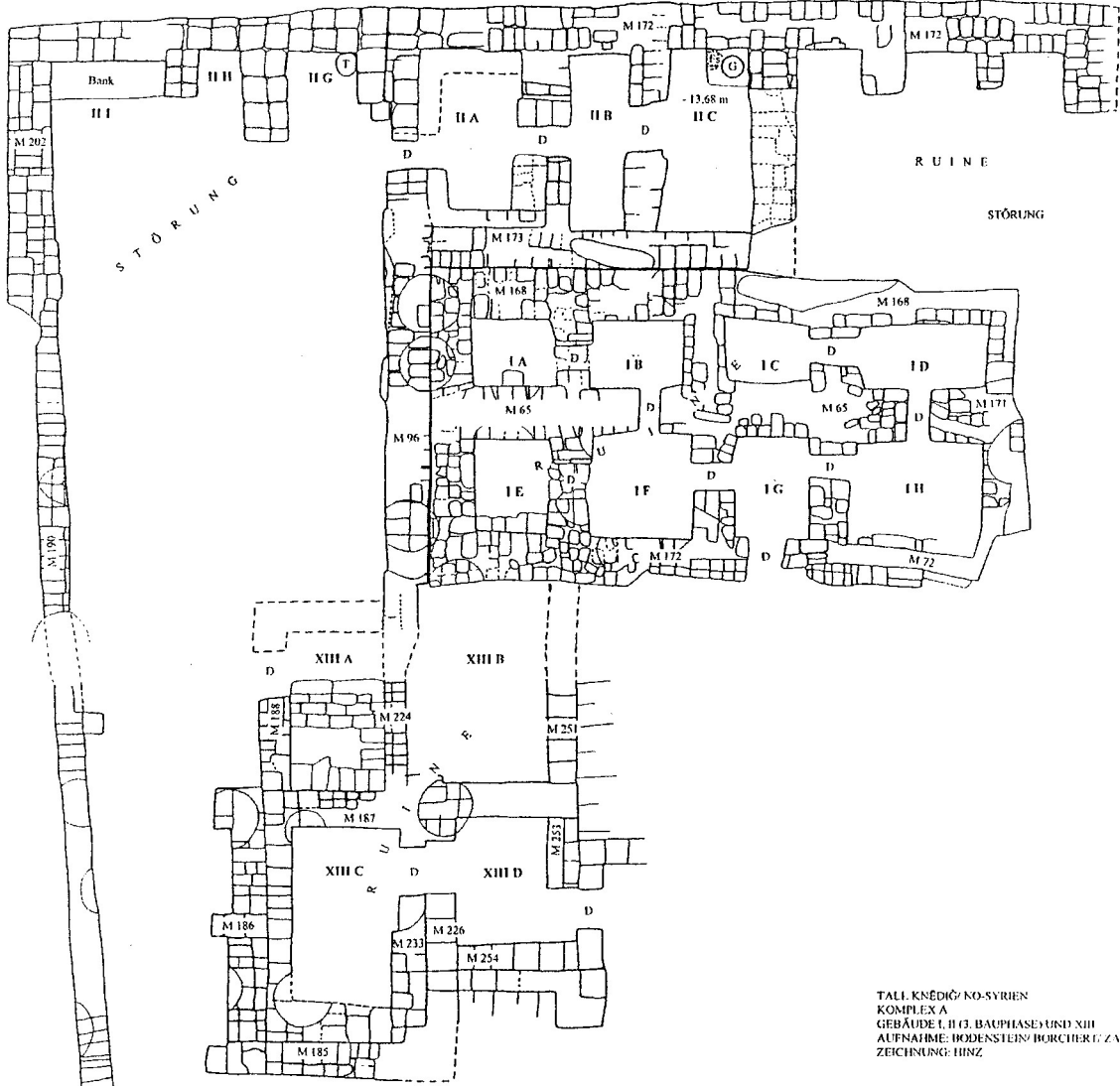

TAL. KNÉDÍČ KO-SYRIEN  
 KOMPLEX A  
 GEBÄUDE I, II (3. BAUPHASE) UND XIII  
 AUFNAHME: BODENSTEIN-BORCHERT, ZARF  
 ZEICHNUNG: HINZ

**TAFEL 4**

N 75,0 +  
 O 55,0 +

60,0 +

65,0 +

70,0 +

75,0 +

N 75,0 +  
 O 50,0 +

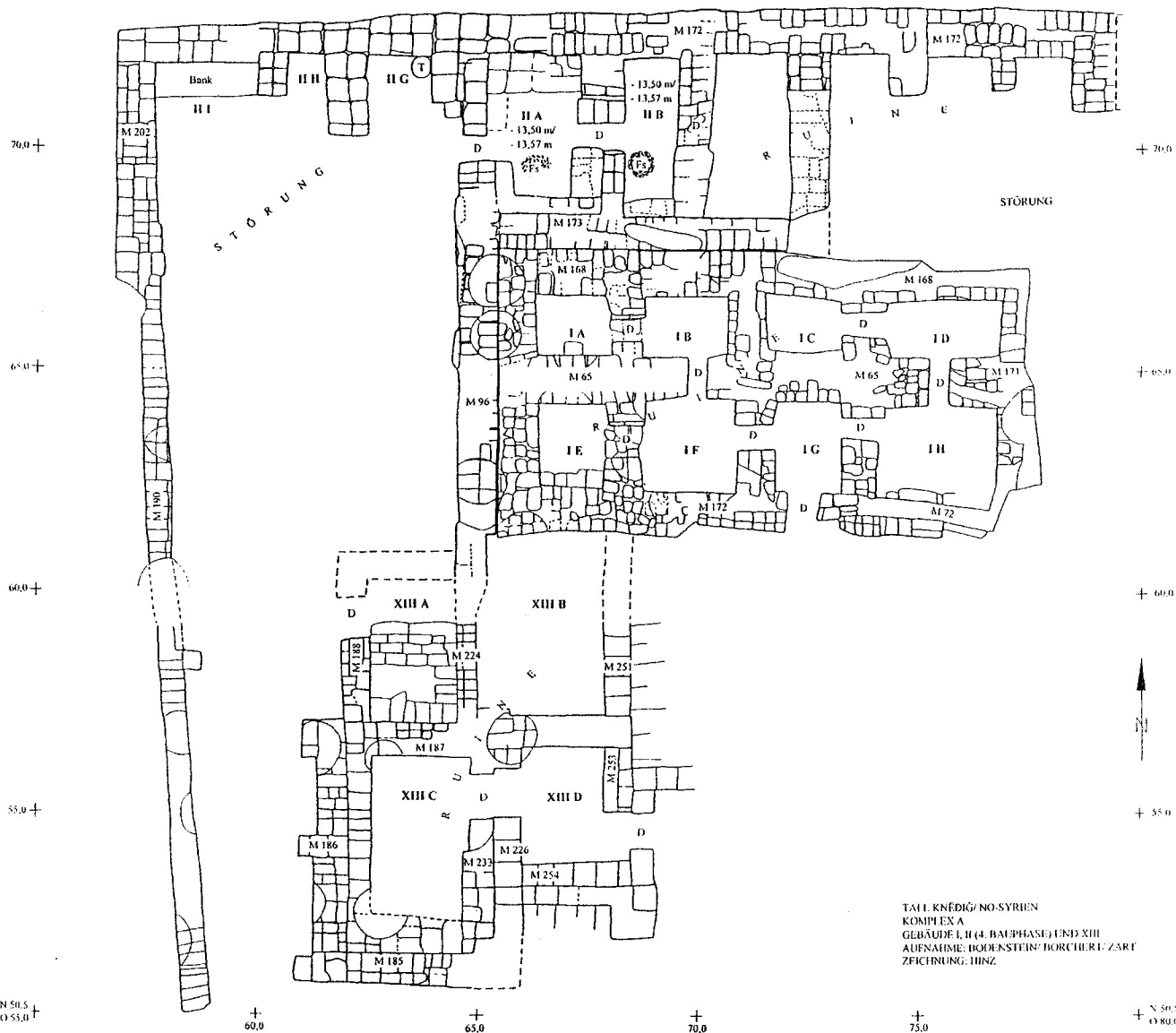

TALL KNÉDÍQ/NO-SYRIEN  
 KOMPLEX A  
 GEBÄUDE I, II (4. BAUPHASE) UND XIII  
 AUFNAHME: BODENSTEIN-BOURCHERL-ZART  
 ZEICHNUNG: HINZ

N 50,5 +  
 O 55,0 +

60,0 +

65,0 +

70,0 +

75,0 +

N 50,5 +  
 O 50,0 +



**TAFEL 5**



N 75,0  
O 45,0 +

50,0  
+

55,0  
+

+ N 75,0  
O 60,0

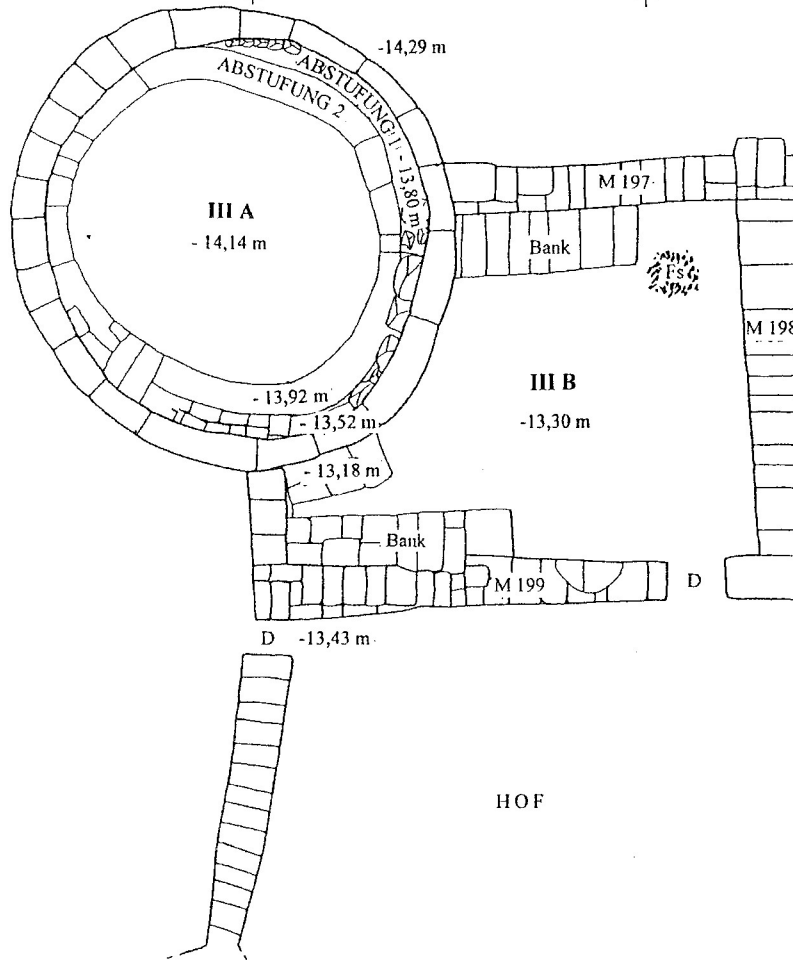

70,0 +

+ 70,0

65,0 +

+ 65,0

N 60,0  
O 45,0 +

50,0  
+

55,0  
+

+ N 60,0  
O 60,0



TALL KNĒDIĞ/ NO-SYRIEN  
KOMPLEX B  
AUFNAHME: ZART  
ZEICHNUNG: HINZ

# TAFEL 6

N 75,0  
+  
O 55,0

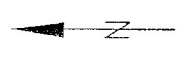

+ 70,0

+ 65,0

N 60,0  
+  
O 35,0

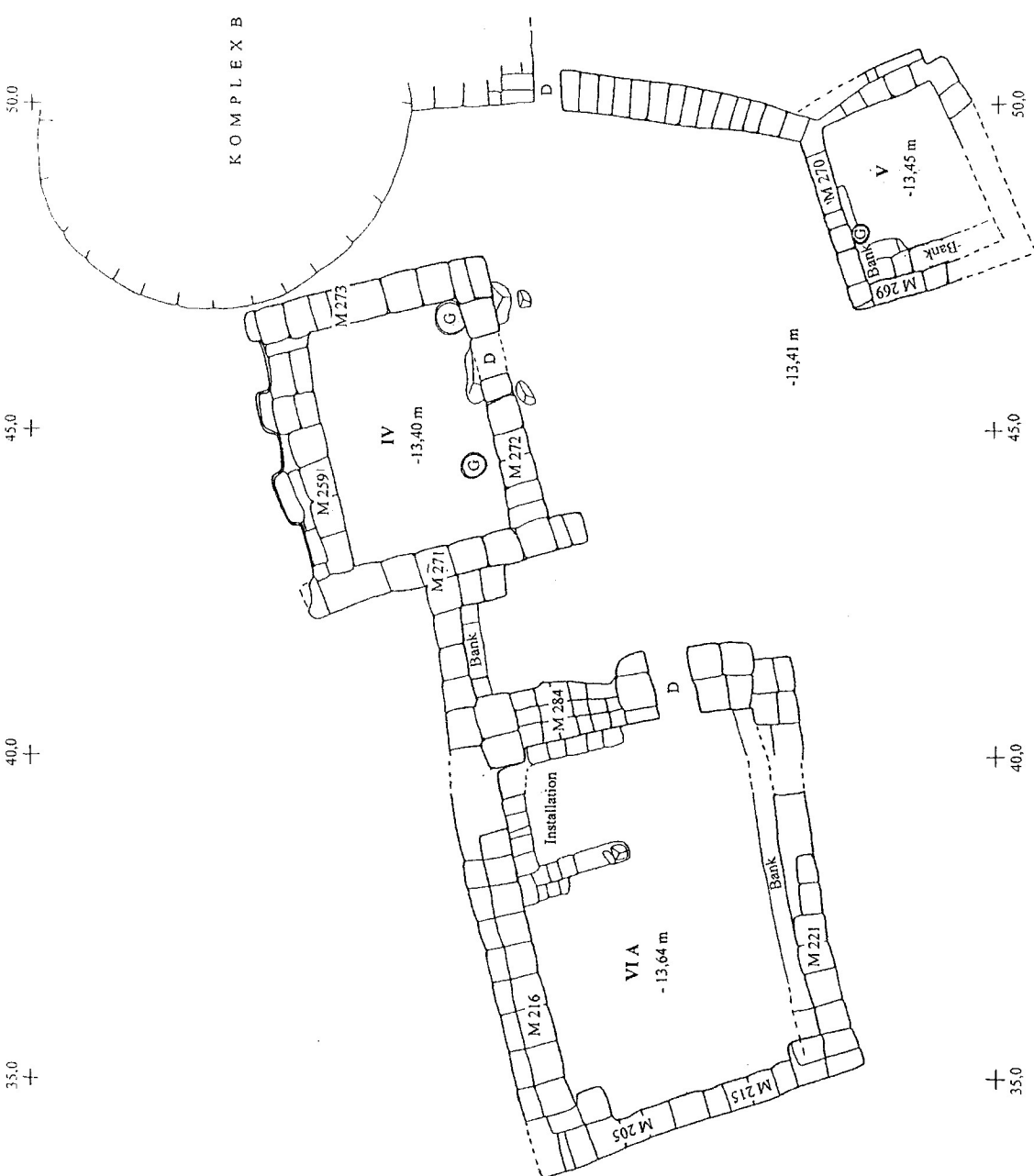

45,0  
+

40,0  
+

35,0  
+

+ 45,0

+ 40,0

+ 35,0

+ 45,0

+ 40,0

+ 35,0

+ 50,0

+ 40,0

+ 35,0

N 75,0  
+  
O 30,0

+ 70,0

+ 65,0

N 60,0  
+  
O 30,0



TALL KNEDIG/NO-SYRIEN  
KOMPLEX C/ RAUM VIA (I. BAUPIASE)  
AUFNAHME: HANF/MARTIN  
ZEICHNUNG: HINZ.

**TAFEL 7**

N 70,0  
+ O 45,0

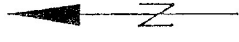

+ 65,0

40,0  
+

35,0  
+

N 70,0  
+ O 30,0

65,0  
+

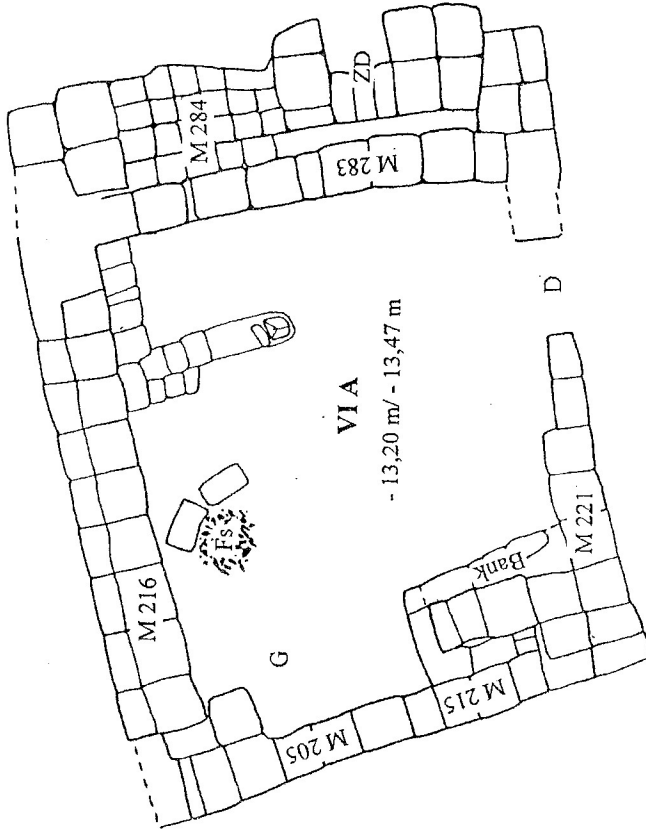

N 60,0  
+ O 45,0

40,0  
+

35,0  
+

N 60,0  
+ O 30,0



TALL KNĒDIĠ/ NO-SYRIEN  
RAUM VI A (2. BAUPHASE)  
AUFNAHME: HANF  
ZEICHNUNG: HINZ

**TAFEL 8**

N 70,0 +  
O 25,0 +

30,0 +

35,0 +

40,0 +

+ N 70,0  
O 45,0

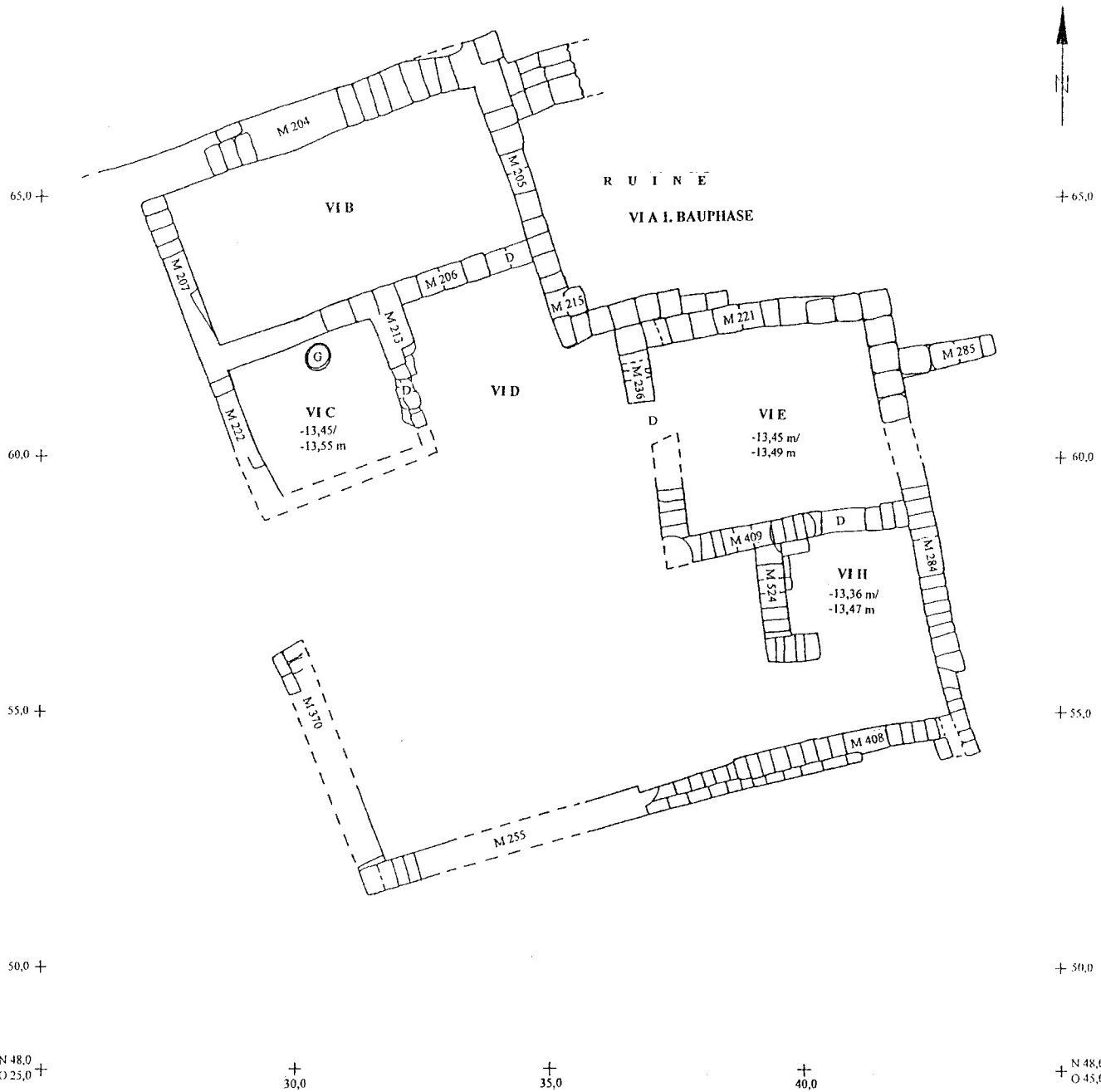

N 48,0 +  
O 25,0 +

30,0 +

35,0 +

40,0 +

+ N 48,0  
O 45,0



TALL KNEDIĞ/ NO-SYRIEN  
KOMPLEX D/ I. BAUPHASE  
AUFNAHME: HANF/ MARTIN/ WARTKE  
ZEICHNUNG: HINZ

**TAFEL 9**

N 70,0 +  
O 25,0 +

30,0 +

35,0 +

40,0 +

+ N 70,0  
+ O 45,0



TALL KNEDIĞ/NO-SYRIEN  
KOMPLEX D/ 2. BAUPHASE  
AUFNAHME: HANF/MARTIN/WARTKE  
ZEICHNUNG: HINZ

**TAFEL 10**

N 65,0  
O 10,0

15,0

20,0

25,0

N 65,0  
O 30,0

60,0

+ 60,0

55,0

+ 55,0

50,0

+ 50,0

45,0

+ 45,0

N 41,0  
O 10,0

15,0

20,0

25,0

N 41,0  
O 30,0

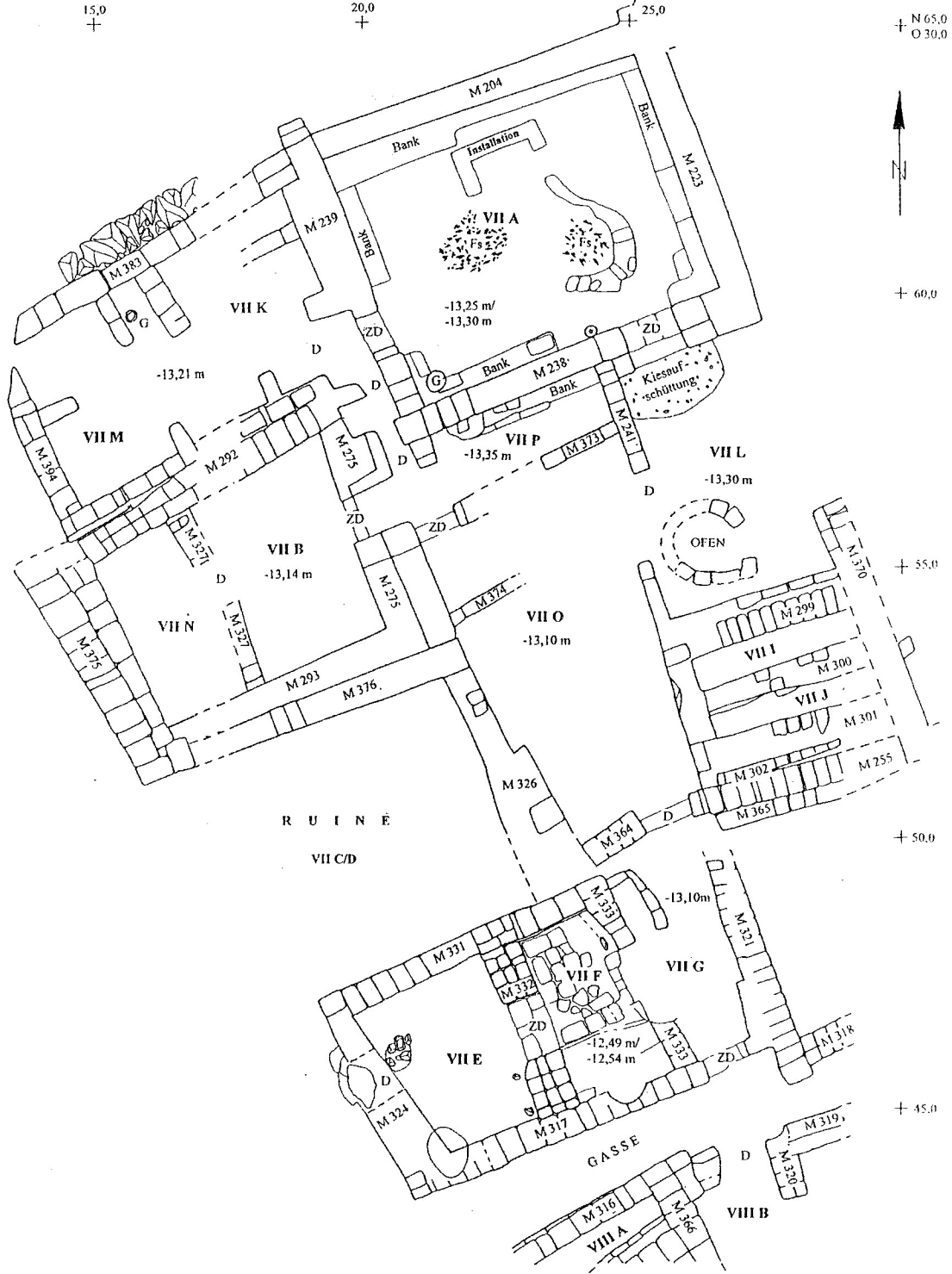

TAL. KNEDIG/NO-SYRIEN  
KOMPLEX E  
AUFNAHME: HANF/ZÜHLSDORFF  
ZEICHNUNG: HINZ

**TAFEL 11**

N 50,0  
+ O 30,0

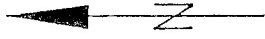

+ 45,0

25,0  
+

20,0  
+

N 50,0  
+ O 15,0

45,0  
+

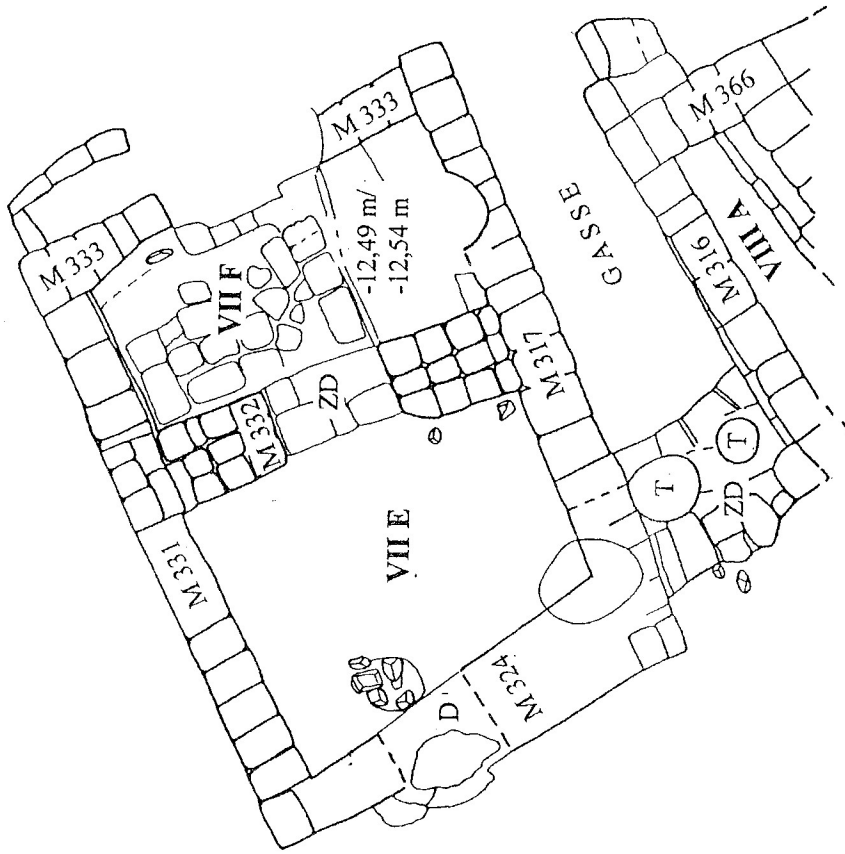

N 41,0  
+ O 30,0

+ 25,0

+ 20,0

N 41,0  
+ O 15,0



TALL KNĒDĪĢ/ NO-SYRIEN  
KOMPLEX E (DETAIL)  
AUFNAHME: HANF  
ZEICHNUNG: HINZ

**TAFEL 12**

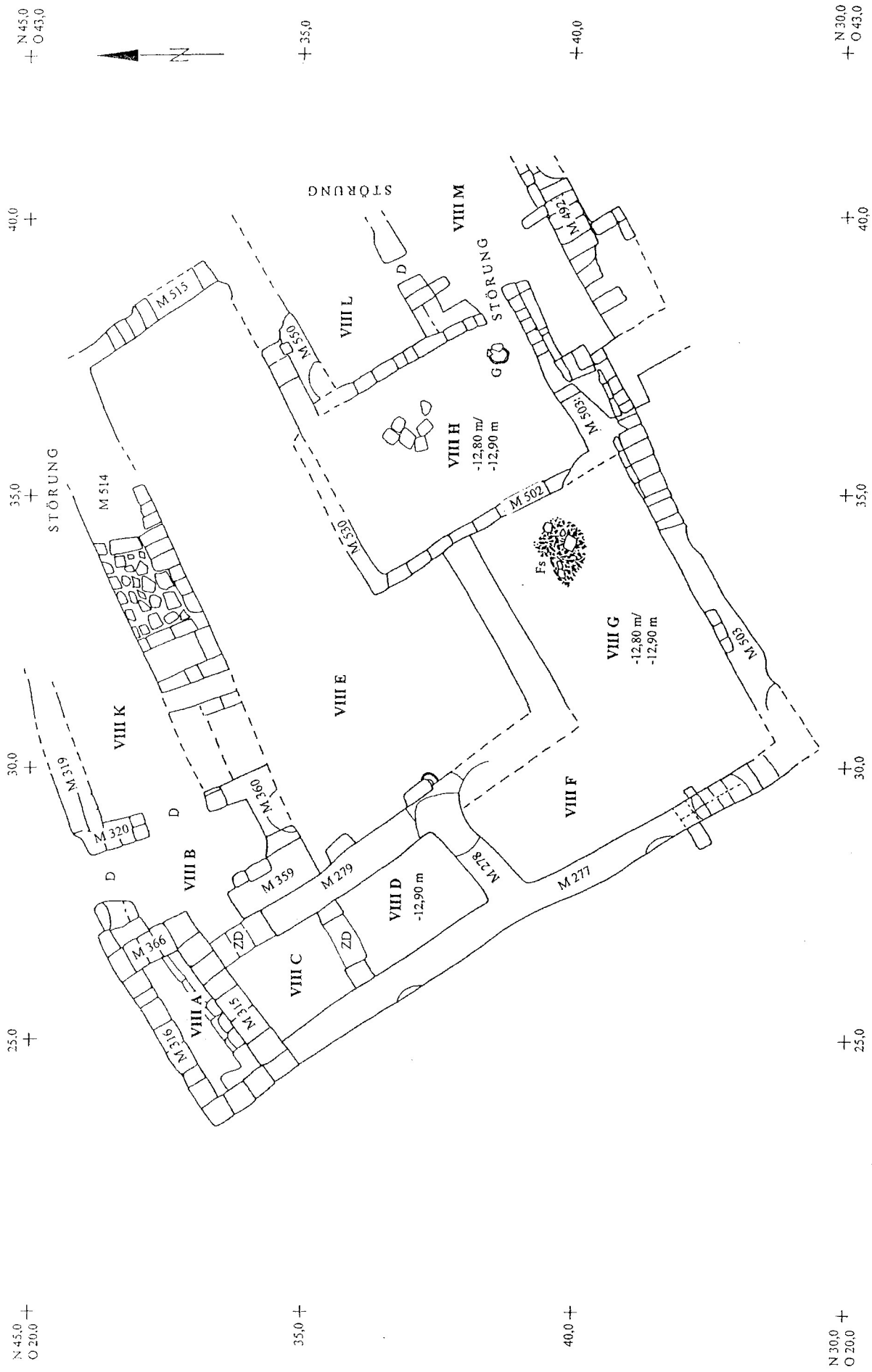

FALL KNEDIĞ/ NO-SYRIEN  
 KOMPLEX F  
 AUFNAHME: HUNSDÖRFER/ JEUTE/ WARTKE  
 ZEICHNUNG: HINZ



**TAFEL 13**



N 35,0  
O 30,0 +

35,0  
+

+ N 35,0  
O 41,0

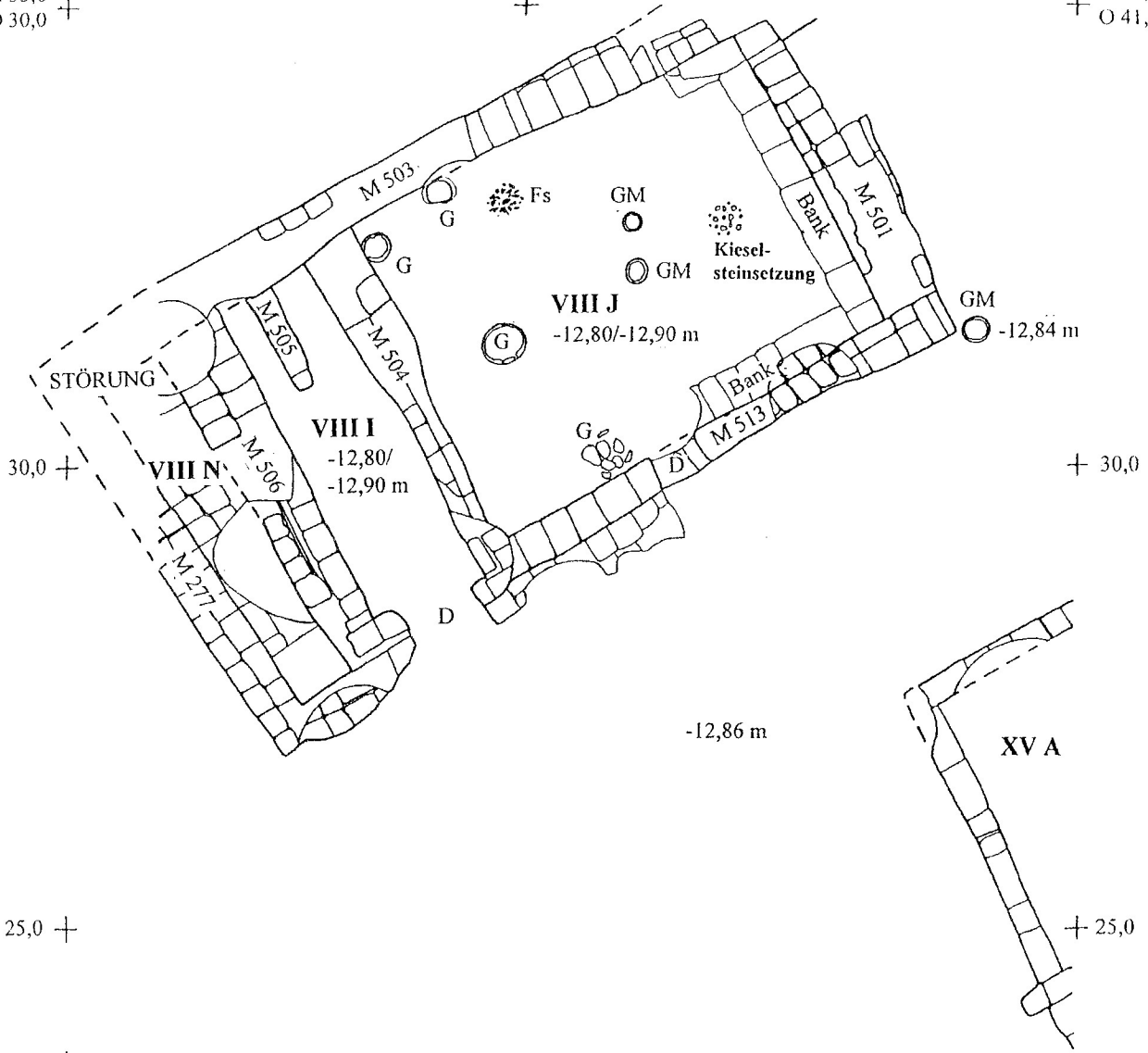

25,0 +

+ 30,0



N 20,0  
O 30,0 +

+  
35,0

+ N 20,0  
O 41,0



TALL KNĒDIĠ/ NO-SYRIEN  
 KOMPLEX G  
 AUFNAHME: HUNSDÖRFER  
 ZEICHNUNG: HINZ

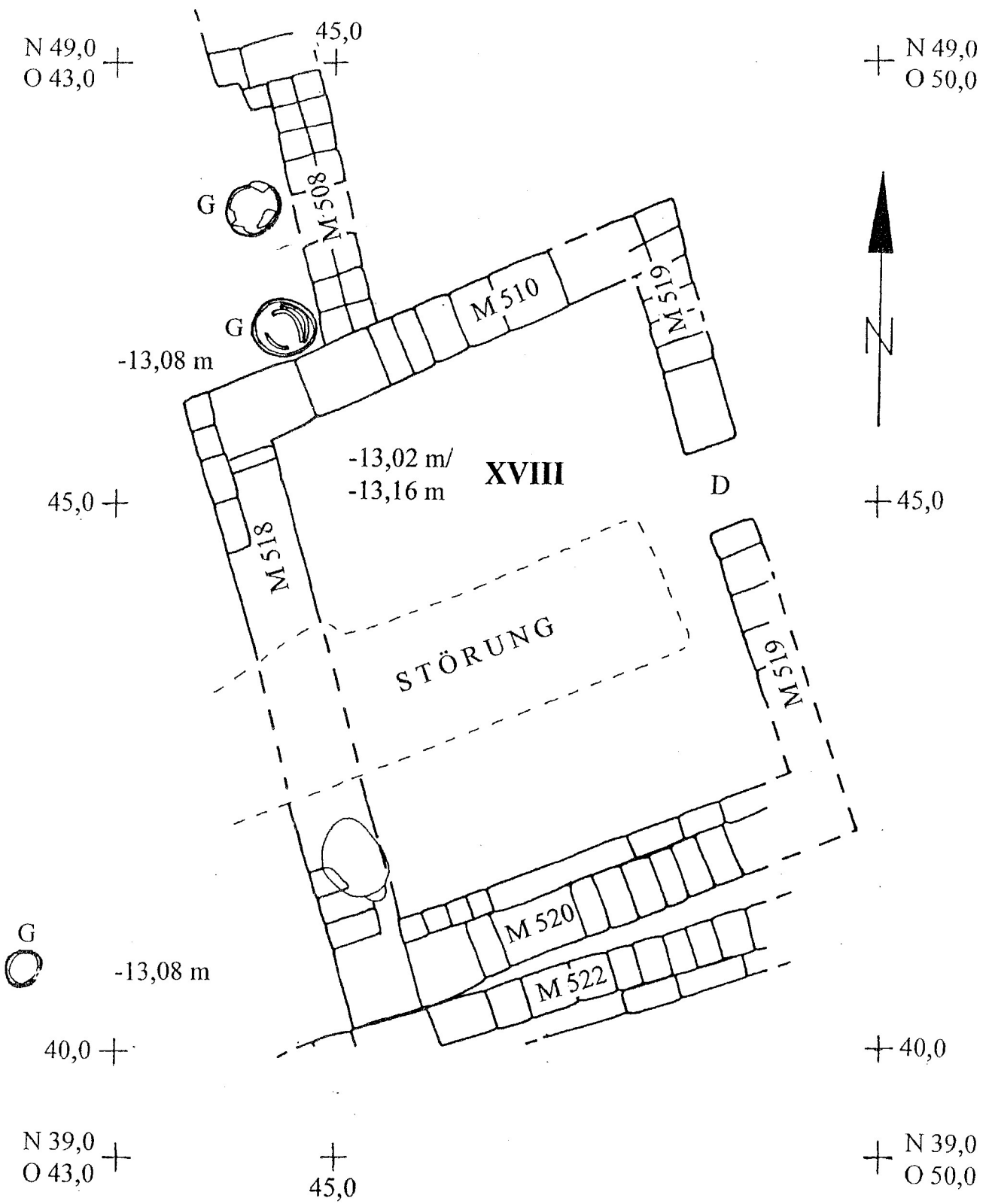

TALL KNĒDIĠ/ NO-SYRIEN  
 KOMPLEX H  
 AUFNAHME: ZÜHLSORFF  
 ZEICHNUNG: HINZ

**TAFEL 15**

N 32,0  
O 17,0

20,0

25,0

30,0

N 32,0  
O 32,0

30,0

30,0

25,0

25,0

20,0

20,0

15,0

15,0

N 10,0  
O 17,0

20,0

25,0

30,0

N 10,0  
O 32,0

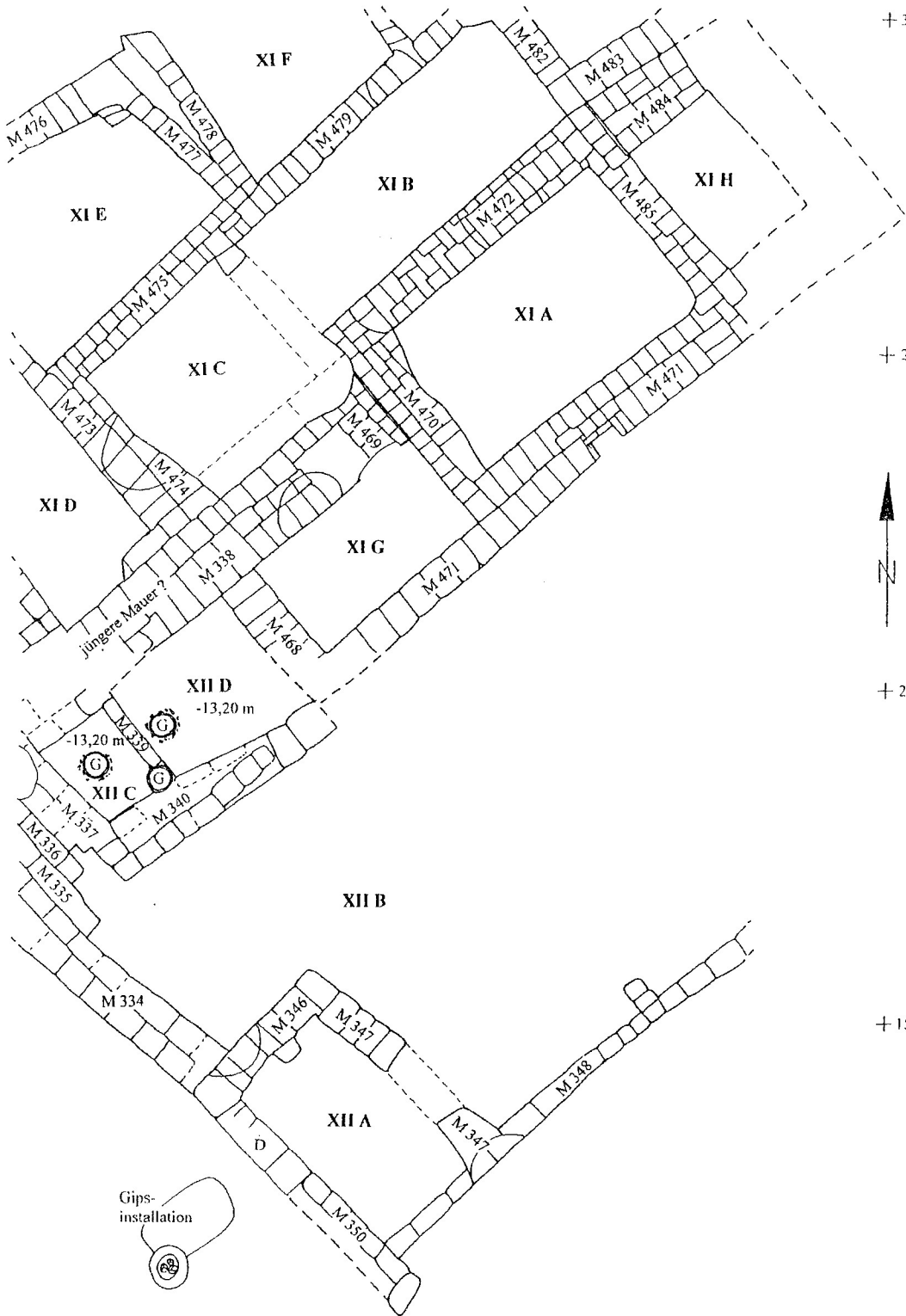

TALL KNĒDIĠ/ NO-SYRIEN  
KOMPLEX J  
AUFNAHME: MARTIN/ ZART  
ZEICHNUNG: HINZ

**TAFEL 16**

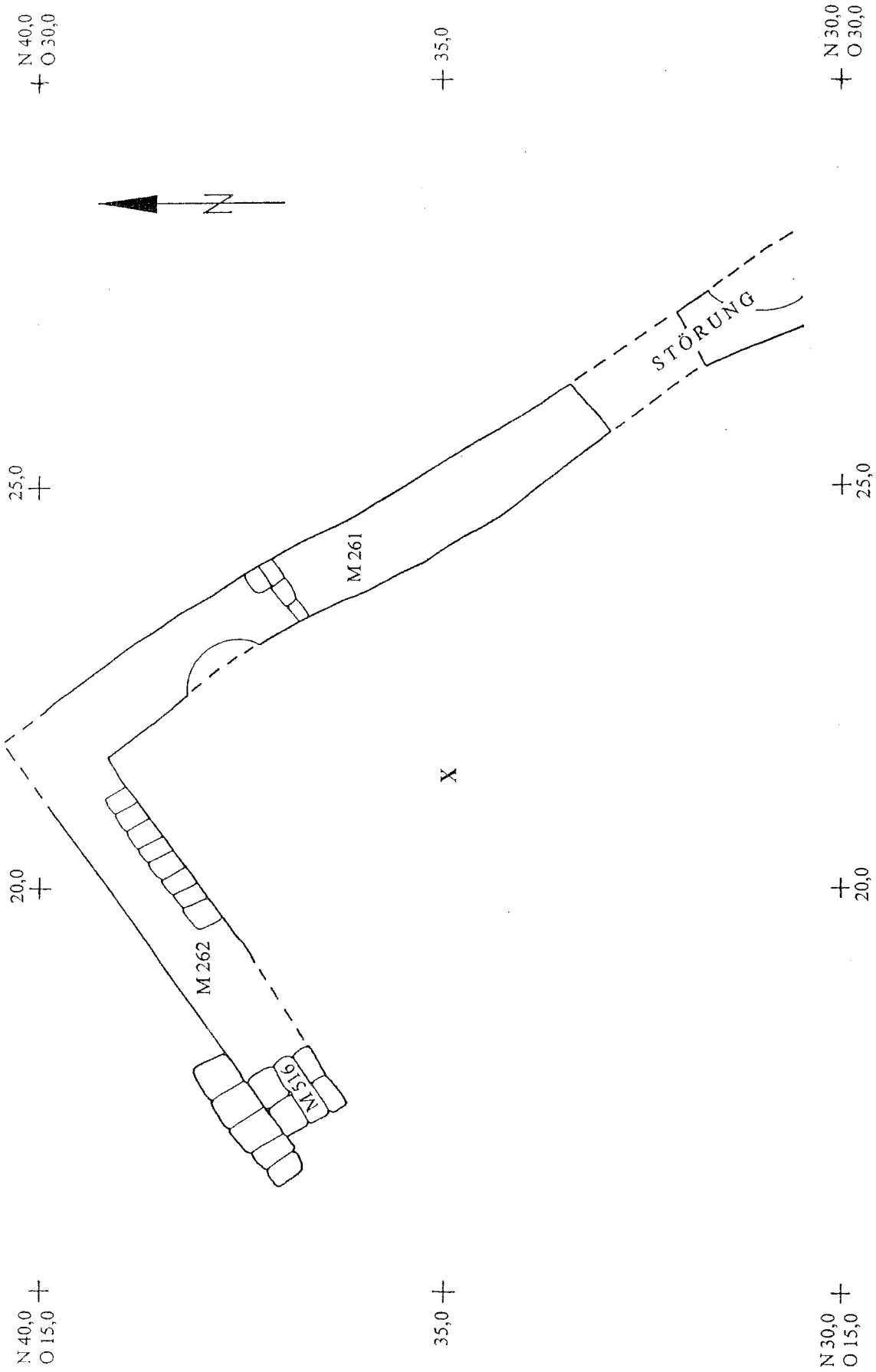

TALL KNEDIĞ/NO-SYRIEN  
 KOMPLEX K (I. BAUPHASE)  
 AUFNAHME: JEUTE  
 ZEICHNUNG: HINZ



**TAFEL 17**

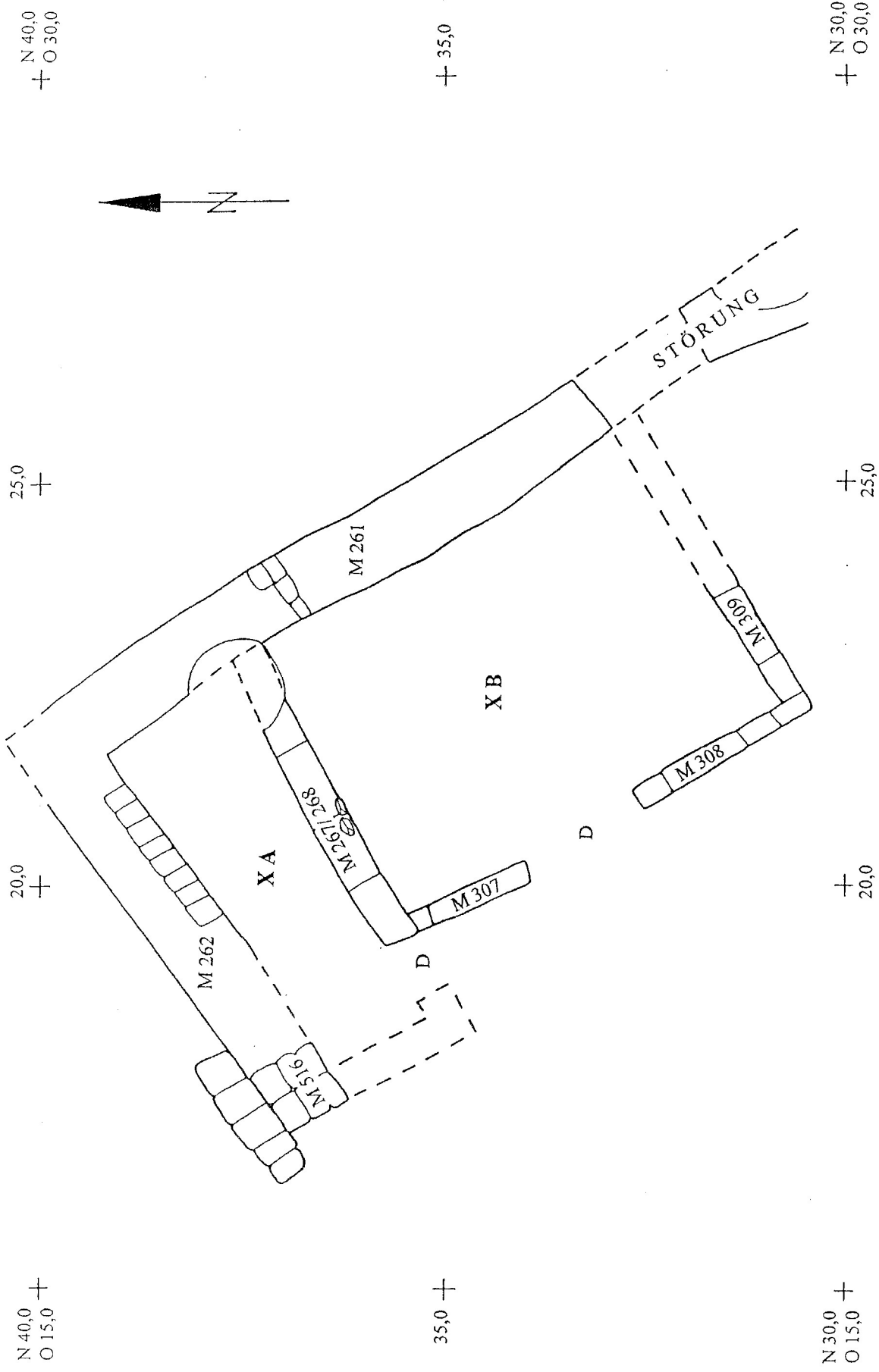

TALL KNEDIĞ/NO-SYRIEN  
 KOMPLEX K (2. BAUPHASE)  
 AUFNAHME: JEUTE  
 ZEICHNUNG: HINZ

**TAFEL 18**

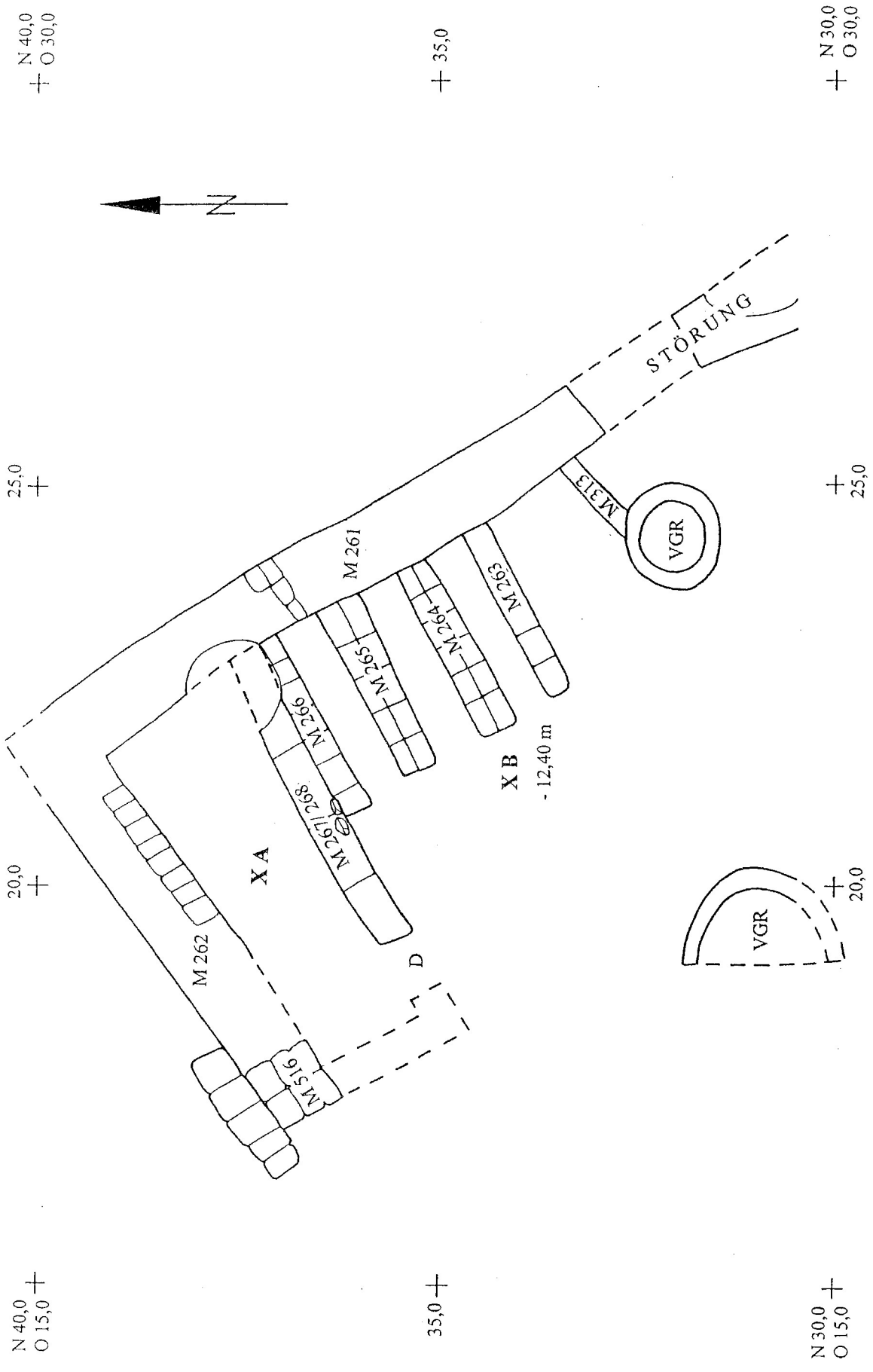

TALL KNĒDĪG/ NO-SYRIEN  
 KOMPLEX K (3. BAUPHASE)  
 AUFNAHME: JEUTE  
 ZEICHNUNG: HINZ

**TAFEL 19**