

2 Literature review

2.1 The physiological and pathological consideration of acid-base homeodynamics

The concentration of hydrogen ion ($[H^+]$) in the body is low (40 nmol/l) compared with that of many other ions. Because of the low $[H^+]$ of the body fluid, $[H^+]$ is commonly expressed as the negative logarithm or pH (Carlson, 1997). The normal physiological blood pH in mammals is between 7.35-7.45 or about 44.7-35.5 nmol/l of $[H^+]$, which is necessary for the normal function of the cellular processes (Koeppen, 1998). The range of pH compatible for life is 6.85 to 7.80 (160-16 nmol/l of H^+). Groutides and Michell, (1990) and Berchtold, (1998) reported a pH about 6.79 ± 0.078 immediately before death in diarrhoeic calves. A depression of blood pH below the normal range is known as acidaemia, whereas a value above the normal range is called alkalaemia. The disturbance caused by the addition of excess acid or the removal of base from ECF is known as acidosis, whereas alkalosis is a disturbance that happens due to addition of excess base or a loss of an acid (Houpt, 1993). Many investigators have studied acid-base status by estimating pH in venous blood in healthy and diarrhoeic calves (Table 1). However, data on the blood pH in healthy or diarrhoeic camels has not been published.

Table 1 Venous blood pH in healthy and diarrhoeic calves (mean \pm SD).

Reference	Healthy calves			Diarrhoeic calves			Young camels
	No of calves	Age	pH	No of calves	Age	pH	
Kasari and Naylor, (1986)	36	≤ 30 d	7.34 ± 0.01	36	≤ 30 d	7.09 ± 0.09	No data has been reported previously
Naylor and Forsyth, (1986)	6	2-5 d	7.42 ± 0.01	-	-	-	
	6	11-18	7.40 ± 0.03	-	-	-	
Singh et al., (1989)	6	3-4 w	7.34 ± 0.04	6	3-4 w	* 7.28 ± 0.01	
Groutides and Michell, (1990)	-	-	-	14	-	7.12 ± 0.05	
Weldon et al., (1992)	-	-	-	3	3d- 4w	7.27	

Lechowski, (1996)	-	-	7.39 ±0.07	-	-	** 7.14 ±0.08
Berchtold, (1998)	-	-	-	36	3-28 d	7.09 ±0.16
Stocker et al., (1999)	-	-	-	50	6-90 d	7.21- 7.13
Omole et al., (2001)	21	1-45 d	7.36 ±0.03	21	1-45 d	7.17 ±0.14
Grove-White and Michell, (2001)	6	5-10 d	7.37 ±0.01	11	5-10 d	7.00 ±0.01
Cambier et al., (2005)	68	5-21 d	7.32 ±0.01	12	5-21 d	7.17 ±0.04

* Hypokalaemic calves

** Experimental osmotic diarrhoea

d: days, w: weeks

According to Bronsted's definition, an acid is a substance that can donate H⁺ (CH₃COOH, NH₄⁺ and others) and a base is a substance that can accept H⁺ (CH₃COO⁻, NH₃ and others). Normally, acids and bases are added daily to the ECF via metabolism processes. The amount of acid produced in the body varies, depending on the physiological status of the animal such as pregnancy (Wolfe et al., 1998), diet composition (Vagnoni and Oetzel, 1998) and during exercise (Kowalchuk and Sceurmann, 1995). However, the diet composition plays a major role in acid and base production. In herbivorous animals, the metabolism of most organic compounds containing hydrogen, oxygen and carbon results in the formation of water and carbon dioxide (CO₂). CO₂ reacts with water to form carbonic acid in the presence of carbonic anhydrase; therefore carbonic acid is called volatile acid.



The net products of metabolism are thus large amounts of CO₂ + H₂O. The CO₂ produced is eliminated by the lungs. Within the red blood cells, H⁺ is removed from the blood stream by means of formation of H₂CO₃ which dissociates to HCO₃⁻ and H⁺. HCO₃⁻ is electrically balanced by K⁺ and other cations of the ECF. The excess HCO₃⁻ raises the HCO₃⁻/H₂CO₃ ratio and the pH rises and leads to metabolic alkalosis. However, under physiological circumstances, the metabolic alkalosis is corrected by the excretion of the excess HCO₃⁻ as alkaline urine.

On the other hand, in the carnivorous and omnivorous species including man, the main metabolic products are excess acids (non-volatile acids), which resulted in an excretion of acidic urine and ammonia production as regulatory mechanisms. In the renal tubular cells, NH_3 is produced from the breakdown of glutamic acid. In the lumen, the produced NH_3 reacts immediately with H^+ to form ammonium ions (NH_4^+).

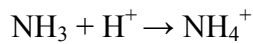

Most of NH_4^+ produced is transferred to the liver and used in hepatic synthesis of urea.

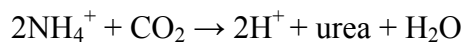

In the liver, H^+ formed reacts with HCO_3^- to reform H_2CO_3 and the overall there is no change in acid-base balance.

Under physiological conditions, the body uses three basic regulatory mechanisms to maintain acid-base homeodynamics: intracellular and extracellular buffers, the respiratory system and the kidneys. However, metabolic processes in the liver played a minor role in the regulation of acid-base homeodynamics. The intracellular and extracellular buffers and the respiratory system are responsible for rapid correction of pH changes, whereas the kidneys are responsible for long-term acid-base homeodynamics and excretion of excess $[\text{H}^+]$ (Verlander, 2002).

2.1.1 Intracellular and extracellular buffers

A buffer is a compound that can accept protons (H^+) and minimise the changes in pH (DiBartola, 1992).

A buffer system consists of a mixture of a weak acid and its conjugate base:



The relationship between pH and a mixture of a weak acid and its conjugate base is given by Henderson-Hasselbalch equation:

$$\text{pH} = \text{pK} + \log \frac{[\text{base}]}{[\text{acid}]}$$

Therefore, when a strong acid is added to a buffer system containing a weak acid and its conjugate weak base, the protons (H^+) from the strong acid are donated to the conjugate weak base of the weak acid, and the change in pH is minimised.

Several intracellular and extracellular buffers neutralise H^+ to maintain the blood pH within the physiological limits.

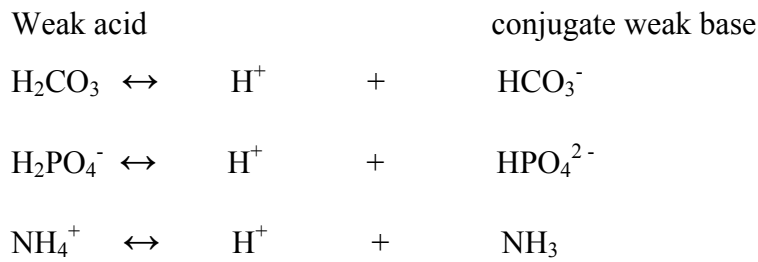

The principal buffer systems in the blood are haemoglobin (Hb), plasma proteins, bicarbonate (HCO_3^-), and phosphate (HPO_4^{2-} , H_2PO_4^-). The $\text{CO}_2/\text{HCO}_3^-$ buffer system is an important buffer of the ECF. The strength of this buffer is due to the volatility of CO_2 , which is allowed the lungs to maintain stable CO_2 . This buffer system differs from the other buffering systems of the body because it is regulated by both the lungs and the kidneys.

The phosphate buffer (HPO_4^{2-} , H_2PO_4^-) plays a major role as an important intracellular buffer because of its great intracellular concentration. Although $\text{pK} = 6.8$ is closer to ECF pH of 7.4, it plays a minor role as ECF buffering system because of its low extracellular concentration of approximately 1-2 mmol/l (DiBartola, 1992). The importance of phosphate buffer, particularly HPO_4^{2-} is very clear in the renal proximal tubular cells. In these cells, it is responsible for binding H^+ to form H_2PO_4^- . However, during metabolic acidosis the bones also provide a reservoir of phosphate buffer that contributes to maintain systematic pH (Bushinsky et al., 2003).

2.1.2 The role of the respiratory system in acid-base homeodynamics

Respiratory system adjustment mechanisms are sensitive to the changes in the arterial P_{O_2} , P_{CO_2} and $[\text{H}^+]$. The adjustment is provided via central and peripheral chemoreceptors; a small change in the arterial P_{CO_2} and $[\text{H}^+]$ stimulates pulmonary ventilation (Robinson, 2002). Chemoreceptors are located at several sites in the body. The central chemoreceptors (chemosensitive neurons) are located along the ventral medulla. These receptors account for 75% of the CO_2 -induced increases in ventilation, and respond to the changes in $[\text{H}^+]$ of the surrounding brainstem interstitial fluid. The peripheral chemoreceptors are located in the carotid and aortic bodies, which are accounted for 25% of the CO_2 -induced increases in ventilation (Koeppen, 1998).

Under physiological conditions, CO_2 diffuses from the tissues into the plasma and erythrocytes and carbonic acid (H_2CO_3) formed then is dissociated into H^+ and HCO_3^- (Fig. 2.1). $\text{H}_2\text{O} + \text{CO}_2 \xrightleftharpoons{\text{carbonic anhydrase}} \text{H}_2\text{CO}_3 \leftrightarrow \text{H}^+ + \text{HCO}_3^-$

In the blood, the initial concentration of HCO_3^- is greater than H_2CO_3 , so the $\text{HCO}_3^-/\text{H}_2\text{CO}_3$ ratio decreases and consequently the blood pH decreases. When the blood reaches the lungs,

CO₂ leaves the blood and the pH increases. Normally, P_{CO₂} and pH in the arterial blood remain relatively constant because the lungs always eliminate CO₂ as fast as it is produced by the tissues.

Fig. 2.1 Regulation of CO₂ and H⁺ by plasma proteins, haemoglobin and HCO₃⁻ buffers.

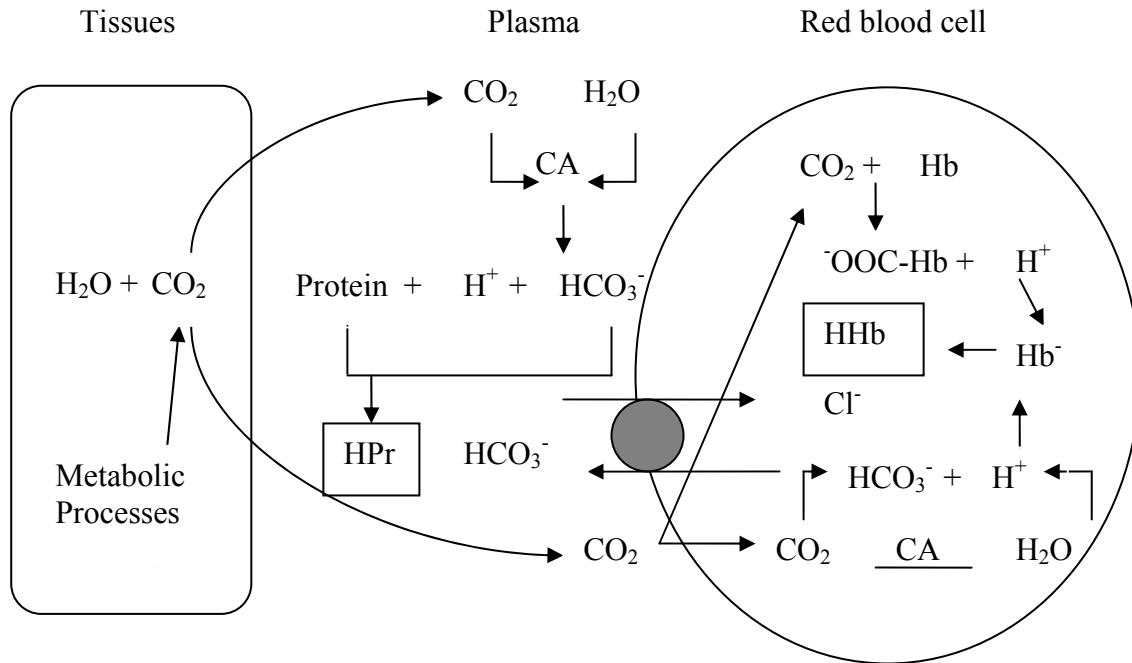

2.1.3 The role of the kidneys in acid-base homeodynamics

The kidneys play a major role in the regulation of the extracellular homeodynamics by controlling the volume and the composition of ECF (Standon and Koeppen, 1990). They are responsible for secretion of the majority of excess H⁺ in the form of either ammonium (NH₄⁺) or acid buffer salts (Fig. 2.2) (Koeppen et al., 1985). This process is facilitated by the glomerular filtration and tubular secretion of H⁺. The secretion process takes place primarily in the proximal tubules and the collecting ducts.

Fig. 2.2 The formation of acid buffer salts (NaH₂PO₄) by the proximal renal tubular cell.

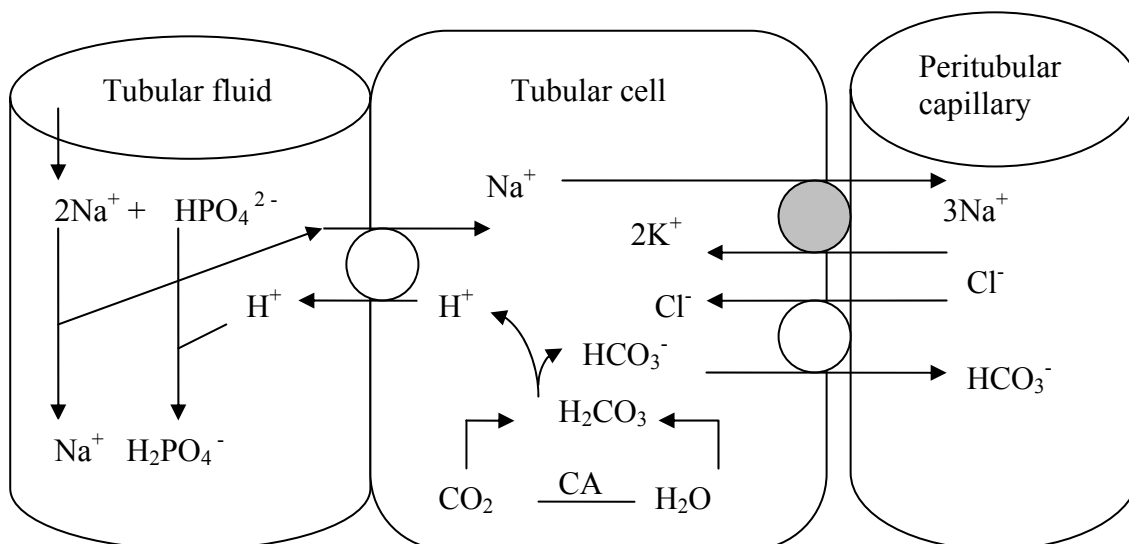

The apical membrane of the proximal tubules cell contains a $\text{Na}^+\text{-H}^+$ antiporter that uses energy to secrete H^+ into the tubular fluid. Recent evidence indicates that some portion of H^+ is secreted via $\text{H}^+\text{-ATPase}$ pump and $\text{H}^+\text{-K}^+$ transporter. Within the tubular cell, H^+ and HCO_3^- are produced in a reaction catalyzed by carbonic anhydrase (CA) (Fig. 2.3). H^+ is secreted into the tubular fluid, whereas HCO_3^- moves across the basolateral membrane and returns to the peritubular capillary blood. In the tubular fluid, the secreted H^+ combines with the filtered HCO_3^- to form H_2CO_3 , which is converted to CO_2 and H_2O .

Fig. 2.3 Schematic representation of the mechanisms of the secretion of H^+ by the proximal renal tubular cell.

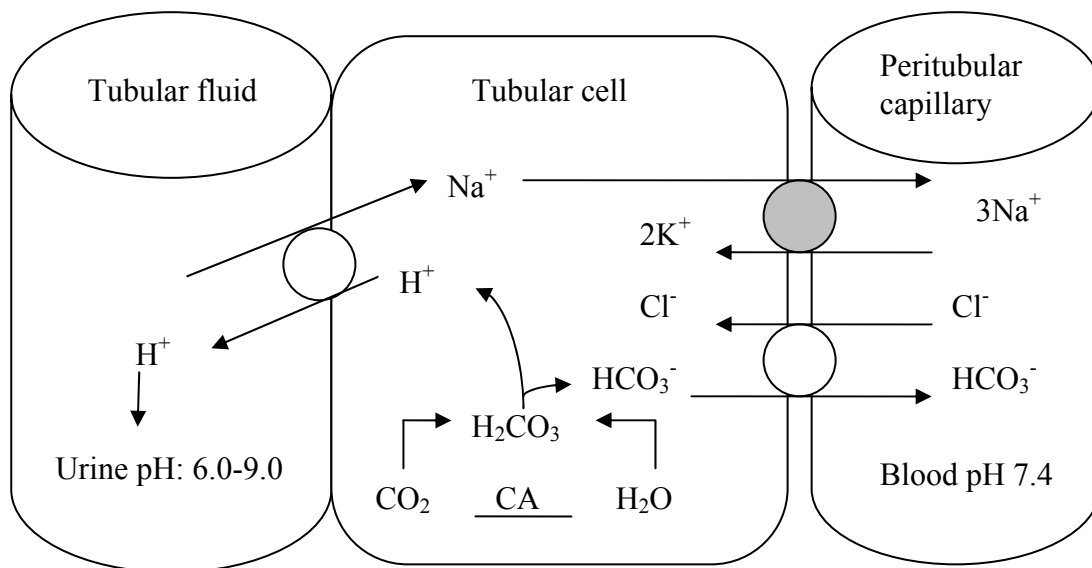

There is a second extremely important role that the kidneys regulate acid-base balance by reabsorption of the filtered bicarbonate. Daily filtered bicarbonate equals the product of the daily glomerular filtration rate in humans (180 l/day, Verlander, 2002) and about 2.31ml/minute/kg (213 l/day) in calves weighing between 37-90 kg (Wanner et al., 1981). About 85 to 90% of the filtered bicarbonate is reabsorbed by the proximal tubule and the rest is reabsorbed by the intercalated cells of the distal tubule and the collecting ducts. This process is also facilitated by the active transport of H^+ across the intercalated cells (Verlander, 2002).

An additional 15% of the filtered HCO_3^- is reabsorbed by the loop of Henle by the same mechanisms that operate in the proximal tubules. However, there is an additional mechanism that facilitated the exit of HCO_3^- across the basolateral membrane coupled to Na^+ ($\text{H}^+\text{-Na}^+\text{-CO}_3^{2-}\text{-HCO}_3^-$ symporter).

The distal tubules and the collecting ducts reabsorb about 5% of filtered HCO_3^- . However, this reabsorption process does not depend on the $\text{Na}^+\text{-H}^+$ antiporter. Within the cell, H^+ and HCO_3^- are produced by the hydration of CO_2 in the presence of CA (Fig. 2.4).

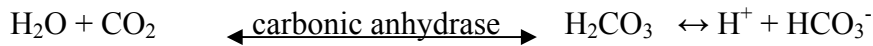

The secretion of H^+ across the apical membrane is facilitated via the H^+ -ATPase pump and H^+ - K^+ transporter, whereas HCO_3^- moves across the basolateral membrane in exchange for Cl^- via a Cl^- - HCO_3^- antiporter and enters the peritubular capillary blood (Fig. 2.4).

Fig. 2.4 Mechanisms of HCO_3^- reabsorption by the intercalated cells of renal distal tubules and collecting ducts.

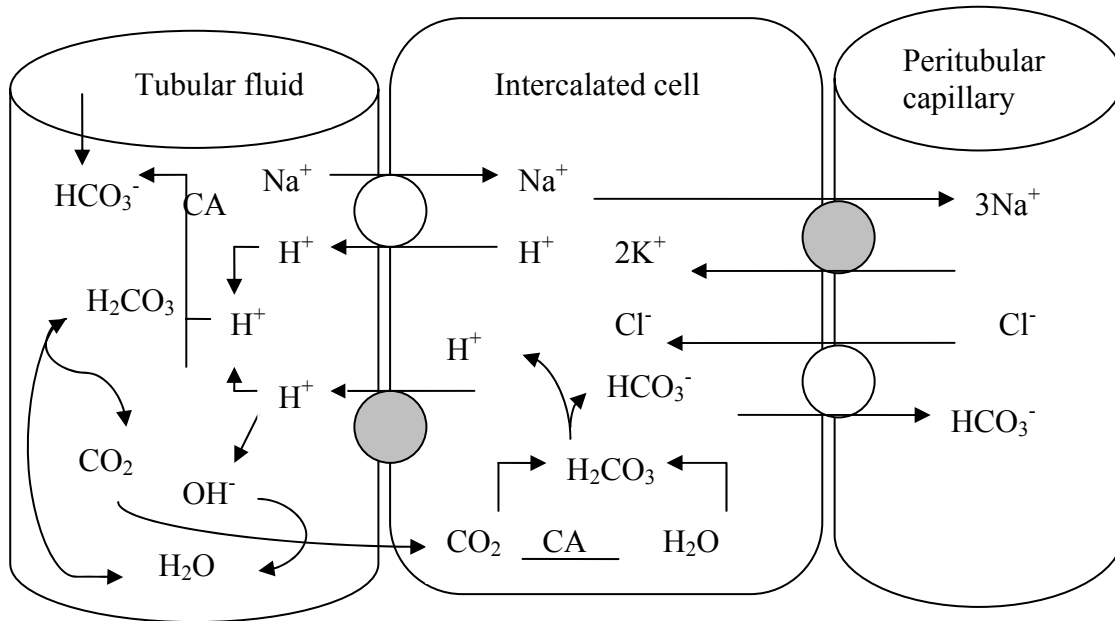

Reabsorption of HCO_3^- along the nephron is affected by systemic acid-base balance. Both respiratory acidosis, which is characterised by an increase in the arterial partial pressure of carbon dioxide (Pa_{CO_2}) and metabolic acidosis (a decrease in the plasma- $[\text{HCO}_3^-]$) stimulates HCO_3^- reabsorption along the nephron. Conversely, respiratory and metabolic alkalosis inhibits reabsorption of HCO_3^- along the nephron (Koeppen, 1998).

Renal generation and excretion of ammonium ions (NH_4^+) are a major component in the maintenance of acid-base balance. The kidneys metabolise the glutamine to produce NH_3 . NH_3 is produced mainly in the proximal tubules by the metabolism of glutamine primarily from the liver and Na^+ salts of the non-volatile acids which are delivered to the kidneys in the renal arterial plasma (Fig. 2.5). In the tubular fluid, the diffused NH_3 reacts with secreted H^+ to form NH_4^+ .



NH_4^+ formed excretes with the acids salts in the urine and return NaHCO_3 to the body in the renal vein plasma. The HCO_3^- moves across the basolateral membrane of the proximal tubule cell and enters the peritubular capillary blood as new HCO_3^- (Fig. 2.5). The formation of

a new HCO_3^- depends on the ability of the kidney to excrete NH_4^+ in the urine. If NH_4^+ is not excreted in the urine but instead enters the systemic circulation, it will neutralise plasma HCO_3^- and thus negating the process of generation of new HCO_3^- .

Fig. 2.5 Renal generation and excretion of ammonium ion (NH_4^+) by the proximal renal tubular cell.

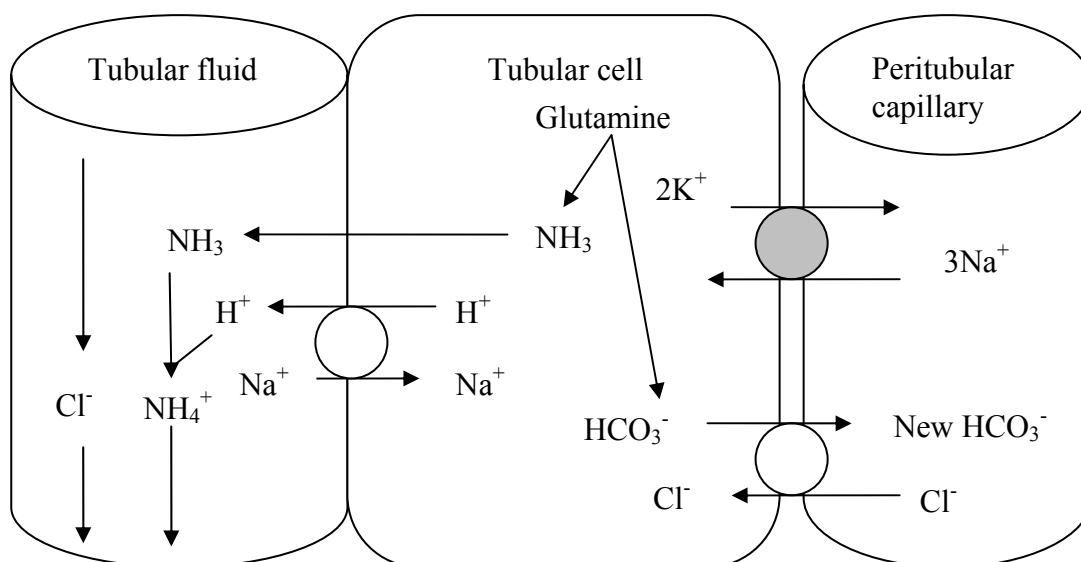

A significant portion of the NH_4^+ secreted by the proximal tubules is reabsorbed by the loop of Henle by substituting NH_4^+ for K^+ on the $\text{Na}^+-\text{K}^+-2\text{Cl}^-$ symporter. The accumulation of NH_3 and NH_4^+ in the medullary interstitium is enhanced by a countercurrent multiplication system. This creates a steep concentration for NH_3 to diffuse into the medullary collecting ducts across the plasma membrane. In the luminal fluid, NH_3 combines with H^+ to form NH_4^+ which can not diffuse across the plasma membrane and is trapped within the tubular fluid. This contributes to maintenance of a favourable gradient for the electrochemical gradient for H^+ that created by the active protons secretion in the collecting ducts.

2.1.4 The role of the gastrointestinal tract and the liver in acid-base homeodynamics

The gastrointestinal tract only plays a minor role in acid-base regulation. During the digestion process many fixed acids and bases are added to the blood stream, which is metabolised later by the liver. Also many ions such as H^+ , Na^+ , K^+ , Cl^- and HCO_3^- are trapping or lost from the blood as a result of the formation of saliva, HCl , pancreatic secretion and the bile (Herdt, 1997). Furthermore, the absorption and secretion mechanisms of electrolytes in the intestine play a major role in the regulation of blood SID.

The liver is important in acid-base homeodynamics because it is a metabolically active organ which may be either a significant net producer or consumer of H^+ and through metabolism,

the liver adds various non-volatile acids (HPO_4^{2-} , H_2PO_4^- , SO_4^{2-}) and bases equivalent to the ECF (Koeppen, 1998). The acid-base roles of the liver may be associated with the production of CO_2 from oxidation process of substrates. The liver also contributes to regulate acid-base balance by controlling the rate of ureagenesis, and therefore HCO_3^- consumption in response to the changes in the plasma acidity. Accordingly, previous investigators have studied the role of the liver during acid-base disturbances, particularly during metabolic acidosis (Hosch et al., 2004). The liver also plays a major role in the metabolism of organic acid anions such as lactate, ketones and amino acids. Furthermore, the production of plasma proteins (albumin) takes place primarily in the liver, which is contributed to maintain systemic pH as extracellular buffers.

2.2 Clinical assessment of acid-base status

Characterisation of acid-base balance in the body is central important in human medicine (Wooten, 1999). In veterinary medicine, characterisation of acid-base status is very important to provide useful information about clinical management of acid-base disorders in animals (Constable, 2002). Several methods have been proposed to evaluate clinical acid-base status. The Henderson-Hasselbalch approach and the two physicochemical approaches, the strong ion model (Stewart's model) and simplified ion model have been used to describe acid-base balance in humans and animals.

2.2.1 Henderson-Hasselbalch approach

The traditional approach is most commonly known as the Henderson-Hasselbalch equation. This approach focuses on the effect of independent variable partial pressure of carbon dioxide (PCO_2), dependent variable plasma concentration of bicarbonate ($[\text{plasma- HCO}_3^-]$) and the plasma solubility of CO_2 (S) on blood pH, which is expressed as follows:

$$\text{pH} = \text{pK} + \log \frac{[\text{HCO}_3^-]}{\text{S} \times \text{PCO}_2}$$

Clinically, the Henderson-Hasselbalch equation is used to categorise 4 primary acid-base disturbances: respiratory acidosis and alkalosis and metabolic acidosis and alkalosis (Constable, 2000). Previous investigators have concluded that Henderson-Hasselbalch equation is more descriptive than mechanistic (Stewart, 1983; Constable, 2000). Others investigators have argued that Henderson-Hasselbalch approach doesn't explain the cause of acid-base changes during diseases, because it fails to distinguish between the effects of dependent and independent variables on plasma pH (Fencil and Leith, 1993).

Constable, (1999) concluded that Henderson-Hasselbalch approach is of limited usefulness in clinical management of acid-base disorders in ruminants. However, many investigators continue to use the traditional approach to evaluate acid-base status in healthy and diarrhoeic calves (Table 2).

2.2.2 Physicochemical approaches

Two quantitative physicochemical approaches have been developed to describe acid base status in animals.

2.2.2.1 The strong ion approach (Stewart's strong ion model)

The Stewart approach (1983) is a very important general method that uses charge and mass balances to deduce an expression for proton concentration ($[H^+]$). Stewart, (1978) defined strong ion difference ([SID]) as the sum of the strong positive ion concentration minus the sum of the strong negative ion concentration in the plasma. He also distinguished between dependent (pH, $[H^+]$ and $[HCO_3^-]$) and independent variables (P_{CO_2} , SID and A_{tot}). In an acid-base system, Stewart, (1983) proposed that the physicochemical interactions between dependent and independent variables recognise the constraints imposed by the law of electrical neutrality, the dissociation equilibrium of weak acids and the conservation of mass. He concluded that $[H^+]$ in biological solutions is determined by P_{CO_2} , [SID] and the total plasma concentration of non-volatile weak acids [A_{tot}], and that the changes in $[H^+]$ can be brought only by changing one or more of these three independent variables. In agreement with Stewart terminology, any changes in pH, $[H^+]$ and $[HCO_3^-]$ are only possible if P_{CO_2} , SID or A_{tot} itself change. Therefore, when SID decreases due to the increase in independent negative charges, leads to a decrease in dependent negative charges $[HCO_3^-]$ and thus results in acidosis. In contrast, a decrease in A_{tot} leads to an increase in $[HCO_3^-]$ and therefore alkalosis. Constable et al., (2005) concluded that the calculation of SID is difficult to obtain from the plasma due to a cumulative measurements error and the presence of unknown strong anions. Therefore they calculated SID as:

$$[SID_3] \text{ (mmol/l)} = ([Na^+] + [K^+] - [Cl^-]) \text{ (mmol/l)}$$

$$[SID_4] \text{ (mmol/l)} = ([Na^+] + [K^+] - [Cl^-] - [lactate^-]) \text{ (mmol/l)}$$

$$[SID_6] \text{ (mmol/l)} = ([Na^+] + [K^+] + [Ca^{++}] + [Mg^{++}] - [Cl^-] - [lactate^-]) \text{ (mmol/l)}$$

In diarrhoeic calves, Grove-White and Michell, (2001) used the equation, $[SID_3] = ([Na^+] + [K^+]) - ([Cl^-])$ to calculate SID and they reported SID value of 40.5-46.7 mmol/l in diarrhoeic calves in comparison with a value of 50.8 mmol/l in healthy calves. On the other hand, A_{tot} which is known as the total concentration of plasma non-volatile buffers, albumin, globulin

and phosphate have been experimentally calculated by the general formula as described by (Rehm et al., 2004).

$$[A_{\text{tot}}] \text{ (mmol/l)} = [\text{Albumin}] \text{ (g/l)} (0.123 \times \text{pH} - 0.631) + [\text{Pi}] \text{ (mmol/l)} (0.309 \times \text{pH} - 0.469)$$

Moreover, Figge et al., (1992) modified Stewart's approach by calculating apparent SID ($[\text{SID}_5]$) and effective (SIDE) as:

$$[\text{SID}_5] \text{ (mmol/l)} = ([\text{Na}^+] + [\text{K}^+] + [\text{Mg}^{++}] + [\text{Ca}^{++}] - [\text{Cl}^-]) \text{ (mmol/l)}$$

$$[\text{SIDE}] \text{ (mmol/l)} = ([A_{\text{tot}}] + [\text{HCO}_3^-]) \text{ (mmol/l)}$$

Stewart's approach describes 6 primary acid-base disturbances: respiratory acidosis and alkalosis, strong ion acidosis and alkalosis and non-volatile buffer ion acidosis and alkalosis instead of the 4 primary acid-base disturbances described by Henderson-Hasselbalch approach (Constable, 1999, 2000). Therefore, Constable, (2003) concluded that the strong ion approach is more valuable than applying the traditional approach to determine the mechanism of acid-base abnormalities. Furthermore, Constable, (2002) concluded that the useful application of SID theory is the calculation of SIG. Other investigators modified Stewart's approach and took into account the effect of sodium, chloride and plasma protein concentration on plasma pH (Fencl and Lieth, 1993). On the other hand, previous investigators used Fencl-Stewart's approach to evaluate acid-base disturbances in small animals (Whitehair et al., 1995) and calves (Stocker et al., 1999). Moreover, Story et al., (2004) suggested that the use of Fencl- Stewart's approach was useful to analyse acid-base disorders in clinical practice. Recently, Stewart's approach requires specific values for SID_3 , $[A_{\text{tot}}]$ and effective dissociation constant (Ka) for the plasma non-volatile buffers in humans (Constable, 2001), horses (Stämpfli et al., 1999), cattle (Constable, 2002) and calves (Constable et al., 2005). However, little information has been reported to investigate the normal values of serum- $[\text{SID}_3]$ and $[A_{\text{tot}}]$ in venous blood of the calves (Table 2).

2.2.2.2 The simplified ion model

The simplified strong ion model was generated by Constable et al., (1997). This model assumes that the plasma pH is determined by 5 independent variables. These variables include P_{CO_2} , SID, concentration of individual non-volatile plasma buffers (albumin, globulin and phosphate), ionic strength and temperature. Therefore, the plasma contains 3 types of charged entities: SID^+ , HCO_3^- and A^- . The requirement for electroneutrality can be formulated as:

$$\text{SID}^+ = [\text{HCO}_3^-] + [\text{A}^-]$$

Therefore, the simplified ion model assumes that ionic charges carried by $[\text{CO}_3^-]$, $[\text{OH}^-]$ and $[\text{H}^+]$ are quantitatively unimportant for pH determination and the pH can be expressed as:

$$\text{pH} = \text{pK} + \log \frac{[\text{SID}^+] - k_a [\text{A}_{\text{tot}}] / k_a + 10^{-\text{pH}}}{\text{S} \times \text{PCO}_2}$$

Table 2 Acid-base parameters of clinically healthy and calves with metabolic acidosis.

Ref	No. of calves	Age (days)	Healthy calves						
			Henderson- Hasselbalch variables					Stewart's variables	
			pH	kPa	mmol/l			mmol/l	
				P _{CO2}	[HCO ₃ ⁻]	[BE]	[AG]	[SID ₃]	[A _{tot}]
Omole et al., (2001)	21	1-34	7.36 ±0.03	7.7 (57.8 ±4.3)	32.6 ±0.03	6.9 ±2.3	5.6 ±3.5	-	-
Varga et al., (2001)	27	24 hrs	7.39 ±0.04 7.42 ±0.04	6.2 (46.4 ±3.9 mmHg) 5.8 (43.6 ±5.1)	26.8 ±1.9 27.1 ±2.8	2.0 ±2.3 3.1 ±2.6	-	-	-
Grove-White and Michell, (2001)	13	< 21	-	TCO ₂ 22.4 (mmol/l)	-	-	-	50.8	-
Constable et al., (2005)	9	4-55	7.38 ±0.03	7.05 (53.0 ±4 mmHg)	-	-	8.9-15.0	43.0 ±2.4	20.1 ±4.7
Omole et al., (2001)	21	1-34	7.36 ±0.03	7.7 (57.8 ±4.3)	32.6 ±0.03	6.9 ±2.3	5.6 ±3.5	-	-
Diarrhoeic calves with metabolic acidosis									
Berchtold, (1998)	36	3-28	7.09 ±0.16	6.2 ±1.6	14.5 ±7.3	-15.6 ±10.1	-	-	-
Stocker et al., (1999)	50	6-90	7.21-7.13	2.9-3.3 (21.5-25)	9-14.1	-12.3 -17.6	17.2-13.8	-	-
Berchtold et al., (2000)	36	9.6 ±5.3 7.5 ±2.8	7.04 ±0.16 7.16 ±0.1	5.9 ±1.7 6.8 ±1.2	11.8 ±4.6 17.7 ±5.8	-19.0 ±7.8 -11.0 ±7.1	-	-	-
Omole et al., (2001)	21	5-45	7.17 ±0.14	6.2 (46.5 ±12.3 mmHg)	18.8 ±8.8	-10.3 ±10	19.7 ±8.6	-	-
Grove-White and Michell, (2001)	84	< 21	-	TCO ₂ 13 (mmol/l)	-	-	-	46.7	-

2.2.3 Measurements of unmeasured strong anions in the plasma

Measurement of unmeasured plasma strong anions such as lactate, β -hydroxybutyrate, acetoacetate and sulphate are not clinically well established.

2.2.3.1 Anion gap

The anion gap (AG) is widely used for the diagnosis of acid-base disorders in humans (Morimatsu et al., 2003), small animals (McCullough and Constable, 2003), horses (Paulson, 1996; Constable et al., 1998) and cattle (Constable et al., 1997). The AG concept arose from the concept of the electroneutrality, where AG represents the difference between the concentration of unmeasured anions (UA) and the concentration of unmeasured cations (UC) in serum (Stocker et al., 1999). This relationship can be expressed by the general equation:

$$\begin{aligned} [\text{Na}^+] + [\text{K}^+] + [\text{UC}] &= [\text{Cl}^-] + [\text{HCO}_3^-] + [\text{UA}] \\ ([\text{Na}^+] + [\text{K}^+]) - ([\text{Cl}^-] + [\text{HCO}_3^-]) &= [\text{UA}] - [\text{UC}] = \text{AG} \end{aligned}$$

The normal range for AG values in animals is 14-20 mmol/l (Schull, 1978; Stocker et al., 1999). However, Ewaschuk et al., (2003) reported a lower AG value of 7.1 mmol/l in healthy calves compared with a higher AG value of 23.4 mmol/l in diarrhoeic calves. This normal range depends partially on the formula used for the calculation (Gabow, 1985). In diarrhoeic calves, Grove-White and Michell, (2001) calculated AG by using the equation:

$$[\text{AG}] \text{ (mmol/l)} = ([\text{Na}^+] - [\text{Cl}^-] - [\text{HCO}_3^-]) \text{ (mmol/l)}$$

The normal range also depends on the species, age and the clinical conditions of the animal. Constable et al., (1997) observed AG values ranging from 21 to 34 mEq/l in neonatal calves compared with AG 14-20 mEq/l in adult non-lactating cattle. On the other hand, Gossett et al., (1987) reported greater values of AG (9-22 mEq/l) in foals aged 2-3 weeks compared with values (8-13 mEq/l) in horses 2 years old. A significant increase in AG has been reported in neonatal calves with experimentally induced diarrhoea (28.6 mEq/l) compared with AG of 29.6 mEq/l in healthy calves and 20.5 mEq/l in adult cattle with abomasal volvulus (Constable et al., 1997). Grove-White and White, (1999) reported AG of about 32.4 ± 8.4 in diarrhoeic calves compared with AG of 28.5 ± 2.2 in healthy calves. In adult cattle, Constable et al., (1991) and Garry et al., (1988, 1989) observed an AG greater than 30 mEq/l in critically ill cattle. Moreover, many investigators have observed various values of AG in healthy calves and calves with clinical and experimental diarrhoea (Table 3). However, no data has been reported previously for serum AG values in young or adult camels.

Table 3 Serum- [AG] (mmol/l) in healthy and diarrhoeic calves (mean±SD).

Reference	Healthy calves			Diarrhoeic calves			Camel
	No of calves	Age (days)	AG	No of calves	Age (days)	AG	
Hartmann et al., (1997)	-	-	-	34	3-28	33 ±10	No data has been reported previously
Constable et al., (1997)	16	3-4	29.6 ±6.2	*16	4-6	28.6 ±5.6	
Ewaschuk et al., (2003)	24	2-34	7.1 ±2.6	52	5-35	23.4 ±7.7	
Gentile et al., 2004)	11	5-23	11.61 ±2.1	-	-	-	
Omole et al., (2004)	21	1-45	5.6 ±3.5	-	-	-	

* Experimental diarrhoea

2.2.3.2 Strong anion gap (SIG)

The SIG is a logical extension of the simplified strong ion model and anion gap concept. This concept is developed by Kellum et al., (1995). They used apparent strong ion difference concentration ([SIDa]) and effective strong ion difference concentration ([SIDE]) described by Figge et al., (1992) to calculate SIG as follows:

$$[\text{SIG}] (\text{mmol/l}) = ([\text{SIDa}] - [\text{SIDE}]) (\text{mmol/l})$$

Moreover, Constable et al., (1998) expressed SIG by the equation:

$$[\text{SIG}] (\text{mmol/l}) = \frac{[\text{A}_{\text{tot}}]}{1 + 10^{(\text{pKa} - \text{pH})}} + \text{AG}$$

In cattle, Constable et al., (1997) showed that SIG is a more accurate approach to identify unmeasured anions in the plasma than AG.

2.2.3.3 Base excess (BE)

Base excess approach has been widely applied to acid-base disturbances in cattle (Stocker et al., 1999) and calves (Gentile et al., 2004). BE is a single variable used to quantify the metabolic component of a patient acid-base status. Siggaard et al., (1966) defined BE as the amount of strong acid needed to neutralise the pH of 100% oxygenated human blood to 7.4 at

37° C and at arterial P_{CO2} of 5.32 kPa (40 mm/Hg). BE characterises the non-respiratory acid-base status and depends on two independent variables, SID and plasma proteins. Several researchers have combined BE with the Stewart's approach to identify acid-base disturbances. In humans, Fencl et al., (2000) and Balasubramanyan et al., (1999) combined BE with Stewart's approach to diagnosis metabolic acidosis in critically ill patients. They examined BE effects of two of the Stewart's independent variables [SID] and [A⁻]. In veterinary clinical studies, BE is well established in calf diarrhoea as a diagnostic parameter (Table 4) but no data has been reported previously for camels.

Table 4 Serum- [BE] (mmol/l) in healthy and diarrhoeic calves (mean±SD).

Reference	Healthy calves			Diarrhoeic calves			Camel
	No of calves	Age (days)	BE	No of calves	Age (days)	BE	
Kasari and Naylor, (1986)	36	≤ 30	-4.9 ±4	36	≤ 30	-18.8 ±4.7	No data has been reported previously
Singh et al., (1989)	6	3-4 weeks	-0.38 ±0.6	6	3-4 weeks	-8.35 ±1.1	
Hartmann et al., (1997)	-	-	-	34	3-28	-20	
Lorenz, (2004)	-	-	-	80	≤ 21	-10, -25	
Gentile et al., (2004)	11	5-23	3.17 ±1.6	11	5-23	-15	
Omole et al., (2004)	21	1-45	6.9 ±2.3	21	1-45	-10.3 ±10	

2.2.4 Total CO₂ concentration

Total CO₂ (TCO₂) is the total amount of CO₂ that is contained in the plasma, and is equal to the actual HCO₃⁻ concentration plus the carbonic acid concentration (Robertson, 1989). Gamble, (1996) considered that the intracellular buffering system during metabolic acidosis appears not to depend on the changes in pH but rather on the changes in [HCO₃⁻] of the blood. Therefore, many investigators used TCO₂ concentration to evaluate acid-base disturbances in calf diarrhoea (Groutides and Michell, 1990; Berchtold, 1998; Crove-White and Michell, 2001).

2.3 Factors that influence acid-base status

2.3.1 Effect of sex, age and physical treatment

Acid-base status is affected by many factors such as age, sex and physical treatments. A close relationship has been reported between acid-base status and the age (Steinhardt et al., 1995). Thus, Reece and Wahlstrom, (1972) reported that the age had a significant effect on acid-base parameters during the 2nd, 3rd and 4th weeks of life in calves. In neonate calves, noticeable fluctuations have been reported in acid-base status during the first minutes and hours of life, which were characterised by lower values of pH, current base excess (BE) and P_{CO_2} (Herfen and Bostedt, 1999). Grove-White, (1998) concluded that calves less than 6 days old were less acidotic than the older ones. Other investigators reported a marked age difference with calves more than 6 days old and they concluded that the older calves were more severely acidotic than the younger ones (Grove-White and Michell, 2001). Observations in diarrhoeic calves have been indicated that the older calves tend to be more acidotic than the younger calves (Naylor, 1987; Grove-White and White, 1993). Moreover, significantly higher values for pH, BE and $[HCO_3^-]$ have been observed in calves of more than 1 month, whereas P_{CO_2} was significantly lower compared with the calves less than one month (Roussel et al., 1998). The same authors reported higher values of BE and $[HCO_3^-]$ in dairy calves than in beef calves. On the other hand, significantly higher pH value has been reported in male calves than female (Reece, 1984). Studies of neonate calves have shown that physical treatments with cold water caused a significant decrease in pH, HCO_3^- and BE. Conversely, treatment with hot water leads to a significant decrease in P_{CO_2} (Uystepuyst et al., 2002).

2.3.2 Effect of diet composition

Dietary cation-anion balance (DCAB) has been reported to have significant impacts on acid-base status in ruminants (Vagnoni and Oetzel, 1998). Intraruminal administration of anionic salts has been used to induce metabolic acidosis in cattle (Löffler, 2004). In other investigations a high anionic diet has been used to induce metabolic acidosis in cows experimentally (Bigner et al., 1997). On the other hand, a gradual increase in pH values has been reported in calves fed high energy diets (Fernandez et al., 1990). Wang and Beede, (1990) concluded that dietary supplementation of increased amounts of protein induced a mild acidosis in non-lactating cows. Observations in cattle have shown that lower dietary concentrations of sodium (Na^+) and potassium (K^+) during pregnancy were associated with lower values of dam pH and BE compared with pH and current BE of their calves. In sequence, cows fed diets high in cations such as Na^+ and K^+ before calving are at an increased risk of developing of hypocalcaemia and milk fever (Goff and Horst, 1997).

2.3.3 Effect of clinical and environmental conditions

Evaluation of acid-base disorders in calf diarrhoea has been studied by Hartmann et al., (1997) and Kasari, (1999). Diarrhoea is a major cause of morbidity and mortality in young calves. It is associated with major metabolic disturbances including dehydration and metabolic acidosis (Grove-White and White, 1999). Neonatal diarrhoea in calves caused a significant decrease in P_{CO_2} and was associated with a distinct respiratory compensation (Berchtold et al., 2000). Acid-base disorders, in particular metabolic acidosis have been observed in neonatal calves with minimal signs of dehydration and no diarrhoea (Kasari and Naylor, 1986). Metabolic acidosis developing in diarrhoeic calves has been observed as a result of the loss of HCO_3^- via the intestinal tract (Naylor, 1987) and the production of lactic acid in the colon (Grove-White and White, 1993). In addition, the formation of D-lactate has been considered to be the major cause of high anion gap acidosis in calves with neonatal diarrhoea (Lorenz, 2006).

In adult cattle, metabolic diseases such as parturient paresis and displaced abomasum are usually associated with acid-base and electrolyte disturbances. Constable et al., (1991) observed acid-base abnormalities (metabolic alkalosis) in cattle with abomasal volvulus. Earlier studies have reported marked changes in acid-base balance in cattle exposed to high environmental temperature (Bianca and Findly, 1962; Bianca et al., 1962). Wallace et al., (1996) observed a reduction in P_{CO_2} , HCO_3^- , BE and arterial blood pH in bull calves exposed experimentally to heat stress.

2.3.4 Effect of therapeutic solutions infusion

NH_4Cl is used as a therapeutic drug for urine acidification in humans (Juncos et al., 2000) and animals (Schober, 1996). NH_4Cl is also used to enhance the effectiveness of antibiotics in urine and as a diagnostic drug for renal tubular acidosis or liver function testing (Polzin et al., 1986). Administration of NH_4Cl has been widely used as model of metabolic acidosis in both humans and animals (Osther et al., 2004; Iwabuchi et al., 2003). In the body, NH_4Cl is taken up by the liver with formation of urea and net release of HCl, which is ultimately responsible for lowering the body's acid-buffering capacity and induction of acidosis (Caso et al., 2004). In veterinary medicine, intravenous administration of 5M NH_4Cl (1.0 ml/kg) has been used to induce metabolic acidosis in calves within 180 min (Iwabuchi et al., 2003). Bushinsky et al., (1999) used 1.5% NH_4Cl for 7 days to induce metabolic acidosis in mice. Several studies have shown that oral administration of NH_4Cl (100 mg/kg) every 12 hrs for 8 days caused a significant decrease in plasma pH, P_{CO_2} , standard HCO_3^- and BE in dogs (Schober, 1996). The

treatment also increased urine acid excretion. In human medicine, Osther et al., (2004) have studied renal responses to acid load by oral administration of various dose of NH_4Cl (0.1, 0.2 and 3 g/kg BW); they concluded that the treatment caused a significant decrease in systemic and urine pH. Clinical study of azotaemic rat has shown that administration of NH_4Cl facilitates renal excretion of phosphorus (Jara et al., 2004). Furthermore, NH_4Cl is also known to cause kidney hypertrophy (Golchini et al., 1989) by inducing an imbalance between protein synthesis and degradation. Jara et al., (2004) reported that NH_4Cl (0.375 % solution) in drinking water caused acidosis in sham operated rats.

In clinical practice, intravenous administration of NaHCO_3 is specifically effective in the treatment of severe cases of metabolic acidosis in calves (Suzuki et al., 2002; Bertchold et al., 2005; Cambier et al., 2005). Earlier studies conducted by Ayers and Besser, (1992) have concluded that intravenous infusion of NaHCO_3 (3 mEq/kg) caused a significant increase in venous pH, P_{CO_2} and HCO_3^- in calves. However, rapid or overdose with 7.0 % hypertonic NaHCO_3 has been associated with the development of extracellular hyperosmolality, cerebrospinal fluid acidosis and intracranial haemorrhage (Hartfield et al., 1981). Moreover, administration of NaHCO_3 via nasogastric tube caused metabolic alkalosis in horses (Freestone, 1989). Other investigators concluded that administration of low volumes of hypertonic NaCl (7.15 %) and dextran 70 (6 %) combination at a dose of 4 ml/kg with oral electrolytes solution (50 ml/kg) is an effective treatment of dehydrated diarrhoeic calves (Sentürk, 2003). In calves, metabolic alkalosis has been induced by intravenous infusion of isotonic NaHCO_3 and furosemide combination (Cambier et al., 2002).

2.4 Acid-base disturbances

The basic buffering systems, the respiratory system and the kidneys keep systemic pH relatively constant; but in severe diseases, these homeostatic mechanisms may be inadequate and an alteration in pH occurs resulting in acid-base disturbances. The problems are mainly related to the alterations in P_{CO_2} with excessive accumulation or elimination of CO_2 , known as respiratory acidosis or alkalosis, respectively. On other hand, an excessive accumulation or elimination of fixed acids causes metabolic acidosis or alkalosis, respectively.

2.4.1 Metabolic acidosis and alkalosis

Metabolic acidosis is an acid-base disturbance caused by a decrease in the plasma HCO_3^- and the higher production of acid in the colon (Grove-White and White, 1993); sometimes it is followed by a secondary respiratory compensation (Berchtold et al., 2000; Omole et al.,

2004). Metabolic acidosis is a well recognised potentially life-threatening consequence of diarrhoea in calves (Grove-White and Michell, 2001; Lorenz, 2004), and it is a complicating factor in a number of diseases that affect cattle, including ketoacidosis (Block, 1994) and lactic acidosis (Zust et al., 2000). Neonatal acidosis has been observed in newborn calves, but this condition disappeared in most cases within 6 to 24 hrs after birth (Varga et al., 2001; Uystepuyst et al., 2000).

In an in vitro study for whole blood dilution, experimentally dilutional metabolic acidosis was induced by infusion of 0.9% saline, which was characterised by a decrease in A_{tot} (Lang and Zander, 2005). In dogs, experimental acute metabolic acidosis occurred within 60-120 min after intravenous infusion of HCl (Halperin and Bun-chen, 1990). Oral administration of NH_4Cl for 7 days has been reported to induce acute metabolic acidosis in mice (Bushinsky et al., 1999). In humans, acute metabolic acidosis has been observed after infusion of 0.9 mmol/kg of NH_4Cl into the duodenum, which was characterised by a decrease in Pa_{CO_2} , a decrease in the plasma- $[\text{HCO}_3^-]$ and a decrease in blood- $[\text{H}^+]$ (Wiederseiner et al., 2004).

On the other hand, metabolic alkalosis can result from a decrease in H^+ production or due to a greater loss of H^+ or Cl^- and an increase in HCO_3^- . In an in vitro study of human blood, metabolic alkalosis was induced by changing the concentration of plasma protein (Rossing et al., 1986; Watson, 1999). In critical care patients, metabolic alkalosis was associated with hypoproteinaemia characterised by low A_{tot} (Wilkes, 1998). In clinical practice, metabolic alkalosis has been observed in cattle with abomasal volvulus (Constable et al., 1991). Metabolic alkalosis has been also reported in calves in association with hypercalcaemia induced by intravenous infusion of calcium (15% solution) for 6 hrs. This condition was characterised by an increased systemic pH, an increased plasma bicarbonate concentration (plasma- $[\text{HCO}_3^-]$) and plasma base excess (plasma- $[\text{BE}]$) (Setia et al., 1990). Moreover, oral administration of magnesium hydroxide, $\text{Mg}(\text{OH})_2$ at a dosage of 0.6 or magnesium oxide, MgO at a dosage of 0.3 g/kg of body weight resulted in severe hypomagnesaemia, metabolic alkalosis and diarrhoea in beef calves (Kasari, 1990). Observations in rats have indicated that a higher plasma Ca^{++} level could generate a metabolic alkalosis and decrease urinary HCO_3^- excretion concurrent with lowered filtrated HCO_3^- (Mercier et al., 1986).

2.4.2 Respiratory acidosis and alkalosis

Respiratory acidosis or alkalosis is caused by alveolar hypoventilation or hyperventilation has been observed as a result of changed arterial P_{CO_2} or a depression of the respiratory control centres. At birth, all healthy newborn calves have a slight mixed respiratory and metabolic

acidosis (Szenci, 1985). A severe respiratory metabolic acidosis occurred in newborn calves during dystocia (Szenci, 1988; Bardos et al., 1991). Postnatal respiratory acidosis ($\text{pH} = 7.25 \pm 0.07$, $\text{P}_{\text{CO}_2} = 7.72 \text{ kPa}$ ($58.08 \pm 3.78 \text{ mm/Hg}$) has been observed in association with a decrease in colostral immunoglobulin absorption in newborn calves (Besser et al., 1990; Ayers and Besser, 1992). Furthermore, an experimental respiratory acidosis has been reported in ventilated calves (Berchtold et al., 2005).

On the other hand, respiratory alkalosis in calves has been observed in association with hyperkalaemia when the level of K^+ increased to 6.08. However, when plasma K^+ rose above 6.08 metabolic acidosis was developed (Singh et al., 1989).

2.5 Renal response to acid-base disturbances

Renal damage has been observed in neonatal rats with experimental chronic metabolic acidosis (Guron et al., 1998). Furthermore, severe diarrhoea in calves caused strong alterations in glomerular capillary and tubular vessels of the kidney, which was characterised by condensed serum protein and endothelial cell proliferations (Hartmann et al., 1988). Renal electrolyte disturbances are usually associated with diarrhoea and dehydration in calves (Lorenz et al., 1998). Moreover, the changes in the renal excretion of electrolytes in response to metabolic diseases and diet composition have been well established in adult cattle (Löffler, 2004). Investigations in dairy cows have concluded that $\text{NH}_4\text{Cl} + \text{MgSO}_4$ used for preventing hypocalcaemia caused a significant decrease in urine pH (Mellau et al., 2002). On the other hand, Hu and Murphy, (2004) reported that DCAB increased urine pH and fractional excretion (FE) of Na^+ , K^+ and Cl^- . Fleming et al., (1992) studied renal excretion of electrolytes after parturition. However, little information is available regarding urinary diagnostic values of healthy calves and camels (Sommandahl et al., 1997). Likewise, few data are available regarding the changes in renal excretion of electrolytes in response to acid-base disturbances (Table 5).

Table 5 Urine pH and fractional of electrolytes in urine of calves and mature cows.

Reference	Animal status	No.	Age	pH	(%)			
					FE _{Na+}	FE _{K+}	FE _{Cl-}	FE _{Pi}
Fleming et al., (1992)	Lactating cows	56	-	-	0.001-0.1	26.9-21.6	0.07-0.25	0.002-0.04
Sommardahl et al, (1997)	Healthy calves	12	1 - 5 d	-	0.69 ±0.5	-	-	13.04 ±8.2
			7- 27 d	-	1.14 ±0.9	-	-	11.4 ±8.3
			28-90 d	-	0.84 ±0.6	-	-	20.1 ±11.3
Mellau et al., (2002)	Mature cows supplemented with a mixture of NH ₄ Cl + MgSO ₄	6	-	5.5	-	-	-	-
Ulutas et al., (2003)	Pregnant cows	20	5 years	-	0.96 ±0.09	97.7 ±5	0.88 ±0.1	0.35 ±0.5
Hu and Murphy, (2004)	Mature dairy cows fed DCAD	-		7.27-7.49	-	-	-	-
Ulutas and Sahal, (2005)	Healthy calves	10	1- 30 d	-	0.19 ±0.3	29.3 ±9.2	0.89 ±0.5	-
	diarrhoeic calves	28	1- 30 d	-	0.16 ±1	15.1 ±8.6	0.66 ±0.4	-

d: days

2.6 Physiological characteristics of the camel

The camel plays an integral role in the daily life of the people in Africa and Asia (Schwartz, 1992). There are two species of camel within the genus *Camelus*. The one humped camel (*Camelus dromedarius*) is most widely distributed in the hot arid areas of the Middle East and Africa; whereas the two humped camel (*Camelus bactrianus*) is found in several parts of Asia. The camel has a special adaptation to live in hot, dry environment and can adapt to hot and arid areas by preserving water as demonstrated by its ability to decrease urine production, sweat economically, and raise body temperature (Schwartz, 1992). Thus, earlier studies of *Camelus dromedarius* have concentrated on its ability to tolerate prolonged periods of water

deprivation (Yagil et al., 1974). Furthermore, many investigators have used haematological and biochemical analysis of the serum to monitor health and for diagnosis of diseases in camels (Abdullah et al., 1988; Haroun et al., 1996). The normal values of some serum biochemical components have been reported previously by many researchers (Table 6).

Table 6 Some serum biochemical components concentration of healthy camels (*Camelus dromedarius*).

Reference	Animal status	No. of camels	Age (years)	(mmol/l)				(g/l)	
				[Na ⁺]	[K ⁺]	[Cl ⁻]	[Pi]	[TP]	[Alb]
Barakat and Abdel-Fathah, (1969)	Healthy mature male and female camels	-	7-15	148.2	4.7	101.4	6.4	64.2	-
Lewis, (1976)	Hydrated adult female camel	1	-	152	4.2	105	8.2	48	34
Yagil et al., (1975)	Hydrated adult female camels	5	-	148	5.18	-	6.07	-	-
Yagil et al., (1975)	Dehydrated adult female camels	5	-	161.8	5.05	-	5.7	-	-
Sharma et al., (1984)	Adult camels	6		180 ±8.5	4.6 ±0.2	117.5 ±3.2	-	109 ±16	-
Abdalla et al., (1988)	Adult racing camels	-	4-6	154	4.6	-	6.6	61	45
Snow et al., (1988)	Adult racing camels	9	5-6	154 ±3.8	4.2 ±0.3	116 ±3.3	2.12 ±0.2	65.4 ±2.4	28.6 ±1.1
Wernery and Wensvoort, (1992)	Young camel	1	1 year	147	3.7	114	-	45	-
Haroun, (1994)	Young Najdi camels	-	About 1 year	-	-	-	-	62.3 ±8.9	33.5 ±8.9
Nazifi and Maleki, (1998)	Adult Iranian camels	-	3-6	143 ±0.9	5.2 ±0.1	98.5 ±2.6	1.9 ±0.1	53	-
Mohamed and Hussein, (1999)	Adult racing camels	100	4-7	148.2 ±17.4	3.96 ±0.4	-	5.02 ±1.2	62.6 ±0.6	-

Reference	Animal status	No. of camels	Age (years)	(mmol/l)				(g/l)	
				[Na ⁺]	[K ⁺]	[Cl ⁻]	[Pi]	[TP]	[Alb]
Bogin, (2000)	Adult camels	-	-	-	5.1 ±0.4	115 ±7	5.2 ±1	73 ±5	37 ±4
Chaudhary et al., (2003)	Young camels	30	<3 m	-	-	-	-	49.7 ±1.8	23.7 ±0.8
Chaudhary et al., (2003)	Adult camels	30	3-8	-	-	-	-	56.8 ±1.5	30.7 ±0.8
Salaman and Afzal, (2004)	Adult racing camels	28	4-8	-	-	-	-	63.3 ±0.3	42.2 ±0.2

Alb: Albumin, TP: total protein, m: months

2.7 Acid-base physiology of the camel

In camels (*Camelus dromedarius*), acid-base parameters have been studied by earlier investigators in venous and arterial blood. The normal venous blood pH has been considered to be 7.45 which have been reported in healthy mature male and female camels aged between 7-15 years (Barakat and Abdel-Fathah, 1969). However, other investigators reported low values of venous blood pH of 7.28 in adult hydrated female camels (Yagil et al, 1975) and a value of 7.34±0.03 in adult racing camels aged between 5-6 years (Snow et al., 1988). The same investigators concluded that dehydration caused a significant increase in venous blood pH to 7.32 in female camels while exercise caused a significant decrease in blood pH to 6.98±0.02. Moreover, Wernery and Wensvoort, (1992) reported normal low venous pH value of 7.26 in one year old camel bull with experimentally induced ruminal acidosis. In racing camels, Knight et al., (1994) reported normal venous pH of 7.36±0.06 compared with 6.99±0.02 after exercise. On the other hand, Sharma et al., (1984), Peshin et al., (1991) and Singh et al., (1994) measured the pH of the arterial blood and reported pH values of 7.34±0.02, 7.49 and 7.34, respectively in healthy adult camels.

Blood P_{CO2} of the vertebrates fluctuates between 4.79-6.65 kPa (36-50 mmHg). However, few studies are available regarding the normal values of P_{CO2} in camels. Yagil et al., (1975) reported low values of venous P_{CO2}, 3.9 kPa in normal hydrated female camels compared with a value of 6.38 kPa in dehydrated female camels. In bacterian camels, Custer et al., (1977) reported a normal venous P_{CO2} value of 7.04 kPa. Knight et al., (1994) reported a venous P_{CO2} value of 6.41 kPa in adult racing camels. In camel bull, Wernery and Wensvoort, (1992)

observed a normal venous P_{CO_2} value of 6.62 kPa. Sharma et al., (1984) and Singh et al., (1994) reported a normal value of P_{aCO_2} of 5.36 and 5.66 kPa in arterial adult camels' blood. However, Peshin et al., (1991) demonstrated a low value of P_{aCO_2} in adult camels.

Few studies have been conducted to evaluate the changes in acid-base status either under physiological circumstances or during diseases in camels. However, many investigators have studied acid-base balance during sedation with xylazine in bacterian camel (Custer et al., 1977) and during anaesthesia with chloral hydrate in dromedary (Sharma et al., 1984). They concluded that neither sedation nor anaesthesia had an effect on acid-base balance in camels with normal acid-base status ($pH = 7.32 \pm 0.03$, $P_{CO_2} = 7.04$ kPa, $HCO_3^- = 26.2 \pm 2.4$ mmol/l and $BE = -1.5 \pm 2$ mmol/l; $pH_a = 7.341 \pm 0.018$, $P_{aCO_2} = 5.36$ kPa, $HCO_3^- = 21.58 \pm 0.59$ mmol/l and $BE = 3.5 \pm 0.79$ mmol/l, respectively). More recent, acid-base balance has been estimated in racing camels by Snow et al., (1988) who reported a decrease in venous pH from 7.34 ± 0.03 to 6.98 ± 0.07 during maximal exercise. The same authors concluded that the decrease in pH has been observed in association with a significant decrease in blood- $[HCO_3^-]$ from 23.6 ± 2.8 to 10.1 ± 2.8 mmol/l and a significant decrease in blood- $[BE]$ from -2.4 ± 1.5 to -22.6 ± 2.8 mmol/l. Knight et al., (1994) reported that the significant decrease in venous pH was accompanied by a significant increase in P_{CO_2} after an intensive exercise in racing camels. A study conducted by Wernery and Wensvoort, (1992) concluded that experimentally induced ruminal acidosis caused a significant increase in venous blood pH (7.34) in one year old camel bull with normal acid-base status ($pH = 7.32 \pm 0.03$, $P_{CO_2} = 7.04$ kPa, $HCO_3^- = 26.2 \pm 2.4$ mmol/l and $BE = -1.5 \pm 2$ mmol/l). The experimental induce ruminal acidosis was also accompanied by a significant reduction in venous blood P_{CO_2} (5.63 kPa). However, little information is available regarding acid-base status in camels in relation to their age. To dates no data has been reported previously to evaluate acid-base status in camels in response to experimentally induced metabolic acidosis.