

**Chemical Synthesis of Oligosaccharides as Basis for the  
Development of Carbohydrate-Based Vaccine Candidates  
against *Streptococcus suis* Serotype 18 and *Candida auris***

Inaugural-Dissertation  
to obtain the academic degree  
Doctor rerum naturalium (Dr. rer. nat.)

Submitted to the Department of Biology, Chemistry, Pharmacy  
of Freie Universität Berlin

By  
Rajat Kumar Singh  
From Uttar Pradesh, India

2023



This work was performed between August 2019 and January 2023 under supervision of Prof. Dr. Peter H. Seeberger in the Department of Biomolecular Systems, Max Planck Institute of Colloids and Interfaces Potsdam and the Department of Biology, Chemistry, Pharmacy, Freie Universität Berlin.

1<sup>st</sup> Reviewer: Prof. Dr. Peter H. Seeberger

2<sup>nd</sup> Reviewer: Prof. Dr. Beate Kokschi

Date of defense: July 20, 2023



## **Declaration of Independence**

Herewith I certify that I have prepared and written my thesis independently and that I have not used any source and aids other than those indicated by me. I also declare that I have not applied for an examination procedure at any other institution and that I have not submitted the dissertation in this or any other form to any other faculty as a dissertation



## **Acknowledgements**

First and foremost, I would like to express my sincere gratitude to my supervisor Prof. Dr. Peter H. Seeberger, for continuous support, encouragement, and guidance throughout my Ph.D. study. He has been an invaluable source of knowledge and has always been there to provide necessary resources and advice.

I am thankful to Prof. Dr. Beate Koksich for kindly agreeing to review my thesis.

I am grateful to my lab mates, Dr. Julinton Sianturi, Dr. Abragam Joseph, and Dr. Manuel Garcia Ricardo, for creating a good working environment, discussing science and making science fun. This experience has been unforgettable to me, and I will never forget it.

I want to thank all the glycobiology and vaccine development group members, Patricia Priegue, Julinton Sianturi, Marilet Sigler, and Fabian Weber, for the insightful and beneficial discussions in group meetings and the fantastic atmosphere in the lab that they created. I would also like to thank all members of the automated glycan assembly group, Dr. Abragam Joseph, Dr. José Angel Danglad-Flores, Dr. Kabita Pradhan, Dr. Georg Niggemeyer, Dr. Manuel Garcia Ricardo, Jiri Ledvinka, Mei-Huei Lin, Phuong Luong, Dr. Eric Sletten, Sebastian Pinzon Lopez, and Dr. Conor Crawford.

I thank to my former colleagues Dr. Sabrina Lechnitz, Dr. Shuo Zhang and Dr. Dacheng Shen for their help during my initial days of Ph.D.

I would like to thank Emelie Reuber for performing glycan microarray screening.

I would like to thank Dr. Abragam Joseph, Dr. Conor Crawford, Dr. Kabita Pradhan and former colleague Dr. Narayana Murthy Sabbavarapu for the corrections and suggestions for this thesis. I also like to thank Georg Niggemeyer for translating the summary into German.

I am grateful to our technicians Eva Settles, Olaf Niemeyer, Felix Hentschel, Katrin Sellrie, and Reinhild Dünnebacke for technical support. I also want to thank department secretary Dorothee Böhme for her help during my stay.

I am also grateful to all those who have directly or indirectly supported me in this journey. I could not have done it without your help and support.

Finally, I would like to thank my parents and friends in Germany and India for their unconditional love and support during this process. I am blessed to have you all in my life.





## List of publications

Singh R. K.; Sianturi, J.; Seeberger, P. H. Synthesis of Oligosaccharides Resembling the *Streptococcus suis* Serotype 18 Capsular Polysaccharide as a Basis for Glycoconjugate Vaccine Development. *Org. Lett.* **2022**, *24*, 2371–2375.

Singh R. K.; Reuber E. E.; Bruno M.; Nerea M. G.; Seeberger, P. H. Synthesis of Oligosaccharides Resembling *Candida auris* Cell Surface Mannans as Basic for Anti-fungal Glycoconjugate Vaccine Development. (Manuscript in preparation)



## Table of contents

<b>List of Abbreviations</b> .....	<b>iii</b>
<b>Summary</b> .....	<b>vi</b>
<b>Zusammenfassung</b> .....	<b>viii</b>
<b>Chapter 1</b> .....	<b>1</b>
<b>Introduction</b> .....	<b>1</b>
1.1 Bacteria.....	1
1.1.1 <i>Streptococcus suis</i> .....	1
1.1.2 Antibiotic.....	2
1.2 Fungi.....	3
1.2.1 <i>Candida auris</i> .....	3
1.2.2 Antifungal drugs.....	4
1.2.3 Antibiotics vs Vaccine.....	5
1.3 Vaccine.....	5
1.3.1 Different type of Vaccines.....	5
1.3.2 Microbial glycoconjugate structures.....	6
1.3.3 Carbohydrate-based vaccines.....	6
1.3.4 Immunology of glycoconjugate vaccines.....	9
1.3.5 Design of semi-synthetic glycoconjugate vaccine.....	10
1.4 Synthesis of oligosaccharides.....	12
1.4.1 Chemical glycosylation reactions.....	12
1.4.2 Nucleophile.....	12
1.4.3 Historial development of glycosyl donors.....	13
1.4.4 General reaction mechanism.....	14
1.4.5 Stereoselectivity of glycosylation.....	16
1.4.6 Protecting group.....	16
1.4.7 Solvent effect.....	17
1.5 Automated solid-phase synthesis.....	18
1.6 Aim of the thesis.....	20
<b>Chapter 2</b> .....	<b>21</b>

**Synthesis of Oligosaccharides Resembling the *Streptococcus suis* Serotype 18 Capsular Polysaccharide as a Basis for Glycoconjugate Vaccine Development**

2.1 Introduction.....	21
2.2 Results and discussion.....	23
2.2.1 Synthetic strategy.....	23
2.2.2 Synthesis of orthogonally protected building blocks.....	25
2.2.3 Synthesis of oligosaccharides <b>2.1</b> and <b>2.2</b> .....	27
2.2.4 Synthesis of oligosaccharides <b>2.3</b> , <b>2.4</b> and <b>2.5</b> .....	30
2.3 Conclusion and outlook.....	32
2.4 Experimental section.....	33
2.4.1 General information.....	33
2.4.2 Experimental procedure and spectral data.....	34
<b>Chapter 3.....</b>	<b>61</b>
<b>Synthesis of Oligosaccharides Resembling <i>Candida auris</i> Cell Surface Mannans as Basis for Anti-fungal Glycoconjugate Vaccine Development</b>	
3.1 Introduction.....	61
3.2 Result and discussion.....	62
3.2.1 Synthesis of Mannose Building Block <b>3.4</b> and <b>3.5</b> .....	64
3.3 AGA.....	66
3.3.1 Optimization of coupling conditions.....	66
3.3.2 Synthesis of oligosaccharide <b>3.28</b> .....	68
3.4 Synthesis of oligosaccharide <b>3.29</b> , <b>3.30</b> , <b>3.31</b> and <b>3.32</b> .....	71
3.5 Glycan microarray screening.....	75
3.6 Conclusion and outlook.....	77
3.7 Experimental section.....	78
3.7.1 General information.....	78
3.7.2 Experimental procedure and spectral data.....	79
<b>References.....</b>	<b>115</b>

## Abbreviations

Å	Angstrom, $10^{-10}$ m
Ac	Acetyl
AIBN	azobisisobutyronitrile
BAIB	bis(acetoxy)iodobenzene
Bn	Benzyl
BSA	Bovine serum albumin
Bu	Butyl
Bz	Benzoyl
Cbz	Benzyloxycarbonyl
CPS	Capsular polysaccharide
CRM	Cross-reacting material
CPS	Capsular polysaccharide
CSA	Camphorsulfonic acid
CWPS	Cell wall polysaccharide
DCM	Dichloromethane
DDQ	2,3-dichloro-5,6-dicyano-1,4-benzoquinone
DIC	<i>N,N'</i> -Diisopropylcarbodiimide
DMAP	4-( <i>N,N</i> -dimethylamino)pyridine
DMF	Dimethylformamide
DMSO	dimethylsulfoxide
EDC	1-ethyl-3-(3-dimethylaminopropyl)carbodiimide
ESI-MS	Electrospray ionization-mass spectrometry
Et	Ethyl
Fmoc	9-Fluorenylmethoxycarbonyl
Gal	Galactose
Glc	Glucose

HMBC	Hetronuclear multiple bond coherence
HRMS	High resolution mass spectroscopy
HPLC	High-performance liquid chromatography
HSQC	Hetronuclear single quantum coherence spectroscopy
ICU	Intensive care unit
Ig	Immunoglobulin
Lev	Levulinoyl (4-Oxopentanoyl)
MALDI-MS	Matrix-assisted laser desorption ionization-mass spectrometry
Man	Mannose
Me	Methyl
MDR	Multidrug-resistant
MS	Molecular sieves
Nap	2-Naphtylmethyl
NBS	<i>N</i> -bromosuccinimide
NHS	<i>N</i> -hydroxysuccinimide
NIS	<i>N</i> -iodosuccinimide
NMR	Nuclear magnetic resonance
Nu	Nucleophile
PBS	Phosphate-buffered saline
Py	Pyridine
r.t.	Room temperature
TBAI	Tetrabutylammonium iodine
TBS	<i>tert</i> -butyldimethylsilyl
TCA	Trichloroacetyl
TEA	Triethylamine
TfOH	Trifluoromethanesulfonic acid
TFA	Trifluoroacetic acid
THF	Tetrahydrofuran

TLC	Thin layer chromatography
TMSOTf	Trimethylsilyl trifluoromethanesulfonate
Tol	Toluene
Tris	<i>tris</i> -(Hydroxymethyl)aminomethane
TTBP	2,4,6-tri- <i>tert</i> -butylpyrimidine
UV	Ultraviolet
WHO	World Health Organization

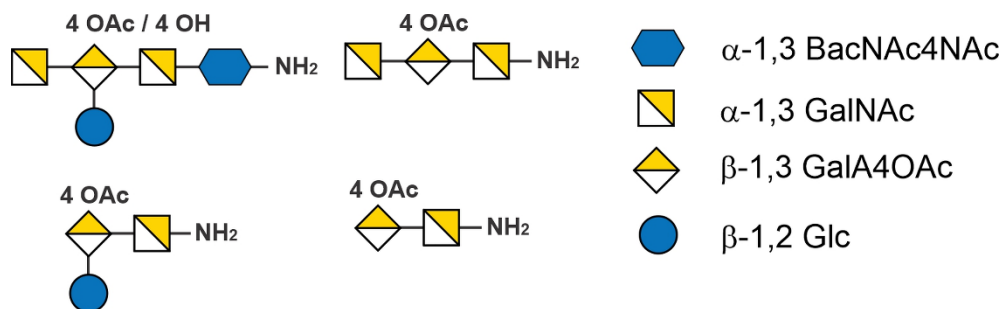
## Summary

Bacterial infections have been increasing in recent year, and this trend is a significant public health concern worldwide. There are several reasons for this, including the overuse and misuse of antibiotics, which has led to the spread and emergence of antibiotic-resistant bacteria. Developing a vaccine while resistance is rising is crucial to combat this issue. Vaccines can help reduce antibiotic use, which can slow the development of antibiotic resistance.

Capsular polysaccharides (CPSs) on the surface of bacteria play an essential role in the virulence of bacteria by protecting them from the host's immune system. Because of their important role in bacterial virulence, CPSs are often targeted by vaccines and antimicrobial therapies. Carbohydrates based vaccines can be developed to stimulate the immune system to produce antibodies against specific CPSs, which can then prevent or reduce the severity of infections caused by the targeted bacteria.

Vaccines based on synthetic oligosaccharides are a type of subunit vaccine that mimic the structure of natural polysaccharide antigens found on the surface of bacteria. The advantage of synthetic oligosaccharides in vaccines is that they are well-defined and can be produced in large quantities with high purity, unlike polysaccharides obtained from natural sources, which can have variable structures and impurities. In addition, synthetic oligosaccharides can be designed to elicit a specific immune response, reducing the risk of adverse reactions or non-specific immune activation.

The first part of my research focused on synthesizing five novel synthetic oligosaccharides resembling the capsular polysaccharides of *Streptococcus suis* serotype 18 using solution-phase chemistry (Scheme I). The main goal of this part is to develop new methods for synthesizing oligosaccharides that represent capsular polysaccharide (CPS) sequences from pathogenic bacteria to identify minimum antibody epitopes. Five differentially protected building blocks were synthesized and employed in glycosylations to assemble the oligosaccharides. The neighbouring and remote participation ensured the stereoselectivity of the glycosidic bond during glycosylation.

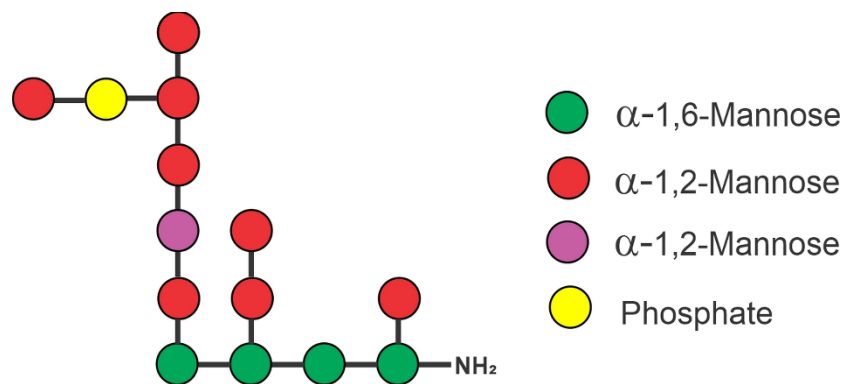


**Scheme I:** Oligosaccharides resembling *Streptococcus suis* serotype 18

The second part of my dissertation focused on fungi *Candida auris*. Antifungal drugs that are resistant to *Candida auris* is a significant concern because it can lead to treatment failures, prolonged hospital stays, and increased mortality. Chapter 3 describes the synthesis of oligosaccharides resembling the key immunogenic structure of *Candida auris* KCTC 17810



(Scheme II). The goal was accomplished using a combination of synthetic chemical approaches that included automated solid-phase and solution-phase methods. A new method was developed to synthesize phosphodiester linkages on the solid phase.



**Scheme II:** Structure of *Candida auris* KCTC 17810 Mannan

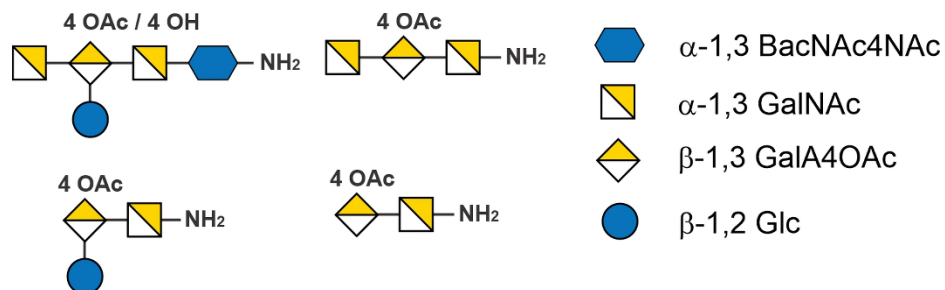
## Zusammenfassung

Bakterielle Infektionen haben in den vergangenen Jahren stetig zugenommen. Dieser Trend stellt weltweit ein großes Problem für die öffentliche Gesundheit dar. Dafür gibt es mehrere Gründe, u. a. den übermäßigen und missbräuchlichen Einsatz von Antibiotika, der zur Ausbreitung und Entstehung von Antibiotikaresistenzen in Bakterien führt. Daher ist die Entwicklung eines Impfstoffs für die Bekämpfung dieses Problems von entscheidender Bedeutung. Impfstoffe können dazu beitragen, den Einsatz von Antibiotika zu reduzieren, was die Entwicklung von Antibiotikaresistenzen verlangsamen kann.

Kapselpolysaccharide (KPS) spielen eine wesentliche Rolle bei der Virulenz der Bakterien, indem sie den Erreger vor dem Immunsystem des Wirts schützen. Wegen ihrer wichtigen Rolle bei der bakteriellen Virulenz sind KPS Gegenstand von Impfstoffkampagnen und antimikrobielle Therapien. Kohlenhydratbasierte Impfstoffe könnten das Immunsystem zur Bildung von Antikörpern gegen bestimmte KPS anregen, die die Schwere der entsprechenden bakteriellen Infektionen verringern können.

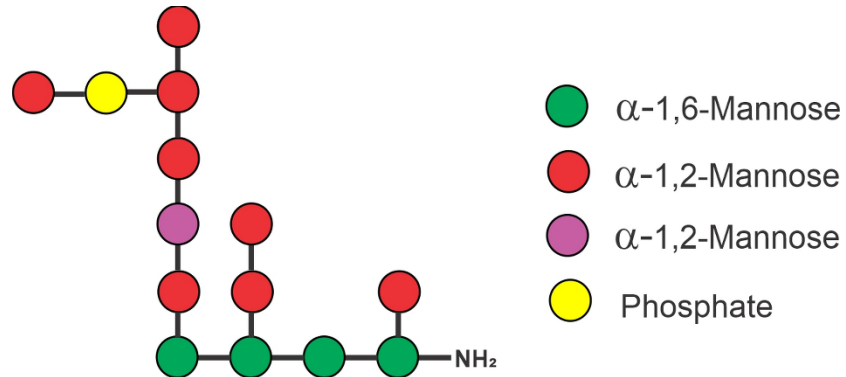
Impfstoffe auf der Grundlage synthetischer Oligosaccharide sind eine Art Untereinheit-Impfstoff, der die Struktur natürlicher Polysaccharid-Antigene auf der Oberfläche von Bakterien nachahmt. Der Vorteil von synthetischen Oligosacchariden als Impfstoffen besteht darin, dass sie genau definiert sind und in großen Mengen mit hoher Reinheit hergestellt werden können, während Polysacchariden aus natürlichen Quellen oft variable Strukturen und Verunreinigungen aufweisen. Die Spezifität der provozierten Immunantwort kann bei synthetischen Oligosaccharidimpfstoffen durch das Level an Komplexität sichergestellt werden. Somit können synthetischer Aufwand und das Risiko auf unerwünschte Immunantwort minimiert werden.

Der erste Teil meiner Forschung konzentrierte sich auf die Synthese von fünf neuartigen, synthetischen Oligosacchariden, die den kapsulären Polysacchariden von *Streptococcus suis* Serotyp 18 ähneln. Das Hauptziel dieses Teils ist die Identifizierung minimaler Epitope durch die Entwicklung neuer Methoden zur Synthese von Kapselpolysaccharid-Sequenzen von pathogenen Bakterien möglich zu machen. Es wurden fünf orthogonal geschützte Bausteine synthetisiert und via Glykosylierungen zu Oligosacchariden zusammengesetzt. Hierbei wurde die Stereoselektivität der jeweiligen glykosidischen Bindung durch direkte und entfernte Nachbargruppenbeteiligung sichergestellt.



**Scheme I:** *Streptococcus-suis*-serotype-18-ähnliche Oligosaccharide

Der zweite Teil meiner Dissertation befasste sich mit dem gegen Antimykotika resistenten Pilz *Candida auris*. Zunehmende Resistenzen bei *Candida auris* geben Anlass zu großer Sorge, da sie zu Behandlungsfehlern, verlängerten Krankenhausaufenthalten und erhöhter Sterblichkeit führen können. Kapitel 3 beschreibt die Synthese von Oligosacchariden, die die wichtigste immunogene Struktur von *Candida auris* KCTC 17810 nachahmen (Schema II). Das Ziel wurde durch eine Kombination von synthetischen chemischen Ansätzen erreicht, die automatisierte Festphasen- und Lösungsphasenmethoden umfassten. Außerdem wurde eine neue Methode zur Synthese von Phosphodiesterbindungen in der festen Phase entwickelt.



**Scheme II:** Chemische Struktur des prominentesten *Candida auris* KCTC 17810 Mannan

# *Chapter 1*

## **Introduction**

### **1.1 Bacteria**

Bacteria are single-celled microorganisms that can reproduce independently and be found in almost every environment on Earth, from the deepest ocean trenches to the highest mountain peaks.<sup>1</sup> Bacteria are incredibly diverse, with thousands of known species. The discovery of bacteria is credited to Antonie van Leeuwenhoek, a Dutch scientist who was the first to observe and describe single-celled organisms.<sup>2</sup> They are responsible for breaking down organic matter<sup>3</sup> and releasing nutrients into the soil, and playing a role in the global carbon cycle. Bacteria are also crucial for the health of humans and animals, as many species are beneficial and are used in medicine, food production, and bioremediation.<sup>4</sup>

Bacteria that can cause infections such as pneumonia, meningitis, strep throat, etc., are called pathogenic bacteria.<sup>5</sup> Bacterial pathogenesis is the process by which bacteria cause disease in an organism. This process involves a complex interaction between the bacteria and the organism's cells, tissues, and organs. The bacteria must first attach to the host and then invade and multiply within the host.<sup>6</sup> The bacteria may also produce toxins and other molecules that can damage the host's cells and tissues, leading to pathology. Other bacteria can evade the host immune system and persist in the body, leading to long-term chronic disease.<sup>7</sup>

#### **1.1.1 *Streptococcus suis***

*Streptococcus suis* (*S. suis*) is a Gram-positive, peanut-shaped, facultative anaerobe bacterium and an important pathogen of the pig. It was isolated during an outbreak among pigs in the Netherlands<sup>8</sup> in 1954, and since then, it has been found in pigs in countries across Asia, Europe, the Americas, and Africa, indicating that it has spread globally. Almost all the swine herds have asymptomatic carriers, and morbidity due to infection with *S. suis* is in the range of <1% to >50%.<sup>9</sup> Around 35 serotypes of *S. suis* are known, and only a limited number are responsible for infections in the pig. In pigs, *S. suis* can be transmitted nasally, orally or via vaginal secretions during parturition. In some countries, such as the United States, losses due to *S. suis* have been estimated to be millions of dollars.<sup>10</sup> In other countries, such as China, losses due to *S. suis* have been estimated to be billions of dollars. Besides pigs, *S. suis* can be isolated from other animals, such as cats, dogs, and deer.

*S. suis* infections are zoonotic, meaning they can be transmitted from animals to humans. The first case of *S. suis* human infection was reported in 1968 in the Netherlands.<sup>11</sup> Until 1983, human infection was reported only in Europe. However, since 1968 many patients with meningitis and septicemia due to *S. suis* have been reported in Hong Kong and Canada. Humans can be infected through contact with infected pigs or by consuming contaminated pork or pork products. Common symptoms of *S. suis* infection include fever, headache, sore throat, nausea, vomiting, joint pain,

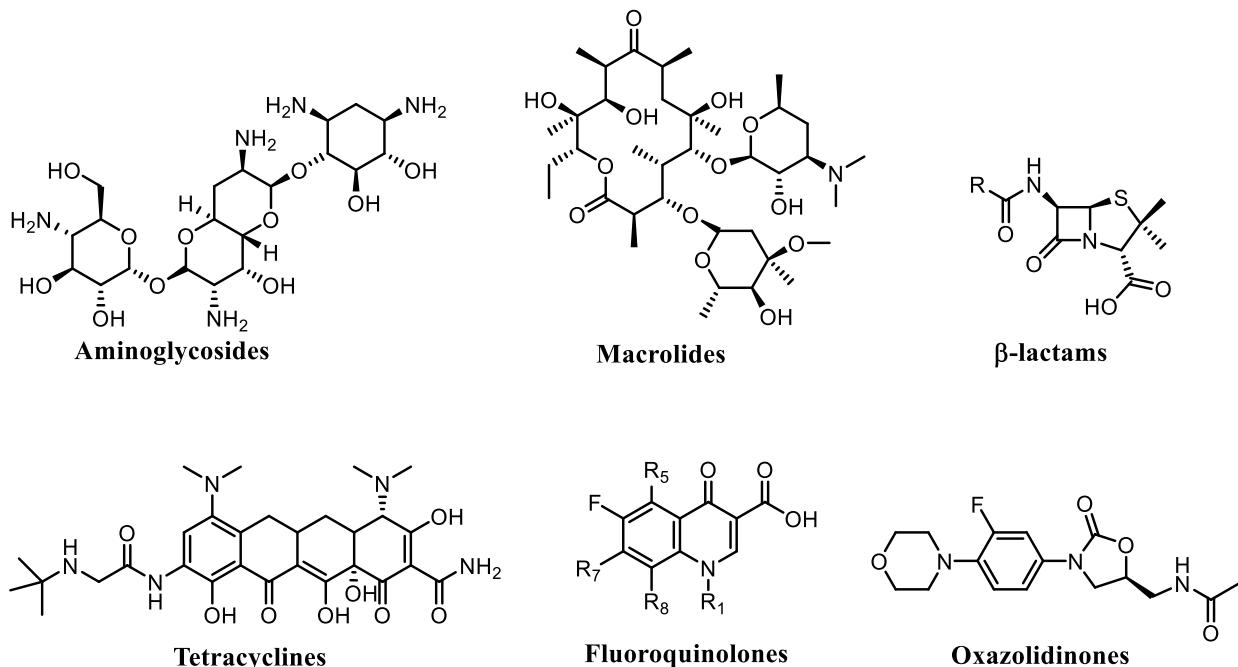
rash, and abdominal pain. In more severe cases, meningitis, encephalitis, and sepsis can occur.<sup>11</sup> Treatment typically involves antibiotics and, in some cases, hospitalization or intensive care.

The cell wall of *Streptococcus suis* is composed of a peptidoglycan layer which is surrounded by a polysaccharide capsule. The capsule is composed of polysaccharides and other components, including lipids and proteins. The peptidoglycan layer comprises a mesh of polysaccharide strands and peptides cross-linked by peptide bridges. This layer serves as a physical barrier to protect the cell from its environment and also plays a role in the cell's ability to adhere to other cells and surfaces.

### **1.1.2 Antibiotics**

Bacterial infections have been documented throughout human history, with some of the earliest evidence of bacterial infections being found in ancient skeletons. The history of outbreaks dates back to the Roman Empire when a plague known as the Antonine Plague<sup>12</sup> killed approximately 5 million people in 165-180 AD. Over the next few centuries, outbreaks of plague, smallpox, cholera, and other diseases devastated populations around the world. The first recorded pandemic was the Plague of Justinian<sup>13</sup>, which began in 541 AD and killed an estimated 25 million people over the next 200 years. This was followed by the Black Death<sup>14</sup> in the 14th century, which killed a third of Europe's population and is estimated to have killed between 75 and 200 million people worldwide.<sup>15</sup>

In 1928, Alexander Fleming discovered penicillin, the first antibiotic, which revolutionized the treatment of bacterial infections. Penicillin works by inhibiting the growth of bacteria by interfering with their cell wall synthesis.<sup>16</sup> It is effective against a wide range of bacteria, including ones that cause illnesses such as pneumonia, strep throat, and meningitis. Penicillin has saved countless lives since its discovery and has been used to treat various illnesses since then. In the 1950s, the development of antibiotics continued, with new generations of antibiotics being developed to treat more resistant bacteria (Figure 1.1).<sup>17</sup> In the 1970s, the emergence of antibiotic resistance began to be recognized, leading to the development of new strategies to combat bacterial infections.<sup>18</sup> Bacteria can evolve and become resistant to antibiotics through several mechanisms. These include mutations in their genetic material, the acquisition of new genes (particularly those coding for antibiotic resistance), and the development of new metabolic pathways that enable them to survive in the presence of antibiotics. Bacteria can also become resistant through the production of enzymes that degrade antibiotics or through increasing the permeability of their cell walls, allowing antibiotics to be released before they have time to act.<sup>19</sup> In fact, Overuse of antibiotics can lead to the development of antibiotic-resistant bacteria.<sup>20</sup> This means that antibiotics will no longer be effective in treating infections caused by these bacteria, which can make infections harder to treat. Today, bacterial infections continue to be a significant health concern. The emergence of antibiotic-resistant bacteria has created a need for new treatments, and researchers are continuing to develop new treatments and preventive strategies to combat bacterial infections.



**Figure 1.1:** Different classes of commonly used antibiotics

## 1.2 Fungi

Fungi are eukaryotic organisms with one or more cells that can be found in many different environments.<sup>21</sup> They can take various shapes, ranging from fungi visible to the naked eye, like mushrooms, to tiny yeasts and molds. While most fungi do not play a significant role in human disease, hundreds of fungi cause fungal infections or diseases.<sup>22</sup> Fungal infections (mycoses) vary from severe, potentially fatal illnesses like cryptococcal meningitis to common benign infections like "jock itch." All pharmaceuticals, natural remedies,<sup>23</sup> and chemical substances used to treat mycoses fall under the umbrella name "antifungals."

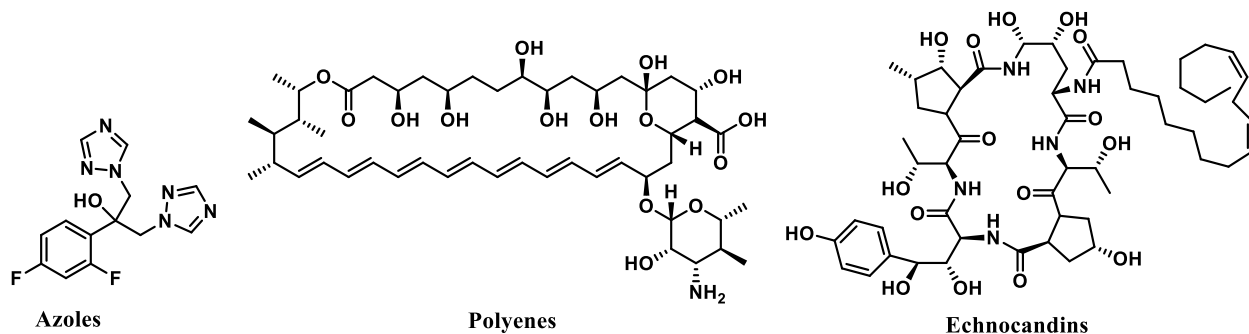
### 1.2.1 *Candida auris*

*Candida auris* (*C. auris*) is a species of yeast believed to have originated in Asia and was first reported in 2009 at a hospital in Japan from a patient's ear canal.<sup>24</sup> It is an emerging, multidrug-resistant, potentially life-threatening infection that can cause sepsis, meningitis, and other severe conditions if left untreated. *C. auris* has been found in hospitals and other healthcare settings worldwide and has been linked to outbreaks in some countries.<sup>25</sup> The infection is most commonly found in healthcare settings and can be spread from person to person through contact with contaminated surfaces or medical equipment. Symptoms of *C. auris* infection vary but may include fever, chills, confusion, and general discomfort. Diagnosis is typically made through a combination of laboratory testing and medical history.<sup>26</sup> Treatment of *C. auris* infections is often tricky and has been increasing drug resistance to fluconazole, amphotericin B, voriconazole, and emerging caspofungin. In 2022, the World Health Organization (WHO) published<sup>27</sup> a report high

lighting the first-ever list of fungal “priority pathogens”, and it has 19 fungi that represent the greatest threat to public health. This list is arranged into three priorities tiers: critical, high, and medium. *C. auris* has been listed in the “critical priority group” of this list for which there is an urgent need to develop a vaccine.

### 1.2.2 Antifungal Drugs

Antifungal drugs are essential to today's medical care of mycoses and comprise a pharmacologically diverse group of drugs. While the field of antimycotic pharmacology has made great strides, especially in the last three decades,<sup>28</sup> the common invasive fungal infections still carry a high mortality rate: *Candida albicans* (approx. 20 to 40% mortality), *Aspergillus fumigatus* (approx. 50 to 90%), *Cryptococcus neoformans* (approx. 20 to 70%).<sup>29</sup> The first antimycotic drug, a polyene antibiotic called amphotericin B deoxycholate, was introduced in 1958 to treat systemic mycoses. Although this medication is effective, there is a clear demand for further effective topical, oral, and injectable medications. The second family of antifungals, griseofulvin, was first introduced in 1959. The following significant introduction was when the antimetabolite drug flucytosine entered into the market. Clotrimazole, the first azole, was introduced in 1973,<sup>30</sup> and the pharmaceutical industry has developed subsequent azoles during the past 50 years: miconazole (1979), ketoconazole (1981), fluconazole (1990), itraconazole (1992), voriconazole (2002), posaconazole (2006), and most recently isavuconazonium (2015). In 1996, the FDA approved the allylamine antifungal terbinafine<sup>31</sup> to treat localized, non-systemic fungal infections. The next advancement in systemic therapy would be based on amphotericin B lipid formulations,<sup>32</sup> which have fewer side effects. The recently developed echinocandins<sup>33</sup> class follows lipid formulations of azoles, a new class of antifungal drugs that are very effective in treating various systemic mycoses. Echinocandins have less renal toxicity than amphotericin B, but they are more expensive and induce considerable hepatotoxicity, effectively relegating this class to second- or third-line medicines (Figure 1.2). Although many different antifungal drugs have different mechanisms of action, new medications are more important than ever due to the alarming and rapid rise in drug-resistant systemic fungal infections.



**Figure 1.2:** Different classes of anti-fungal drugs

### **1.2.3 Antibiotics vs Vaccines**

Vaccines and antibiotics are used to prevent and treat illnesses, but they work differently. Antibiotics work by killing or inhibiting the growth of certain bacteria. In contrast, a vaccine works by stimulating the body's immune system to create antibodies specific to the disease-causing organism.<sup>34</sup> Vaccines are usually more effective than antibiotics in treating and preventing infectious diseases. Vaccines can also provide long-term protection, whereas antibiotics only offer short-term protection. Vaccines can help prevent illnesses caused by bacteria and viruses, while antibiotics are used to treat illnesses caused by bacteria.

## **1.3 Vaccines**

The history of pathogen vaccines dates back to the late 18th century when Edward Jenner developed the first vaccine for smallpox.<sup>35</sup> This was the first in a long line of vaccines against various pathogens, including cholera, rabies, typhoid, tuberculosis, and plague. In the 20th century, advances in vaccine technology led to the development of more effective and safer vaccines, such as the polio vaccine (developed in the 1950s)<sup>36</sup>, the measles vaccine (developed in the 1960s),<sup>37</sup> and the influenza vaccine (developed in the 1970s).<sup>38</sup> In the 21st century, the development of new technologies such as genetic engineering and recombinant DNA technology, as well as the increasing use of adjuvants, has enabled the production of more effective and safer vaccines for a various range of pathogens.<sup>39</sup>

### **1.3.1 Different type of vaccines**

#### **(a) Whole-Pathogen Vaccines**

A whole pathogen vaccine is a vaccine that contains a weakened or dead form of the entire microorganism that causes a particular disease.<sup>40</sup> These vaccines often provide complete protection against the disease in question, as they elicit an immune response directed against the whole pathogen.<sup>41</sup> Whole pathogen vaccines are most commonly used to protect against bacterial and viral infections, although they can also be used to protect against other types of infectious agents. Examples of whole pathogen vaccines include the measles, mumps, and rubella (MMR) vaccines.

#### **(b) Nucleic Acid Vaccines**

Nucleic acid vaccines are a type of vaccine that uses genetic material such as DNA or RNA to induce an immune response.<sup>42</sup> They are relatively new and have been developed to target specific diseases. Unlike traditional vaccines, which rely on weakened or inactivated pathogens to create an immune response, nucleic acid vaccines use genetic material to stimulate the body's immune system to produce protective antibodies.<sup>43</sup> These vaccines can be created from genes that code for the target disease's proteins and can be used to create a specific immune response.

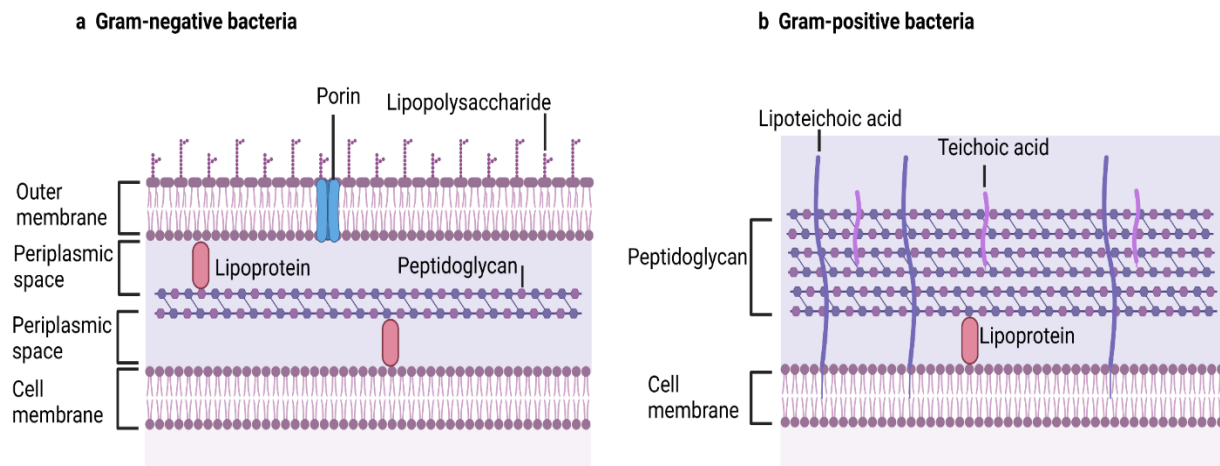
#### **(c) Subunit Vaccines**



Subunit vaccines are made up of components of the disease-causing organism. These components are typically proteins or polysaccharides.<sup>44</sup> The components are isolated from the organism and combined with a carrier substance that helps the body to recognize the antigen.<sup>45</sup> This type of vaccine does not contain any live or attenuated microorganisms, so it is considered as a safer alternative than live vaccines.

### 1.3.2 Microbial glycoconjugate structures

Bacterial cells commonly communicate with the outer world through a coating of polysaccharides. Occasionally, this structure is also known as a "glycocalyx." Bacterial polysaccharides are classified into different types: capsular polysaccharides (CPS), exopolysaccharides (EPS), teichoic acid (TA) and lipopolysaccharides (LPS).<sup>46</sup> In Gram-negative bacteria, CPSs are found on the outer membrane, and they are connected to the reducing end of the cell surface by covalent bonds to phospholipid or lipid A molecules,<sup>47</sup> whereas in Gram-positive glycosidic linkages hold CPSs to the peptidoglycan (Figure 1.3.1).<sup>48</sup>



**Figure 1.3.1:** Representation of the general cell wall structure of Gram-negative bacteria (left) and Gram-positive bacteria (right) (Created with BioRender.com).

It has been established that capsular polysaccharides, the outermost layer of bacterial cells, have significant virulence factors for many bacterial diseases. These molecules help in the bacteria's defense against toxins and stressful environmental conditions, occurrence and the development of invasive disease and also promote the occurrence and development of invasive diseases. CPSs facilitate the production of biofilms and colonization by enhancing bacterial adhesion to other cells. Additionally, capsules may strengthen the host's resistance to non-specific and specific immunity.

### 1.3.3 Carbohydrate-based vaccines

Carbohydrate-based vaccines are a type of vaccine that use carbohydrates as a way to stimulate an immune response.<sup>49</sup> These vaccines work by using a carbohydrate molecule to mimic a pathogen, such as a virus or bacteria, and trigger the body to create antibodies to fight against the real pathogen if it is encountered. Carbohydrate-based vaccines are relatively new and are still under development, but they could potentially be used to treat a wide range of infectious diseases. Because these vaccines use only specific pieces of the germ, they give a very strong immune response targeted to key parts of the germ. They can also be used for almost everyone including people with weakened immune systems and long-term health problems.<sup>50</sup>

The history of carbohydrate-based vaccines dates back to the early 20th century when Avery and Heidelberger's studies began with the observation of agglutination in *Streptococcus pneumoniae* (*pneumococcus*).<sup>40</sup> They showed that the phenomenon was due to a substance in the bacterial cells, which was later identified as the capsular polysaccharide (CPS). They then conducted further experiments in which they demonstrated that this polysaccharide was responsible for the immunogenicity of *pneumococcus*. They also established that the capsular polysaccharide was essential for producing antibodies that protect against pneumococcus. In 1930, Francis and Tillett's first to demonstrated the potential of polysaccharide vaccines to induce immunity in humans.<sup>49</sup> They injected pure pneumococcal polysaccharides into patients and found that specific antibodies were produced in response to the polysaccharide antigens. Then, Heidelberger and his associates developed a tetravalent vaccine<sup>51</sup> during World War II from 1942 to 1945. The vaccine was tested in the US Army Air Force, and the tests were successful. Inspired by the success of the pneumococcal CPS vaccine, the tetravalent (A, C, W135 and Y) meningococcal, the *Haemophilus influenzae type b* (Hib) and the Salmonella typhi Vi CPS-based vaccine were developed and licensed.

In their landmark study, Avery and Goebel demonstrated that the immunogenicity of a capsular polysaccharide (the protective outer layer of certain bacteria) could be significantly enhanced when it was coupled with a carrier protein.<sup>52</sup> The carrier protein helps the body to recognize and take up the antigen more effectively. They used a capsular polysaccharide from the pneumococcal bacterium as their test antigen and coupled it with a protein from the same bacteria. When injected into mice, the coupled antigen produced a much stronger immune response than the antigen alone. Their findings provided a breakthrough in the development of vaccines, as they showed that coupling a capsular polysaccharide with a protein could significantly improve the effectiveness of a vaccine.

Prevenar™ (PCV7), the first licensed pneumococcal glycoconjugate vaccine produced by Wyeth laboratories, is a conjugate vaccine introduced in 2000.<sup>53</sup> This vaccine has CRM<sub>197</sub> as a carrier protein. CRM<sub>197</sub> is a non-toxic mutant of diphtheria toxin designed to be harmless when injected into the body. The vaccine was initially recommended for children under two years of age and is now recommended for all children under five. The vaccine is designed to prevent *Streptococcus pneumoniae* infections, the most common cause of severe bacterial pneumonia, meningitis, and

**Table 1:** Carbohydrate-based vaccines approved by the FDA (*This table was adopted from US Food and Drug Administration website <http://www.fda.gov>*)

Antigen	Indications	Trade name	Manufacturer	Carrier Protein	Adjuvant	Age approval
<i>Haemophilus influenzae</i> type b; CPS (polyribosyl-rivitol-phosphate)	Invasive disease caused by <i>Haemophilus influenzae</i> type b	HIBERIX	GlaxosmithKline Biologicals	TT	-	Children 6 weeks-4 years
		ACTHIB	Sanofi Pasteur	TT	-	Children 2 months-5 years
	Diphtheria, tetanus, pertussis, poliomyelitis, and invasive disease caused by <i>Haemophilus influenzae</i> type B	Liquid PedvaxHIB	Merck sharp & Dohme	OMPC	amorphous aluminium hydroxyphosphate sulfate	Children 2 months-5 years
		Pentacel	Sanofi Pasteur	TT	Aluminium phosphate	Children 6 weeks-4 years
<i>Neisseria meningitidis</i> serogroups A, C, Y and W-135 (Menactra, Menveo, Menomune-A/C/Y/W-135) or serogroup W (MenQuadfi); CPS	Invasive meningococcal disease caused by <i>Neisseria meningitidis</i> serogroups A, C, Y and W-135 or W	VAXELIS	MCM vaccine	OMPC	Aluminium salts (various)	Children 6 weeks-4 years
		Menactra	Sanofi Pasteur	DT	-	9 months-55 years
	or serogroup W (MenQuadfi); CPS	MENVEO	GlaxoSmithKline Biologicals SA	CRM <sub>197</sub>	-	2 months-55 years
		Menomune -A/C/Y/W-135	Sanofi Pasteur	-	-	≥2 years
<i>Salmonella enterica</i> serovar Typhi; cell surface Vi polysaccharide	Typhoid fever caused by <i>salmonella enterica</i> serovar Typhi	MenQuadfi	Sanofi Pasteur	TT	-	≥2 years
		Typhim Vi	Sanofi Pasteur	-	-	≥2 years
<i>Streptococcus pneumoniae</i> serotype 1, 3, 5, 6A, 6B, 7F, 9V, 14, 18C, 19A, 19F, and 23F; CPS	Invasive disease caused by <i>Streptococcus pneumoniae</i> serotype 1, 3, 5, 6A, 6B, 7F, 9V, 14, 18C, 19A, 19F, and 23F	Pprevnar 13	Wyeth pharmaceuticals	CRM <sub>197</sub>	Aluminium phosphate	Children 6 weeks-5 years; children 6 years-17 years; adults ≥18 years
<b>Pneumococcal</b> serotype 1, 2, 3, 4, 5, 6B, 7F, 8, 9N, 9V, 10A,	Pneumococcal disease caused by serotype 1, 2, 3, 4, 5, 6B, 7F, 8, 9N, 9V,	Pneumovax 23	Merck sharp & Dohme	-	-	≥2 years

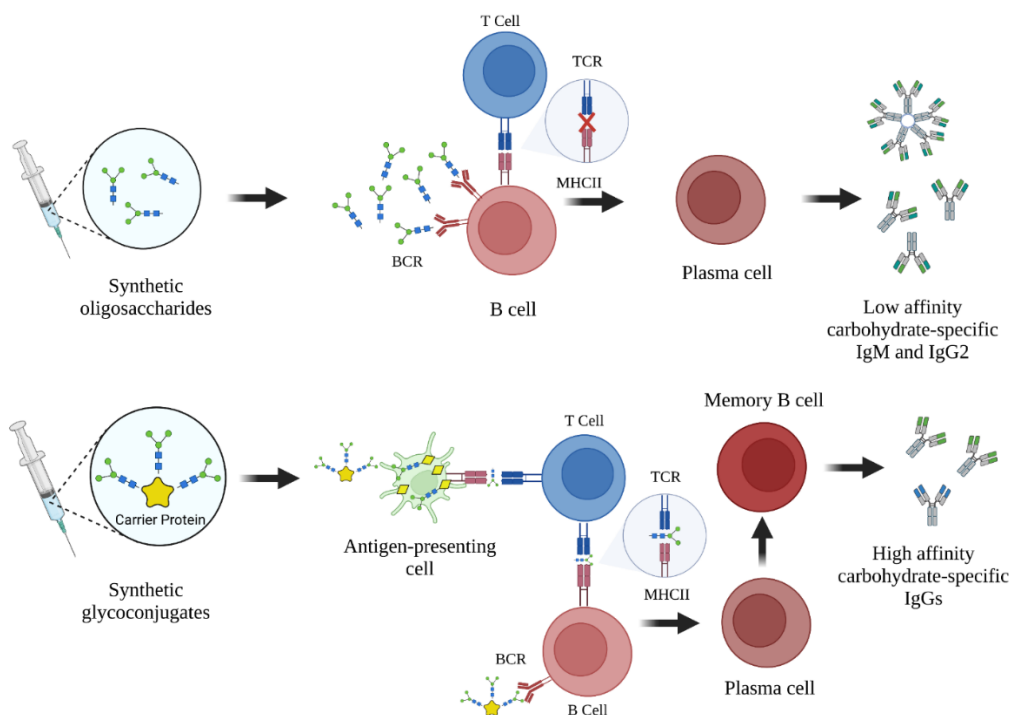
11A, 12F, 14, 15B, 17F, 18C, 19F, 19A, 20, 22F, 23F, and 33F	10A, 11A, 12F, 14, 15B, 17F, 18C, 19F, 19A, 20, 22F, 23F, and 33F
--	--

bloodstream infections in children. The vaccine consists of seven (4, 6B, 9V, 14, 18C, 19F and 23F) of the most common types of pneumococcal bacteria, which are attached to a harmless protein to provoke an immune response. Prevenar™ (PCV7) is administered to children as a series of three doses, typically at two, four, and six months of age, followed by a booster dose at 12-15 months of age (Table 1).<sup>54</sup>

Carbohydrate-based vaccines are attractive to the researchers because they are relatively inexpensive to produce and can be easily stored and transported. Furthermore, they are safe for humans and can be tailored to protect against specific disease-causing organisms.

### 1.3.4 Immunology of glycoconjugate vaccines

Oligosaccharide antigens can activate B-cells independently. This type of B-cell activation is known as T-cell-independent B-cell activation.<sup>55</sup> Examples of T-cell-independent B-cell activation by oligosaccharides include the binding of bacterial lipopolysaccharides to the B-cell surface receptors known as toll-like receptors, as well as the cross-linking of B-cell receptors by polysaccharides (Figure 1.3.2).<sup>54</sup> This type of B-cell activation results in the production of mostly low affinity IgG2 and IgM antibodies.

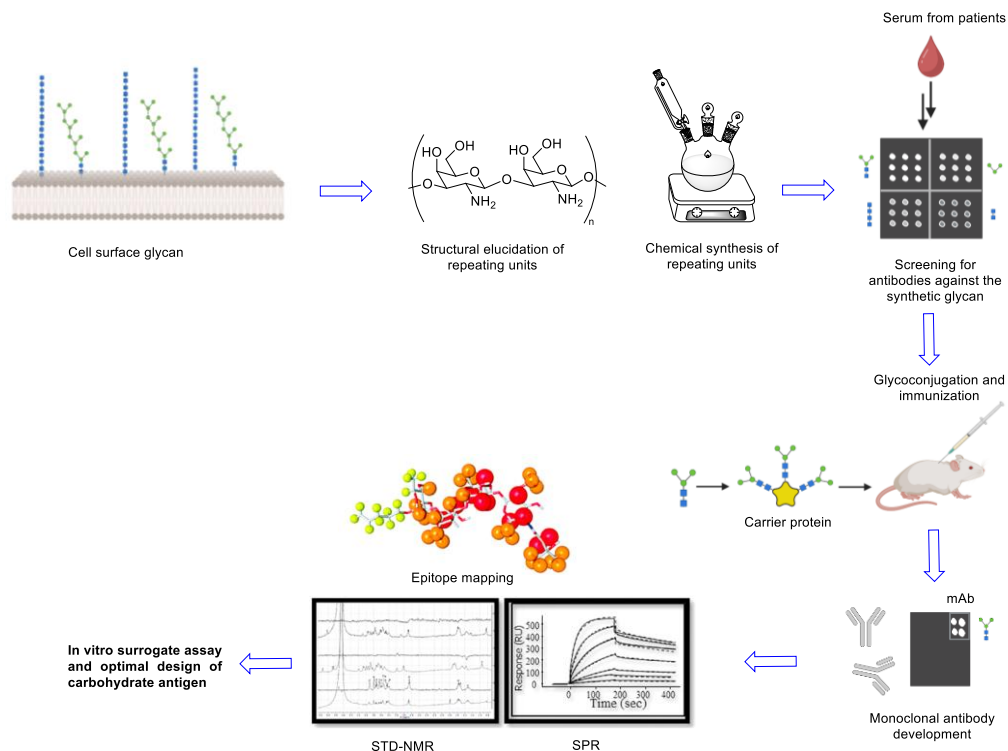


**Figure 1.3.2:** Simplified mechanism for immune response to oligosaccharides and glycoconjugates (Created with BioRender.com)

The capsular polysaccharides that are not protein-conjugated exhibit poor immunogenicity. So at the beginning of the early 1980s, glycoconjugate vaccines were made by combining bacterial polysaccharides with carrier proteins. These glycoconjugates induce T cell-dependent B-cell activation. It is a type of immune response that is activated when T cells recognize an antigen presented to them by antigen-presenting cells (APCs).<sup>56</sup> When an antigen is presented to a T cell, it binds to an antigen receptor on the cell surface and triggers a signaling cascade inside the cell. This results in the secretion of cytokines and other molecules that induce B-cell activation and proliferation. Some B cells differentiate into memory B cells to promote a rapid and efficient immune response in case of re-infection. This type of vaccines are specified to produce high affinity immunoglobulin (IgGs) antibodies.

### 1.3.5 Design of semi-synthetic glycoconjugate vaccine

In theory, any pathogen with distinctive glycans on its surface is a target for developing glycoconjugate<sup>57</sup> vaccines or treatment with monoclonal antibodies. Most Gram-negative bacteria and protozoan parasites have distinctive glycoconjugates on their cell surfaces. The medical requirement and understanding of the cell-surface glycans are crucial factors in choosing a vaccine target. The target should ideally be a cell-surface glycan that is conserved across a wide range of pathogens so that a single vaccine can provide broad protection. Additionally, the target should be associated with a robust immune response to increase the likelihood of a successful vaccine.



**Figure 1.3.3:** Major steps involved in rational design of synthetic carbohydrate vaccines (Created with BioRender.com).<sup>57</sup>

Following the identification of a pathogen as a prospective vaccination target based on a particular medical need, information of the pathogen's cell-surface glycan composition is essential. Various pathogenic bacteria, fungi, and protozoan parasites use CPS, LPS, and other similar structures to cover themselves (Figure 1.3.3). This layer of CPS, LPS, and related structures is known as the capsule or slime layer. The capsule or slime layer protects the pathogenic bacteria, fungi, and protozoan parasites from being attacked by antibodies and other immune cells as well as allowing them to survive in harsh environments. This layer also helps the pathogens to adhere to host tissue and to evade detection by the host's immune system. In addition, the capsule or slime layer can provide nutrients to the pathogen, help them survive in extreme temperatures, and spread the pathogen to other locations. Isolating the cell-surface glycans from cultivated bacteria, followed by chemical degradation and thorough structural elucidation based on physical techniques like NMR spectroscopy, provides information about the structures of CPS, *O*-antigens, or glycolipids.

A number of oligosaccharides antigens can be synthesized by chemical synthesis based on the structure of the CPS repeating unit. Typically, this system includes fragments of various monosaccharide units and one or two complete repeating CPS units. These oligosaccharides are linked at the reducing end by a linker with an amino group on the other end. The stereoselective synthesis of glycosidic linkages is one of the most challenging aspects of glycan synthesis. There are numerous ways to produce glycosidic bonds stereoselectively.

Using glycan microarrays, it is possible to study interactions between proteins that bind to carbohydrates in a high-throughput manner.<sup>58</sup> The study of interactions between mammalian carbohydrates and proteins has received a lot of attention since the development of the first glycan arrays. However, many bacterial carbohydrate arrays have recently been developed, which have provided information on the binding preferences of bacterial carbohydrate-binding proteins.<sup>59</sup> Glycan microarrays have developed into a powerful technique for quick, sensitive, and high-throughput interactions investigations of glycan antigens and antibodies during infections. The surface of the glass slides used for amine-binding microarrays is modified with *N*-hydroxysuccinimide (NHS) esters, which act as nucleophiles to enable covalent attachment to the microarray through amide bonds. The resulting glycan microarray is used to analyze sera and a secondary antibody that has been fluorescently tagged. Careful design of the microarray printing pattern by the inclusion of oligosaccharides with different chain lengths, frame shifts and terminal glycan residues help to deduce meaningful inferences on the epitope of bound antibodies.<sup>57</sup>

The carbohydrate antigen needs to be attached to a carrier since most glycans cannot trigger a T-cell-mediated immunological response. These carrier proteins are extracted after homologous or heterologous expression in bioreactors utilizing bacterial strains that have been well-studied. Cross reacting material (CRM<sub>197</sub>), diphtheria toxin (DT), tetanus toxoid (TT), outer membrane protein (OMP), and protein D of nontypeable *Haemophilus influenzae* (PD) are the five most commonly used proteins in utilizing in licensed glycoconjugate vaccines.<sup>60</sup>

The conjugated glycoprotein can be injected into animal models (often mice or rabbits) for additional immunological testing using aluminum-based adjuvants like  $\text{Al}(\text{OH})_3$ .<sup>61</sup> In order to increase immunity, a second injection of the vaccine candidate is often administered after around two weeks as part of the immunological test. An enzyme-linked immunosorbent test is used to measure the quantity of the matching antibody in blood samples obtained at various times to determine the immunological response (ELISA).<sup>62</sup> Effective vaccine candidates might advance to the development of commercial vaccines or monoclonal antibodies.

## **1.4 Synthesis of oligosaccharides**

Biopolymers are macromolecules that occur naturally in living organisms. Examples of biopolymers include proteins, nucleic acids, and carbohydrates. All these are essential components of living organisms and their functioning.

Oligosaccharides are synthesized using various methods, including solution chemical synthesis, solid phase synthesis, and enzymatic synthesis. Chemical synthesis is the most commonly used method and involves protecting groups to control the reactivity of the sugar moieties and protect them from unwanted side reactions. The sugars are then coupled together using a condensation reaction. Enzymatic synthesis uses glycosyltransferases and glycosylhydrolases to efficiently create oligosaccharides with defined linkages. This method is often used to synthesize glycoproteins and glycoconjugates.

### **1.4.1 Chemical glycosylation reactions**

The most critical step in synthesizing oligosaccharides is the formation of glycosidic bonds by chemical glycosylation. It is a process of covalently linking two monosaccharides (or two oligosaccharides) together by forming a glycosidic bond. This type of bond is formed when the hydroxyl group of the acceptor is reacted with the donor and the glycosylating agent, forming an ether linkage. The glycosidic bond formation is typically catalyzed by acid or base, and the reaction is often carried out in the presence of a protecting group. The product of the glycosidic bond formation is an oligosaccharide, which can be further modified to produce a variety of different types of carbohydrates.

### **1.4.2 Nucleophile**

Typically, monosaccharides/oligosaccharides with one unprotected hydroxyl group serve as nucleophile. To prevent the formation of a mixture of regioisomeric products, it is generally much preferable to work with glycosyl acceptors that only have a single hydroxyl group free. This is true even though the nucleophilicity of hydroxyl groups around a sugar ring does vary slightly depending on their position and orientation. The anomeric position of the glycosyl acceptor should be appropriately protected or functionalized differently from the anomeric position of the glycosyl donor in order to prevent self-reaction and/or polymerization.

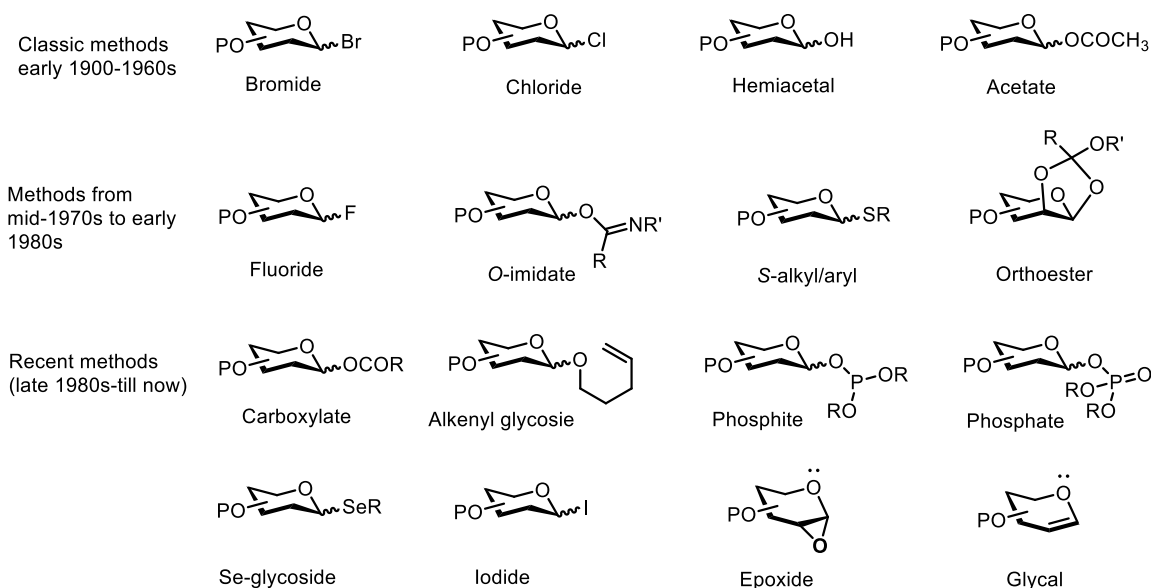


### 1.4.3 Historical development of glycosyl donors

The first reactions performed by Michael (synthesis of aryl glycosides from glycosyl halides) and Fischer (synthesis of alkyl glycosides from hemiacetals) at the end of the nineteenth century showed the complexity of the glycosylation process and the need for a detailed understanding of the fundamental reactivity of glycosyl group.<sup>63</sup> Michael and Fischer's reactions were the first steps in developing the field of glycosylation chemistry. In 1891, German chemists Theodor Koenigs and Ludwig Knorr discovered the first controlled, general glycosylation procedure involving the nucleophilic displacement of chlorine or bromine at the anomeric center. This breakthrough was the first step in what is now known as the Koenigs–Knorr reaction.<sup>64</sup> Koenigs and Knorr's discovery revolutionized the field of carbohydrate science and paved the way for developing new and more efficient glycosylation protocols. The discovery also enabled researchers to create novel glycosides and oligosaccharides with complex branching patterns. The discovery of the nucleophilic displacement of chlorine or bromine at the anomeric center was an early breakthrough in the field of carbohydrate chemistry. However, glycosylation with sugar hydroxyls was poor and sluggish, and the synthesis of simple disaccharides was challenging. Thus, Zemplen and Gerecs, as well as Helferich and Wedemeyer,<sup>65</sup> assumed that complexing the anomeric bromides with more reactive, heavy-metal-based catalysts would significantly improve their leaving-group ability and thus replaced  $\text{Ag}_2\text{CO}_3$  or  $\text{Ag}_2\text{O}$  by more active mercury (II) salt catalysts, such as  $\text{HgCl}_2$  or  $\text{Hg}(\text{OAc})_2$  in the Knorr synthesis. Faster reactions often result in decreased stereoselectivity, and this was the case with mercury salt catalysts. At around the same time, introducing other classes of anomeric leaving groups (LGs) resulted in the investigation of peracetates as glycosyl donors (Figure 1.4.1).<sup>66</sup>

A variety of targets, from simple glycosides to relatively complex oligosaccharides and polymers, have been synthesized for many decades using classic methods, in which anomeric bromides, chlorides, acetates and hemiacetals were used as glycosyl donors. However, these methods have several drawbacks, such as using toxic and expensive reagents. During the 1970s to early 1980s, a few new classes of glycosyl donors were developed that allowed the condensation of glycosyl donors with nucleophiles other than alcohols, such as thiols, amines and phenols. The new glycosyl donors such as thioglycoside,<sup>67</sup> fluoride,<sup>68</sup> *O*-imidates and orthoesters were developed during this period. Many glycosyl donors were introduced in that period, leading to excellent complementary glycosylation methodologies. Arguably, trichloroacetimidates, thioglycosides and fluorides have become the most common glycosyl donors. The end of the 1980s saw the emergence of a new generation of methods, including glycosyl donors such as carboxylate, phosphite, and alkenyl glycosides. These were used as leaving group followed by a variety of new donors such as phosphate, iodide and Se-glycoside.<sup>69</sup>

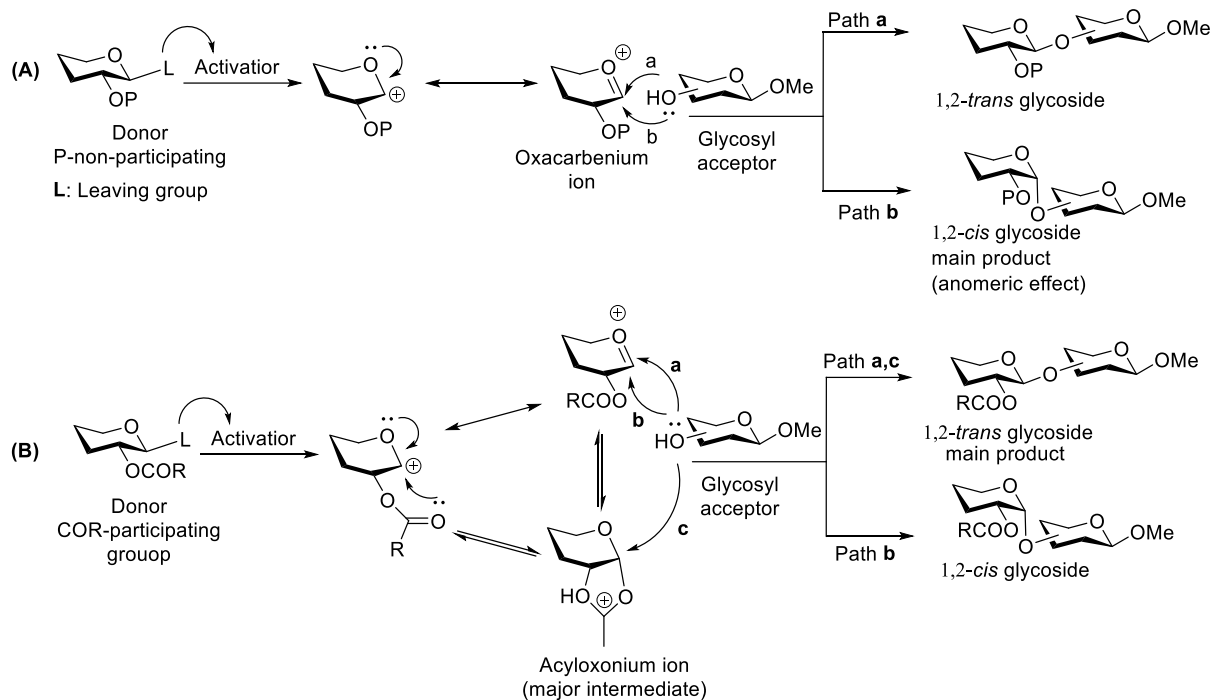




**Figure 1.4.1:** Historical development of glycosyl donors

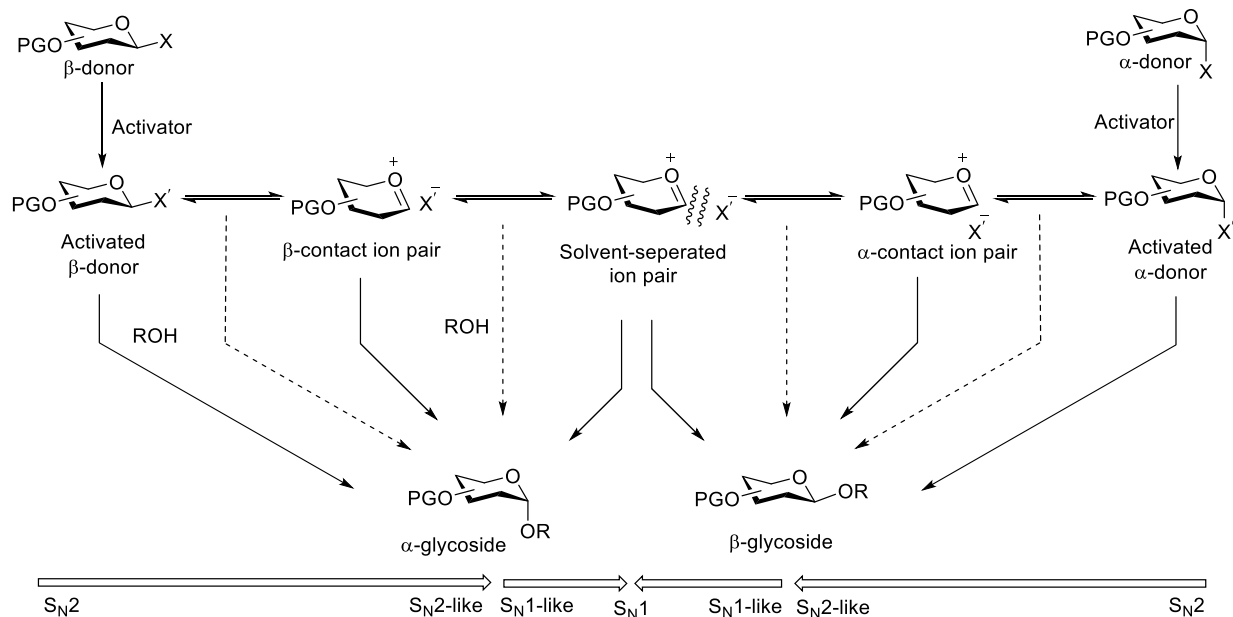
#### 1.4.4 General reaction mechanism

Most frequently, nucleophilic displacement at the anomeric core occurs during the glycosylation reaction. The reaction often follows a unimolecular  $S_N1$  mechanism as it occurs at the secondary carbon atom with the aid of weak nucleophiles (sugar acceptors). In addition to the  $S_N1$  mechanism, there are other pathways for nucleophilic displacement at the anomeric core, including  $S_N2$  pathways. In most cases, an activator (promoter or catalyst) assists the departure of the anomeric leaving group, resulting in the formation of the glycosyl cation intermediate in the glycosylation reaction (Figure 1.4.2).<sup>70</sup> An appropriate nucleophile then attacks the glycosyl cation to form a glycoside bond. The activator may be a Lewis acid, such as boron trifluoride or trimethylsilyl trifluoromethanesulfonate (TMSOTf). The glycosyl donor bearing a non-participating group stabilizes the glycosyl cation by resonance from O-5. The two non-participating groups that are most frequently utilized are benzyl (OBn) for neutral sugars and azide ( $N_3$ ) for 2-amino-2-deoxy sugars, but other non-participating functional groups have also occasionally been used. The nucleophilic attack would be almost equally likely from either the top (*trans*,  $\beta$ - for the D-gluco series) or the bottom face (*cis*,  $\alpha$ - for D-manno series) of the ring since the anomeric carbon of both resonance contributors is  $sp^2$  hybridized. Although the so-called anomeric effect favors the  $\alpha$ -product thermodynamically, a significant quantity of the kinetic  $\beta$ -linked product is frequently obtained due to the irreversible nature of glycosylation of complex aglycones. Temperature, protective groups, conformation, solvent, promoter, steric hindrance, or leaving groups are a few more variables that have an impact on the glycosylation outcome.<sup>66</sup>



**Figure 1.4.2:** General reaction mechanism of glycosylation **A)** Non-participating group at C-2 **B)** Participating group at C-2.

1,2-*trans* glycosidic linkage can be produced stereoselectively with the help of an acyl moiety such as *O*-acetyl (Ac), *O*-benzoyl (Bz), 2-phthalimido (NPhth), and other neighboring participating groups (Figure 1.4.2 b). The acyloxonium ion, a bicyclic intermediate generated by the activator-assisted removal of the leaving group and subsequent intramolecular stabilization of the glycosyl cation, is the main pathway by which these glycosylations occur. In this case, only the top face of the ring is accessible for the attack of a nucleophile (alcohol, glycosyl acceptor), allowing the stereoselective synthesis of a 1,2-*trans* glycoside. When unreactive alcohols are utilized as an acceptor and/or poorly nucleophilic participating substituents are present at C-2, significant amounts of 1,2-*cis*-linked products are formed occasionally.



**Figure 1.4.3:** General mechanism for chemical glycosylation<sup>71</sup>

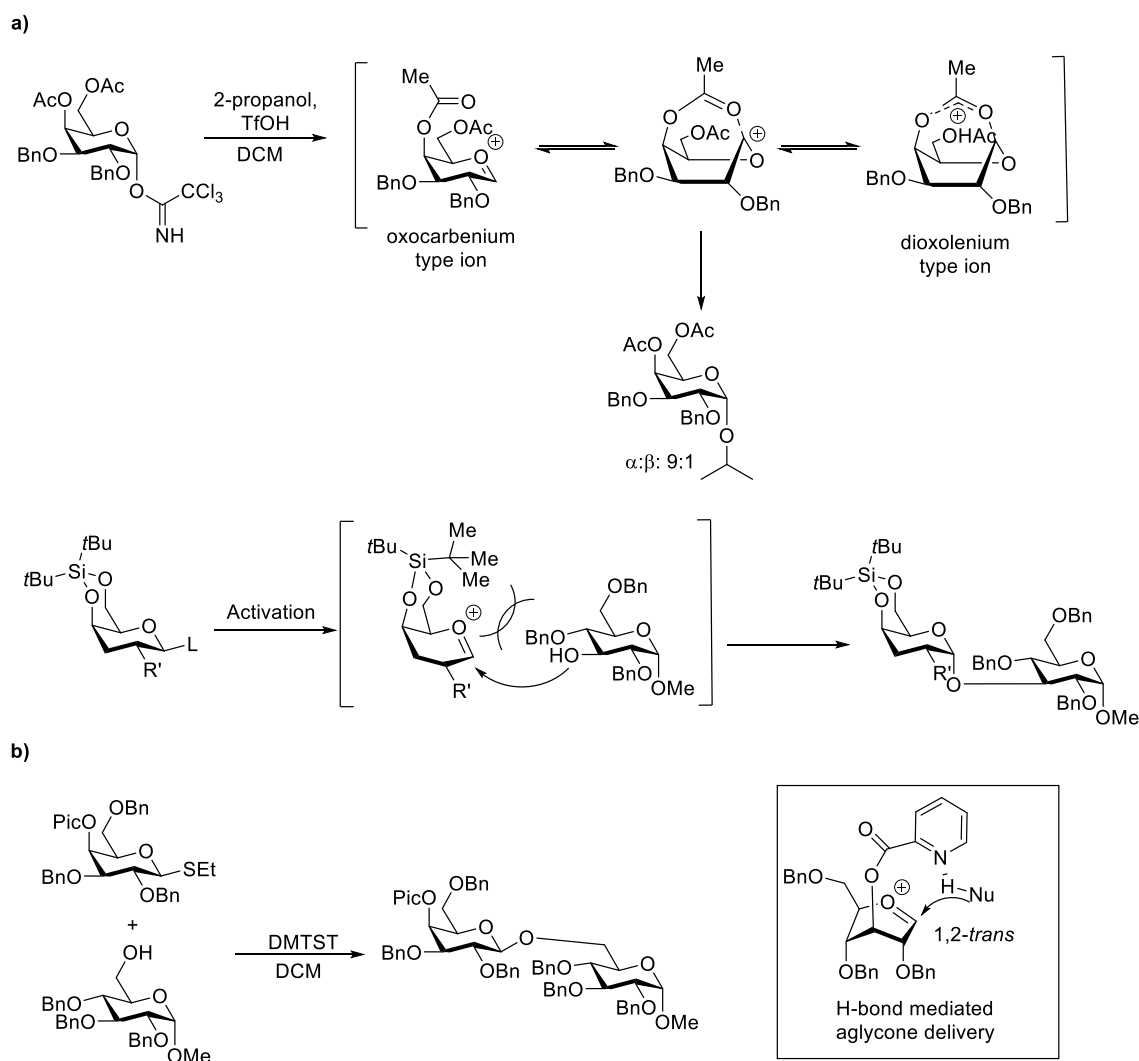
### 1.4.5 Stereoselectivity of glycosylation

In carbohydrate synthesis, the stereoselective synthesis of 1,2-*cis* glycoside linkages is generally more complex than that of 1,2-*trans* glycosides. Neighbouring group participation is highly favourable for the synthesis of 1,2-*trans* glycosides (generation of intermediate acyloxonium ion) and is supported by the presence of a participating substituent at C-2.

The anomeric effect, which favors the synthesis of  $\alpha$ -glycosides, is one of the factors influencing the stereochemical outcome of glycosidation of glycosyl donors containing a nonparticipating substituent at C-2. However, because glycosylation is irreversible, the anomeric effect has less of an impact and other factors that affect the orientation of the new glycosidic bond frequently take center stage.

#### 1.4.5.1 Protecting group

The neighboring group at C-2 has the strongest impact on the stereoselectivity. One of the most effective methods for steering stereoselectivity toward the synthesis of a 1,2-*trans*-linked product is neighboring-group participation.<sup>72</sup> The effects of remote substituents are less significant, although there is convincing evidence that a substituent at the C-4 and C-6 position may significantly affect the stereochemical outcome of glycosylation.<sup>73</sup> Additionally, it was observed that a substituent at C-6 with strong electron-withdrawing abilities or steric bulkiness is favorable for 1,2-*cis* glycosylation (Figure 1.4.4 a).<sup>74</sup> This is probably because it shields (sterically or electronically) the top face of the ring, favoring the nucleophilic attack from the opposite side.



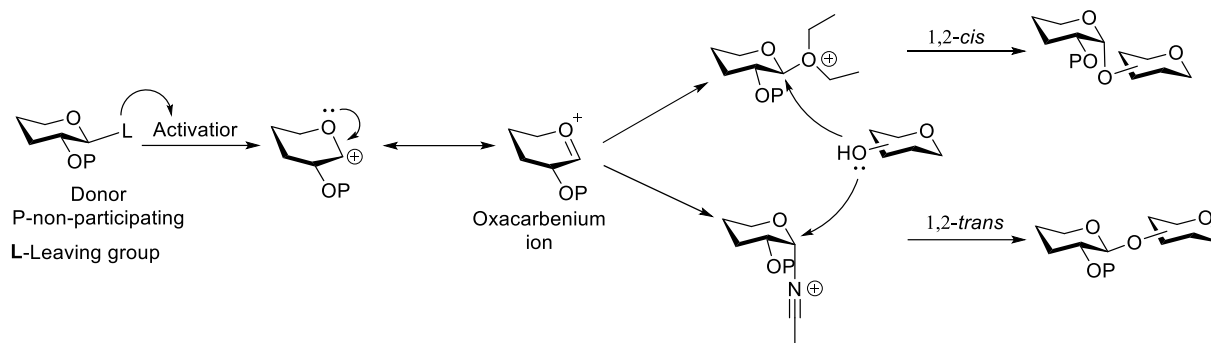
**Figure 1.4.4:** a) Strategies to generate 1,2-*cis* glycosidic bonds b) H-bond mediated aglycan delivery

For remote picolinyl (Pic) and picoloyl (Pico) substituents, a substantially different stereodirecting effect was found. With the incoming glycosyl acceptor, picolinyl nitrogen forms a hydrogen bond.<sup>74</sup> This results in an extremely high facial selectivity that is always syn in relation to the picolinyl substituent.

### 1.4.5.2 Solvent effect

The reaction solvent can significantly influence the stereochemical outcome of the glycosylation reaction. An excellent illustration of this is the stereoselective acetonitrile-mediated synthesis of  $\beta$ -linked disaccharides from glycosyl donors without a participation group at the 2-position (Figure 1.4.5).<sup>75</sup> It is believed that the reaction proceeds via an  $S_N1$  pathway, first generating an intermediate glycosyl cation, which is subsequently coordinated to a solvent molecule to produce

a nitrilium ion. In the example below, trimethylsilyl triflate is used as the Lewis acid activator for the anomeric trichloroacetimidate, which likely forms a glycosyl cation before being trapped by the solvent to form the anomeric ion in an  $S_N2$  reaction with configuration inversion at the anomeric center to produce, almost exclusively, the  $\beta$ -product. Whereas ethereal solvents have been demonstrated to have a capacity to drive glycosylation in an  $\alpha$ -selective manner.<sup>76</sup>

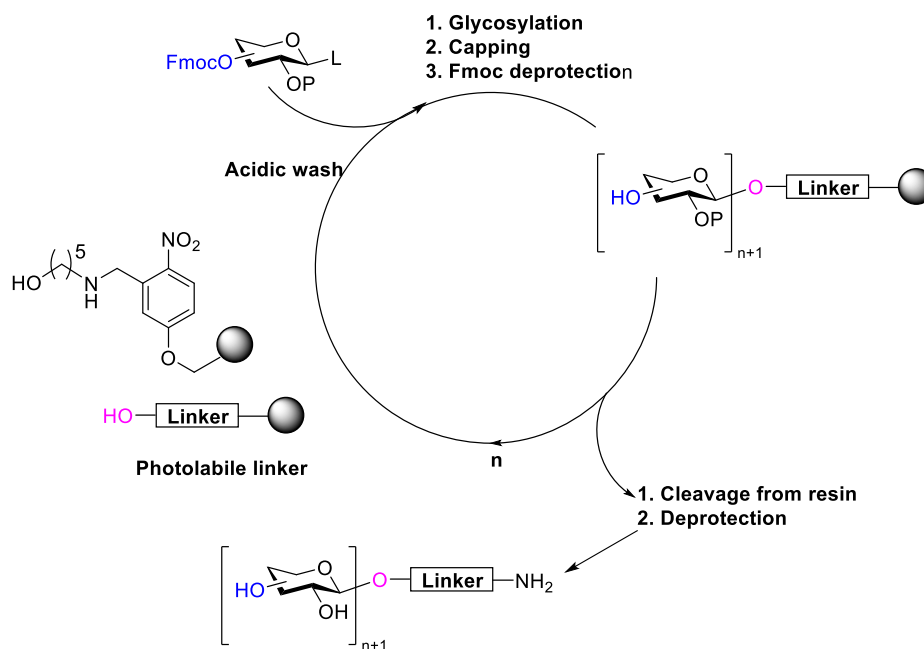


**Figure 1.4.5:** Solvent effect during glycosylation reaction

## 1.5 Automated solid-phase synthesis

Schuerch and colleagues described the first solid-phase glycan synthesis in 1971.<sup>77</sup> Since then, numerous improvements have been made to this procedure. Parallel to this, the automated synthesis of peptides and oligonucleotides experienced considerable success.<sup>78</sup> In 2001, Seeberger et al. published the first fully automated glycan synthesis, marking the first step toward automated solid-phase glycan synthesis.<sup>79</sup> Different linkers and building blocks have been tried and used in the subsequent two decades to improve the synthesis capability.

In solid-phase oligosaccharide synthesis, carbohydrate chains are synthesized on the surface of a solid support made of resin beads. Usually, the resin is functionalized with suitable linkers that provide nucleophilic sites for the formation of chemical bonds with monosaccharides through the glycosylation procedure. The carbohydrate is temporarily protected on one hydroxyl group, just like in peptide synthesis, by a protective group like levulinoyl (Lev) ester. Nucleophilic hydroxyls on resin-bound acceptors are exposed after a step of selective deprotection using a suitable reagent, allowing subsequent glycosylations to attach another monosaccharide unit. An orthogonal protective group, such as Fmoc, is positioned on a particular hydroxyl group of the sugar residue and can be cleaved to provide a site for a second glycosylation if branching along the chain is necessary. Upon completion of the synthesis, chemical treatment of the resin releases necessary fully or semi-protected oligosaccharides from the resin.<sup>80</sup> The target molecule is obtained after the global deprotection of oligosaccharide. Automated synthesizers could perform the whole oligosaccharide assembly from fully protected building blocks, minimizing the need for human intervention.<sup>81</sup>

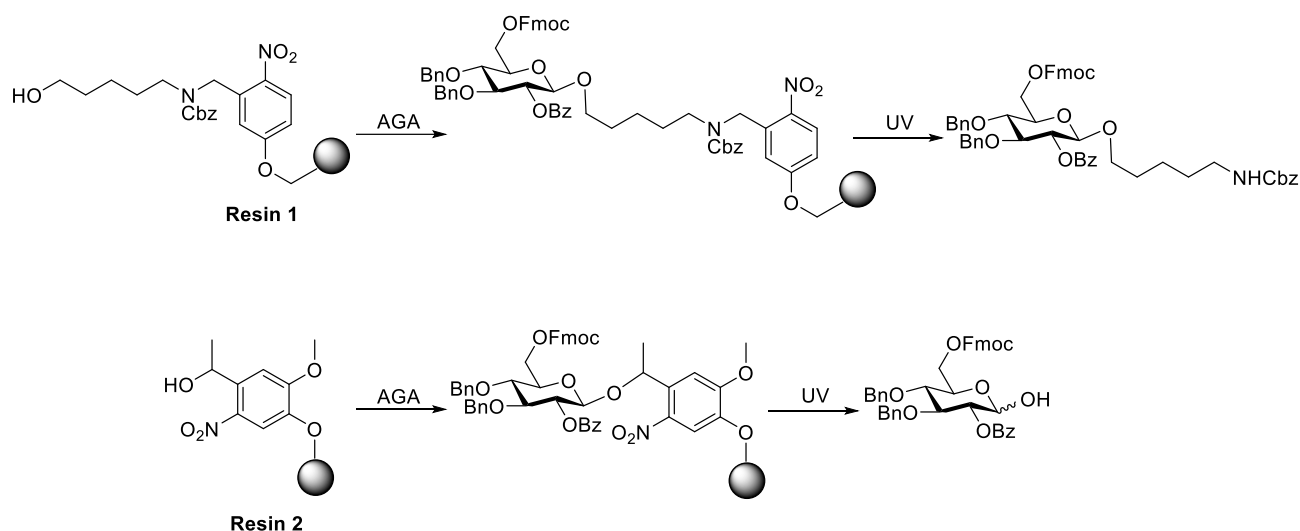


**Figure 1.5.1:** Schematic representation of solid phase oligosaccharides synthesis

Merrifield resin, a polystyrene-divinylbenzene cross-linked polymer, is frequently used for automated glycan assembly (AGA) because it is insoluble, inert in all reaction conditions, and capable of swelling in the majority of organic solvents.<sup>82</sup>

Several linkers have been used, but the photocleavable,<sup>83</sup> metathesis-labile,<sup>84</sup> and base-labile<sup>85</sup> linkers are the most useful for AGA. The photolabile linker has found most applications. This linker allows for the selective release of glycan molecules from solid support when exposed to light. This type of linker is typically a short chain that bears a photocleavable group, such as a photoreactive group, which can be cleaved by light. The most commonly used photocleavable linkers are based on nitrobenzyl alcohols. These linkers are effective in the synthesis of a wide range of glycans, including glycoproteins and glycolipids.

There are now two popular types of photocleavable linkers in use. Resin 1 releases the glycan, which has an aminoalkyl spacer at the reducing end, allowing it to be attached to a protein or microarray later. Linker 2 furnishes the free reducing end glycan after photocleavage.<sup>86</sup>



**Figure 1.5.2:** Photolabile linker used in AGA

The main advantage of solid-phase glycan synthesis is that it is a reliable and efficient approach to synthesize a variety of glycans. It is also a cost-effective method as fewer reagents and solvents are required for purification. Furthermore, the reaction is highly selective, allowing for synthesizing complex and diverse glycans. Additionally, the solid phase approach allows for the efficient isolation and purification of the desired glycan, simplifying downstream processing.

## 1.6 Aim of the thesis

This thesis aims to contribute to the development of new glycoconjugate vaccines against emerging pathogens such as *S. suis* (Bacteria) and *C. auris* (Fungi) with the help of synthetic organic chemistry. To develop a novel glycoconjugate vaccine against *S. suis* serotype 18, libraries of compounds related to capsular polysaccharides of pathogenic bacteria were synthesized. They will be used in a glycan array experiment to find the minimal epitope. The oligosaccharide, identified as a minimal epitope from the previous experiment, will be conjugated with carrier proteins such as CRM<sub>197</sub>. The resulting glycoconjugates will be used to study immunogenic properties in animal models. Chapter 3 of this thesis describes the development of a method to synthesize phosphodiester linkages on the solid support, and using this method, oligosaccharides resembling *C. auris* were synthesized using AGA. In addition to this, *C. auris* KCTC 17810 mannan was synthesized. These vaccine candidates are ready for glycan array study, conjugation with carrier protein and further immunological studies.

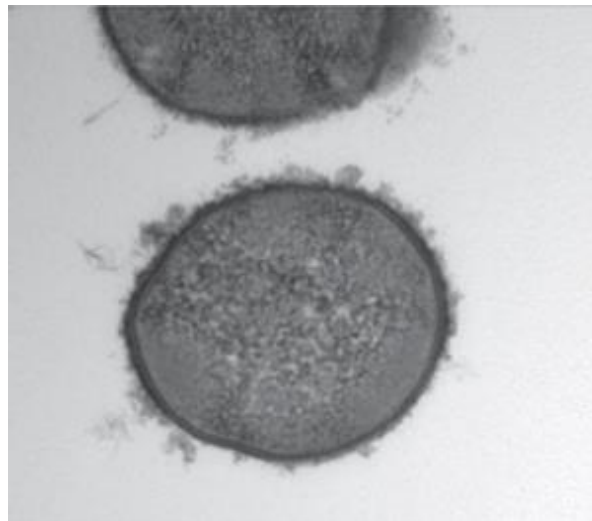
## Chapter 2

### Synthesis of Oligosaccharides Resembling the *Streptococcus suis* Serotype 18 Capsular Polysaccharide as a Basis for Glycoconjugate Vaccine Development

Part of this chapter has been modified from: Singh R. K.; Sianturi, J.; Seeberger, P. H. Synthesis of Oligosaccharides Resembling the *Streptococcus suis* Serotype 18 Capsular Polysaccharide as a Basis for Glycoconjugate Vaccine Development. *Org. Lett.* **2022**, *24*, 2371–2375.

#### 2.1 Introduction:

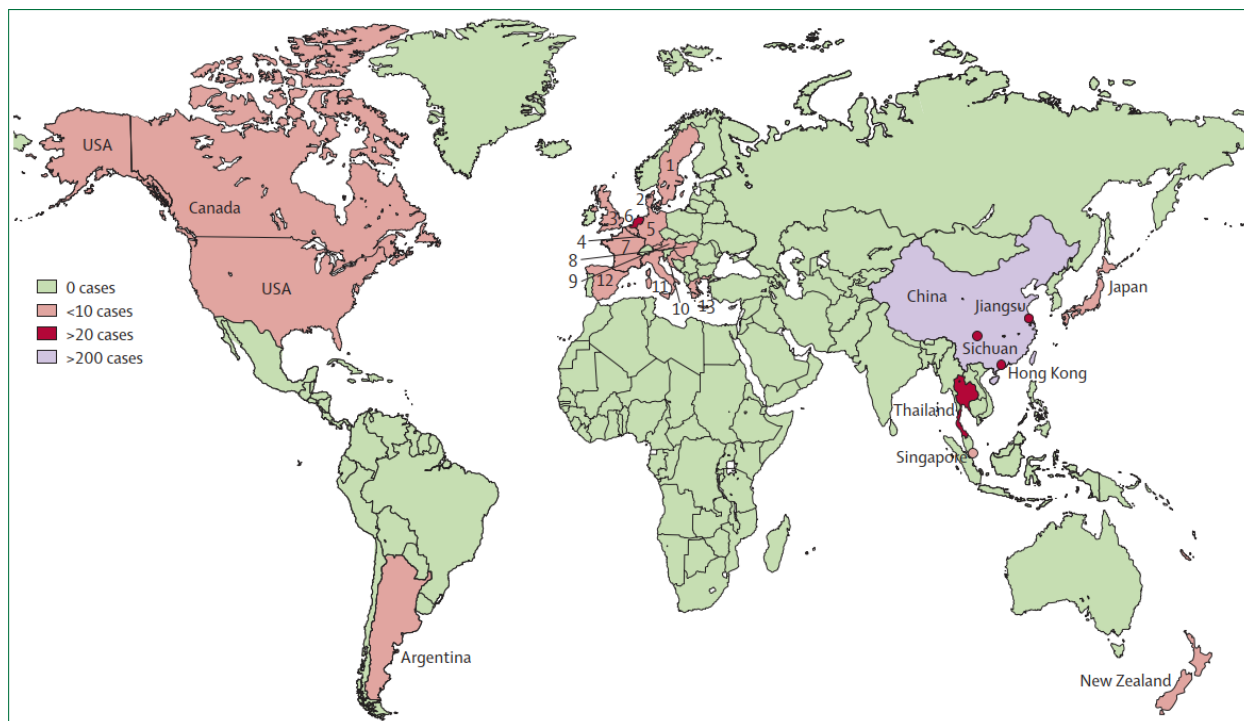
*Streptococcus suis* (*S. suis*) is a Gram-positive, peanut-shaped, facultative anaerobe bacterium<sup>87</sup> and an important pig pathogen (Figure 2.1).<sup>88</sup> It was isolated from pigs during an outbreak in the Netherlands in 1954. Since then, it has been found in pigs in countries across<sup>89</sup> Asia, Europe, the Americas, and Africa (Figure 2.2).<sup>90</sup> Almost all the swine herds have asymptomatic carriers, and morbidity due to infection with *S. suis* can be in the range of <1% to >50%.<sup>91</sup> Around 35 serotypes<sup>92</sup> of *S. suis* are known, and only a limited number are responsible for infections in the pig.<sup>93</sup> In pigs, *S. suis* can be transmitted nasally, orally or via vaginal secretions during parturition. In some countries, such as the United States, losses due to *S. suis* have been estimated to be millions of dollars. In other countries, such as China, losses due to *S. suis* have been estimated to be billions of dollars. Besides pigs, *S. suis* can be isolated from other animals, such as cats, dogs, and deer.<sup>94</sup>



**Figure 2.1:** Transmission electron micrograph of *S. suis* isolate (Reprinted from: *JMM Case Rep.* **2014**, *1*, 1–4)



It is a zoonotic infection, meaning it can spread between animals and humans.<sup>95</sup> The first case of human infection was reported in 1968 in the Netherlands.<sup>9</sup> Until 1983 human infection was reported only in Europe, but since 1968 many patients with meningitis and septicemia due to *S. suis* have been reported in Hong Kong and Canada. Humans can become infected through contact with infected pigs or by consuming contaminated pork or pork products. Common symptoms of *S. suis* infection include fever, headache, sore throat, nausea, vomiting, joint pain, rash, and abdominal pain.<sup>96</sup> In more severe cases, meningitis, encephalitis, and sepsis can occur. Treatment typically involves antibiotics and, in some cases, hospitalization or intensive care.<sup>97</sup>



**Figure 2.2:** Countries or region where *S. suis* human infection cases have been reported. (Reprinted from: *Lancet Infect. Dis.* 2007, 7, 201–209)

The cell wall of *S. suis* is composed of a peptidoglycan layer which is surrounded by a polysaccharide capsule.<sup>98</sup> The capsule is composed of polysaccharides<sup>99</sup> and other components, including lipids and proteins. The peptidoglycan layer comprises a mesh of polysaccharide strands and peptides cross-linked by peptide bridges. This layer serves as a physical barrier to protect the cell from its environment and plays a role in the cell’s ability to adhere to other cells and surfaces. Various potential virulence factors of *S. suis* have been discovered, including the capsular polysaccharide, extracellular protein factor, muramidase-released protein, suilysin, several adhesins and hyaluronate lyase. Animal models of infection have indicated that none of these, except for the capsular polysaccharide, are essential for virulence.

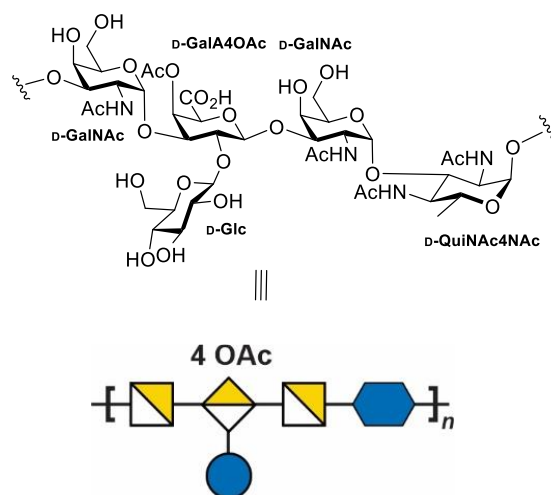
In clinical contexts, antibiotics are primarily used to prevent and treat developing zoonotic *S. suis* infections.<sup>9</sup> However, in many endemic nations, continuous antibiotic usage is now a serious problem<sup>100</sup> since it promotes the growth and spread of antibiotic-resistant *S. suis*. Numerous studies have shown that using different bacterial and viral vaccinations in animal populations might result in a sizable decrease in antibiotic usage. They would help reduce the spread of pathogens from animals to humans. All currently available antibacterial veterinary vaccinations are made from live, attenuated, or inactivated bacteria, which have disadvantages in terms of stability, immunogenicity, and sometimes safety. Veterinary glycoconjugate<sup>101</sup> vaccines are currently a relatively untapped market, despite the fact that human glycoconjugate vaccinations<sup>97</sup> are highly effective.

The most critical step in the development of semi-synthetic glycoconjugate vaccines is the identification of the immunogenic epitope. Using synthetic antigen candidates based on CPS to study the glycan epitope's structural details is important. Branching, the terminal sugar moiety, overall sequence, and length are structural factors that must be considered since they may impact the antigen's activity or stability. The first synthesis of a group of oligosaccharides related to the natural *S. suis* serotype 18 CPS repeating unit is presented in this chapter as the foundation for further immunological studies.

## 2.2 Results and discussion

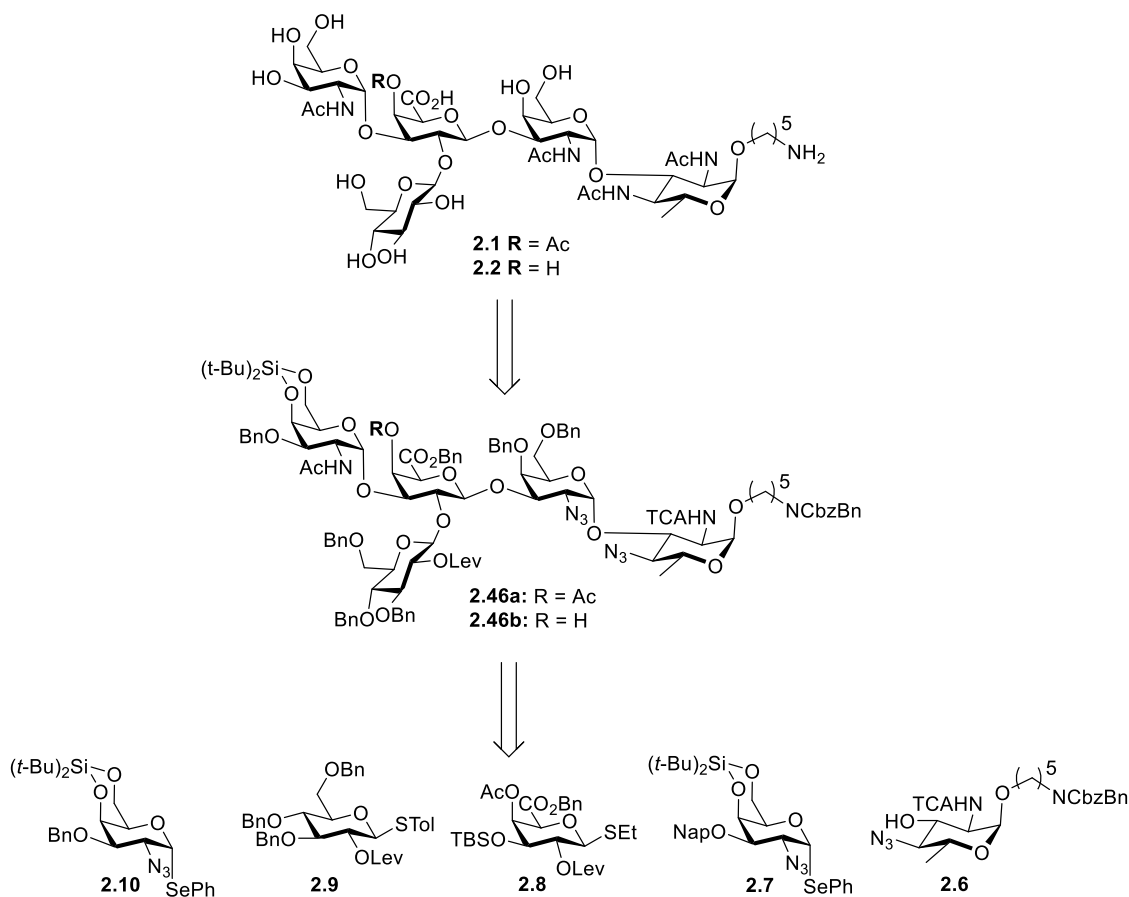
### 2.2.1 Synthetic strategy

The *S. suis* serotype 18 CPS pentasaccharide repeating units (Figure 2.3) was first reported in 2018 by Segura's group with repeating unit made up of  $[\rightarrow 3)\text{-D-GalNAc}(\alpha 1\text{-}3)[\text{D-Glc-}(\beta 1\text{-}2)]\text{D-GalA}4\text{OAc}(\beta 1\text{-}3)\text{-D-GalNAc}(\alpha 1\text{-}3)\text{-D-BacNAc}4\text{NAc}(\alpha 1\text{-}\rightarrow)]_n$  (Figure 2.3).<sup>102</sup> The repeating unit consists of a branched pentasaccharide unit contains core D-galacturonic acid linked to D-galactosamine at C3 and D-glucose at the C2 position. At the anomeric position of core D-galacturonic acid is a disaccharide consisting of D-galactosamine linked to C3 of rare deoxy amino sugar D-bacillosamine.



**Figure 2.3:** Repeating unit of the *S. suis* serotype 18 CPS.

The structure of target pentasaccharide contains the rare deoxy amino sugar D-bacillosamine in addition to D-galactosamine, D-galacturonic acid, D-glucose and D-galactose. The major challenges involved in the synthesis of structurally complex and conjugation-ready pentasaccharides are the efficient synthesis of orthogonally protected rare deoxy amino sugar building block (D-bacillosamine), synthesis of D-galacturonic acid and the stereo-controlled installation of 1,2-*cis*-glycosidic linkages between D-galactosamine and rare sugar units to obtain the disaccharide. The presence of C4-OAc at the D-galacturonic acid of pentasaccharide **2.1** complicates the synthesis by not allowing the use of most ester protecting groups. An aminopentyl linker must be attached to the target molecules in order to conjugate or immobilize them. Deprotection is more difficult due to the densely functionalized target molecules having four protected nitrogen groups.



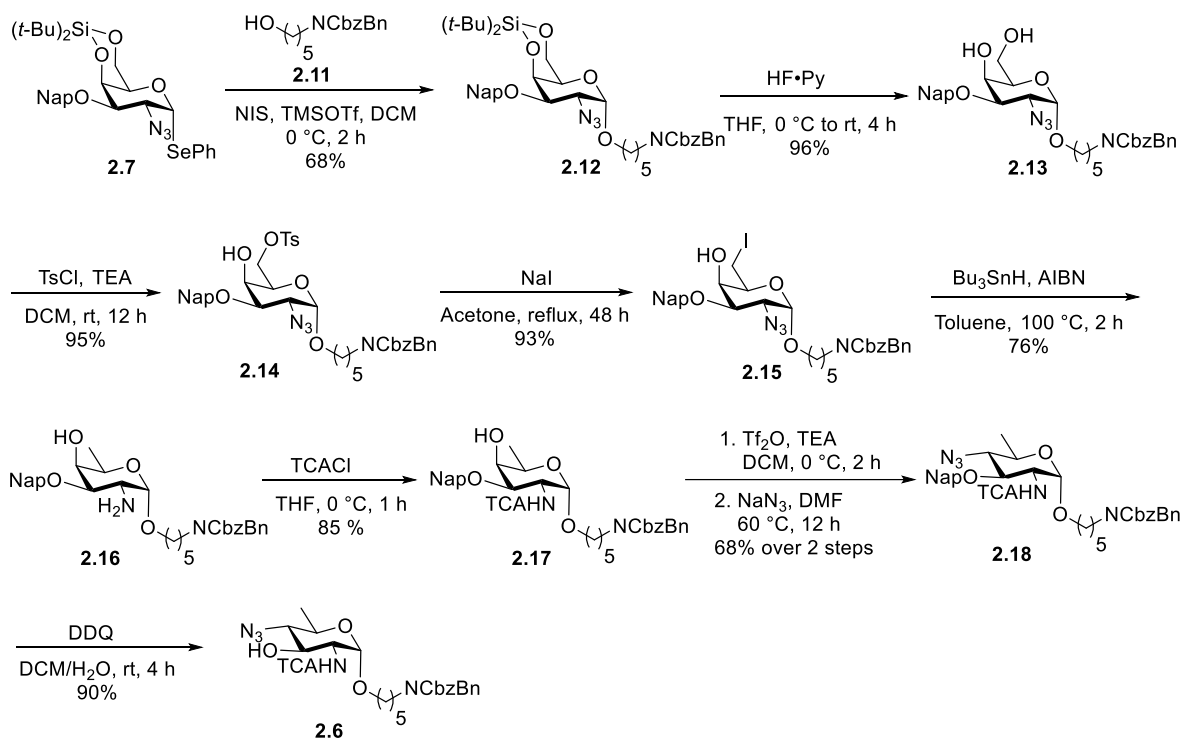
**Scheme 2.1:** Retrosynthetic analysis of pentasaccharide **2.1** and **2.2**.

Retrosynthetically (Scheme 2.1), target molecule **2.1** can be obtained from fully protected pentasaccharide **2.46a** by functional group interconversions (FGI) and global deprotection. Glycosylations of five differently protected monosaccharide building blocks would provide the protected pentasaccharide **2.46a**. The silyl group serve as a temporary protecting group, Benzyl ethers as permanent protecting groups, while the trichloroacetyl group (TCA) and levulinoyl ester (Lev) ensure neighboring participation as C2 protective groups to construct 1,2-*trans* linkages.

### 2.2.2 Synthesis of orthogonally protected building blocks

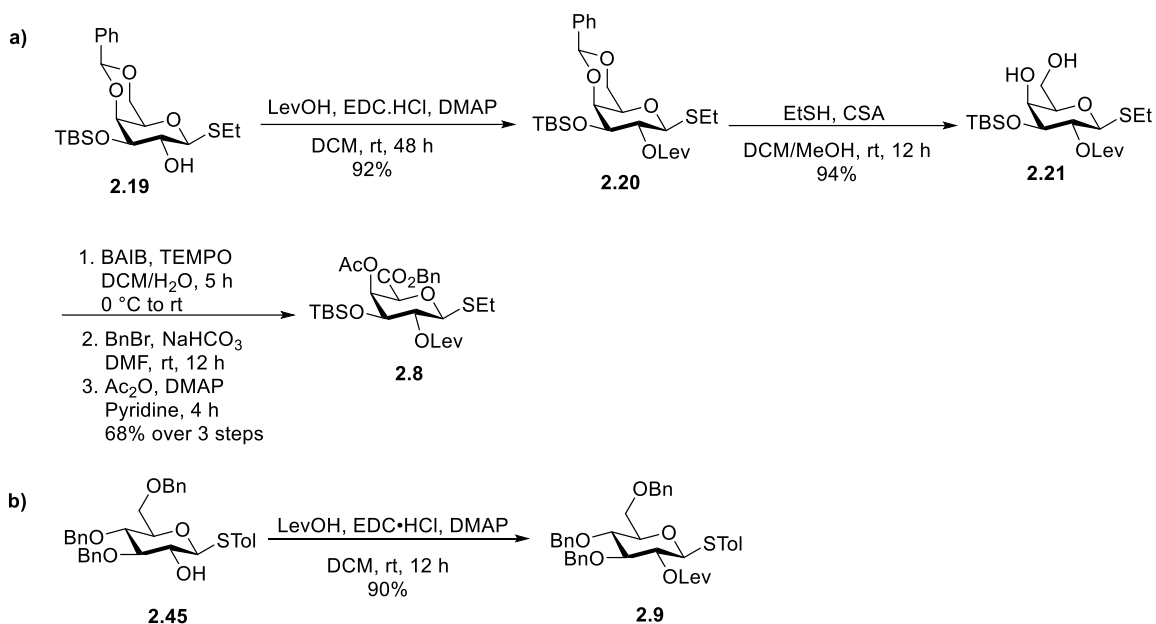
D-Bacillosamine **2.6** (Scheme 2.2) was synthesized starting from D-galactosamine building block<sup>103</sup> **2.7** and used to glycosylate the protected reducing end linker **2.11** using NIS/TMSOTf as a promoter to afford exclusively  $\alpha$ -linked glycoside **2.12** in 68% yield.<sup>104</sup> The bulky alkyl substituents of the 4,6-*O*-silylidene group prevent attack of the nucleophile from the  $\beta$ -face of the donor, combined with a through-space electron donation that stabilizes the oxocarbenium-like intermediate<sup>105</sup> ensured complete stereoselectivity of the glycosylation. Silylidene removal using HF in pyridine<sup>106</sup> yielded dihydroxy galactosamine derivative **2.13** (96%), followed by tosylation

of the primary C6 hydroxyl<sup>107</sup> to give **2.14** in 95% yield. C6-Deoxygenation was achieved via iodination with NaI in refluxing acetone (93% yield of **2.15**), and subsequent dehalogenation/reduction with tributyltin hydride yielded fucosamine<sup>108</sup> derivative **2.16** (76%). Selective acylation of the amine in **2.16** using trichloroacetyl chloride<sup>109</sup> afforded **2.17** in 85% yield. Triflation of **2.17** using triflic anhydride, followed by C4-inversion with stoichiometric amounts of sodium azide provided D-bacillosamine<sup>110</sup> **2.18** in 68% yield. Oxidative cleavage of the naphthyl ether (Nap) by DDQ afforded D-bacillosamine<sup>111</sup> building block **2.6** in 90% yield.



**Scheme 2.2.** Synthesis of D-bacillosamine acceptor **2.6**

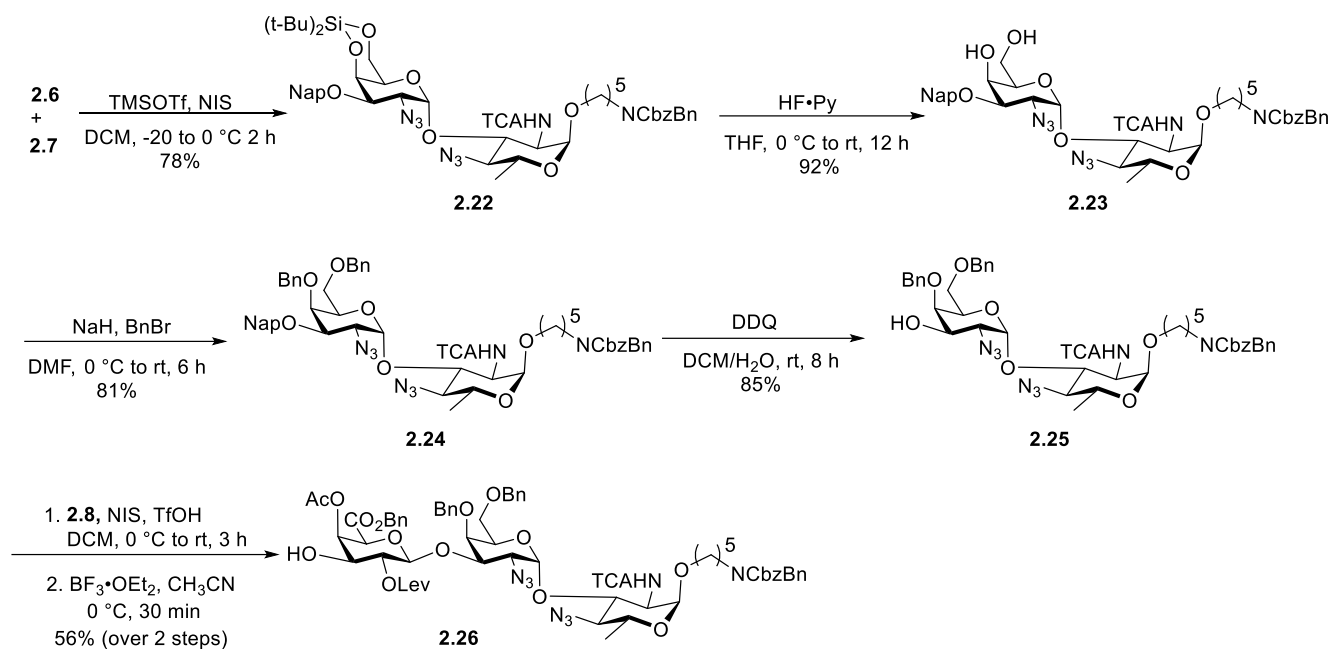
Galacturonic acid building block **2.8** was prepared from differentially protected galactose thioglycoside **2.19** (Scheme 2.3).<sup>112</sup> Levulinoylation, followed by benzylidene acetal hydrolysis<sup>113</sup> gave dihydroxy galactose thioglycoside **2.21**. Selective oxidation of the primary C6 alcohol to the carboxylic acid<sup>114</sup> using TEMPO and subsequent benzylation followed by acetylation gave rise to D-galacturonic acid thioglycoside **2.8** in 68% yield over three steps. Glucose building block **2.9** was synthesized in one step from a known **2.45**.<sup>115</sup>



**Scheme 2.3 a)** Synthesis of differentially protected galacturonic acid building block **2.8** **b)** Synthesis of glucose building block **2.9**

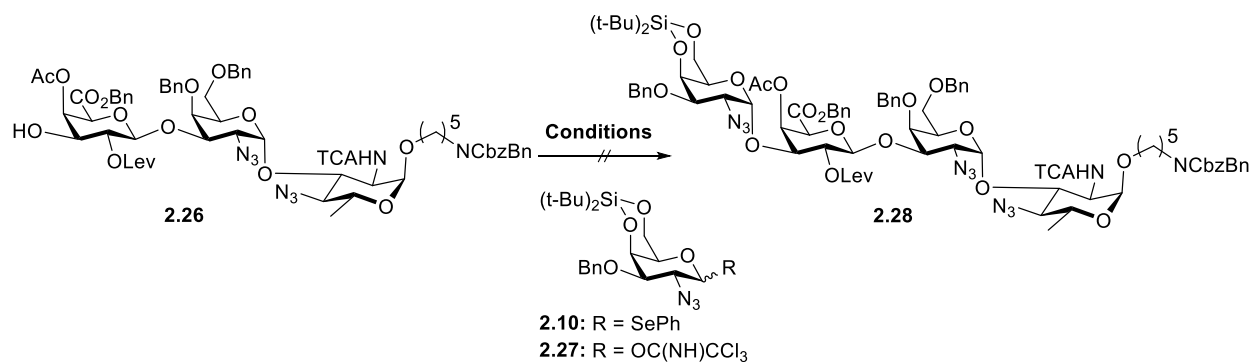
### 2.2.3 Synthesis of oligosaccharides 2.1 and 2.2

Oligosaccharide assembly commenced with the NIS/TMSOTf promoted union of D-bacillosamine derivative **2.6** and D-galactosamine **2.7**. Removal of the silylidene group by treatment with HF•Py, followed by benzylation gave differentially protected disaccharide **2.24** (Scheme 2.4). Oxidative removal of the naphthyl ether using DDQ furnished disaccharide acceptor **2.25** in 85% yield. Glycosylation of disaccharide **2.25** using galacturonic acid **2.8** afforded the protected trisaccharide. The subsequent cleavage of the silyl ether using HF•Py proved difficult and furnished a complex mixture of products. Desilylation using BF<sub>3</sub>•OEt<sub>2</sub> was successful and produced the desired acceptor **2.26** in 56% yield<sup>116</sup> over two steps (Scheme 2.4). Several attempts to synthesize tetrasaccharide **2.28** by glycosylation of trisaccharide acceptor **2.26** using selenoglycoside **2.10** and the corresponding trichloroacetimidate **2.27** did not meet with success. The poor nucleophilicity of free hydroxyl group of **2.26** is a result of the electron withdrawing groups at C4 and C6 and rendered glycosylations doomed to failure (Table 2.1).

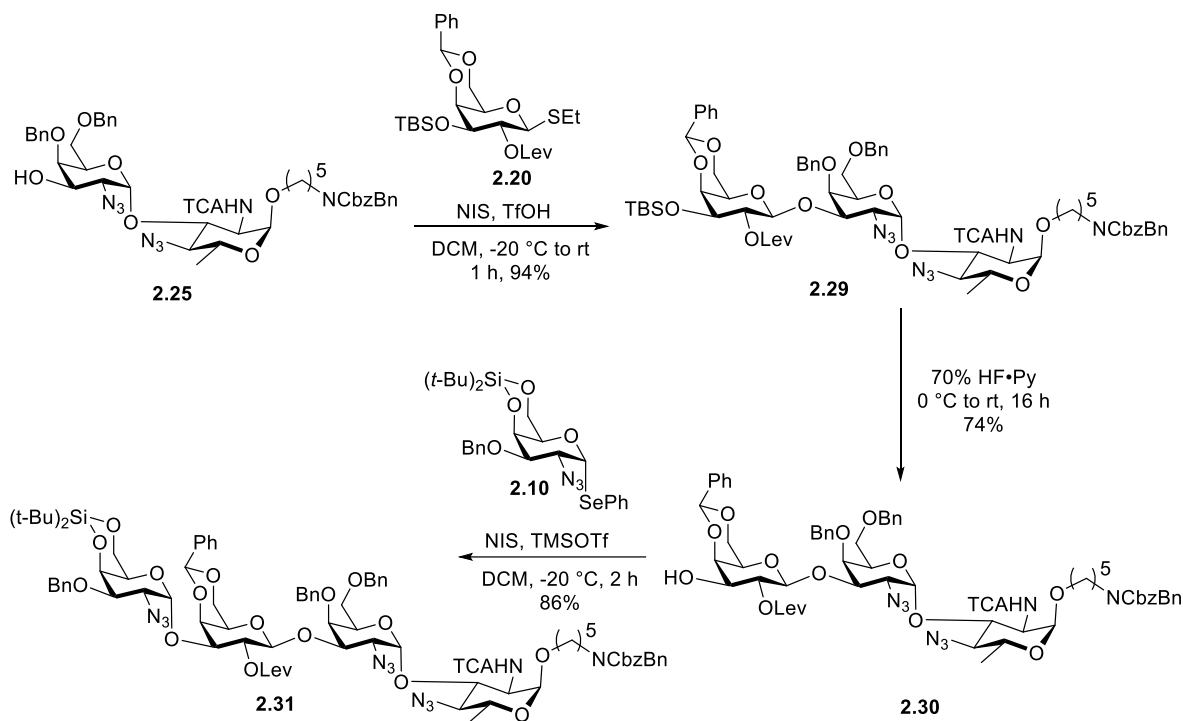


**Scheme 2.4.** Synthesis of trisaccharide **2.26**

**Table 2.1:** Glycosylation conditions to synthesize tetrasaccharide **2.28**



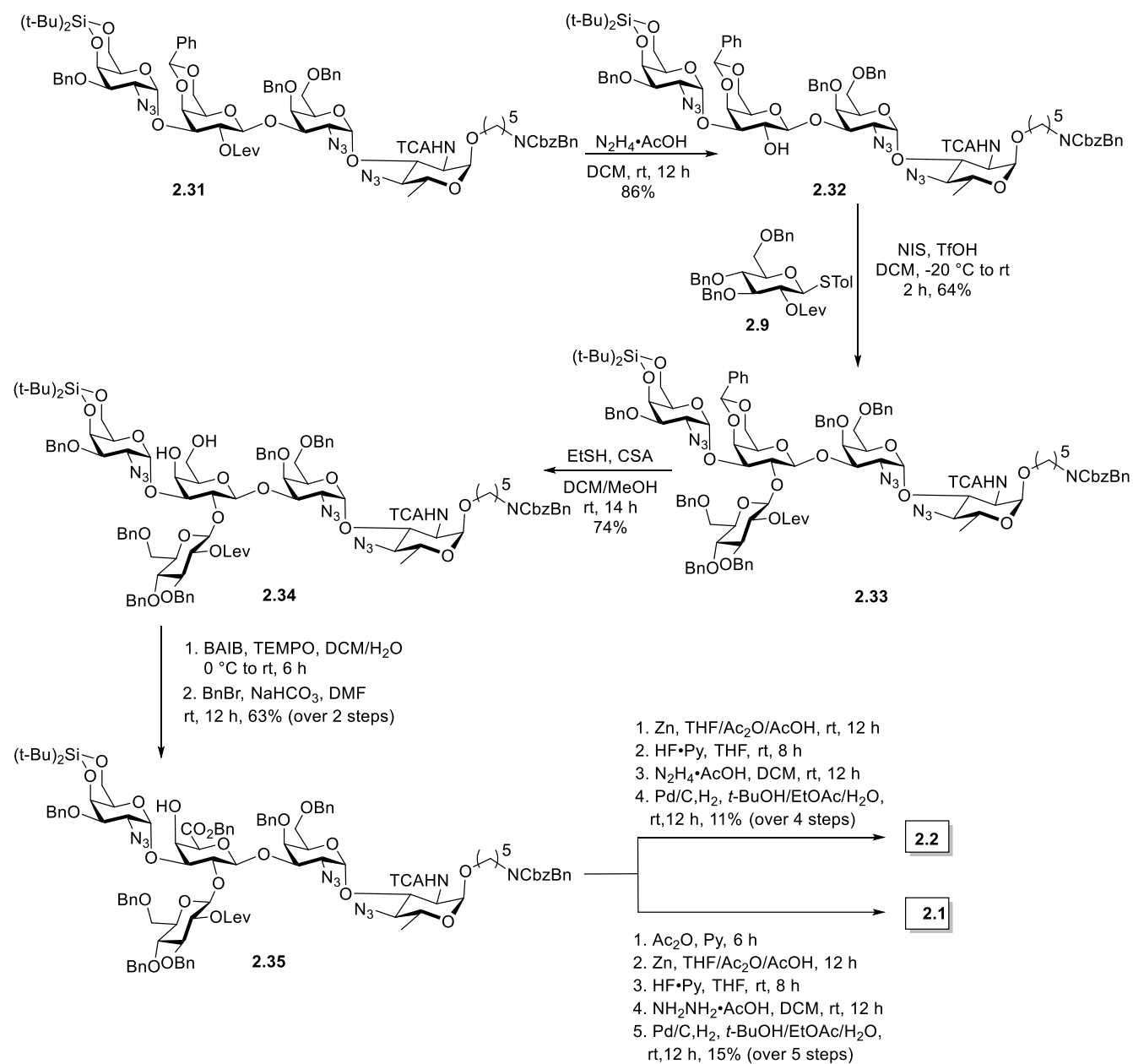
Entry	Donor	Promotor	Temperature	Yield (%)
1	2.10	NIS/TfOH	-20 to 0 °C	—
2	2.10	NIS/TfOH	0 °C	—
3	2.10	NIS/TMSOTf	0 °C	—
4	2.27	TMSOTf	0 °C	—



**Scheme 2.5:** Synthesis of tetrasaccharide **2.31**

In order to overcome the reactivity problems associated with the low nucleophilicity of the central galacturonic acid unit, a less direct method using galactose in place of galacturonic acid had to be explored. Glycosylation of disaccharide **2.25** with galactose building block **2.20** afforded trisaccharide **2.29** in 94% yield that was liberated from the silyl ether protective group to furnish trisaccharide acceptor **2.30**. Glycosylation of trisaccharide acceptor **2.30** with selenoglycoside donor **2.10** provided tetrasaccharide **2.31** (Scheme 2.5). Levulinoyl ester in **2.31** was cleaved using hydrazine acetate followed by glycosylation with glucosamine building block **2.9** produced pentasaccharide **2.33** in 64% yield. The central galacturonic acid moiety was prepared by CSA-mediated hydrolysis of the benzylidene acetal followed by BAIB/TEMPO oxidation and selective benzylation of carboxylic acid afford pentasaccharide **2.35**. The azide of pentasaccharide **2.35** was converted into the corresponding acetamide using zinc powder in a THF/Ac<sub>2</sub>O/AcOH mixture, and subsequently silylidene ether, levulinoyl ester group was deprotected and hydrogenation reaction provided *S. suis* serotype 18 CPS resembling repeating unit pentasaccharide target **2.2** in 11% yield over four steps. In addition, pentasaccharide **2.35** was acetylated followed by azide conversion to acetamide, subsequent removal of silylidene, levulinoyl ester and hydrogenation reaction provided *S. suis* serotype 18 CPS repeating unit pentasaccharide target **2.1** in 15% yield over five steps (Scheme 2.6).



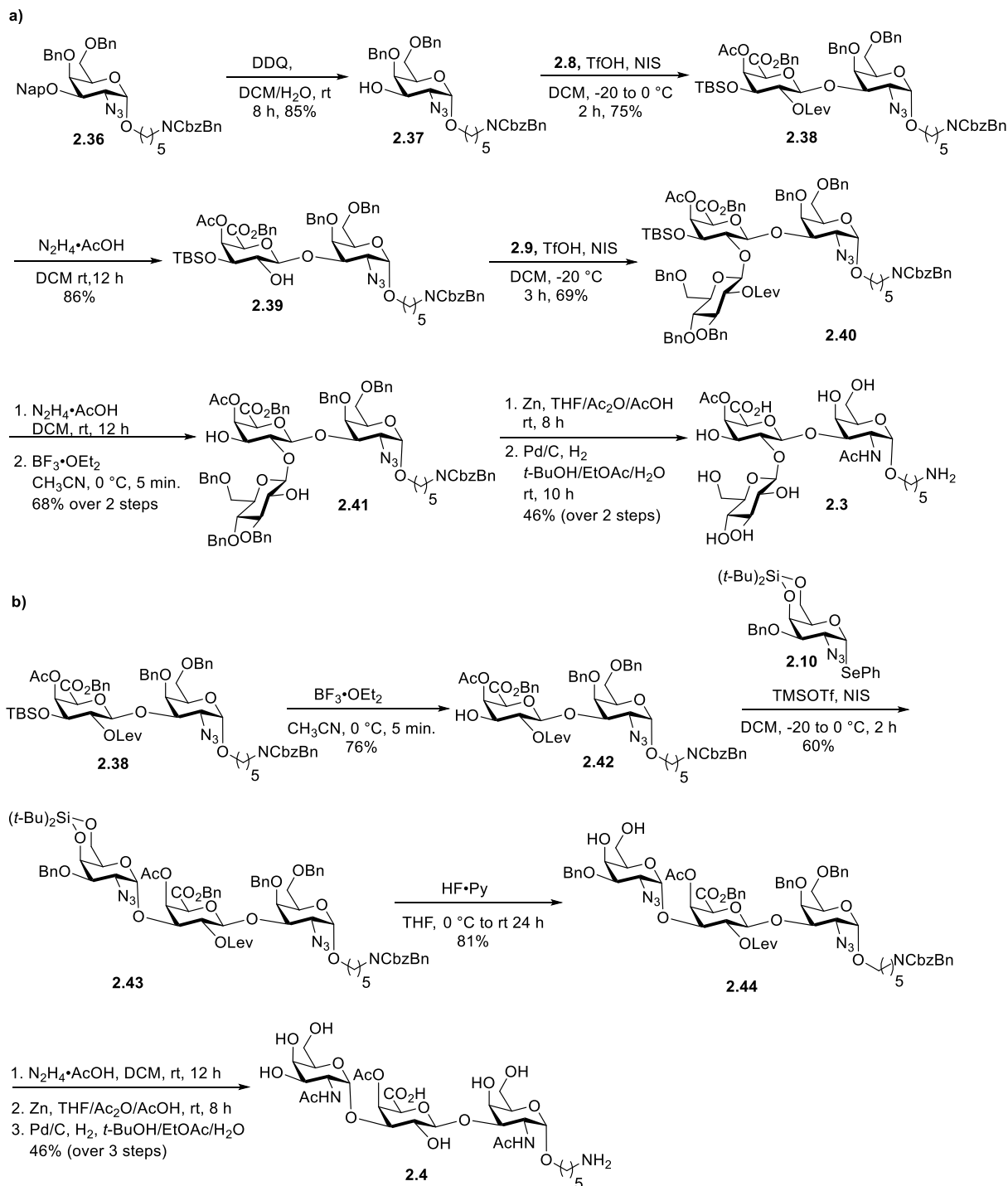


**Scheme 2.6:** Synthesis of pentasaccharide **2.1** and **2.2**

### 2.2.4 Synthesis of oligosaccharides **2.3**, **2.4** and **2.5**

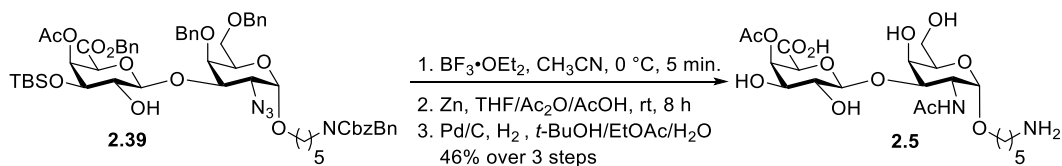
Three oligosaccharides (**2.3**, **2.4** and **2.5**) that are essential for subsequent immunological studies to identify the minimally protective glycan epitope were prepared using a divergent synthesis approach (Scheme 2.7). Benzoylation of galactosamine diol **2.13** afforded **2.36** (see supporting information) that was freed from the Nap ether to provide **2.37**. Glycosylation of monosaccharide **2.37** with galacturonic acid building block **2.8** furnished exclusively the  $\beta$ -isomer of disaccharide **2.38** in 75% yield. Levulinoyl ester cleavage using hydrazine acetate afforded **2.39** and then

glycosylation with **2.9** in the presence of TfOH and NIS at  $-20\text{ }^{\circ}\text{C}$  produced trisaccharide **2.40** in 69% yield. Cleavage of levulinoyl ester and the TBS silyl ether afforded diol **2.41**. Conversion of the azide to the corresponding acetamide using Zn/AcOH/Ac<sub>2</sub>O followed by hydrogenation afforded trisaccharide **2.3** (46% yield over two steps).



**Scheme 2.7:** Synthesis of oligosaccharides **2.3** and **2.4**

For the synthesis of trisaccharide **2.4**, the silyl group in disaccharide **2.38** was cleaved using  $\text{BF}_3 \cdot \text{OEt}_2$  followed by glycosylation with selenoglycoside donor **2.10** provided protected trisaccharide **2.43**. The global deprotection of trisaccharide **2.43** provided fully deprotected trisaccharide **2.4**. Similarly, global deprotection of disaccharide **2.39** provided deprotected disaccharide **2.5**.



**Scheme 2.8:** Synthesis of disaccharide **2.5**

## 2.3 Conclusion and outlook

This chapter describes the total synthesis of several oligosaccharides resembling the CPS of swine pathogen *S. suis* serotype 18 that are the basis for immunological studies and the development of a glycoconjugate vaccine. The rare D-bacillosamine derivative that was prepared from D-galactosamine using tin mediated reduction and dehalogenation. Access to the pentasaccharide repeating unit antigen proved very challenging due to the poor reactivity of the trisaccharide intermediate. The challenge was overcome by creation of the galacturonic acid at a late stage of the synthesis. The conjugation-ready glycans prepared using the total synthesis approach will be used for the immunological studies.

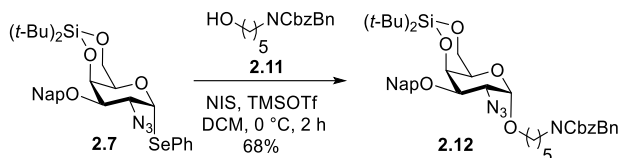
## 2.4 Experimental Section

### 2.4.1 General information

All the glassware were dried in the oven prior to reaction. Commercial grade solvents and reagents were used without further purification. Reactions sensitive to moisture were carried out under an atmosphere of nitrogen. Sodium iodide (NaI) used in the reaction was dried at 80 °C under vacuum, sugar building blocks indicated as commercially available were purchased from GlycoUniverse GmbH. Anhydrous solvents were obtained from a solvent drying system (JCMeyer) or dried according to reported procedures. Analytical TLC was performed on Kieselgel 60 F<sub>254</sub> glass (Macherey-Nagel). Spots were visualized with UV light ( $\lambda$ : 254 nm), sulphuric acid stain [1 mL of 3-methoxyphenol in 1 L of EtOH and 30 mL H<sub>2</sub>SO<sub>4</sub>] or ceric ammonium molybdate stain [0.5 g Ce(NH<sub>4</sub>)<sub>4</sub>(SO<sub>4</sub>)<sub>4</sub>•2H<sub>2</sub>O, 12 g (NH<sub>4</sub>)<sub>6</sub>Mo<sub>7</sub>O<sub>24</sub>•4H<sub>2</sub>O and 15 mL H<sub>2</sub>SO<sub>4</sub> in 235 mL H<sub>2</sub>O]. Flash chromatography was performed on Kieselgel 60 230-400 mesh (Sigma-Aldrich). Preparative HPLC purifications were performed with an Agilent 1200 Series or Agilent 1260 Infinity II. NMR spectra were recorded on a Varian 400 MHz spectrometer (Agilent), Ascend 400 MHz (cryoprobe, Bruker), Ascend 700 MHz (cryoprobe, Bruker) or Varian 600 MHz (Agilent) at 25 °C unless indicated otherwise. Chemical shifts ( $\delta$ ) are reported in parts per million (ppm) relative to the respective residual solvent peaks (CHCl<sub>3</sub>:  $\delta$  7.26 in <sup>1</sup>H and 77.16 in <sup>13</sup>C; HDO  $\delta$  4.79 in <sup>1</sup>H). Bidimensional and non-decoupled experiments were performed to assign identities of peaks showing relevant structural features. The following abbreviations are used to indicate peak multiplicities: s (singlet), d (doublet) dd (doublet of doublets), t (triplet), dt (doublet of triplets), td (triplet of doublets), q (quartet), p (pentet), m (multiplet). Additional descriptors b (broad signal) and app (apparent first-order multiplet) are also employed when required. Coupling constants (J) are reported in Hertz (Hz). NMR spectra were processed using MestreNova 14.1 (MestreLab Research). High-resolution mass spectra (ESI-HRMS) were recorded with a Xevo G2-XS Q-Tof (Waters).

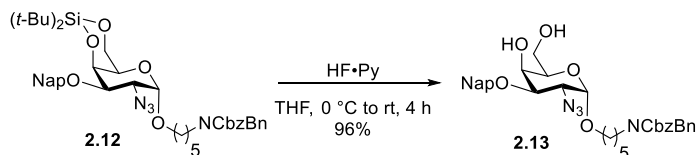
## 2.4.2 Experimental procedure and spectral data

### *N*-(Benzyl)benzyloxycarbonyl-5-aminopentyl 2-azido-2-deoxy-3-*O*-(2-naphthylmethyl)-4,6-*O*-silylidene- $\alpha$ -D-galactopyranoside (**2.12**)



To a solution of donor **2.7** (2.2 g, 3.52 mmol.), *N*-benzyloxycarbonyl-*N*-benzyl-5-aminopentanol **2.11** (2.31 g, 7.04 mmol) in DCM (20 mL) were added 4Å molecular sieves. After ~30 minutes, the mixture was cooled to 0 °C and *N*-iodosuccinimide (1.03 g, 4.58 mmol) and TMSOTf (63  $\mu$ L, 0.35 mmol) were added. After TLC analysis indicated complete consumption of the starting material (~2 hours), the reaction was quenched with Et<sub>3</sub>N (2 mL) and the mixture was diluted with DCM. After filtration over Celite® 353, the mixture was washed with 10% aqueous Na<sub>2</sub>S<sub>2</sub>O<sub>3</sub>, saturated aqueous NaHCO<sub>3</sub> and brine, dried over Na<sub>2</sub>SO<sub>4</sub>, filtered and concentrated *in vacuo*. The crude was purified by silica gel column chromatography using 8% ethyl acetate in hexanes to afford the title product **2.12** as the sole isomer (1.9 g, 68%). <sup>1</sup>H NMR (400 MHz, CDCl<sub>3</sub>)  $\delta$  7.86 – 7.81 (m, 4H), 7.58 (m, 1H), 7.48 (dd, *J* = 6.4, 3.2 Hz, 2H), 7.38 – 7.24 (m, 9H), 7.17 (d, *J* = 7.4 Hz, 1H), 5.18 (d, *J* = 21.1 Hz, 2H), 4.94 – 4.88 (m, 2H), 4.84 (d, *J* = 11.8 Hz, 1H), 4.61 (d, *J* = 12.3 Hz, 1H), 4.50 (d, *J* = 14.6 Hz, 2H), 4.24 (t, *J* = 14.5 Hz, 1H), 4.13 (m, 1H), 3.90 (dd, *J* = 17.0, 10.5 Hz, 1H), 3.82 – 3.77 (m, 1H), 3.60 (m, 2H), 3.46 – 3.36 (m, 1H), 3.28 – 3.17 (m, 2H), 1.63 – 1.50 (m, 4H), 1.35 – 1.28 (m, 2H), 1.08 (s, 9H), 1.06 (s, 9H). <sup>13</sup>C NMR (101 MHz, CDCl<sub>3</sub>)  $\delta$  156.8, 156.3, 138.0, 136.9, 135.5, 133.4, 133.2, 128.7, 128.6, 128.5, 128.1, 127.9, 127.8, 127.5, 127.4, 127.3, 126.7, 126.2, 126.1, 126.0, 98.4, 75.5, 70.6, 70.0, 68.3, 67.5, 67.3, 58.5, 50.6, 50.3, 47.2, 46.2, 29.8, 29.2, 27.8, 27.5, 23.6, 23.5, 20.9. HR-ESI-MS (*m/z*): calculated for C<sub>45</sub>H<sub>58</sub>N<sub>4</sub>O<sub>7</sub>SiNa [M+Na]<sup>+</sup>: 817.3972, found: 817.3978

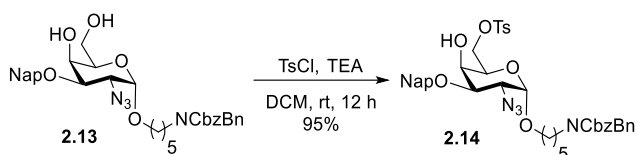
### *N*-(Benzyl)benzyloxycarbonyl-5-aminopentyl 2-azido-2-deoxy-3-*O*-(2-naphthylmethyl)- $\alpha$ -D-galactopyranoside (**2.13**)



To a solution of **2.12** (1.64 g, 2.06 mmol) in THF (20 mL) was added HF·Py (70% HF, 2.65 mL, 20.6 mmol). After TLC analysis indicated complete conversion of the starting material (~4 hours), the reaction was quenched with Et<sub>3</sub>N (2 mL). The mixture was concentrated, dissolved in EtOAc and subsequently washed with saturated aqueous NaHCO<sub>3</sub> and brine. The aqueous layers were then extracted with EtOAc, combined organic layers were dried over Na<sub>2</sub>SO<sub>4</sub>, filtered and concentrated *in vacuo*. The residue was purified by silica column chromatography using 25% ethyl

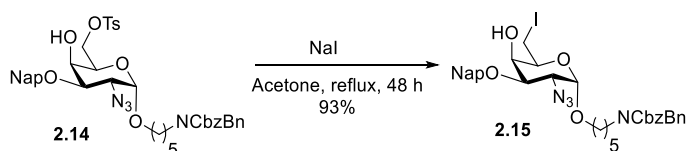
acetate in hexanes to furnish the title compound **2.13** (1.3 g, 96%).  $^1\text{H}$  NMR (400 MHz,  $\text{CDCl}_3$ )  $\delta$  7.89 – 7.79 (m, 4H), 7.56 – 7.45 (m, 3H), 7.41 – 7.13 (m, 10H), 5.19 (d,  $J = 17.3$  Hz, 2H), 4.94 – 4.82 (m, 3H), 4.56 – 4.41 (m, 2H), 4.19 (dd,  $J = 24.3, 3.2$  Hz, 1H), 4.01 – 3.54 (m, 6H), 3.48 – 3.11 (m, 3H), 2.95 (bs, 1H), 1.66 – 1.44 (m, 4H), 1.39 – 1.24 (m, 2H).  $^{13}\text{C}$  NMR (101 MHz,  $\text{CDCl}_3$ )  $\delta$  156.8, 156.4, 137.8, 136.9, 136.6, 134.6, 133.2, 133.2, 128.6, 128.5, 128.5, 128.0, 128.0, 127.9, 127.8, 127.8, 127.8, 127.4, 127.2, 126.9, 126.4, 126.3, 126.2, 125.7, 98.0, 98.0, 77.5, 77.4, 77.2, 76.8, 76.1, 75.9, 72.0, 69.8, 69.5, 68.2, 67.7, 67.4, 67.3, 67.3, 67.1, 62.8, 62.4, 59.1, 59.0, 50.5, 50.3, 47.2, 46.1, 29.0, 28.9, 27.9, 27.1, 23.3, 23.2. HR-ESI-MS ( $m/z$ ): calculated for  $\text{C}_{37}\text{H}_{42}\text{N}_4\text{O}_7\text{Na}$  [ $\text{M}+\text{Na}$ ] $^+$ : 677.2951, found: 677.2966.

***N*-(Benzyl)benzyloxycarbonyl-5-aminopentyl 2-azido-2-deoxy-3-*O*-(2-naphthylmethyl)-6-*O*-*p*-toluenesulfonyl- $\alpha$ -D-galactopyranoside (**2.14**)**



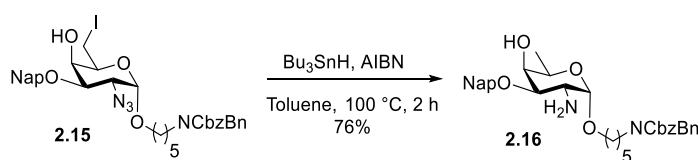
To a solution of **2.13** (1.3 g, 1.99 mmol) in DCM (15 mL), *p*-toluenesulfonyl chloride (455 mg, 2.39 mmol) and TEA (0.69 mL, 4.98 mmol) were added. The reaction mixture was stirred overnight at rt, when TLC showed that the starting material was completely consumed, diluted with DCM (10 mL), washed with saturated aqueous  $\text{NaHCO}_3$ , dried over  $\text{Na}_2\text{SO}_4$ , filtered and concentrated *in vacuo*. The residue was purified by silica gel column chromatography using 20% ethyl acetate in hexanes to furnish compound **2.14** (1.53 g, 95%).  $^1\text{H}$  NMR (400 MHz,  $\text{CDCl}_3$ )  $\delta$  7.89 – 7.81 (m, 4H), 7.79 – 7.74 (m, 2H), 7.54 – 7.46 (m, 3H), 7.41 – 7.24 (m, 11H), 7.19 (d,  $J = 7.2$  Hz, 1H), 5.19 (d,  $J = 13.3$  Hz, 2H), 4.90 – 4.78 (m, 3H), 4.51 (d,  $J = 8.3$  Hz, 2H), 4.26 – 4.12 (m, 2H), 4.06 (d,  $J = 4.0$  Hz, 1H), 4.03 – 3.86 (m, 2H), 3.60 (dd,  $J = 10.4, 3.6$  Hz, 2H), 3.41 – 3.15 (m, 4H), 2.42 (s, 3H), 1.63 – 1.49 (m, 4H), 1.37 – 1.23 (m, 2H).  $^{13}\text{C}$  NMR (101 MHz,  $\text{CDCl}_3$ )  $\delta$  156.8, 156.3, 145.1, 138.0, 136.8, 134.5, 133.3, 133.2, 132.7, 130.0, 128.7, 128.6, 128.6, 128.5, 128.1, 128.0, 127.9, 127.8, 127.4, 127.3, 127.3, 127.1, 126.5, 126.4, 125.7, 97.9, 77.5, 77.4, 77.2, 76.8, 75.7, 72.3, 68.9, 68.4, 67.9, 67.2, 65.9, 58.9, 50.6, 50.3, 47.2, 46.2, 29.0, 27.9, 27.5, 23.4, 23.3, 21.7. HR-ESI-MS ( $m/z$ ): calculated for  $\text{C}_{44}\text{H}_{48}\text{N}_4\text{O}_9\text{SNa}$  [ $\text{M}+\text{Na}$ ] $^+$ : 831.3040, found: 831.3060.

***N*-(Benzyl)benzyloxycarbonyl-5-aminopentyl 2-azido-2,6-di-deoxy-6-iodo-3-*O*-(2-naphthylmethyl)- $\alpha$ -D-galactopyranoside (**2.15**)**



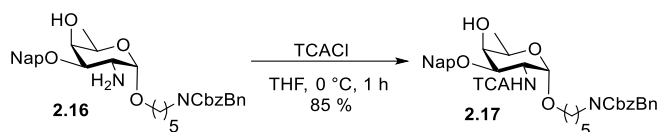
To a solution of **2.14** (1.53 g, 1.89 mmol) in acetone (25 mL) was added NaI (2.83 g, 18.9 mmol). The mixture was refluxed using oil bath under nitrogen for 48 h. After cooling to rt, ethyl acetate (25 mL) was added and the mixture was washed with saturated aqueous Na<sub>2</sub>S<sub>2</sub>O<sub>3</sub> solution and water. The organic phase was dried over Na<sub>2</sub>SO<sub>4</sub>, filtered, and concentrated. The residue was purified by silica gel column chromatography using 15% ethyl acetate in hexanes to give product **2.15** (1.35 g, 93%). <sup>1</sup>H NMR (400 MHz, CDCl<sub>3</sub>) δ 7.89 – 7.80 (m, 4H), 7.55 – 7.47 (m, 3H), 7.40 – 7.23 (m, 10H), 7.17 (d, *J* = 7.2 Hz, 1H), 5.18 (d, *J* = 14.4 Hz, 2H), 4.88 (q, *J* = 11.5 Hz, 3H), 4.50 (d, *J* = 9.4 Hz, 2H), 4.23 – 4.15 (m, 1H), 3.99 – 3.82 (m, 2H), 3.81 – 3.68 (m, 1H), 3.63 (dd, *J* = 10.4, 3.6 Hz, 1H), 3.48 – 3.36 (m, 1H), 3.32 (t, *J* = 4.7 Hz, 2H), 3.30 – 3.16 (m, 2H), 1.67 – 1.47 (m, 3H), 1.40 – 1.28 (m, 2H). <sup>13</sup>C NMR (101 MHz, CDCl<sub>3</sub>) δ 156.9, 156.3, 138.0, 138.0, 137.0, 136.8, 134.5, 133.3, 128.8, 128.7, 128.6, 128.6, 128.4, 128.2, 128.1, 128.1, 127.9, 127.9, 127.5, 127.4, 127.3, 127.2, 126.5, 126.4, 125.8, 97.9, 77.5, 77.4, 77.2, 76.8, 72.5, 70.7, 68.4, 67.3, 67.2, 58.8, 50.6, 50.3, 47.2, 46.2, 32.1, 29.8, 29.8, 29.5, 29.1, 28.0, 27.6, 23.5, 23.4, 22.8, 14.3, 3.0, 1.2. HR-ESI-MS (*m/z*): calculated for C<sub>37</sub>H<sub>41</sub>N<sub>4</sub>O<sub>6</sub>Na [M+Na]<sup>+</sup>: 787.1968, found: 787.1990

***N*-(Benzyl)benzyloxycarbonyl-5-aminopentyl 2-amino-2,6-di-deoxy-3-*O*-(2-naphthylmethyl) - $\alpha$ -D-galactopyranoside (**2.16**)**



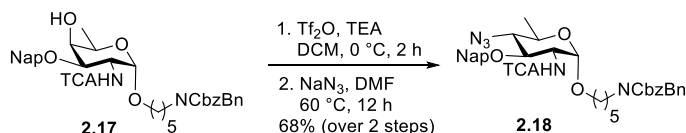
Compound **2.15** (1.35 g, 1.77 mmol) was co-evaporated with toluene for three times and dried under high vacuum for 8 h. To this, Bu<sub>3</sub>SnH (1.05 mL, 3.89 mmol) and AIBN (57 mg, 0.35 mmol) were added and stirred at 100 °C using oil bath for 2 h, after which time the reaction mixture was diluted with EtOAc (30 mL), the organic layer was washed with water (80 mL) and brine (80 mL), dried over Na<sub>2</sub>SO<sub>4</sub>, filtered and concentrated *in vacuo*. The resultant oil was purified by silica gel column chromatography using 5% methanol in DCM to afford desired compound **2.16** (821 mg, 76%) as oil. <sup>1</sup>H NMR (600 MHz, CDCl<sub>3</sub>) δ 7.87 – 7.77 (m, 3H), 7.51 – 7.45 (m, 3H), 7.39 – 7.20 (m, 10H), 7.15 (d, *J* = 7.4 Hz, 1H), 5.16 (d, *J* = 24.7 Hz, 2H), 4.88 – 4.79 (m, 2H), 4.70 (d, *J* = 11.2 Hz, 1H), 4.48 (d, *J* = 20.4 Hz, 2H), 3.89 – 3.81 (m, 2H), 3.65 – 3.45 (m, 2H), 3.43 – 3.29 (m, 1H), 3.27 – 3.09 (m, 4H), 2.45 (bs, 2H), 1.57 – 1.45 (m, 4H), 1.32 – 1.19 (m, 5H). <sup>13</sup>C NMR (151 MHz, CDCl<sub>3</sub>) δ 156.8, 156.3, 138.0, 136.8, 135.3, 133.3, 133.2, 130.5, 128.8, 128.6, 128.6, 128.5, 128.5, 128.2, 128.0, 127.9, 127.9, 127.8, 127.7, 127.6, 127.4, 127.3, 126.8, 126.7, 126.4, 126.2, 126.1, 126.0, 125.8, 99.4, 99.3, 80.2, 77.4, 77.4, 77.3, 77.2, 77.1, 76.9, 76.9, 71.5, 69.6, 68.2, 68.0, 67.3, 67.3, 65.8, 50.6, 50.3, 47.2, 46.2, 29.3, 28.0, 27.9, 27.6, 26.9, 23.6, 23.5, 16.6, 13.7. HR-ESI-MS (*m/z*): calculated for C<sub>37</sub>H<sub>44</sub>N<sub>2</sub>O<sub>6</sub>Na [M+Na]<sup>+</sup>: 635.3097, found: 635.3084

***N*-(Benzyl)benzyloxycarbonyl-5-aminopentyl 2-trichloroacetamido-2,6-di-deoxy-3-*O*-(2-naphthylmethyl) - $\alpha$ -D-galactopyranoside (**2.17**)**



The amine **2.16** (821 mg, 1.34 mmol) was dissolved in anhydrous THF (13 mL) and cooled to 0 °C. To this stirred solution, TCACl (0.19 mL, 1.74 mmol) was slowly added and stirred for 1 h at 0 °C under a nitrogen atmosphere. The mixture was diluted with DCM (20 mL) and washed with brine (3x), organic phase was dried over Na<sub>2</sub>SO<sub>4</sub>, filtered and evaporated. The crude product was purified by silica column chromatography using 10% ethyl acetate in hexane to give **2.17** (861 mg, 85%) as a yellow oil. <sup>1</sup>H NMR (600 MHz, CDCl<sub>3</sub>) δ 7.84 – 7.79 (m, 3H), 7.75 (s, 1H), 7.51 – 7.41 (m, 3H), 7.38 – 7.20 (m, 8H), 7.16 (d, *J* = 7.2 Hz, 1H), 6.77 (dd, *J* = 87.1, 9.2 Hz, 1H), 5.16 (d, *J* = 26.2 Hz, 2H), 4.88 – 4.78 (m, 2H), 4.77 – 4.69 (m, 1H), 4.52 – 4.40 (m, 3H), 3.92 (d, *J* = 3.1 Hz, 1H), 3.90 – 3.81 (m, 1H), 3.77 – 3.51 (m, 3H), 3.41 – 3.28 (m, 1H), 3.19 (dt, *J* = 46.0, 7.0 Hz, 2H), 1.59 – 1.42 (m, 4H), 1.32 (d, *J* = 6.6 Hz, 3H), 1.30 – 1.17 (m, 2H). <sup>13</sup>C NMR (151 MHz, CDCl<sub>3</sub>) δ 156.3, 138.0, 134.9, 133.3, 133.3, 128.7, 128.7, 128.6, 128.1, 127.9, 127.9, 127.5, 127.3, 126.7, 126.5, 126.3, 125.6, 97.1, 92.9, 77.4, 77.2, 76.9, 76.6, 71.5, 68.3, 68.2, 67.3, 65.9, 50.7, 50.4, 47.2, 46.2, 29.8, 29.1, 28.0, 27.5, 23.7, 23.4, 16.5. HR-ESI-MS (*m/z*): calculated for C<sub>39</sub>H<sub>43</sub>C<sub>13</sub>N<sub>2</sub>O<sub>7</sub>Na [M+Na]<sup>+</sup>: 779.2034, found: 779.2021

***N*-(Benzyl)benzyloxycarbonyl-5-aminopentyl 2-trichloroacetamido-4-azido-3-*O*-(2-naphthylmethyl)- 2,4,6-tri-deoxy- $\alpha$ -D-glucosidepyranoside (**2.18**)**

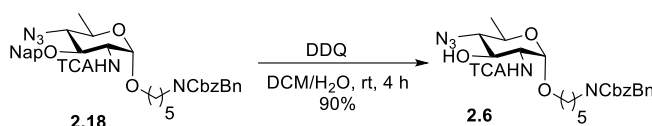


Triethylamine (0.81 mL, 13.9 mmol) was added to a stirred solution of **2.17** (880 mg, 1.16 mmol) in anhydrous DCM (10 mL). After being cooled to 0 °C, Tf<sub>2</sub>O (0.29 mL, 1.74 mmol) was added dropwise. The reaction was brought to rt over 2 h and partitioned between DCM (3 x 30 mL) and water (20 mL). Washing process was repeated three times and the combined organic layer was washed with saturated aqueous NaHCO<sub>3</sub>, 1N HCl, brine (20 mL), dried over Na<sub>2</sub>SO<sub>4</sub>, filtered and concentrated. The crude product was directly taken to the next step without purification. The crude triflate derivative was dissolved in anhydrous DMF (10 mL). To this stirred solution, NaN<sub>3</sub> (377 mg, 5.8 mmol) was added and gradually brought to 60 °C for 12 h. The reaction mixture was diluted with DCM (30 mL) and were washed with water (50 mL) and saturated aqueous brine (50 mL). Washing process was repeated three times and the combined organic layer was dried over Na<sub>2</sub>SO<sub>4</sub>, filtered and concentrated. The crude product was purified by silica gel column chromatography using 8% ethyl acetate in hexanes to afford compound **2.18** (613 mg, 68% over two steps). <sup>1</sup>H NMR (600 MHz, CDCl<sub>3</sub>) δ 7.84 – 7.76 (m, 4H), 7.48 – 7.42 (m, 3H), 7.40 – 7.22 (m, 8H), 7.17 (d, *J* = 7.3 Hz, 1H), 7.02 – 6.72 (m, 1H), 5.18 (d, *J* = 28.7 Hz, 2H), 4.98 – 4.84 (m, 2H), 4.80 – 4.71 (m, 1H), 4.50 (d, *J* = 11.6 Hz, 2H), 4.29 – 4.19 (m, 1H), 3.78 – 3.55 (m, 3H), 3.42 – 3.14 (m, 4H), 1.59 – 1.45 (m, 4H), 1.34 (d, *J* = 6.2 Hz, 3H), 1.28 – 1.19 (m, 1H). <sup>13</sup>C NMR (151



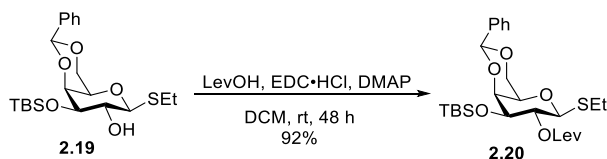
MHz, CDCl<sub>3</sub>)  $\delta$  161.8, 156.4, 137.9, 136.8, 134.9, 133.4, 133.2, 128.7, 128.6, 128.4, 128.2, 128.1, 127.9, 127.8, 127.5, 127.3, 127.1, 126.2, 126.1, 126.1, 96.9, 92.7, 78.9, 77.4, 77.2, 76.9, 75.2, 68.2, 67.4, 66.8, 55.0, 50.7, 50.5, 47.2, 46.2, 29.0, 28.0, 27.5, 23.8, 23.4, 18.5. HR-ESI-MS (m/z): calculated for C<sub>39</sub>H<sub>42</sub>Cl<sub>3</sub>N<sub>5</sub>O<sub>6</sub>Na [M+Na]<sup>+</sup>: 804.2098, found: 804.2090

***N*-(Benzyl)benzyloxycarbonyl-5-aminopentyl 2-trichloroacetamido-4-azido-2,4,6-tri-deoxy- $\alpha$ -D-galactopyranoside (2.6)**



To a stirred emulsion of **2.18** (613 mg, 0.78 mmol) in DCM and H<sub>2</sub>O (7/1, v/v, 8 mL) was added DDQ (265 mg, 1.17 mmol) under the exclusion of light and stirred at rt for 6 h. The mixture was diluted with DCM (40 mL) and washed (2 x 30 mL) with 10% aqueous Na<sub>2</sub>S<sub>3</sub>O<sub>3</sub> to reduce the remaining DDQ. The organic layer was dried over Na<sub>2</sub>SO<sub>4</sub>, filtered and concentrated *in vacuo*. The residue was purified by silica column chromatography using 10% ethyl acetate in hexanes to afford product **2.6** as yellowish oil (455 mg, 90%). <sup>1</sup>H NMR (400 MHz, CDCl<sub>3</sub>)  $\delta$  7.42 – 7.20 (m, 8H), 7.17 (d, *J* = 7.3 Hz, 1H), 5.26 – 5.11 (m, 2H), 4.81 (d, *J* = 14.5 Hz, 1H), 4.50 (d, *J* = 12.7 Hz, 2H), 3.97 (d, *J* = 11.2 Hz, 1H), 3.61 (dq, *J* = 15.7, 8.2 Hz, 2H), 3.45 – 3.31 (m, 1H), 3.22 – 3.10 (m, 2H), 3.05 (t, *J* = 9.6 Hz, 1H), 2.68 (s, 1H), 1.68 – 1.43 (m, 4H), 1.30 (d, *J* = 6.3 Hz, 5H). <sup>13</sup>C NMR (101 MHz, CDCl<sub>3</sub>)  $\delta$  128.7, 128.6, 128.1, 128.0, 127.4, 127.3, 97.6, 77.4, 77.2, 76.9, 70.9, 69.0, 68.4, 67.3, 66.4, 63.5, 50.7, 50.4, 47.2, 46.3, 29.2, 28.0, 27.6, 23.5, 18.4. HR-ESI-MS (m/z): calculated for C<sub>28</sub>H<sub>34</sub>Cl<sub>3</sub>N<sub>5</sub>O<sub>6</sub>Na [M+Na]<sup>+</sup>: 664.1472, found: 664.1473

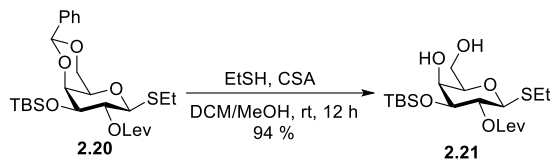
**Ethyl 4,6-*O*-benzylidene-3-*tert*-butyl dimethylsilyl-2-*O*-levulinoyl-1-thio- $\beta$ -D-galactopyranoside (2.20)**



To a solution of compound **2.19** (3.43 g, 8.04 mmol) in DCM (35 mL) were added 4-dimethylaminopyridine (99 mg, 0.81 mmol), levulinic acid (1.65 mL, 16.1 mmol) and EDC·HCl (2.31 g, 12.1 mmol). The mixture was stirred overnight at rt, washed with saturated aqueous NaHCO<sub>3</sub> and brine, the organic layer was dried over Na<sub>2</sub>SO<sub>4</sub>, filtered and concentrated. The residue was purified by silica gel column chromatography using 30% ethyl acetate in hexanes to afford compound **2.20** (3.87 g, 92%) as a white solid. <sup>1</sup>H NMR (600 MHz, CDCl<sub>3</sub>)  $\delta$  7.49 (dt, *J* = 7.6, 1.4 Hz, 2H), 7.37 – 7.31 (m, 3H), 5.48 (d, *J* = 1.7 Hz, 1H), 5.32 – 5.27 (m, 1H), 4.37 – 4.30 (m, 2H), 4.08 – 4.06 (m, 1H), 4.00 (dd, *J* = 12.4, 1.8 Hz, 1H), 3.85 (dd, *J* = 9.3, 3.6 Hz, 1H), 3.47 – 3.44 (m, 1H), 2.86 – 2.79 (m, 1H), 2.75 (td, *J* = 6.6, 1.8 Hz, 2H), 2.70 – 2.56 (m, 3H), 2.17 (d, *J*

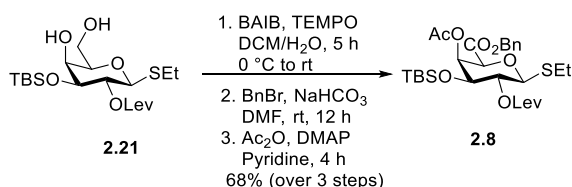
= 2.1 Hz, 3H), 1.25 (t, 3H), 0.84 (s, 9H), 0.07 (s, 3H), 0.06 (s, 3H).  $^{13}\text{C}$  NMR (151 MHz,  $\text{CDCl}_3$ )  $\delta$  206.3, 171.5, 137.9, 128.9, 128.1, 128.1, 126.3, 101.1, 82.8, 77.4, 77.2, 76.9, 76.8, 73.3, 70.2, 69.8, 69.4, 38.1, 30.0, 28.3, 25.6, 25.6, 22.8, 22.8, 18.0, 14.9, -4.5, -4.6. HR-ESI-MS ( $m/z$ ): calculated for  $\text{C}_{26}\text{H}_{40}\text{O}_7\text{SSiNa}$   $[\text{M}+\text{Na}]^+$ : 547.2162, found: 547.2168

### Ethyl 3-*tert*-butyl dimethylsilyl 2-*O*-levulinoyl-1-thio- $\beta$ -D-galactopyranoside (**2.21**)



To a solution of compound **2.20** (4.21 g, 8.02 mmol) in a mixture of DCM/MeOH (99:1, *v/v*) (32 mL), were added ethanethiol (4.13 mL, 56.2 mmol) and CSA (373 mg, 1.6 mmol). After stirring at rt for 6 h, the mixture was quenched with  $\text{Et}_3\text{N}$  and concentrated *in vacuo*. The residue was purified by silica gel column chromatography using 40% ethyl acetate in hexanes to give **2.21** (3.3 g, 94%).  $^1\text{H}$  NMR (600 MHz,  $\text{CDCl}_3$ )  $\delta$  5.14 (t,  $J = 9.5$  Hz, 1H), 4.33 (d,  $J = 10.0$  Hz, 1H), 4.01 – 3.95 (m, 1H), 3.86 (dd,  $J = 3.5, 1.2$  Hz, 1H), 3.82 – 3.75 (m, 2H), 3.62 – 3.56 (m, 1H), 2.81 – 2.70 (m, 3H), 2.70 – 2.59 (m, 3H), 2.19 (s, 3H), 1.25 (t,  $J = 7.5$  Hz, 3H), 0.88 (s, 9H), 0.12 (s, 3H), 0.10 (s, 3H).  $^{13}\text{C}$  NMR (151 MHz,  $\text{CDCl}_3$ )  $\delta$  206.3, 171.8, 83.5, 78.5, 77.4, 77.2, 76.9, 73.9, 70.5, 70.4, 62.7, 38.1, 30.1, 28.3, 25.7, 23.8, 18.0, 15.0, -4.6, -4.6. HR-ESI-MS ( $m/z$ ): calculated for  $\text{C}_{19}\text{H}_{36}\text{O}_7\text{SSiNa}$   $[\text{M}+\text{Na}]^+$ : 459.1849, found: 459.1857

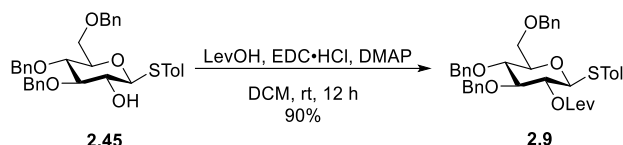
### Ethyl 4-*O*-acetyl-6-*O*-benzyl-3-*tert*-butyl dimethylsilyl-2-*O*-levulinoyl-1-thio- $\beta$ -D-glucopyranoside uronate (**2.8**)



Diol **2.21** (167 mg, 0.382 mmol) was dissolved in a mixture of DCM/ $\text{H}_2\text{O}$  (5:1, *v/v*, 6 mL) and cooled to 0 °C before TEMPO (6 mg, 0.038 mmol) and BAIB (197 mg, 0.611 mmol) were added and stirred at 0 °C for 20 min and slowly warmed to rt and stirred for 3 h. Reaction mixture was then diluted with DCM (5 mL) and water (5 mL) and the aqueous layer was extracted four times with DCM (5 mL each). Combined organics were dried over  $\text{Na}_2\text{SO}_4$ , filtered, and concentrated. The crude product was dissolved in DMF (1 mL),  $\text{NaHCO}_3$  (96 mg, 1.15 mmol) and BnBr (91  $\mu\text{L}$ , 0.764 mmol) were added at 0 °C. Then the reaction was stirred overnight at rt. After complete consumption of starting material, the mixture was diluted with DCM (20 mL) and washed with brine. The separated organic layer was dried over  $\text{Na}_2\text{SO}_4$  and concentrated *in vacuo*. Crude hydroxyl compound dissolved in pyridine (5 mL), was added acetic anhydride (0.24 mL, 2.56 mmol) at 0 °C. After being stirred at rt for 6 h, the mixture was concentrated *in vacuo*, diluted with

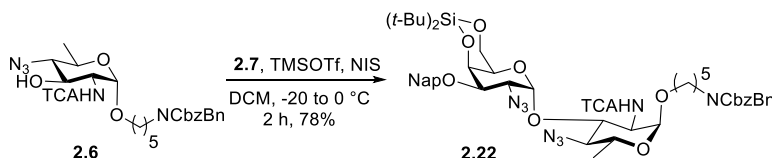
DCM (10 mL) and organic layer was washed with saturated NaHCO<sub>3</sub>, brine (10 mL) and dried over Na<sub>2</sub>SO<sub>4</sub>, filtered and concentrated *in vacuo*. The residue was purified by silica gel column chromatography using 20% ethyl acetate in hexanes to give **2.8** (165 mg, 68% over 3 steps). <sup>1</sup>H NMR (400 MHz, CDCl<sub>3</sub>) δ 7.39 – 7.26 (m, 4H), 5.57 (dd, *J* = 3.6, 1.3 Hz, 1H), 5.19 – 5.05 (m, 3H), 4.38 (d, *J* = 10.0 Hz, 1H), 4.22 (d, *J* = 1.3 Hz, 1H), 3.84 (dd, *J* = 9.2, 3.6 Hz, 1H), 2.78 – 2.71 (m, 0H), 2.71 – 2.62 (m, 1H), 2.62 – 2.55 (m, 2H), 2.16 (s, 3H), 1.90 (d, *J* = 0.9 Hz, 3H), 1.25 (t, *J* = 7.4 Hz, 3H), 0.78 (s, 8H), 0.07 (s, 3H), 0.05 (s, 3H). <sup>13</sup>C NMR (101 MHz, CDCl<sub>3</sub>) δ 206.2, 171.5, 169.7, 166.3, 135.0, 129.1, 128.6, 128.6, 83.7, 77.5, 77.2, 76.8, 76.0, 71.8, 70.5, 70.1, 67.5, 37.9, 30.0, 28.1, 25.4, 24.2, 20.5, 17.7, 14.9, -4.7, -5.0. HR-ESI-MS (*m/z*): calculated for C<sub>28</sub>H<sub>42</sub>O<sub>9</sub>SSiNa [M+Na]<sup>+</sup>: 605.2216, found: 605.2230

### Ethyl 2-*O*-levulinoyl-3,4,6-*O*-tri-benzyl-1-thio-β-*D*-glucopyranoside (**2.9**)



To a solution of compound **2.45** (1.54 g, 2.77 mmol) in dichloromethane (15 mL) were added 4-dimethylaminopyridine (84 mg, 0.69 mmol), levulinic acid (0.425 mL, 4.14 mmol) and EDC·HCl (847 mg, 4.42 mmol). The mixture was stirred overnight at rt, washed with saturated NaHCO<sub>3</sub> and brine, the organic layer was dried over Na<sub>2</sub>SO<sub>4</sub>, filtered and concentrated *in vacuo*. The residue was purified by flash column chromatography using 15% ethyl acetate in hexanes to afford compound **2.9** (1.62 g, 90%) as a white solid. <sup>1</sup>H NMR (400 MHz, CDCl<sub>3</sub>) δ 7.41 – 7.35 (m, 2H), 7.32 – 7.15 (m, 13H), 7.17 – 7.09 (m, 2H), 6.96 (d, *J* = 7.9 Hz, 2H), 4.95 (dd, *J* = 10.0, 8.7 Hz, 1H), 4.76 – 4.60 (m, 3H), 4.58 – 4.39 (m, 4H), 3.75 – 3.54 (m, 4H), 3.46 (dq, *J* = 7.5, 2.4 Hz, 1H), 2.71 – 2.56 (m, 2H), 2.56 – 2.35 (m, 2H), 2.21 (s, 3H), 2.07 (s, 3H). <sup>13</sup>C NMR (101 MHz, CDCl<sub>3</sub>) δ 206.1, 171.3, 138.1, 138.0, 137.9, 137.8, 133.1, 129.5, 128.5, 128.3, 128.3, 128.2, 127.9, 127.7, 127.6, 127.5, 127.4, 85.9, 84.2, 79.2, 77.5, 77.5, 77.2, 76.8, 75.1, 74.9, 73.3, 72.0, 68.7, 37.7, 29.7, 28.0, 21.0. HR-ESI-MS (*m/z*): calculated for C<sub>39</sub>H<sub>42</sub>O<sub>7</sub>SNa [M+Na]<sup>+</sup>: 677.2549, found: 677.2568

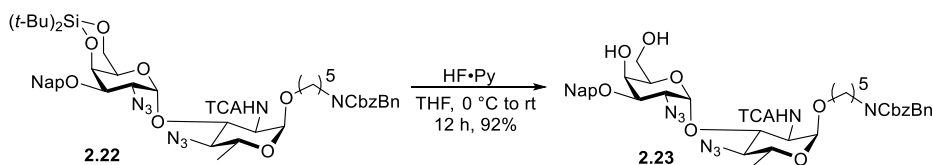
### *N*-(Benzyl)benzyloxycarbonyl-5-aminopentyl 2-azido-2-deoxy-3-*O*-(2-naphthylmethyl)-4,6-*O*-silylidene-α-*D*-galactopyranosyl-(1→3)-2-trichloroacetamido-4-azido-2,4,6-tri-deoxy-α-*D*-glucopyranosyl (**2.22**)



Acceptor **2.6** (100 mg, 0.156 mmol) and selenoglycoside **2.7** (127 mg 0.203 mmol) were mixed, co-evaporated with toluene (3 x 10 mL) and dried under high vacuum for 2 h. The mixture was dissolved in anhydrous DCM (12 mL) with suspended freshly activated 4Å molecular sieves, under a nitrogen atmosphere and stirred for 30 min at rt. The mixture was cooled to 0 °C, to this

stirred suspension, NIS (52.6 mg, 0.234 mmol) and TMSOTf (5.6  $\mu$ L, 31  $\mu$ mol) were slowly added. After stirring at rt for 2 h, diluted with DCM (10 mL), quenched with Et<sub>3</sub>N, warmed to rt and 4Å molecular sieves were filtered. The filtrate was washed with 10% aqueous Na<sub>2</sub>S<sub>2</sub>O<sub>3</sub>, saturated aqueous NaHCO<sub>3</sub> and brine. The combined organic layer was dried over Na<sub>2</sub>SO<sub>4</sub>, filtered and evaporated *in vacuo*. The crude product was purified by silica column chromatography using 10% ethyl acetate in hexanes to afford the desired protected disaccharide **2.22** (135 mg, 78%). <sup>1</sup>H NMR (600 MHz, CDCl<sub>3</sub>)  $\delta$  7.88 – 7.80 (m, 4H), 7.57 (dd, *J* = 8.4, 1.7 Hz, 1H), 7.50 – 7.44 (m, 2H), 7.39 – 7.14 (m, 9H), 6.87 (dd, *J* = 59.6, 9.4 Hz, 1H), 5.40 (d, *J* = 0.9 Hz, 1H), 5.18 (d, *J* = 18.2 Hz, 2H), 4.91 – 4.82 (m, 2H), 4.72 – 4.65 (m, 1H), 4.54 – 4.46 (m, 3H), 4.18 – 4.04 (m, 3H), 4.00 (dd, *J* = 10.6, 3.7 Hz, 1H), 3.91 (dd, *J* = 10.6, 2.7 Hz, 1H), 3.78 – 3.52 (m, 4H), 3.38 – 3.15 (m, 4H), 1.60 – 1.44 (m, 4H), 1.38 (d, *J* = 6.2 Hz, 3H), 1.33 – 1.20 (m, 2H), 1.04 (s, 9H), 1.02 (s, 9H). <sup>13</sup>C NMR (151 MHz, CDCl<sub>3</sub>)  $\delta$  162.0, 156.3, 137.9, 136.8, 135.5, 133.4, 133.2, 128.7, 128.6, 128.4, 128.2, 128.0, 127.9, 127.8, 127.5, 127.3, 126.8, 126.2, 126.1, 126.0, 99.4, 96.5, 92.4, 77.4, 77.2, 76.9, 76.8, 76.4, 71.2, 70.1, 69.7, 68.3, 68.2, 67.5, 67.4, 67.2, 58.7, 54.5, 50.7, 50.5, 47.1, 46.2, 29.1, 28.0, 27.7, 27.5, 27.5, 23.6, 23.5, 20.8, 18.3. HR-ESI-MS (*m/z*): calculated for C<sub>53</sub>H<sub>67</sub>C<sub>13</sub>N<sub>8</sub>O<sub>10</sub>SiNa [M+Na]<sup>+</sup>: 1131.3713, found: 1131.3721

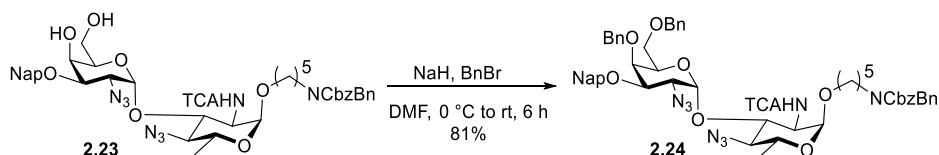
***N*-(Benzyl)benzyloxycarbonyl-5-aminopentyl 2-azido-2-deoxy-3-*O*-(2-naphthylmethyl)- $\alpha$ -D-galactopyranosyl-(1 $\rightarrow$ 3)-2-trichloroacetamido-4-azido-2,4,6-tri-deoxy- $\alpha$ -D-glucopyranosyl (2.23)**



To a solution of **2.22** (315 mg, 0.287 mmol) in THF (2.8 mL, 0.1 M) was added HF·Py (70% HF, 0.74 mL, 5.75 mmol). After TLC analysis (40% ethyl acetate in hexanes) indicated complete conversion of the starting material (~8 hours), the reaction was quenched with Et<sub>3</sub>N (4 mL). The mixture was concentrated, dissolved in EtOAc and subsequently washed with saturated aqueous NaHCO<sub>3</sub> and brine. The aqueous layers were then extracted with EtOAc, combined organic layers were dried over Na<sub>2</sub>SO<sub>4</sub>, filtered and concentrated *in vacuo*. The residue was purified by silica gel column chromatography using 35% ethyl acetate in hexanes to furnish the title compound **2.23** (257 mg, 92%). <sup>1</sup>H NMR (600 MHz, CDCl<sub>3</sub>)  $\delta$  7.87 – 7.82 (m, 4H), 7.54 – 7.48 (m, 3H), 7.40 – 7.21 (m, 10H), 7.18 (d, *J* = 7.3 Hz, 1H), 5.46 (dd, *J* = 33.6, 3.6 Hz, 1H), 5.19 (d, *J* = 22.6 Hz, 2H), 4.90 – 4.78 (m, 2H), 4.74 – 4.65 (m, 1H), 4.48 (dd, *J* = 27.9, 16.1 Hz, 2H), 4.22 – 4.14 (m, 1H), 4.01 (t, *J* = 5.7 Hz, 1H), 3.97 – 3.79 (m, 5H), 3.77 – 3.72 (m, 1H), 3.70 – 3.52 (m, 2H), 3.31 – 3.17 (m, 4H), 3.00 (bs, 1H), 1.59 – 1.45 (m, 5H), 1.37 (d, *J* = 6.2 Hz, 3H), 1.34 – 1.23 (m, 2H). <sup>13</sup>C NMR (151 MHz, CDCl<sub>3</sub>)  $\delta$  162.2, 162.1, 156.8, 156.3, 137.7, 136.8, 136.6, 134.6, 133.2, 133.2, 128.6, 128.5, 128.5, 128.4, 128.1, 128.0, 127.9, 127.9, 127.8, 127.7, 127.5, 127.4, 127.2, 127.1,

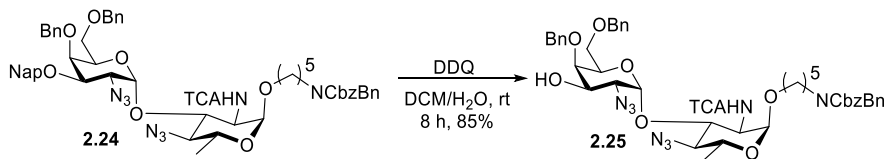
126.3, 126.2, 125.8, 98.3, 98.0, 96.6, 96.4, 92.4, 77.4, 77.2, 76.9, 76.5, 76.4, 75.9, 75.3, 72.4, 70.7, 69.2, 69.0, 68.1, 68.0, 67.9, 67.8, 67.3, 66.8, 63.2, 63.1, 59.4, 54.6, 54.5, 50.6, 50.2, 47.0, 46.0, 29.7, 28.9, 27.8, 27.4, 23.5, 23.3, 18.2. HR-ESI-MS (m/z): calculated for C<sub>45</sub>H<sub>51</sub>Cl<sub>3</sub>N<sub>8</sub>NaO<sub>10</sub>Na [M+Na]<sup>+</sup>: 991.2691, found: 991.2698

***N*-(Benzyl)benzyloxycarbonyl-5-aminopentyl 2-azido-2-deoxy-3-*O*-(2-naphthylmethyl)-4,6-*O*-di-benzyl- $\alpha$ -D-galactopyranosyl-(1 $\rightarrow$ 3)-2-trichloroacetamido-4-azido-2,4,6-tri-deoxy- $\alpha$ -D-glucopyranosyl (2.24)**



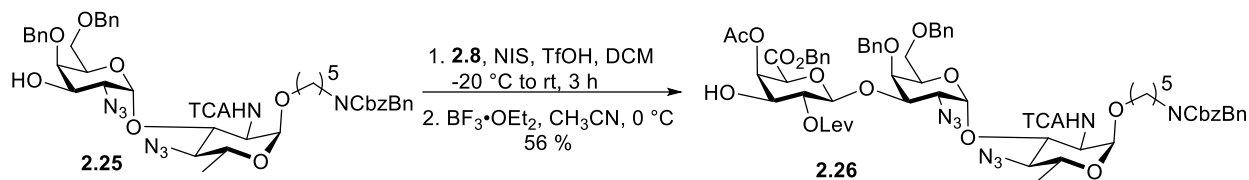
To a cooled solution of **2.23** (380 mg, 0.392 mmol) in DMF (2 mL) at 0 °C were added benzyl bromide (0.103 mL, 0.862 mmol) and NaH (60% disp.) (21.6 mg, 0.902 mmol). After stirring for 6 h, the mixture was neutralized with H<sub>2</sub>O and added EtOAc. The organic layer was washed with H<sub>2</sub>O for five times and brine, dried over Na<sub>2</sub>SO<sub>4</sub> and concentrated *in vacuo*. The residue was purified by silica column chromatography using 12% ethyl acetate in hexanes to yield the desired compound **2.24** (364 mg, 81%). <sup>1</sup>H NMR (400 MHz, CDCl<sub>3</sub>)  $\delta$  7.89 – 7.83 (m, 4H), 7.55 – 7.48 (m, 3H), 7.37 – 7.21 (m, 21H), 7.07 – 6.85 (m, 1H), 5.50 (d, *J* = 3.1 Hz, 1H), 5.20 (d, *J* = 11.0 Hz, 2H), 4.92 – 4.85 (m, 3H), 4.80 – 4.69 (m, 1H), 4.54 – 4.47 (m, 4H), 4.41 (d, *J* = 11.6 Hz, 1H), 4.20 – 4.11 (m, 1H), 4.10 – 3.99 (m, 4H), 3.89 – 3.59 (m, 3H), 3.56 (d, *J* = 6.8 Hz, 2H), 3.37 – 3.13 (m, 4H), 1.58 – 1.44 (m, 4H), 1.39 (d, *J* = 6.1 Hz, 3H), 1.28 – 1.18 (m, 2H). <sup>13</sup>C NMR (101 MHz, CDCl<sub>3</sub>)  $\delta$  162.1, 156.8, 156.3, 138.4, 137.9, 137.7, 136.9, 136.7, 135.2, 133.4, 133.1, 133.1, 128.7, 128.6, 128.5, 128.4, 128.4, 128.3, 128.2, 128.1, 128.1, 128.0, 127.9, 127.9, 127.8, 127.8, 127.4, 127.3, 126.6, 126.2, 126.1, 126.0, 125.8, 98.2, 96.4, 92.4, 77.5, 77.5, 77.4, 77.2, 76.8, 75.0, 74.9, 73.7, 73.6, 73.4, 72.5, 70.3, 69.5, 68.3, 68.2, 68.1, 67.3, 67.0, 60.0, 54.4, 50.6, 50.3, 47.1, 46.1, 29.8, 29.0, 27.9, 27.4, 23.5, 23.3, 18.3. HR-ESI-MS (m/z): calculated for C<sub>59</sub>H<sub>63</sub>Cl<sub>3</sub>N<sub>8</sub>O<sub>10</sub>Na [M+Na]<sup>+</sup>: 1171.3630, found: 1171.3637

***N*-(Benzyl)benzyloxycarbonyl-5-aminopentyl 2-azido-2-deoxy-4,6-*O*-di-benzyl- $\alpha$ -D-galactopyranosyl-(1 $\rightarrow$ 3)-2-trichloroacetamido-4-azido-2,4,6-tri-deoxy- $\alpha$ -D-glucopyranosyl (2.25)**



To a stirred emulsion of **2.24** (685 mg, 0.60 mmol) in DCM and H<sub>2</sub>O (7/1, v/v, 8 mL) was added DDQ (202 mg, 0.89 mmol) under the exclusion of light and stirred at rt for 8 h. The mixture was diluted with DCM (10 mL) and washed (2 x 15 mL) with 10% aqueous Na<sub>2</sub>S<sub>3</sub>O<sub>3</sub> to reduce the remaining DDQ. The organic layer was dried over Na<sub>2</sub>SO<sub>4</sub>, filtered and concentrated *in vacuo*. The residue was purified by silica column chromatography using 15% ethyl acetate in hexanes to afford product **2.25** as yellowish liquid (511 mg, 85%). <sup>1</sup>H NMR (700 MHz, CDCl<sub>3</sub>) δ 7.37 – 7.21 (m, 18H), 7.19 – 7.13 (m, 1H), 7.05 – 6.88 (m, 1H), 5.44 (dd, *J* = 9.3, 3.9 Hz, 1H), 5.20 – 5.12 (m, 2H), 4.72 (d, *J* = 20.3 Hz, 1H), 4.67 – 4.59 (m, 2H), 4.52 – 4.44 (m, 3H), 4.41 (d, *J* = 11.7 Hz, 1H), 4.12 – 4.06 (m, 2H), 4.05 – 4.01 (m, 1H), 3.89 (s, 1H), 3.82 – 3.63 (m, 2H), 3.63 – 3.48 (m, 4H), 3.36 – 3.11 (m, 4H), 2.28 (bs, 1H), 1.55 – 1.40 (m, 4H), 1.36 – 1.32 (m, 3H), 1.29 – 1.15 (m, 2H). <sup>13</sup>C NMR (176 MHz, CDCl<sub>3</sub>) δ 162.1, 156.8, 156.3, 138.1, 137.9, 137.7, 137.6, 136.9, 136.8, 128.7, 128.7, 128.6, 128.5, 128.4, 128.2, 128.1, 128.1, 128.0, 128.0, 127.9, 127.9, 127.5, 127.3, 98.1, 96.4, 92.5, 77.4, 77.3, 77.2, 77.2, 77.0, 77.0, 76.6, 76.6, 75.3, 75.1, 75.0, 73.7, 70.2, 69.4, 68.7, 68.6, 68.3, 68.2, 68.1, 67.3, 67.0, 61.4, 54.4, 50.7, 50.4, 47.1, 46.2, 29.0, 27.9, 27.5, 23.5, 23.3, 18.2. HR-ESI-MS (*m/z*): calculated for C<sub>48</sub>H<sub>55</sub>Cl<sub>3</sub>N<sub>8</sub>O<sub>10</sub>Na [M+Na]<sup>+</sup>: 1031.3004, found: 1031.3011

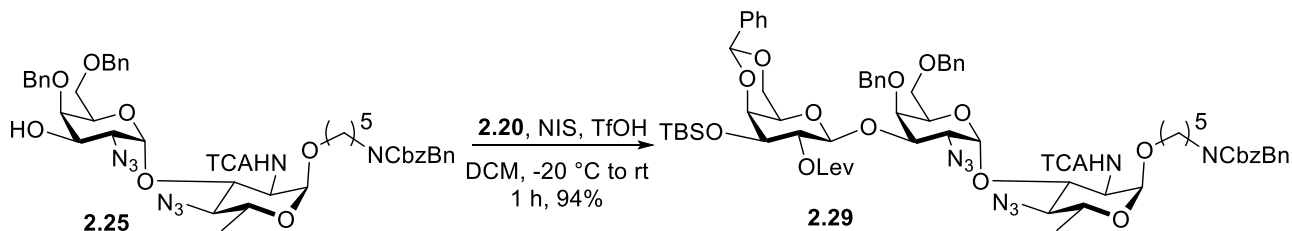
***N*-(Benzyl)benzyloxycarbonyl-5-aminopentyl 2-*O*-levulinoyl-4-*O*-acetyl-6-*O*-benzyl-β-*D*-galactopyranosyl uronate-(1→3)-2-azido-2-deoxy-4,6-*O*-di-benzyl-α-*D*-galactopyranosyl-(1→3)-2-trichloroacetamido-4-azido-2,4,6-tri-deoxy-α-*D*-glucopyranosyl (2.26)**



Acceptor **2.25** (76 mg, 0.075 mmol) and thioglycoside **2.8** (127 mg 0.135 mmol) were mixed, co-evaporated with toluene (3 x 10 mL) and dried under high vacuum for 2 h. The added freshly activated 4Å molecular sieves were dissolved in anhydrous DCM (5 mL) under a nitrogen atmosphere and stirred for 30 min at rt. The mixture was cooled to -20 °C, to this stirred suspension, NIS (30.3 mg, 0.135 mmol) and TfOH (2.6 μL, 0.03 mmol) were slowly added. After stirring at rt for 2 h, diluted with DCM (10 mL), quenched with Et<sub>3</sub>N, warmed to rt and 4Å molecular sieves were filtered. The filtrate was washed with 10% aqueous Na<sub>2</sub>S<sub>2</sub>O<sub>3</sub>, saturated aqueous NaHCO<sub>3</sub> and brine. The combined organic layer was dried over Na<sub>2</sub>SO<sub>4</sub>, filtered and evaporated *in vacuo*. The residue was passed through short silica column using ethyl acetate and evaporated *in vacuo*. The crude was dissolved in the anhydrous ACN (3 mL), cooled to 0 °C and BF<sub>3</sub>•OEt<sub>2</sub> (9.2 μmol, 0.075 mmol) was added. After stirring for 5 min, saturated aqueous NaHCO<sub>3</sub> was added and extracted the organic layer with DCM. The combined layers were dried over Na<sub>2</sub>SO<sub>4</sub>, filtered and evaporated *in vacuo*. The crude was purified by silica gel column chromatography using 20% ethyl acetate in hexanes to afford compound **2.26** (60 mg, 56% over

two steps).  $^1\text{H}$  NMR (400 MHz,  $\text{CDCl}_3$ )  $\delta$  7.31 – 7.14 (m, 23H), 7.08 (d,  $J = 7.2$  Hz, 1H), 7.02 – 6.87 (m, 1H), 5.61 (dd,  $J = 3.6, 1.3$  Hz, 1H), 5.45 (d,  $J = 3.6$  Hz, 1H), 5.16 – 5.04 (m, 4H), 4.95 (dd,  $J = 16.1, 11.7$  Hz, 2H), 4.73 (d,  $J = 7.9$  Hz, 1H), 4.61 (d,  $J = 16.1$  Hz, 1H), 4.52 (d,  $J = 11.6$  Hz, 1H), 4.43 – 4.21 (m, 5H), 4.19 – 4.00 (m, 2H), 3.98 – 3.86 (m, 3H), 3.87 – 3.76 (m, 2H), 3.61 (d,  $J = 6.2$  Hz, 1H), 3.54 – 3.37 (m, 2H), 3.25 (s, 1H), 3.18 – 3.03 (m, 4H), 2.88 – 2.77 (m, 1H), 2.73 – 2.61 (m, 1H), 2.60 – 2.47 (m, 2H), 2.10 (s, 3H), 1.80 (s, 3H), 1.45 – 1.32 (m, 4H), 1.28 (d,  $J = 6.2$  Hz, 3H), 1.17 – 1.04 (m, 2H).  $^{13}\text{C}$  NMR (101 MHz,  $\text{CDCl}_3$ )  $\delta$  208.0, 173.0, 170.3, 166.0, 138.9, 138.1, 137.9, 135.0, 129.1, 128.8, 128.7, 128.6, 128.4, 128.4, 128.1, 128.0, 127.9, 127.8, 127.7, 127.5, 127.3, 102.0, 97.7, 96.5, 92.3, 78.8, 77.5, 77.4, 77.2, 76.8, 76.4, 75.1, 73.6, 72.7, 72.5, 71.1, 70.4, 69.5, 67.6, 67.3, 66.9, 60.0, 54.4, 50.7, 50.4, 47.1, 46.2, 38.7, 29.9, 29.9, 29.0, 28.4, 20.6, 18.3. HR-ESI-MS ( $m/z$ ): calculated for  $\text{C}_{68}\text{H}_{77}\text{Cl}_3\text{N}_8\text{O}_{19}\text{Na}$   $[\text{M}+\text{Na}]^+$ : 1437.4268, found: 1437.4261

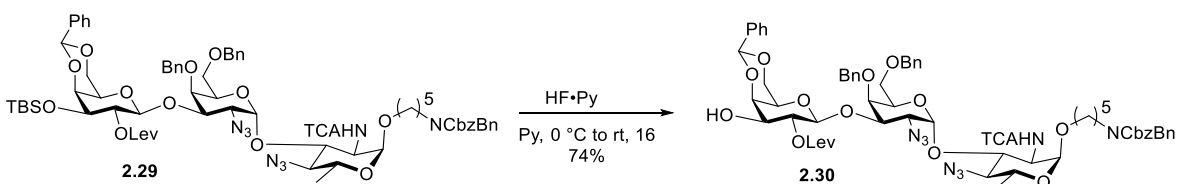
***N*-(Benzyl)benzyloxycarbonyl-5-aminopentyl 2-levulinoyl-3-*tert*-butyl dimethylsilyl-4,6-*O*-benzylidene- $\beta$ -D-galactopyranosyl-(1 $\rightarrow$ 3)-2-azido-2-deoxy-4,6-*O*-di-benzyl- $\alpha$ -D-galactopyranosyl-(1 $\rightarrow$ 3)-2-trichloroacetamido-4-azido-2,4,6-tri-deoxy- $\alpha$ -D-glucopyranosyl (2.29)**



Acceptor **2.25** (200 mg, 0.198 mmol) and thioglycoside **2.20** (145 mg, 0.277 mmol) were mixed, co-evaporated with toluene (3 x 10 mL) and dried under vacuum for 2 h. The mixture was dissolved in anhydrous DCM (6 mL), freshly activated 4Å molecular sieves were added under a nitrogen atmosphere and stirred for 30 min at rt. The mixture was cooled to -20 °C, to this stirred suspension, NIS (68 mg, 0.297 mmol) and TfOH (26  $\mu\text{L}$ , 0.059 mmol) were slowly added. The mixture was brought to 0 °C over 4 h, diluted with DCM (5 mL), quenched with  $\text{Et}_3\text{N}$ , warmed to rt and 4Å molecular sieves were filtered. The filtrate was washed with saturated aqueous  $\text{Na}_2\text{S}_2\text{O}_3$ , saturated aqueous  $\text{NaHCO}_3$  and brine. The combined organic layer was dried over  $\text{Na}_2\text{SO}_4$ , filtered and evaporated *in vacuo*. The crude product was purified by silica column chromatography using 20% ethyl acetate in hexanes to afford the desired protected trisaccharide **2.29** (275 mg, 94%).  $^1\text{H}$  NMR (600 MHz,  $\text{CDCl}_3$ )  $\delta$  7.53 – 7.48 (m, 2H), 7.46 – 7.18 (m, 24H), 7.07 (dd,  $J = 49.5, 9.3$  Hz, 1H), 5.64 (d,  $J = 3.7$  Hz, 1H), 5.59 (s, 1H), 5.41 (dd,  $J = 9.8, 7.9$  Hz, 1H), 5.24 (d,  $J = 16.7$  Hz, 2H), 5.11 (d,  $J = 11.7$  Hz, 1H), 4.83 – 4.74 (m, 2H), 4.65 (d,  $J = 11.7$  Hz, 1H), 4.54 (d,  $J = 15.3$  Hz, 2H), 4.49 – 4.43 (m, 1H), 4.41 – 4.31 (m, 2H), 4.24 – 4.13 (m, 4H), 4.08 (td,  $J = 9.6, 8.5, 4.3$  Hz, 2H), 4.00 – 3.88 (m, 3H), 3.82 – 3.61 (m, 2H), 3.61 – 3.53 (m, 2H), 3.43 – 3.36 (m, 2H), 3.35 – 3.25 (m, 2H), 3.22 (d,  $J = 7.7$  Hz, 1H), 2.90 – 2.83 (m, 1H), 2.80 (dd,  $J = 7.7, 5.8$  Hz, 1H), 2.78 – 2.73 (m, 2H), 2.22 (s, 3H), 1.58 – 1.48 (m, 4H), 1.44 (d,  $J = 6.2$  Hz, 3H), 1.35 – 1.30 (m, 2H),

0.93 (s, 9H), 0.16 (s, 3H), 0.16 (s, 3H).  $^{13}\text{C}$  NMR (151 MHz,  $\text{CDCl}_3$ )  $\delta$  206.7, 171.5, 162.2, 156.8, 156.3, 138.7, 138.0, 137.9, 137.8, 128.9, 128.8, 128.8, 128.7, 128.6, 128.5, 128.4, 128.4, 128.2, 128.1, 128.1, 128.0, 127.9, 127.8, 127.7, 127.4, 127.3, 126.3, 102.6, 101.2, 98.0, 96.4, 92.4, 77.4, 77.3, 77.2, 77.0, 76.9, 76.4, 76.1, 74.9, 73.5, 73.3, 73.2, 72.0, 71.9, 70.4, 69.6, 69.2, 68.2, 68.1, 67.3, 67.0, 66.6, 59.8, 54.5, 50.7, 50.3, 47.1, 46.1, 38.1, 30.0, 29.8, 29.0, 28.1, 27.9, 27.4, 26.0, 25.6, 23.4, 23.3, 18.3, 18.1, 1.1, -4.4, -4.5. HR-ESI-MS ( $m/z$ ): calculated for  $\text{C}_{72}\text{H}_{89}\text{Cl}_3\text{N}_8\text{O}_{17}\text{SiNa}$   $[\text{M}+\text{Na}]^+$ : 1493.5078, found: 1493.5072

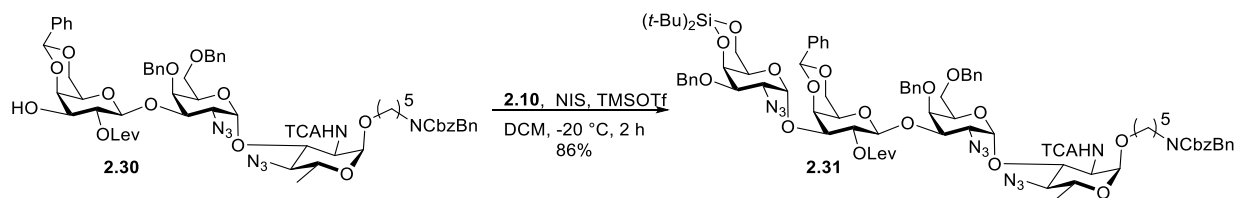
***N*-(Benzyl)benzyloxycarbonyl-5-aminopentyl 2-levulinoyl-4,6-*O*-benzylidene- $\beta$ -D-galactopyranosyl-(1 $\rightarrow$ 3)-2-azido-2-deoxy-4,6-*O*-di-benzyl- $\alpha$ -D-galactopyranosyl-(1 $\rightarrow$ 3)-2-trichloroacetamido-4-azido-2,4,6-tri-deoxy- $\alpha$ -D-glucopyranosyl (2.30)**



Protected trisaccharide **2.29** (290 mg g, 0.197 mmol) was dissolved in anhydrous pyridine (5 mL) at 0 °C and to this,  $\text{HF}\cdot\text{Py}$  (0.76 mL, 5.91 mmol) was added dropwise and the reaction was stirred overnight at rt. The reaction mixture was diluted with water and extracted three times with DCM (3 x 10 mL). Organic layers were combined and then washed twice with cold dil. HCl (20 mL each time), saturated aqueous  $\text{NaHCO}_3$  (20 mL), brine (10 mL), dried over  $\text{Na}_2\text{SO}_4$ , filtered and concentrated *in vacuo*. The residue was purified by silica gel column chromatography using 20% ethyl acetate in hexanes to yield **2.30** (204 mg, 74%) as a yellowish liquid.  $^1\text{H}$  NMR (400 MHz,  $\text{CDCl}_3$ )  $\delta$  7.33 – 7.05 (m, 25H), 6.89 (dd,  $J = 31.0, 9.6$  Hz, 1H), 5.48 (s, 1H), 5.45 (d,  $J = 3.7$  Hz, 1H), 5.17 (dd,  $J = 10.0, 7.8$  Hz, 1H), 5.09 (d,  $J = 8.7$  Hz, 2H), 5.02 (d,  $J = 11.5$  Hz, 1H), 4.74 (d,  $J = 7.9$  Hz, 1H), 4.66 – 4.58 (m, 1H), 4.53 (d,  $J = 11.5$  Hz, 1H), 4.39 (d,  $J = 7.5$  Hz, 2H), 4.35 – 4.21 (m, 2H), 4.20 – 4.16 (m, 2H), 4.10 – 3.99 (m, 3H), 3.95 (td,  $J = 10.2, 9.7, 4.5$  Hz, 2H), 3.82 (dd,  $J = 10.8, 3.6$  Hz, 1H), 3.75 (dt,  $J = 10.0, 7.8$  Hz, 2H), 3.66 – 3.55 (m, 1H), 3.53 – 3.37 (m, 3H), 3.29 (dd,  $J = 9.2, 6.5$  Hz, 2H), 3.14 (t,  $J = 9.6$  Hz, 3H), 2.81 – 2.74 (m, 1H), 2.72 – 2.66 (m, 1H), 2.63 – 2.54 (m, 2H), 2.08 (s, 3H), 1.42 (t,  $J = 6.4$  Hz, 1H), 1.29 (d,  $J = 6.2$  Hz, 3H), 1.17 – 1.04 (m, 3H).  $^{13}\text{C}$  NMR (151 MHz,  $\text{CDCl}_3$ )  $\delta$  207.1, 172.8, 162.3, 156.9, 156.4, 138.8, 138.1, 138.0, 137.6, 137.0, 129.4, 128.8, 128.8, 128.7, 128.5, 128.4, 128.4, 128.2, 128.2, 128.1, 128.0, 127.9, 127.8, 127.7, 127.5, 127.4, 126.6, 102.3, 101.8, 98.1, 96.5, 92.5, 78.2, 77.5, 77.3, 77.1, 77.0, 76.3, 75.5, 75.2, 74.0, 73.6, 72.8, 71.6, 70.4, 69.7, 69.2, 69.0, 68.3, 67.4, 67.1, 66.6, 60.1, 54.6, 50.4, 47.2, 38.5, 30.0, 29.9, 29.1, 28.4, 28.0, 27.5, 23.5, 23.4, 18.4. HR-ESI-MS ( $m/z$ ): calculated for  $\text{C}_{66}\text{H}_{75}\text{Cl}_3\text{N}_8\text{O}_{17}\text{Na}$   $[\text{M}+\text{Na}]^+$ : 1379.4213; found 1379.4221

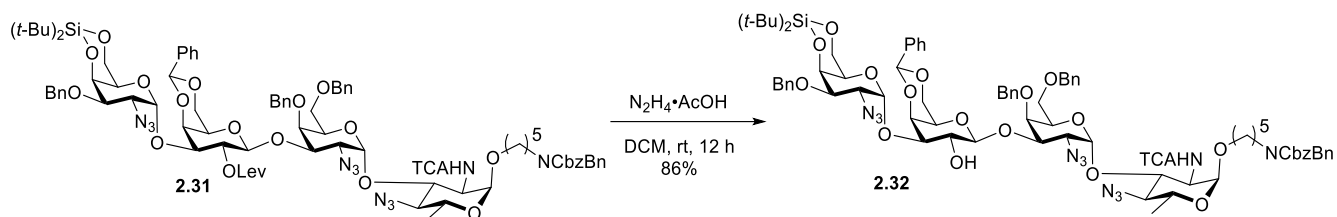
***N*-(Benzyl)benzyloxycarbonyl-5-aminopentyl 2-azido-2-deoxy-3-*O*-benzyl-4,6-*O*-silylidene- $\alpha$ -D-galactopyranosyl-(1 $\rightarrow$ 3)-2-levulinoyl-4,6-*O*-benzylidene- $\beta$ -D-galactopyranosyl-(1 $\rightarrow$ 3)-2-azido-2-deoxy-4,6-*O*-di-benzyl- $\alpha$ -D-galactopyranosyl-(1 $\rightarrow$ 3)-2-trichloroacetamido-4-azido-2,4,6-tri-deoxy- $\alpha$ -D-glucopyranosyl (2.31)**





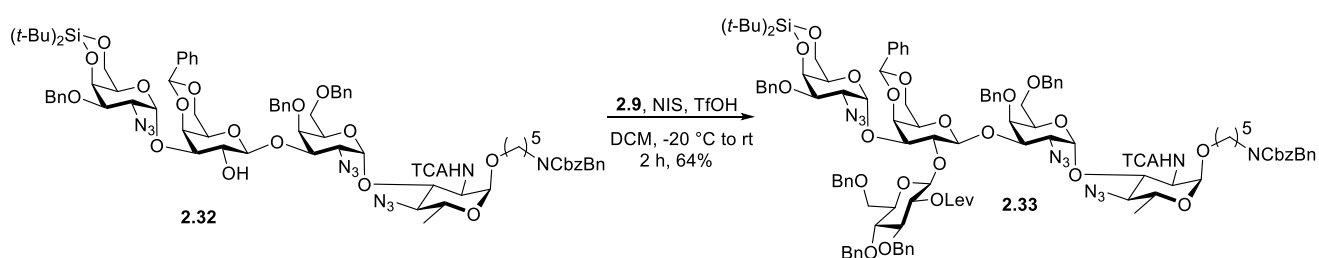
Selenoglycoside donor **2.10** (119 mg, 0.207 mmol) and trisaccharide acceptor **2.30** (204 mg, 0.138 mmol) were dried azeotropically with toluene in rotary evaporator. DCM (5 mL) was then added followed by activated 4Å molecular sieves and the solution stirred at rt for 30 min before cooling to -20 °C. NIS (49.7 mg, 0.221 mmol) and TMSOTf (7.5 μL, 0.041 mmol) were added and the reaction mixture stirred at -20 °C for 2 h. The reaction mixture was quenched with Et<sub>3</sub>N, warmed to rt and 4Å molecular sieves were filtered. The filtrate was washed with saturated aqueous Na<sub>2</sub>S<sub>2</sub>O<sub>3</sub>, saturated aqueous NaHCO<sub>3</sub> and brine. The combined organic layer was dried over Na<sub>2</sub>SO<sub>4</sub>, filtered and evaporated *in vacuo*. The crude product was purified by silica gel column chromatography using 20% ethyl acetate in hexanes to afford the desired protected tetrasaccharide **2.31** (210 mg, 86%). <sup>1</sup>H NMR (600 MHz, CDCl<sub>3</sub>) δ 7.42 – 7.38 (m, 2H), 7.32 (d, *J* = 7.7 Hz, 2H), 7.30 – 7.20 (m, 8H), 7.19 – 7.15 (m, 8H), 7.15 – 7.05 (m, 10H), 6.96 – 6.83 (m, 1H), 5.53 (s, 1H), 5.48 (d, *J* = 3.8 Hz, 1H), 5.38 (dd, *J* = 10.0, 7.9 Hz, 1H), 5.12 – 5.06 (m, 3H), 4.94 (d, *J* = 11.7 Hz, 1H), 4.86 (d, *J* = 2.8 Hz, 1H), 4.72 – 4.66 (m, 2H), 4.51 (dd, *J* = 18.5, 11.4 Hz, 2H), 4.39 (d, *J* = 16.0 Hz, 3H), 4.34 (d, *J* = 3.7 Hz, 1H), 4.32 – 4.27 (m, 2H), 4.21 (td, *J* = 12.6, 3.9 Hz, 2H), 4.14 (d, *J* = 12.8 Hz, 1H), 4.10 – 4.01 (m, 3H), 3.97 – 3.87 (m, 6H), 3.83 – 3.77 (m, 1H), 3.74 – 3.67 (m, 2H), 3.63 (q, *J* = 7.6, 6.8 Hz, 2H), 3.50 – 3.46 (m, 1H), 3.41 (q, *J* = 9.9, 7.7 Hz, 2H), 3.29 – 3.21 (m, 2H), 3.13 (dd, *J* = 12.1, 7.1 Hz, 3H), 3.10 – 3.04 (m, 1H), 2.90 – 2.82 (m, 1H), 2.56 – 2.47 (m, 1H), 2.46 – 2.37 (m, 2H), 2.04 (s, 3H), 1.44 – 1.32 (m, 4H), 1.29 (d, *J* = 6.3 Hz, 3H), 1.20 – 1.13 (m, 2H), 1.00 (s, 9H), 0.97 (d, *J* = 1.6 Hz, 9H). <sup>13</sup>C NMR (151 MHz, CDCl<sub>3</sub>) δ 206.8, 171.2, 162.2, 156.7, 156.3, 138.6, 138.6, 138.3, 138.0, 137.9, 137.6, 136.9, 136.8, 133.2, 129.4, 129.3, 128.9, 128.7, 128.7, 128.6, 128.5, 128.4, 128.4, 128.3, 128.2, 128.1, 128.1, 128.1, 128.0, 128.0, 127.9, 127.8, 127.7, 127.7, 127.4, 127.4, 127.3, 126.4, 126.3, 102.6, 101.2, 98.1, 96.4, 95.6, 92.4, 77.4, 77.2, 76.9, 76.0, 75.0, 75.0, 74.9, 74.2, 73.5, 71.7, 70.4, 70.4, 70.3, 69.7, 69.6, 69.1, 69.0, 68.4, 68.2, 68.1, 67.3, 67.2, 66.9, 66.5, 59.8, 57.8, 54.5, 50.7, 50.3, 47.1, 37.5, 30.1, 29.0, 28.1, 28.1, 27.8, 27.8, 27.8, 27.6, 27.4, 27.3, 23.5, 23.4, 23.3, 20.8, 18.2. HR-ESI-MS (*m/z*): calculated for C<sub>87</sub>H<sub>106</sub>Cl<sub>3</sub>N<sub>11</sub>O<sub>21</sub>SiNa [M+Na]<sup>+</sup>: 1796.6297, found: 1796.6286

***N*-(Benzyloxy)benzylidene-5-aminopentyl 2-azido-2-deoxy-3-*O*-benzyl-4,6-*O*-silylidene- $\alpha$ -D-galactopyranosyl-(1 $\rightarrow$ 3)-4,6-*O*-benzylidene- $\beta$ -D-galactopyranosyl-(1 $\rightarrow$ 3)-2-azido-2-deoxy-4,6-*O*-di-benzyl- $\alpha$ -D-galactopyranosyl-(1 $\rightarrow$ 3)-2-trichloroacetamido-4-azido-2,4,6-tri-deoxy- $\alpha$ -D-glucopyranosyl (2.32)**



To a solution of **2.31** (210 mg, 0.118 mmol) in DCM (5 mL) was added  $\text{N}_2\text{H}_4 \cdot \text{AcOH}$  (109 g, 1.18 mmol) and the mixture was stirred at rt for 12 h. The reaction was quenched by the addition of acetone (1 mL) and evaporated under high vacuum. Residue was purified by silica gel chromatography using 20% ethyl acetate in hexanes to afford product **2.32** (170 mg, 86%) as colorless syrup.  $^1\text{H}$  NMR (600 MHz,  $\text{CDCl}_3$ )  $\delta$  7.44 (dd,  $J = 7.5, 2.4$  Hz, 2H), 7.37 (dd,  $J = 7.2, 2.1$  Hz, 2H), 7.35 – 7.14 (m, 26H), 7.12 (d,  $J = 7.3$  Hz, 1H), 7.00 – 6.86 (m, 1H), 5.56 (s, 1H), 5.52 (t,  $J = 3.2$  Hz, 1H), 5.19 – 5.11 (m, 3H), 4.99 (dd,  $J = 11.9, 2.5$  Hz, 1H), 4.69 (d,  $J = 2.4$  Hz, 1H), 4.62 – 4.56 (m, 4H), 4.44 (d,  $J = 14.4$  Hz, 2H), 4.38 – 4.31 (m, 2H), 4.29 – 4.21 (m, 3H), 4.18 – 4.12 (m, 2H), 4.11 – 4.06 (m, 3H), 4.01 – 3.90 (m, 5H), 3.86 – 3.76 (m, 3H), 3.72 – 3.52 (m, 2H), 3.51 (s, 1H), 3.47 – 3.29 (m, 4H), 3.26 – 3.15 (m, 2H), 3.12 (t,  $J = 7.6$  Hz, 1H), 2.61 (bs, 1H), 1.50 – 1.38 (m, 4H), 1.33 (d,  $J = 6.0$  Hz, 3H), 1.23 – 1.19 (m, 2H), 1.04 (s, 9H), 1.02 (s, 9H).  $^{13}\text{C}$  NMR (151 MHz,  $\text{CDCl}_3$ )  $\delta$  162.2, 156.8, 156.3, 138.7, 137.9, 137.9, 137.8, 136.9, 136.8, 128.8, 128.7, 128.6, 128.6, 128.5, 128.4, 128.3, 128.3, 128.2, 128.2, 128.2, 128.1, 128.1, 128.0, 127.9, 127.9, 127.7, 127.7, 127.5, 127.4, 127.3, 126.4, 126.3, 105.3, 101.1, 97.8, 96.4, 95.4, 92.4, 79.3, 77.4, 77.2, 76.9, 76.1, 75.5, 75.4, 74.8, 74.0, 73.4, 71.9, 70.7, 70.2, 69.9, 69.6, 69.5, 69.3, 68.8, 68.3, 68.1, 67.8, 67.3, 67.3, 67.0, 66.6, 60.5, 60.0, 58.0, 54.4, 50.7, 50.4, 47.1, 46.1, 29.8, 29.0, 28.0, 27.9, 27.8, 27.4, 23.5, 23.4, 23.3, 21.2, 20.8, 18.3, 14.3. HR-ESI-MS ( $m/z$ ): calculated for  $\text{C}_{82}\text{H}_{100}\text{Cl}_3\text{N}_{11}\text{O}_{19}\text{SiNa}$   $[\text{M}+\text{Na}]^+$ : 1698.5929, found: 1698.5945

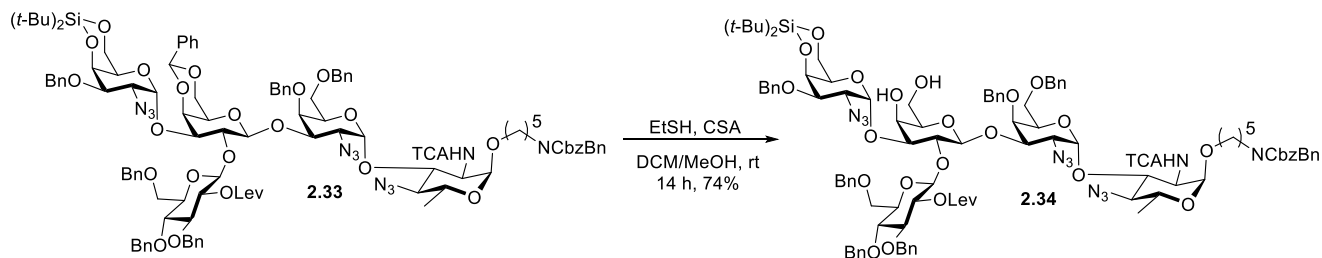
***N*-(Benzyl)benzyloxycarbonyl-5-aminopentyl 2-azido-2-deoxy-3-*O*-benzyl-4,6-*O*-silylidene- $\alpha$ -D-galactopyranosyl-(1 $\rightarrow$ 3)-[3,4,6-*O*-benzyl-2-*O*-levulinoyl- $\beta$ -D-galactopyranosyl-(1 $\rightarrow$ 3)]-4,6-*O*-benzylidene- $\beta$ -D-galactopyranosyl-(1 $\rightarrow$ 3)-2-azido-2-deoxy-4,6-*O*-di-benzyl- $\alpha$ -D-galactopyranosyl-(1 $\rightarrow$ 3)-2-trichloroacetamido-4-azido-2,4,6-tri-deoxy- $\alpha$ -D-glucopyranoside (2.33)**



Acceptor **2.32** (170 mg, 0.101 mmol) and thioglycoside donor **2.9** (119 mg, 0.182 mmol) were mixed, co-evaporated with toluene (3 x 10 mL) and dried under vacuum for 2 h. The mixture was dissolved in anhydrous DCM (5 mL), freshly activated 4 Å molecular sieves were added under a nitrogen atmosphere and stirred for 30 min at rt. The mixture was cooled to  $-20$  °C, to this stirred

suspension, NIS (41 mg; 0.182 mmol) and TfoH (3.6  $\mu$ L, 0.04 mmol) were slowly added. The mixture was brought to 0  $^{\circ}$ C over 4 h, diluted with DCM (5 mL), quenched with Et<sub>3</sub>N, warmed to rt and 4 $\text{\AA}$  molecular sieves were filtered. The filtrate was washed with 10% aqueous Na<sub>2</sub>S<sub>2</sub>O<sub>3</sub>, saturated aqueous NaHCO<sub>3</sub> and brine. The combined organic layer was dried over Na<sub>2</sub>SO<sub>4</sub>, filtered and evaporated *in vacuo*. The crude product was purified by silica gel column chromatography using 20% ethyl acetate in hexanes to afford protected pentasaccharide **2.33** (142 mg, 64%). <sup>1</sup>H NMR (600 MHz, CDCl<sub>3</sub>)  $\delta$  7.46 – 7.43 (m, 2H), 7.42 – 7.39 (m, 2H), 7.35 – 7.19 (m, 387H), 7.14 (t, *J* = 7.6 Hz, 2H), 7.00 – 6.88 (m, 1H), 5.56 (s, 1H), 5.45 (d, *J* = 3.7 Hz, 1H), 5.21 – 5.15 (m, 3H), 5.15 – 5.11 (m, 2H), 4.87 (d, *J* = 7.5 Hz, 1H), 4.79 (dd, *J* = 16.5, 11.2 Hz, 3H), 4.74 – 4.68 (m, 5H), 4.66 – 4.57 (m, 3H), 4.51 – 4.43 (m, 3H), 4.38 (dd, *J* = 16.4, 11.8 Hz, 2H), 4.32 (d, *J* = 3.3 Hz, 1H), 4.27 – 4.21 (m, 3H), 4.19 (d, *J* = 1.9 Hz, 2H), 4.17 – 4.08 (m, 3H), 4.08 – 4.01 (m, 3H), 3.97 – 3.88 (m, 2H), 3.86 – 3.77 (m, 3H), 3.73 – 3.65 (m, 3H), 3.62 – 3.55 (m, 2H), 3.55 – 3.47 (m, 3H), 3.44 (s, 1H), 3.25 (t, *J* = 9.6 Hz, 3H), 2.56 – 2.49 (m, 1H), 2.40 – 2.31 (m, 2H), 2.20 (dt, *J* = 14.5, 4.4 Hz, 1H), 1.85 (s, 3H), 1.53 (t, *J* = 7.8 Hz, 4H), 1.37 (d, *J* = 6.3 Hz, 3H), 1.33 – 1.29 (m, 1H), 1.06 (s, 9H), 1.05 (s, 9H). <sup>13</sup>C NMR (151 MHz, CDCl<sub>3</sub>)  $\delta$  206.4, 172.1, 162.3, 156.3, 139.0, 138.7, 138.5, 138.3, 138.2, 138.0, 137.9, 137.9, 136.8, 129.0, 128.7, 128.6, 128.5, 128.5, 128.4, 128.4, 128.4, 128.3, 128.2, 128.2, 128.1, 128.1, 128.0, 128.0, 127.9, 127.9, 127.8, 127.8, 127.7, 127.7, 127.6, 127.6, 127.5, 127.4, 127.3, 126.3, 103.9, 101.2, 98.9, 98.8, 96.4, 95.1, 92.5, 83.3, 77.8, 77.4, 77.2, 76.9, 76.8, 76.5, 75.8, 75.7, 75.5, 75.4, 75.3, 75.2, 75.0, 74.3, 74.0, 73.5, 73.5, 71.9, 70.4, 70.3, 70.0, 69.8, 69.2, 68.7, 68.3, 68.1, 67.3, 67.3, 67.1, 66.2, 65.3, 65.1, 63.4, 60.5, 59.0, 58.2, 54.5, 50.7, 50.4, 47.1, 46.2, 37.7, 34.9, 34.4, 34.3, 32.1, 31.6, 30.4, 30.3, 29.8, 29.8, 29.7, 29.7, 29.6, 29.6, 29.5, 29.4, 29.3, 29.0, 28.7, 28.0, 28.0, 27.9, 27.5, 27.2, 26.0, 25.0, 23.5, 23.4, 22.8, 21.2, 20.9, 18.2, 14.3, 14.3. HR-ESI-MS (*m/z*): calculated for C<sub>114</sub>H<sub>134</sub>Cl<sub>3</sub>N<sub>11</sub>O<sub>26</sub>SiNa [M+Na]<sup>+</sup>: 2228.8234, found: 2228.8242

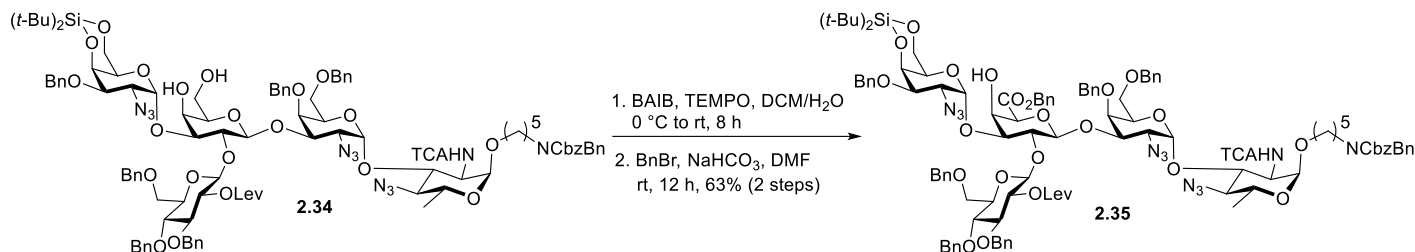
***N*-(Benzyl)benzyloxycarbonyl-5-aminopentyl 2-azido-2-deoxy-3-*O*-benzyl-4,6-*O*-silylidene- $\alpha$ -D-galactopyranosyl-(1 $\rightarrow$ 3)-[3,4,6-*O*-benzyl-2-*O*-levulinoyl- $\beta$ -D-glucopyranosyl-(1 $\rightarrow$ 3)]- $\beta$ -D-galactopyranosyl-(1 $\rightarrow$ 3)-2-azido-2-deoxy-4,6-*O*-di-benzyl- $\alpha$ -D-galactopyranosyl-(1 $\rightarrow$ 3)-2-trichloroacetamido-4-azido-2,4,6-tri-deoxy- $\alpha$ -D-glucopyranoside (**2.34**)**



To a solution of compound **2.33** (100 mg, 0.045 mmol) in a mixture of DCM/MeOH (99 : 1, *v/v*, 4 mL) were added ethanethiol (16.2  $\mu$ L, 0.225 mmol) and CSA (2.1 mg, 0.009 mmol) at rt. After being stirred at rt overnight, the mixture was quenched with Et<sub>3</sub>N and concentrated *in vacuo*. The residue was purified by silica gel column chromatography using 30% ethyl acetate in hexanes to afford **2.34** (71 mg, 74%). <sup>1</sup>H NMR (600 MHz, CDCl<sub>3</sub>)  $\delta$  7.49 – 7.44 (m, 2H), 7.40 – 7.38 (m, 1H),

7.36 – 7.23 (m, 32H), 7.22 – 7.15 (m, 4H), 7.09 – 6.99 (m, 1H), 5.61 (d,  $J = 3.5$  Hz, 1H), 5.22 – 5.15 (m, 3H), 5.03 – 4.98 (m, 2H), 4.88 – 4.83 (m, 2H), 4.80 – 4.74 (m, 3H), 4.73 – 4.69 (m, 3H), 4.65 – 4.62 (m, 2H), 4.61 – 4.56 (m, 2H), 4.52 – 4.44 (m, 4H), 4.38 – 4.33 (m, 1H), 4.29 – 4.23 (m, 3H), 4.15 (d,  $J = 15.0$  Hz, 1H), 4.11 – 4.06 (m, 2H), 4.02 (q,  $J = 4.0, 2.9$  Hz, 4H), 4.00 – 3.96 (m, 1H), 3.93 – 3.90 (m, 1H), 3.86 (d,  $J = 9.4$  Hz, 1H), 3.83 – 3.79 (m, 2H), 3.77 – 3.71 (m, 3H), 3.68 (td,  $J = 9.4, 1.7$  Hz, 1H), 3.62 (d,  $J = 9.2$  Hz, 1H), 3.57 – 3.52 (m, 2H), 3.50 (t,  $J = 5.2$  Hz, 1H), 3.47 – 3.42 (m, 3H), 3.38 – 3.22 (m, 3H), 3.20 – 3.15 (m, 1H), 2.80 – 2.74 (m, 1H), 2.58 (t,  $J = 6.6$  Hz, 2H), 2.52 – 2.45 (m, 1H), 2.43 – 2.35 (m, 1H), 1.97 (s, 3H), 1.56 – 1.42 (m, 4H), 1.38 (d,  $J = 6.2$  Hz, 3H), 1.31 – 1.25 (m, 2H), 1.09 (s, 9H), 1.07 (s, 9H).  $^{13}\text{C}$  NMR (151 MHz,  $\text{CDCl}_3$ )  $\delta$  206.1, 171.8, 162.3, 156.7, 156.2, 138.8, 138.4, 138.3, 138.2, 138.2, 137.9, 128.7, 128.6, 128.5, 128.5, 128.5, 128.4, 128.4, 128.4, 128.1, 128.0, 128.0, 128.0, 127.9, 127.8, 127.8, 127.8, 127.8, 127.7, 127.7, 127.7, 127.6, 127.5, 127.3, 102.5, 98.5, 98.0, 96.4, 94.2, 92.3, 83.1, 78.0, 77.4, 77.3, 77.2, 77.0, 76.9, 76.4, 75.5, 75.4, 75.3, 75.3, 74.9, 74.8, 74.5, 74.4, 73.6, 73.5, 73.4, 70.3, 69.8, 69.5, 69.3, 68.8, 68.1, 68.0, 67.3, 67.3, 67.0, 66.3, 63.0, 60.5, 59.5, 59.3, 54.4, 50.7, 50.4, 47.1, 46.1, 37.7, 29.6, 29.0, 28.1, 27.9, 27.8, 27.7, 27.6, 27.5, 27.4, 27.4, 27.3, 23.4, 23.3, 20.9, 18.2, 14.3. HR-ESI-MS ( $m/z$ ): calculated for  $\text{C}_{107}\text{H}_{130}\text{Cl}_3\text{N}_{11}\text{O}_{26}\text{SiNa}$   $[\text{M}+\text{Na}]^+$ : 2140.7921, found: 2140.7931

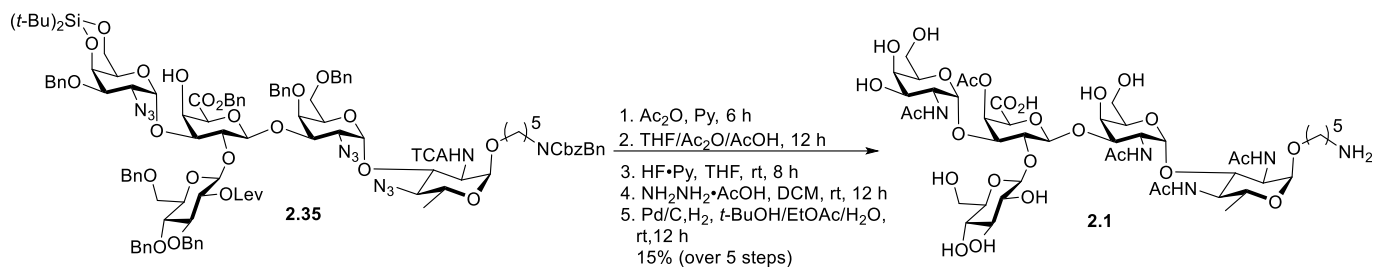
***N*-(Benzyl)benzyloxycarbonyl-5-aminopentyl 2-azido-2-deoxy-3-*O*-benzyl-4,6-*O*-silylidene- $\alpha$ -D-galactopyranosyl-(1 $\rightarrow$ 3)-[3,4,6-*O*-benzyl-2-*O*-levulinoyl- $\beta$ -D-glucopyranosyl-(1 $\rightarrow$ 3)]- $\beta$ -D-galactopyranosyl-(1 $\rightarrow$ 3)-2-azido-2-deoxy-4,6-*O*-di-benzyl- $\alpha$ -D-galactopyranosyl-(1 $\rightarrow$ 3)-2-trichloroacetamido-4-azido-2,4,6-tri-deoxy- $\alpha$ -D-glucopyranoside (2.35)**



Diol **2.34** (73 mg, 0.034 mmol) was dissolved in a mixture of DCM/*t*-BuOH/H<sub>2</sub>O (2:2:1, *v/v/v*, 4 mL) and cooled to 0 °C before TEMPO (1.1 mg, 0.007 mmol) and BAIB (27 mg, 0.085 mmol) were added and stirred at 0 °C for 8 h. The reaction mixture was then diluted with DCM (5 mL) and water (5 mL) and the aqueous layer was extracted four times with DCM (10 mL each). Combined organics were dried over Na<sub>2</sub>SO<sub>4</sub>, filtered, and concentrated. The crude product was dissolved in DMF (1 mL), NaHCO<sub>3</sub> (8.6 mg, 0.102 mmol) and BnBr (8  $\mu$ L, 0.068 mmol) were added at 0 °C. Then the reaction was stirred overnight at rt. After complete consumption of starting material, the mixture was diluted with DCM (20 mL) and washed with brine. The separated organic layer was dried over Na<sub>2</sub>SO<sub>4</sub> and concentrated *in vacuo*. The crude was purified by silica gel column chromatography using 20% ethyl acetate in hexanes to furnish product **2.35** (48 mg, 63% over two steps).  $^1\text{H}$  NMR (400 MHz,  $\text{CDCl}_3$ )  $\delta$  7.47 – 7.43 (m, 2H), 7.39 – 7.23 (m, 42H), 7.21 – 7.18 (m, 3H), 5.55 (d,  $J = 3.6$  Hz, 1H), 5.29 (d,  $J = 12.2$  Hz, 1H), 5.20 – 5.08 (m, 4H), 5.06 – 4.96

(m, 2H), 4.85 – 4.72 (m, 6H), 4.71 – 4.63 (m, 4H), 4.61 (d,  $J = 4.2$  Hz, 1H), 4.58 – 4.51 (m, 2H), 4.47 (d,  $J = 7.1$  Hz, 3H), 4.43 – 4.37 (m, 2H), 4.32 (q,  $J = 2.6$  Hz, 2H), 4.22 (s, 2H), 4.08 – 3.97 (m, 7H), 3.94 (dd,  $J = 9.6, 3.2$  Hz, 1H), 3.88 (d,  $J = 9.3$  Hz, 1H), 3.81 – 3.66 (m, 6H), 3.62 – 3.48 (m, 4H), 3.41 – 3.33 (m, 2H), 3.24 (dd,  $J = 14.3, 4.9$  Hz, 2H), 2.57 (td,  $J = 6.6, 2.7$  Hz, 2H), 2.48 – 2.35 (m, 2H), 1.94 (s, 3H), 1.53 – 1.38 (m, 4H), 1.35 (d,  $J = 6.2$  Hz, 3H), 1.23 – 1.12 (m, 2H), 1.06 (s, 9H), 1.03 (s, 9H).  $^{13}\text{C}$  NMR (101 MHz,  $\text{CDCl}_3$ )  $\delta$  206.1, 171.8, 167.0, 162.3, 139.1, 138.5, 138.4, 138.2, 138.2, 138.1, 138.0, 135.4, 128.8, 128.7, 128.6, 128.6, 128.6, 128.5, 128.4, 128.3, 128.2, 128.1, 128.1, 128.0, 127.9, 127.8, 127.8, 127.7, 127.7, 127.6, 127.3, 103.2, 98.5, 98.2, 96.4, 94.6, 92.4, 83.2, 78.0, 77.5, 77.4, 77.2, 77.0, 76.8, 75.6, 75.5, 75.3, 75.1, 74.4, 73.6, 73.5, 73.2, 70.4, 70.0, 69.7, 69.4, 68.7, 68.3, 67.3, 67.3, 67.1, 66.4, 59.3, 59.1, 54.5, 37.8, 29.8, 29.6, 29.0, 28.2, 27.8, 27.5, 23.5, 23.3, 20.9, 18.2, 14.3. HR-ESI-MS ( $m/z$ ): calculated for  $\text{C}_{114}\text{H}_{134}\text{C}_{13}\text{N}_{11}\text{O}_{27}\text{SiNa}$  [ $\text{M}+\text{Na}$ ] $^+$ : 2244.8183, found: 2244.8189.

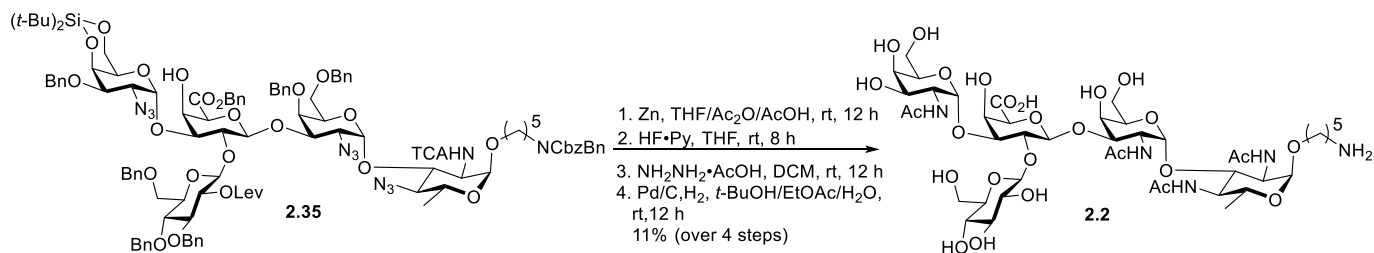
**5-Aminopentyl 2-acetamido-2-deoxy- $\alpha$ -D-galactopyranosyl-(1 $\rightarrow$ 3)-[ $\beta$ -D-glucopyranosyl-(1 $\rightarrow$ 2)]-4-O-acetyl- $\beta$ -D-galactopyranosyl urinate-(1 $\rightarrow$ 3)-2-acetamido-2-deoxy- $\alpha$ -D-galactopyranosyl-(1 $\rightarrow$ 3)-2,4-di-acetamido-2,4,6-tri-deoxy- $\alpha$ -D-glucopyranosyl (2.1)**



To a solution of pentasaccharide **2.35** (20 mg, 0.009 mmol) in pyridine (3 mL) was added acetic anhydride (2.5  $\mu\text{L}$ , 0.027 mmol) at 0 °C. After stirring at rt for 6 h, the mixture was concentrated *in vacuo*, diluted with DCM (10 mL) and organic layer was washed with saturated  $\text{NaHCO}_3$ , brine (10 mL) and dried over  $\text{Na}_2\text{SO}_4$ , filtered and concentrated *in vacuo*. The crude was dissolved in the solution of THF/ $\text{AcOH}/\text{Ac}_2\text{O}$  (2/1/1, v/v/v, 3 mL) and added freshly activated zinc (200 mg). After stirring 12 h at rt, the mixture was diluted with ethyl acetate and filtered over Celite® 353, evaporated *in vacuo* and dried in vacuum for 2 h. To a solution of crude in THF (3 mL) was added HF·Py (70% HF, 12  $\mu\text{L}$ , 0.09 mmol). After TLC analysis indicated complete conversion of the starting material (~8 hours), the reaction was quenched with  $\text{Et}_3\text{N}$  (0.5 mL). The mixture was concentrated, dissolved in EtOAc and subsequently washed with saturated aqueous  $\text{NaHCO}_3$  and brine. The aqueous layers were then extracted with EtOAc, combined organic layers were dried over  $\text{Na}_2\text{SO}_4$ , filtered and concentrated *in vacuo*. The crude was dissolved in DCM (3 mL),  $\text{N}_2\text{H}_4\cdot\text{AcOH}$  (8 mg, 0.09 mmol) was added and the mixture was stirred at rt for 12 h. The reaction was quenched by the addition of acetone (1 mL) and the solvent was removed under vacuum. The crude was filtered through a small bed of silica gel, evaporated *in vacuo*. The triol intermediate was dissolved in the solution of EtOAc/ $t\text{-BuOH}/\text{H}_2\text{O}$  (2/1/1, v/v/v, 2 mL) and Pd/C (50 mg) was added to the solution. After stirring for 12 h under hydrogen atmosphere (1 atm, balloon), the

mixture was filtered through a PTFE filter (0.45  $\mu\text{m}$  pore size) and concentrated. The crude material was purified by HPLC (Hypercarb column, 150 x 10 mm, H<sub>2</sub>O (0.1% formic acid) isocratic (5 min), linear gradient to 30% ACN (30 min), linear gradient to 100% ACN (10 min) and lyophilized to obtain pure pentasaccharide **2.1** (1.5 mg, 15%). <sup>1</sup>H NMR (600 MHz, D<sub>2</sub>O)  $\delta$  5.63 (d,  $J = 2.9$  Hz, 1H), 5.12 (d,  $J = 3.7$  Hz, 1H), 5.08 (d,  $J = 4.0$  Hz, 1H), 4.74 (s, 1H), 4.73 (s, 1H), 4.57 (d,  $J = 7.8$  Hz, 2H), 4.26 (d,  $J = 2.7$  Hz, 1H), 4.16 (dd,  $J = 11.2, 4.0$  Hz, 1H), 4.15 – 4.12 (m, 1H), 4.08 (s, 1H), 4.04 (d,  $J = 3.0$  Hz, 1H), 4.01 – 3.96 (m, 2H), 3.89 (d,  $J = 3.2$  Hz, 1H), 3.87 – 3.84 (m, 2H), 3.81 (d,  $J = 10.8$  Hz, 1H), 3.74 – 3.69 (m, 6H), 3.64 (d,  $J = 3.7$  Hz, 1H), 3.63 – 3.60 (m, 1H), 3.60 – 3.55 (m, 2H), 3.42 – 3.39 (m, 1H), 3.34 (t,  $J = 9.2$  Hz, 2H), 3.19 (d,  $J = 9.5$  Hz, 1H), 3.13 (dd,  $J = 9.4, 7.8$  Hz, 1H), 2.92 – 2.89 (m, 2H), 2.02 (d,  $J = 0.8$  Hz, 3H), 1.94 (s, 9H), 1.88 (d,  $J = 0.8$  Hz, 3H), 1.61 – 1.55 (m, 4H), 1.38 – 1.31 (m, 2H), 1.06 (d,  $J = 5.9$  Hz, 3H). <sup>13</sup>C NMR (176 MHz, D<sub>2</sub>O)  $\delta$  174.4, 174.2, 173.4, 173.3, 172.1, 171.0, 102.3, 102.0, 96.8, 96.5, 92.2, 76.8, 76.1, 75.8, 73.5, 73.3, 73.1, 70.9, 70.5, 70.2, 68.8, 68.2, 67.7, 67.4, 67.3, 61.6, 61.4, 60.9, 52.8, 49.1, 48.2, 39.4, 28.0, 26.5, 22.8, 22.3, 22.1, 22.0, 20.2, 16.3. HR-ESI-MS ( $m/z$ ): calculated for C<sub>45</sub>H<sub>76</sub>N<sub>5</sub>O<sub>27</sub> [M+H]<sup>+</sup>: 1118.4728, found: 1118.4741

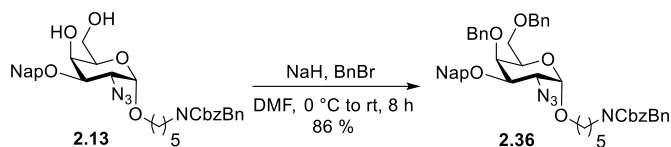
**5-Aminopentyl 2-acetamido-2-deoxy- $\alpha$ -D-galactopyranosyl-(1 $\rightarrow$ 3)-[ $\beta$ -D-glucopyranosyl-(1 $\rightarrow$ 2)]- $\beta$ -D-galactopyranosyl urinate-(1 $\rightarrow$ 3)-2-acetamido-2-deoxy- $\alpha$ -D-galactopyranosyl-(1 $\rightarrow$ 3)-2,4-di-acetamido-2,4,6-tri-deoxy- $\alpha$ -D-glucopyranosyl (2.2)**



Pentasaccharide **2.35** (20 mg, 0.009 mmol) was dissolved in a mixture of THF/AcOH (2/1/1, *v/v/v*, 3 mL) and added freshly activated zinc (200 mg). After stirring for 12 h at rt, the mixture was diluted with ethyl acetate and filtered over Celite® 353, evaporated *in vacuo* and dried in vacuum for 2h. To a solution of crude in THF (3 mL) was added HF·Py (70% HF, 12  $\mu\text{L}$ , 0.09 mmol). After TLC analysis indicated complete conversion of the starting material (~8 hours), the reaction was quenched with Et<sub>3</sub>N (0.5 mL). The mixture was concentrated, dissolved in EtOAc and subsequently washed with saturated aqueous NaHCO<sub>3</sub> and brine. The aqueous layers were then extracted with EtOAc, combined organic layers were dried over Na<sub>2</sub>SO<sub>4</sub>, filtered and concentrated *in vacuo*. The crude was dissolved in DCM (2 mL), N<sub>2</sub>H<sub>4</sub>·AcOH (8 mg, 0.09 mmol) was added and the mixture was stirred at rt for 12 h. The reaction was quenched by the addition of acetone (1 mL) and the solvent was removed under vacuum. The crude was filtered through a small bed of silica gel, evaporated *in vacuo*. The triol intermediate was dissolved in the solution of EtOAc/*t*-BuOH/H<sub>2</sub>O (2/1/1, *v/v/v*, 2 mL) and Pd/C (50 mg) was added to the solution. After stirring for 12 h under hydrogen atmosphere (1 atm, balloon), the mixture was filtered through a PTFE filter (0.45  $\mu\text{m}$  pore size) and concentrated. The crude material was purified by HPLC (Hypercarb column,

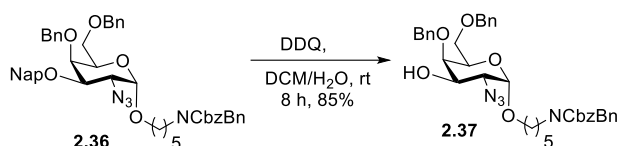
150 x 10 mm, H<sub>2</sub>O (0.1% formic acid) isocratic (5 min), linear gradient to 30% ACN (30 min), linear gradient to 100% ACN (10 min)) and lyophilized to obtain pure pentasaccharide **2.2** (1.1 mg, 11%). <sup>1</sup>H NMR (700 MHz, D<sub>2</sub>O) δ 5.19 (dd, *J* = 18.6, 3.9 Hz, 2H), 4.86 – 4.82 (m, 1H), 4.72 (d, *J* = 7.8 Hz, 1H), 4.58 (d, *J* = 7.3 Hz, 1H), 4.48 – 4.44 (m, 1H), 4.38 (d, *J* = 3.0 Hz, 1H), 4.32 (dd, *J* = 8.2, 4.2 Hz, 1H), 4.27 (dd, *J* = 11.1, 3.8 Hz, 2H), 4.12 – 4.08 (m, 1H), 4.06 – 3.98 (m, 6H), 3.95 (t, *J* = 6.4 Hz, 1H), 3.90 (d, *J* = 12.0 Hz, 1H), 3.85 – 3.78 (m, 6H), 3.75 (dd, *J* = 12.1, 4.1 Hz, 1H), 3.70 (d, *J* = 9.1 Hz, 1H), 3.66 (dd, *J* = 12.3, 7.0 Hz, 1H), 3.54 – 3.49 (m, 1H), 3.48 – 3.41 (m, 2H), 3.31 (t, *J* = 9.5 Hz, 1H), 3.24 (t, *J* = 8.8 Hz, 1H), 3.01 (t, *J* = 7.8 Hz, 2H), 2.05 (s, 2H), 2.05 (s, 3H), 2.04 (s, 3H), 1.98 (s, 3H), 1.73 – 1.63 (m, 4H), 1.45 (q, *J* = 8.2 Hz, 2H), 1.16 (d, *J* = 5.4 Hz, 3H). <sup>13</sup>C NMR (176 MHz, D<sub>2</sub>O) δ 174.9, 174.7, 174.3, 173.3, 102.5, 102.0, 96.8, 96.5, 91.8, 77.1, 76.1, 76.0, 75.4, 75.4, 73.4, 73.2, 71.1, 70.5, 70.1, 68.7, 68.0, 67.9, 67.7, 65.0, 61.4, 61.3, 61.0, 52.8, 49.5, 48.1, 39.4, 28.0, 26.5, 22.8, 22.3, 22.1, 22.0, 16.3. HR-ESI-MS (*m/z*): calculated for C<sub>43</sub>H<sub>74</sub>N<sub>5</sub>O<sub>26</sub> [M+H]<sup>+</sup>: 1076.4622, found: 1076.4631

***N*-(Benzyl)benzyloxycarbonyl-5-aminopentyl 2-azido-4,6-*O*-di-benzyl-2-deoxy-3-*O*-(2-naphthylmethyl)- $\alpha$ -D-galactopyranoside (**2.36**)**



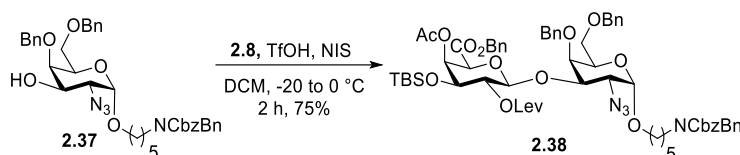
To a solution of diol **2.13** (653 mg, 1.12 mmol) in DMF (2 mL) was cooled to 0 °C and treated with NaH (60% disp.) (112 mg, 2.80 mmol). The mixture was stirred for 20 min before benzyl bromide (0.332 mL, 2.80 mmol) was added. After stirring for 8 h, quenched with aqueous saturated NH<sub>4</sub>Cl and diluted with EtOAc. The organic layer was washed with H<sub>2</sub>O and brine, dried over Na<sub>2</sub>SO<sub>4</sub> and concentrated *in vacuo*. The crude was purified by silica gel column chromatography using 8% ethyl acetate in hexanes to yield the desired compound **2.36** (734 mg, 86%). <sup>1</sup>H NMR (400 MHz, CDCl<sub>3</sub>) δ 7.91 – 7.80 (m, 4H), 7.55 (dd, *J* = 8.5, 1.7 Hz, 1H), 7.52 – 7.48 (m, 2H), 7.42 – 7.26 (m, 19H), 7.20 (d, *J* = 7.2 Hz, 1H), 5.21 (d, *J* = 12.6 Hz, 2H), 4.98 – 4.84 (m, 4H), 4.61 (d, *J* = 11.3 Hz, 1H), 4.52 (t, *J* = 6.2 Hz, 3H), 4.46 (d, *J* = 11.7 Hz, 1H), 4.11 (s, 1H), 4.07 – 3.94 (m, 2H), 3.91 (dd, *J* = 10.6, 3.5 Hz, 1H), 3.74 – 3.54 (m, 3H), 3.50 – 3.35 (m, 1H), 3.34 – 3.18 (m, 2H), 1.69 – 1.47 (m, 54), 1.43 – 1.31 (m, 2H). <sup>13</sup>C NMR (101 MHz, CDCl<sub>3</sub>) δ 156.8, 156.3, 138.4, 138.0, 137.9, 137.0, 136.9, 135.2, 133.4, 133.1, 128.6, 128.6, 128.5, 128.4, 128.2, 128.1, 128.0, 127.9, 127.8, 127.4, 127.3, 126.6, 126.2, 126.1, 125.8, 98.2, 77.5, 77.4, 77.2, 76.8, 74.9, 73.6, 73.5, 72.3, 69.7, 68.9, 68.2, 67.2, 59.9, 50.6, 50.3, 47.2, 46.2, 29.8, 29.2, 27.9, 27.5, 23.5, 1.1. HR-ESI-MS (*m/z*): calculated for C<sub>51</sub>H<sub>54</sub>N<sub>4</sub>O<sub>7</sub>Na [M+Na]<sup>+</sup>: 857.3890, found: 857.3898

***N*-(Benzyl)benzyloxycarbonyl-5-aminopentyl 2-azido-4,6-*O*-di-benzyl-2-deoxy- $\alpha$ -D-galactopyranoside (**2.37**)**



To a well stirred emulsion of **2.36** (500 g, 0.598 mmol) in DCM and H<sub>2</sub>O (7/1, v/v, 8 mL) was added DDQ (203 mg, 0.897 mmol) and stirred at rt for 8 h. The mixture was diluted with DCM (20 mL) and washed (2 x 20 mL) with 10% aqueous Na<sub>2</sub>S<sub>3</sub>O<sub>3</sub> to reduce the remaining DDQ. The organic layer was dried over Na<sub>2</sub>SO<sub>4</sub>, filtered and concentrated *in vacuo*. The residue was purified by silica column chromatography using 10% ethyl acetate in hexanes to afford product **2.37** (353 mg, 85%) as yellowish liquid. <sup>1</sup>H NMR (400 MHz, CDCl<sub>3</sub>) δ 7.30 – 7.11 (m, 19H), 7.07 (d, *J* = 7.3 Hz, 1H), 5.08 (d, *J* = 13.4 Hz, 2H), 4.81 – 4.73 (m, 1H), 4.59 (d, *J* = 1.8 Hz, 2H), 4.48 – 4.35 (m, 4H), 3.98 – 3.86 (m, 2H), 3.82 (d, *J* = 4.7 Hz, 1H), 3.61 – 3.43 (m, 3H), 3.33 (dd, *J* = 10.6, 3.5 Hz, 2H), 3.21 – 3.02 (m, 2H), 2.16 (bs, 1H), 1.57 – 1.36 (m, 4H), 1.29 – 1.20 (m, 2H). <sup>13</sup>C NMR (101 MHz, CDCl<sub>3</sub>) δ 156.8, 156.2, 138.0, 137.9, 137.9, 137.7, 136.9, 136.8, 128.7, 128.6, 128.5, 128.5, 128.3, 128.3, 128.3, 128.2, 128.1, 128.0, 128.0, 127.9, 127.9, 127.4, 127.3, 127.2, 98.2, 77.5, 77.4, 77.2, 76.9, 76.8, 75.5, 73.6, 69.3, 68.5, 68.5, 68.2, 68.1, 67.2, 67.2, 67.2, 61.1, 50.5, 50.2, 47.1, 46.2, 29.8, 29.1, 27.9, 27.5, 23.4, 23.3. HR-ESI-MS (*m/z*): calculated for C<sub>40</sub>H<sub>46</sub>N<sub>4</sub>O<sub>7</sub>Na [M+Na]<sup>+</sup>: 717.3264, found: 717.3271

***N*-(Benzyl)benzyloxycarbonyl-5-aminopentyl dimethylsilyl-2-*O*-levulinoyl-β-*D*-galactopyranosyl uronate-(1→3)-2-azido-4,6-*O*-di-benzyl-2-deoxy-α-*D*-galactopyranoside (**2.38**)**

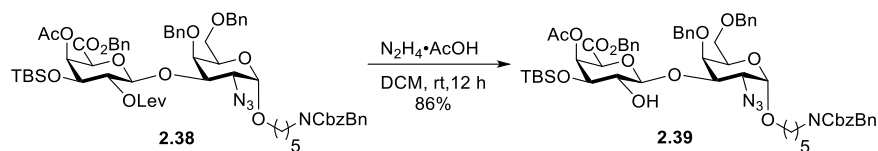


Acceptor **2.37** (50 mg, 0.072 mmol) and donor **2.8** (63 mg 0.108 mmol) were mixed, co-evaporated with toluene (3 x 10 mL), dried under high vacuum overnight and then dissolved in DCM under nitrogen atmosphere. Freshly activated 4Å molecular sieves were added and stirred for 30 min at rt. The mixture was cooled to -20 °C, to this stirred suspension, NIS (24 mg; 0.108 mmol) and TfOH (3.2 μL, 36 μmol) were slowly added. After being stirred at -20 °C for 2 h, diluted with DCM (10 mL), quenched with Et<sub>3</sub>N, warmed to rt and 4Å molecular sieves were filtered. The filtrate was washed with 10% aqueous Na<sub>2</sub>S<sub>2</sub>O<sub>3</sub>, saturated aqueous NaHCO<sub>3</sub> and brine. The combined organic layer was dried over Na<sub>2</sub>SO<sub>4</sub>, filtered and evaporated *in vacuo*. The crude product was purified by silica gel column chromatography using 10% ethyl acetate in hexanes to afford the desired protected disaccharide **2.38** (66 mg, 75%) <sup>1</sup>H NMR (700 MHz, CDCl<sub>3</sub>) δ 7.34 (d, *J* = 7.5 Hz, 2H), 7.32 – 7.16 (m, 24H), 7.10 (d, *J* = 7.5 Hz, 1H), 5.52 (d, *J* = 3.6 Hz, 1H), 5.17 – 5.06 (m, 4H), 5.02 – 4.95 (m, 2H), 4.84 (d, *J* = 7.2 Hz, 1H), 4.64 (d, *J* = 8.0 Hz, 1H), 4.57 (d, *J* = 11.6 Hz, 1H), 4.45 – 4.36 (m, 3H), 4.30 (d, *J* = 11.8 Hz, 1H), 4.23 (s, 1H), 4.17 (d, *J* = 3.0 Hz, 1H), 4.01 (d, *J* = 10.8 Hz, 1H), 3.89 – 3.82 (m, 2H), 3.67 (d, *J* = 10.7 Hz, 1H), 3.63 – 3.53 (m,



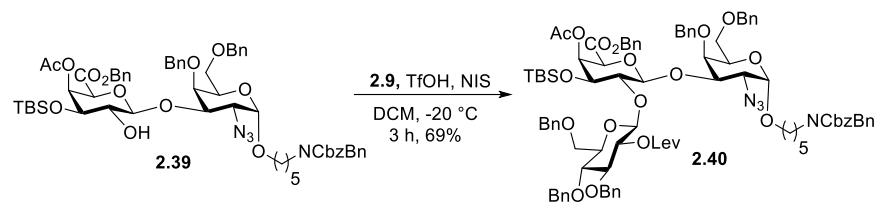
1H), 3.48 – 3.43 (m, 1H), 3.40 – 3.27 (m, 2H), 3.24 – 3.10 (m, 2H), 2.72 – 2.66 (m, 1H), 2.66 – 2.59 (m, 3H), 2.08 (s, 3H), 1.81 (s, 3H), 1.56 – 1.40 (m, 4H), 1.30 – 1.19 (m, 2H), 0.76 (s, 9H), 0.05 (s, 3H), 0.03 (s, 3H). <sup>13</sup>C NMR (176 MHz, CDCl<sub>3</sub>) δ 206.3, 171.6, 169.6, 166.2, 156.8, 156.3, 139.0, 138.2, 138.0, 135.1, 129.0, 128.8, 128.8, 128.7, 128.7, 128.6, 128.6, 128.5, 128.5, 128.4, 128.3, 128.0, 127.9, 127.8, 127.7, 127.6, 127.4, 127.3, 102.2, 98.3, 77.7, 77.3, 77.2, 77.0, 76.4, 74.9, 73.5, 72.6, 72.0, 70.7, 70.5, 69.9, 69.5, 68.2, 68.1, 67.6, 67.3, 59.8, 50.6, 50.3, 47.2, 46.1, 37.9, 30.0, 29.8, 29.2, 29.2, 28.0, 27.9, 27.6, 25.7, 25.5, 25.5, 25.4, 23.5, 23.4, 20.5, 18.0, 17.8, 17.6, 1.1, -4.5, -4.6, -4.8, -4.8, -4.9, -5.1. HR-ESI-MS (m/z): calculated for C<sub>66</sub>H<sub>82</sub>N<sub>4</sub>O<sub>16</sub>SiNa [M+Na]<sup>+</sup>: 1237.5393, found: 1237.5383

***N*-(Benzyl)benzyloxycarbonyl-5-aminopentyl dimethylsilyl-β-D-galactopyranosyl uronate-(1→3)-2-azido-4,6-*O*-di-benzyl-2-deoxy-α-D-galactopyranoside (2.39)**



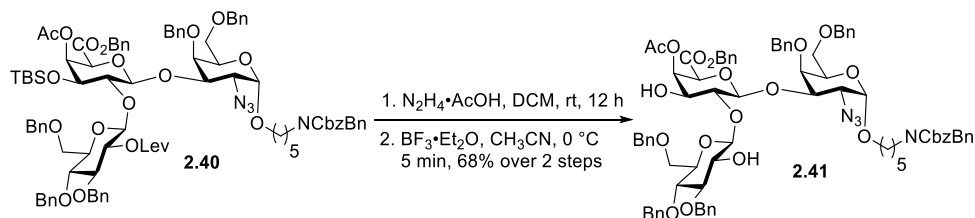
To a solution of disaccharide **2.38** (72 mg, 0.059 mmol) in DCM (5 mL) was added N<sub>2</sub>H<sub>4</sub>•AcOH (27 mg, 0.296 mmol) and the mixture was stirred at rt overnight. The reaction was quenched by the addition of acetone (1 mL) and the solvent was removed under vacuum. The residue was purified by silica gel chromatography using 15% ethyl acetate in hexanes to give product **2.39** (56 mg, 86%) as colorless syrup. <sup>1</sup>H NMR (700 MHz, CDCl<sub>3</sub>) δ 7.29 (d, *J* = 7.4 Hz, 2H), 7.26 – 7.11 (m, 24H), 7.05 (d, *J* = 7.5 Hz, 1H), 5.45 (d, *J* = 3.7 Hz, 1H), 5.05 (q, *J* = 9.8 Hz, 3H), 4.92 (dd, *J* = 12.0, 5.1 Hz, 2H), 4.80 (d, *J* = 10.9 Hz, 1H), 4.57 (d, *J* = 12.0 Hz, 1H), 4.45 (d, *J* = 7.6 Hz, 1H), 4.40 – 4.30 (m, 3H), 4.24 (d, *J* = 11.9 Hz, 1H), 4.19 – 4.15 (m, 2H), 4.03 – 3.96 (m, 1H), 3.86 – 3.80 (m, 1H), 3.73 (dd, *J* = 10.7, 3.6 Hz, 1H), 3.67 (dd, *J* = 9.3, 3.7 Hz, 1H), 3.59 – 3.48 (m, 2H), 3.40 (dd, *J* = 9.7, 6.3 Hz, 1H), 3.32 – 3.21 (m, 2H), 3.19 – 3.03 (m, 2H), 2.37 (bs, 1H), 1.74 (s, 3H), 1.52 – 1.36 (m, 4H), 1.25 – 1.17 (m, 2H), 0.76 (s, 9H), 0.03 (s, 3H), 0.00 (s, 3H). <sup>13</sup>C NMR (176 MHz, CDCl<sub>3</sub>) δ 169.6, 166.5, 156.9, 156.3, 139.0, 138.2, 138.0, 137.0, 136.9, 135.2, 129.0, 128.8, 128.8, 128.7, 128.7, 128.6, 128.6, 128.5, 128.4, 128.4, 128.3, 128.3, 128.2, 128.0, 127.9, 127.9, 127.8, 127.7, 127.6, 127.4, 127.3, 104.9, 98.0, 79.4, 77.3, 77.2, 77.1, 77.0, 76.6, 75.0, 73.5, 72.7, 72.4, 72.2, 70.6, 69.8, 69.5, 68.2, 68.1, 67.5, 67.3, 60.5, 59.8, 50.6, 50.3, 47.2, 46.2, 29.2, 29.2, 28.0, 27.6, 25.7, 23.5, 23.4, 21.2, 20.5, 18.2, 14.3, 1.1, -4.5, -4.9. HR-ESI-MS (m/z): calculated for C<sub>61</sub>H<sub>76</sub>N<sub>4</sub>O<sub>14</sub>SiNa [M+Na]<sup>+</sup>: 1139.5025, found: 1139.5033

***N*-(Benzyl)benzyloxycarbonyl-5-aminopentyl 3,4,6-tri-*O*-benzyl-2-*O*-levulinoyl-β-D-glucopyranosyl-(1→2)-4-*O*-acetyl-6-*O*-benzyl-3-*tert*-butyl dimethylsilyl-β-D-galactopyranosyl uronate-(1→3)-2-azido-4,6-di-*O*-benzyl-2-deoxy-α-D-galactopyranoside (2.40)**



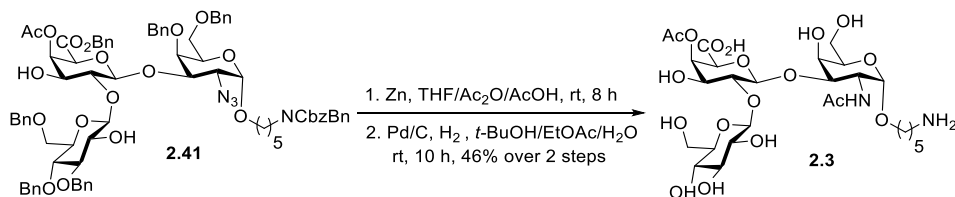
Acceptor **2.39** (48 mg, 0.072 mmol) and donor **2.9** (42 mg, 0.064 mmol) were mixed, co-evaporated with toluene (3 x 10 mL) and dried under high vacuum for 2 h. Freshly activated 4Å molecular sieves were added, dissolved in anhydrous DCM (12 mL) under a nitrogen atmosphere and stirred for 30 min at rt. The mixture was cooled to -20 °C, to this stirred suspension, NIS (16.4 mg, 0.073 mmol) and TfOH (1.5 µL, 17 µmol) were slowly added. After being stirred at -20 °C for 3 h, diluted with DCM (10 mL), quenched with Et<sub>3</sub>N, warmed to rt and 4Å molecular sieves were filtered. The filtrate was washed with 10% aqueous Na<sub>2</sub>S<sub>2</sub>O<sub>3</sub>, saturated aqueous NaHCO<sub>3</sub> and brine. The combined organic layer was dried over Na<sub>2</sub>SO<sub>4</sub>, filtered and evaporated *in vacuo*. The crude product was purified by silica gel column chromatography using 15% ethyl acetate in hexanes to afford the desired protected trisaccharide **2.40** (49 mg, 69%). <sup>1</sup>H NMR (700 MHz, CDCl<sub>3</sub>) δ 7.36 (d, *J* = 7.4 Hz, 2H), 7.30 – 7.18 (m, 36H), 7.15 – 7.09 (m, 4H), 5.38 (d, *J* = 3.3 Hz, 1H), 5.10 (t, *J* = 13.2 Hz, 3H), 5.07 – 5.03 (m, 1H), 5.01 (d, *J* = 11.9 Hz, 1H), 4.96 – 4.92 (m, 2H), 4.73 – 4.67 (m, 4H), 4.63 (dd, *J* = 15.4, 11.5 Hz, 2H), 4.50 (dd, *J* = 13.6, 11.3 Hz, 2H), 4.45 – 4.38 (m, 4H), 4.32 – 4.28 (m, 2H), 4.21 (d, *J* = 3.0 Hz, 1H), 4.09 (s, 1H), 4.02 – 3.95 (m, 3H), 3.90 – 3.83 (m, 1H), 3.69 – 3.60 (m, 3H), 3.55 – 3.51 (m, 3H), 3.49 – 3.44 (m, 2H), 3.35 – 3.25 (m, 2H), 3.23 – 3.10 (m, 2H), 2.62 – 2.51 (m, 2H), 2.49 – 2.45 (m, 1H), 2.34 – 2.28 (m, 1H), 2.04 (s, 3H), 1.77 (s, 3H), 1.61 – 1.48 (m, 4H), 1.31 – 1.22 (m, 2H), 0.82 (s, 9H), 0.12 (s, 3H), 0.09 (s, 3H). <sup>13</sup>C NMR (176 MHz, CDCl<sub>3</sub>) δ 206.4, 171.3, 169.9, 166.7, 139.3, 138.5, 138.4, 138.3, 138.1, 135.2, 129.0, 128.7, 128.7, 128.7, 128.6, 128.6, 128.5, 128.5, 128.4, 128.4, 128.3, 128.3, 128.2, 128.1, 128.0, 128.0, 127.9, 127.9, 127.8, 127.7, 127.7, 127.6, 127.6, 127.5, 127.4, 102.2, 98.5, 83.4, 78.2, 77.3, 77.3, 77.2, 77.0, 76.7, 75.3, 75.1, 74.9, 74.9, 73.9, 73.6, 73.4, 73.1, 72.2, 71.3, 69.7, 69.7, 69.4, 67.6, 67.3, 59.6, 50.6, 50.4, 47.3, 46.3, 38.0, 30.0, 29.2, 28.1, 28.0, 27.6, 26.0, 23.5, 20.6, 18.0, 14.3, 1.2, -4.2, -4.3. HR-ESI-MS (*m/z*): calculated for C<sub>93</sub>H<sub>110</sub>N<sub>4</sub>O<sub>21</sub>SiNa [M+Na]<sup>+</sup>: 1669.7335, found: 1669.7331

***N*-(Benzyl)benzyloxycarbonyl-5-aminopentyl 3,4,6-tri-*O*-benzyl-β-D-glucopyranosyl-(1→2)-4-*O*-acetyl-6-*O*-benzyl-β-D-galactopyranosyl uronate-(1→3)-2-azido-4,6-di-*O*-benzyl-2-deoxy-α-D-galactopyranoside (2.42)**



To a solution of trisaccharide **2.40** (34 mg, 0.021 mmol) in DCM (4 mL) was added  $\text{N}_2\text{H}_4 \cdot \text{AcOH}$  (10 mg, 0.103 mmol) and the mixture was stirred at rt for 12 h. The reaction was quenched by the addition of acetone (2 mL) and the solvent was removed under vacuum. The crude was dissolved in anhydrous ACN (4 mL), cooled to 0 °C and  $\text{BF}_3 \cdot \text{OEt}_2$  (3.4  $\mu\text{mol}$ , 0.027 mmol) was added. After stirring for 5 min, saturated aqueous  $\text{NaHCO}_3$  was added and extracted the organic layer with DCM. The combined layers were dried over  $\text{Na}_2\text{SO}_4$ , filtered and evaporated *in vacuo*. The crude was purified by silica gel column chromatography using 45% ethyl acetate in hexanes to afford diol **2.41** (20 mg, 68% over two steps).  $^1\text{H}$  NMR (700 MHz,  $\text{CDCl}_3$ )  $\delta$  7.37 (d,  $J = 7.4$  Hz, 2H), 7.34 – 7.30 (m, 9H), 7.28 – 7.20 (m, 26H), 7.12 (dd,  $J = 7.4, 2.0$  Hz, 3H), 5.68 (d,  $J = 3.5$  Hz, 1H), 5.13 (d,  $J = 13.1$  Hz, 3H), 5.07 – 5.02 (m, 1H), 5.00 – 4.93 (m, 2H), 4.87 – 4.82 (m, 1H), 4.80 – 4.72 (m, 3H), 4.66 (d,  $J = 11.7$  Hz, 1H), 4.57 (d,  $J = 8.2$  Hz, 1H), 4.49 (dd,  $J = 11.5, 2.2$  Hz, 2H), 4.45 – 4.38 (m, 4H), 4.35 – 4.30 (m, 2H), 4.27 (s, 1H), 4.15 (s, 1H), 4.10 (t,  $J = 9.2$  Hz, 1H), 3.95 – 3.90 (m, 1H), 3.84 – 3.78 (m, 2H), 3.72 – 3.66 (m, 2H), 3.63 – 3.55 (m, 6H), 3.51 – 3.44 (m, 2H), 3.38 (dd,  $J = 9.7, 6.0$  Hz, 1H), 3.25 – 3.12 (m, 2H), 1.76 (s, 3H), 1.59 – 1.49 (m, 4H), 1.32 – 1.25 (m, 2H).  $^{13}\text{C}$  NMR (176 MHz,  $\text{CDCl}_3$ )  $\delta$  170.0, 166.3, 156.9, 156.3, 139.0, 138.9, 138.2, 138.2, 138.1, 138.0, 137.0, 136.9, 135.1, 129.0, 128.8, 128.7, 128.6, 128.6, 128.5, 128.5, 128.5, 128.4, 128.1, 128.1, 128.0, 128.0, 127.9, 127.8, 127.8, 127.8, 127.7, 127.7, 127.7, 127.4, 127.3, 102.4, 101.6, 98.4, 84.4, 77.6, 77.3, 77.2, 77.0, 76.9, 75.7, 75.6, 75.3, 75.3, 75.2, 73.6, 73.5, 72.6, 72.6, 71.0, 70.0, 69.8, 69.4, 68.6, 68.3, 68.1, 67.6, 67.3, 50.6, 50.4, 47.2, 46.1, 29.8, 29.3, 29.2, 27.9, 27.6, 23.5, 23.4, 20.6. HR-ESI-MS ( $m/z$ ): calculated for  $\text{C}_{87}\text{H}_{96}\text{N}_4\text{O}_{21}\text{Na}$   $[\text{M}+\text{Na}]^+$ : 1555.6465, found: 1555.6461.

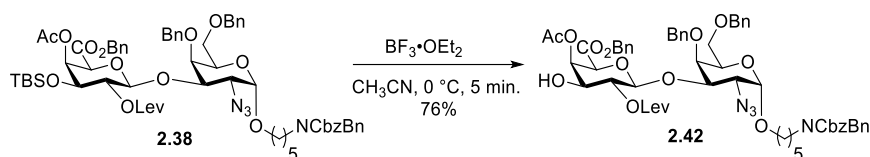
**5-Aminopentyl  $\beta$ -D-glucopyranosyl-(1 $\rightarrow$ 2) -4-O-acetyl- $\beta$ -D-galactopyranosyl uronate-(1 $\rightarrow$ 3)-2-acetamido-2-deoxy- $\alpha$ -D-galactopyranoside (2.3)**



The diol **2.41** (16 mg, 0.011 mmol) intermediate was dissolved in the solution of THF/ $\text{Ac}_2\text{O}$ / $\text{AcOH}$  (3/2/1,  $v/v/v$ , 3 mL) and added freshly activated zinc (200 mg). After stirring for 8 h at rt, the mixture was diluted with ethyl acetate and filtered over Celite® 353 and evaporated *in vacuo*. The crude product was dissolved in the solution of  $\text{EtOAc}/t\text{-BuOH}/\text{H}_2\text{O}$  (2/1/1,  $v/v/v$ , 2 mL) and Pd/C (50 mg) was added to the solution. After stirring for 10 h under hydrogen atmosphere (1 atm, balloon), the mixture was filtered through a PTFE filter (0.45  $\mu\text{m}$  pore size) and concentrated. The crude material was purified by HPLC (Hypercarb column, 150 x10 mm,  $\text{H}_2\text{O}$  (0.1% formic acid) isocratic (5 min), linear gradient to 10% ACN (30 min), linear gradient to 100% ACN (10 min)) and lyophilized to obtain pure trisaccharide **2.3** (4.8 mg, 46% over two steps).  $^1\text{H}$  NMR (700 MHz,  $\text{D}_2\text{O}$ )  $\delta$  5.55 (dd,  $J = 3.7, 1.2$  Hz, 1H), 4.89 (d,  $J = 3.8$  Hz, 1H), 4.81 (s, 1H), 4.67 (d,  $J = 7.8$  Hz, 1H), 4.35 – 4.30 (m, 2H), 4.17 (d,  $J = 1.3$  Hz, 1H), 4.12 (dd,  $J = 9.6, 3.7$  Hz, 1H), 4.05 (dd,  $J =$

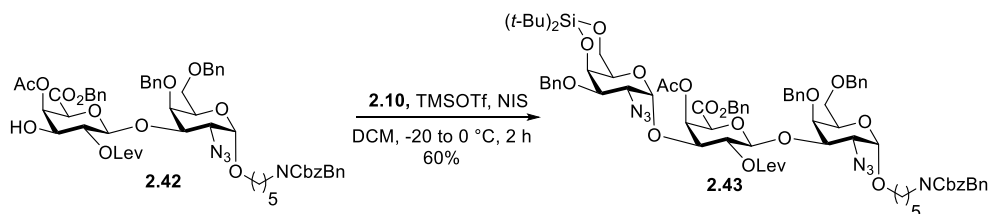
11.1, 3.1 Hz, 1H), 4.00 – 3.97 (m, 1H), 3.92 – 3.89 (m, 1H), 3.84 (dd,  $J = 9.6, 7.8$  Hz, 1H), 3.80 – 3.75 (m, 2H), 3.71 (ddd,  $J = 10.0, 4.5, 1.6$  Hz, 2H), 3.52 – 3.47 (m, 2H), 3.40 – 3.36 (m, 2H), 3.26 – 3.17 (m, 2H), 3.01 (t,  $J = 7.6$  Hz, 2H), 2.14 (s, 3H), 2.04 (s, 3H), 1.72 – 1.62 (m, 4H), 1.48 – 1.44 (m, 2H).  $^{13}\text{C}$  NMR (176 MHz,  $\text{D}_2\text{O}$ )  $\delta$  173.8, 173.7, 173.1, 102.0, 101.9, 97.1, 76.8, 76.3, 76.0, 75.8, 73.7, 73.6, 72.6, 72.4, 70.8, 69.6, 68.5, 67.6, 61.3, 60.8, 48.8, 46.7, 39.4, 28.0, 26.4, 22.4, 22.3, 20.3, 8.2. HR-ESI-MS ( $m/z$ ): calculated for  $\text{C}_{27}\text{H}_{47}\text{N}_2\text{O}_{18}$   $[\text{M}+\text{H}]^+$ : 687.2824, found: 687.2829

***N*-(Benzyl)benzyloxycarbonyl-5-aminopentyl 4-*O*-acetyl-6-*O*-benzyl-2-*O*-levulinoyl- $\beta$ -*D*-galactopyranosyl uronate-(1 $\rightarrow$ 3)-2-azido-4,6-di-*O*-benzyl-2-deoxy- $\alpha$ -*D*-galactopyranoside (2.42)**



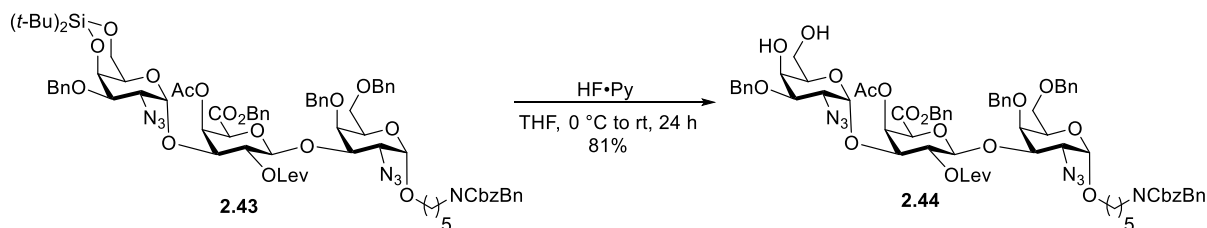
Disaccharide **2.38** (36 mg, 0.03 mmol) was dissolved in anhydrous ACN (5 mL) under a nitrogen atmosphere at 0 °C and to this,  $\text{BF}_3 \cdot \text{OEt}_2$  (4.8  $\mu\text{L}$ , 0.038 mmol) was added dropwise. After stirring for 5 min, quenched with saturated aqueous  $\text{NaHCO}_3$ , extracted the organic layer with DCM. The combined organic layer was dried over  $\text{Na}_2\text{SO}_4$ , filtered and evaporated *in vacuo*. The crude was purified by silica gel column chromatography using 15% ethyl acetate in hexanes to afford compound **2.42** (24 mg, 76%).  $^1\text{H}$  NMR (400 MHz,  $\text{CDCl}_3$ )  $\delta$  7.37 – 7.32 (m, 2H), 7.30 – 7.26 (m, 4H), 7.25 – 7.14 (m, 18H), 7.09 (d,  $J = 7.1$  Hz, 1H), 5.61 (dd,  $J = 3.5, 1.3$  Hz, 1H), 5.13 – 5.07 (m, 3H), 5.01 (d,  $J = 4.7$  Hz, 1H), 4.97 (d,  $J = 11.6$  Hz, 1H), 4.81 (s, 1H), 4.73 (d,  $J = 7.8$  Hz, 1H), 4.59 (d,  $J = 11.6$  Hz, 1H), 4.45 – 4.34 (m, 3H), 4.29 (d,  $J = 11.8$  Hz, 1H), 4.25 – 4.18 (m, 2H), 4.03 – 3.96 (m, 1H), 3.92 – 3.83 (m, 2H), 3.72 (dd,  $J = 10.7, 3.5$  Hz, 1H), 3.62 – 3.50 (m, 1H), 3.45 (dd,  $J = 9.6, 6.3$  Hz, 1H), 3.39 – 3.24 (m, 2H), 3.22 – 3.07 (m, 3H), 2.86 – 2.77 (m, 1H), 2.71 – 2.62 (m, 1H), 2.59 – 2.46 (m, 2H), 2.09 (s, 3H), 1.82 (s, 3H), 1.57 – 1.41 (m, 4H), 1.30 – 1.20 (m, 2H).  $^{13}\text{C}$  NMR (101 MHz,  $\text{CDCl}_3$ )  $\delta$  207.9, 172.9, 170.3, 166.1, 138.9, 138.2, 138.0, 137.0, 136.8, 135.0, 129.0, 128.8, 128.8, 128.8, 128.7, 128.6, 128.5, 128.4, 128.3, 128.3, 128.0, 127.9, 127.9, 127.8, 127.7, 127.7, 127.4, 127.3, 101.9, 98.1, 78.8, 77.5, 77.4, 77.2, 76.8, 76.5, 76.5, 75.1, 73.5, 72.7, 72.5, 71.0, 70.4, 69.8, 69.4, 68.1, 68.0, 67.6, 67.3, 60.0, 50.5, 50.3, 47.2, 46.1, 38.6, 32.0, 30.4, 29.9, 29.8, 29.8, 29.7, 29.5, 29.4, 29.2, 29.2, 29.1, 28.2, 27.9, 27.6, 23.5, 23.4, 22.8, 20.6, 14.3. HR-ESI-MS ( $m/z$ ): calculated for  $\text{C}_{60}\text{H}_{68}\text{N}_4\text{O}_{16}\text{Na}$   $[\text{M}+\text{Na}]^+$ : 1123.4528, found: 1123.4534

***N*-(Benzyl)benzyloxycarbonyl-5-aminopentyl 2-azido-2-deoxy-3-*O*-(2-naphthylmethyl)-4,6-*O*-silylidene- $\alpha$ -*D*-galactopyranosyl-(1 $\rightarrow$ 3)-4-*O*-acetyl-6-*O*-benzyl-2-*O*-levulinoyl- $\beta$ -*D*-galactopyranosyl uronate-(1 $\rightarrow$ 3)-2-azido-4,6-di-*O*-benzyl-2-deoxy- $\alpha$ -*D*-galactopyranoside (2.43)**



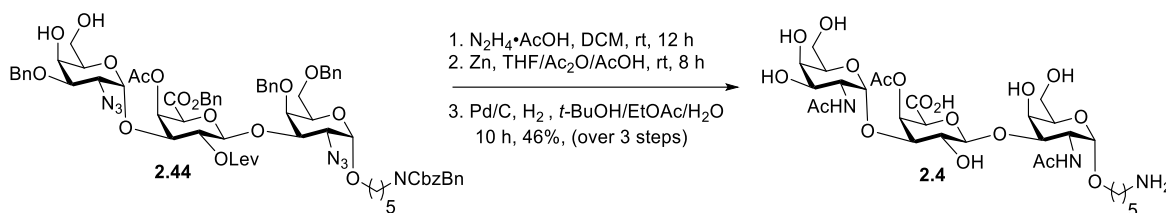
To a solution of acceptor **2.42** (48 mg, 0.044 mmol) and donor **2.10** (38 mg, 0.065 mmol) in DCM (5 mL) was added activated 4Å molecular sieves. After ~30 minutes of stirring at rt, the mixture was cooled to 0 °C, to this, NIS (15 mg, 0.065 mmol) and TMSOTf (1.9 μL, 0.022 mmol) were slowly added. After TLC analysis indicated complete consumption of the starting material (~2 hours), the reaction was quenched with Et<sub>3</sub>N (2 mL) and the mixture was diluted with DCM. After filtration over Celite® 353, the mixture was washed with saturated aqueous Na<sub>2</sub>S<sub>2</sub>O<sub>3</sub>, saturated aqueous NaHCO<sub>3</sub> and brine, dried over Na<sub>2</sub>SO<sub>4</sub>, filtered and concentrated *in vacuo*. The residue was purified by silica column chromatography using 12% ethyl acetate in hexanes to afford the title product **2.43** (40 mg, 60%) as the sole isomer. <sup>1</sup>H NMR (400 MHz, CDCl<sub>3</sub>) δ 7.39 – 7.31 (m, 4H), 7.30 – 7.16 (m, 26H), 7.10 (d, *J* = 7.3 Hz, 1H), 5.83 – 5.80 (m, 1H), 5.26 (dd, *J* = 10.1, 7.8 Hz, 1H), 5.12 – 5.06 (m, 3H), 5.03 (d, *J* = 8.0 Hz, 2H), 4.99 – 4.92 (m, 2H), 4.84 – 4.80 (m, 1H), 4.75 – 4.66 (m, 2H), 4.58 (dd, *J* = 11.5, 8.9 Hz, 2H), 4.44 – 4.36 (m, 3H), 4.33 – 4.27 (m, 2H), 4.22 (d, *J* = 3.4 Hz, 2H), 4.15 (d, *J* = 12.3 Hz, 1H), 4.01 (dd, *J* = 10.1, 3.4 Hz, 2H), 3.90 – 3.83 (m, 2H), 3.83 – 3.75 (m, 2H), 3.67 – 3.55 (m, 2H), 3.49 – 3.43 (m, 1H), 3.40 – 3.25 (m, 2H), 3.23 – 3.09 (m, 2H), 2.91 (dd, *J* = 15.2, 10.7 Hz, 1H), 2.53 – 2.42 (m, 1H), 2.41 – 2.31 (m, 2H), 2.05 (s, 3H), 1.87 (s, 3H), 1.56 – 1.41 (m, 4H), 1.32 – 1.23 (m, 2H), 1.02 (s, 9H), 0.99 (s, 9H). <sup>13</sup>C NMR (101 MHz, CDCl<sub>3</sub>) δ 206.7, 171.1, 169.9, 165.8, 156.8, 156.2, 138.8, 138.4, 138.1, 137.9, 136.9, 136.8, 134.7, 129.1, 129.0, 128.9, 128.8, 128.7, 128.7, 128.6, 128.6, 128.5, 128.5, 128.4, 128.4, 128.3, 128.3, 128.3, 128.0, 127.9, 127.9, 127.8, 127.7, 127.7, 127.6, 127.4, 127.3, 127.2, 102.3, 98.2, 94.2, 78.0, 77.5, 77.4, 77.2, 76.8, 76.3, 75.8, 75.0, 73.4, 72.4, 71.6, 70.4, 70.1, 69.8, 69.4, 69.3, 68.1, 67.9, 67.7, 67.2, 67.1, 65.5, 60.5, 59.8, 57.9, 50.4, 50.2, 47.1, 46.0, 37.3, 32.0, 30.0, 29.8, 29.7, 29.7, 29.4, 29.2, 29.1, 28.0, 28.0, 27.8, 27.8, 27.6, 27.6, 27.5, 27.4, 23.4, 23.3, 22.8, 21.1, 20.7, 20.3, 14.3, 14.2. HR-ESI-MS (*m/z*): calculated for C<sub>81</sub>H<sub>99</sub>N<sub>7</sub>O<sub>20</sub>SiNa [M+Na]<sup>+</sup>: 1540.6612, found: 1540.6619.

***N*-(Benzyl)benzyloxycarbonyl-5-aminopentyl 2-azido-2-deoxy-3-*O*-(2-naphthylmethyl)-α-*D*-galactopyranosyl-(1→3)-4-*O*-acetyl-6-*O*-benzyl-2-*O*-levulinoyl-β-*D*-galactopyranosyl uronate-(1→3)-2-azido-4,6-di-*O*-benzyl-2-deoxy-α-*D*-galactopyranoside (2.44)**



To a solution of trisaccharide **2.43** (140 mg, 0.092 mmol) in THF (5 mL) was added HF•Py (70% HF, 0.083 mL, 0.922 mmol) at 0 °C. After TLC analysis indicated complete conversion of the starting material (~12 hours), the reaction was quenched with Et<sub>3</sub>N (2 mL). The mixture was concentrated, dissolved in EtOAc and subsequently washed with saturated aqueous NaHCO<sub>3</sub> and brine. The aqueous layers were then extracted with EtOAc combined organic layers were dried over Na<sub>2</sub>SO<sub>4</sub>, filtered and concentrated *in vacuo*. The residue was purified by silica column chromatography using 50% ethyl acetate in hexanes to furnish the title compound **2.44** (103 mg, 81%). <sup>1</sup>H NMR (400 MHz, CDCl<sub>3</sub>) δ 7.42 – 7.37 (m, 5H), 7.36 (d, *J* = 1.0 Hz, 2H), 7.35 – 7.27 (m, 21H), 7.26 – 7.22 (m, 2H), 7.16 (d, *J* = 6.8 Hz, 1H), 5.86 – 5.83 (m, 1H), 5.32 (dd, *J* = 10.1, 7.8 Hz, 1H), 5.20 – 5.14 (m, 3H), 5.13 – 5.06 (m, 2H), 5.03 (d, *J* = 11.6 Hz, 1H), 4.89 (s, 1H), 4.80 – 4.68 (m, 3H), 4.65 (d, *J* = 11.6 Hz, 1H), 4.54 – 4.45 (m, 4H), 4.36 (d, *J* = 11.8 Hz, 1H), 4.28 (t, *J* = 2.5 Hz, 2H), 4.11 – 4.04 (m, 3H), 4.02 – 3.94 (m, 2H), 3.93 – 3.86 (m, 2H), 3.72 (ddd, *J* = 11.8, 8.3, 3.5 Hz, 2H), 3.65 (s, 1H), 3.52 (dd, *J* = 9.6, 6.3 Hz, 1H), 3.42 (dd, *J* = 9.7, 6.0 Hz, 2H), 3.30 – 3.16 (m, 2H), 3.03 – 2.93 (m, 1H), 2.76 – 2.67 (m, 1H), 2.61 (d, *J* = 14.4 Hz, 2H), 2.54 – 2.42 (m, 2H), 2.16 (s, 3H), 1.93 (s, 3H), 1.63 – 1.47 (m, 4H), 1.35 – 1.30 (m, 2H). <sup>13</sup>C NMR (151 MHz, CDCl<sub>3</sub>) δ 207.3, 171.3, 169.9, 165.9, 156.9, 138.9, 138.2, 138.0, 137.7, 134.8, 129.1, 129.0, 128.8, 128.8, 128.7, 128.7, 128.6, 128.5, 128.3, 128.2, 128.0, 127.9, 127.8, 127.7, 127.7, 127.4, 127.3, 102.3, 98.2, 94.2, 78.1, 77.4, 77.2, 76.9, 76.4, 76.2, 75.0, 73.5, 72.4, 72.1, 70.2, 70.1, 69.8, 69.4, 68.2, 68.0, 67.7, 67.6, 67.3, 65.7, 63.2, 59.9, 58.8, 50.5, 50.3, 47.2, 46.1, 37.4, 32.0, 30.1, 29.8, 29.5, 29.2, 27.9, 27.7, 27.6, 23.5, 23.4, 22.8, 20.4, 14.3. HR-ESI-MS (*m/z*): calculated for C<sub>81</sub>H<sub>99</sub>N<sub>7</sub>O<sub>20</sub>SiNa [M+Na]<sup>+</sup>: 1400.5591, found: 1400.5599.

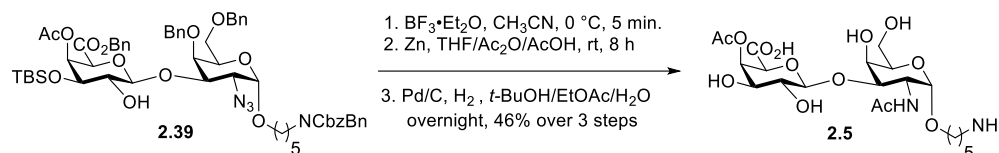
### 5-Aminopentyl 2-acetamido-2-deoxy- $\alpha$ -D-galactopyranosyl-(1 $\rightarrow$ 3)-4-O-acetyl- $\beta$ -D-galactopyranosyl uronate-(1 $\rightarrow$ 3)-2-acetamido-2-deoxy- $\alpha$ -D-galactopyranoside (**2.4**)



To a solution of trisaccharide **2.44** (20 mg, 0.014 mmol) in DCM (3 mL) was added N<sub>2</sub>H<sub>4</sub>•AcOH (8 mg, 0.087 mmol). After stirring for 12 h at rt, the reaction was quenched with acetone (1 mL) and evaporated under high vacuum. Residue was passed through silica column chromatography using ethyl acetate followed by evaporation to get quantitative amount of triol intermediate. The triol intermediate was dissolved in the solution of THF/Ac<sub>2</sub>O/AcOH (3/2/1, *v/v/v*, 3 mL) and added freshly activated zinc (400 mg). After stirring for 8 h at rt, the mixture was diluted with ethyl acetate and filtered over Celite® 353 and evaporated *in vacuo*. The crude was dissolved in EtOAc/*t*-BuOH/H<sub>2</sub>O (2/1/1, *v/v/v*, 2 mL) and Pd/C (50 mg) was added to the solution. After stirring for 10 h under hydrogen atmosphere (1 atm, balloon), the mixture was filtered through a PTFE filter (0.45 μm pore size) and concentrated. The crude material was purified by HPLC (Hypercarb column, 150 x 10 mm, H<sub>2</sub>O (0.1% formic acid) isocratic (5 min), linear gradient to 10% ACN (30

min), linear gradient to 100% ACN (10 min)) and lyophilized to obtain pure trisaccharide **2.4** (4.8 mg, 46%). <sup>1</sup>H NMR (700 MHz, D<sub>2</sub>O) δ 5.71 (dd, *J* = 3.2, 1.2 Hz, 1H), 5.17 (d, *J* = 3.8 Hz, 1H), 4.92 (d, *J* = 3.8 Hz, 1H), 4.63 (d, *J* = 7.9 Hz, 1H), 4.42 – 4.35 (m, 2H), 4.27 – 4.22 (m, 1H), 4.22 – 4.17 (m, 2H), 4.05 – 4.00 (m, 3H), 3.96 (ddd, *J* = 15.7, 10.5, 3.3 Hz, 2H), 3.82 – 3.77 (m, 4H), 3.77 – 3.72 (m, 1H), 3.69 (dd, *J* = 10.0, 7.9 Hz, 1H), 3.53 (dt, *J* = 9.9, 6.1 Hz, 1H), 3.03 (t, *J* = 7.7 Hz, 2H), 2.16 (s, 3H), 2.06 (s, 3H), 2.04 (s, 3H), 1.75 – 1.64 (m, 4H), 1.52 – 1.44 (m, 1H). <sup>13</sup>C NMR (176 MHz, D<sub>2</sub>O) δ 174.5, 174.4, 173.5, 172.4, 103.9, 97.2, 93.5, 78.1, 74.1, 73.5, 70.8, 70.7, 69.0, 68.5, 68.4, 68.1, 67.7, 67.4, 61.4, 61.2, 49.3, 48.7, 39.4, 28.1, 26.5, 22.4, 22.2, 22.0, 20.3. HR-ESI-MS (*m/z*): calculated for C<sub>29</sub>H<sub>50</sub>N<sub>3</sub>O<sub>18</sub> [M+H]<sup>+</sup>: 728.3089, found: 728.3096

***N*-(Benzyl)benzyloxycarbonyl-5-aminopentyl 4-*O*-acetyl-β-*D*-galactopyranosyl uronate-(1→3)-2-acetamido-α-*D*-galactopyranoside (2.5)**



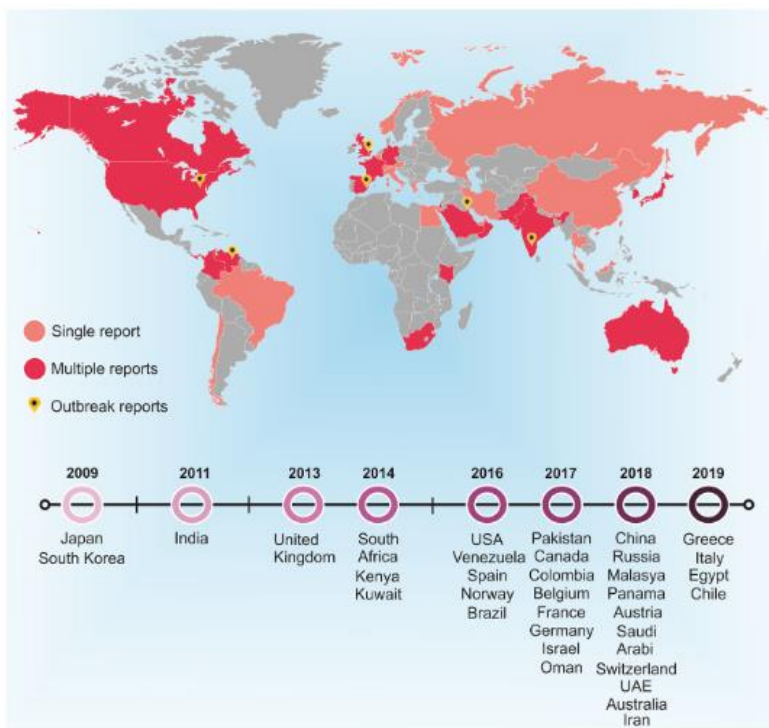
Disaccharide **2.39** (36 mg, 0.032 mmol) was dissolved in anhydrous ACN (5 mL) under a nitrogen atmosphere at 0 °C and to this,  $\text{BF}_3 \cdot \text{OEt}_2$  (4.8 μL, 0.038 mmol) was added dropwise. After stirring for 5 min, quenched with saturated aqueous  $\text{NaHCO}_3$ , extracted the organic layer with DCM. The combined organic layer was dried over  $\text{Na}_2\text{SO}_4$ , filtered and evaporated *in vacuo*. The crude was dissolved in a mixture of THF/ $\text{Ac}_2\text{O}$ / $\text{AcOH}$  (3/2/1, *v/v/v*, 3 mL) and added freshly activated Zn dust. After stirring overnight at rt, the mixture was diluted with DCM and filtered over Celite® 353. The filtrate was neutralized with saturated aqueous  $\text{NaHCO}_3$  and washed with brine. The organic phase was dried over  $\text{Na}_2\text{SO}_4$ , filtered and evaporated *in vacuo*. The crude was dissolved in EtOAc/*t*-BuOH/ $\text{H}_2\text{O}$  (2/1/1, *v/v/v*, 3 mL) and added Pd/C (60 mg). The reaction mixture was stirred overnight at rt under hydrogen atmosphere (1 atm, balloon). The crude material was purified by HPLC (Hypercarb column, 150 x 10 mm,  $\text{H}_2\text{O}$  (0.1% formic acid) isocratic (5 min), linear gradient to 10% ACN (30 min), linear gradient to 100% ACN (10 min) and lyophilized to obtain pure disaccharide **2.5** (11 mg, 46%) as a white solid. <sup>1</sup>H NMR (400 MHz, D<sub>2</sub>O) δ 5.54 (dt, *J* = 3.8, 1.0 Hz, 1H), 4.86 (d, *J* = 3.8 Hz, 1H), 4.51 (d, *J* = 7.8 Hz, 1H), 4.36 – 4.28 (m, 2H), 4.16 (d, *J* = 1.4 Hz, 1H), 4.03 – 3.94 (m, 2H), 3.85 (dd, *J* = 10.0, 3.7 Hz, 1H), 3.77 – 3.73 (m, 2H), 3.71 – 3.64 (m, 1H), 3.56 – 3.44 (m, 2H), 2.98 (t, *J* = 7.6 Hz, 2H), 2.09 (d, *J* = 0.7 Hz, 3H), 2.01 – 1.98 (m, 3H), 1.65 (dt, *J* = 15.1, 7.4 Hz, 4H), 1.50 – 1.39 (m, 2H). <sup>13</sup>C NMR (101 MHz, D<sub>2</sub>O) δ 174.5, 173.5, 173.0, 103.9, 97.1, 77.1, 73.5, 72.1, 71.1, 70.7, 70.2, 68.5, 67.6, 61.3, 48.7, 39.3, 28.0, 26.4, 22.3, 21.9, 20.2. HR-ESI-MS (*m/z*): calculated for C<sub>21</sub>H<sub>37</sub>N<sub>2</sub>O<sub>13</sub> [M+H]<sup>+</sup>: 525.2296, found: 525.2288.

## Chapter 3

# Synthesis of Oligosaccharides Resembling *Candida auris* Cell Surface Mannans as Basis for Anti-fungal Glycoconjugate Vaccine Development

### 3.1 Introduction

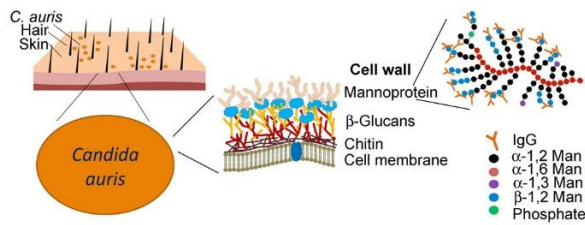
*Candida auris* (*C. auris*) is a species of yeast first identified in 2009 in Japan.<sup>117</sup> Since then, it has been reported in dozens of countries and can cause severe infections in humans. It is a growing global health (Figure 3.1)<sup>118</sup> concern because it is often resistant to multiple current antifungal drugs, which can also lead to high mortality rates. *C. auris* can cause infections in the bloodstream, wounds, and ears. The fungus can spread through contact with infected surfaces and can remain viable on surfaces for long periods, making it difficult to control. It is most commonly found in patients who have had prolonged hospital stays, weakened immune systems, or have been exposed to antibiotics for long periods of time. Common symptoms of *C. auris* infection include fever, chills, coughing, shortness of breath, and chest pain. Other symptoms may include skin lesions, confusion, extreme fatigue, and poor appetite.<sup>119</sup> With a growing population of susceptible people, invasive candidiasis is rising, and antifungal resistance makes treatment difficult. As a result, *Candida* species are now the third most common reason of bloodstream infections.



**Figure 3.1:** Global distribution of *C. auris* between 2009 and 2019 (Reprinted from: *J. Fungi* 2020, 6, 185)

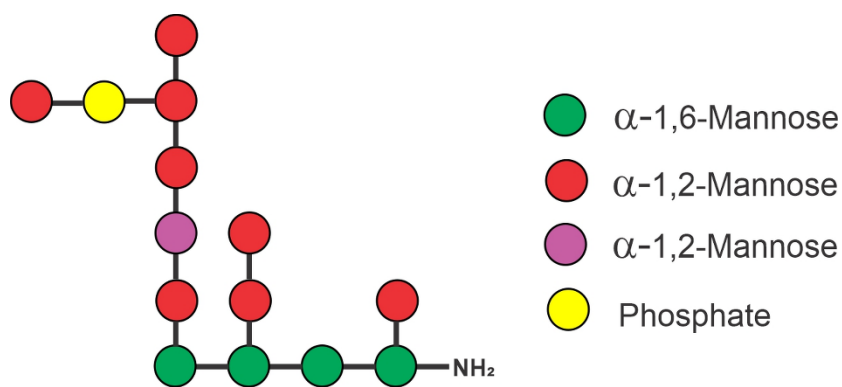


The treatment for *C. auris* infections typically involves antifungal medication and the first line of treatment for is an echinocandin, such as caspofungin, micafungin, or anidulafungin.<sup>120</sup> Echinocandins work by inhibiting the synthesis of beta-glucan, a key component of the fungal cell wall, and are often effective against *C. auris*.<sup>121</sup> Other antifungal drugs that may be used to treat *C. auris* infections include azoles, such as fluconazole, and polyenes, such as amphotericin B. However, it is important to note that many strains of *C. auris* are resistant to multiple antifungal drugs, making treatment more difficult.



**Figure 3.2:** Cell wall structure of *C. auris* (Reprinted from: *ACS Infect. Dis.* **2020**, *6*, 1018-1031)

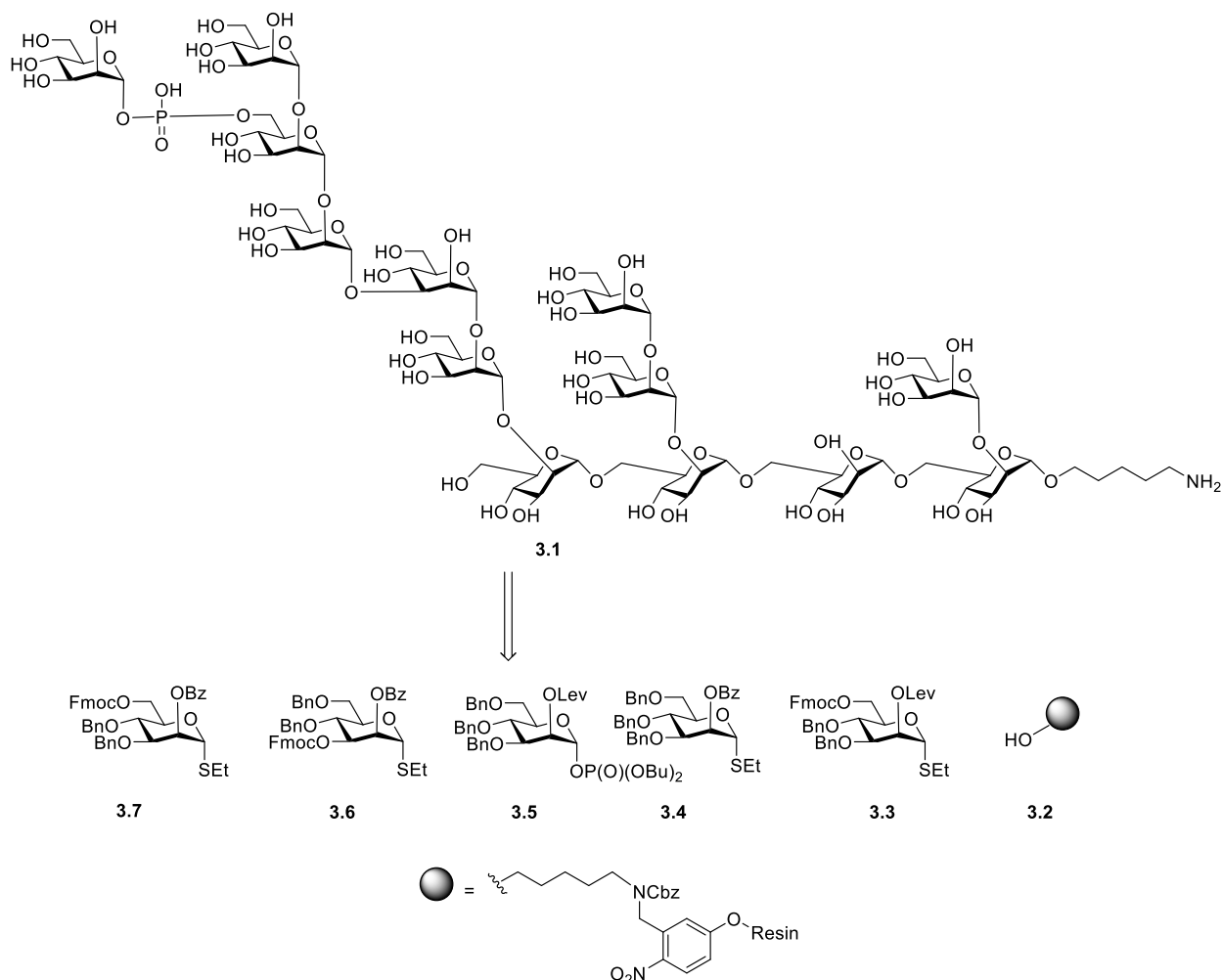
Nearly all aspects of the biology and pathogenicity of pathogenic *C. auris* depend on the cell wall, which makes up the exterior surface of the pathogen and contains a carbohydrate content of over 60%. Cell wall mannoproteins are comprised of N- and O-linked mannans with mannopyranose residues that are  $\alpha$ -1,2,  $\alpha$ -1,3,  $\alpha$ -1,6, and  $\beta$ -1,2-linked along with phospho-linked mannopyranose units.<sup>122</sup> During candidiasis, these mannoproteins are effective immunogens that activate and regulate the host's innate immune response via the mannose receptor, DC-SIGN (dendritic cell-specific intracellular adhesion molecule-3 (ICAM-3) grabbing nonintegrin), and Dectin-216.<sup>122</sup> *Candida* mannans and mannoproteins are effective vaccines with high immunogenicity in animal models of candidiasis.



**Figure 3.3:** Structure of *Candida auris* KCTC17810

### 3.2 Results and Discussion

The design of building blocks began with a retrosynthetic analysis of conjugation-ready *C. auris* KCTC 17810, which is a highly complex target oligosaccharide in a synthetic perspective. This target oligosaccharide has unique  $\alpha$ -1,2,  $\alpha$ -1,3, and  $\alpha$ -1,6-linked mannopyranose residues along with challenging phospho-linked mannans. Merrifield resin equipped with an aminopentyl photocleavable linker would enable access to target glycan following cleavage from the solid support and global deprotection. Building blocks **3.3**, **3.4**, **3.5**, **3.6** and **3.7** were carefully selected for the synthesis of the target oligosaccharide.



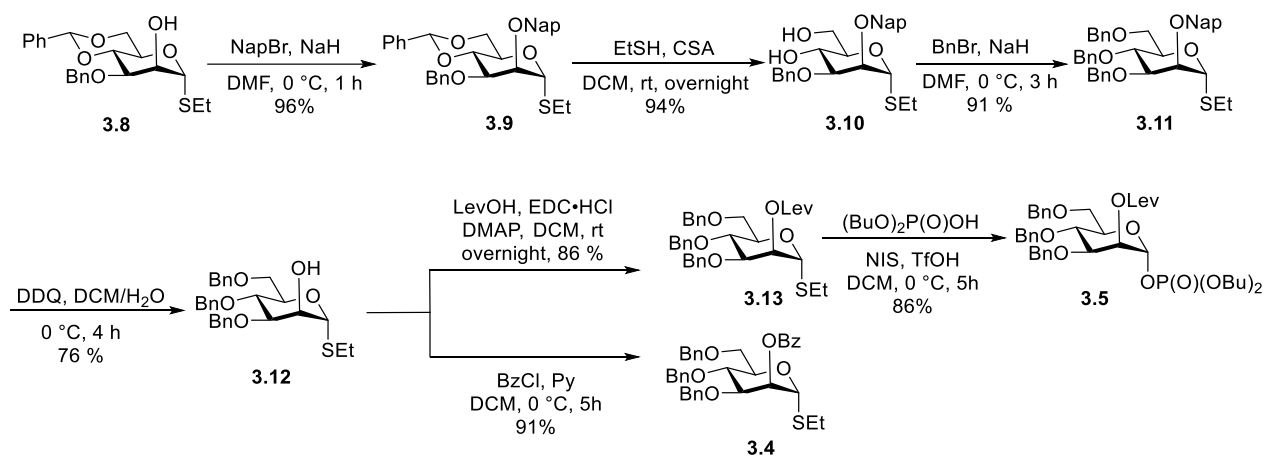
**Figure 3.4:** Building blocks for the AGA of *C. auris* KCTC 17810

In general, thioglycosides are a popular choice for glycosyl donors because they are easy to synthesize on a large scale and are stable for a long time. More importantly, the activation of thioglycosides are well established. Hydroxyl groups of building blocks **3.3** and **3.5** that engage in the branch elongation were temporarily protected as levulinoyl (Lev) ester. Fmoc carbonates masked the C6 hydroxyls in **3.3** and **3.7** as an orthogonal temporary protecting group to extend the backbone of the target structure. Benzoyl (Bz) ester and benzyl (Bn) ether were used as permanent participating and nonparticipating groups, respectively. After AGA, *H*-phosphonate would be

coupled with an acceptor (12-mer) to get a fully protected target oligosaccharide which then undergoes on resin methanolysis (to remove esters) followed by cleavage from the solid support and hydrogenation (to deprotect Bn and Cbz) would provide *C. auris* KCTC 17810 mannan.

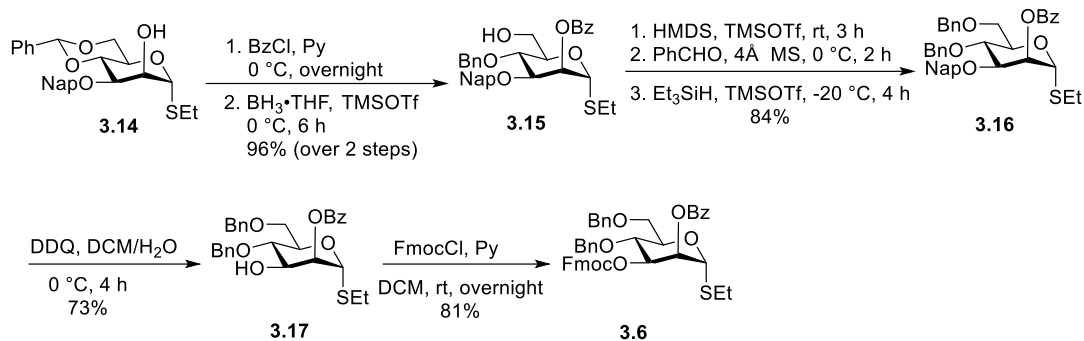
### 3.2.1 Synthesis of mannose building blocks 3.4 and 3.5

Building block **3.5** requires protection at the C2 hydroxyl with a group capable of engaging in neighboring group participation during glycosylation reaction and can be deprotected for branch elongation during AGA. Synthesis of the building block began with the protection of the C2 hydroxyl group of commercially available thiomannoside **3.8** by Nap using 2-(Bromomethyl) naphthalene. The benzylidene acetal **3.9** was hydrolyzed using ethanethiol along with catalytic amount of camphorsulfonic acid (CSA), followed by per-benylation of diol using benzyl bromide afforded thiomannoside **3.11**. The naphthyl ether was selectively deprotected by DDQ to give **3.12**, which then undergoes subsequent levulinoyl protection to afford **3.13**.<sup>123</sup> Thioglycoside **3.13** was then converted to phosphate donor **3.5** using dibutyl phosphate. Compound **3.4** was synthesized from thiomannoside **3.12** using benzoylation.



**Scheme 3.1:** Synthesis of building blocks **3.4** and **3.5**

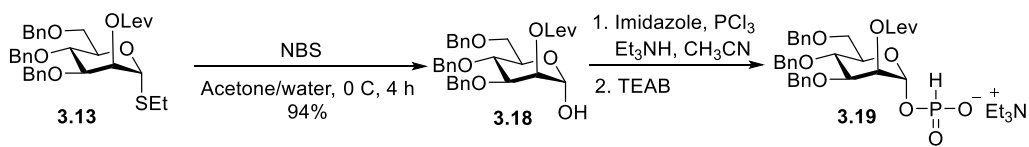
Building block **3.6** carrying Fmoc carbonate at the 3-position was synthesized starting from benzylidene acetal **3.14**. Benzoylation followed by regioselective benzylidene ring opening using  $\text{BH}_3 \cdot \text{THF}$ , and TMSOTf afforded 6-hydroxyl compound **3.15** with 96% yield over two steps. Acid catalyzed benzylation of **3.15** followed by Nap deprotection using DDQ provided requisite 3-hydroxyl compound **3.17**. Subsequently, the hydroxyl group was protected as Fmoc carbonate using FmocCl to get desired building block **3.6**.



**Scheme 3.2:** Synthetic route to **3.6**

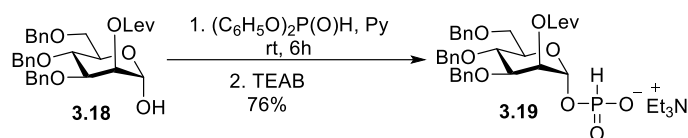
In order to synthesize the important *H*-phosphonate **3.19**, the compound **3.13** was treated with NBS to hydrolyze the thioglycoside to give the hemiacetal **3.18**, which was then treated with triimidazolylphosphine<sup>124</sup> (produced in situ from imidazole, phosphorus trichloride, and triethylamine), followed by basic hydrolysis to produce the *H*-phosphonate monoester **3.19** in a one-pot synthesis. During this synthesis, I tried with three equiv. of phosphorus trichloride, eight equiv. of imidazole and four equiv. of trimethylamine in acetonitrile provided *H*-phosphonate **3.19** with only 40% yield (Table 1) with recovered hemiacetal **3.18** (32%). I also tried to improve the yield by different reaction conditions, but to our disappointment, it gave only 44% of *H*-phosphonate **3.19**.

**Table 3.1:** Synthesis of *H*-phosphonate **3.19**



Entry	PCl <sub>3</sub> (Equiv.)	Imidazole (Equiv.)	Et <sub>3</sub> N (Equiv.)	3.19 (%)	3.18 (%)
1	4	8	4	40	32
2	4	8	4	43	27
3	5	4	5	44	25

After an unsuccessful attempt to obtain the *H*-phosphonate in good yield, we used a different strategy to improve the yield. Treatment of hemiacetal **3.18** with diphenyl phosphite in anhydrous pyridine followed by basic hydrolysis using triethylammonium bicarbonate buffer (TEAB) provided *H*-phosphonate **3.19** in a satisfactory yield of 76%.

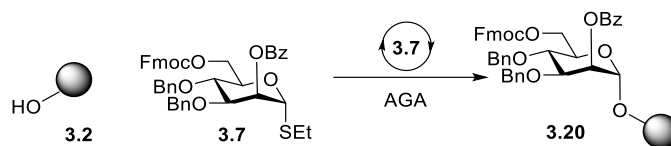


**Scheme 3.3:** Synthesis of *H*-phosphonate **3.19**

### 3.3 AGA

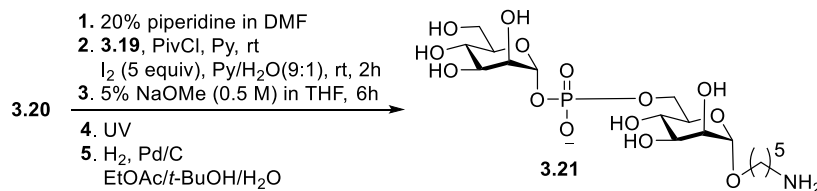
#### 3.3.1 Optimization of coupling conditions

With building blocks **3.3**, **3.4**, **3.5** and **3.7** in hand, the optimization process started to find the appropriate conditions for assembling large structures. This optimization was tested in the context of mono-, di- and trisaccharide fragments, aiming to achieve complete conversion with maximum stereoselectivity in each glycosylation cycle (Table 2.1). Analytical HPLC chromatograms (complemented with MALDI data) were used as the main tools for a qualitative optimization of the reaction conditions during AGA. A typical AGA process consists of acidic wash, glycosylation, capping to mask unreacted acceptor and deprotection of a temporary protecting group to unmask the nucleophile for the subsequent glycosylation. First, the photocleavable aminopentanol linker immobilized on polystyrene resin **3.2** was placed in the reaction vessel of AGA to synthesize monosaccharide. Six equivalents of thioglycoside donors were used for coupling using NIS and TfOH as an activator at an incubation temperature of  $-20\text{ }^{\circ}\text{C}$  for 20 minutes, followed by warming up to  $0\text{ }^{\circ}\text{C}$ , and maintained for 20 minutes. Acid catalyzed capping was performed with a solution of methanesulfonic acid and acetic anhydride. Fmoc was cleaved using 20% piperidine in DMF. The micro cleavage of a few beads of resin by light gave the crude sample, which was then analyzed by HPLC and MALDI mass spectrometry, confirming the clean monosaccharide synthesis (Scheme 3.4).



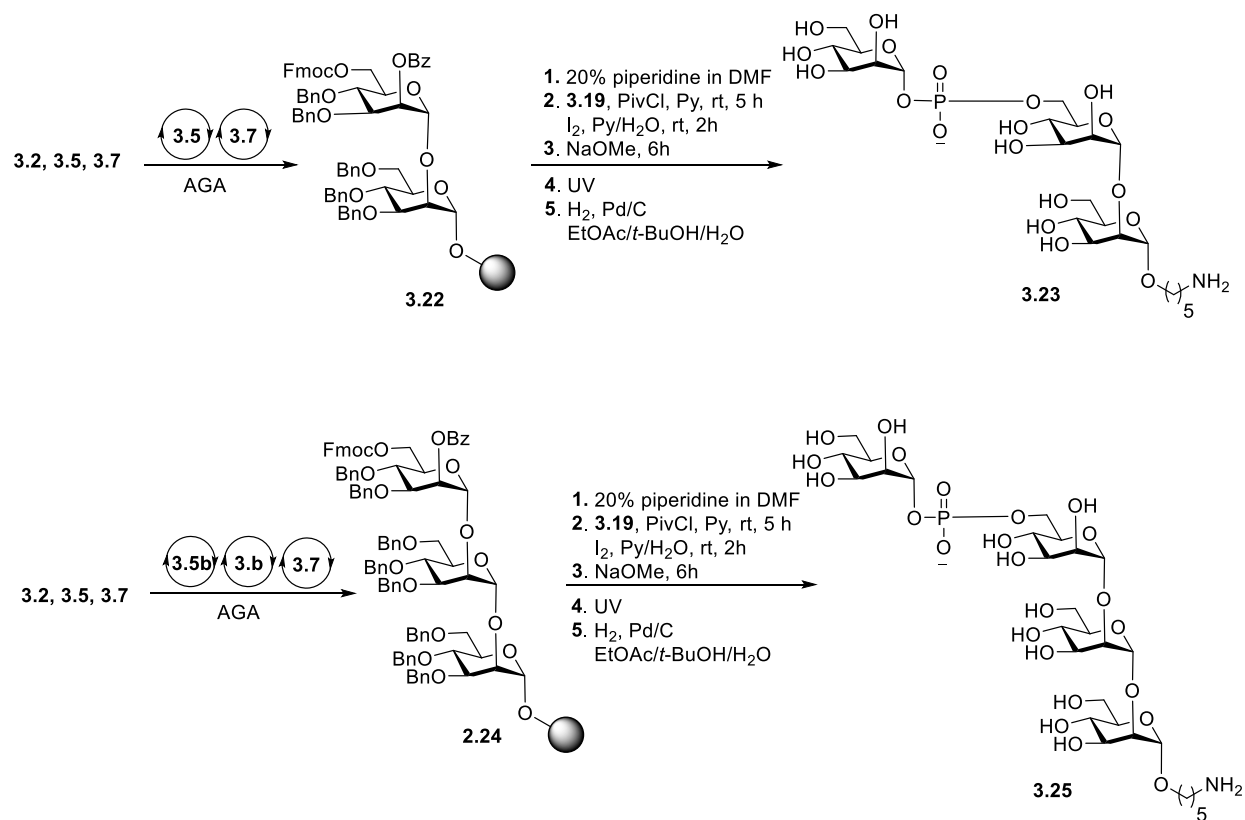
**Scheme 3.4:** AGA of **3.20**. Conditions for AGA: (1) For coupling step: a) Acidic wash: TMSOTf in DCM; b) Glycosylation: six equiv. of **3.7** and NIS, TfOH in DCM/dioxane,  $-20\text{ }^{\circ}\text{C}$  (20 min)  $\rightarrow$   $0\text{ }^{\circ}\text{C}$  (20 Min.); c) Capping:  $\text{Ac}_2\text{O}$ , MsOH in DCM; d) Deprotection: Fmoc removal 20% piperidine in DMF at  $25\text{ }^{\circ}\text{C}$ .

After the AGA process, by having the monosaccharide **3.20** on the solid support, we moved to explore the reaction conditions for synthesis challenging phosphodiester linkage on a solid support.

**Table 3.2:** Optimization of *H*-phosphonate coupling conditions

Entry	PivCl (equiv.)	<i>H</i> -phosphonate(3.21) (equiv.)	Time (h)	Yield (%)
1	2	3	2	-
2	2	5	5	-
3	5	5	5	5
4	4	5	5	12
5	10	5	5	26
6	12	5	5	20

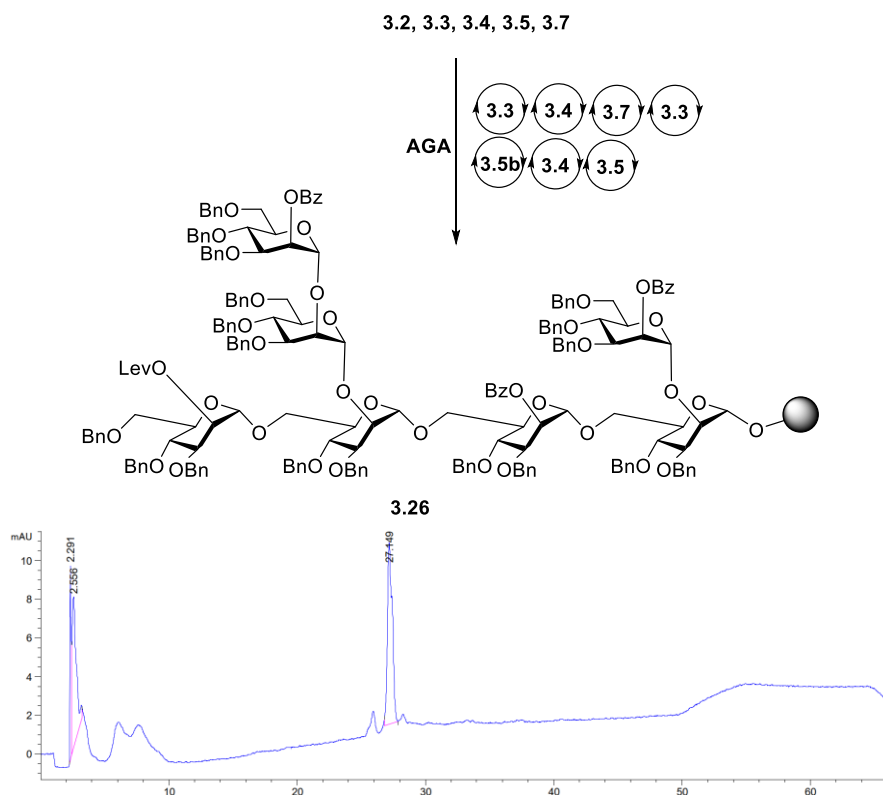
Initially, the screening started with glycosylated resin **3.20** by treating with two equiv. of PivCl and three equiv. of *H*-phosphonate followed by oxidation using iodine (Table 3.2, entry 1).<sup>125</sup> After the reaction, a few beads of resin were subjected to UV cleavage and obtained crude did not show any desired mass in Q-tof mass spectrometry. Then I increased the *H*-phosphonate amount to five equiv. and again, no mass corresponding to desired mass was observed (Table 3.2, entry 2). To facilitate the reaction between *H*-phosphonate and glycosylated resin, the amount of pivCl was increased to five equiv. and this condition showed the desired mass (Table 3.2, entry 3). Debenzoylation using 5% NaOMe in THF provided resin-bound dihydroxy compound. Photocleavage followed by hydrogenation provided deprotected disaccharide having phosphodiester linkage in 5% yield. After systematic optimization of *H*-phosphate coupling reaction conditions, the desired disaccharide **2.21** was obtained in 26% yield using 10 equiv. of PivCl and 5 equiv. of *H*-phosphonate (Table 3.2, entry 5). Using this optimized condition, trisaccharide **3.23** and tetrasaccharide **3.25** were synthesized.



**Scheme 3.5:** Synthesis of oligosaccharides **3.23** and **3.25**

### 3.3.2 Synthesis of oligosaccharide **3.28**

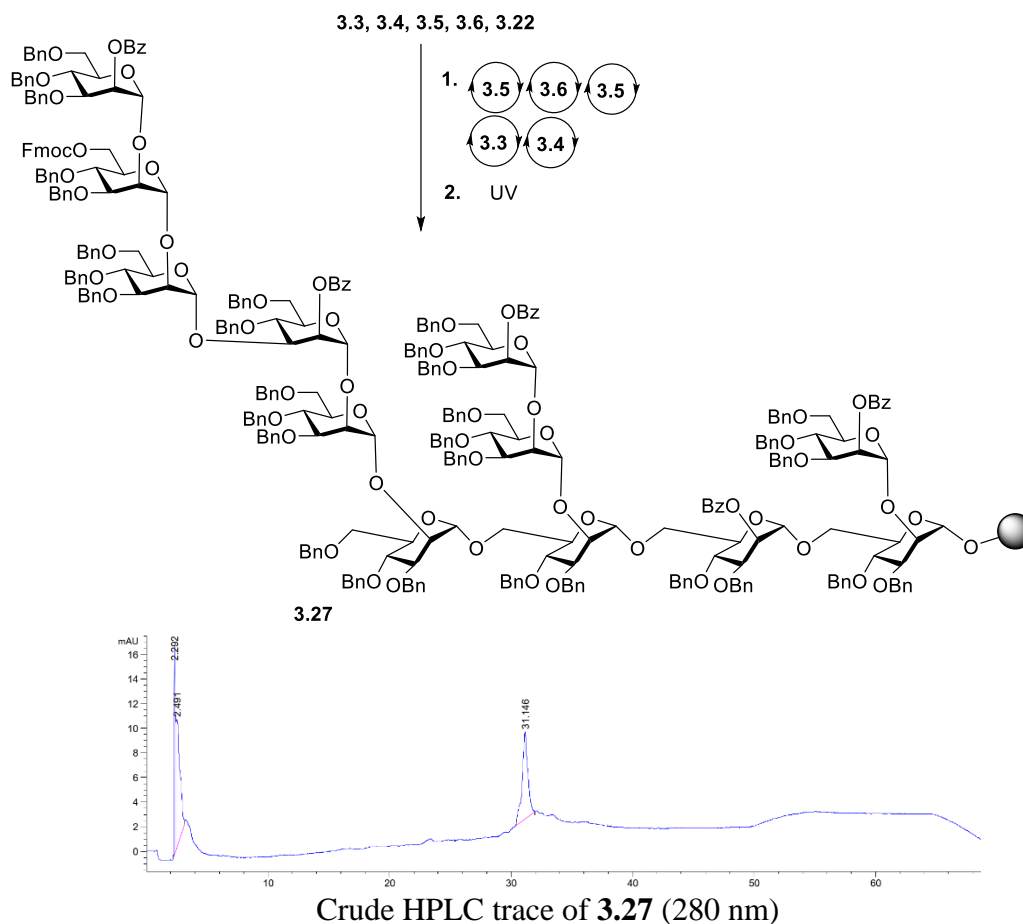
After optimizing reaction conditions for *H*-phosphonate coupling using a monosaccharide, I started the synthesis of *C. auris* KCTC 17810 mannan with the synthesis of intermediate 7-mer. The synthesis began with four differentially protected thioglycoside (**3.3**, **3.4** and **3.7**) and phosphate (**3.5**) donors in AGA using conjugate ready photolabile linker. Thioglycoside donor building blocks were activated by NIS, TfOH and phosphate donor **3.5** by TMSOTf. Fmoc and Lev groups were cleaved using piperidine and hydrazine acetate, respectively. The synthesis was monitored by microcleavage followed by HPLC and MALDI, confirming the clean synthesis at the 7-mer stage.



**Scheme 3.6:** AGA of 7-mer **3.22**. Conditions for AGA: (1) For each coupling step: a) Acidic wash: TMSOTf in DCM; b) Glycosylation: six equiv. of **3.3** or **3.4** or **3.7** and NIS, TfOH in DCM/dioxane, -20 °C (20 min) → 0 °C (20 Min) or eight equiv. of **3.5** and TMSOTf in DCM, -35 °C (10 min) → -10 °C (30 Min.); c) Capping: Ac<sub>2</sub>O, MsOH in DCM; d) Deprotection: Fmoc removal 20% piperidine in DMF at 25 °C; Lev removal 0.15 M NH<sub>2</sub>NH<sub>2</sub>·AcOH in py/AcOH/H<sub>2</sub>O for 3 x 30 min at 35 °C. (2) UV cleavage.

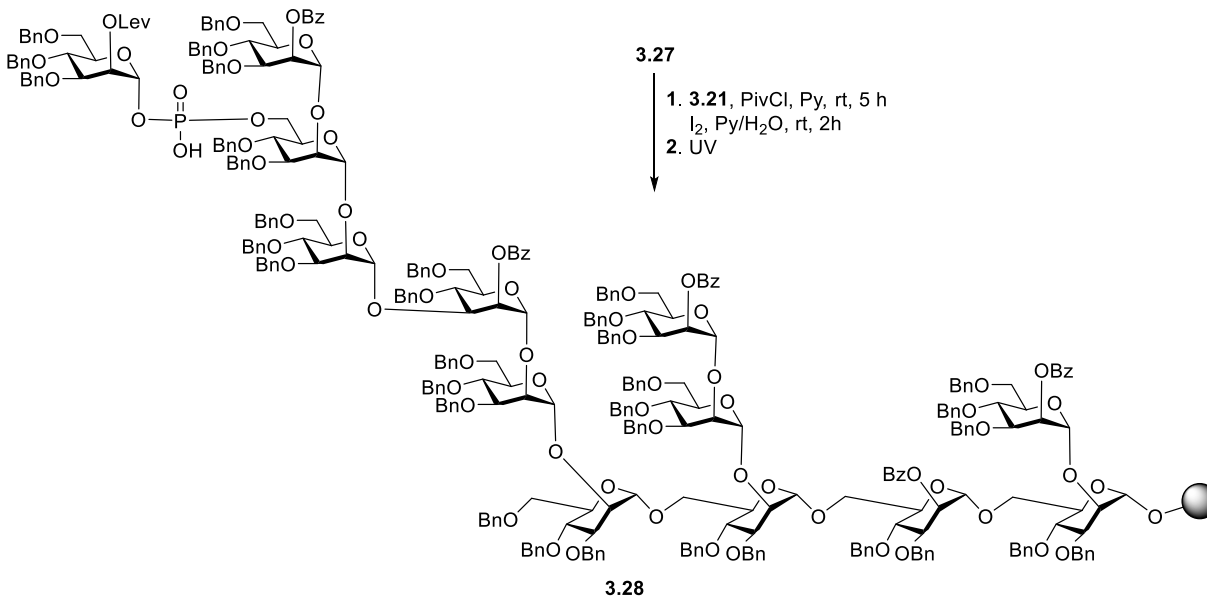
After establishing a clean synthesis of 7-mer, the synthesis of the 12-mer was continued with deprotection of Lev in **3.26**, followed by sequential glycosylations with four different building blocks (**3.3**, **3.4**, **3.6**, and **3.6**). At the 12-mer stage, the synthesis was confirmed again with the crude product which was analyzed by HPLC and MALDI.





**Scheme 3.7:** AGA of 13-mer **3.23**. Conditions for AGA: (1) For each coupling step: a) Acidic wash: TMSOTf in DCM; b) Glycosylation: six equiv. of **3.3** or **3.4** or **3.6** and NIS, TfOH in DCM/dioxane, -20 °C (20 min) → 0 °C (20 Min.) or eight equiv. of **3.5b** and TMSOTf in DCM, -35 °C (10 min) → -10 °C (30 Min.); c) Capping: Ac<sub>2</sub>O, MsOH in DCM; d) Deprotection: Fmoc removal 20% piperidine in DMF at 25 °C; Lev removal 0.15 M NH<sub>2</sub>NH<sub>2</sub>·AcOH in py/AcOH/H<sub>2</sub>O for 3 x 30 min. at 35 °C. (2) UV cleavage.

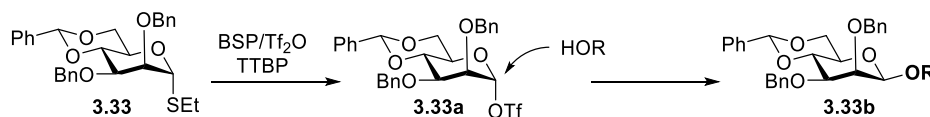
After synthesizing resin bound 12-mer, Fmoc was deprotected and subjected to the *H*-phosphonate coupling using the optimized protocol to get compound **3.28**. The phosphodiester linkage formation was confirmed by Q-tof.



**Scheme 3.8:** Synthesis of protected *C. auris* KCTC 17810 **3.28**

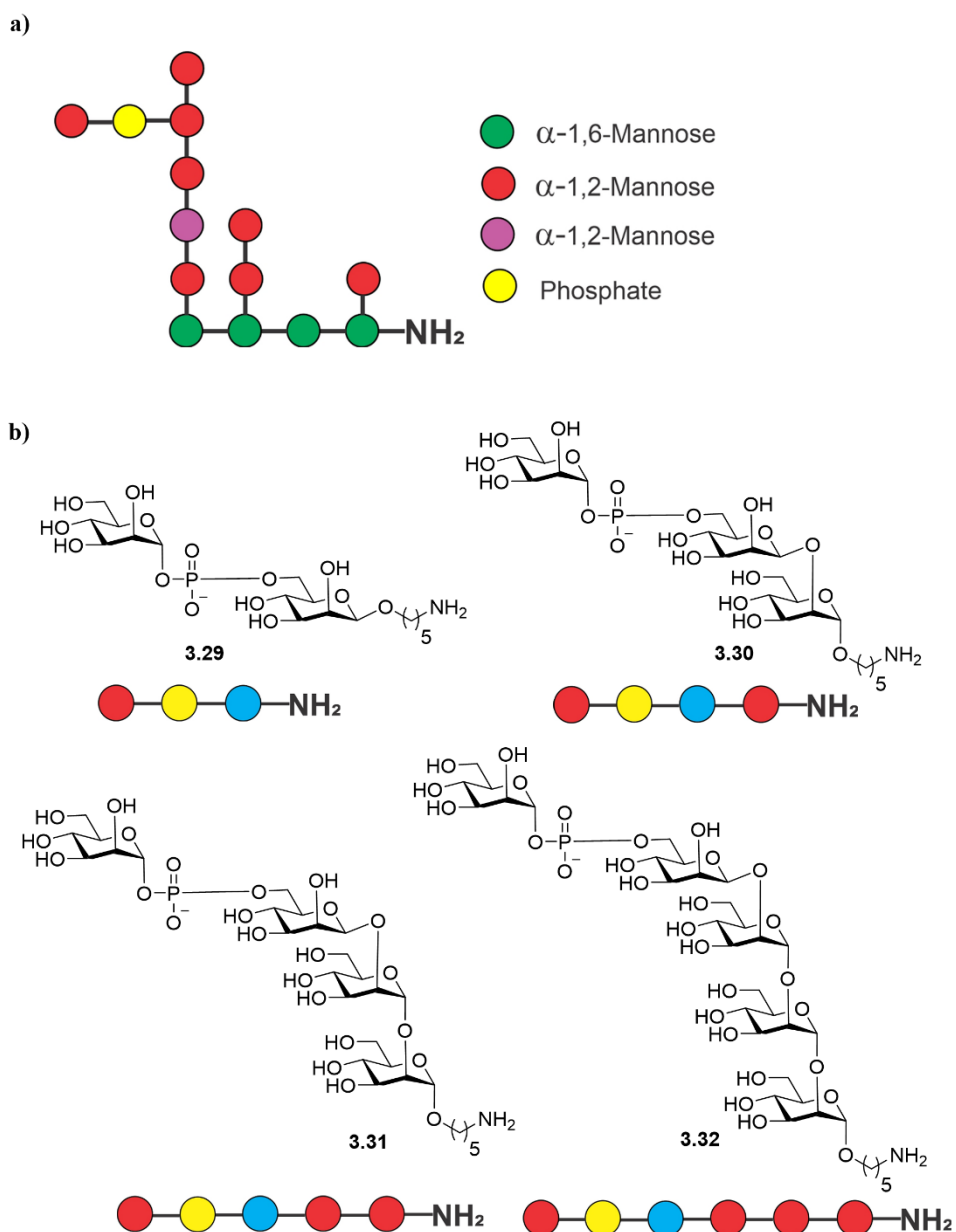
### 3.4 Synthesis of oligosaccharides **3.29**, **3.30**, **3.31** and **3.32**

For the synthesis of oligosaccharides (Figure 3.6) comprising difficult  $\beta$ -1,2-mannosidic and phosphodiester linkages resembling *C. auris*, solution phase strategy was used to have good control over selectivity. The synthesis of 1,2-*cis* glycosides in the mannosyl series represents one of the biggest challenges in carbohydrate chemistry till now. There are many efforts have been made to tackle this issue. However, only the Crich method showed some reasonable outcomes regarding selectivity. For instance, when a thioglycoside is treated with 1-benzenesulfinyl piperidine (BSP), 2,4,6-tri-*tert*-butylpyrimidine (TTBP) and trifluoromethanesulfonic anhydride (Tf<sub>2</sub>O) it form  $\alpha$ -triflate **3.33a** (Figure 3.5) because of a strong endo-anomeric effect.<sup>126</sup> Subsequent addition of nucleophilic acceptor via direct S<sub>N</sub>2 type displacement of  $\alpha$ -triflate will lead to the desired  $\beta$ -mannosidic linkage. The limitation of this method is 4,6-*O*-benzylidene acetal of the donor is must to get the high  $\beta$ -selectivity.



**Figure 3.5.** Introduction of  $\beta$ -mannosidic linkages by in situ formation of an  $\alpha$ -triflate.

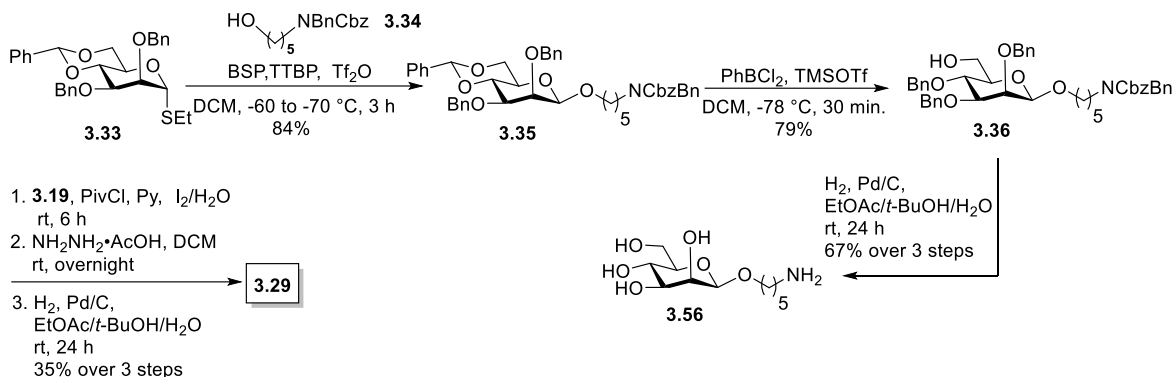
Target oligosaccharides (Figure 3.6 b) have  $\alpha$ -1,2, and  $\beta$ -1,2-linked mannosylpyranose residue along with phospho-linkage. Three building blocks **3.19**, **3.38** and **3.33**, were required and a linear synthetic strategy was used.



**Figure 3.6.** a) Structure of *C. auris* mannans; b) Structure of synthetic mannans resembling *C. auris*

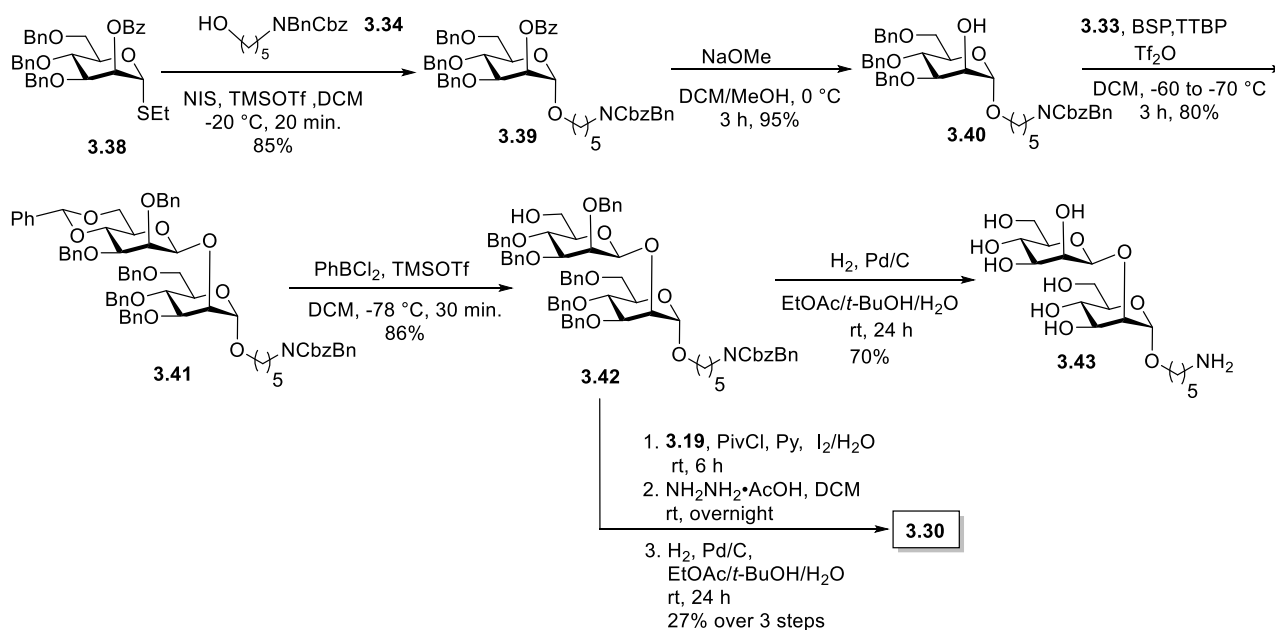
Glycosylation<sup>127</sup> of **3.33** with aminopentyl linker **3.34** using BSP, TTBP and triflic anhydride provided exclusively  $\beta$ -linked (confirmed by coupled HSQC NMR) fully protected monosaccharide **3.35** in 84% yield. The benzylidene ring in monosaccharide **3.35** was opened using dichlorophenyl borane and TMSOTf to yield 79% the 6-OH containing **3.36** (Scheme 3.9). Coupling of *H*-phosphonate **3.19** and monosaccharide **3.36** using pivaloyl chloride as a coupling reagent,  $I_2/H_2O$  assisted the oxidation of the newly formed *H*-phosphonate diester in disaccharide

followed by global deprotection<sup>128</sup> provided phosphate diester disaccharide **3.29**. The stereochemistry of newly formed linkage was confirmed by coupled HSQC NMR.



**Scheme 3.9:** Synthesis of phosphodiester linked disaccharide **3.29**

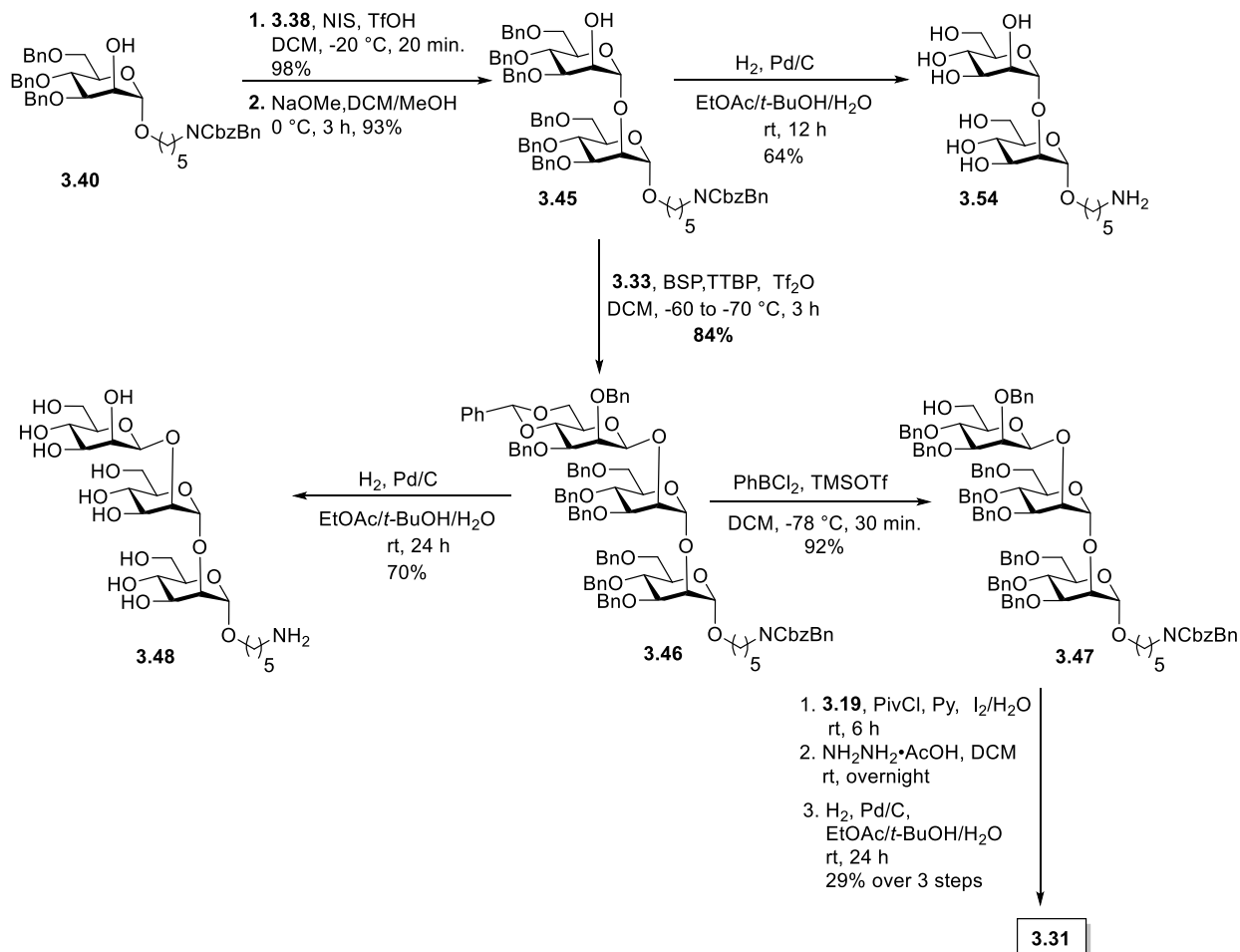
Glycosylation of D-thiomannoside<sup>129</sup> **3.38** donor with aminopentyl linker **3.34** promoted by NIS/TfOH afforded desired  $\alpha$ -linked glycoside **3.39** with 85% yield (Scheme 3.10). This linker is placed in anticipation of the conjugation to a carrier protein or a microarraysurface. Benzoyl ester cleavage using sodium methoxide gave differentially protected monosaccharide **3.40**. The synthesis of the  $\beta$ -(1 $\rightarrow$ 2)-linked disaccharide<sup>126</sup> **3.41** began with the activation of thioglycoside **3.33** by the addition of 1-benzene-sulfonyl piperidine (BSP), 2,4,6-tri-*tert*-butylpyrimidine (TTBP) and triflic anhydride (Tf<sub>2</sub>O) at -60 °C followed by addition of acceptor **3.40** at -70 °C to get exclusively fully protected  $\beta$ -(1 $\rightarrow$ 2)-linked mannan **3.41**.



**Scheme 3.10:** Synthesis of phosphodiester linked trisaccharide **3.30**

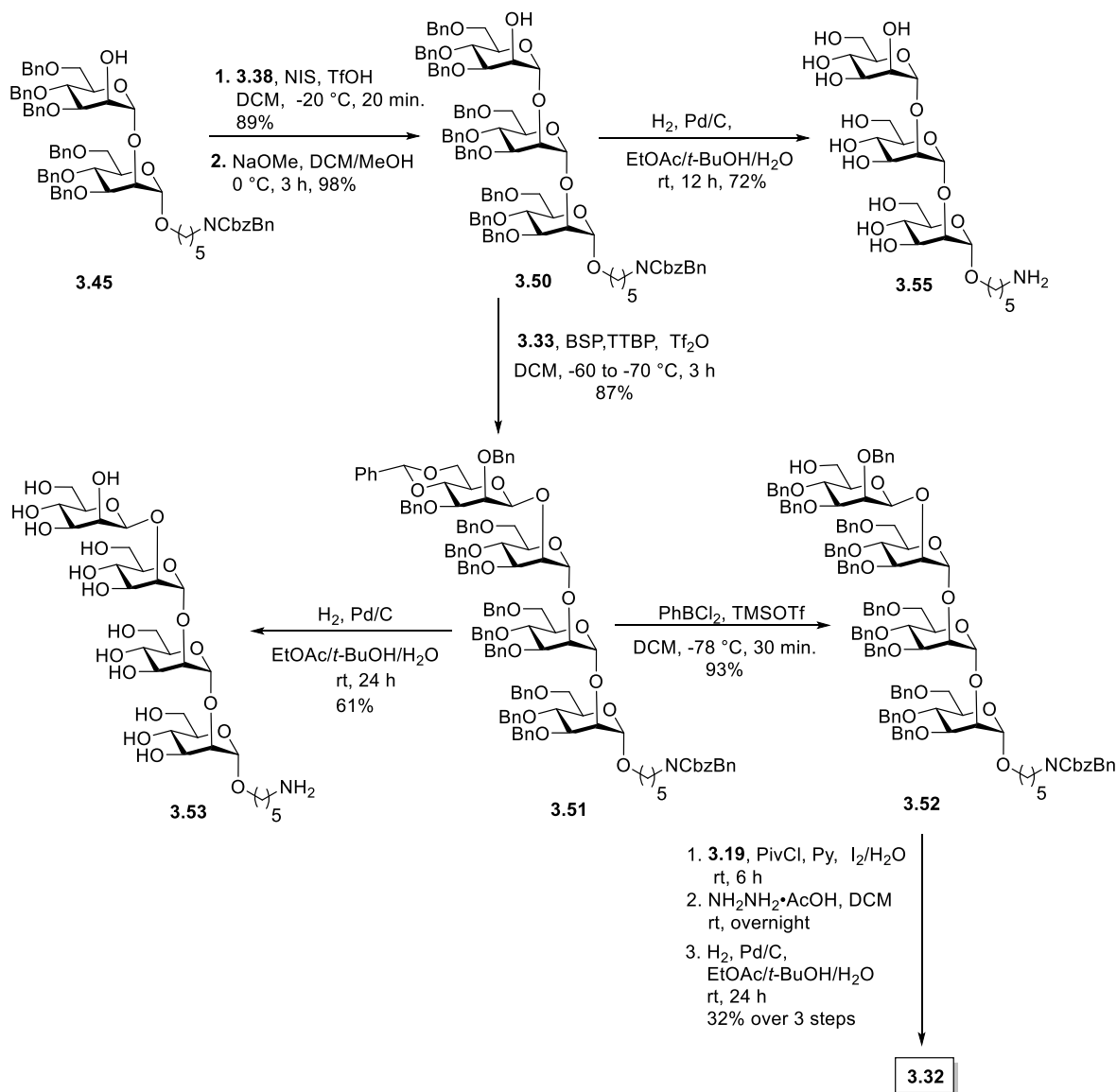
For the synthesis of trisaccharide **3.30**, the benzylidene ring was opened in disaccharide **3.41** to obtain disaccharide **3.42** in 86% yield. The coupling of *H*-phosphonate **3.19** with disaccharide **3.42**, followed by oxidation using I<sub>2</sub>/H<sub>2</sub>O and global deprotection, provided trisaccharide **3.30** containing a phosphodiester linkage in 27% yield over three steps. For the synthesis of trisaccharide **3.43**, hydrogenation was performed on protected trisaccharide **3.42**.

For the synthesis of tetrasaccharide **3.31**, monosaccharide acceptor **3.40** was glycosylated with donor **3.38** using NIS and TfOH, followed by methanolysis afforded disaccharide acceptor **3.45**. Disaccharide acceptor **3.45** was glycosylated with building block **3.33** using BSP, TTBP, and triflic anhydride to afford β-(1→2)-linked trisaccharide **3.46** in 84% yield (Scheme 3.11). Benzylidene ring opening in trisaccharide **3.46** using dichlorophenyl borane and TMSOTf provided trisaccharide **3.47** with 92% yield. The reaction of *H*-phosphonate **3.19** with trisaccharide **3.47**, oxidation of the newly formed *H*-phosphonate diester followed by global deprotection provided tetrasaccharide **3.31** in 29% yield over three steps.



**Scheme 3.11:** Synthesis of phosphodiester linked tetrasaccharide **3.31**

Synthesis of pentasaccharide **3.32** began with the union of disaccharide **3.45** with donor **3.38** using NIS/TfOH, followed by debenzoylation using sodium methoxide provided protected trisaccharide **3.50** (Scheme 3.12). Trisaccharide **3.50** was glycosylated with thioglycoside donor **3.33** to give protected tetrasaccharide **3.51** in 87% yield. Benzylidene ring opening, *H*-phosphonate coupling followed by global deprotection provide pentasaccharide **3.32**.

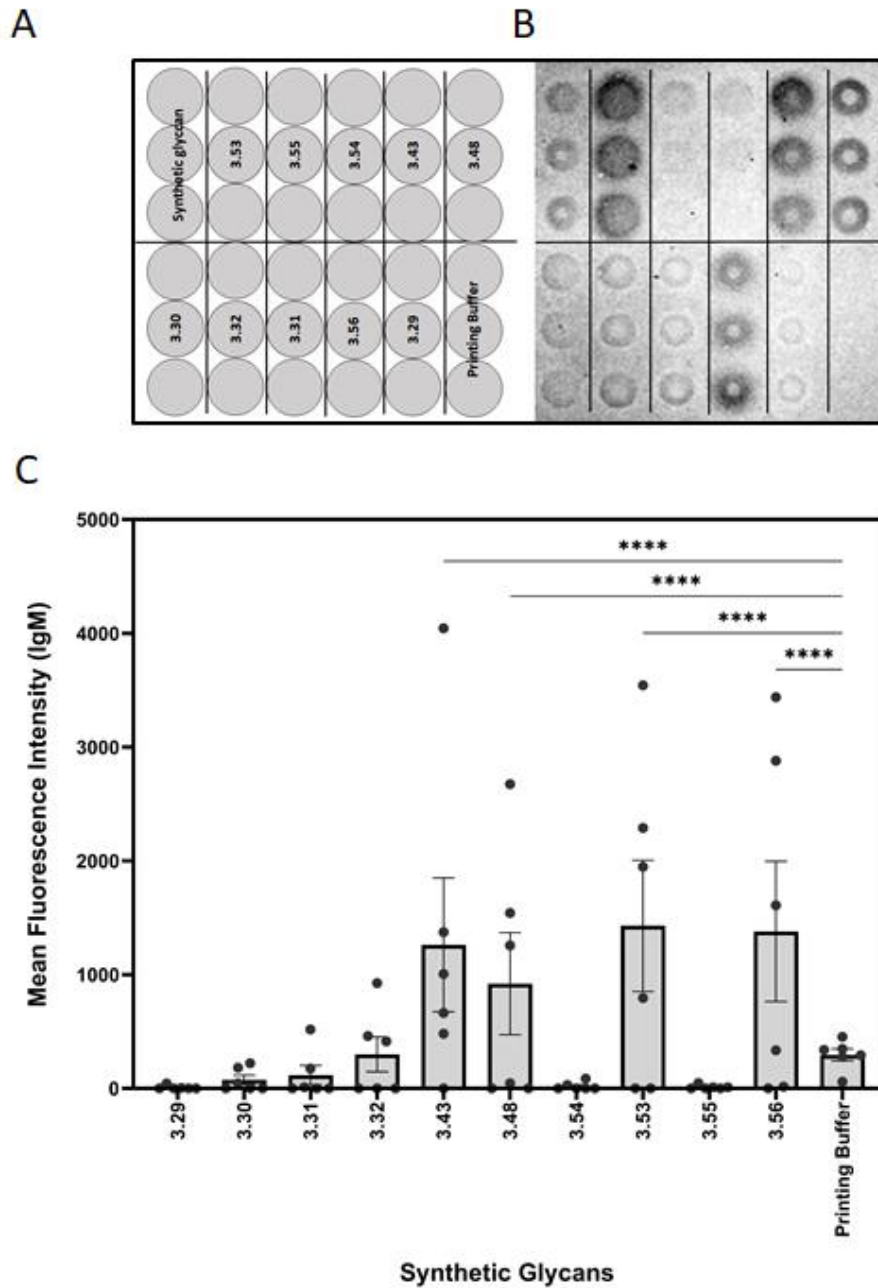


**Scheme 3.12:** Synthesis of phosphodiester linked pentasaccharide **3.32**

### 3.5 Glycan microarray screening

Glycan microarrays are useful tools for screening plasma samples in order to identify minimal glycan epitopes.<sup>130</sup> Synthetic glycans **3.29-3.32**, **3.43**, **3.48**, **3.53**, **3.54**, **3.55** and **3.56** were

immobilized in triplicates on glass slides to detect antibody binding to the glycans in plasma samples derived from mice three days after infection.



**Figure 3.7** Glycan microarray analysis of *Candida auris* mannans. (A) Printing pattern of glycan microarray. (B) Exemplary binding pattern of mice plasma to immobilized synthetic glycans. (C) Mean Fluorescence Intensity of IgM antibody binding to synthetic glycans. A plasma dilution of 1:50 was used. Values represent mean  $\pm$  SEM. Differences were tested for significance using one-way ANOVA followed by Tukey's post hoc test with (\*\*\*\*)  $p < 0.0001$ . (Glycan microarray screening was performed by Emelie E. Reuber)

IgM antibodies from infected mice specifically bound to structures **3.43**, **3.48**, **3.53** and **3.56**. All these synthetic glycans contain the  $\beta$ -(1 $\rightarrow$ 2)-linked mannan. Five of six animals produced antibodies to disaccharide **3.43** that emerged as a vaccine lead for incorporation into a glycoconjugate. No IgM antibodies were detected against glycans **3.29-3.32** possibly be due to shielding of the phosphodiester linker. Since antibodies against the synthetic glycans were detected already after three days of infection, oligosaccharides **3.43**, **3.48**, **3.53** and **3.56** serve for early detection of infection.

### 3.6 Conclusion and Outlook

This chapter describes the synthesis of phosphodiester linked glycans on solid support by AGA. We identified the diphenyl phosphite as an effective reagent to synthesize an anomerically pure *H*-phosphonate building block which is then utilized in the first solid phase synthesis of oligosaccharides having phosphodiester linkage. I extended this methodology to the synthesis of *C. auris* KCTC17810 mannans and successfully synthesized protected mannans **3.28**. The global deprotection will provide *C. auris* KCTC 17810.

In addition, I also synthesized the mannans, comprised of  $\beta$ -1,2-, and phosphodiester linkage resembling *C. auris* mannans. The challenging phosphodiester linkage was synthesized using *H*-phosphonate building block **3.19**. Glycan array analysis of plasma from mice infected with *C. auris*. for three days were screened for antibodies to the synthetic glycans. Disaccharide **3.43** is recognized by IgM and appears to be a promising vaccine lead for further development of a glycoconjugate vaccine candidate.



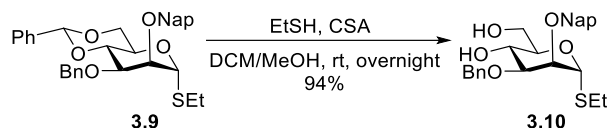
## 3.6 Experimental Section

### 3.6.1 General information

All the glassware were dried in the oven prior to reaction. Commercial grade solvents and reagents were used without further purification. Reactions sensitive to moisture were carried out under an atmosphere of nitrogen. Sodium iodide (NaI) used in the reaction was dried at 80 °C under vacuum, sugar building blocks indicated as commercially available were purchased from GlycoUniverse GmbH. Anhydrous solvents were obtained from a solvent drying system (JCMeyer) or dried according to reported procedures. Analytical TLC was performed on Kieselgel 60 F<sub>254</sub> glass (Macherey-Nagel). Spots were visualized with UV light ( $\lambda$ : 254 nm), sulphuric acid stain [1 mL of 3-methoxyphenol in 1 L of EtOH and 30 mL H<sub>2</sub>SO<sub>4</sub>] or ceric ammonium molybdate stain [0.5 g Ce(NH<sub>4</sub>)<sub>4</sub>(SO<sub>4</sub>)<sub>4</sub>•2H<sub>2</sub>O, 12 g (NH<sub>4</sub>)<sub>6</sub>Mo<sub>7</sub>O<sub>24</sub>•4H<sub>2</sub>O and 15 mL H<sub>2</sub>SO<sub>4</sub> in 235 mL H<sub>2</sub>O]. Flash chromatography was performed on Kieselgel 60 230-400 mesh (Sigma-Aldrich). Preparative HPLC purifications were performed with an Agilent 1200 Series or Agilent 1260 Infinity II. NMR spectra were recorded on a Varian 400 MHz spectrometer (Agilent), Ascend 400 MHz (cryoprobe, Bruker), Ascend 700 MHz (cryoprobe, Bruker) or Varian 600 MHz (Agilent) at 25 °C unless indicated otherwise. Chemical shifts ( $\delta$ ) are reported in parts per million (ppm) relative to the respective residual solvent peaks (CHCl<sub>3</sub>:  $\delta$  7.26 in <sup>1</sup>H and 77.16 in <sup>13</sup>C; HDO  $\delta$  4.79 in <sup>1</sup>H). Bidimensional and non-decoupled experiments were performed to assign identities of peaks showing relevant structural features. The following abbreviations are used to indicate peak multiplicities: s (singlet), d (doublet) dd (doublet of doublets), t (triplet), dt (doublet of triplets), td (triplet of doublets), q (quartet), p (pentet), m (multiplet). Additional descriptors b (broad signal) and app (apparent first-order multiplet) are also employed when required. Coupling constants (J) are reported in Hertz (Hz). NMR spectra were processed using MestreNova 14.1 (MestreLab Research). High-resolution mass spectra (ESI-HRMS) were recorded with a Xevo G2-XS Q-ToF (Waters).

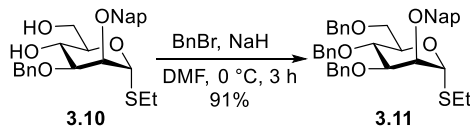
### 3.7.2 Experimental procedure and spectral data

#### Ethyl 2-*O*-(2-naphthylmethyl)-3-*O*-benzyl-1-thio- $\alpha$ -D-mannopyranoside (**3.10**)



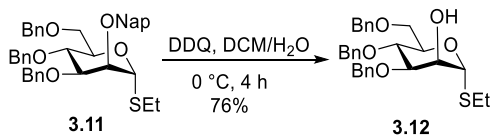
To a solution of compound **3.9** (2.2 g, 4.05 mmol) in DCM/MeOH (99:1, v/v) (20 mL), was added ethanethiol (1.46 mL, 20.25 mmol) and CSA (188 mg, 0.81 mmol). After stirring at room temperature overnight, the mixture was quenched with Et<sub>3</sub>N and concentrated *in vacuo*. The residue was purified by silica gel column chromatography using 30% ethyl acetate in hexanes to give diol **3.10** (1.73 g, 94%). <sup>1</sup>H NMR (400 MHz, CDCl<sub>3</sub>)  $\delta$  7.86 – 7.74 (m, 4H), 7.54 – 7.43 (m, 3H), 7.29 (dtd,  $J = 13.2, 5.3, 2.6$  Hz, 5H), 5.40 (d,  $J = 1.4$  Hz, 1H), 4.88 – 4.68 (m, 2H), 4.63 – 4.37 (m, 2H), 4.14 (t,  $J = 9.6$  Hz, 1H), 4.05 – 3.96 (m, 1H), 3.93 – 3.83 (m, 3H), 3.68 (dd,  $J = 9.4, 3.0$  Hz, 1H), 2.59 (dd,  $J = 11.2, 7.4$  Hz, 2H), 1.24 (t,  $J = 7.4$  Hz, 3H). <sup>13</sup>C NMR (101 MHz, CDCl<sub>3</sub>)  $\delta$  137.8, 135.4, 133.3, 133.1, 128.6, 128.4, 128.1, 128.0, 127.8, 126.8, 126.3, 126.1, 126.0, 82.3, 79.9, 77.5, 77.2, 76.8, 75.8, 72.6, 72.4, 71.9, 67.5, 62.8, 25.5, 14.9. HR-ESI-MS (m/z): calculated for C<sub>26</sub>H<sub>30</sub>O<sub>5</sub>SNa [M+Na]<sup>+</sup>: 477.1712, found: 477.1710

#### Ethyl 2-*O*-(2-naphthylmethyl)-3,4,6-tri-*O*-benzyl-1-thio- $\alpha$ -D-mannopyranoside (**3.11**)



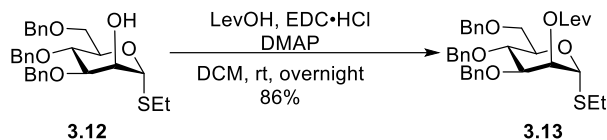
To a cooled solution of **3.10** (1.73 g, 3.8 mmol) in DMF (15 mL) at 0 °C were added benzyl bromide (1.35 mL, 11.4 mmol) and NaH (60% disp.) (425 mg, 10.64 mmol). After stirring for 10 h, the mixture was neutralized with H<sub>2</sub>O and added EtOAc. The organic layer was washed with H<sub>2</sub>O for five times and brine, dried over Na<sub>2</sub>SO<sub>4</sub> and concentrated *in vacuo*. The residue was purified by silica column chromatography using 8% ethyl acetate in hexanes to yield the desired compound **3.11** (2.19 g, 91%). <sup>1</sup>H NMR (400 MHz, CDCl<sub>3</sub>)  $\delta$  7.90 – 7.76 (m, 4H), 7.58 (dd,  $J = 8.4, 1.6$  Hz, 1H), 7.55 – 7.48 (m, 2H), 7.44 – 7.29 (m, 13H), 7.23 (dd,  $J = 7.4, 2.2$  Hz, 2H), 5.51 (d,  $J = 1.5$  Hz, 1H), 4.99 – 4.85 (m, 3H), 4.74 (d,  $J = 12.1$  Hz, 1H), 4.68 – 4.61 (m, 2H), 4.61 – 4.55 (m, 2H), 4.24 – 4.17 (m, 1H), 4.13 (t,  $J = 9.4$  Hz, 1H), 3.97 – 3.85 (m, 3H), 3.78 (dd,  $J = 10.9, 1.9$  Hz, 1H), 2.75 – 2.53 (m, 2H), 1.28 (t,  $J = 7.4$  Hz, 3H). <sup>13</sup>C NMR (101 MHz, CDCl<sub>3</sub>)  $\delta$  138.6, 138.5, 138.4, 135.7, 133.3, 133.1, 128.5, 128.4, 128.4, 128.3, 128.1, 127.9, 127.8, 127.7, 127.7, 127.6, 126.8, 126.2, 126.1, 126.0, 82.0, 80.5, 77.5, 77.2, 76.8, 76.4, 75.2, 75.2, 73.4, 72.2, 72.2, 72.1, 69.3, 25.4, 15.1. HR-ESI-MS (m/z): calculated for C<sub>40</sub>H<sub>42</sub>O<sub>5</sub>SNa [M+Na]<sup>+</sup>: 657.2651, found: 657.2641.

#### Ethyl 2-*O*-(2-naphthylmethyl)-3,4,6-tri-*O*-benzyl-1-thio- $\alpha$ -D-mannopyranoside (**3.12**)



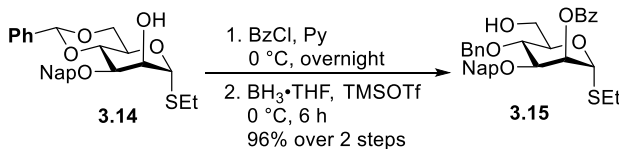
To the solution of **3.11** (1.6 g, 2.52 mmol) in 15 mL DCM/H<sub>2</sub>O (7:1) at 0 °C added DDQ (743 mg, 3.28 mmol) and stirred the reaction mixture for 5 h. After completion of reaction, excess DDQ was quenched by addition of saturated sodium thiosulphate, extracted the organic phase using DCM and combined layers were dried on the Na<sub>2</sub>SO<sub>4</sub>. The organic phase was evaporated in vacuum and crude was purified by silica gel column chromatography (10 % ethyl acetate in hexanes) to get the desired compound **3.12** (0.94 g, 76 %). <sup>1</sup>H NMR (400 MHz, CDCl<sub>3</sub>) δ 7.29 – 7.17 (m, 13H), 7.10 (dd, *J* = 7.3, 2.1 Hz, 2H), 5.32 (d, *J* = 1.5 Hz, 1H), 4.74 (d, *J* = 10.8 Hz, 1H), 4.60 (d, *J* = 1.0 Hz, 2H), 4.57 (s, 1H), 4.47 – 4.39 (m, 2H), 4.14 – 4.05 (m, 1H), 4.02 (dd, *J* = 3.2, 1.5 Hz, 1H), 3.87 – 3.67 (m, 3H), 3.61 (dd, *J* = 10.8, 2.0 Hz, 1H), 2.65 – 2.42 (m, 2H), 1.20 (t, *J* = 7.4 Hz, 3H). <sup>13</sup>C NMR (101 MHz, CDCl<sub>3</sub>) δ 138.4, 138.3, 137.8, 128.7, 128.5, 128.4, 128.2, 128.1, 128.0, 128.0, 127.8, 127.7, 83.4, 80.6, 77.5, 77.2, 76.8, 75.3, 74.6, 73.5, 72.2, 71.5, 70.0, 68.9, 25.0, 15.0. HR-ESI-MS (*m/z*): calculated for C<sub>29</sub>H<sub>34</sub>O<sub>5</sub>SNa [M+Na]<sup>+</sup>: 517.2025, found: 517.2019.

#### Ethyl 2-*O*-levulinoyl-3,4,6-tri-*O*-benzyl-1-thio- $\alpha$ -D-mannopyranoside (**3.13**)



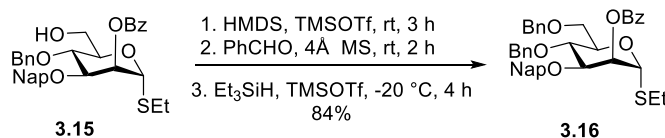
To a solution of compound **3.12** (2.0 g, 4.04 mmol) in DCM (20 mL) were added 4-dimethylaminopyridine (98 mg, 0.81 mmol), levulinic acid (617  $\mu$ L, 6.06 mmol) and EDC·HCl (1.16 g, 6.06 mmol). The mixture was stirred overnight at room temperature, washed with saturated aqueous NaHCO<sub>3</sub> and brine, the organic layer was dried over Na<sub>2</sub>SO<sub>4</sub>, filtered and concentrated. The residue was purified by silica gel column chromatography using 30% ethyl acetate in hexanes to afford compound **3.13** (2.06 g, 86%) as a white solid. <sup>1</sup>H NMR (400 MHz, CDCl<sub>3</sub>) δ 7.39 – 7.29 (m, 14H), 7.20 (dd, *J* = 7.3, 2.1 Hz, 2H), 5.46 (t, *J* = 2.1 Hz, 1H), 5.33 (d, *J* = 1.5 Hz, 1H), 4.88 (d, *J* = 10.8 Hz, 1H), 4.70 (dd, *J* = 11.6, 3.8 Hz, 2H), 4.57 – 4.48 (m, 3H), 4.24 – 4.15 (m, 1H), 3.98 – 3.90 (m, 2H), 3.86 (dd, *J* = 10.8, 4.2 Hz, 1H), 3.71 (dd, *J* = 10.8, 2.0 Hz, 1H), 2.81 – 2.71 (m, 4H), 2.72 – 2.53 (m, 2H), 2.17 (s, 3H), 1.30 (t, *J* = 7.4 Hz, 3H). <sup>13</sup>C NMR (101 MHz, CDCl<sub>3</sub>) δ 206.5, 172.1, 138.5, 138.3, 137.9, 128.5, 128.4, 128.3, 128.0, 127.9, 127.8, 127.7, 82.4, 78.6, 77.5, 77.2, 76.8, 75.3, 74.6, 73.5, 71.9, 71.8, 70.8, 68.9, 38.1, 29.9, 28.3, 25.6, 15.0. HR-ESI-MS (*m/z*): calculated for C<sub>34</sub>H<sub>40</sub>O<sub>7</sub>SNa [M+Na]<sup>+</sup>: 615.2392, found: 615.2380.

#### Ethyl 2-*O*-benzoyl-4-*O*-benzyl-3-*O*-(2-naphthylmethyl)-1-thio- $\alpha$ -D-mannopyranoside (**3.15**)



To the solution of **3.14** (4.05 g, 8.89 mmol) in anhydrous DCM (40 mL), Et<sub>3</sub>N (1.36 mL, 9.78 mmol) and BzCl (1.24 mL, 10.67 mmol) were added and the mixture was stirred at 0 °C overnight. After the completion of reaction, the solution was diluted with DCM (10 mL) and the organic layer was saturated aqueous NaHCO<sub>3</sub> and brine. The organic was dried over Na<sub>2</sub>SO<sub>4</sub>, filtered and concentrated. The crude was passed through short bed of silica gel, concentrated and co-evaporated with toluene. The crude was dissolved in the solution of 1 M BH<sub>3</sub>·THF (45 mL) at 0 °C and was added TMSOTf (0.325 mL, 1.79 mmol) and stirred the reaction mixture for 6 h. After completion of reaction, saturated aqueous solution of NaHCO<sub>3</sub> was added at 0 °C, extracted the organic phase using ethyl acetate and combined layer was dried on the Na<sub>2</sub>SO<sub>4</sub>. The organic phase was evaporated in vacuum and crude was purified by silica gel column chromatography (20 % ethyl acetate in hexanes) to get the desired compound **3.15** (4.8 g, 96 %). <sup>1</sup>H NMR (400 MHz, CDCl<sub>3</sub>) δ 8.11 (dd, *J* = 8.2, 1.4 Hz, 2H), 7.82 – 7.76 (m, 1H), 7.75 – 7.72 (m, 2H), 7.68 – 7.64 (m, 1H), 7.63 – 7.59 (m, 1H), 7.49 (t, *J* = 7.8 Hz, 2H), 7.46 – 7.40 (m, 3H), 7.31 (dq, *J* = 5.9, 4.4 Hz, 5H), 5.75 (dd, *J* = 2.9, 1.7 Hz, 1H), 5.41 (d, *J* = 1.7 Hz, 1H), 4.94 (dd, *J* = 23.4, 11.2 Hz, 2H), 4.72 (dd, *J* = 18.4, 11.3 Hz, 2H), 4.11 (dt, *J* = 9.0, 3.2 Hz, 2H), 4.08 – 4.03 (m, 1H), 3.87 (q, *J* = 3.4 Hz, 2H), 2.71 – 2.57 (m, 2H), 1.29 (t, *J* = 7.4 Hz, 3H). <sup>13</sup>C NMR (101 MHz, CDCl<sub>3</sub>) δ 165.8, 138.3, 135.3, 133.5, 133.4, 133.1, 130.1, 130.0, 128.7, 128.6, 128.2, 128.2, 128.1, 127.9, 127.8, 127.0, 126.1, 126.1, 126.0, 82.7, 78.7, 77.4, 77.2, 76.9, 75.4, 74.3, 72.4, 71.7, 71.1, 62.2, 25.8, 15.0.

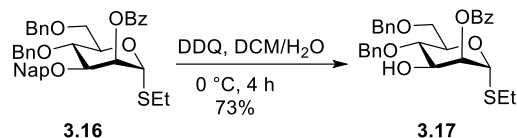
**Ethyl 2-*O*-benzoyl-4,6-di-*O*-benzyl-3-*O*-(2-naphthylmethyl)-1-thio- $\alpha$ -D-mannopyranoside (3.16)**



To the stirring solution of **3.15** (1.0 g, 1.79 mmol) in DCM was added TMSOTf (64  $\mu$ L, 0.36 mmol) and HMDS (0.94 mL, 4.47 mmol). After stirring for 3 h, solvent was evaporated in vacuo followed by addition of DCM, benzaldehyde (0.77 mL, 4.47 mmol) and molecular sieves (4  $\text{\AA}$ ). The mixture was allowed to stir at room temperature for 2 h then cooled to -78 °C, and TMSOTf (97  $\mu$ L, 0.54 mmol) and triethylsilane were added. After the system had been stirred for 4 h, triethylamine was added, and the mixture was allowed to warm gradually to room temperature. The mixture was filtered through Celite, the filtrate was diluted with ethyl acetate and washed with saturated aqueous NaHCO<sub>3</sub> and brine. the organic layer was dried over Na<sub>2</sub>SO<sub>4</sub>, filtered and concentrated. The residue was purified by silica gel column chromatography using 10% ethyl acetate in hexanes to afford compound **3.16** (925 mg, 84%) as a white solid. <sup>1</sup>H NMR (400 MHz, CDCl<sub>3</sub>) δ 8.02 (dd, *J* = 8.3, 1.4 Hz, 2H), 7.73 – 7.68 (m, 1H), 7.68 – 7.63 (m, 2H), 7.59 – 7.54 (m, 1H), 7.49 (s, 0H), 7.37 – 7.32 (m, 3H), 7.32 – 7.28 (m, 4H), 7.27 – 7.21 (m, 2H), 7.21 – 7.18 (m, 3H), 7.13 – 7.09 (m, 2H), 5.70 (dd, *J* = 3.1, 1.8 Hz, 1H), 5.38 (d, *J* = 1.7 Hz, 1H), 4.89 – 4.80 (m, 2H), 4.65 (dd, *J* = 14.1, 11.7 Hz, 2H), 4.47 (dd, *J* = 20.3, 11.4 Hz, 2H), 4.16 (ddd, *J* = 9.8, 3.7, 1.8 Hz, 1H), 4.09 (t, *J* = 9.5 Hz, 1H), 4.01 (dd, *J* = 9.2, 3.1 Hz, 1H), 3.86 (dd, *J* = 10.8, 3.8 Hz, 1H), 3.69 (dd, *J* = 10.8, 1.9 Hz, 1H), 2.66 – 2.50 (m, 2H), 1.22 (t, *J* = 7.4 Hz, 3H). <sup>13</sup>C NMR (101 MHz, CDCl<sub>3</sub>) δ 165.9, 138.5, 135.4, 133.4, 133.3, 133.1, 130.1, 130.1, 128.6, 128.5, 128.5, 128.2, 128.1,

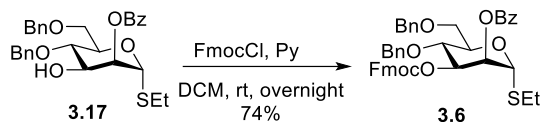
128.0, 127.8, 127.7, 127.6, 127.0, 126.2, 126.1, 125.9, 82.7, 78.8, 75.4, 74.6, 73.6, 72.1, 71.7, 71.0, 69.1, 25.8, 15.1.

### Ethyl 2-*O*-benzoyl-4,6-di-*O*-benzyl-1-thio- $\alpha$ -D-mannopyranoside (**3.17**)



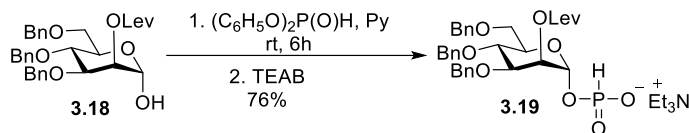
To the solution of **3.16** (600 mg, 1.1 mmol) in 8 mL DCM/H<sub>2</sub>O (7:1) at 0 °C added DDQ (367 mg, 1.62 mmol) and stirred the reaction mixture for 4 h. After completion of reaction, excess DDQ was quenched by addition of saturated sodium thiosulphate, extracted the organic phase using DCM and combined layers were dried on the Na<sub>2</sub>SO<sub>4</sub>. The organic phase was evaporated in vacuum and crude was purified by silica gel column chromatography (20% ethyl acetate in hexanes) to get the desired compound **3.17** (402 mg, 73 %). <sup>1</sup>H NMR (600 MHz, CDCl<sub>3</sub>)  $\delta$  8.07 – 8.01 (m, 2H), 7.60 – 7.54 (m, 1H), 7.41 – 7.37 (m, 4H), 7.36 – 7.28 (m, 5H), 7.28 – 7.24 (m, 3H), 5.47 – 5.42 (m, 2H), 4.77 (dd,  $J$  = 19.6, 11.5 Hz, 2H), 4.65 (d,  $J$  = 11.1 Hz, 1H), 4.54 (d,  $J$  = 11.9 Hz, 1H), 4.23 – 4.15 (m, 2H), 4.05 (t,  $J$  = 9.5 Hz, 1H), 3.94 (dd,  $J$  = 11.0, 3.7 Hz, 1H), 3.77 (dd,  $J$  = 10.9, 1.9 Hz, 1H), 2.73 – 2.57 (m, 2H), 2.17 – 2.12 (m, 1H), 1.29 (t,  $J$  = 7.4 Hz, 3H). <sup>13</sup>C NMR (151 MHz, CDCl<sub>3</sub>)  $\delta$  166.2, 138.4, 138.3, 133.4, 130.0, 129.9, 128.7, 128.6, 128.5, 128.2, 128.1, 127.7, 127.7, 82.5, 77.4, 77.2, 76.9, 76.1, 75.0, 74.8, 73.6, 71.9, 71.4, 69.1, 25.8, 15.1.

### Ethyl 2-*O*-benzoyl-4,6-di-*O*-benzyl-3-fluorenylmethoxycarbonyl-1-thio- $\alpha$ -D-mannopyranoside (**3.6**)



To the solution of **3.17** (300 mg, 0.59 mmol) and pyridine (1 mL) in anhydrous DCM (6 mL), FmocCl (213 mg, 0.83 mmol) was added and the mixture was stirred at room temperature overnight. After the completion of reaction, the solution was diluted with DCM (10 mL) and the organic layer was washed with 10% citric acid, saturated aqueous NaHCO<sub>3</sub> and brine. The organic was dried over Na<sub>2</sub>SO<sub>4</sub>, filtered and concentrated. The crude product was purified by silica gel column chromatography (10% ethyl acetate in hexanes) to give **3.6** as a white solid (319 mg, 74%). <sup>1</sup>H NMR (600 MHz, CDCl<sub>3</sub>)  $\delta$  8.04 – 7.99 (m, 2H), 7.66 (ddt,  $J$  = 7.6, 3.1, 0.9 Hz, 2H), 7.56 – 7.50 (m, 1H), 7.46 (ddd,  $J$  = 7.6, 3.4, 1.0 Hz, 2H), 7.37 – 7.31 (m, 4H), 7.31 – 7.23 (m, 5H), 7.20 – 7.17 (m, 3H), 7.16 (ddt,  $J$  = 7.6, 4.9, 3.2 Hz, 3H), 7.08 (dd,  $J$  = 7.5, 1.1 Hz, 1H), 5.69 (dd,  $J$  = 3.2, 1.7 Hz, 1H), 5.40 (d,  $J$  = 1.7 Hz, 1H), 5.23 – 5.16 (m, 1H), 4.71 (dd,  $J$  = 18.6, 11.4 Hz, 2H), 4.52 (d,  $J$  = 11.1 Hz, 1H), 4.49 – 4.41 (m, 2H), 4.28 – 4.23 (m, 2H), 4.22 – 4.14 (m, 2H), 3.92 – 3.87 (m, 1H), 3.71 (dd,  $J$  = 10.9, 1.2 Hz, 1H), 2.68 – 2.53 (m, 2H), 1.24 (t,  $J$  = 7.4 Hz, 3H). <sup>13</sup>C NMR (151 MHz, CDCl<sub>3</sub>)  $\delta$  165.6, 154.3, 143.8, 143.3, 141.4, 141.3, 138.4, 138.0, 133.5, 130.2, 129.8, 128.6, 128.5, 128.5, 128.0, 127.9, 127.9, 127.7, 127.7, 127.3, 127.2, 125.5, 125.2, 120.1, 120.1, 82.3, 75.3, 73.7, 73.2, 72.1, 72.0, 70.4, 68.9, 46.8, 25.7, 15.0.

## 2-Levulinoyl-3,4,6-tri-*O*-benzyl- $\alpha$ -D-mannopyranosyl triethylammonium salt (**3.19**)



To the solution of hemiacetal **3.18** (150 mg, 0.273 mmol) in anhydrous pyridine (5mL), diphenyl phosphite (260  $\mu\text{L}$ ) was added. The mixture was stirred at room temperature for 2 h. TEAB buffer (20 mL) was added and reaction mixture was stirred for additional 2 h. The reaction was diluted with DCM (20 mL) and washed with TEAB buffer. The organic layer was dried over  $\text{Na}_2\text{SO}_4$ , concentrated and purified by silica gel column chromatography using 5% methanol in DCM which was neutralized with triethylamine to afford the *H*-phosphonate **3.19** (149 mg, 76%) as a light yellow syrup.  $^1\text{H}$  NMR (400 MHz,  $\text{CDCl}_3$ )  $\delta$  11.98 (s, 1H), 7.36 – 7.21 (m, 13H), 7.20 – 7.11 (m, 2H), 5.62 – 5.53 (m, 1H), 5.40 (t,  $J = 3.1$  Hz, 1H), 4.84 (dt,  $J = 11.1, 3.3$  Hz, 1H), 4.63 (ddt,  $J = 12.5, 7.6, 3.6$  Hz, 2H), 4.48 (tdd,  $J = 12.3, 7.4, 3.1$  Hz, 3H), 4.14 – 3.99 (m, 2H), 3.87 (td,  $J = 9.9, 4.2$  Hz, 1H), 3.78 (td,  $J = 7.5, 3.6$  Hz, 1H), 3.71 – 3.62 (m, 1H), 2.99 (q, 7H), 2.75 – 2.58 (m, 4H), 2.08 (s, 3H), 1.27 (t,  $J = 3.3$  Hz, 12H).  $^{13}\text{C}$  NMR (101 MHz,  $\text{CDCl}_3$ )  $\delta$  206.4, 171.8, 138.6, 138.3, 138.1, 129.4, 129.2, 129.2, 128.3, 128.3, 128.2, 128.2, 128.0, 127.9, 127.8, 127.8, 127.7, 127.6, 127.6, 127.5, 115.7, 93.3, 93.2, 77.8, 77.6, 77.5, 77.3, 77.2, 77.0, 76.9, 74.9, 74.1, 73.4, 72.4, 71.7, 69.4, 69.4, 68.9, 45.6, 38.0, 29.8, 28.2, 8.6.  $^{31}\text{P}$  NMR (162 MHz,  $\text{CDCl}_3$ )  $\delta$  -0.2. HR-ESI-MS ( $m/z$ ): calculated for  $\text{C}_{38}\text{H}_{53}\text{NO}_{10}\text{H}$   $[\text{M}+\text{H}]^+$ : 714.3407, found: 714.3405.

## General Procedure for Automated Glycan Assembly

### General material and methods:

Syntheses were performed on a home-built automated synthesizer at the Max Planck Institute of Colloids and Interfaces. All the solvents used were HPLC-grade. The building block, activator, TMSOTf, and capping solutions were prepared with anhydrous solvents and further dried with molecular sieves (4Å) for moisture-sensitive solutions. The building blocks were co-evaporated with toluene (three times) and dried on high vacuum overnight before use. All the flasks were dried in the oven and flushed with argon before use. Capping, activator, deprotection, acidic wash, and building block solutions were freshly prepared and kept under argon during the automation run. Photocleavable linker was synthesized by established procedure. Reported yields are calculated on the basis of resin loading, which was determined as described previously.

The calculated resin loading was 0.4 mmol/g.

### Stock solution preparation:

- **Building blocks:** building block was dissolved in 1 mL dichloromethane (DCM).
- **Acidic wash/phosphate activation:** 0.9 mL (5 mmol) of Trimethylsilyl trifluoromethanesulfonate (TMSOTf) in 40 mL of DCM.
- **Thioglycoside activator:** 1.567 g of NIS (7 mmol) was dissolved in anhydrous DCM/dioxane (2:1, v/v, 45 mL) and TfOH (64  $\mu$ L, 0.7 mmol) was added. The solution was kept at 0 °C during automation run.
- **Pre-capping:** 10% (v/v) pyridine in DMF.
- **Capping:** 1.2 mL of methanesulfonic acid and 6 mL of acetic anhydride in 50 mL of DCM.
- **Fmoc deprotection:** 20% (v/v) piperidine in DMF
- **Lev deprotection:** Hydrazine acetate (725 mg, 7.87 mmol) was dissolved in pyridine/AcOH/H<sub>2</sub>O (52.5 mL, v/v/v, 16:4:1).

## Modules for automated synthesis

### Module A: Resin preparation before synthesis

Photocleavable linker-functionalized resin (40 mg, 16  $\mu$ mol) was placed in the reaction vessel and swollen in DCM for 20 min at room temperature before synthesis. All reagent lines needed for the synthesis were washed and primed. The resin was washed with DMF, THF, and DCM (three times each with 2 mL, for 25 s).

### Module B: Acidic wash

DCM (2 mL) was added to the reaction vessel, and the temperature was adjusted to -20 °C. Upon reaching the temperature, acidic wash solution (1 mL) was delivered to the reaction vessel. After bubbling argon for 3 min, the solution was drained, and the resin was washed with DCM (2 mL, for 25 s).

### Module C: Glycosylation

**Module C.1 (Thioglycoside donor):** Thioglycoside building block (96  $\mu$ mol, 6 equiv.) in 1 mL of DCM was delivered to the reaction vessel, and the mixture was cooled to the incubation temperature (-20 °C). Then thioglycoside activator (1 mL) was added dropwise, and glycosylation

was performed by increasing the temperature to 0 °C for 40 min. After completion of glycosylation, the solution was drained, and the resin was washed with dioxane (2 mL for 20 s) and DCM (twice, each with 2 mL for 25 s).

**Module C.2 (Phosphate donor):** Phosphate building block (128 μmol, 8 equiv.) in 1 mL of DCM was delivered to the reaction vessel, and the mixture was cooled to the incubation temperature (-35 °C). Then phosphate activator (1 mL) was added dropwise, and glycosylation was performed by increasing the temperature to -10 °C for 40 min. After completion of glycosylation, the solution was drained, and the resin was washed DCM (six times, each with 2 mL for 25 s).

### **Module D: Capping**

The resin was washed with DMF (twice, each with 2 mL for 25 s), and the temperature was adjusted to 25 °C, then the pre-capping solution (2 mL) was delivered. After 1 min, the solution was drained, and the resin was washed with DCM (three times with 3 mL for 25 s). Capping solution (4 mL) was delivered into the reaction vessel. After 20 min, the reaction solution was drained, and the resin was washed with DCM (thrice, each with 3 mL for 25 s).

### **Module E: Fmoc deprotection**

The resin was washed with DMF (three times, each with 2 mL for 25 s), and the temperature was adjusted to 25 °C. Fmoc deprotection solution (2 mL) was delivered. After 5 min, the solution was drained, and the resin was washed with DMF (three times, each with 3 mL for 25 s) and DCM (five times, each with 3 mL for 25 s).

### **Module F: Lev deprotection**

The resin was washed with DMF (three times, each with 2 mL for 30 s), and the temperature was adjusted to 35 °C. Lev deprotection solution (0.8 mL) was delivered. After 30 min, the solution was drained, and the resin was washed with DMF (three times, each with 3 mL for 25 s) and DCM (five times, each with 3 mL for 25 s). The entire cycle was repeated three times.

### **Post AGA manipulations**

### **Module G: On-resin phosphodiester linkage formation**

The resin was suspended in a solution of H-phosphonate (10 equiv.) in pyridine (3 mL) and PivCl (5 equiv.) was added. The solution containing resin was rotated for 5 h at room temperature. After 5 h, a solution of I<sub>2</sub> in Pyridine/water (10:1, 300 μL) was added and rotated for another 2 h. After that time, the resin was repeatedly washed with MeOH (4 x 4 mL), THF (4 x 4 mL), DMF (4 x 4 mL) and DCM (4 x 4 mL).



## Module H: On-resin hydrolysis

The resin was suspended in THF (4 mL), and solution of NaOMe in MeOH (200  $\mu$ L, 0.5 M) was added. The mixture was rotated at room temperature for 5 h. After micro cleavage indicated the complete hydrolysis of all the ester groups, the resin was washed with MeOH (4 x 4 mL), THF (4 x 4 mL), DMF (4 x 4 mL) and DCM (4 x 4 mL).

## Module I: Micro-cleavage from solid support

Trace amount of resin (around 10 beads) was dispersed in DCM (0.2 mL) and irradiated with a UV lamp (254 nm) for 10 min. MeOH was then added to the resin, and the resulting solution was analyzed by Q-TOF mass spectrometry.

## Module J: Cleavage from solid support

The oligosaccharides were cleaved from the solid support using a continuous-flow photo reactor. A 10% MeOH in DCM solvent system was used for photo cleavage.

## Module K: Hydrogenolysis

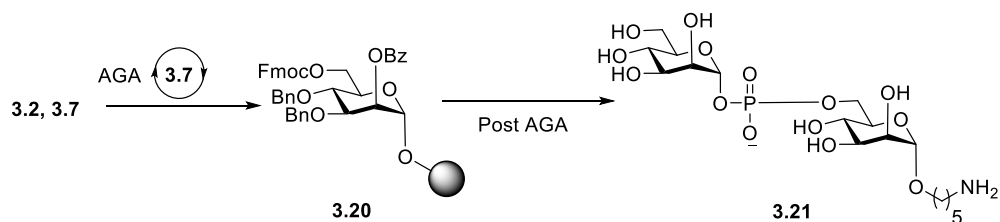
The crude compound obtained from Module J was dissolved in 3.75 mL of *t*-BuOH:EtOAc:H<sub>2</sub>O (2:2:1). Pd catalyst (100 mg) was added, and the reaction was stirred at room temperature under hydrogen atmosphere (1 atm, balloon). Upon completion, the mixture was filtered through Celite and concentrated *in vacuo*.

## Module L: Purification

- **Method A:** HPLC (YMC-Diol-300 column, 150 x 4.6 mm, Hexane isocratic (5 Min), linear gradient to 60% EtOAc (35 Min), linear gradient to 100% EtOAc (10 min))
- **Method B:** HPLC (Hypercarb column, 150 x 10 mm, H<sub>2</sub>O (0.1% formic acid) isocratic (5 min), linear gradient to 40% ACN (30 min), linear gradient to 100% ACN (10 min)) and lyophilized.

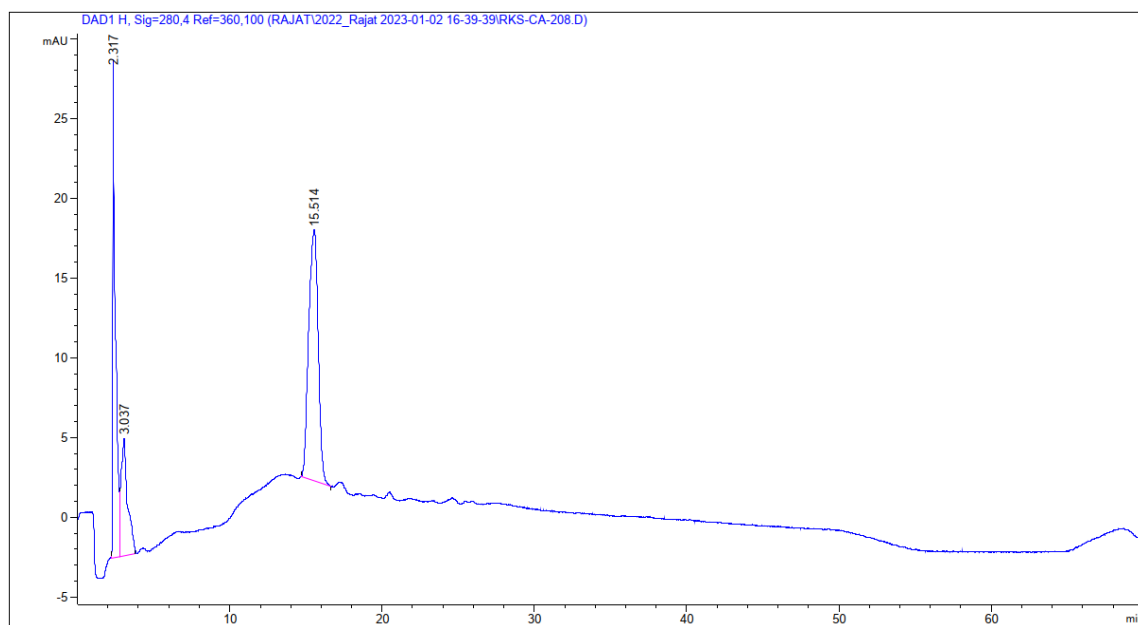
## Oligosaccharides synthesis

### Synthesis of 3.21

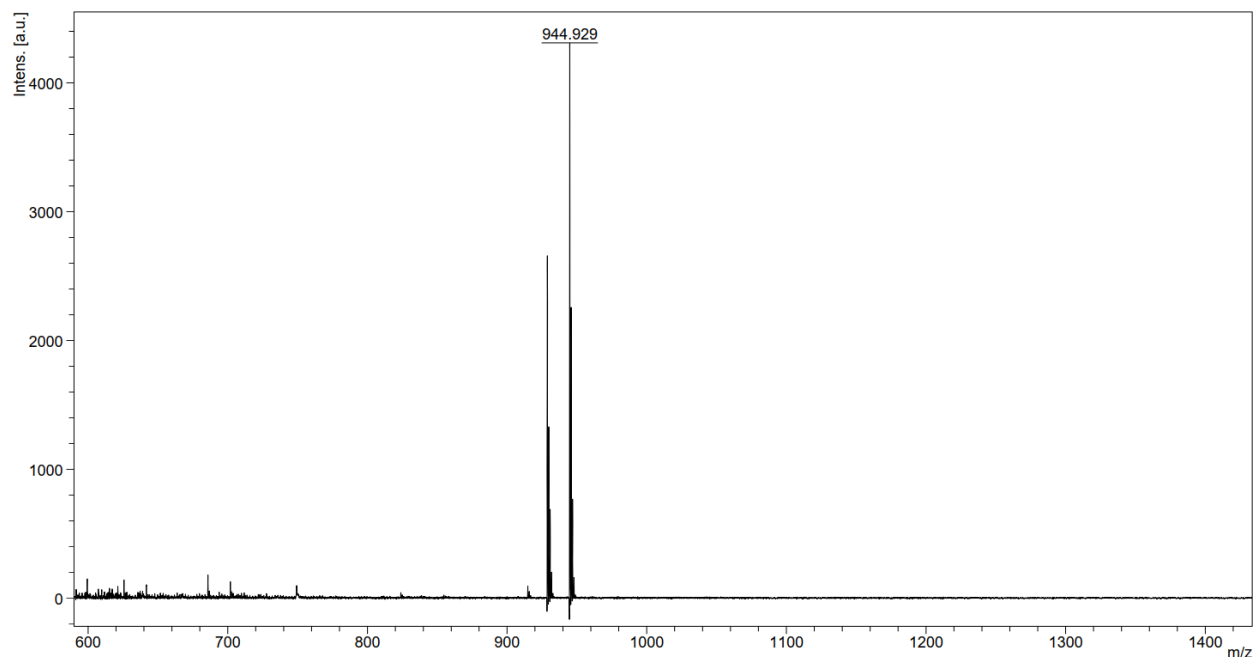


Step	Module	Conditions	Cycles
AGA	A: Resin Preparation for Synthesis		
	B: Acidic Wash with TMSOTf Solution	Building block <b>3.7</b> (6 equiv) -20 °C for 20 min, 0 °C for 20 min	1
	C.1: Thioglycoside Glycosylation		
	D: Capping		
Post AGA	E: Fmoc deprotection		
	G: Phosphodiester linkage formation		
	H: Hydrolysis		
	J: Cleavage from solid support		
	K: Hydrogenolysis		
	L(Method B): Purification		

### Analytical HPLC (Method A, 280 nm) of crude protected **3.20**



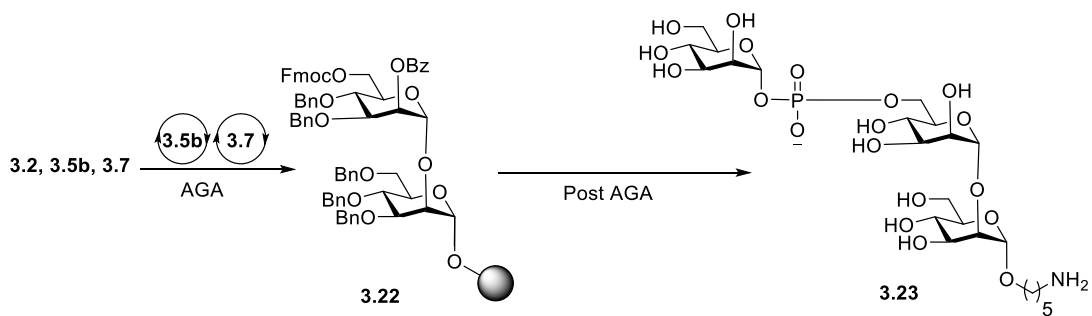
### MALDI of **3.20**



Compound **3.21** was obtained as a white solid (2.0 mg, 25% overall yield)

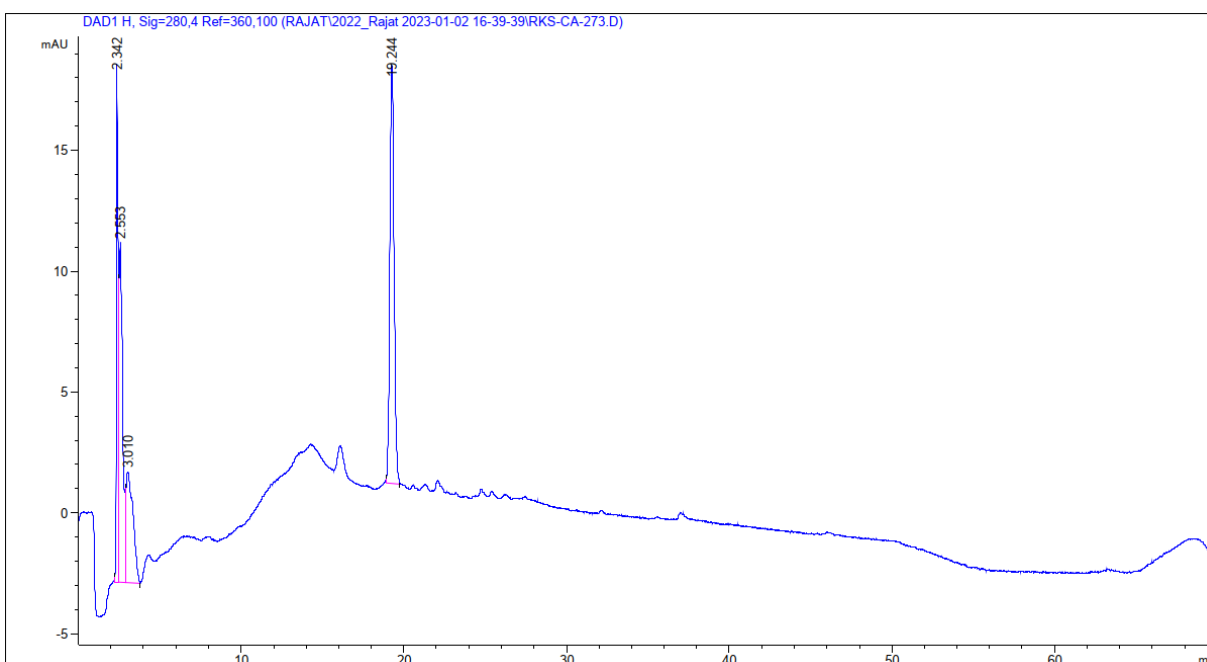
Analytical data for **3.21**.  $^1\text{H}$  NMR (600 MHz,  $\text{D}_2\text{O}$ )  $\delta$  5.46 – 5.40 (m, 1H), 4.86 (d,  $J = 1.7$  Hz, 1H), 4.22 – 4.16 (m, 1H), 4.03 (dd,  $J = 11.8, 6.0$  Hz, 1H), 4.00 (dd,  $J = 3.4, 2.0$  Hz, 1H), 3.92 (dd,  $J = 3.5, 1.7$  Hz, 1H), 3.91 – 3.89 (m, 1H), 3.89 – 3.86 (m, 1H), 3.84 – 3.80 (m, 1H), 3.79 – 3.77 (m, 1H), 3.76 (d,  $J = 3.3$  Hz, 1H), 3.74 (d,  $J = 2.5$  Hz, 1H), 3.73 (s, 1H), 3.67 (dt,  $J = 22.3, 9.8$  Hz, 2H), 3.60 – 3.54 (m, 1H), 2.99 (t,  $J = 7.6$  Hz, 2H), 1.68 (dt,  $J = 25.1, 10.1$  Hz, 4H), 1.49 – 1.42 (m, 2H).  $^{13}\text{C}$  NMR (176 MHz,  $\text{D}_2\text{O}$ )  $\delta$  171.0, 99.7, 96.1, 73.7, 71.8, 71.7, 70.5, 70.3, 69.9, 69.8, 67.3, 66.4, 66.2, 64.9, 60.7, 39.3, 27.9, 26.3, 22.3.  $^{31}\text{P}$  NMR (162 MHz,  $\text{D}_2\text{O}$ )  $\delta$  -1.9.

### Synthesis of **3.23**

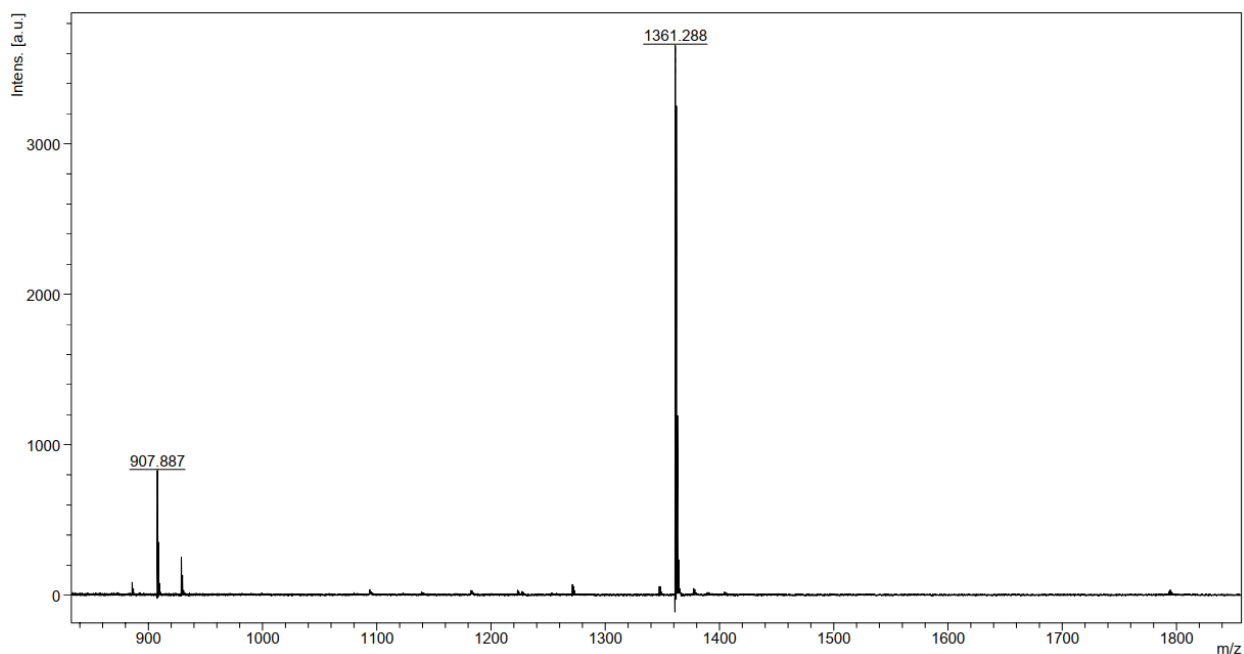


Step	Module	Conditions	Cycles
AGA	A: Resin Preparation for Synthesis		
	B: Acidic Wash with TMSOTf Solution	Building block <b>3.5b</b> (8 equiv) -35 °C for 10 min, -10 °C for 30 min	1
	C.2: Phosphate Glycosylation		
	D: Capping		
	F: Lev Deprotection	Building block <b>3.7</b> (6 equiv) -20° for 20 min, 0° for 20 min	1
	B: Acidic Wash with TMSOTf Solution		
	C.1: Thioglycoside Glycosylation		
	D: Capping		
	E: Fmoc deprotection		
Post	G: Phosphodiester linkage formation		
AGA	H: Hydrolysis		
	J: Cleavage form solid support		
	K: Hydrogenolysis		
	L(Method B): Purification		

### Analytical HPLC (Method A, 280 nm) of crude protected **3.22**



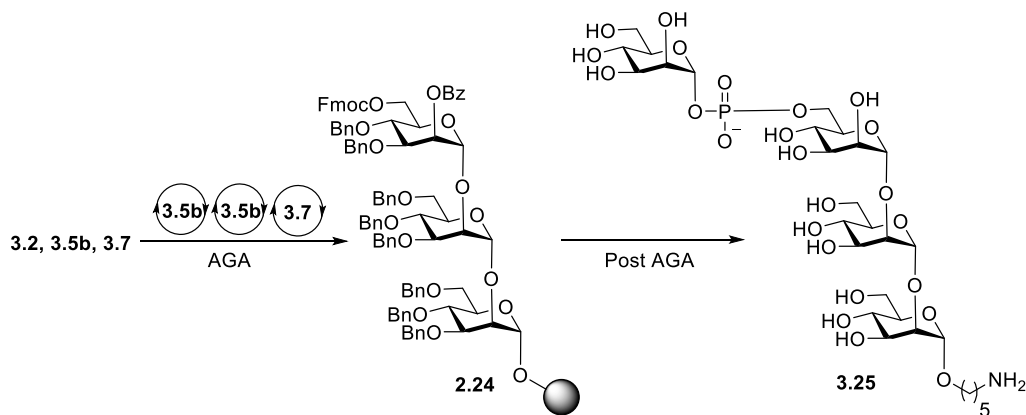
## MALDI of **3.22**



Compound **3.23** was obtained as a white solid (2.0 mg, 19% overall yield)

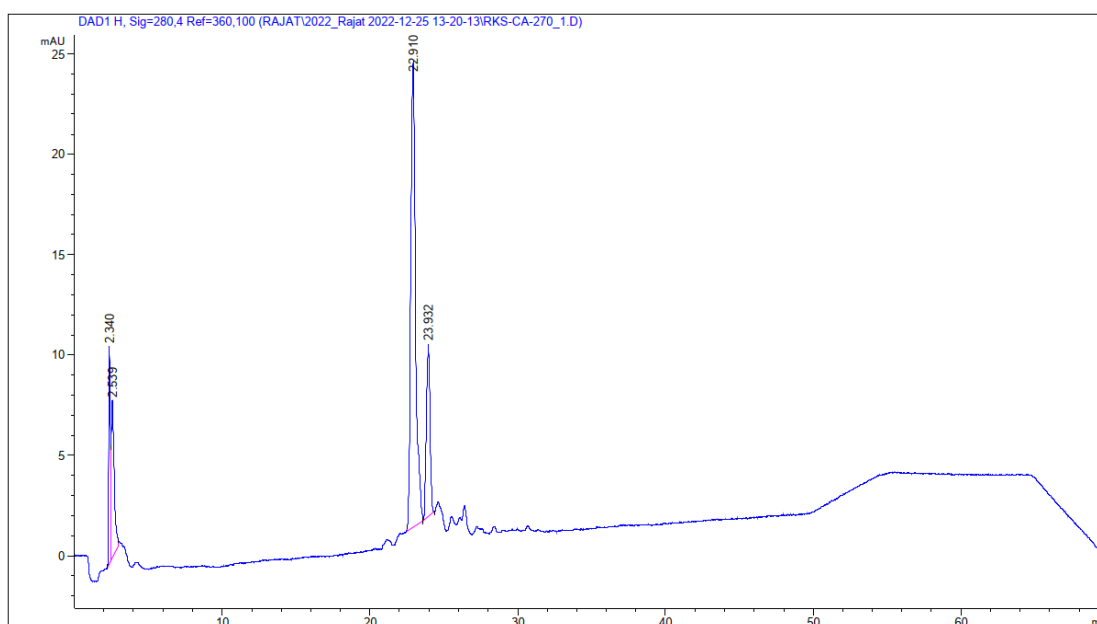
Analytical data for **3.23**.  $^1\text{H}$  NMR (400 MHz,  $\text{D}_2\text{O}$ )  $\delta$  5.39 (dd,  $J = 8.0, 2.0$  Hz, 1H), 5.04 (d,  $J = 1.7$  Hz, 1H), 4.97 (d,  $J = 1.9$  Hz, 1H), 4.12 (ddd,  $J = 11.2, 5.5, 1.9$  Hz, 1H), 4.03 (dd,  $J = 3.4, 1.8$  Hz, 1H), 4.02 – 3.95 (m, 2H), 3.90 (dd,  $J = 3.4, 1.7$  Hz, 1H), 3.89 – 3.81 (m, 6H), 3.79 (d,  $J = 3.4$  Hz, 1H), 3.77 – 3.65 (m, 4H), 3.65 – 3.61 (m, 2H), 3.56 (ddd,  $J = 12.2, 6.2, 3.2$  Hz, 2H), 2.96 (dd,  $J = 8.2, 6.8$  Hz, 2H), 1.64 (dt,  $J = 13.0, 7.3$  Hz, 4H), 1.50 – 1.35 (m, 2H).  $^{13}\text{C}$  NMR (101 MHz,  $\text{D}_2\text{O}$ )  $\delta$  102.4, 98.2, 96.1, 96.0, 78.9, 73.7, 72.7, 72.1, 72.0, 70.4, 70.3, 70.2, 70.1, 69.8, 69.8, 67.6, 66.8, 66.4, 66.3, 65.1, 65.1, 60.8, 60.8, 39.2, 27.9, 26.3, 22.3.  $^{31}\text{P}$  NMR (162 MHz,  $\text{D}_2\text{O}$ )  $\delta$  -2.0.

## Synthesis of **3.25**

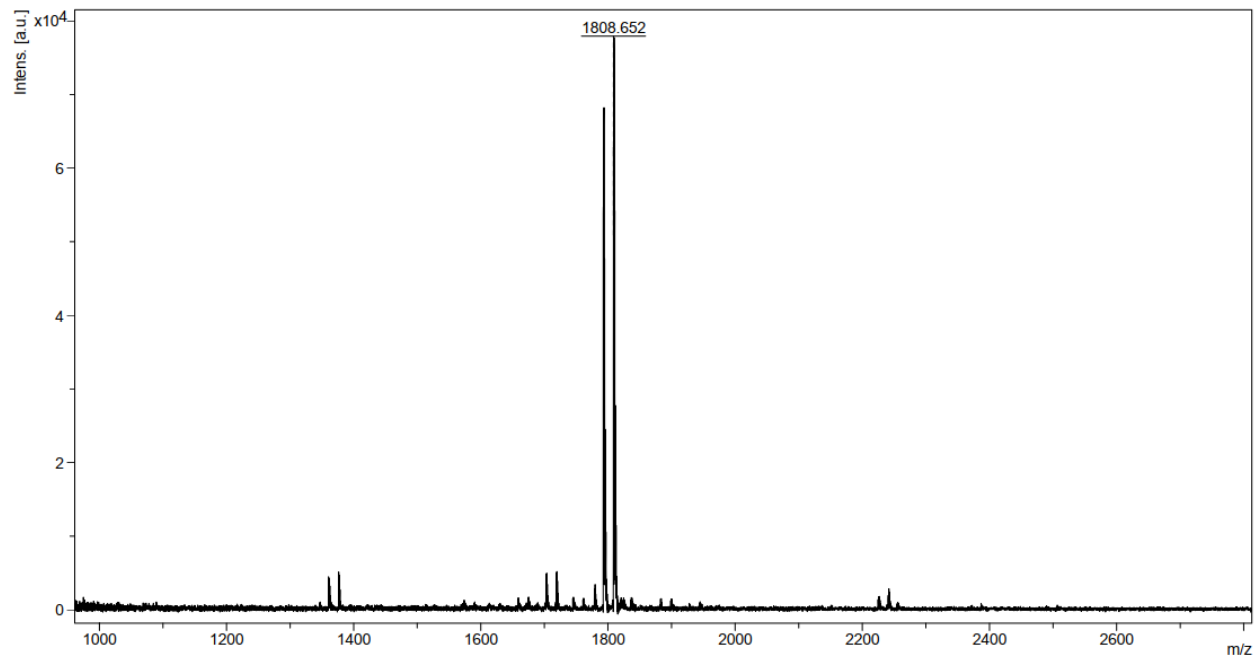


Step	Module	Conditions	Cycles
AGA	A: Resin Preparation for Synthesis		
	B: Acidic Wash with TMSOTf Solution	Building block <b>3.5b</b> (8 equiv) -35 °C for 10 min, -10 °C for 30 min	2
	C.2: Phosphate Glycosylation		
	D: Capping		
	F: Lev Deprotection		
	B: Acidic Wash with TMSOTf Solution	Building block <b>3.7</b> (6 equiv) -20 °C for 20 min, 0 °C for 20 min	1
	C.1: Thioglycoside Glycosylation		
	D: Capping		
Post AGA	E: Fmoc Deprotection G: Phosphodiester linkage formation H: Hydrolysis J: Cleavage form solid support K: Hydrogenolysis L(Method B): Purification		

Analytical HPLC (Method A, 280 nm) of crude protected **3.24**



## MALDI of **2.24**



Compound **3.25** was obtained as a white solid (2.8 mg, 21% overall yield)

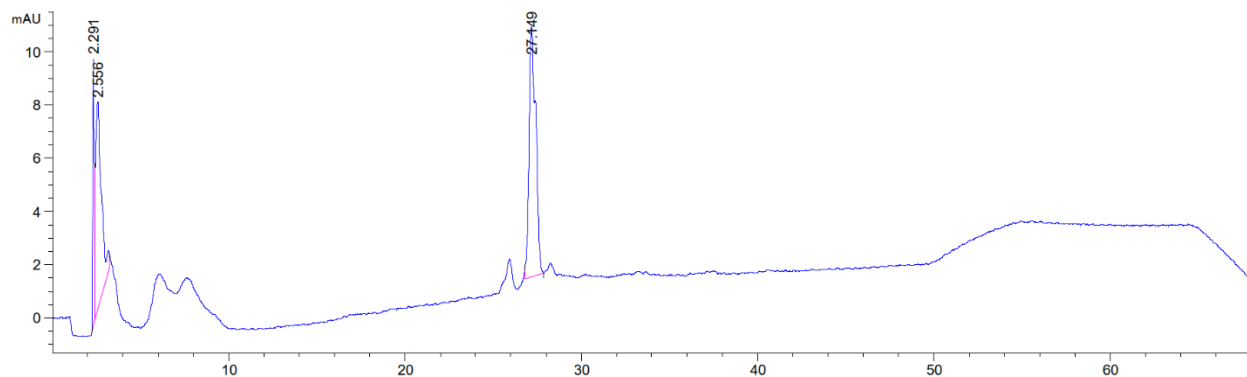
Analytical data for **3.25**. <sup>1</sup>H NMR (400 MHz, D<sub>2</sub>O) δ 5.32 (dd, *J* = 7.9, 2.0 Hz, 1H), 5.15 (d, *J* = 1.8 Hz, 1H), 4.90 (dd, *J* = 5.9, 1.8 Hz, 2H), 4.04 (ddd, *J* = 7.5, 5.6, 2.8 Hz, 1H), 3.98 (dd, *J* = 3.4, 1.8 Hz, 1H), 3.94 (dt, *J* = 4.4, 2.2 Hz, 1H), 3.92 – 3.85 (m, 3H), 3.84 – 3.68 (m, 9H), 3.68 – 3.64 (m, 1H), 3.64 – 3.37 (m, 10H), 2.87 (t, *J* = 7.5 Hz, 2H), 1.57 – 1.44 (m, 4H), 1.41 – 1.24 (m, 2H). <sup>13</sup>C NMR (101 MHz, D<sub>2</sub>O) δ 102.3, 100.7, 98.1, 96.2, 96.1, 78.7, 78.3, 73.7, 73.3, 72.7, 72.0, 71.9, 70.4, 70.3, 70.1, 69.8, 69.8, 67.4, 66.9, 66.6, 66.4, 66.3, 65.1, 61.0, 60.9, 60.8, 39.3, 27.9, 26.4, 22.4. <sup>31</sup>P NMR (162 MHz, D<sub>2</sub>O) δ -1.9.

## Synthesis of **3.26**



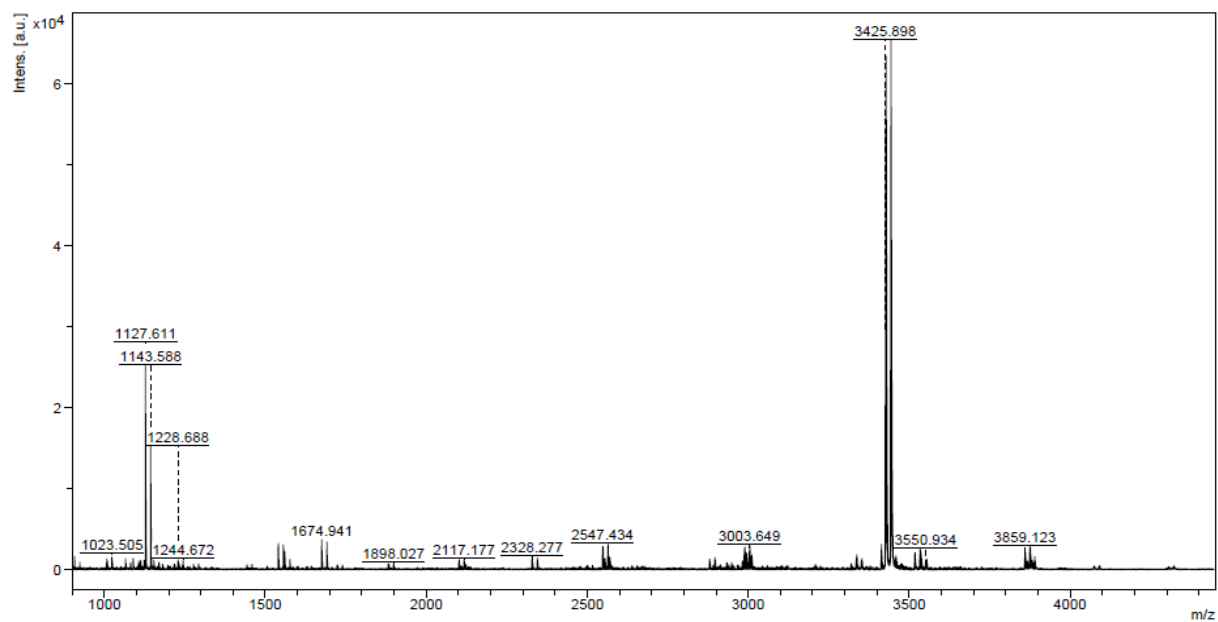


### Analytical HPLC (Method A, 280 nm) of crude protected **3.26**

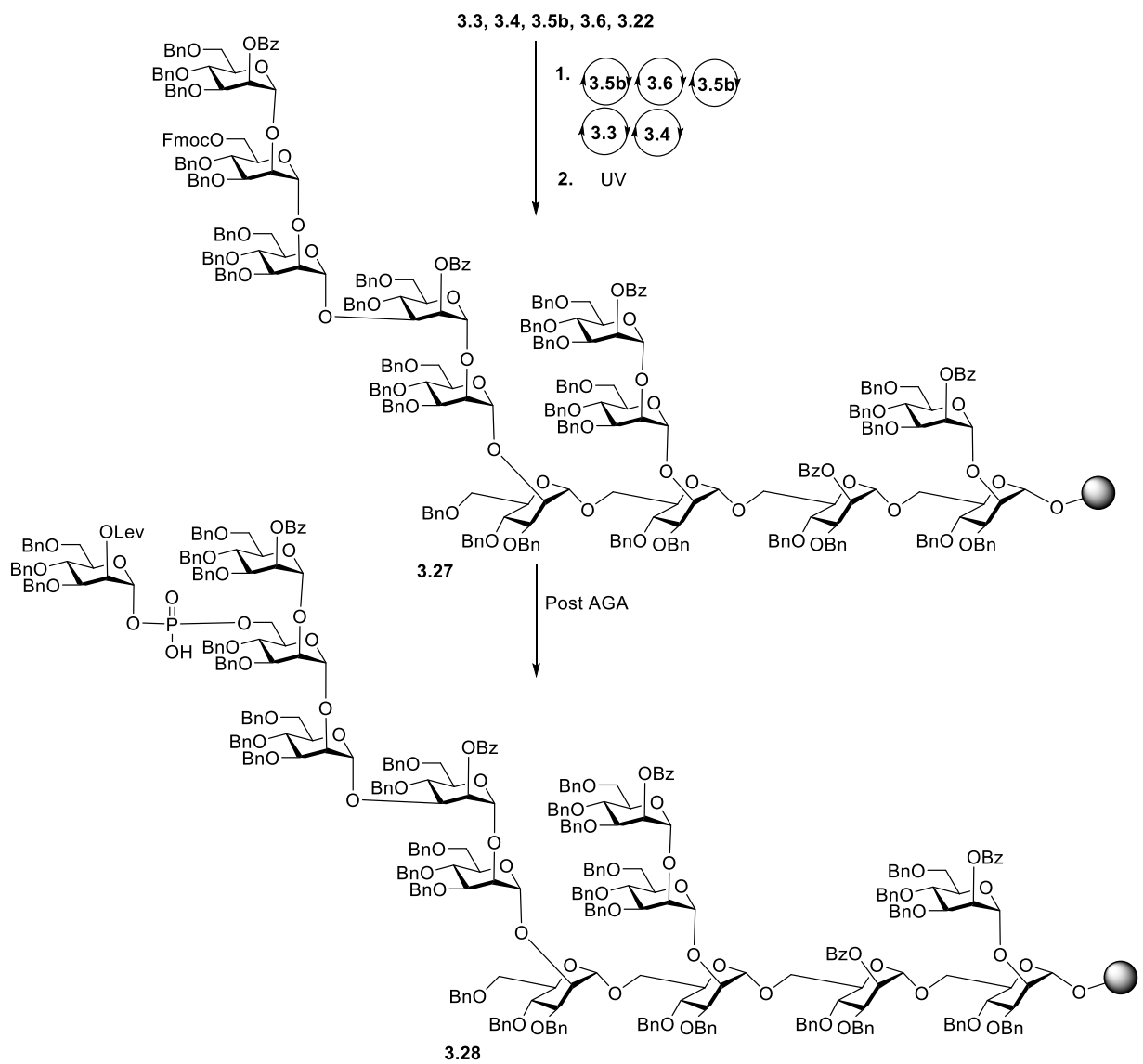


### MALDI of **3.26**

Comment 1  
Comment 2



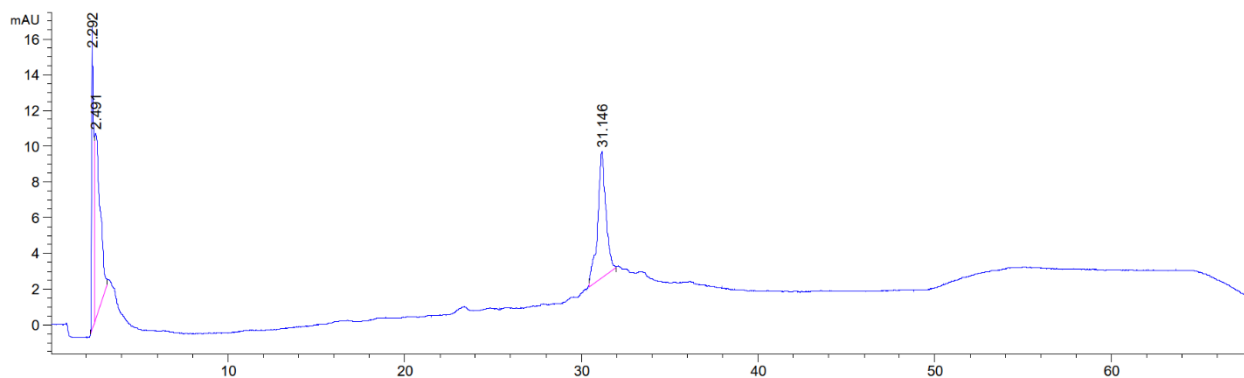
### Synthesis of **3.28**



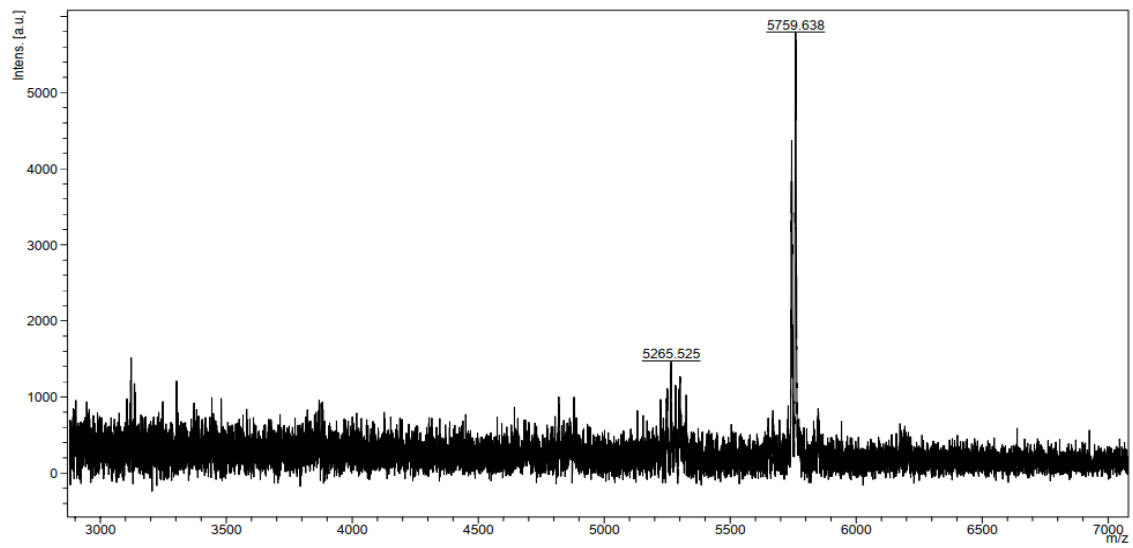
Step	Module	Conditions	Cycles
AGA	A: Resin Preparation for Synthesis		
	B: Acidic Wash with TMSOTf Solution		
	C.2: Phosphate Glycosylation	Building block <b>3.5b</b> (8 equiv) -35 °C for 10 min, -10 °C for 30 min	2
	D: Capping F: Lev Deprotection		

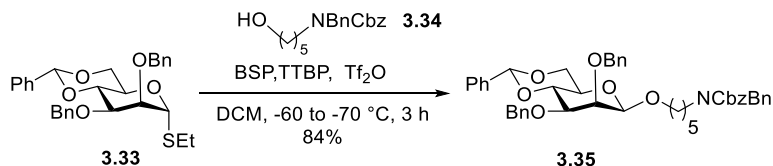
B: Acidic Wash with TMSOTf Solution	Building block <b>3.6</b> (6 equiv) -20 °C for 20 min, 0 °C for 20 min	}	1
C.1: Thioglycoside Glycosylation			
D: Capping			
E: Fmoc Deprotection			
B: Acidic Wash with TMSOTf Solution	Building block <b>3.3</b> (6 equiv) -20 °C for 20 min, 0 °C for 20 min	}	1
C.1: Thioglycoside Glycosylation			
D: Capping			
F: Lev Deprotection			
B: Acidic Wash with TMSOTf Solution	Building block <b>3.4</b> (6 equiv) -20 °C for 20 min, 0 °C for 20 min	}	1
C.1: Thioglycoside Glycosylation			
D: Capping			
F: Fmoc Deprotection			
<hr/>			
Post AGA	G: Phosphodiester linkage formation		
<hr/>			

Analytical HPLC (Method A, 280 nm) of crude protected **3.28**

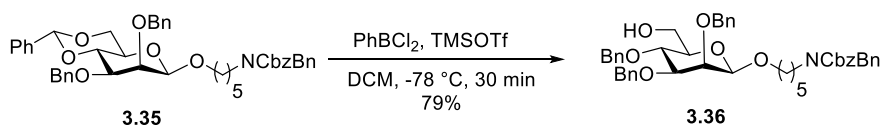


MALDI of **3.28**



**N-(Benzyl)benzyloxycarbonyl-5-aminopentyl mannopyranoside (3.35)****2,3-O-di-benzyl-4,6-O-benzylidene-β-D-**

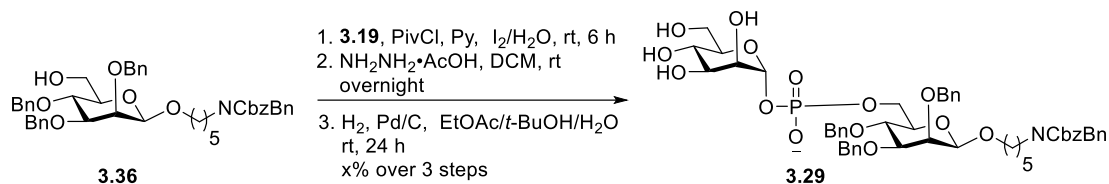
To the solution of donor **3.33** (315 mg, 0.641 mmol) in DCM (8 mL) was added molecular sieves (4 Å) and stirred the solution for 30 min. BSP (128 mg, 0.614 mmol) and TTBP (212 mg, 0.586 mmol) were added to the reaction mixture at -60 °C and stirred the reaction for 30 min. After stirring for 30 min, Tf<sub>2</sub>O (179 μL, 1.07 mmol) was added and stirred the mixture for another 30 min. The reaction mixture was brought to -70 °C and acceptor **3.34** (70 mg, 0.214 mmol) was added. After stirring for 2 h, reaction was quenched by adding Et<sub>3</sub>N (0.5 mL) and filtered through Celite®. Organic layer was washed with saturated aqueous sodium bicarbonate, dried over Na<sub>2</sub>SO<sub>4</sub> and evaporated *in vacuo*. The crude was purified by silica gel column chromatography (10% ethyl acetate in hexanes) to get linker attached monosaccharide **3.35** (136 mg, 84%). <sup>1</sup>H NMR (400 MHz, CDCl<sub>3</sub>) δ 7.54 – 7.49 (m, 2H), 7.46 (d, *J* = 7.0 Hz, 2H), 7.42 – 7.35 (m, 5H), 7.34 – 7.26 (m, 15H), 7.18 (d, *J* = 7.2 Hz, 1H), 5.63 (s, 1H), 5.18 (d, *J* = 14.6 Hz, 2H), 5.01 – 4.93 (m, 1H), 4.86 (d, *J* = 12.3 Hz, 1H), 4.75 – 4.63 (m, 1H), 4.59 (d, *J* = 12.5 Hz, 1H), 4.51 (d, *J* = 9.0 Hz, 2H), 4.41 (d, *J* = 19.0 Hz, 1H), 4.31 (dd, *J* = 10.4, 4.8 Hz, 1H), 4.22 (t, *J* = 9.6 Hz, 1H), 3.99 – 3.81 (m, 3H), 3.58 (dd, *J* = 9.9, 3.2 Hz, 1H), 3.45 – 3.15 (m, 3H), 1.68 – 1.52 (m, 4H), 1.41 – 1.32 (m, 2H). <sup>13</sup>C NMR (101 MHz, CDCl<sub>3</sub>) δ 156.8, 156.3, 138.5, 138.4, 138.0, 137.8, 137.7, 137.0, 136.8, 129.0, 128.8, 128.8, 128.7, 128.6, 128.6, 128.6, 128.5, 128.4, 128.4, 128.3, 128.3, 128.2, 128.1, 127.9, 127.8, 127.7, 127.4, 127.3, 126.2, 126.2, 102.4, 101.5, 94.1, 79.4, 79.1, 78.7, 78.0, 77.5, 77.4, 77.2, 76.8, 76.0, 75.7, 74.7, 73.7, 73.3, 72.4, 70.1, 69.0, 68.7, 67.7, 67.3, 50.6, 50.3, 47.2, 46.3, 32.1, 31.6, 30.3, 29.8, 29.5, 29.4, 28.0, 27.6, 23.4, 22.8, 14.3. . HR-ESI-MS (*m/z*): calculated for C<sub>47</sub>H<sub>51</sub>NO<sub>8</sub>Na [M+Na]<sup>+</sup>: 780.3512, found: 780.3519.

**N-(Benzyl)benzyloxycarbonyl-5-aminopentyl (3.36)****2,3,4-O-tri-benzyl-β-D-mannopyranoside**

To the solution of **3.35** (65 mg, 0.085 mmol) in the anhydrous DCM (5 mL) was added molecular sieves (4 Å) and stirred the mixture under argon for 30 min at room temperature. The mixture was cooled to the -78 °C, added triethylsilane (40 μL, 0.255 mmol) and dichlorophenylborane (22 μL, 0.171 mmol). After stirring for 30 min, reaction was quenched by adding Et<sub>3</sub>N (0.5 mL) and filtered through Celite®. The organic layer was washed with saturated aqueous sodium bicarbonate, dried over Na<sub>2</sub>SO<sub>4</sub> and evaporated *in vacuo*. The crude was purified by silica gel column chromatography (10% ethyl acetate in hexanes) to furnish the title compound **3.36** (51 mg, 79%). <sup>1</sup>H NMR (600 MHz, CDCl<sub>3</sub>) δ 7.50 – 7.42 (m, 2H), 7.40 – 7.25 (m, 22H), 7.19 (d, *J* = 7.5 Hz, 1H), 5.20 (d, *J* = 22.5 Hz, 2H), 4.97 (t, *J* = 9.8 Hz, 2H), 4.86 (d, *J* = 12.5 Hz, 1H), 4.67 (d, *J* =

10.9 Hz, 1H), 4.59 – 4.48 (m, 4H), 4.39 (d,  $J = 25.8$  Hz, 1H), 3.98 – 3.87 (m, 4H), 3.80 (dd,  $J = 11.8, 5.7$  Hz, 1H), 3.57 – 3.52 (m, 1H), 3.47 – 3.18 (m, 4H), 1.70 – 1.51 (m, 4H), 1.43 – 1.26 (m, 2H).  $^{13}\text{C}$  NMR (151 MHz,  $\text{CDCl}_3$ )  $\delta$  156.3, 138.6, 138.3, 138.2, 138.0, 137.0, 136.8, 134.3, 134.1, 128.6, 128.6, 128.6, 128.5, 128.5, 128.4, 128.3, 128.2, 128.2, 128.1, 128.0, 127.9, 127.8, 127.7, 127.7, 127.6, 127.6, 127.4, 127.3, 101.8, 82.4, 82.0, 77.4, 77.2, 76.9, 75.9, 75.5, 75.4, 75.0, 74.0, 73.9, 71.6, 69.9, 67.3, 62.7, 50.6, 50.3, 47.2, 46.3, 29.8, 29.4, 28.0, 27.4, 23.4. HR-ESI-MS ( $m/z$ ): calculated for  $\text{C}_{47}\text{H}_{53}\text{NO}_8\text{Na}$  [ $\text{M}+\text{Na}$ ] $^+$ : 782.3669, found: 782.3661.

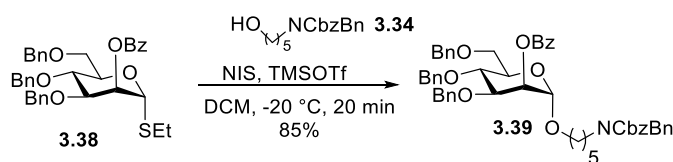
### 5-Aminopentyl-[ $\alpha$ -D-mannopyranosyl]-6-phosphate-(1 $\rightarrow$ 2)- $\beta$ -D-mannopyranoside (**3.29**)



Monoaccharide alcohol **3.36** (20 mg, 26.3  $\mu\text{mol}$ ) and *H*-phosphonate **3.19** (37 mg, 52.6  $\mu\text{mol}$ ) were co-evaporated three times with pyridine and the resulting mixture was dried under vacuum overnight before dissolving in anhydrous pyridine (3 mL). Pivaloyl chloride (16  $\mu\text{L}$ , 131.5  $\mu\text{mol}$ ) was then added. After 5 h of stirring at room temperature, a freshly prepared solution of iodine (33 mg, 131.5  $\mu\text{mol}$ ) in pyridine/water (10/1, 0.3 mL) was added. After 3 h, the reaction was diluted with DCM, washed with saturated  $\text{Na}_2\text{S}_2\text{O}_3$  solution and TEAB buffer, dried over  $\text{Na}_2\text{SO}_4$  and evaporated under reduced pressure. The crude was dissolved in DCM (3 mL), added hydrazine acetate (12 mg, 131.5  $\mu\text{mol}$ ) and stirred the reaction mixture overnight at room temperature. After completion of reaction, quenched by acetone and evaporated *in vacuo*. The crude was dissolved in the solution of EtOAc/*t*-BuOH/ $\text{H}_2\text{O}$  (2/1/1, *v/v/v*, 2 mL) and Pd/C (60 mg) was added to the solution. After stirring for 24 h under hydrogen atmosphere (1 atm, balloon), the mixture was filtered through a PTFE filter (0.45  $\mu\text{m}$  pore size) and concentrated. The crude material was purified by HPLC (Hypercarb column, 150 x10 mm,  $\text{H}_2\text{O}$  (0.1% formic acid) isocratic (5 min), linear gradient to 40% ACN (35 min), linear gradient to 100% ACN (10 min)) and lyophilized to obtain pure trisaccharide **3.29** (7 mg, 35%).  $^1\text{H}$  NMR (400 MHz,  $\text{D}_2\text{O}$ )  $\delta$  5.30 (dd,  $J = 7.8, 2.0$  Hz, 1H), 4.55 (d,  $J = 1.0$  Hz, 1H), 4.12 – 4.03 (m, 1H), 3.95 – 3.89 (m, 1H), 3.87 (dd,  $J = 3.4, 2.0$  Hz, 1H), 3.86 – 3.83 (m, 1H), 3.80 – 3.73 (m, 3H), 3.73 – 3.61 (m, 2H), 3.60 – 3.53 (m, 2H), 3.51 – 3.48 (m, 2H), 3.40 – 3.33 (m, 1H), 2.87 (t,  $J = 7.5$  Hz, 2H), 1.64 – 1.45 (m, 4H), 1.40 – 1.24 (m, 2H).  $^{13}\text{C}$  NMR (151 MHz,  $\text{D}_2\text{O}$ )  $\delta$  99.9, 96.1, 74.9, 74.8, 73.8, 72.9, 70.5, 70.4, 70.4, 69.8, 69.5, 66.5, 66.3, 65.0, 64.9, 60.8, 39.4, 28.0, 26.3, 22.0.  $^{31}\text{P}$  NMR (162 MHz,  $\text{D}_2\text{O}$ )  $\delta$  -2.0. HR-ESI-MS ( $m/z$ ): calculated for  $\text{C}_{17}\text{H}_{33}\text{NO}_{14}\text{P}$  [ $\text{M}$ ]: 506.1644, found: 506.1650

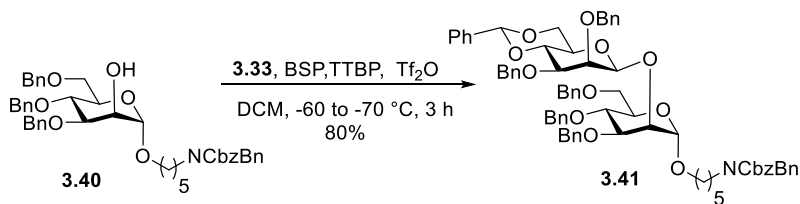
### *N*-(Benzyl)benzyloxycarbonyl-5-aminopentyl mannopyranoside (**3.39**)

### 2-benzoyl-3,4,6-*O*-tri-benzyl- $\alpha$ -D-mannopyranoside (**3.39**)



To a solution of donor **3.38** (1.161 g, 1.93 mmol.) and *N*-benzyloxycarbonyl-*N*-benzyl-5-aminopentanol **3.34** (0.952 g, 2.895 mmol) in DCM (10 mL) were added molecular sieves (4 Å). After ~30 minutes, the mixture was cooled to 0 °C and *N*-iodosuccinimide (0.738 g, 3.281 mmol) and TMSOTf (85 μL, 0.965 mmol) were added. After TLC analysis indicated complete consumption of the starting material (~20 Min.), the reaction was quenched with Et<sub>3</sub>N (2 mL) and the mixture was diluted with DCM. After filtration over Celite®, the mixture was washed with 10 % aqueous Na<sub>2</sub>S<sub>2</sub>O<sub>3</sub>, saturated aqueous NaHCO<sub>3</sub> and brine, dried over Na<sub>2</sub>SO<sub>4</sub>, filtered and concentrated *in vacuo*. The crude was purified by silica gel column chromatography using 10% ethyl acetate in hexanes to afford the title product **3.39** as the sole isomer (1.412 g, 85%). <sup>1</sup>H NMR (400 MHz, CDCl<sub>3</sub>) δ 8.09 – 8.05 (m, 2H), 7.55 (t, *J* = 7.4 Hz, 1H), 7.38 (dt, *J* = 8.3, 2.1 Hz, 6H), 7.35 – 7.21 (m, 18H), 7.21 – 7.14 (m, 3H), 5.61 – 5.57 (m, 1H), 5.18 (d, *J* = 21.0 Hz, 2H), 4.92 (d, *J* = 12.0 Hz, 1H), 4.86 (d, *J* = 10.7 Hz, 1H), 4.79 (d, *J* = 11.3 Hz, 1H), 4.73 (d, *J* = 12.0 Hz, 1H), 4.59 – 4.47 (m, 5H), 4.10 – 4.06 (m, 2H), 3.91 – 3.86 (m, 1H), 3.83 (d, *J* = 10.4 Hz, 1H), 3.76 (d, *J* = 10.7 Hz, 1H), 3.71 – 3.56 (m, 1H), 3.44 – 3.31 (m, 1H), 3.23 (dt, *J* = 44.0, 7.6 Hz, 2H), 1.56 – 1.46 (m, 4H), 1.34 – 1.19 (m, 2H). <sup>13</sup>C NMR (101 MHz, CDCl<sub>3</sub>) δ 165.9, 138.6, 138.4, 138.2, 138.1, 136.9, 133.3, 130.1, 130.0, 128.7, 128.6, 128.6, 128.5, 128.5, 128.4, 128.3, 128.2, 128.1, 128.0, 128.0, 127.9, 127.8, 127.7, 127.7, 127.6, 127.4, 127.3, 97.9, 78.5, 77.4, 77.2, 76.9, 75.5, 74.5, 73.6, 71.7, 69.2, 67.8, 67.3, 50.6, 50.3, 47.2, 46.2, 29.2, 28.1, 27.6, 23.5. HR-ESI-MS (*m/z*): calculated for C<sub>54</sub>H<sub>57</sub>NO<sub>9</sub>Na [M+Na]<sup>+</sup>: 886.3931, found: 886.3919

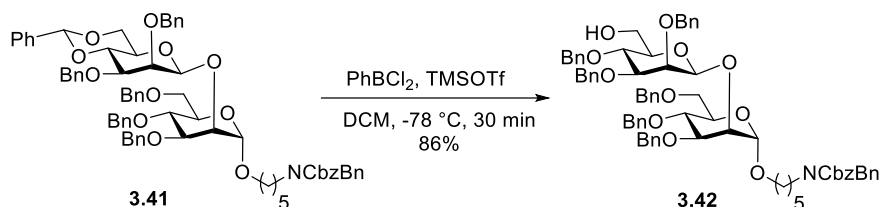
***N*-(Benzyl)benzyloxycarbonyl-5-aminopentyl 2,3-*O*-di-benzyl-4,6-*O*-benzylidene-β-*D*-mannopyranosyl-(1→2)-3,4,6-*O*-tri-benzyl-α-*D*-mannopyranoside (3.41)**



To the solution of donor **3.33** (778 mg, 1.58 mmol) in DCM (8 mL) was added molecular sieves (4 Å) and stirred the solution for 30 min. BSP (330 mg, 1.58 mmol) and TTBP (522 mg, 2.1 mmol) were added to the reaction mixture at -60 °C and stirred the reaction for 30 min. After stirring for 30 min, Tf<sub>2</sub>O (441 μL, 2.63 mmol) was added and stirred the mixture for 30 min. The reaction mixture was brought to -70 °C and acceptor **3.40** (400 mg, 0.526 mmol) was added. After stirring for 2 h, reaction was quenched by adding Et<sub>3</sub>N (0.5 mL) and filtered through Celite®. Organic layer was washed with saturated aqueous sodium bicarbonate, dried over Na<sub>2</sub>SO<sub>4</sub> and evaporated *in vacuo*. The crude was purified by silica gel column chromatography (10% ethyl acetate in hexanes) to get the disaccharide **3.41** (504 mg, 80%). <sup>1</sup>H NMR (400 MHz, CDCl<sub>3</sub>) δ 7.56 – 7.50 (m, 4H), 7.49 – 7.45 (m, 2H), 7.43 – 7.35 (m, 5H), 7.35 – 7.29 (m, 12H), 7.28 – 7.20 (m, 14H), 7.12 – 7.06 (m, 2H), 5.61 (s, 1H), 5.23 – 5.16 (m, 2H), 5.11 (d, *J* = 11.6 Hz, 1H), 4.86 (d, *J* = 11.5 Hz, 3H), 4.79 (d, *J* = 10.8 Hz, 1H), 4.65 (d, *J* = 3.7 Hz, 3H), 4.62 – 4.54 (m, 2H), 4.53 – 4.48 (m, 2H), 4.46 (d, *J* = 12.1 Hz, 1H), 4.31 (d, *J* = 10.8 Hz, 1H), 4.28 – 4.20 (m, 3H), 4.04 (d, *J* = 3.2 Hz, 1H), 3.94 – 3.81 (m, 3H), 3.76 – 3.63 (m, 4H), 3.59 (d, *J* = 10.3 Hz, 1H), 3.41 – 3.16 (m, 5H), 1.51 – 1.42 (m, 40H), 0.96 – 0.90 (m, 2H). <sup>13</sup>C NMR (101 MHz, CDCl<sub>3</sub>) δ 138.8, 138.7, 138.3, 138.0,

137.6, 134.5, 129.8, 129.0, 128.9, 128.8, 128.7, 128.6, 128.5, 128.3, 128.3, 128.2, 128.2, 128.2, 128.1, 128.1, 128.0, 127.9, 127.8, 127.8, 127.7, 127.6, 127.6, 127.5, 127.5, 127.4, 127.2, 126.1, 101.4, 100.4, 97.3, 78.3, 78.2, 77.4, 77.3, 77.0, 76.7, 76.1, 75.1, 74.5, 74.2, 73.4, 73.3, 72.9, 71.8, 71.4, 70.6, 70.5, 68.9, 68.5, 67.6, 67.2, 50.2, 47.0, 46.1, 45.3, 32.0, 30.2, 30.1, 29.7, 29.4, 29.2, 28.0, 27.7, 27.5, 23.4, 22.7, 21.5, 14.2. HR-ESI-MS (m/z): calculated for C<sub>74</sub>H<sub>80</sub>NO<sub>13</sub>H [M+H]<sup>+</sup>: 1190.5630, found: 1190.5642. HR-ESI-MS (m/z): calculated for C<sub>74</sub>H<sub>79</sub>NO<sub>13</sub>Na [M+Na]<sup>+</sup>: 1212.5449, found: 1212.5438

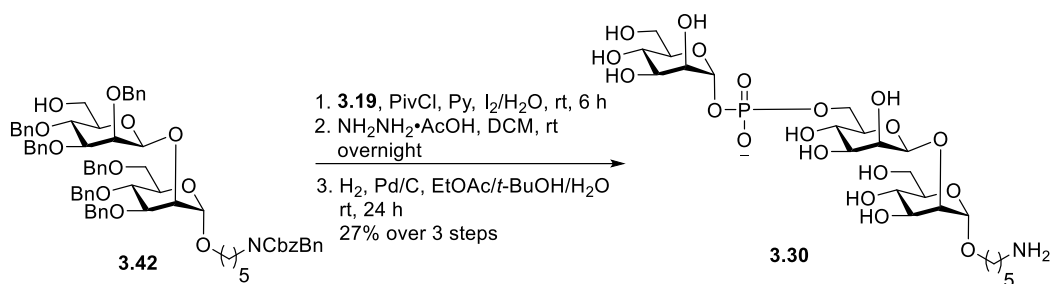
***N*-(Benzyl)benzyloxycarbonyl-5-aminopentyl 2,3,4-*O*-tri-benzyl-β-D-mannopyranosyl-(1→2)-3,4,6-*O*-tri-benzyl-α-D-mannopyranoside (3.42)**



To the solution of disaccharide **3.41** (200 mg, 0.168 mmol) in the anhydrous DCM (6 mL) was added molecular sieves (4 Å) and stirred the mixture under argon for 30 min at room temperature. The mixture was cooled to the -78 °C, added triethylsilane (80 μL, 0.504 mmol) and dichlorophenylborane (43 μL, 0.336 mmol). After stirring for 30 min, reaction was quenched by adding Et<sub>3</sub>N (1 mL) and filtered through Celite®. The organic layer was washed with saturated aqueous sodium bicarbonate, dried over Na<sub>2</sub>SO<sub>4</sub> and evaporated *in vacuo*. The crude was purified by silica gel column chromatography (15% ethyl acetate in hexanes) to get the disaccharide **3.42** (173 mg, 86%). <sup>1</sup>H NMR (600 MHz, CDCl<sub>3</sub>) δ 7.54 – 7.48 (m, 2H), 7.47 – 7.42 (m, 2H), 7.29 (tdt, *J* = 8.1, 5.6, 3.0 Hz, 17H), 7.26 – 7.19 (m, 16H), 7.15 (d, *J* = 7.4 Hz, 1H), 7.07 (dt, *J* = 4.5, 3.2 Hz, 2H), 5.16 (d, *J* = 22.4 Hz, 2H), 5.08 (d, *J* = 11.7 Hz, 1H), 4.94 (d, *J* = 10.8 Hz, 1H), 4.85 (dd, *J* = 11.7, 8.5 Hz, 3H), 4.78 (d, *J* = 10.7 Hz, 1H), 4.63 – 4.52 (m, 5H), 4.51 – 4.41 (m, 4H), 4.32 (d, *J* = 10.8 Hz, 1H), 4.24 – 4.16 (m, 1H), 4.02 – 3.95 (m, 2H), 3.91 (d, *J* = 8.5 Hz, 2H), 3.80 – 3.67 (m, 4H), 3.68 – 3.58 (m, 2H), 3.50 (d, *J* = 9.1 Hz, 1H), 3.37 – 3.13 (m, 4H), 1.53 – 1.39 (m, 4H), 1.23 – 1.13 (m, 2H). <sup>13</sup>C NMR (176 MHz, CDCl<sub>3</sub>) δ 156.9, 156.3, 138.8, 138.6, 138.5, 138.4, 138.3, 138.2, 138.0, 137.0, 136.8, 129.2, 128.8, 128.7, 128.6, 128.6, 128.6, 128.5, 128.5, 128.4, 128.4, 128.3, 128.3, 128.3, 128.2, 128.2, 128.1, 128.0, 127.9, 127.9, 127.9, 127.8, 127.7, 127.7, 127.7, 127.6, 127.5, 127.4, 127.3, 99.8, 97.5, 81.4, 78.5, 77.3, 77.2, 77.0, 76.0, 75.4, 75.3, 75.3, 74.6, 74.4, 74.3, 74.3, 74.1, 73.5, 73.0, 71.5, 71.1, 70.9, 70.8, 70.0, 69.0, 67.7, 67.3, 62.3, 50.6, 50.3, 47.2, 46.2, 45.4, 32.1, 30.3, 29.9, 29.5, 29.3, 28.1, 27.6, 23.6, 22.8, 21.6, 14.3, 1.2. HR-ESI-MS (m/z): calculated for C<sub>74</sub>H<sub>81</sub>NO<sub>13</sub>Na [M+Na]<sup>+</sup>: 1214.5606, found: 1214.55991.

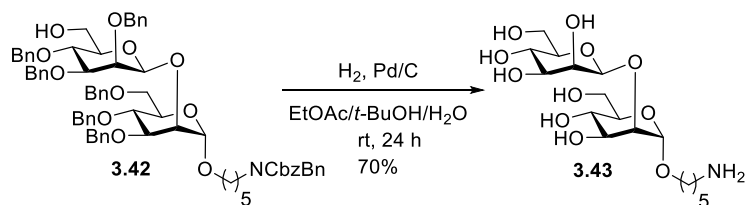
**5-Aminopentyl-β-D-mannopyranosyl [α-D-mannopyranosyl]-6-phosphate-(1→2)-α-D-mannopyranoside (3.30)**





Disaccharide alcohol **3.42** (30 mg, 25.15  $\mu$ mol) and *H*-phosphonate **3.19** (35.9 mg, 50.3  $\mu$ mol) were co-evaporated three times with pyridine and the resulting mixture was dried under vacuum overnight before dissolving in anhydrous pyridine (3 mL). Pivaloyl chloride (15.3  $\mu$ L, 125.7  $\mu$ mol) was then added. After 5 h of stirring at room temperature, a freshly prepared solution of iodine (31.9 mg, 125.7  $\mu$ mol) in pyridine/water (10/1, 0.3 mL) was added. After 3 h, the reaction was diluted with DCM, washed with saturated Na<sub>2</sub>S<sub>2</sub>O<sub>3</sub> solution and TEAB buffer, dried over Na<sub>2</sub>SO<sub>4</sub> and evaporated under reduced pressure. The crude was dissolved in DCM (3 mL), added hydrazine acetate (11.5 mg, 125.7  $\mu$ mol) and stirred the reaction mixture overnight at room temperature. After completion of reaction, quenched by acetone and evaporated *in vacuo*. The crude was dissolved in the solution of EtOAc/*t*-BuOH/H<sub>2</sub>O (2/1/1, *v/v/v*, 2 mL) and Pd/C (60 mg) was added to the solution. After stirring for 24 h under hydrogen atmosphere (1 atm, balloon), the mixture was filtered through a PTFE filter (0.45  $\mu$ m pore size) and concentrated. The crude material was purified by HPLC (Hypercarb column, 150 x10 mm, H<sub>2</sub>O (0.1% formic acid) isocratic (5 min), linear gradient to 40% ACN (35 min), linear gradient to 100% ACN (10 min)) and lyophilized to obtain pure trisaccharide **3.30** (4.6 mg, 27%). <sup>1</sup>H NMR (600 MHz, D<sub>2</sub>O)  $\delta$  5.33 (dd, *J* = 7.9, 2.0 Hz, 1H), 4.88 (s, 1H), 4.12 (ddd, *J* = 11.4, 5.6, 2.0 Hz, 1H), 4.05 (dd, *J* = 3.3, 1.8 Hz, 1H), 3.98 – 3.92 (m, 2H), 3.91 (dd, *J* = 3.4, 2.0 Hz, 1H), 3.84 – 3.75 (m, 3H), 3.75 – 3.63 (m, 5H), 3.62 – 3.51 (m, 5H), 3.49 – 3.38 (m, 2H), 2.92 – 2.87 (m, 2H), 1.62 – 1.49 (m, 4H), 1.40 – 1.31 (m, 2H). <sup>13</sup>C NMR (151 MHz, D<sub>2</sub>O)  $\delta$  98.7, 97.5, 96.1, 96.1, 77.6, 75.1, 75.0, 73.8, 72.8, 72.6, 70.7, 70.4, 70.0, 69.8, 67.6, 67.1, 66.4, 66.3, 65.0, 64.9, 60.8, 60.6, 39.4, 28.0, 26.5, 22.5. <sup>31</sup>P NMR (162 MHz, D<sub>2</sub>O)  $\delta$  -2.0. HR-ESI-MS (*m/z*): calculated for C<sub>23</sub>H<sub>43</sub>NO<sub>19</sub>P [M]<sup>-</sup>: 668.2172, found: 668.2153

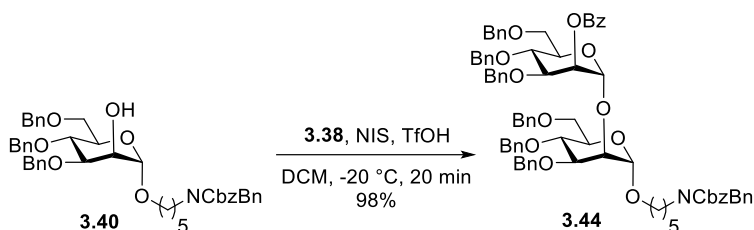
### 5-Aminopentyl $\beta$ -D-mannopyranosyl-(1 $\rightarrow$ 2)- $\alpha$ -D-mannopyranoside (**3.43**)



The disaccharide **3.42** (20 mg, 16.8  $\mu$ mol) was dissolved in EtOAc/*t*-BuOH/H<sub>2</sub>O (2/1/1, *v/v/v*, 3 mL) and added Pd/C (40 mg). The reaction mixture was stirred overnight at room temperature under hydrogen atmosphere (1 atm, balloon). The crude material was purified by HPLC (Hypercarb column, 150 x 10 mm, H<sub>2</sub>O (0.1% formic acid) isocratic (5 min), linear gradient to 40% ACN (35 min), linear gradient to 100% ACN (10 min)) and lyophilized to obtain pure

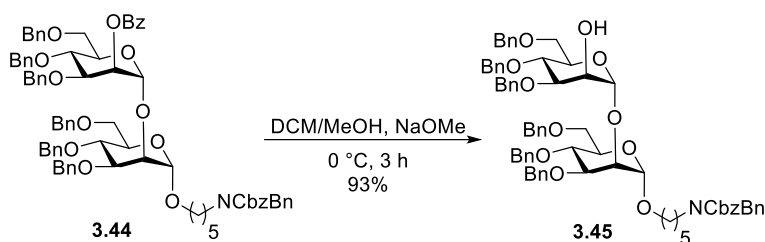
disaccharide **3.43** (5 mg, 70%) as a white solid.  $^1\text{H}$  NMR (700 MHz,  $\text{D}_2\text{O}$ )  $\delta$  4.93 (d,  $J = 1.7$  Hz, 1H), 4.72 (d,  $J = 1.0$  Hz, 1H), 4.10 (dd,  $J = 3.4, 1.7$  Hz, 1H), 4.00 (dd,  $J = 3.4, 0.9$  Hz, 1H), 3.88 (dd,  $J = 12.3, 2.3$  Hz, 1H), 3.83 (dd,  $J = 12.3, 2.2$  Hz, 1H), 3.77 (dd,  $J = 9.7, 3.4$  Hz, 1H), 3.75 – 3.63 (m, 4H), 3.62 – 3.56 (m, 2H), 3.54 – 3.48 (m, 2H), 3.35 – 3.30 (m, 1H), 2.96 (t,  $J = 7.6$  Hz, 2H), 1.69 – 1.56 (m, 4H), 1.47 – 1.35 (m, 2H).  $^{13}\text{C}$  NMR (176 MHz,  $\text{D}_2\text{O}$ )  $\delta$  170.9, 98.5, 97.4, 77.1, 76.3, 72.8, 72.7, 70.7, 69.9, 67.5, 66.9, 66.6, 61.0, 60.5, 39.3, 28.0, 26.5, 22.4. HR-ESI-MS (m/z): calculated for  $\text{C}_{17}\text{H}_{33}\text{NO}_{11}\text{H}$   $[\text{M}+\text{H}]^+$ : 428.2132, found: 428.2087.

***N*-(Benzyl)benzyloxycarbonyl-5-aminopentyl 2-benzoyl-3,4,6-*O*-tri-benzyl-  $\alpha$ -D-mannopyranosyl- (1 $\rightarrow$ 2)-3,4,6-*O*-tri-benzyl- $\alpha$ -D-mannopyranoside (3.44)**



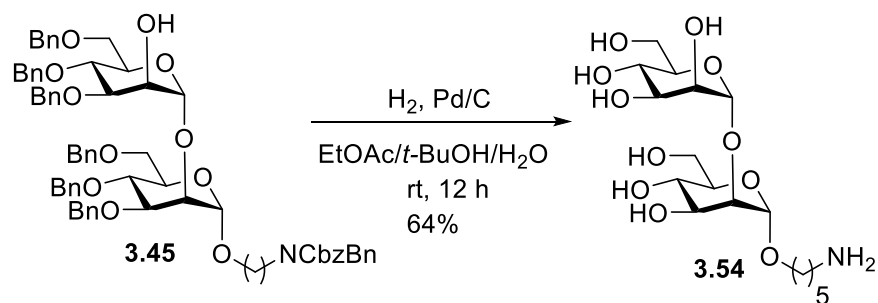
Acceptor **3.40** (913 mg, 1.20 mmol) and thioglycoside donor **3.38** (1.077 g, 1.8 mmol) were mixed, co-evaporated with toluene (3 x 10 mL) and dried under high vacuum for 2 h. The mixture was freshly activated molecular sieves (4 Å), dissolved in anhydrous DCM (12 mL) under a nitrogen atmosphere and stirred for 30 min. at room temperature. The mixture was cooled to 0 °C, to this stirred suspension, NIS (0.413 g, 1.92 mmol) and TfOH (52  $\mu\text{L}$ , 0.6 mmol) were slowly added. After stirring at room temperature for 20 min., diluted with DCM (10 mL), quenched with  $\text{Et}_3\text{N}$ , warmed to room temperature and molecular sieves (4 Å) were filtered. The filtrate was washed with 10% aqueous  $\text{Na}_2\text{S}_2\text{O}_3$ , saturated aqueous  $\text{NaHCO}_3$  and brine. The combined organic layer was dried over  $\text{Na}_2\text{SO}_4$ , filtered and evaporated *in vacuo*. The crude product was purified by silica column chromatography using 13% ethyl acetate in hexanes to afford the desired protected disaccharide **3.44** (1.541 g, 98%).  $^1\text{H}$  NMR (600 MHz,  $\text{CDCl}_3$ )  $\delta$  8.07 (dd,  $J = 8.3, 1.4$  Hz, 2H), 7.60 – 7.52 (m, 1H), 7.41 – 7.32 (m, 10H), 7.31 – 7.24 (m, 19H), 7.24 – 7.12 (m, 13H), 5.78 (dd,  $J = 3.1, 2.0$  Hz, 1H), 5.21 – 5.11 (m, 3H), 4.89 – 4.83 (m, 3H), 4.76 (d,  $J = 11.1$  Hz, 1H), 4.74 – 4.63 (m, 4H), 4.55 (dd,  $J = 11.5, 4.5$  Hz, 2H), 4.52 – 4.49 (m, 3H), 4.48 – 4.43 (m, 2H), 4.15 – 4.07 (m, 1H), 4.06 – 4.01 (m, 2H), 3.98 (s, 1H), 3.92 – 3.80 (m, 3H), 3.80 – 3.67 (m, 4H), 3.55 (dd,  $J = 26.9, 8.5$  Hz, 1H), 3.28 – 3.13 (m, 3H), 1.47 (ddd,  $J = 31.6, 15.5, 9.0$  Hz, 4H), 1.26 – 1.14 (m, 2H).  $^{13}\text{C}$  NMR (151 MHz,  $\text{CDCl}_3$ )  $\delta$  165.6, 156.8, 138.6, 138.5, 138.4, 138.2, 138.0, 133.2, 130.1, 130.1, 128.7, 128.6, 128.6, 128.5, 128.4, 128.4, 128.4, 128.3, 128.3, 128.0, 128.0, 127.9, 127.8, 127.6, 127.6, 127.6, 127.5, 127.4, 127.3, 99.7, 98.8, 79.9, 78.3, 77.4, 77.2, 76.9, 75.4, 75.3, 74.8, 74.5, 73.5, 73.4, 72.3, 72.1, 71.9, 71.8, 69.4, 69.4, 69.2, 67.6, 67.3, 50.6, 50.3, 47.2, 46.2, 29.3, 28.1, 27.6, 23.5. HR-ESI-MS (m/z): calculated for  $\text{C}_{81}\text{H}_{88}\text{NO}_{14}\text{H}$   $[\text{M}+\text{H}]^+$ : 1296.6048, found: 1296.6073

***N*-(Benzyl)benzyloxycarbonyl-5-aminopentyl 3,4,6-*O*-tri-benzyl- $\alpha$ -D-mannopyranosyl- (1 $\rightarrow$ 2)-3,4,6-*O*-tri-benzyl- $\alpha$ -D-mannopyranoside (3.45)**



To a stirred solution of **3.44** (1.52 g, 1.17 mmol) in MeOH/DCM (2:1, 30 mL) in an ice bath was added NaOMe (3.98 mL, 1 M in MeOH) and stirred the reaction mixture for 3 h at room temperature. After completion of reaction, reaction mixture was neutralized by addition of Amberlite® IR120 H<sup>+</sup>, filtered and concentrated under reduced pressure. The crude product was purified by silica column chromatography using 15% ethyl acetate in hexanes to afford the desired disaccharide **3.45** (1.3 g, 93%). <sup>1</sup>H NMR (400 MHz, CDCl<sub>3</sub>) δ 7.39 – 7.14 (m, 40H), 5.20 – 5.11 (m, 3H), 4.90 – 4.78 (m, 3H), 4.72 – 4.62 (m, 3H), 4.61 – 4.54 (m, 3H), 4.54 – 4.44 (m, 5H), 4.12 (t, *J* = 2.5 Hz, 1H), 4.00 (s, 1H), 3.98 – 3.93 (m, 1H), 3.92 – 3.90 (m, 1H), 3.88 (d, *J* = 3.3 Hz, 1H), 3.87 – 3.84 (m, 1H), 3.84 – 3.76 (m, 2H), 3.75 – 3.66 (m, 3H), 3.51 (d, *J* = 9.1 Hz, 1H), 3.27 – 3.11 (m, 3H), 1.53 – 1.36 (m, 4H), 1.26 – 1.10 (m, 2H). <sup>13</sup>C NMR (101 MHz, CDCl<sub>3</sub>) δ 138.75, 138.50, 138.44, 138.38, 138.11, 128.68, 128.61, 128.57, 128.50, 128.46, 128.42, 128.16, 128.07, 128.01, 127.98, 127.95, 127.84, 127.82, 127.75, 127.67, 127.57, 127.51, 101.21, 98.90, 80.14, 79.97, 77.48, 77.36, 77.16, 76.84, 75.34, 75.16, 74.95, 74.55, 73.52, 73.43, 72.38, 72.27, 72.00, 71.65, 69.45, 69.33, 68.65, 67.59, 67.28, 50.30, 47.22, 46.26, 29.36, 23.53. HR-ESI-MS (*m/z*): calculated for C<sub>74</sub>H<sub>81</sub>NO<sub>13</sub>Na [M+Na]<sup>+</sup>: 1214.5606, found: 1214.50.1.

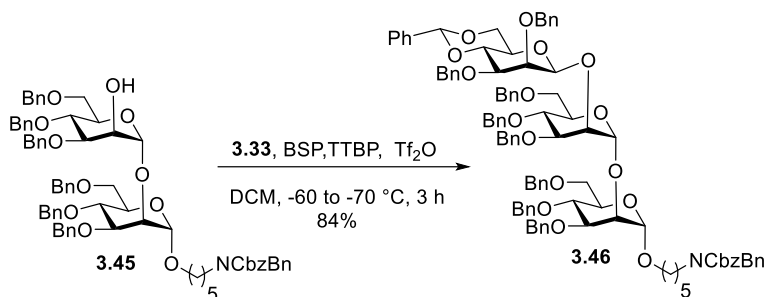
### 5-Aminopentyl α-D-mannopyranosyl-(1→2)-α-D-mannopyranoside (**3.54**)



Disaccharide **3.45** (2.1 mg, 17.6 μmol) was dissolved in EtOAc/*t*-BuOH/H<sub>2</sub>O (2/1/1, v/v/v, 3 mL) and Pd/C (40 mg) was added to the solution. After stirring overnight under a hydrogen atmosphere (1 atm, balloon), the mixture was filtered through a PTFE filter (0.45 μm pore size) and concentrated. The crude material was purified by HPLC (Hypercarb column, 150 x 10 mm, H<sub>2</sub>O (0.1% formic acid) isocratic (5 min), linear gradient to 40% ACN (35 min), linear gradient to 100% ACN (10 min)) and lyophilized to obtain pure disaccharide **3.54** (4.8 mg, 64%). <sup>1</sup>H NMR (600 MHz, D<sub>2</sub>O) δ 5.06 (d, *J* = 1.7 Hz, 1H), 4.97 (d, *J* = 1.8 Hz, 1H), 4.03 (dd, *J* = 3.4, 1.8 Hz, 1H), 3.91 (dd, *J* = 3.5, 1.7 Hz, 1H), 3.88 – 3.83 (m, 3H), 3.80 (dd, *J* = 9.7, 3.4 Hz, 1H), 3.76 – 3.61 (m, 5H), 3.59 – 3.54 (m, 2H), 3.52 – 3.48 (m, 1H), 2.98 – 2.93 (m, 2H), 1.70 – 1.54 (m, 4H), 1.47 – 1.34 (m, 2H). <sup>13</sup>C NMR (101 MHz, D<sub>2</sub>O) δ 102.3, 98.0, 78.7, 73.2, 72.7, 70.2, 70.2, 69.9, 67.5,

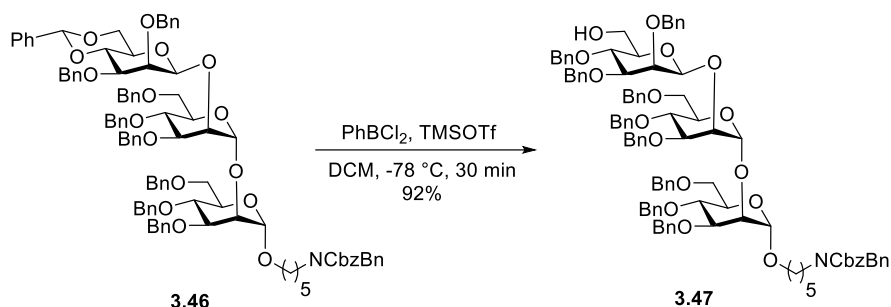
66.9, 66.9, 61.1, 60.9, 39.3, 27.9, 26.5, 22.4. HR-ESI-MS (m/z): calculated for C<sub>17</sub>H<sub>33</sub>NO<sub>11</sub>H [M+H]<sup>+</sup>: 428.2132, found: 428.2128.

***N*-(Benzyl)benzyloxycarbonyl-5-aminopentyl 2,3-*O*-di-benzyl-4,6-*O*-benzylidene- $\beta$ -D-mannopyranosyl-(1 $\rightarrow$ 2)-3,4,6-*O*-tri-benzyl- $\alpha$ -D-mannopyranosyl-(1 $\rightarrow$ 2)-3,4,6-*O*-tri-benzyl- $\alpha$ -D-mannopyranoside (3.46)**



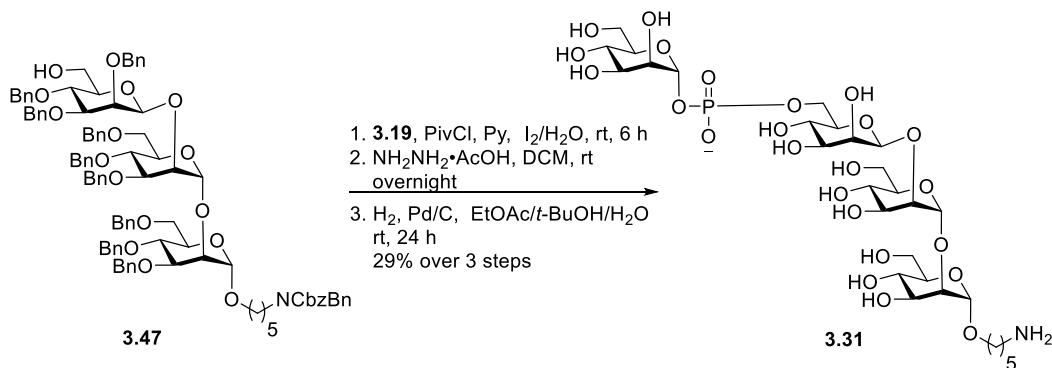
To the solution of donor **3.33** (248 mg, 0.503 mmol) in DCM (8 mL) was added molecular sieves (4 Å) and stirred the solution for 30 min under nitrogen atmosphere. BSP (105 mg, 0.503 mmol) and TTBP (167 mg, 0.671 mmol) were added to the reaction mixture at -60 °C and stirred the reaction for 30 min. After stirring for 30 min, Tf<sub>2</sub>O (140 μL, 0.839 mmol) was added and stirred the mixture for another 30 min. The reaction mixture was brought to -70 °C and acceptor **3.45** (200 mg, 0.168 mmol, in 2 mL of DCM) was added. After stirring for 2 h, reaction was quenched by adding Et<sub>3</sub>N (0.5 mL) and filtered through Celite®. Organic layer was washed with saturated aqueous sodium bicarbonate, dried over Na<sub>2</sub>SO<sub>4</sub> and evaporated *in vacuo*. The crude was purified by silica gel column chromatography (10% ethyl acetate in hexanes) to get the trisaccharide **3.46** (230 mg, 84%). <sup>1</sup>H NMR (600 MHz, CDCl<sub>3</sub>) δ 7.55 – 7.51 (m, 4H), 7.47 – 7.43 (m, 2H), 7.43 – 7.37 (m, 8H), 7.37 – 7.19 (m, 37H), 7.15 – 7.11 (m, 4H), 7.09 (d, *J* = 7.3 Hz, 1H), 5.60 (s, 1H), 5.22 (d, *J* = 19.8 Hz, 2H), 5.14 (d, *J* = 2.8 Hz, 1H), 5.05 (d, *J* = 11.7 Hz, 1H), 4.93 – 4.87 (m, 2H), 4.83 (dd, *J* = 11.6, 6.5 Hz, 2H), 4.77 – 4.68 (m, 3H), 4.66 – 4.57 (m, 6H), 4.55 – 4.50 (m, 3H), 4.46 (d, *J* = 12.1 Hz, 1H), 4.31 – 4.20 (m, 3H), 4.14 (dd, *J* = 21.0, 11.4 Hz, 2H), 4.00 (dd, *J* = 7.5, 3.1 Hz, 1H), 3.98 – 3.89 (m, 2H), 3.88 – 3.76 (m, 5H), 3.76 – 3.66 (m, 4H), 3.64 – 3.48 (m, 1H), 3.33 (dd, *J* = 9.9, 3.2 Hz, 1H), 3.31 – 3.14 (m, 3H), 3.02 (s, 1H), 1.59 – 1.41 (m, 4H), 1.30 – 1.18 (m, 2H). <sup>13</sup>C NMR (151 MHz, CDCl<sub>3</sub>) δ 156.8, 156.3, 138.9, 138.9, 138.7, 138.3, 138.1, 137.9, 128.9, 128.7, 128.7, 128.6, 128.6, 128.6, 128.5, 128.4, 128.4, 128.4, 128.4, 128.3, 128.3, 128.3, 128.2, 128.2, 128.1, 128.1, 128.0, 128.0, 127.9, 127.8, 127.8, 127.7, 127.7, 127.6, 127.6, 127.6, 127.5, 127.5, 127.4, 127.4, 127.3, 126.2, 101.5, 100.1, 99.0, 80.4, 78.5, 77.8, 77.4, 77.3, 77.2, 77.1, 76.9, 76.3, 75.4, 75.2, 75.0, 74.8, 74.3, 73.6, 73.4, 73.4, 73.3, 73.0, 71.8, 71.7, 71.6, 71.4, 69.5, 69.3, 68.6, 67.5, 67.3, 67.2, 50.6, 50.3, 47.2, 46.2, 31.6, 30.3, 29.8, 29.3, 28.0, 27.6, 23.5, 23.5. HR-ESI-MS (m/z): calculated for C<sub>101</sub>H<sub>107</sub>NO<sub>18</sub>Na [M+Na]<sup>+</sup>: 1644.7386, found: 1644.7379.

***N*-(Benzyl)benzyloxycarbonyl-5-aminopentyl 2,3,4-*O*-tri-benzyl- $\beta$ -D-mannopyranosyl-(1 $\rightarrow$ 2)-3,4,6-*O*-tri-benzyl- $\alpha$ -D-mannopyranoside (3.47)**



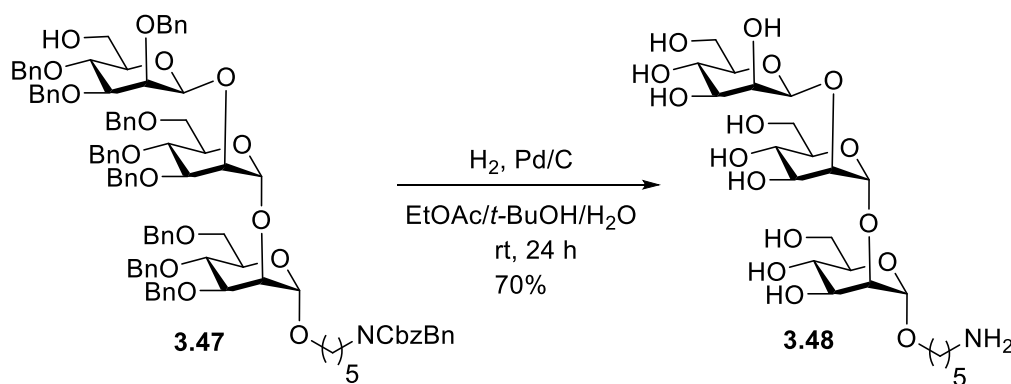
To the solution of **3.46** (140 mg, 0.086 mmol) in the anhydrous DCM (7 mL) was added molecular sieves (4 Å) and stirred the mixture under argon for 30 min at room temperature. The mixture was cooled to the  $-78^\circ\text{C}$ , added triethylsilane (41  $\mu\text{L}$ , 0.258 mmol) and dichlorophenylborane (22  $\mu\text{L}$ , 0.172 mmol). After stirring for 30 min., reaction was quenched by adding  $\text{Et}_3\text{N}$  (1 mL) and filtered through Celite<sup>®</sup>. The organic layer was washed with saturated aqueous sodium bicarbonate, dried over  $\text{Na}_2\text{SO}_4$  and evaporated *in vacuo*. The crude was purified by silica gel column chromatography (17% ethyl acetate in hexanes) to get the trisaccharide **3.47** (128 mg, 92%). <sup>1</sup>H NMR (400 MHz,  $\text{CDCl}_3$ )  $\delta$  7.50 (dd,  $J = 6.6, 2.9$  Hz, 2H), 7.45 – 7.41 (m, 2H), 7.38 – 7.26 (m, 35H), 7.25 – 7.18 (m, 11H), 7.14 (d,  $J = 7.6$  Hz, 2H), 7.13 – 7.09 (m, 3H), 5.20 (d,  $J = 12.1$  Hz, 2H), 5.12 (d,  $J = 2.3$  Hz, 1H), 5.00 (dd,  $J = 28.0, 11.5$  Hz, 2H), 4.91 – 4.85 (m, 2H), 4.81 (dd,  $J = 11.7, 5.2$  Hz, 2H), 4.78 – 4.71 (m, 2H), 4.69 (d,  $J = 4.8$  Hz, 1H), 4.67 – 4.57 (m, 5H), 4.57 – 4.42 (m, 6H), 4.39 – 4.27 (m, 3H), 4.24 (t,  $J = 2.7$  Hz, 1H), 4.08 (t,  $J = 2.4$  Hz, 1H), 3.98 (dd,  $J = 8.2, 3.0$  Hz, 1H), 3.92 (t,  $J = 9.4$  Hz, 3H), 3.86 – 3.77 (m, 4H), 3.76 – 3.64 (m, 6H), 3.56 (d,  $J = 8.2$  Hz, 1H), 3.31 – 3.16 (m, 4H), 3.09 – 2.99 (m, 1H), 1.55 – 1.44 (m, 4H), 0.94 – 0.82 (m, 2H). <sup>13</sup>C NMR (101 MHz,  $\text{CDCl}_3$ )  $\delta$  156.8, 156.3, 138.9, 138.8, 138.7, 138.5, 138.4, 138.4, 138.1, 138.0, 137.0, 136.9, 128.7, 128.7, 128.6, 128.6, 128.5, 128.5, 128.5, 128.5, 128.4, 128.4, 128.4, 128.3, 128.2, 128.1, 128.1, 128.0, 128.0, 127.9, 127.9, 127.7, 127.7, 127.7, 127.7, 127.6, 127.6, 127.5, 127.5, 127.4, 127.3, 99.8, 99.7, 99.0, 81.3, 80.4, 78.1, 77.5, 77.4, 77.2, 76.8, 75.8, 75.4, 75.2, 75.1, 74.8, 74.5, 74.4, 74.3, 73.6, 73.4, 73.4, 72.8, 71.9, 71.8, 71.2, 70.9, 69.3, 67.6, 67.3, 62.3, 50.6, 50.3, 47.2, 46.2, 29.8, 29.3, 28.1, 27.6, 23.5, 14.3. HR-ESI-MS ( $m/z$ ): calculated for  $\text{C}_{101}\text{H}_{110}\text{NO}_{18}\text{H} [\text{M}+\text{H}]^+$ : 1624.7723, found: 1624.7772

**5-Aminopentyl- $\beta$ -D-mannopyranosyl [ $\alpha$ -D-mannopyranosyl]-6-phosphate-(1 $\rightarrow$ 2)- $\alpha$ -D-mannopyranosyl-(1 $\rightarrow$ 2)- $\alpha$ -D-mannopyranoside (3.31)**



Trisaccharide alcohol **3.47** (28 mg, 17.2  $\mu\text{mol}$ ) and *H*-phosphonate **3.19** (31 mg, 43.7  $\mu\text{mol}$ ) were coevaporated three times with pyridine and the resulting mixture was dried under vacuum overnight before dissolving in anhydrous pyridine (3 mL). Pivaloyl chloride (10.5  $\mu\text{L}$ , 85.2  $\mu\text{mol}$ ) was then added. After 5 h of stirring at room temperature, a freshly prepared solution of iodine (21.8 mg, 86.2  $\mu\text{mol}$ ) in pyridine/water (10/1, 0.3 mL) was added. After 3 h, the reaction was diluted with DCM, washed with saturated  $\text{Na}_2\text{S}_2\text{O}_3$  solution and TEAB buffer, dried over  $\text{Na}_2\text{SO}_4$  and evaporated under reduced pressure. The crude was dissolved in DCM (3 mL), added hydrazine acetate (7.9 mg, 86.2  $\mu\text{mol}$ ) and stirred the reaction mixture overnight at room temperature. After completion of reaction, quenched by acetone and evaporated *in vacuo*. The crude was dissolved in the solution of EtOAc/*t*-BuOH/ $\text{H}_2\text{O}$  (2/1/1, *v/v/v*, 2 mL) and Pd/C (60 mg) was added to the solution. After stirring for 24 h under hydrogen atmosphere (1 atm, balloon), the mixture was filtered through a PTFE filter (0.45  $\mu\text{m}$  pore size) and concentrated. The crude material was purified by HPLC (Hypercarb column, 150 x 10 mm,  $\text{H}_2\text{O}$  (0.1% formic acid) isocratic (5 min), linear gradient to 40% ACN (35 min), linear gradient to 100% ACN (10 min)) and lyophilized to obtain pure tetrasaccharide **3.31** (4.1 mg, 29%).  $^1\text{H}$  NMR (700 MHz,  $\text{D}_2\text{O}$ )  $\delta$  5.39 (dd,  $J = 7.9, 2.0$  Hz, 1H), 5.10 (d,  $J = 1.8$  Hz, 1H), 5.05 (d,  $J = 1.8$  Hz, 1H), 4.81 (d,  $J = 0.9$  Hz, 1H), 4.26 (dd,  $J = 3.3, 1.8$  Hz, 1H), 4.18 (ddd,  $J = 11.6, 5.8, 2.1$  Hz, 1H), 4.06 – 3.98 (m, 2H), 3.97 (dd,  $J = 3.4, 2.0$  Hz, 1H), 3.92 (dd,  $J = 3.4, 1.8$  Hz, 1H), 3.90 – 3.86 (m, 1H), 3.86 – 3.77 (m, 6H), 3.75 – 3.67 (m, 5H), 3.66 – 3.60 (m, 5H), 3.57 (ddd,  $J = 9.7, 8.0, 4.5$  Hz, 1H), 3.54 – 3.46 (m, 2H), 2.96 (t,  $J = 7.6$  Hz, 2H), 1.66 – 1.55 (m, 4H), 1.46 – 1.35 (m, 2H).  $^{13}\text{C}$  NMR (176 MHz,  $\text{D}_2\text{O}$ )  $\delta$  100.1, 98.7, 97.9, 96.1, 96.1, 78.8, 77.4, 75.0, 74.9, 73.7, 73.4, 72.7, 72.5, 70.6, 70.4, 70.3, 70.2, 69.7, 69.6, 67.4, 67.1, 66.9, 66.3, 66.2, 64.8, 60.9, 60.7, 39.3, 27.9, 26.4, 22.4.  $^{31}\text{P}$  NMR (243 MHz,  $\text{D}_2\text{O}$ )  $\delta$  -1.9. HR-ESI-MS (*m/z*): calculated for  $\text{C}_{29}\text{H}_{53}\text{NO}_{24}\text{P}$  [*M*] $^-$ : 830.2701, found: 830.2687

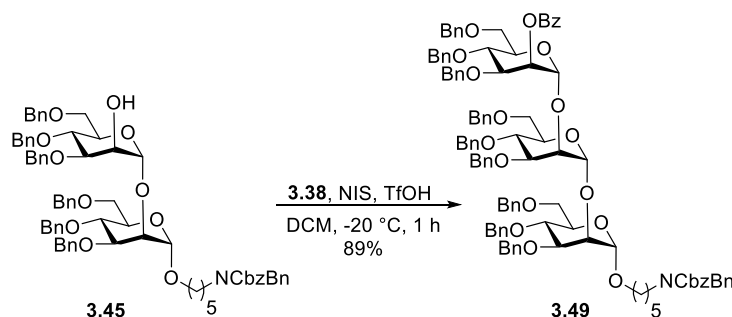
**5-Aminopentyl  $\beta$ -D-mannopyranosyl-(1 $\rightarrow$ 2)- $\alpha$ -D-mannopyranosyl-(1 $\rightarrow$ 2)- $\alpha$ -D-mannopyranoside (3.48)**



The trisaccharide **3.46** (12 mg, 7.3  $\mu\text{mol}$ ) was dissolved in the solution of EtOAc/*t*-BuOH/ $\text{H}_2\text{O}$  (2/1/1, *v/v/v*, 2 mL) and Pd/C (60 mg) was added to the solution. After stirring for 24 h under hydrogen atmosphere (1 atm, balloon), the mixture was filtered through a PTFE filter (0.45  $\mu\text{m}$  pore size) and concentrated. The crude material was purified by HPLC (Hypercarb column, 150 x 10 mm,  $\text{H}_2\text{O}$  (0.1% formic acid) isocratic (5 min), linear gradient to 40% ACN (35 min), linear

gradient to 100% ACN (10 min)) and lyophilized to obtain pure trisaccharide **3.48** (3 mg, 70%). <sup>1</sup>H NMR (700 MHz, D<sub>2</sub>O) δ 5.09 (d, *J* = 1.8 Hz, 1H), 5.04 (d, *J* = 1.7 Hz, 1H), 4.75 (d, *J* = 1.0 Hz, 1H), 4.25 (dd, *J* = 3.4, 1.8 Hz, 1H), 3.99 (dd, *J* = 3.3, 0.9 Hz, 1H), 3.92 (dd, *J* = 3.5, 1.7 Hz, 1H), 3.88 (dd, *J* = 12.3, 2.3 Hz, 1H), 3.86 – 3.80 (m, 4H), 3.74 – 3.67 (m, 5H), 3.65 – 3.62 (m, 2H), 3.60 (dd, *J* = 9.6, 3.3 Hz, 1H), 3.58 – 3.54 (m, 1H), 3.54 – 3.48 (m, 2H), 3.34 (ddd, *J* = 9.5, 6.7, 2.3 Hz, 1H), 2.95 (t, *J* = 7.6 Hz, 2H), 1.69 – 1.55 (m, 4H), 1.47 – 1.34 (m, 2H). <sup>13</sup>C NMR (176 MHz, D<sub>2</sub>O) δ 171.0, 100.1, 98.4, 98.0, 78.8, 76.9, 76.3, 73.3, 72.7, 72.7, 70.7, 70.1, 69.6, 67.4, 67.0, 66.9, 66.6, 60.9, 60.8, 60.7, 39.3, 27.9, 26.4, 22.4. HR-ESI-MS (*m/z*): calculated for C<sub>23</sub>H<sub>43</sub>NO<sub>16</sub>H [M+H]<sup>+</sup>: 590.2660, found: 590.2660.

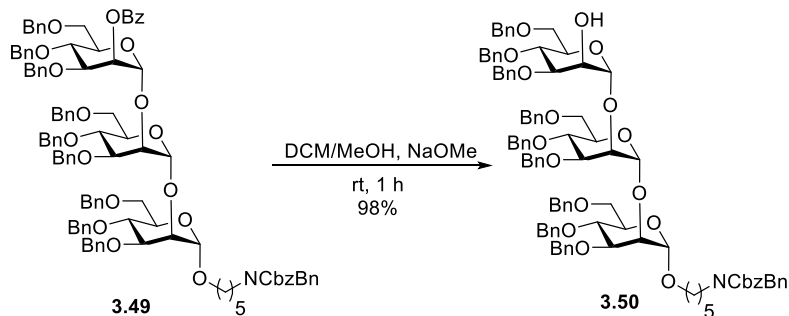
***N*-(Benzyl)benzyloxycarbonyl-5-aminopentyl 2-benzoyl-3,4,6-*O*-tri-benzyl- $\alpha$ -D-mannopyranosyl-(1 $\rightarrow$ 2)-3,4,6-*O*-tri-benzyl- $\alpha$ -D-mannopyranosyl-(1 $\rightarrow$ 2)-3,4,6-*O*-tri-benzyl- $\alpha$ -D-mannopyranoside (**3.49**)**



Acceptor **3.45** (1.2 g, 1.01 mmol) and thioglycoside donor **3.38** (907 mg, 1.52 mmol) were mixed, co-evaporated with toluene (3 x 10 mL) and dried under vacuum for 2 h. The mixture was dissolved in anhydrous DCM (25 mL), freshly activated molecular sieves (4 Å) were added under a nitrogen atmosphere and stirred for 30 min. at room temperature. The mixture was cooled to -20 °C, to this stirred suspension, NIS (363 mg; 1.62 mmol) and TfOH (44 μL, 0.505 mmol) were slowly added. The mixture was stirred at -20 °C for 1 h, diluted with DCM (20 mL), quenched with Et<sub>3</sub>N, warmed to room temperature and molecular sieves (4 Å) were filtered. The filtrate was washed with 10% aqueous Na<sub>2</sub>S<sub>2</sub>O<sub>3</sub>, saturated aqueous NaHCO<sub>3</sub> and brine. The combined organic layer was dried over Na<sub>2</sub>SO<sub>4</sub>, filtered and evaporated *in vacuo*. The crude product was purified by silica gel column chromatography using 15% ethyl acetate in hexanes to afford protected trisaccharide **3.49** (1.569 g, 89%). <sup>1</sup>H NMR (600 MHz, CDCl<sub>3</sub>) δ 8.10 – 8.06 (m, 2H), 7.57 (tt, *J* = 7.4, 1.3 Hz, 1H), 7.40 – 7.36 (m, 2H), 7.36 – 7.31 (m, 6H), 7.31 – 7.27 (m, 16H), 7.26 – 7.22 (m, 10H), 7.22 – 7.19 (m, 5H), 7.19 – 7.14 (m, 11H), 7.13 – 7.07 (m, 1H), 7.06 – 7.00 (m, 1H), 5.75 (t, *J* = 2.3 Hz, 1H), 5.22 (d, *J* = 2.0 Hz, 1H), 5.16 (d, *J* = 17.3 Hz, 2H), 5.11 (d, *J* = 2.0 Hz, 1H), 4.89 – 4.78 (m, 4H), 4.76 (d, *J* = 11.2 Hz, 1H), 4.64 (dt, *J* = 24.8, 12.5 Hz, 4H), 4.56 – 4.55 (m, 2H), 4.53 (d, *J* = 4.7 Hz, 1H), 4.53 – 4.49 (m, 4H), 4.49 – 4.44 (m, 3H), 4.35 (d, *J* = 11.9 Hz, 1H), 4.14 – 4.06 (m, 3H), 3.99 – 3.87 (m, 4H), 3.81 – 3.71 (m, 6H), 3.67 (d, *J* = 10.6 Hz, 2H), 3.63 – 3.55 (m, 1H), 3.55 – 3.44 (m, 1H), 3.25 – 3.11 (m, 3H), 1.52 – 1.38 (m, 4H), 1.21 – 1.13 (m, 2H). <sup>13</sup>C NMR (151 MHz, CDCl<sub>3</sub>) δ 165.5, 138.7, 138.6, 138.6, 138.5, 138.2, 133.2, 130.2, 130.1, 128.7, 128.6, 128.5, 128.5, 128.5, 128.5, 128.4, 128.4, 128.4, 128.2, 128.1, 128.1, 127.9, 127.8, 127.8, 127.7, 127.7, 127.6, 127.6, 127.5, 127.5, 127.3, 100.8, 99.6, 98.9, 79.8, 78.2, 77.4, 77.2, 76.9, 75.6, 75.4, 75.3, 75.1,

75.0, 74.9, 74.4, 73.4, 73.4, 73.3, 72.3, 72.3, 72.2, 72.2, 71.9, 71.7, 69.7, 69.4, 69.1, 67.6, 67.3, 50.6, 50.3, 47.2, 46.2, 29.4, 28.1, 27.6, 23.5. HR-ESI-MS (*m/z*): calculated for C<sub>108</sub>H<sub>113</sub>NO<sub>19</sub>Na [M+Na]<sup>+</sup>: 1750.7805, found: 1750.7801.

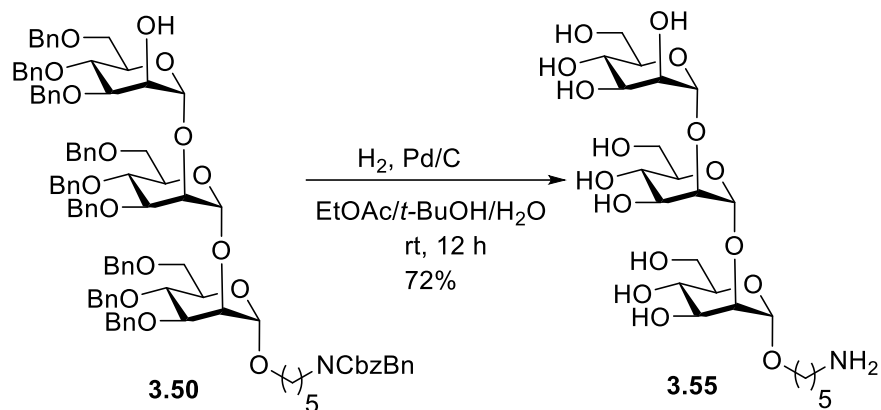
***N*-(Benzyl)benzyloxycarbonyl-5-aminopentyl 3,4,6-*O*-tri-benzyl- $\alpha$ -D-mannopyranosyl-(1 $\rightarrow$ 2)-3,4,6-*O*-tri-benzyl- $\alpha$ -D-mannopyranosyl-(1 $\rightarrow$ 2)-3,4,6-*O*-tri-benzyl- $\alpha$ -D-mannopyranoside (3.50)**



Compound **25** (1.569 g, 0.907 mmol) was dissolved in DCM/MeOH (1:2, 15 mL) was added NaOMe (1.81 mL, 0.907 mmol) and stirred the reaction mixture for 4 h at room temperature. After completion of reaction it was neutralized with the addition of Amberlite® IR120 H<sup>+</sup>, filtered and concentrated. The crude was purified by silica gel column chromatography to get trisaccharide **26** (1.441 g, 98%). <sup>1</sup>H NMR (600 MHz, CDCl<sub>3</sub>)  $\delta$  7.37 – 7.10 (m, 55H), 5.21 (d, *J* = 2.0 Hz, 1H), 5.19 – 5.11 (m, 3H), 4.88 (s, 1H), 4.81 (t, *J* = 10.1 Hz, 3H), 4.66 (d, *J* = 12.3 Hz, 2H), 4.62 – 4.42 (m, 14H), 4.31 (d, *J* = 12.2 Hz, 1H), 4.11 (q, *J* = 2.5 Hz, 2H), 3.97 – 3.86 (m, 6H), 3.86 – 3.70 (m, 6H), 3.67 (d, *J* = 10.6 Hz, 2H), 3.62 (dd, *J* = 10.5, 3.2 Hz, 1H), 3.56 – 3.46 (m, 2H), 3.25 – 3.08 (m, 3H), 2.36 (s, 1H), 1.51 – 1.32 (m, 4H), 1.22 – 1.02 (m, 2H). <sup>13</sup>C NMR (151 MHz, CDCl<sub>3</sub>)  $\delta$  138.7, 138.6, 138.5, 138.4, 138.3, 138.2, 128.7, 128.6, 128.6, 128.6, 128.5, 128.5, 128.5, 128.4, 128.4, 128.4, 128.2, 128.0, 128.0, 127.9, 127.8, 127.7, 127.7, 127.6, 127.6, 127.6, 127.5, 127.3, 101.1, 101.0, 98.9, 80.1, 79.6, 77.4, 77.2, 77.0, 75.4, 75.2, 75.1, 75.0, 75.0, 74.4, 73.4, 73.4, 73.4, 72.4, 72.3, 72.2, 71.9, 71.7, 69.7, 69.4, 69.0, 68.6, 67.6, 67.3, 50.6, 50.3, 47.2, 46.2, 29.4, 28.1, 27.6, 23.5. HR-ESI-MS (*m/z*): calculated for C<sub>101</sub>H<sub>109</sub>NO<sub>18</sub>Na [M+Na]<sup>+</sup>: 1646.7542, found: 1646.7487.

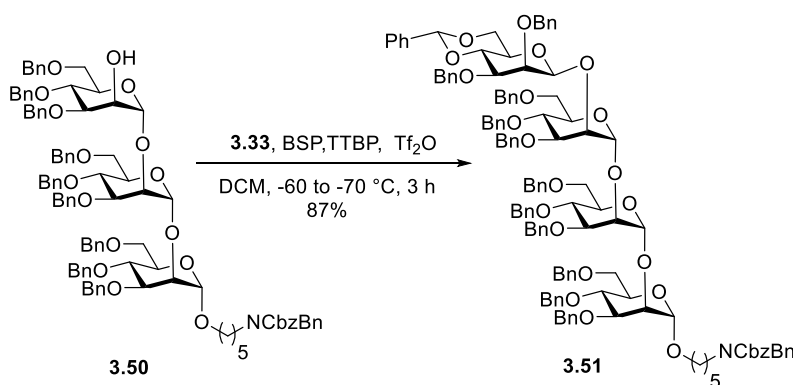
**5-Aminopentyl  $\alpha$ -D-mannopyranosyl-(1 $\rightarrow$ 2)- $\alpha$ -D-mannopyranosyl-(1 $\rightarrow$ 2)- $\alpha$ -D-mannopyranoside (3.55)**





The trisaccharide **3.50** (20 mg, 12.3  $\mu\text{mol}$ ) was dissolved in the solution of EtOAc/*t*-BuOH/ $\text{H}_2\text{O}$  (2/1/1, v/v/v, 2 mL) and Pd/C (50 mg) was added to the solution. After stirring 12 h under a hydrogen atmosphere (1 atm, balloon), the mixture was filtered through a PTFE filter (0.45  $\mu\text{m}$  pore size) and concentrated. The crude material was purified by HPLC (Hypercarb column, 150 x10 mm,  $\text{H}_2\text{O}$  (0.1% formic acid) isocratic (5 min), linear gradient to 10% ACN (30 min), linear gradient to 100% ACN (10 min)) and lyophilized to obtain pure trisaccharide **3.55** (5.2 mg, 72%).  $^1\text{H}$  NMR (400 MHz,  $\text{D}_2\text{O}$ )  $\delta$  5.23 (s, 1H), 5.04 (d,  $J = 1.7$  Hz, 1H), 4.98 (d,  $J = 1.9$  Hz, 1H), 4.08 – 3.98 (m, 2H), 3.92 – 3.80 (m, 6H), 3.78 (dd,  $J = 9.7, 3.3$  Hz, 1H), 3.75 – 3.64 (m, 6H), 3.62 (d,  $J = 2.8$  Hz, 1H), 3.57 (dt,  $J = 14.1, 6.3$  Hz, 3H), 3.51 – 3.44 (m, 1H), 2.94 (t,  $J = 7.6$  Hz, 2H), 1.69 – 1.51 (m, 4H), 1.49 – 1.32 (m, 2H).  $^{13}\text{C}$  NMR (101 MHz,  $\text{D}_2\text{O}$ )  $\delta$  102.2, 100.6, 97.9, 79.0, 78.6, 73.2, 72.7, 70.2, 70.1, 69.8, 67.4, 67.0, 66.9, 66.7, 61.1, 60.8, 39.2, 27.9, 26.4, 22.3. HR-ESI-MS (m/z): calculated for  $\text{C}_{23}\text{H}_{43}\text{NO}_{16}\text{H}$  [ $\text{M}+\text{H}$ ] $^+$ : 590.2660, found: 590.2669.

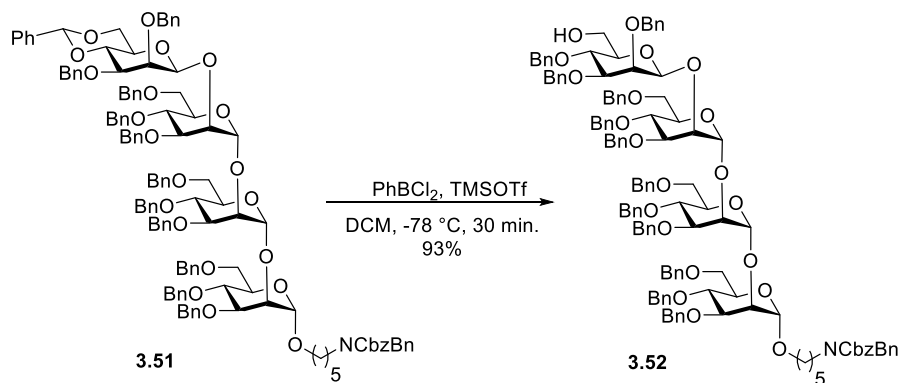
***N*-(Benzyl)benzyloxycarbonyl-5-aminopentyl 2,3-*O*-di-benzyl-4,6-*O*-benzylidene- $\beta$ -*D*-mannopyranosyl-(1 $\rightarrow$ 2)-3,4,6-*O*-tri-benzyl- $\alpha$ -*D*-mannopyranosyl-(1 $\rightarrow$ 2)-3,4,6-*O*-tri-benzyl- $\alpha$ -*D*-mannopyranosyl-(1 $\rightarrow$ 2)-3,4,6-*O*-tri-benzyl- $\alpha$ -*D*-mannopyranoside (**3.51**)**



To the solution of donor **3.33** (181.8 mg, 0.369 mmol) in DCM (5 mL) were added molecular sieves (4  $\text{\AA}$ ) and stirred the solution for 30 min. BSP (77.2 mg, 0.396 mmol) and TTBP (122.2 mg, 0.492 mmol) were added to the reaction mixture at -60  $^\circ\text{C}$  and stirred the reaction for 30 min. After stirring for 30 min,  $\text{Tf}_2\text{O}$  (103  $\mu\text{L}$ , 0.615 mmol) was added and stirred the mixture for 30 min. The reaction mixture was brought to -70  $^\circ\text{C}$  and acceptor **3.50** was added. After stirring for 2

h, reaction was quenched by adding Et<sub>3</sub>N (1 mL) and filtered through Celite<sup>®</sup>. Organic layer was washed with saturated aqueous sodium bicarbonate, dried over Na<sub>2</sub>SO<sub>4</sub> and evaporated *in vacuo*. The crude was purified by silica gel column chromatography (20% ethyl acetate in hexanes) to get the tetrasaccharide **3.51** (220 mg, 87%). <sup>1</sup>H NMR (600 MHz, CDCl<sub>3</sub>) δ 7.50 – 7.45 (m, 4H), 7.41 (d, *J* = 7.3 Hz, 2H), 7.37 (dd, *J* = 5.4, 1.9 Hz, 3H), 7.35 – 7.27 (m, 18H), 7.26 – 6.96 (m, 34H), 5.54 (s, 1H), 5.20 (s, 1H), 5.15 (d, *J* = 16.6 Hz, 2H), 5.05 (d, *J* = 2.6 Hz, 1H), 5.00 (d, *J* = 11.7 Hz, 1H), 4.88 – 4.81 (m, 3H), 4.77 (dd, *J* = 11.5, 4.2 Hz, 2H), 4.72 – 4.55 (m, 5H), 4.55 – 4.44 (m, 10H), 4.41 (d, *J* = 11.1 Hz, 1H), 4.23 – 4.12 (m, 5H), 4.08 (t, *J* = 9.6 Hz, 1H), 3.98 (s, 1H), 3.93 (dd, *J* = 7.9, 3.0 Hz, 1H), 3.91 – 3.81 (m, 5H), 3.81 – 3.77 (m, 3H), 3.77 – 3.64 (m, 6H), 3.56 – 3.44 (m, 2H), 3.41 (dd, *J* = 10.5, 2.0 Hz, 1H), 3.24 (dd, *J* = 9.9, 3.2 Hz, 1H), 3.22 – 3.09 (m, 3H), 2.89 (s, 1H), 1.52 – 1.36 (m, 4H), 1.35 – 1.23 (m, 2H). <sup>13</sup>C NMR (176 MHz, CDCl<sub>3</sub>) δ 156.8, 156.2, 101.5, 100.7, 100.1, 98.8, 80.0, 79.9, 78.5, 77.8, 77.3, 77.2, 77.0, 76.4, 76.1, 75.3, 75.2, 75.2, 75.1, 75.0, 74.9, 74.4, 73.5, 73.4, 73.4, 73.3, 72.9, 72.9, 72.2, 72.0, 71.9, 71.7, 71.6, 71.3, 69.5, 69.3, 68.8, 68.6, 67.6, 67.2, 67.1, 50.5, 50.2, 47.1, 46.2, 29.8, 29.3, 28.0, 27.6, 23.4, 22.8. HR-ESI-MS (*m/z*): calculated for C<sub>128</sub>H<sub>135</sub>NO<sub>23</sub>Na [M+Na]<sup>+</sup>: 2076.9323, found: 2076.9321.

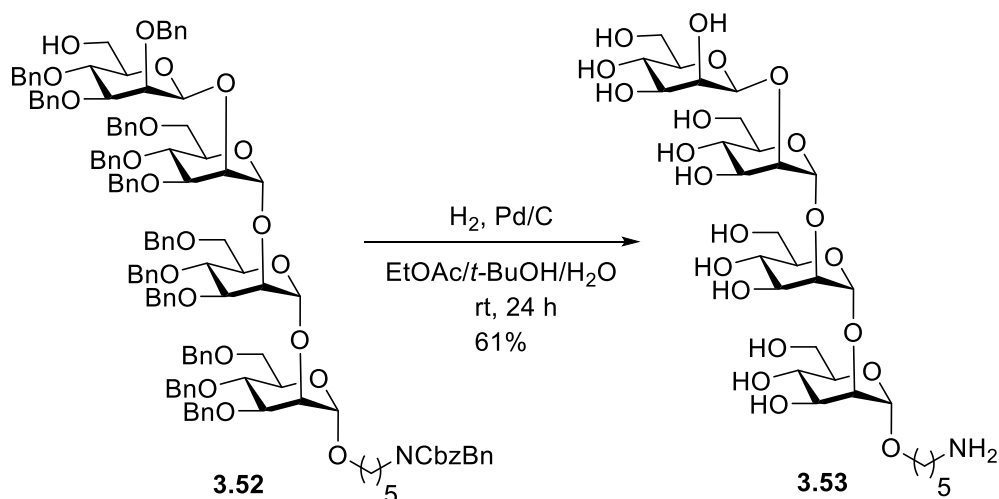
***N*-(Benzyl)benzyloxycarbonyl-5-aminopentyl 2,3,4-*O*-di-benzyl-β-*D*-mannopyranosyl-(1→2)-3,4,6-*O*-tri-benzyl-α-*D*-mannopyranosyl-(1→2)-3,4,6-*O*-tri-benzyl-α-*D*-mannopyranosyl-(1→2)-3,4,6-*O*-tri-benzyl-α-*D*-mannopyranoside (3.52)**



To the solution of tetrasaccharide **3.51** (183 mg, 0.089 mol) in DCM (5 mL) added molecular sieves (4 Å) and stirred the reaction mixture for 30 min. After 30 min of stirring, brought the reaction mixture to -78 °C and added triethylsilane (0.042 mL, 0.267 mmol) and dichlorophenyl borane (0.023 mL, 0.178 mmol) and stirred for 30 min. Quenched the reaction by adding 1 mL of triethylamine, filtered through Celite<sup>®</sup>, washed the organic layer with saturated aqueous NaHCO<sub>3</sub>, brine, dried over Na<sub>2</sub>SO<sub>4</sub> and evaporated *in vacuo*. The crude was purified by silica gel column chromatography to get tetrasaccharide **3.52** (170 mg, 93%). <sup>1</sup>H NMR (700 MHz, CDCl<sub>3</sub>) δ 7.48 (dd, *J* = 6.8, 2.9 Hz, 2H), 7.41 (d, *J* = 7.5 Hz, 2H), 7.35 – 7.26 (m, 31H), 7.25 – 7.18 (m, 20H), 7.17 – 7.12 (m, 9H), 7.11 – 7.03 (m, 6H), 5.22 – 5.12 (m, 3H), 5.07 (d, *J* = 2.3 Hz, 1H), 4.98 (dd, *J* = 54.3, 11.4 Hz, 2H), 4.90 – 4.82 (m, 3H), 4.79 (dd, *J* = 11.7, 3.4 Hz, 2H), 4.75 – 4.64 (m, 3H), 4.64 – 4.56 (m, 2H), 4.56 – 4.40 (m, 12H), 4.32 (d, *J* = 12.1 Hz, 1H), 4.26 – 4.17 (m, 5H), 4.01 – 3.94 (m, 2H), 3.93 – 3.74 (m, 11H), 3.73 – 3.65 (m, 5H), 3.47 (ddd, *J* = 44.6, 10.5, 2.8 Hz, 3H), 3.25 – 3.11 (m, 4H), 1.24 – 1.10 (m, 4H), 0.90 – 0.85 (m, 2H). <sup>13</sup>C NMR (176 MHz, CDCl<sub>3</sub>) δ

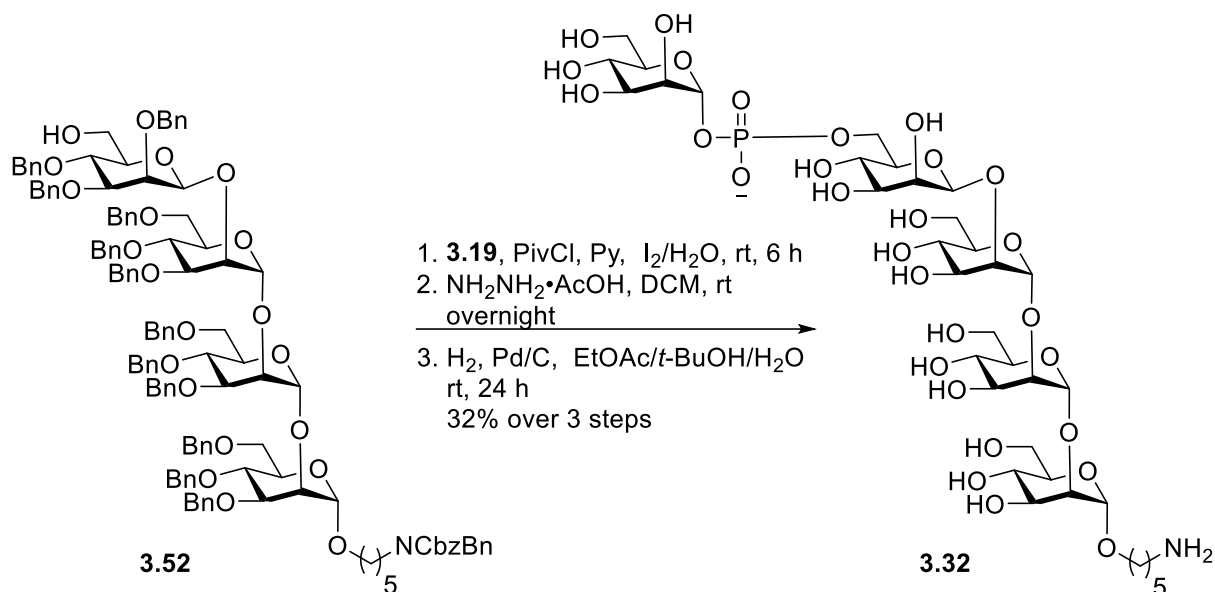
138.9, 138.8, 138.6, 138.5, 138.5, 138.4, 138.4, 138.0, 137.0, 136.9, 128.7, 128.6, 128.6, 128.6, 128.5, 128.5, 128.5, 128.5, 128.4, 128.4, 128.3, 128.2, 128.2, 128.1, 128.0, 128.0, 127.9, 127.9, 127.9, 127.8, 127.8, 127.7, 127.7, 127.7, 127.6, 127.6, 127.6, 127.5, 127.5, 100.7, 99.7, 98.9, 81.2, 80.0, 79.9, 78.1, 77.3, 77.2, 77.0, 75.7, 75.4, 75.3, 75.2, 75.0, 74.9, 74.8, 74.6, 74.5, 74.5, 74.4, 74.2, 73.5, 73.4, 73.4, 73.4, 73.2, 72.8, 72.3, 72.0, 71.9, 71.9, 71.0, 70.8, 69.6, 69.3, 68.8, 67.6, 67.3, 67.3, 62.3, 50.6, 50.2, 47.2, 46.2, 32.1, 31.6, 31.6, 30.4, 30.3, 30.3, 30.2, 29.8, 29.8, 29.5, 29.4, 28.1, 27.6, 23.5, 22.8, 19.9, 14.3, 7.0, 6.7, 6.5, 5.9, 1.2. HR-ESI-MS ( $m/z$ ): calculated for  $C_{128}H_{138}NO_{23}H [M+H]^+$ : 2056.9660, found: 2056.9558

**5-Aminopentyl  $\beta$ -D-mannopyranosyl-(1 $\rightarrow$ 2)- $\alpha$ -D-mannopyranosyl-(1 $\rightarrow$ 2)- $\alpha$ -D-mannopyranosyl-(1 $\rightarrow$ 2)- $\alpha$ -D-mannopyranoside (3.53)**



The tetrasaccharide **3.51** (25 mg, 12.2  $\mu$ mol) was dissolved in the solution of EtOAc/*t*-BuOH/ $H_2O$  (2/1/1, *v/v/v*, 2 mL) and Pd/C (60 mg) was added to the solution. After stirring for 24 h under hydrogen atmosphere (1 atm, balloon), the mixture was filtered through a PTFE filter (0.45  $\mu$ m pore size) and concentrated. The crude material was purified by HPLC (Hypercarb column, 150 x 10 mm,  $H_2O$  (0.1% formic acid) isocratic (5 min), linear gradient to 10% ACN (30 min), linear gradient to 100% ACN (10 min)) and lyophilized to obtain pure trisaccharide **3.53** (5.6 mg, 61%).  $^1H$  NMR (700 MHz,  $D_2O$ )  $\delta$  5.24 (d,  $J = 1.8$  Hz, 1H), 5.12 (d,  $J = 1.8$  Hz, 1H), 5.04 (d,  $J = 1.7$  Hz, 1H), 4.75 (s, 1H), 4.24 (dd,  $J = 3.4, 1.8$  Hz, 1H), 4.08 (dd,  $J = 3.3, 1.8$  Hz, 1H), 3.99 (d,  $J = 3.3$  Hz, 1H), 3.92 – 3.87 (m, 3H), 3.86 – 3.80 (m, 5H), 3.73 – 3.66 (m, 7H), 3.66 – 3.58 (m, 4H), 3.56 (ddd,  $J = 9.6, 6.3, 2.3$  Hz, 1H), 3.54 – 3.47 (m, 2H), 3.33 (ddd,  $J = 9.5, 6.7, 2.3$  Hz, 1H), 2.95 (t,  $J = 7.6$  Hz, 2H), 1.70 – 1.55 (m, 3H), 1.45 – 1.35 (m, 2H).  $^{13}C$  NMR (176 MHz,  $D_2O$ )  $\delta$  100.6, 99.9, 98.4, 97.9, 78.9, 78.7, 76.9, 76.3, 73.3, 73.2, 72.7, 70.7, 70.1, 69.8, 69.6, 67.4, 67.0, 67.0, 66.9, 66.6, 61.1, 60.9, 60.8, 60.7, 39.3, 27.9, 26.4, 22.4. HR-ESI-MS ( $m/z$ ): calculated for  $C_{128}H_{135}NO_{23}Na [M+Na]^+$ : 2076.9323, found: 2076.932.

**5-Aminopentyl- $\beta$ -D-mannopyranosyl [ $\alpha$ -D-mannopyranosyl]-6-phosphate-(1 $\rightarrow$ 2)- $\alpha$ -D-mannopyranosyl-(1 $\rightarrow$ 2)- $\alpha$ -D-mannopyranoside (3.32)**



Tetrasaccharide alcohol **34** (25 mg, 12.15  $\mu$ mol) and H-phosphonate X (17.3 mg, 24.3  $\mu$ mol) were co-evaporated three times with pyridine and the resulting mixture was dried under vacuum overnight before dissolving in anhydrous pyridine (2 mL). Pivaloyl chloride (7.4  $\mu$ L, 60.7  $\mu$ mol) was then added. After 5 h of stirring at room temperature, a freshly prepared solution of iodine (6.7 mg, 72.5  $\mu$ mol) in pyridine/water (10/1, 0.3 mL) was added. After 2 h, the reaction was diluted with DCM, washed with saturated Na<sub>2</sub>S<sub>2</sub>O<sub>3</sub> solution and TEAB buffer, dried over Na<sub>2</sub>SO<sub>4</sub> and evaporated under reduced pressure. The crude was dissolved in DCM (3 mL), added hydrazine acetate (7.4 mg, 60.7  $\mu$ mol) and stirred the reaction mixture overnight at room temperature. After completion of reaction, quenched by acetone and evaporated *in vacuo*. The crude was dissolved in the solution of EtOAc/*t*-BuOH/H<sub>2</sub>O (2/1/1, *v/v/v*, 2 mL) and Pd/C (50 mg) was added to the solution. After stirring for 24 h under hydrogen atmosphere (1 atm, balloon), the mixture was filtered through a PTFE filter (0.45  $\mu$ m pore size) and concentrated. The crude material was purified by HPLC (Hypercarb column, 150 x10 mm, H<sub>2</sub>O (0.1% formic acid) isocratic (5 min), linear gradient to 40% ACN (35 min), linear gradient to 100% ACN (10 min)) and lyophilized to obtain pure pentasaccharide **4** (3.9 mg, 32%). <sup>1</sup>H NMR (700 MHz, D<sub>2</sub>O)  $\delta$  5.39 (dd, *J* = 7.9, 2.0 Hz, 1H), 5.23 (d, *J* = 1.8 Hz, 1H), 5.13 (d, *J* = 1.8 Hz, 1H), 5.05 (d, *J* = 1.7 Hz, 1H), 4.77 (d, *J* = 9.5 Hz, 1H), 4.25 (dd, *J* = 3.3, 1.8 Hz, 1H), 4.17 (ddd, *J* = 7.5, 5.5, 2.7 Hz, 1H), 4.08 (dd, *J* = 3.4, 1.8 Hz, 1H), 4.04 – 3.99 (m, 2H), 3.96 (dd, *J* = 3.4, 2.1 Hz, 1H), 3.91 – 3.86 (m, 4H), 3.85 – 3.77 (m, 6H), 3.75 – 3.67 (m, 7H), 3.66 – 3.58 (m, 6H), 3.58 – 3.55 (m, 1H), 3.52 – 3.46 (m, 2H), 2.98 – 2.93 (m, 2H), 1.68 – 1.55 (m, 4H), 1.46 – 1.34 (m, 2H). <sup>13</sup>C NMR (176 MHz, D<sub>2</sub>O)  $\delta$  100.6, 100.0, 98.7, 97.9, 96.1, 96.1, 79.0, 78.7, 77.5, 74.9, 73.7, 73.3, 73.2, 72.7, 72.5, 70.7, 70.4, 70.1, 69.9, 69.7, 69.6, 67.4, 67.0, 67.0, 66.9, 66.3, 66.2, 64.8, 61.1, 60.9, 60.7, 60.7, 39.3, 27.8, 26.4, 22.3. HR-ESI-MS (*m/z*): calculated for C<sub>35</sub>H<sub>63</sub>NO<sub>29</sub>P [M]<sup>-</sup>: 992.3229, found: 992.3167.

## Glycan Microarray Screening

The *in vivo* experiments to obtain the mouse plasma used in this study were published previously.<sup>131</sup> Briefly, healthy C57Bl6 male mice (aged 8-9 weeks) were i.v. challenged through the tail vein with  $1 \times 10^7$  c.f.u. per mouse log-phase inoculum *C. auris* 10051895  $n=6$  and three days after infection plasma was collected and stored at  $-80^{\circ}\text{C}$ .

The glycans were dissolved at 0.1 mM in 50 mM sodium phosphate buffer pH 8.5 and printed in 64 identical fields to NHS activated hydrogel glass slides (CodeLink slides, Surmodics) using a non-contact S3 microarray spotter (Scienion, Berlin, Germany). After incubation overnight in a humidified box, the remaining NHS groups of the slides were quenched with ethanolamine. The slides were blocked with 1% (w/v) bovine serum albumin (BSA) in phosphate buffered saline (PBS) and a 64 well incubation gasket (FlexWell Grid, Grace Bio Labs) was attached. The slides were incubated with mice plasma diluted 1:50 in 1% BSA-PBS for 1 h at  $37^{\circ}$ . After three washes with PBS containing 0.1% (v/v) Tween-20 (PBS-T) the slides were incubated with goat anti-mouse IgM (heavy chain) secondary antibody, Alexa Fluor<sup>TM</sup> 647 (Invitrogen, Cat. A21238) diluted 1:400 for 1 h at  $37^{\circ}\text{C}$ . The slides were washed twice with PBS-T. After removing the gasket, the slides were washed once with PBS and once with water. The dried slides were scanned with a GenePix 4300A microarray scanner (Molecular Devices). Intensities were evaluated with GenePix Pro 7 (Molecular Devices). The statistical analysis was performed with the software GraphPad Prism 9.3.1 (GraphPad Software, Inc.).

## References

- (1) Gyles, C. L.; Prescott, J. F. Pathogenesis of Bacterial Infections in Animals. **2010**, 3-14.
- (2) Ford, B. J. Bacteria and Cells of Human Origin on van Leeuwenhoek's Sections of 1674. *Trans. Am. Micros. Soc.* **1982**, *101* (1), 1-9.
- (3) Schnecker, J.; Wild, B.; Hofhansl, F.; Eloy Alves, R. J.; Bárta, J.; Capek, P.; Fuchslueger, L.; Gentsch, N.; Gittel, A.; Guggenberger, G.; et al. Effects of soil organic matter properties and microbial community composition on enzyme activities in cryoturbated arctic soils. *PLOS ONE* **2014**, *9* (4), e94076-e94076.
- (4) McFall-Ngai, M.; Hadfield, M. G.; Bosch, T. C. G.; Carey, H. V.; Domazet-Lošo, T.; Douglas, A. E.; Dubilier, N.; Eberl, G.; Fukami, T.; Gilbert, S. F.; et al. Animals in a bacterial world, a new imperative for the life sciences. *Proc. Natl. Acad. Sci.* **2013**, *110* (9), 3229-3236.
- (5) Wilson, J. W.; Schurr, M. J.; LeBlanc, C. L.; Ramamurthy, R.; Buchanan, K. L.; Nickerson, C. A. Mechanisms of bacterial pathogenicity. *Postgrad. Med. J.* **2002**, *78* (918), 216.
- (6) Bhunia, A. K. General Mechanism of Pathogenesis. *Springer New York*, **2018**, 87-115.
- (7) Erkmen O.; Bozoglu T. F. Bacterial Pathogenicity and Microbial Toxins. *Food Microbiology: Principles into Practice*, **2016**, 126-137.
- (8) Vecht, U.; van Leengoed, L. A. M. G.; Verheijen, E. R. M. Streptococcus suis infections in pigs in the Netherlands (Part I). *Vet. Q.* **1985**, *7* (4), 315-321.
- (9) Hughes, J. M.; Wilson, M. E.; Wertheim, H. F. L.; Nghia, H. D. T.; Taylor, W.; Schultz, C. *Streptococcus suis*: An Emerging Human Pathogen. *Clin. Infect. Dis.* **2009**, *48* (5), 617-625.
- (10) Huong, V. T. L.; Turner, H. C.; Kinh, N. V.; Thai, P. Q.; Hoa, N. T.; Horby, P.; van Doorn, H. R.; Wertheim, H. F. Burden of disease and economic impact of human Streptococcus suis infection in Viet Nam. *Trans. R. Soc. Trop. Med. Hyg.* **2019**, *113* (6), 341-350.
- (11) Lun, Z. R.; Wang, Q. P.; Chen, X. G.; Li, A. X.; Zhu, X. Q. *Streptococcus suis*: an emerging zoonotic pathogen. *Lancet Infect. Dis.* **2007**, *7*, 201.
- (12) Sabbatani, S.; Fiorino, S. The Antonine Plague and the decline of the Roman Empire. *Infez. Med.* **2009**, *17* (4), 261-275.
- (13) Mordechai, L.; Eisenberg, M.; Newfield, T. P.; Izdebski, A.; Kay, J. E.; Poinar, H. The Justinianic Plague: An inconsequential pandemic? *Proc. Natl. Acad. Sci.* **2019**, *116* (51), 25546-25554.

- (14) Spyrou, M. A.; Musralina, L.; Gnecci Ruscone, G. A.; Kocher, A.; Borbone, P.-G.; Khartanovich, V. I.; Buzhilova, A.; Djansugurova, L.; Bos, K. I.; Kühnert, D.; et al. The source of the Black Death in fourteenth-century central Eurasia. *Nature* **2022**, *606* (7915), 718-724.
- (15) Glatter, K. A.; Finkelman, P. History of the Plague: An Ancient Pandemic for the Age of COVID-19. *Am. J. Med.* **2021**, *134* (2), 176-181.
- (16) Fleming, A. On the Antibacterial Action of Cultures of a Penicillium, with Special Reference to their Use in the Isolation of B. influenzae. *Br. J. Exp. Pathol.* **1929**, *10*(3), 226.
- (17) Aminov, R. I. A brief history of the antibiotic era: lessons learned and challenges for the future. *Front. in microbiol.* **2010**, *1*, 134-134.
- (18) Ventola, C. L. The antibiotic resistance crisis: part 1: causes and threats. *Pharmacol. Ther.* **2015**, *40* (4), 277-283
- (19) Egorov, A. M.; Ulyashova, M. M.; Rubtsova, M. Y. Bacterial Enzymes and Antibiotic Resistance. *Acta Naturae* **2018**, *10* (4), 33-48.
- (20) Klein, E. Y.; Van Boeckel, T. P.; Martinez, E. M.; Pant, S.; Gandra, S.; Levin, S. A.; Goossens, H.; Laxminarayan, R. Global increase and geographic convergence in antibiotic consumption between 2000 and 2015. *Proc. Natl. Acad. Sci.* **2018**, *115* (15), E3463-E3470.
- (21) Naranjo-Ortiz, M. A.; Gabaldón, T. Fungal evolution: major ecological adaptations and evolutionary transitions. *Biol. Rev.* **2019**, *94* (4), 1443-1476.
- (22) Köhler, J. R.; Casadevall, A.; Perfect, J. The spectrum of fungi that infects humans. *Cold Spring Harb. Perspect. Med.* **2014**, *5* (1), a019273-a019273.
- (23) Martin, K. W.; Ernst, E. Herbal medicines for treatment of fungal infections: a systematic review of controlled clinical trials. *Mycoses* **2004**, *47* (3-4), 87-92.
- (24) Sharma, M.; Chakrabarti, A. On the Origin of *Candida auris*: Ancestor, Environmental Stresses, and Antiseptics. *Mbio* **2020**, *11* (6), e02102-02120.
- (25) Nancy, A. C.; Lalitha, G.; Sharon, V. T.; Kaitlin, F.; Jane, A. G.; Karen, L. S.; Patricia, M. B.; Janna, L. K.; Shawn, R. L.; Tom, M. C.; et al. Multiple introductions and subsequent transmission of multidrug-resistant *Candida auris* in the USA: a molecular epidemiological survey. *Lancet Infect. Dis.* **2018**, *18* (12), 1377-1384.
- (26) Dennis, E. K.; Chaturvedi, S.; Chaturvedi, V. So Many Diagnostic Tests, So Little Time: Review and Preview of *Candida auris* Testing in Clinical and Public Health Laboratories. *Front. Microbiol.* **2021**, *12*, 757835.
- (27) WHO fungal priority pathogens list to guide research, development and public health action. Geneva: World Health Organization; **2022**.

- (28) Roemer, T.; Krysan, D. J. Antifungal drug development: challenges, unmet clinical needs, and new approaches. *Cold Spring Harb. Perspect. Med.* **2014**, *4* (5), a019703.
- (29) Bouz, G.; Doležal, M. Advances in Antifungal Drug Development: An Up-To-Date Mini Review. *Pharmaceuticals (Basel)* **2021**, *14* (12), 1312.
- (30) Maertens, J. A. History of the development of azole derivatives. *Clin. Microbiol. Infect.* **2004**, *10*, 1-10.
- (31) Dolton, M. J.; Perera, V.; Pont, L. G.; McLachlan, A. J. Terbinafine in combination with other antifungal agents for treatment of resistant or refractory mycoses: investigating optimal dosing regimens using a physiologically based pharmacokinetic model. *Antimicrob. Agents Chemother.* **2014**, *58* (1), 48-54.
- (32) Mesa-Arango, A. C.; Scorzoni, L.; Zaragoza, O. It only takes one to do many jobs: Amphotericin B as antifungal and immunomodulatory drug. *Front. microbiol.* **2012**, *3*, 286.
- (33) Patil, A.; Majumdar, S. Echinocandins in antifungal pharmacotherapy. *J. Pharm. Pharmacol.* **2017**, *69* (12), 1635-1660.
- (34) Micoli, F.; Bagnoli, F.; Rappuoli, R.; Serruto, D. The role of vaccines in combatting antimicrobial resistance. *Nat. Rev. Microbiol.* **2021**, *19* (5), 287-302.
- (35) Riedel, S. Edward Jenner and the history of smallpox and vaccination. *Proc. (Bayl. Univ. Med. Cent.)* **2005**, *18* (1), 21-25.
- (36) Fitzpatrick, M. The Cutter Incident: How America's First Polio Vaccine Led to a Growing Vaccine Crisis. *J. R. Soc. Med.* **2006**, *99* (3), 156-156.
- (37) Lauri, E. M.; Walter, A. O. Measles Vaccines. *Pediatr. Clin. North Am.* **1990**, *37* (3), 603-625.
- (38) Bouvier, N. M. The Future of Influenza Vaccines: A Historical and Clinical Perspective. *Vaccines* **2018**, *6* (3), 58.
- (39) Khan, S.; Ullah, M. W.; Siddique, R.; Nabi, G.; Manan, S.; Yousaf, M.; Hou, H. Role of Recombinant DNA Technology to Improve Life. *Int. J. Genomics* **2016**, *2016*, 2405954-2405954.
- (40) Fred, Z. Principles of vaccine design—Lessons from nature. *Vaccine* **2010**, *28*, C14-C24.
- (41) Bartlett, B. L.; Pellicane, A. J.; Tyring, S. K. Vaccine immunology. *Dermatol. Ther.* **2009**, *22* (2), 104-109.
- (42) Rodríguez-Gascón, A.; del Pozo-Rodríguez, A.; Solinís, M. Á. Development of nucleic acid vaccines: use of self-amplifying RNA in lipid nanoparticles. *Int. J. Nanomedicine* **2014**, *9*, 1833-1843.
- (43) Vogel, F. R.; Sarver, N. Nucleic acid vaccines. *Clin. Microbiol. Rev.* **1995**, *8* (3), 406-410.



- (44) Hansson, M.; Nygren, P.-A. k.; Stahl, S. Design and production of recombinant subunit vaccines. *Biotechnol. Appl. Biochem.* **2000**, *32* (2), 95-107.
- (45) Clark, T. G.; Cassidy-Hanley, D. Recombinant subunit vaccines: potentials and constraints. *Dev. Biol. (Basel)* **2005**, *121*, 153-163.
- (46) Tarbell, J. M.; Cancel, L. M. The glycocalyx and its significance in human medicine. *J. Intern. Med.* **2016**, *280* (1), 97-113.
- (47) Domenico, P.; Landolphi, D. R.; Cunha, B. A. Reduction of capsular polysaccharide and potentiation of aminoglycoside inhibition in Gram-negative bacteria by bismuth snbsalicylate. *J. Antimicrob. Chemother.* **1991**, *28* (6), 801-810.
- (48) Larson, T. R.; Yother, J. Membrane linkage of a *Streptococcus pneumoniae* Wzy capsular polysaccharide occurs through an acylglycerol. *bioRxiv* **2020**, 2020.2009.2016.299636.
- (49) Mettu, R.; Chen, C.-Y.; Wu, C.-Y. Synthetic carbohydrate-based vaccines: challenges and opportunities. *J. Biomed. Sci.* **2020**, *27* (1), 9.
- (50) Huang, Y.-L.; Wu, C.-Y. Carbohydrate-based vaccines: challenges and opportunities. *Expert Rev. Vaccines* **2010**, *9* (11), 1257-1274.
- (51) Watson, D. A.; Musher, D. M.; Jacobson, J. W.; Verhoef, J. A Brief History of the Pneumococcus in Biomedical Research: A Panoply of Scientific Discovery. *Clin. Infect. Dis.* **1993**, *17* (5), 913-924.
- (52) Goldblatt, D. Conjugate vaccines. *Clin. Exp. Immunol.* **2002**, *119* (1), 1-3.
- (53) Mairi, V.; David, P. Glycoconjugate vaccines: an update. *Expert Opin. Biol. Ther.* **2015**, *15* (4), 529-546.
- (54) Zaslona, M. E.; Downey, A. M.; Seeberger, P. H.; Moscovitz, O. Semi- and fully synthetic carbohydrate vaccines against pathogenic bacteria: recent developments. *Biochem. Soc. Trans.* **2021**, *49* (5), 2411-2429.
- (55) Farjana, K.; Istvan, T.; Rachel, J. S. Immunology of carbohydrate-based vaccines. *Adv. Drug Deliv. Rev.* **2020**, *165-166*, 117-126.
- (56) Costantino, P.; Rappuoli, R.; Berti, F. The design of semi-synthetic and synthetic glycoconjugate vaccines. *Expert Opin. Drug Discov.* **2011**, *6* (10), 1045-1066.
- (57) Anish, C.; Schumann, B.; Pereira, Claney L.; Seeberger, Peter H. Chemical Biology Approaches to Designing Defined Carbohydrate Vaccines. *Chem. Biol.* **2014**, *21* (1), 38-50.
- (58) Lepenies, B.; Seeberger, P. H. The promise of glycomics, glycan arrays and carbohydrate-based vaccines. *Immunopharmacol. Immunotoxicol.* **2010**, *32* (2), 196-207.

- (59) Geissner, A.; Anish, C.; Seeberger, P. H. Glycan arrays as tools for infectious disease research. *Curr. Opin. Chem. Biol.* **2014**, *18*, 38-45.
- (60) Micoli, F.; Adamo, R.; Costantino, P. Protein Carriers for Glycoconjugate Vaccines: History, Selection Criteria, Characterization and New Trends. *Molecules* **2018**, *23* (6), 1451.
- (61) Safari, D.; Dekker, H. A. T.; Rijkers, G.; Snippe, H. Codelivery of adjuvants at the primary immunization site is essential for evoking a robust immune response to neoglycoconjugates. *Vaccine* **2011**, *29* (4), 849-854.
- (62) Klaamas, K.; Held, M.; Wadström, T.; Lipping, A.; Kurtenkov, O. IgG immune response to *Helicobacter pylori* antigens in patients with gastric cancer as defined by ELISA and immunoblotting. *Int. J. Cancer* **1996**, *67* (1), 1-5.
- (63) Satoh, H.; Manabe, S. Design of chemical glycosyl donors: does changing ring conformation influence selectivity/reactivity? *Chem. Soc. Rev.* **2013**, *42* (10), 4297-4309.
- (64) Igarashi, K. The Koenigs-Knorr Reaction. **1977**, *34*, 243-283.
- (65) Haynes, L. J.; Newth, F. H. The Glycosyl Halides and Their Derivatives. **1955**, *10*, 207-256.
- (66) Mydock, L. K.; Demchenko, A. V. Mechanism of chemical O-glycosylation: from early studies to recent discoveries. *Org. Biomol. Chem.* **2010**, *8* (3), 497-510.
- (67) Garegg, P. J. Thioglycosides as Glycosyl Donors in Oligosaccharide Synthesis. In *Advances in Carbohydrate Chemistry and Biochemistry*, Horton, D. Ed.; Vol. 52; Academic Press, 1997; pp 179-205.
- (68) Toshima, K. Glycosyl fluorides in glycosidations. *Carbohydr. Res* **2000**, *327* (1), 15-26.
- (69) Mehta, S.; Mario Pinto, B. Phenylselenoglycosides as novel, versatile glycosyl donors. Selective activation over thioglycosides. *Tetrahedron Lett.* **1991**, *32* (35), 4435-4438.
- (70) Demchenko, A. V. General aspects of the glycosidic bond formation. *Handbook of chemical glycosylation: advances in stereoselectivity and therapeutic relevance* **2008**, 1-27.
- (71) Mukherjee, M. M.; Ghosh, R.; Hanover, J. A. Recent Advances in Stereoselective Chemical O-Glycosylation Reactions. *Front. Mol. Biosci.* **2022**, *9*, 896187.
- (72) Das, R.; Mukhopadhyay, B. Chemical O-Glycosylations: An Overview. *ChemistryOpen* **2016**, *5* (5), 401-433.
- (73) Marianski, M.; Mucha, E.; Greis, K.; Moon, S.; Pardo, A.; Kirschbaum, C.; Thomas, D. A.; Meijer, G.; von Helden, G.; Gilmore, K.; et al. Remote Participation during Glycosylation Reactions of Galactose Building Blocks: Direct Evidence from Cryogenic Vibrational Spectroscopy. *Angew. Chem. Int. Ed.* **2020**, *59* (15), 6166-6171.

- (74) Nigudkar, S. S.; Demchenko, A. V. Stereocontrolled 1,2-cis glycosylation as the driving force of progress in synthetic carbohydrate chemistry. *Chem. sci.* **2015**, *6* (5), 2687-2704.
- (75) Mong, K.-K. T.; Nokami, T.; Tran, N. T. T.; Nhi, P. B. Solvent Effect on Glycosylation. *Selective Glycosylations: Synthetic Methods and Catalysts*, 2017; pp 59-77.
- (76) Nishimura, D.; Hasegawa, A.; Nakajima, M. Solvent Effect and Anchimeric Assistance on  $\alpha$ -Glycosylation. *Agricul. Bio.Chem.* **1972**, *36* (10), 1767-1772.
- (77) Frechet, J.; Schuerch, C. Solid-phase synthesis of oligosaccharides. I. Preparation of the solid support. Poly [*p*-(1-propen-3-ol-1-yl)]. *J. Am. Chem. Soc.* **1971**, *93* (2), 492-496.
- (78) Kaplan, B. E. The automated synthesis of oligodeoxyribonucleotides. *Trends Biotechnol.* **1985**, *3* (10), 253-256.
- (79) Plante, O. J.; Palmacci, E. R.; Seeberger, P. H. Automated Solid-Phase Synthesis of Oligosaccharides. *Science* **2001**, *291* (5508), 1523-1527.
- (80) Mattan, H.; Jeyakumar, K.; Mayeul, C.; Daniel, K.; Tyler, M. D.; Seeberger P. H. Continuous Photochemical Cleavage of Linkers for Solid-Phase Synthesis. **2014**, *16* (6), 1794-1797 .
- (81) Seeberger, P. H. The logic of automated glycan assembly. *Acc. Chem. Res.* **2015**, *48* (5), 1450-1463.
- (82) Gisin, B. The preparation of Merrifield-resins through total esterification with cesium salts. *Helve. Chim. Acta* **1973**, *56* (5), 1476-1482.
- (83) Eller, S.; Collot, M.; Yin, J.; Hahm, H. S.; Seeberger, P. H. Automated solid-phase synthesis of chondroitin sulfate glycosaminoglycans. *Angew. Chem. Int. Ed.* **2013**, *52* (22), 5858-5861.
- (84) Andrade, R. B.; Plante, O. J.; Melean, L. G.; Seeberger, P. H. Solid-phase oligosaccharide synthesis: preparation of complex structures using a novel linker and different glycosylating agents. *Org. lett.* **1999**, *1* (11), 1811-1814.
- (85) Kröck, L.; Esposito, D.; Castagner, B.; Wang, C.-C.; Bindschädler, P.; Seeberger, P. H. Streamlined access to conjugation-ready glycans by automated synthesis. *Chem. Sci.* **2012**, *3* (5), 1617-1622.
- (86) Le Mai Hoang, K.; Pardo-Vargas, A.; Zhu, Y.; Yu, Y.; Loria, M.; Delbianco, M.; Seeberger, P. H. Traceless photolabile linker expedites the chemical synthesis of complex oligosaccharides by automated glycan assembly. *J. Am. Chem. Soc.* **2019**, *141* (22), 9079-9086.
- (87) Feng, Y.; Zhang, H.; Wu, Z.; Wang, S.; Cao, M.; Hu, D.; Wang, C. *Streptococcus suis* infection. *Virulence* **2014**, *5*, 477.
- (88) Zhao-Rong, L.; Qiao-Ping, W.; Xiao-Guang, C.; An-Xing, L.; Xing-Quan, Z. *Streptococcus suis*: an emerging zoonotic pathogen. *Lancet Infect. Dis.* **2007**, *7* (3), 201-209.

- (89) Elliott, S. D.; Clifton-Hadley, F.; Tai, J. Streptococcal infection in young pigs. V. An immunogenic polysaccharide from *Streptococcus suis* type 2 with particular reference to vaccination against streptococcal meningitis in pigs. *J. Hyg. Camb.* **1980**, *85* (2), 275-285.
- (90) Dutkiewicz, J.; Zając, V.; Sroka, J.; Wasieński, B.; Cisak, E.; Sawczyn, A.; Kloc, A.; Wójcik-Fatla, A. *Streptococcus suis*: a re-emerging pathogen associated with occupational exposure to pigs or pork products. Part II – Pathogenesis. *Ann. Agric. Environm. Med.* **2018**, *25* (1), 186-203.
- (91) Gajdács, M.; Németh, A.; Knausz, M.; Barrak, I.; Stájer, A.; Mestyán, G.; Melegh, S.; Nyul, A.; Tóth, Á.; Ágoston, Z.; et al. Streptococcus suis: An Underestimated Emerging Pathogen in Hungary? *Microorganisms* **2020**, *8* (9), 1292.
- (92) Gottschalk, M.; Segura, M.; Xu, J. *Streptococcus suis* infections in humans: the Chinese experience and the situation in North America. *Anim. Health Res. Rev.* **2007**, *8* (1), 29-45.
- (93) Estrada, A. A.; Gottschalk, M.; Rossow, S.; Rendahl, A.; Gebhart, C.; Marthaler, D. G. Serotype and Genotype (Multilocus Sequence Type) of *Streptococcus suis* Isolates from the United States Serve as Predictors of Pathotype. *J. Clin. Microbiol.* **2019**, *57* (9), e00377-00319.
- (94) Stefan, R.; Olivier, D.; Herma, B.; Hilde, S.; Patrick, B. Isolation of *Streptococcus suis* from a cat with meningoencephalitis. *Vet. Microbiol.* **2009**, *136* (1), 206-207.
- (95) Nhung, N. T.; Yen, N. T. P.; Cuong, N.; Kiet, B. T.; Hien, V. B.; Campbell, J.; Thwaites, G.; Baker, S.; Geskus, R.; Ashton, P.; et al. Carriage of the zoonotic organism *Streptococcus suis* in chicken flocks in Vietnam. *Zoonoses Public Health* **2020**, *67* (8), 843-848.
- (96) Zhang, X.; Wu, Z.; Wang, K. Diagnosis of Streptococcus suis Meningoencephalitis with metagenomic next-generation sequencing of the cerebrospinal fluid: a case report with literature review. *BMC Infect. Dis.* **2020**, *20* (1), 884.
- (97) Feng, Y.; Zhang, H.; Wu, Z.; Wang, S.; Cao, M.; Hu, D.; Wang, C. *Streptococcus suis* infection. *Virulence* **2014**, *5* (4), 477-497.
- (98) Roberts, I. S. The Biochemistry and Genetics of Capsular Polysaccharide Production in Bacteria. *Annu. Rev. Microbiol.* **1996**, *50* (1), 285-315.
- (99) Lecours, M.-P.; Gottschalk, M.; Houde, M.; Lemire, P.; Fittipaldi, N.; Segura, M. Critical Role for *Streptococcus suis* Cell Wall Modifications and Suilysin in Resistance to Complement-Dependent Killing by Dendritic Cells. *J. Infect. Dis.* **2011**, *204* (6), 919-929.
- (100) Uruén, C.; García, C.; Fraile, L.; Tommassen, J.; Arenas, J. How *Streptococcus suis* escapes antibiotic treatments. *Vete. Res.* **2022**, *53* (1), 91.
- (101) Kay, E.; Cuccui, J.; Wren, B. W. Recent advances in the production of recombinant glycoconjugate vaccines. *npj Vaccines* **2019**, *4* (1), 16.

- (102) Corsaut, L.; Martelet, L.; Goyette-Desjardins, G.; Beauchamp, G.; Denicourt, M.; Gottschalk, M.; Segura, M. Immunogenicity study of a *Streptococcus suis* autogenous vaccine in preparturient sows and evaluation of passive maternal immunity in piglets. *BMC Infect. Dis.* **2021**, *17* (1), 72.
- (103) Daan; Nadia, A. G.; Diana, L.; Herman, S. O.; Johannes, H.; Gijsbert, A.; Jeroen, D. C. C. Synthesis of *E. faecium* wall teichoic acid fragments. *Bioorg. Medi. Chem.* **2016**, *24* (17), 3893-3907.
- (104) Behera, A.; Rai, D.; Kulkarni, S. S. Total Syntheses of Conjugation-Ready Trisaccharide Repeating Units of *Pseudomonas aeruginosa* O11 and *Staphylococcus aureus* Type 5 Capsular Polysaccharide for Vaccine Development. *J. Am. Chem. Soc.* **2020**, *142* (1), 456-467.
- (105) Jeanneret, R. A.; Johnson, S. E.; Galan, M. C. Conformationally Constrained Glycosyl Donors as Tools to Control Glycosylation Outcomes. *J. Org. Chem.* **2020**, *85* (24).
- (106) Hagen, B.; van Dijk, J. H. M.; Zhang, Q.; Overkleeft, H. S.; van der Marel, G. A.; Codée, J. D. C. Synthesis of the *Staphylococcus aureus* Strain M Capsular Polysaccharide Repeating Unit. *Org. Lett.* **2017**, *19* (10), 2514-2517.
- (107) Mamoru, M.; Hiroharu, M.; Kohtaro, G.; Keita, H. Synthesis of aminoglycoside derivatives on a Cbz-type heavy fluororous tag. *Tetrahedron Lett.* **2006**, *47* (50), 8831-8835.
- (108) Cheng, J. M. H.; Dangerfield, E. M.; Timmer, M. S. M.; Stocker, B. L. A divergent approach to the synthesis of iGb3 sugar and lipid analogues *via* a lactosyl 2-azido-sphingosine intermediate. *Org. Biomol. Chem.* **2014**, *12* (17), 2729-2736.
- (109) van Mechelen, J.; Voorneveld, J.; Overkleeft, H. S.; Filippov, D. V.; van der Marel, G. A.; Codée, J. D. C. Synthesis of orthogonally protected and functionalized bacillosamines. *Org. Biomol. Chem.* **2020**, *18* (15), 2834-2837.
- (110) Emmadi, M.; Kulkarni, S. S. Synthesis of orthogonally protected bacterial, rare-sugar and D-glycosamine building blocks. *Nat. Protoc.* **2013**, *8* (10), 1870-1889.
- (111) Lloyd, D.; Bylsma, M.; Bright, D. K.; Chen, X.; Bennett, C. S. Mild Method for 2-Naphthylmethyl Ether Protecting Group Removal Using a Combination of 2,3-Dichloro-5,6-dicyano-1,4-benzoquinone (DDQ) and  $\beta$ -Pinene. *J. Org. Chem.* **2017**, *82* (7), 3926-3934.
- (112) Toshiaki, K. S.; Fumiko, M.; Ping, W.; ShinYi, Y.; Chi-Chi, C.; Kay-Hooi, K.; Kazuko, K.; Tomoya, O. A.; Kazuhiro, S.; Naohiro, K.; et al. Identification of Mono- and Disulfated *N*-Acetyl-lactosaminyl Oligosaccharide Structures as Epitopes Specifically Recognized by Humanized Monoclonal Antibody HMOCC-1 Raised against Ovarian Cancer. *J. Biol. Chem.* **2012**, *287* (9), 6592-6602.
- (113) Sankaranarayanan, N. V.; Strebel, T. R.; Boothello, R. S.; Sheerin, K.; Raghuraman, A.; Sallas, F.; Mosier, P. D.; Watermeyer, N. D.; Oscarson, S.; Desai, U. R. A Hexasaccharide

Containing Rare 2-O-Sulfate-Glucuronic Acid Residues Selectively Activates Heparin Cofactor II. *Angew. Chem. Int. Ed.* **2017**, *56*, 2312.

(114) Parameswarappa, S. G.; Reppe, K.; Geissner, A.; Ménová, P.; Govindan, S.; Calow, A. D. J.; Wahlbrink, A.; Weishaupt, M. W.; Monnanda, B. P.; Bell, R. L.; et al. A Semi-synthetic Oligosaccharide Conjugate Vaccine Candidate Confers Protection against *Streptococcus pneumoniae* Serotype 3 Infection. *Cell Chem. Biol.* **2016**, *23* (11), 1407-1416.

(115) Rajesh, M.; Mathias, E.; Afshan, B.; Timmy, F.; Peter, K.; Sofie, N.; Per, H. Impact of N-glycosylation site variants during human PrP aggregation and fibril nucleation. *Biochim. Biophys. Acta Proteins Proteom.* **2019**, *1867* (10), 909-921.

(116) David, R. K.; Stanley, M. R.; Roger, F. N. The Cleavage of t-Butyldimethylsilyl Ethers with Boron Trifluoride Etherate. *Synth. Commun.* **1979**, *9* (4), 295-299.

(117) Satoh, K.; Makimura, K.; Hasumi, Y.; Nishiyama, Y.; Uchida, K.; Yamaguchi, H. *Candida auris* sp. nov., a novel ascomycetous yeast isolated from the external ear canal of an inpatient in a Japanese hospital. *Microbiol. Immunol.* **2009**, *53* (1), 41-44.

(118) Cândido, E. d. S.; Affonseca, F.; Cardoso, M. H.; Franco, O. L. Echinocandins as Biotechnological Tools for Treating *Candida auris* Infections. *J. Fungi* **2020**, *6* (3), 185.

(119) Jeffery-Smith, A.; Taori, S. K.; Schelenz, S.; Jeffery, K.; Johnson, E. M.; Borman, A.; *Candida auris* incident Management Team; Manuel, R.; Brown, C. S. *Candida auris*: a review of the literature. *Clin. microbiol. rev.* **2018**, *31* (1), e00029-00017.

(120) Bachmann, S. P.; VandeWalle, K.; Ramage, G.; Patterson, T. F.; Wickes, B. L.; Graybill, J. R.; López-Ribot, J. L. In vitro activity of caspofungin against *Candida albicans* biofilms. *Antimicrob. Agents Chemother.* **2002**, *46* (11), 3591-3596.

(121) Loh, B. S.; Ang, W. H. "Illuminating" echinocandins' mechanism of action. *ACS Cent. Sci.* **2020**, *6*, 1652-1653.

(122) Yan, L.; Xia, K.; Yu, Y.; Miliakos, A.; Chaturvedi, S.; Zhang, F.; Chen, S.; Chaturvedi, V.; Linhardt, R. J. Unique Cell Surface Mannan of Yeast Pathogen *Candida auris* with Selective Binding to IgG. *ACS Infect. Dis.* **2020**, *6* (5), 1018-1031.

(123) Singh, R. K.; Sianturi, J.; Seeberger, P. H. Synthesis of Oligosaccharides Resembling the *Streptococcus suis* Serotype 18 Capsular Polysaccharide as a Basis for Glycoconjugate Vaccine Development. *Org. Lett.* **2022**, *24* (12), 2371-2375.

(124) Dang, A.-T.; Johnson, M. A.; Bundle, D. R. Synthesis of a *Candida albicans* tetrasaccharide spanning the  $\beta$ -1,2-mannan phosphodiester  $\alpha$ -mannan junction. *Org. & Biomol. Chem.* **2012**, *10* (41), 8348-8360.

- (125) Zhang, S.; Sella, M.; Sianturi, J.; Priegue, P.; Shen, D.; Seeberger, P. H. Discovery of Oligosaccharide Antigens for Semi-Synthetic Glycoconjugate Vaccine Leads against *Streptococcus suis* Serotypes 2, 3, 9 and 14. *Angew. Chem. Int. Ed.* **2021**, *60* (26), 14679-14692.
- (126) Crich, D.; Sun, S. Direct Synthesis of  $\beta$ -Mannopyranosides by the Sulfoxide Method. *J. Org. Chem.* **1997**, *62* (5), 1198-1199.
- (127) Capicciotti, C. J.; Kurach, J. D. R.; Turner, T. R.; Mancini, R. S.; Acker, J. P.; Ben, R. N. Small Molecule Ice Recrystallization Inhibitors Enable Freezing of Human Red Blood Cells with Reduced Glycerol Concentrations. *Sci. Rep.* **2015**, *5* (1), 9692.
- (128) Crawford, C. J.; Qiao, Y.; Liu, Y.; Huang, D.; Yan, W.; Seeberger, P. H.; Oscarson, S.; Chen, S. Defining the Qualities of High-Quality Palladium on Carbon Catalysts for Hydrogenolysis. *Org. Process Res. Dev.* **2021**, *25* (7), 1573-1578.
- (129) Karen, P. Synthesis of the trisaccharide portion of soyasaponin  $\beta$ g: evaluation of a new glucuronic acid acceptor. *Carbohydr. Res.* **2003**, *338* (14), 1441-1454.
- (130) Broecker, F.; Seeberger, P. H. Synthetic glycan microarrays. *Small molecule microarrays: methods and protocols* **2017**, 227-240.
- (131) Bruno, M.; Kersten, S.; Bain, J. M.; Jaeger, M.; Rosati, D.; Kruppa, M. D.; Lowman, D. W.; Rice, P. J.; Graves, B.; Ma, Z.; et al. Transcriptional and functional insights into the host immune response against the emerging fungal pathogen *Candida auris*. *Nat. Microbiol.* **2020**, *5* (12), 1516-1531.