

Voice at the interfaces

The syntax, semantics, and
morphology of the Hebrew verb

Itamar Kastner

Open Generative Syntax 8



Open Generative Syntax

Editors: Elena Anagnostopoulou, Mark Baker, Roberta D'Alessandro, David Pesetsky, Susi Wurmbrand

In this series:

1. Bailey, Laura R. & Michelle Sheehan (eds.). Order and structure in syntax I: Word order and syntactic structure.
2. Sheehan, Michelle & Laura R. Bailey (eds.). Order and structure in syntax II: Subjecthood and argument structure.
3. Bacskai-Atkari, Julia. Deletion phenomena in comparative constructions: English comparatives in a cross-linguistic perspective.
4. Franco, Ludovico, Mihaela Marchis Moreno & Matthew Reeve (eds.). Agreement, case and locality in the nominal and verbal domains.
5. Bross, Fabian. The clausal syntax of German Sign Language: A cartographic approach.
6. Smith, Peter W., Johannes Mursell & Katharina Hartmann (eds.). Agree to Agree: Agreement in the Minimalist Programme.
7. Pineda, Anna & Jaume Mateu (eds.). Dative constructions in Romance and beyond.
8. Kastner, Itamar. Voice at the interfaces: The syntax, semantics, and morphology of the Hebrew verb.

Voice at the interfaces

The syntax, semantics, and
morphology of the Hebrew verb

Itamar Kastner



Kastner, Itamar. 2020. *Voice at the interfaces: The syntax, semantics, and morphology of the Hebrew verb* (Open Generative Syntax 8). Berlin: Language Science Press.

This title can be downloaded at:

<http://langsci-press.org/catalog/book/271>

© 2020, Itamar Kastner

Published under the Creative Commons Attribution 4.0 Licence (CC BY 4.0):

<http://creativecommons.org/licenses/by/4.0/> 

ISBN: 978-3-96110-257-0 (Digital)

978-3-96110-258-7 (Hardcover)

ISSN: 2568-7336

DOI: 10.5281/zenodo.3865067

Source code available from www.github.com/langsci/271

Collaborative reading: paperhive.org/documents/remote?type=langsci&id=271

Cover and concept of design: Ulrike Harbort

Typesetting: Itamar Kastner, Felix Kopecky

Proofreading: Andreas Hölzl, Amir Ghorbanpour, Bev Erasmus, Brett Reynolds,

Carla Bombi, Elizabeth Bogal-Allbritten, Eran Asoulin, Esther Yap, Ivica Jeđud,

Jeroen van de Weijer, Lachlan Mackenzie, Lynell Zogbo, Tom Bossuyt, Alena

Witzlack-Makarevich, Waldfried Premper

Fonts: Libertinus, Arimo, DejaVu Sans Mono

Typesetting software: X_YLA_TE_X

Language Science Press

Xhain

Grünberger Str. 16

10243 Berlin, Germany

langsci-press.org

Storage and cataloguing done by FU Berlin

Freie Universität  Berlin

In remembrance of Asi, Edit, Greg, Irit and Maskit,
who showed kindness.

Contents

Acknowledgments	vii
Abbreviations	ix
1 The valence of Voice	1
1.1 Identifying the puzzles	1
1.1.1 The two problems of Semitic morphology	2
1.1.2 Argument structure	3
1.1.3 Solving the two problems	5
1.2 Traditional descriptions and basic generalizations	6
1.2.1 Hebrew morphology for beginners	6
1.2.2 Traditional generative treatments of the system	9
1.2.3 Data and notation	11
1.3 Architectural assumptions	13
1.3.1 The syntax	13
1.3.1.1 What is Voice?	14
1.3.1.2 Layering	16
1.3.2 Interfaces	17
1.3.2.1 Roots	18
1.3.2.2 Contextual allomorphy	19
1.3.2.3 Contextual allosemy	21
1.4 Sketch of the system	22
1.4.1 Simple alternations	22
1.4.2 Beyond simple alternations	25
1.4.3 From templates to functional heads	27
I Hebrew argument structure	31
2 Unspecified Voice	33
2.1 Overview	33
2.2 <i>XaYaZ</i> : Descriptive generalizations	33
2.2.1 Active verbs	33

Contents

2.2.2	Non-active verbs	34
2.2.2.1	Adverbial modifiers	34
2.2.2.2	Unaccusativity diagnostics	35
2.2.2.3	Non-active recap and unaccusativity tests	39
2.2.3	Summary	40
2.3	Unspecified Voice	40
2.3.1	Syntax	41
2.3.2	Semantics	44
2.3.3	Phonology	45
2.3.4	Interim summary	48
2.4	<i>XiYeZ</i> : Descriptive generalizations	49
2.4.1	Agentive modifiers crosslinguistically	51
2.4.1.1	Agentivity \neq animacy	51
2.4.1.2	Agentivity in nominalizations	53
2.4.1.3	Agentive morphemes	54
2.5	Agentive modification: $\sqrt{\text{ACTION}}$	55
2.5.1	Syntax	56
2.5.1.1	Height of attachment	58
2.5.2	Semantics	60
2.5.2.1	Pluractionality	61
2.5.2.2	Underived forms	62
2.5.3	Phonology	63
2.6	Summary and outlook	64
3	Voice_[-D]	67
3.1	Introduction	67
3.2	<i>niXYaZ</i> : Descriptive generalizations	69
3.2.1	Non-active verbs	69
3.2.1.1	Adverbial modifiers	71
3.2.1.2	Unaccusativity diagnostics	72
3.2.2	Figure reflexives	73
3.2.2.1	Adverbial modifiers	74
3.2.2.2	Unaccusativity diagnostics	74
3.2.2.3	Indirect objects	75
3.2.3	Interim summary: <i>niXYaZ</i>	76
3.3	Voice _[-D]	78
3.3.1	Syntax	79

3.3.2	Semantics	80
3.3.2.1	Null allosemy in inchoatives	81
3.3.2.1.1	No licensing of Voice	81
3.3.2.1.2	Weakening the Arad/Marantz hypothesis	82
3.3.2.2	Null allosemy crosslinguistically	83
3.3.3	Phonology	85
3.4	$p_{[-D]}$	87
3.4.1	Syntax and semantics	87
3.4.1.1	Ordinary prepositions	87
3.4.1.2	Figure reflexives	88
3.4.2	Phonology	92
3.5	Interlude: From $niXYaZ$ to $hitXaYeZ$	95
3.6	$hitXaYeZ$: Descriptive generalizations	96
3.6.1	Non-active verbs	96
3.6.2	Figure reflexives	99
3.6.3	Reflexives	100
3.7	Adding $\sqrt{\text{ACTION}}$ to $[-D]$	104
3.7.1	$\sqrt{\text{ACTION}}$ + $\text{Voice}_{[-D]}$	104
3.7.1.1	Non-active verbs	104
3.7.1.2	Reflexives	107
3.7.2	$\sqrt{\text{ACTION}}$ + $p_{[-D]}$	111
3.8	Summary of generalizations and claims	113
3.9	Discussion and outlook	114
3.9.1	Distributed morphosemantics (Doron 2003)	116
3.9.1.1	The three-way alternation	116
3.9.1.2	Additional issues	117
3.9.2	Templates as morphemic elements	118
3.9.2.1	The three-way alternation	118
3.9.2.2	Additional issues	120
3.9.3	Conclusion	120
4	$\text{Voice}_{[+D]}$	123
4.1	Introduction	123
4.2	$heXYiZ$: Descriptive generalizations	124
4.2.1	Causative verbs	124
4.2.2	The labile alternation	127
4.2.2.1	The pattern	127
4.2.2.2	Inchoatives as degree achievements	129

Contents

4.2.3	Summary	131
4.3	Voice _[+D] : An active Voice head	132
4.3.1	Syntax and semantics	132
4.3.1.1	Inchoatives: Structure	133
4.3.1.2	Inchoatives: Derivation	136
4.3.2	Phonology	138
4.4	Causation and alternation	139
4.4.1	Markedness in causation	139
4.4.1.1	Basic and marked alternations	140
4.4.1.2	Markedness in Voice heads	146
4.4.2	Productivity	148
4.4.3	The labile alternation	150
4.4.4	Generalizing to Pred/ <i>t</i> *	151
4.5	Alternative accounts	153
4.5.1	Where do alternations live?	153
4.5.2	Added structure	155
4.5.3	CAUS and existential closure	156
4.5.4	Contextual allomorphy	157
4.5.5	Verbalizing affix	158
4.6	Conclusion	162
5	Passives and nominalizations	165
5.1	Passivization	166
5.1.1	Background	166
5.1.2	Descriptive generalizations	168
5.1.3	The head Pass in Hebrew	171
5.2	Adjectival passives	173
5.2.1	Background	173
5.2.2	Descriptive generalizations	175
5.2.3	The adjectivizer <i>a</i> in Hebrew	179
5.2.3.1	Stative adjectives	179
5.2.3.2	Adjectival passives	180
5.2.3.3	Templates	183
5.2.3.3.1	<i>XaYaZ</i> (adjectival form <i>XaYuZ</i>)	184
5.2.3.3.2	<i>XiYeZ</i> (adjectival form <i>meXuYaZ</i>)	185
5.2.3.3.3	<i>heXYiZ</i> (adjectival form <i>muXYaZ</i>)	186
5.2.4	Summary of adjectival passives	186
5.3	Nominalization	188
5.3.1	Background	188

5.3.2	Descriptive generalizations	190
5.3.3	The head <i>n</i> in Hebrew	190
5.4	Conclusion	193
 II Crosslinguistic consequences		197
6	Syntactic vs. semantic transitivity	199
6.1	Introduction	199
6.2	Layering	199
6.2.1	Causative core	200
6.2.2	The transitivity of Voice	201
6.3	Comparison	203
6.3.1	Non-active layers	204
6.3.2	The trivalency of transitivity	204
6.4	Hebrew with Layering	208
6.5	An alternative with Impoverishment	211
6.5.1	An Impoverished Layering Theory of Hebrew	211
6.5.1.1	Basics	211
6.5.1.2	Appl	213
6.5.1.3	Additional diacritic	213
6.5.2	Discussion	214
6.6	Conclusion	215
7	The features of Voice	217
7.1	Summary of the Trivalent approach	217
7.1.1	Summary of generalizations	218
7.1.2	D-composing the templates	220
7.2	Voice heads	222
7.2.1	Japanese	223
7.2.2	<i>i</i> *	225
7.2.3	Trivalent Voice/ <i>i</i> * crosslinguistically	226
7.3	Features on Voice	228
7.3.1	Layering	229
7.3.2	Restriction	230
7.3.3	Restructuring	231
7.3.4	Valuation	232
7.3.5	Towards a uniform inventory	233

Contents

7.4	Conclusion	234
7.4.1	Open questions	234
7.4.2	Epilogue: From templates to heads	236
	References	237
	Index	259
	Name index	259
	Language index	263
	Subject index	265

Acknowledgments

In a recent post on his lab's website, my former advisor Alec Marantz wrote:

However, one shouldn't forget that I wrote a very long dissertation turned book in the early 1980's that concerned the relationship between word formation and syntax. The work is titled, "On the Nature of Grammatical Relations," because it is, in a sense, a paean to Relational Grammar.

The dissertation-turned-book you are now reading is, in a sense, a paean to Edit Doron and Maya Arad. It is the culmination of a project which first properly started with my 2016 dissertation at NYU, so I have my dissertation committee to thank for their guidance first and foremost: Alec, Maria Gouskova, Stephanie Harves, Michael Becker and the late Edit. Edit's work in particular influenced the way I have approached the intricacies of the Hebrew verbal system, and I was looking forward to many more years of discussing it with her.

Most of this book was written while I was a post-doc at Artemis Alexiadou's *Research Unit on (Experimental) Syntax and Heritage Languages* at the Humboldt-Universität zu Berlin (funded by her well deserved Gottfried Wilhelm Leibniz-Preis AL 554/8-1 from the DFG). I am indebted to Artemis for establishing the ideal working environment where these ideas could be developed, and for providing a place where I could engage her and my colleagues Odelia Ahdout, Fabienne Martin, Florian Schäfer and Giorgos Spathas in many informal conversations. Odelia in particular helped sharpen many specific aspects of the analysis and corrected some of the empirical claims. I also thank the local PhD students, post-docs and research assistants for the friendly atmosphere and useful discussions.

Quite a few people helped get the book itself over the finish line. At Language Science Press, I am grateful to Susi Wurmbrand for her support of the project, Elena Anagnostopoulou for her work as handling editor, and an anonymous reviewer for highly constructive comments. On the production side, the proofreaders deserve a special word of thanks for volunteering their time, Felix Kopecky fixed more problems than I realized I'd caused, and Sebastian Nordhoff made sure the whole operation ran remarkably smoothly. My thanks also to Yifei Hu

Acknowledgments

at the University of Edinburgh for editorial assistance preparing the manuscript for production.

The research in this book led to a number of individual papers, some co-authored, and all owing a debt to feedback from different people at different stages. Thanks to Odelia Ahdout, Matthew Tucker and Vera Zu for joint work which has ended up in this book in one way or another. Earlier parts of this work have appeared in *Glossa*, *Morphology*, *Natural Language & Linguistic Theory* and *The Linguistic Review*; I thank the reviewers and editors there for their work. Thanks especially to participants at the *Parameters Workshop in Honour of Lisa Travis* for providing the impetus to get this thing done.

I was very lucky to benefit from written comments on previous versions of the manuscript. Thanks to Yining Nie for insightful comments on a previous draft; and to Jim Wood and the students in his 2019 Yale seminar on Argument Structure and Morphology for their comments, including important discussion of alternative analyses.

For some suggestions that didn't make it in, thanks to Daniel Harbour for suggesting the titles "The Valence of Voice" and "Hebrew D-Voicing" and to Dylan Bumford for suggesting the title "Modern Morphophonemics of Hebrew". Thanks also to Tricia Irwin, Neil Myler, James Whang and Vera Zu (just because).

This book also symbolizes for me the end of three and a half wonderful years in Berlin. Apart from everyone above who made our time there so enjoyable, my warmest thanks to our adoptive families: Olia & Luca, and Florian & Fabienne.

Finally, thanks to A. and T. for struggling with Hebrew morphology in their own way.

Edinburgh, February 2020

Abbreviations

CAUS	“Causative” template <i>heXYiZ</i>
INTNS	“Intensive” templates <i>XiYeZ</i> and <i>hitXaYeZ</i>
MID	“Middle” templates <i>niXYaZ</i> and <i>hitXaYeZ</i>
SMPL	“Simple” template <i>XaYaZ</i>

1 The valence of Voice

The aim of this book is to present a new theory of argument structure alternations, one which is anchored in the syntax but has systematic interfaces with the phonology and the semantics. Conceptually, my goal is to argue for a specific formal system. Empirically, my goal is to provide the most comprehensive description and analysis of Hebrew verbal morphology to date, one whose formal assumptions are as similar as possible to those made in work on non-Semitic languages. Let's first see why Hebrew is interesting (Section 1.1) and then why it continues to challenge existing accounts (Section 1.2), before outlining the current proposal, Trivalent Voice (Sections 1.3–1.4).

1.1 Identifying the puzzles

In the verbal system of Modern Hebrew, verbs appear in one of seven morphological TEMPLATES. These templates, listed in (1), are the main object of study in this book. I will go into exact notational matters and how to understand these forms momentarily; for now, all that matters is that the ROOT CONSONANTS can be substituted for the placeholders X, Y and Z. Templates are traditionally given in the citation form: third person, masculine singular, past tense.

- (1) a. *XaYaZ*
b. *niXYaZ*
c. *XiYeZ*
d. *hitXaYeZ*
e. *heXYiZ*
f. *XuYaZ*
g. *huXYaZ*

The most important thing to know about the templates is that they are easy to identify based on morphophonological form (although I provide glosses just in case), and that they *often* carry *some kind* of meaning. Pinning down the essence of “often” and “some kind” is my main analytical task.

1.1.1 The two problems of Semitic morphology

Because our theoretical interest is in argument structure alternations, we can start there. The following examples demonstrate three different verbs, all sharing the same root which I notate \sqrt{ktb} . In general, it can be seen that all verbs have to do with writing in some sense. The first is a simple transitive in the template *XaYaZ*:

- (2) Transitive *XaYaZ*
ha-talimidim *katv-u* et ha-nosim.
the-students wrote-PL ACC the-topics
'The students wrote the topics down.'

The second is a non-active variant in *niXYaZ*, (3); this is how we would express the anticausative or passive version of (2).

- (3) Non-active (mediopassive) *niXYaZ*
ha-xiburim *nixtev-u* (al-jedej ha-talimidim).
the-essays were.written-PL by the-students
'The essays were written (by the students).'

The third is a causative version in *heXYiZ*, (4).

- (4) Causative *heXYiZ*
ha-mora *hextiv-a* (la-talimidim) et rejimat ha-nosim.
the-teacher dictated-3SG.F to.the-students ACC list.of the-topics
'The teacher dictated the list of topics (to the students).'

If this is what the language looked like, the system would be far less puzzling. The analytical issues begin to mount when we understand that verbs in *XaYaZ* are not always transitive like in (2). Verbs in *niXYaZ* are not always non-active like those in (3). And verbs in *heXYiZ* are not always causative like those in (4); counterexamples are given in (5).

- (5) a. Unaccusative in *XaYaZ*:
ha-bakbuk *kafa* ba-makpi.
the-bottle froze in.the-freezer
'The bottle froze in the freezer.'
- b. Unergative in *niXYaZ*:
josi *nixnas* la-xeder be-bitaxon.
Yossi entered to.the-room in-security
'Yossi confidently entered the room.'

- c. Unergative in *heXYiZ*:
 marsel *heezin* be-savlanut.
 Marcel listened in-patience
 ‘Marcel listened patiently.’

Be that as it may, it is crucial that there is also some method to the madness. It is not the case that any template can be associated with any syntactic or semantic construction. Certain configurations – unaccusative, transitive, reflexive, etc. – are only possible with certain templates. This is *the first problem* of Semitic morphology: what syntactic structures and semantic readings is a given template associated with, and why?

Additionally, sometimes we can find alternations like in (2–4). Certain templates alternate with some but not with others. *The second problem* of Semitic morphology is thus: what templates does a given template alternate with, and why?

Granted, there is also a third problem: how can we tell which meaning is licensed by which root? That question deserves a monograph of its own, though I will try to flag ways in which it can be approached throughout the book.

I believe the answers to these questions can be found once we abandon the notion of a “template” as some kind of morphological primitive. I propose here a decomposition of the template into functional heads in the syntax, one that is able to address both problems above. What this means is that we need to engage with what alternations are and how argument structure comes about.

1.1.2 Argument structure

Contemporary theories of argument structure often take as a starting point the “anticausative alternation”, whereby a transitive verb (CAUSATIVE) and its intransitive equivalent (ANTICAUSATIVE) stand in some morphologically mediated relationship. In some languages, such as English in (6), the two verbs do not differ in their morphological marking. In other languages the predominant situation is one in which a reflexive pronoun appears in the anticausative variant, as in German, (7). And in other languages, the anticausative variant has specific non-active morphological marking. Some verbs in Greek are like this, (8). Other languages fall into one or more of these typological categories.

- (6) a. Meg *opened* the door. (causative)
 b. The door *opened*. (anticausative)

1 *The valence of Voice*

(7) German

- a. Florian öffnete die Tür. (causative)
Florian opened the door
'Florian opened the door.'
- b. Die Tür öffnete sich. (anticausative)
the door opened REFL
'The door opened.'

(8) Greek

- a. o Giorgos ekapse ti supa. (causative)
the Giorgos burned the soup
'Giorgos burned the soup.'
- b. i supa kaike. (anticausative)
the soup burned.NACT
'The soup burned.'

In other languages a "causative alternation" can be observed, where the causative variant is marked. The Japanese pair in (9) exemplifies (transcription and glosses as in Oseki 2017: 3).

(9) Japanese

- a. John-ga ringo-o koor-as-ta. (causative)
John-NOM apple-ACC freeze-CAUS-PAST
'John froze an apple.'
- b. Ringo-ga koor-ta. (anticausative)
apple-NOM freeze-PAST
'An apple became frozen.'

Various syntactic and semantic questions arise in connection with these seemingly simple patterns, many of which have been explored in influential studies such as Haspelmath (1993), Levin & Rappaport Hovav (1995), Schäfer (2008), Koontz-Garboden (2009) and Alexiadou et al. (2015): what kind of morphological marking appears on the different variants? Is there a sense in which one is derived from the other, or do the two share a common base? Which predicates are marked as causative or anticausative crosslinguistically?

The degree of variation both within and across languages is substantial. However, most studies on argument structure have analyzed this aspect of the syntax-semantics interface through the lens of languages with relatively simple concate-

native morphology. Each of these languages has contributed much to our understanding of argument structure, to be sure: the English labile alternation shines light on which predicates are likely to be marked in which way (Haspelmath 1993; Levin & Rappaport Hovav 1995; Koontz-Garboden 2009); the French, German and Spanish alternations bring in many aspects of cliticization, binding and agreement (Labelle 2008; Schäfer 2008; Cuervo 2014); the Greek alternation shows consistent morphological marking for at least one class of predicates (Alexiadou & Doron 2012; Alexiadou et al. 2015); and more recent work on Icelandic has further identified ways in which argument structure alternations can be correlated with morphological processes (Wood 2014; 2015; 2016). Yet this line of work has the drawback that these languages usually show only binary morphological distinctions, if any: either the causative variant is marked, or the anticausative one is marked (or neither is, as in the labile alternation). Three-way marking is a challenge which persists with some larger-scale typological surveys as well (Haspelmath 1993; Arad 2005).

1.1.3 Solving the two problems

The intuition guiding my analysis is that of Schäfer (2008), Alexiadou et al. (2015) and related work: the alternations are not alternations at all. The grammar does not derive causative forms from inchoative ones, or anticausative forms from transitive ones. Rather, what happens is that both readings are derived from one core structure (technically a vP) with a causative component in the semantics. If we add an external argument, we get a transitive/causative verb; if we do not, we simply retain the basic event and have an anticausative verb on our hands.

This book provides a way of implementing the same idea in Hebrew. Now, I am by no means the first to suggest that the templates be decomposed. Maya Arad and Edit Doron have both made seminal contributions to our understanding of these issues. But Arad (2005) was torn between the need to acknowledge the idiosyncrasies of the system, on the one hand, and the need to encode the alternations, on the other hand. As a result, that theory had to implement conjugation classes in order to adequately describe which alternations exist. Doron (2003) sidestepped the issue by providing a compositional semantics for the components making up the templates, but the result was that alternations could only be discussed in terms of their semantics, and not their morphology or syntax. What I propose is a way to get the alternations from contemporary syntactic assumptions.

The two problems are addressed as follows. By building up specific syntactic structures we are able to easily explain what syntactic configurations and se-

mantic interpretations arise for a given structure, as well as how this structure is spelled out; that spell-out is what we call the template. Instead of figuring out the many-to-many mapping between form and meaning, I map one structure deterministically to form and to meaning, thereby solving the first problem. And by adopting the idea that a core vP carries the basic meaning of a verb, we can then layer additional heads above it, regulating the introduction of an external argument. The majority of work is carried out by the head Voice, which introduces the external argument. This solves the second problem. A technical innovation lies with the syntactic feature [\pm D] that Voice might carry, hence the valence of Voice. But we will get to that soon enough.

Part I of this book is comprised of case studies of the different templates, which together come to form the Theory of Trivalent Voice. Part II consists of two chapters situating this theory within contemporary theoretical debates.

The rest of this introductory chapter is structured as follows. I give a general overview of Hebrew morphology in Section 1.2, including a brief account of what the traditional view is. Section 1.3 introduces the formal assumptions of my theory, which itself is outlined in Section 1.4.

1.2 Traditional descriptions and basic generalizations

1.2.1 Hebrew morphology for beginners

The first thing to note about Hebrew is that not *all* morphology is non-concatenative. Agreement, for example, may consist of prefixes and suffixes, alongside non-concatenative changes to the stem. The future tense paradigm for the verb *katav* ‘wrote’ in *XaYaZ* is given in Table 1.1. The stem vowel is either /o/ or /e/, depending on whether the verb is suffixed or not, but other than that all of the agreement information is affixal.

Table 1.1: Concatenative affixation in Hebrew verbs

Person/Gender	SG	PL
1	e -xtov	ni -xtov
2M	ti -xtov	ti -xtev- u
2F	ti -xtev- i	ti -xtev- u
3M	ji -xtov	ji -xtev- u
3F	ti -xtov	ji -xtev- u

1.2 Traditional descriptions and basic generalizations

I do not concern myself here with this distinction directly since my main interest is within the thematic domain, i.e. VoiceP. In general, it is not surprising that syntactic material from a certain height and “upwards” in the tree is spelled out affixally rather than non-concatenatively; see Harbour (2008) and Kastner & Tucker (submitted) for further discussion of this cross-Semitic point.

Nevertheless, linguists and non-specialists alike often find themselves scratching their heads in an attempt to come to terms with the distinctive morphological system of Semitic languages, built around “roots” and “patterns”. Many early speakers of Modern Hebrew were such head-scratchers themselves: the language was revived in the late 19th century by individuals who, for the most part, were not native speakers of Semitic languages. The language nevertheless retained the Semitic morphology of its classical predecessor. Given that this book is a study of the verbal system of Hebrew, I will make repeated reference to *ROOTS* and *TEMPLATES* (the latter also called “patterns”, “measures”, “forms” and *binyanim*) as the two main components of the verb. I reserve the terms *TEMPLATES* for the seven systematic verbal forms and *PATTERNS* for the nominal and adjectival forms. These traditional terms have been used, as far as I know, for as long as the verbal systems of Hebrew and other Semitic languages have been documented. Ussishkin (2000) mentions a number of works on Hebrew which use roots and templates as integral parts of the system, including Gesenius (1813/1919) – perhaps the best-regarded grammar of Biblical Hebrew – as well as Bopp (1826), Ewald (1827), Harris (1941) and Chomsky (1951). For Arabic, he mentions de Sacy (1810) as one example among many of older works which make direct reference to roots and templates.

According to Borer (2013: 563fn), who herself cites Owens (1988), the nature of the root was already debated by the traditional Arabic grammarians of Basra and Kufa in the 8th Century. Turning to more recent works, we can add foundational contributions by Rosén (1977), Berman (1978), Bolozky (1978; 1999) and Ravid (1990), all relying on the root and the template as descriptive notions. I cannot hope to do justice here to the vast modern-day literature on Hebrew, much of which has been published in Hebrew. The interested reader may want to consult the works of Yehoshua Blau, Reuven Mirkin, Uzzi Ornan and Haim Rosén, among others.

To see how the system is traditionally conceived of, let us consider first form, then meaning. The verbs in (5) were all given in the 3rd person masculine singular past tense – the citation form. The actual conjugation of a given form across tenses and person/number/gender features is completely predictable, as Table 1.2 exemplifies for the *XiYeZ* template (barring certain lexical idiosyncrasies investigated in Kastner 2019b). That is to say, even though the meaning of a given verb

1 The valence of Voice

cannot be immediately guessed in its entirety, the morphophonological form is predictable. Note again how agreement material is mostly affixal.

Table 1.2: Tense and agreement marking in *XiYeZ*

	Past		Present		Future	
	M	F	M	F	M	F
1SG	XiYaZ-ti		me-XaYeZ		je-XaYeZ	
1PL	XiYaZ-nu		me-XaYZ-im		ne-XaYeZ	
2SG	XiYaZ-ta	XiYaZ-t	me-XaYeZ		te-XaYeZ	
2PL	XiYaZ-tem		me-XaYZ-im		te-XaYZ-u	
3SG	XiYeZ	XiYZ-a	me-XaYeZ		je-XaYeZ	
3PL	XiYZ-u		me-XaYZ-im		je-XaYZ-u	

For meaning, we may take as a starting point the essay by Schwarzwald (1981b) and the traditional classification of the seven templates in Table 1.3.¹

Table 1.3: A naïve classification of Hebrew templates (Schwarzwald 1981b: 131)

	Active	Passive				
Simple	<i>XaYaZ</i>	<i>niXYaZ</i>	$\sqrt{\text{sgr}}$	<i>sagar</i>	<i>nisgar</i>	‘closed’
Intensive	<i>XiYeZ</i>	<i>XuYaZ</i>	$\sqrt{\text{tpl}}$	<i>tipel</i>	<i>tupal</i>	‘treated’
Causative	<i>heXYiZ</i>	<i>huXYaZ</i>	$\sqrt{\text{kns}}$	<i>hexnis</i>	<i>huxnas</i>	‘inserted’
Reflexive/recip.	<i>hitXaYeZ</i>		$\sqrt{\text{xbk}}$	<i>hitxabek</i>		‘hugged’

As Schwarzwald immediately points out herself, this classification is misleading. The relationships between the templates (the argument structure alternations) are not always predictable and most templates have additional meanings beyond those listed in Table 1.3. For example, there is little way to predict what the root $\sqrt{\text{rfm}}$, which has to do with writing down, will mean when it is instantiated in a given template. In the SIMPLE template *XaYaZ* we substitute the consonants in $\sqrt{\text{rfm}}$ for X, Y and Z and derive *rafam* ‘wrote down’. In the MIDDLE template *niXYaZ*, *nirfam le-* means ‘signed up for’, against the characterization of *niXYaZ* as “simple passive” in Table 1.3. In the INTENSIVE MIDDLE *hitXaYeZ*,

¹Seven is the canonical number, but cf. Schwarzwald (2016) for reasons to posit novel templates.

hitrafem me- means ‘was impressed by’, challenging the characterization of *hit-XaYeZ* as “reflexive or reciprocal” in Table 1.3.

The only cells of the table which are completely predictable are the two passive templates *XuYaZ* (INTENSIVE PASSIVE) and *huXYaZ* (CAUSATIVE PASSIVE). The other templates constrain the possible meaning in ways that have eluded precise specification. This returns us to the two basic questions that need to be addressed, mentioned at the outset:

- What are the possible readings associated with a given template (and why)?
- What templates does a given template alternate with (and why)?

In Part I of the book we will see that the syntax and semantics of the system can nevertheless be analyzed within a constrained theory of morphosyntax. I will make precise what the unique contribution of each template is and how that contribution comes about in the syntax. We will then be able to identify the role of the root in selecting between different possible meanings for the verb in a given template.

1.2.2 Traditional generative treatments of the system

Before we get to the meat of the book, I would like to acknowledge some of the earlier generative work on Semitic morphology. This will also help set the stage for direct comparison with alternative accounts later on. My aim is not to provide a history of ideas; for that see Kastner & Tucker (submitted).

In a groundbreaking series of works, John McCarthy presented a purely phonological account of Semitic morphology, focusing on Arabic (McCarthy 1979; 1981; 1989; McCarthy & Prince 1990). His original contribution lay in dividing the Semitic verb into three “planes” or “tiers”: the CV skeleton (consonant and vowel slots), the root (consonants) and the melody (individual vowels). By including the vocalism on a separate tier, McCarthy’s theory allowed vowels to be manipulated independently of the roots or the skeleton. The beauty of this theory is that it allowed for a separation of three morphological elements on three phonological tiers: the root (identity of the consonants), the template (the form of the CV skeleton) and additional inflectional or derivational information (the identity of the vowels).

The current work shifts the focus to the nature of the CV skeleton and the melody. McCarthy’s approach did not attempt to model the relationships between the semantics of the different templates – the alternations in argument

structure. Taking these relationships into account requires a slight change in perspective. Like McCarthy (1981), I believe that the consonantal root lies at the core of the lexicon. Unlike in that theory, I do not postulate independent CV skeletons and do not accord the prosody morphemic status as such. The skeletons will be a by-product of how functional heads are pronounced and regulated by the general phonology of the language. There is no skeleton CVCVCCVC (in Arabic) giving *takattab* ‘got written’, for example (McCarthy 1981: 392): there would be a prefix *ta-*, a number of vowels spelling out Voice, gemination spelling out an additional head, and the organization of these different segments will proceed in a way that satisfies the phonology without making reference to prosodic primitives like skeletons. Furthermore, each morpheme will have an explicit syntax and semantics associated with it.

A few more pieces of research that capture generalizations important to this book deserve mention. The seminal work by Berman (1978) underscored the semi-predictable nature of the templates. Berman (1978: Ch. 3), in particular, made the point that the combination of root and template is neither fully regular nor completely idiosyncratic. Instead, she proposed a principle of “lexical redundancy” to regulate the system. According to this theory, each root has a “basic form” in some template from which other forms are derived. Yet this theory did not formalize the relations between the templates, arbitrarily selecting one as the “basic form” and the others as derived from it, for each root. Nevertheless, Berman’s clear description of the regularities and irregularities in the morphology of Hebrew laid the groundwork for later works such as Doron (2003), Arad (2005), Borer (2013) and the current contribution.

Alongside work that analyzed the syntactic and semantic features of roots and templates, other researchers have focused on the morphophonological properties of the system. The research program developed in a series of works by Bat-El (1989; 1994) and Ussishkin (1999; 2000; 2005) – credited by Ussishkin (2000) at least in part to Horvath (1981) – denies the existence of the root as an independent morpheme. Instead, all verbs are derived via phonological manipulation of surface forms from each other, rather than from an underlying root. The syntactic-semantic aspects of this view were developed by Reinhart & Siloni (2005) and Laks (2011; 2013; 2014; 2018). I refer to this idea as the “stem-based approach” and critique it briefly when relevant; if there is no consistent way of thinking about templates as morphosyntactic primitives then this view has few legs to stand on. See Kastner (2017; 2019b) for more pointed objections, and Kastner & Tucker (submitted) for a broader perspective.

Even before the stem-based approach took form, other Semitists explored the idea of a Semitic system which diverged from the traditional descriptions.

Schwarzwald (1973) doubted the productivity of both the root and the templates, making an early argument for frequency effects in the interpretation of different templates. On that view, it is only the high frequency verbs of the language that show reliable alternations between templates. These verbs lead us as analysts to postulate relationships between templates, though when one looks at less frequent verbs, transparent alternations are less likely to hold. Unlike the stem-based hypothesis, which eschewed roots and relied on the template as a morphological primitive, the proposal in Schwarzwald (1973) kept the root but relegated the template to morphophonological limbo: salient in the grammar but not operative in the syntax. While this early formulation of a template-less idea is intriguing, it cannot be maintained in the face of *wug* studies in which speakers generate argument structure alternations between templates using nonce words (Berman 1993; Moore-Cantwell 2013).

A special place in the literature has been carved out by Doron (2003; 2015) and Arad (2003; 2005). I have already mentioned some features of these theories and we will return to them in more depth as the discussion proceeds.

Finally, to pick out a few studies on Arabic (as gleaned from the helpful overview in Ussishkin 2000), Darden (1992) offered an analysis of Egyptian Arabic that attempted to do without verbal templates; McOmber (1995) developed an infixation-based system similar to that of McCarthy (1981) which makes crucial reference to morpheme edges; and Ratcliffe (1997; 1998) attempted to improve on McCarthy & Prince (1990) by restricting the CV skeleton and treating more phenomena as cases of infixation. But let us return to the current study.

1.2.3 Data and notation

I use the variables X, Y and Z for the tri-consonantal root: \sqrt{XYZ} . This book contains little discussion of roots with more than three consonants, but nothing in the notation hinges on it. Ehrenfeld (2012) curated a database of verbal forms in Hebrew notated for root and template; examining the roots in this database reveals 311 quadrilateral roots and three quintilateral roots² out of 1,876 roots in total. I have adapted this database for my own use and refer to it throughout the book. Ahdout (in prep) has further annotated parts of this database with additional information related to argument structure; some of her findings are referenced in the book as well. Other data, in particular examples and judgments of productivity, rely on my own intuitions, published work and online resources.

As will be discussed in Section 2.4, Hebrew has a fairly productive process of postvocalic spirantization applying to /b/, /k/ and /p/, turning them into [v],

² \sqrt{xntrf} ‘bullshit’, \sqrt{snxrn} ‘synchronize’ and \sqrt{flrtt} ‘flirt’.

1 The valence of Voice

[x] and [f] respectively. This process is blocked in certain verbal templates; to note this blocking I borrow the non-syllabicity diacritic and place it under the medial root consonant: $\underset{\cdot}{Y}$. This notation can be found in the templates $Xi\underset{\cdot}{Y}eZ$ and $hitXa\underset{\cdot}{Y}eZ$, in which this blocking holds. The same notation is used for segments which never spirantize: $\underset{\cdot}{k}$.

Transcriptions are given using the International Phonetic Alphabet with the following modifications:

- “e” stands for /ε/ and /ə/.
- “g” stands for /g/.
- “o” stands for /ɔ/.
- “r” stands for /ʀ/.
- “x” stands for /χ/.
- The apostrophe ’ stands for the glottal stop.

These changes were made purely for reasons of convenience. The syntactic literature has often used “š” or “S” for /ʃ/ and “c” for /ts/. In both cases I preferred to retain the IPA transcription, “ʃ” and “ts”. Stress is marked with an acute accent when necessary, “á”. Deleted vowels are enclosed in angle brackets, “⟨⟩”.

My notation also contains various deviations from standard forms; these will probably only be of interest to readers already familiar with the language.

The template $heXYiZ$ usually appears in the literature as $hiXYiZ$, with an /i-/ /i/ vocalic pattern. Yet contemporary speakers use /ε/ (Trachtman 2016), and so I transcribe “e” throughout. Conversely, the initial /h/ is usually dropped in speech but I retain it for two reasons. First, /h/ is still pronounced by some older speakers and certain sociolinguistic groups, often marginalized ones (cf. Schwarzwald 1981a; Gafter 2014a). And second, the initial *h*- should help non-Semitist readers to distinguish this template from other ones.

Glottal stops are often dropped in speech (Enguehard & Faust 2018). I usually omit them, but at times retain an apostrophe in order to distinguish between otherwise homophonous forms, for example *hefria* ‘he disturbed’ ~ *hefri’a* ‘she disturbed’.

When presenting verbal paradigms I include two substandard forms. The 1SG future form is normally prefixed with *a*- or *e*-, e.g. *e-xtov* ‘I will write’. Contemporary usage, however, syncretizes ‘1SG future’ with ‘3SG.M future’: *je-daber* ‘I/he

will talk'. I include both forms when giving paradigms. And finally, contemporary usage does not distinguish between masculine and feminine plural forms in past and future tense verbs. The traditional feminine plural endings have been discarded, syncretizing instead with the masculine plural forms.

In the Hebrew glosses, 'ACC' is used for the direct object marker *et* and 'of' for the head of a CONSTRUCT STATE nominal, in the interest of readability. When reproducing examples from the literature I have modified the original transcriptions for consistency.

Finally, I am careful to use CONSTRUCTION as a term which is meant to be informal, descriptive or pre-theoretical. For example, a *causative construction* does not entail any specific analysis but is merely a convenient label. In contrast, I use STRUCTURE or CONFIGURATION to mean the underlying syntax, for example an unaccusative configuration. With this housekeeping out of the way, we return to the theoretical approach.

1.3 Architectural assumptions

Since my aim is to account for the syntactic, semantic and phonological behavior of the system, I must be explicit about my assumptions in all three cases. But since the focus is on the syntax and how it feeds interpretation at Logical Form (LF) and Phonological Form (PF), I divide the overview here into syntax and the interfaces.

1.3.1 The syntax

I assume a mainstream variety of Distributed Morphology (DM, Halle & Marantz 1993) within the Minimalist Framework (Chomsky 1995). This means that all syntactic and morphological objects are built in the syntax; there is no separate grammatical module for word-building. The traditional work of the lexicon is distributed between the syntax, the semantics and the phonology: the syntax builds up binary structures via Merge of morphemes according to syntactic constraints, features, mechanisms and so on. Traditional "words" are composed here minimally of an abstract root, lacking syntactic category, and one of the three functional heads: *a* for adjectives, *n* for nouns and *v* for verbs (Marantz 2001; Arad 2003). The core of a verb phrase therefore looks as follows, where the root modifies *v* and the internal argument is the complement of *v*.

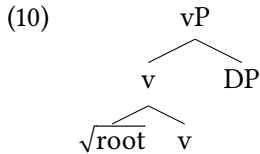

The syntactic structure is transferred to the interfaces at Spell-Out, where it is interpreted by each of the two components. LF calculates meaning and PF calculates (morpho-)phonology. Spell-Out proceeds cyclically, that is, after a structure of certain size has been built up. The three categorizing heads are one such domain for Spell-Out (Arad 2003; Embick 2010; Marantz 2013; Anagnostopoulou & Samioti 2014). The head Voice (see below) demarcates another domain.

Lexical information is stored in what is often called the Encyclopedia, a vaguely-defined warehouse of idiosyncratic information. To the extent that we understand the Encyclopedia, we assume that it is organized by root (Harley 2014a).

This architecture means that there are no stems (as such), no paradigms (as such) and no words (as such). None of these are primitives of the system. Some are epiphenomenal (like paradigms) and some can be more accurately specified as phonological/prosodic words or morphological words, depending on the definition (Embick & Noyer 2001; Gouskova 2019); either way, this definition will be in terms of syntax or phonology, not in independent terms of morphology.

I will not argue for any of these assumptions in this book, but to the extent that the results are convincing, they provide natural support for these assumptions and against stem-based (word-based) theories. Some finer details now follow.

1.3.1.1 What is Voice?

In the current neo-Davidsonian tradition, theories of argument structure have adopted a specific way of thinking about internal and external arguments in the syntax, based in large part on the interpretation asymmetries observed by Marantz (1984) and discussed by Kratzer (1996). The theme or patient of the predicate is generated within the vP as the complement of v.³ The agent is introduced in the specifier of a higher functional head, which takes the vP as its own complement. Since Kratzer (1996) it has become common to call this head Voice and to associate it with accusative case licensing, thereby identifying it with causative “little v” of Chomsky (1995). The basics are given in (11), slightly modifying

³Contemporary decompositional theories do not have a “big-V” lexical verb, V, nor do they have lexical adjectives A and nouns N. In addition, whether or not internal arguments end up in Spec,VP/Spec,vP as in various approaches is immaterial here (Johnson 1991; Alexiadou & Schäfer 2011).

The second point is that as a functional head, Voice might be endowed with different features. In principle, since it licenses a DP in its specifier, it should have the EPP feature [D] (Chomsky 1995). Once we accept that it has that feature, we can begin to ask what other features it can have, and whether these features might get checked in the course of the derivation. Much recent work in argument structure has explored the possible values of the $[\pm D]$ feature on Voice, as well as the theoretical characterization of $[\pm D]$; these issues are discussed directly in Chapters 6 and Section 7.3, after the current theory has been developed in depth. One recent approach is of particular importance so I introduce it next.

1.3.1.2 Layering

A recurring question in discussions of argument structure regards the direction of derivation in (anti-)causative alternations. For an alternation like (12), is the transitive version derived from the intransitive one via causativization or is the intransitive variant derived from the transitive one via anticausativization?

- (12) a. Mary broke the vase.
 b. The vase broke.

In their LAYERING approach to transitivity alternations, Alexiadou et al. (2015) summarize a number of reasons for thinking that neither answer is strictly speaking true. They propose that both variants have the same base: a minimal vP (13a) containing the verb (a verbalized root) and the internal argument. The difference between the two variants is that the transitive one, (13b), then has the external argument added by additional functional material (Voice).⁴

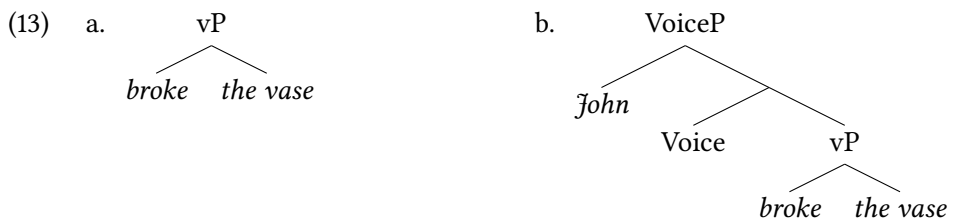

This view explains a range of facts about this alternation, chiefly that there is no dedicated direction of derivation which is marked by the morphology across

⁴Marked anticausatives contain their own Voice layer but still have anticausative syntax and semantics, again because the core vP is the locus of the event. We will get to this in Chapter 3 and recap the specific implementation of the Layering approach in Chapter 6.

languages. That is, while some languages mark the transitive variants, others mark the intransitive variants, and sometimes both variants are marked in the same language (as we have already seen for Hebrew). Even though there is much to say about which verbs or roots are marked in which way (Haspelmath 1993; Levin & Rappaport Hovav 1995; Arad 2005), the grammar itself does not force derivation from one stem type to the other.

In addition to the morphological reasoning, Alexiadou et al. (2015) provide a series of arguments showing that the core causative component of the vP is present even in the anticausative variants. For example, there is no difference in event structure between causatives and anticausatives, indicating that Agents and Causers are not introduced in a separate event to the change of state. Furthermore, the Causer PPs in (14) are possible with anticausatives but Agents are not possible, indicating that causation can take place even without an external argument. Importantly, the causative component is not simply introduced by the preposition *from* (Alexiadou et al. 2006b,a; 2015: 30).

- (14) a. The flowers wilted {from the heat / *from the gardener}.
 b. The window cracked {from the pressure / *from the worker}.

In sum, while there is a causative core, an actual Causer argument can only be introduced by additional structure: either in a cause-PP, or as an external argument in a higher projection. An additional layer, so to speak. Voice is the functional head enabling this layer, both in terms of licensing Spec,VoiceP in the syntax and in opening the semantic function Agent. The causative alternation in English can be easily explained in these terms.

1.3.2 Interfaces

When syntactic structure is spelled-out, it is interpreted at LF (semantics) and PF (phonology). The Trivalent approach shares with other current work a certain view of the so-called autonomy of syntax (Marantz 2013; Wood 2015; Wood & Marantz 2017; Myler 2017). Essentially, the grammar (the syntax) is free to generate different syntactic structures, so long as these satisfy inherently syntactic requirements (for example Case licensing or feature valuation). The syntactic object must then still be interpreted by the interfaces at Spell-Out, at which point they can be said to interpret but also “filter” the output. At LF the semantic composition may or may not converge, and at PF the phonological calculation may or may not yield an optimal candidate. In both cases we may expect certain kinds of crosslinguistic variation.

1 *The valence of Voice*

Compositional semantics proceeds straightforwardly (the main operations are Functional Application and Event Identification, as mentioned above), as does linearization, prosodification and phonological evaluation. See the introductory chapters of Wood (2015) or Myler (2016) for additional details on the semantic composition. While I make repeated reference to semantic roles such as Agent, I do not assume that theta-roles are a primitive of the system. The phonological calculation may be implemented using Optimality Theory (Prince & Smolensky 1993/2004) as done in Kastner (2019b). Here are the other points that might require further elaboration.

1.3.2.1 Roots

I individuate roots based on their phonology (e.g. \sqrt{ktb} and \sqrt{ARRIVE}), but it is more accurate to think of them as pointers to phonological and semantic information (Harley 2014a; Faust 2016; Kastner 2019b). Nevertheless, I will use the phonological shorthand for convenience.

Despite the crucial role of roots in determining the reading of a word, I cannot provide a theory of root meaning here. Not every root can appear in every template, meaning that a root has to license the functional heads it combines with somehow (Harley & Noyer 2000). Exactly how this happens is left vague. Presumably, this licensing should be similar to the way that a root like \sqrt{MURDER} requires Voice in English, but a root like \sqrt{ARRIVE} does not license Voice.

The idea that roots pick out meanings which are shared across forms will likewise not be formalized. I will be relatively comfortable talking about shared meaning in cases of alternations. In Sections 2.4 and 4.4 I will discuss cases where the shared meaning is slightly less easy to pin down. Neither of these points is particular to Hebrew within root-based approaches like DM (and both require engaging more seriously with the lexical semantics literature), but they do appear more prominent because of the nature of the morphological system.

It is important to delve a bit deeper into the idea of one root across a few templates. Consider \sqrt{pkd} in (15). One could find a general semantic notion of “counting” or “surveying” running through the use of this root but the alternations are in no way obvious.

- (15) a. *XaYaZ*: *pakad* ‘ordered’.
b. *niXYaZ*: *nifkad* ‘was absent’.
c. *XiYeZ*: *piked* ‘commanded’ (and a passive *XuYaZ* form).
d. *heXYiZ*: *hefkid* ‘deposited’ (and a passive *huXYaZ* form).
e. *hitXaYeZ*: *hitpaked* ‘allied himself’, ‘conscripted’.

1 The valence of Voice

The English definite article also has two contextual allomorphs conditioned by the phonological environment (but cf. Gouskova et al. 2015; Pak 2016).

- (18) a. *a dog*
b. *an apple*

Similarly:

$$(19) \text{ D}[-\text{def}] \leftrightarrow \begin{cases} a & / _ \#C \\ an & / _ \#V \end{cases}$$

Some roots also supplete based on their environment. Here the context for allomorphy is not the phonological features of the local trigger but the syntactic features.

- (20) a. *go* (today)
b. *went* (yesterday)

$$(21) \text{ GO}^5 \leftrightarrow \begin{cases} go & / _ [\text{PRS}] \\ went & / _ [\text{PAST}] \end{cases}$$

Similarly for adjectives:

- (22) a. *good*
b. *better*
c. *best*

$$(23) \text{ GOOD} \leftrightarrow \begin{cases} good & / _ [\text{NORM}] \\ better & / _ [\text{CMPR}] \\ best & / _ [\text{SPRL}] \end{cases}$$

The question occupying many theorists at the moment regards the exact nature of “_”: is it linear adjacency, syntactic adjacency, or something else? In previous work I have adopted the idea that allomorphy can only be triggered under linear adjacency of overt elements (Embick 2010; Marantz 2013). This hypothesis helps explain a range of allomorphic interactions in Hebrew, as I argued for in Kastner (2019b). Some of these points will be mentioned in the following chapters – in particular because I think the current analysis makes the right predictions – but the discussion does not revolve around them.

⁵This is a simplified version for expository purposes. The element to be spelled out should be something like $\sqrt{\text{GO}}$ in the context of the verbalizer *v*, in addition to phi-features.

In my formal analysis I will assume that the stem vowels spell out Voice and that affixes spell out higher material (this can be seen as a Mirror Principle effect following directly from cyclic spell out; Baker 1985; Muysken 1988; Wallace 2013; Zukoff 2017; Kastner 2019b). Alternatively, we may assume that a dissociated Theme node is projected (“sprouted”) from Voice postsyntactically (Oltra Massuet 1999; Embick 2010); the same holds for Agr (agreement suffixes based on phi-features), be it on T or sprouted from T. But for simplicity I will represent the stem vowels as the overt spell-out of Voice and agreement as the spell out of a joint T+Agr head.

1.3.2.3 Contextual allosemy

The phenomenology of contextual allomorphy is fairly well understood, even if the exact mechanisms are under debate. A similar concept that has only recently gained currency is contextual ALLOSEMY. The idea is the same. One morpheme may have a number of interpretations competing for insertion at PF; this is allomorphy. One morpheme may also have a number of interpretations competing for insertion at LF; this is allosemy. Recent discussions can be found in Wood & Marantz (2017) and Myler & Marantz (submitted).

Kratzer (1996) proposed that Voice introduces the Agent role for eventualities (24) and that Holder introduces the Holder role for states (25).

(24) *feed the dog*:

- a. $\llbracket \textit{feed the dog} \rrbracket = \lambda e.\textit{feed}(\textit{the dog}, e)$
- b. $\llbracket \textit{Voice} \rrbracket = \lambda x \lambda e.\textit{Agent}(x, e)$
- c. $\llbracket \textit{Voice feed the dog} \rrbracket = \lambda x \lambda e.\textit{Agent}(x, e) \ \& \ \textit{feed}(\textit{the dog}, e)$

(25) *own the dog*:

- a. $\llbracket \textit{own the dog} \rrbracket = \lambda s.\textit{own}(\textit{the dog}, e)$
- b. $\llbracket \textit{Holder} \rrbracket = \lambda x \lambda s.\textit{Holder}(x, s)$
- c. $\llbracket \textit{Holder own the dog} \rrbracket = \lambda x \lambda s.\textit{Holder}(x, s) \ \& \ \textit{own}(\textit{the dog}, e)$

Yet nothing forces Voice and Holder to be separate heads; in fact, this would be surprising given that their syntax and morphology are identical. As explained by Wood (2015), we could just as well posit that Voice has two contextual allosemes: one when it combines with a dynamic event and another one when it combines with a stative event, (26).

$$(26) \quad \llbracket \textit{Voice} \rrbracket \leftrightarrow \begin{cases} \lambda x \lambda e.\textit{Agent}(x, e) & / _ _ \text{ (eventuality)} \\ \lambda x \lambda s.\textit{Holder}(x, s) & / _ _ \text{ (state)} \end{cases}$$

Here the contexts are purely semantic, as they should be, given that we are now in LF.

I make extensive use of this formalism in order to encode the semantics of functional heads in this book. An alternative could also be considered, whereby there is a proliferation of homophonous heads similar to Voice and Holder. I see no reason to adopt this perspective, especially considering how naturally contextual allosemy fits into the Trivalent framework. We can now overview what this framework does for the puzzles of Hebrew.

1.4 Sketch of the system

Reviewing the facts that require explanation, all templates can be described along two axes: the range of interpretations they are compatible with and the canonical alternations they participate in.

We have already seen that transitive verbs exist both in $XaYaZ$ and $heXYiZ$, and that unaccusatives exist in $niXYaZ$. Yet transitive verbs also exist in $XiYeZ$ (27a) and anticausatives also exist in $hitXaYeZ$ (27b). So the syntactic configuration does not entail a given template.

- (27) a. Transitive in $XiYeZ$: *bifel* ‘cooked’ (not $XaYaZ$ **basal*)
b. Anticausative in $hitXaYeZ$ *hitparek* ‘fell apart’ (not $niXYaZ$ **nifrak*)

Conversely, a given template does not always entail a given syntactic configuration. Even $niXYaZ$ appears on some unergatives, (28a), and $hitXaYeZ$ instantiates not only anticausatives as in (27b) but also reflexives as in (28b).

- (28) a. Unergative in $niXYaZ$ *nilxam* ‘fought’ (not anticausative)
b. Reflexive in $hitXaYeZ$ *hitgaleax* ‘shaved’ (not anticausative)

This section concludes the introduction by presenting a simplified overview of how the entire system can be understood. The first aspect of the analysis (what readings a given template has) is mainly accomplished using the features on Voice. The second aspect (which templates form alternations) is accomplished using hierarchical syntactic structure.

1.4.1 Simple alternations

We can start from an alternation that works fairly intuitively, the one we saw back in (2–4). In this near-minimal triplet, three verbs are found in which a given root (\sqrt{ktb}) clearly has three different kinds of morphological marking, or templates. Again, TEMPLATE is a descriptive term in this book, not a formal one.

- (29) a. Causative verb in *heXYiZ*:
 fabjen *hextiv-a* (la-talimidim) et refimat ha-nosim.
 Fabienne dictated-F to.the-students ACC list.of the-topics
 ‘Fabienne dictated the list of topics (to the students).’
- b. Transitive verb in *XaYaZ*:
 ha-talimidim *katv-u* et ha-nosim.
 the-students wrote-PL ACC the-topics
 ‘The students wrote the topics down.’
- c. Anticausative/mediopassive verb in *niXYaZ*:
 ha-xiburim *nixtev-u* (al-jedej ha-talimidim).
 the-essays were.written-PL by the-students
 ‘The essays were written (by the students).’

Relying on the idea that the external argument is introduced by the functional head Voice, I propose that it may be endowed with syntactic features, specifically the feature $[\pm D]$.

- (30) Trivalent Voice
- a. Voice is associated with a $[\pm D]$ feature, meaning it can be valued as $[+D]$, $[-D]$ or unspecified with regard to $[D]$.⁶
- b. This feature indicates whether the specifier of Voice must be filled by a DP ($[+D]$), cannot be filled by a DP ($[-D]$), or is agnostic as to whether it is filled by a DP (unspecified).

A verb with $\text{Voice}_{[+D]}$ requires an external argument; a verb with $\text{Voice}_{[-D]}$ prohibits an external argument; and if Unspecified Voice is merged, the syntax itself does not place a restriction, although the root will (lexical idiosyncrasy contained within a rigid syntax).

Importantly, these Voice heads differ in their phonological form. Assuming that $\text{Voice}_{[+D]}$ spells out as *heXYiZ*, $\text{Voice}_{[-D]}$ as *niXYaZ* and Unspecified Voice as *XaYaZ*, the theory derives the alternations seen in (29) as in Table 1.4.

Table 1.4: Simple alternations in Hebrew

	$\text{Voice}_{[+D]}$	Voice	$\text{Voice}_{[-D]}$
	Causative	Transitive	Anticausative
	<i>heXYiZ</i>	<i>XaYaZ</i>	<i>niXYaZ</i>
$\sqrt{\text{ktb}}$	<i>hextiv</i> ‘dictated’	<i>katav</i> ‘wrote’	<i>nixtav</i> ‘was written’
$\sqrt{\text{x}l}$	<i>heexil</i> ‘fed’	<i>axal</i> ‘ate’	<i>neexal</i> ‘was eaten’

⁶A similar view of binary features as trivalent is espoused by Harbour (2011).

1 The valence of Voice

To finish this initial overview we will walk through the alternations. Following Kratzer (1996) and Alexiadou et al. (2015), it has become fairly common to assume that a core vP contains a causative component which is semantically available even in anticausatives (Section 1.3.1.2). Voice can then add an external argument (an agent), but otherwise the vP already has a basic meaning. Accordingly, we can combine the root $\sqrt{\text{ktb}}$, the verbalizer *v* and an internal argument. This vP gives us a basic event of writing something, where *v* is silent (all through the language, by hypothesis):

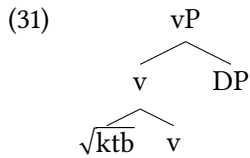

The combinatorics are now simple. If we merge $\text{Voice}_{[-D]}$, no external argument is added and we have a simple anticausative. I notate the ban on an element in Spec, VoiceP as “–” in the specifier position for explicitness.

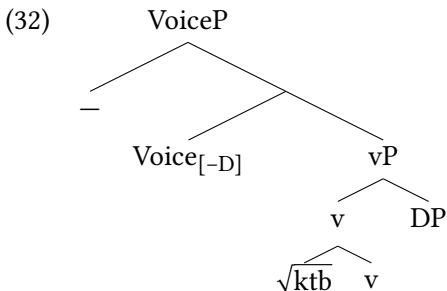

If we merge Voice , an external argument is added and we get the causative variant: an event of writing something with an agent doing the writing.

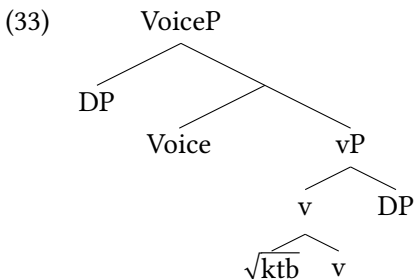

And if we merge $\text{Voice}_{[+D]}$, we will need to specify a different kind of external argument (how this happens is explored in Section 4.4).

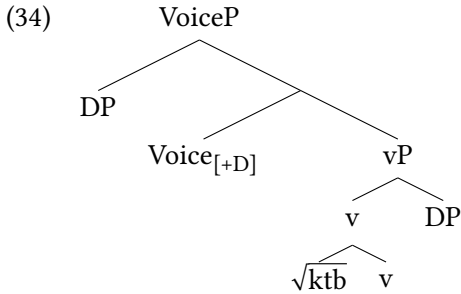

There is no direct alternation between templates, only compositional interpretation of syntactic structure.

1.4.2 Beyond simple alternations

The three-way distinction analyzed above is instructive but not deterministic, since a given syntactic configuration does not always entail a given template, and a given template does not always entail a given syntactic configuration.

Importantly, while verbs in *heXYiZ* are generally active (29a) and those in *niX-YaZ* generally non-active (29c), verbs in *XaYaZ* are underspecified with regard to their argument structure, cf. (29b): with some roots, the verb might be transitive; with others, unergative; and with others still, unaccusative, (35).

- (35) a. Transitive *XaYaZ*:
 teo *axal* et ha-laxmanja.
 Theo ate ACC the-bread.roll
 ‘Theo ate the bread roll.’
- b. Unergative *XaYaZ*:
 teo *rakad* ve-rakad ve-rakad (kol ha-boker).
 Theo danced and-danced and-danced all the-morning
 ‘Theo danced and danced and danced (all morning long).’
- c. Unaccusative *XaYaZ*:
nafal le-teo ha-bakbuk.
 fell to-Theo the-bottle
 ‘Theo’s bottle fell.’

This “flexibility” of *XaYaZ* can be explained if Unspecified Voice does not impose any restrictions of its own on argument structure. Then some roots like $\sqrt{x\ell}$ in (35a) do require an external argument, some like $\sqrt{rk\hat{d}}$ in (35b) require an external argument but no internal argument (save for cognate objects), and other still like \sqrt{npl} in (35c) disallow an external argument. The summary in Table 1.4 is augmented in Table 1.5.

Table 1.5: Basic alternations in Hebrew (extended)

	Voice _[+D] Active	Voice Unmarked	Voice _[-D] Non-active
	<i>heXYiZ</i>	<i>XaYaZ</i>	<i>niXYaZ</i>
a.	$\sqrt{\text{ktb}}$ <i>hextiv</i> ‘dictated’	<i>katav</i> ‘wrote’	<i>nixtav</i> ‘was written’
b.	$\sqrt{\text{x}l}$ <i>heexil</i> ‘fed’	<i>axal</i> ‘ate’	<i>neexal</i> ‘was eaten’
c.	$\sqrt{\text{rkd}}$ <i>herkid</i> ‘made dance’	<i>rakad</i> ‘danced’	–
d.	$\sqrt{\text{nfl}}$ <i>hepil</i> ‘dropped’	<i>nafal</i> ‘fell’	–
e.	$\sqrt{\text{fbr}}$ –	<i>favar</i> ‘broke’	<i>nifbar</i> ‘was broken’

On this account, verbs in *heXYiZ* are expected to be transitive or unergative because they require an external argument (Chapter 4), verbs in *niXYaZ* are expected to be mediopassive (anticausative or passive) because they lack an external argument syntactically (Chapter 3), and verbs in *XaYaZ* could go either way, depending on the idiosyncratic requirements of the root (Chapter 2). The three values of Voice correspond to different morphological markings, but there is more than one way to get e.g. an anticausative verb (namely with Unspecified Voice or with Voice_[-D]). This way of looking at things dissolves the puzzle posed by examples like those above: there is no reason to expect “transitive” to map onto specific morphology deterministically. Any alternations that arise are a by-product of the differences between the heads, or more concretely, between prohibiting an agent, requiring one and allowing one.

This much takes care of three out of seven templates. Two additional templates are easy to explain: the two passive templates *XuYaZ* and *huXYaZ* are always derived from existing active verbs and can be analyzed as spelling out an additional passive head Pass merging above VoiceP (Doron 2003; Alexiadou & Doron 2012). This analysis is uncontroversial, as I discuss in Section 5.1. For example, take *huxtav* ‘was dictated’:

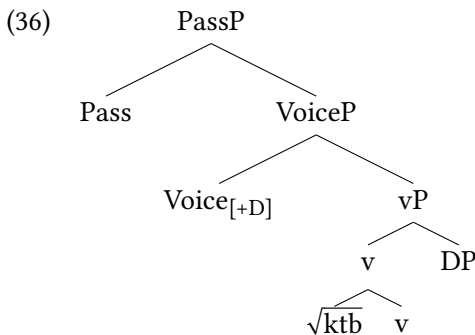

We are left with two more templates, namely $Xi\bar{Y}eZ$ and $hitXa\bar{Y}eZ$. Here I propose that an agentive modifier $\sqrt{\text{ACTION}}$ combines with the vP to create a new core vP. This $[\sqrt{\text{ACTION}} \text{vP}]$ can then merge with Unspecified Voice, yielding $Xi\bar{Y}eZ$, or with $\text{Voice}_{[-D]}$, yielding $hitXa\bar{Y}eZ$, with the predicted alternation between active and anticausative. How this works is the focus of Section 3.7.1.

1.4.3 From templates to functional heads

Before delving into the data we should take stock of the syntactic machinery. The functional head v introduces an event variable and categorizes a root as a verb. A higher functional head, Voice, introduces the external argument. The agentive modifier $\sqrt{\text{ACTION}}$ overtly introduces agentive semantics whose characterization is set aside until Section 2.4.

I further assume that the functional head p introduces the external argument of a preposition, also called its Figure (Svenonius 2003; 2007; Wood 2014). Voice and p heads introduce a DP in their specifier. In a regular, unmarked active clause, default (silent) Voice introduces the external argument. The head p was proposed by Svenonius (2003; 2007) to act in similar fashion to Voice or Chomskyan little v : it merges above the PP, introducing the Figure (subject) of the preposition. I will not attempt to motivate this structure but will simply assume it; it is meant to capture the predicative relationship between the two DPs, similarly to the PredP of Bowers (1993; 2001) and *ann*-XP of McCloskey (2014). In (37) the Figure is the DP *the book* and the Ground, the object of the preposition, is *the table*. Dashed arrows represent assignment of semantic roles; see Section 3.4.

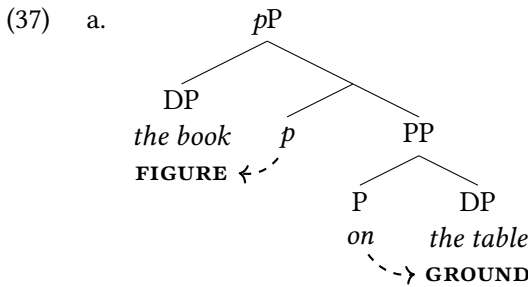

b. $\llbracket p \rrbracket = \lambda x \lambda s. \text{Figure}(x, s)$

To these heads I add two nonactive counterparts, $\text{Voice}_{[-D]}$ and $p_{[-D]}$. These two heads dictate that nothing may be merged in their specifiers. $\text{Voice}_{[-D]}$ blocks the introduction of an external argument and $p_{[-D]}$ blocks merger of a

1 The valence of Voice

DP in the specifier of pP . The different kinds of Voice/ p only manipulate the syntax: they dictate whether a DP may or may not be merged in their specifier. Both Voice $[-D]$ and $p[-D]$ are spelled out by the morphophonology of $niXYaZ$, which adds a prefix and triggers insertion of certain vowels. Voice also has the strongly active counterpart Voice $[+D]$. In its simplest definition, this head requires that a DP be merged in its specifier, behaving the opposite of Voice $[-D]$. For completeness we might also assume a covert $p[+D]$ in some ditransitive verbs, just like overt p , although at least in Hebrew there is no empirical motivation for distinguishing p from $p[+D]$.

Alongside lexical roots and these functional heads I posit $\sqrt{\text{ACTION}}$. In the semantics, this element types the event as an Agent, an Action (Doron 2003) or “self-propelled” (Folli & Harley 2008). In the phonology, $\sqrt{\text{ACTION}}$ is spelled out as a predictable set of vowels slotting between the root consonants. It also blocks a process of spirantization which would otherwise apply to the middle consonant of the root.

The spell-out of these heads produces templates as an epiphenomenon. Details are provided in the relevant chapters.

Table 1.6 summarizes the syntactic, semantic and morphophonological effects of these heads, as well as the chapters and sections in which these fantastic beasts can be found. Special Voice/ p heads affect their specifier; see for the external argument (EA) under “Syntax” and as a prefix under “Phonology”. The effects of the special root $\sqrt{\text{ACTION}}$ can be seen under “Semantics” and as de-spirantization under “Phonology.” Note in particular that the $hitXa\check{Y}eZ$ template is morphologically complex. It is prefixed (overt Voice $[-D]$ / $p[-D]$) and de-spirantized ($\sqrt{\text{ACTION}}$).

If this last part of the overview went by too quickly, the following chapters will guide us more smoothly through the empirical and theoretical landscape.

Part I of the book is organized as follows. I discuss the template $XaYaZ$, Unspecified Voice, the template $Xi\check{Y}eZ$ and $\sqrt{\text{ACTION}}$ in Chapter 2. The templates $niXYaZ$ and $hitXa\check{Y}eZ$ and their particular head Voice $[-D]$ are the topic of Chapter 3. Chapter 4 discusses $heXYiZ$ and Voice $[+D]$. With this Trivalent system established, Chapter 5 embeds these structures under passivizing, adjectivizing and nominalizing heads, providing some cross-categorial context.

Part II provides a detailed comparison of the Trivalent Theory with the Layering Theory in Chapter 6. Chapter 7 then summarizes with general considerations for the nature of Voice.

Table 1.6: Functional heads in the Hebrew verb

	Heads	Syn	Sem	Phono	Section
	Voice			<i>XaYaZ</i>	2.3
	Voice	$\sqrt{\text{ACTION}}$		<i>Action XiYeZ</i>	2.5
Pass	Voice	$\sqrt{\text{ACTION}}$	Passive	<i>Action XuYaZ</i>	5.1.3
	Voice _[+D]		EA	<i>he-XYiZ</i>	4.3
Pass	Voice _[+D]		Passive, EA	<i>hu-XYaZ</i>	5.1.3
	Voice _[-D]		No EA		3.3
	Voice	<i>p</i> _[-D]	EA = Figure	<i>ni-XYaZ</i>	3.4
	Voice _[-D]	$\sqrt{\text{ACTION}}$	No EA	<i>Action</i>	3.7.1
	Voice	$\sqrt{\text{ACTION}}$	<i>p</i> _[-D] EA = Figure	<i>Action hit-XaYeZ</i>	3.7.2

Part I

Hebrew argument structure

2 Unspecified Voice

2.1 Overview

We begin by examining the “simple” template *XaYaZ* and the “intensive” template *XiYeZ*. Section 2.2 reviews the empirical picture for *XaYaZ* and distills a number of generalizations, followed by a formal analysis using the Unspecified Voice head in Section 2.3. I then move on to the template *XiYeZ* in Section 2.4, showing what it teaches us about an agentive modifier which I call $\sqrt{\text{ACTION}}$ in Section 2.5. Section 2.6 summarizes and outlines how the rest of the Hebrew system will inform the theory developed in the first part of this book.

2.2 *XaYaZ*: Descriptive generalizations

This chapter introduces the first part of a theory of Voice which makes room for an unspecified variant, one which neither requires nor prohibits a specifier. We will first consider morphological marking which is compatible with a variety of syntactic structures, namely the template *XaYaZ*.

As we have already seen briefly in the previous chapter, Hebrew has dedicated active and non-active morphology. For example, verbs in *niXYaZ* are usually non-active and those in *heXYiZ* are active. Verbs in *XaYaZ* are unique within the verbal system in that they are underspecified with regard to their argument structure. Simply knowing the morphological form (the template) is not enough to indicate what kind of verb we are dealing with. Let us examine the different possibilities, introducing the diagnostics to be used throughout this book.

2.2.1 Active verbs

With some roots, the verb is transitive. The examples in (1) contain strongly transitive verbs, which require an internal argument and assign accusative case.¹

¹There is a substantial literature on *et* and what kind of syntactic element it is (Siloni 1997; Danon 2001; Borer 2013). What is uncontroversial is that it occurs before specific accusative objects.

2 Unspecified Voice

- (1) a. *teo taraf* *(et ha-laxmanja).
Theo devoured.SMPL ACC the-bread.roll
'Theo devoured the bread roll.'
- b. *ha-balfan katav* *(et) ha-maamar ha-arox.
the-linguist wrote.SMPL ACC the-article the-long
'The linguist wrote the long article.'

With other roots, verbs in *XaYaZ* are unergative. The examples in (2) show activities which can be repeated or modified with atelic adverbials.

- (2) a. *teo rakað ve-rakad ve-rakad* (kol
Theo danced.SMPL and-danced.SMPL and-danced.SMPL all
ha-boker).
the-morning
'Theo danced and danced and danced (all morning long).'
- b. *teo halax kol ha-boker*.
Theo walked.SMPL all the-morning
'Theo walked all morning long.'

Other roots give rise to ditransitive verbs, including strong ditransitives in which the goal cannot be omitted (3).

- (3) a. *teo natan* *(le-marsel) et ha-xatif.
Theo gave.SMPL to-Marcel ACC the-snack
'Theo gave Marcel the treat.'
- b. *teo faal* et ha-sefer me-ha-sifria.
Theo borrowed.SMPL ACC the-book from-the-library
'Theo borrowed the book from the library.'

2.2.2 Non-active verbs

Unaccusative verbs are also possible in this template. Whereas the diagnostics mentioned for active verbs of different kinds are well-established and fairly intuitive, the unaccusative ones are worth introducing in more depth. These are: compatibility with agent-oriented adverbs including 'by itself' (Section 2.2.2.1) and the two standard unaccusativity diagnostics for Hebrew (Section 2.2.2.2).

2.2.2.1 Adverbial modifiers

A common assumption in studies of anticausativity is that the existence of an Agent can be probed using certain adverbial modifiers or the phrase 'by itself'

if there is no Agent (Levin & Rappaport Hovav 1995; Alexiadou & Anagnostopoulou 2004; Alexiadou et al. 2015; Alexiadou & Doron 2012; Koontz-Garboden 2009; Kastner 2017).²

Unaccusatives are incompatible with *by*-phrases, which would otherwise refer to an Agent, (4).

- (4) ha-bakbuk *nafal* (*al-jedej ha-jeled).
 the-bottle fell.SMPL by the-boy
 (int. ‘The boy dropped the bottle’)

Agent-oriented adverbs are fine with transitive verbs (5a) but not with unaccusatives (5b).

- (5) a. teo *taraf* et ha-laxmanja **be-raavtanut**.
 Theo devoured.SMPL ACC the-bread.roll.F in-voracity
 ‘Theo devoured the roll ravenously.’
 b. * ha-bakbuk *nafal* **be-mejomanut**
 the-bottle fell.SMPL in-skill
 (int. ‘The bottle fell skillfully’)

The Hebrew equivalent of ‘by itself’, *me-atsmo* (lit. ‘from himself/itself’), diagnoses the non-existence of an external argument. The phrase is not compatible with direct objects of transitive verbs (6a) but is valid with unaccusatives (6b).

- (6) a. * teo *taraf* et ha-laxmanja {*me-atsmo* / *me-atσμα*}
 Theo devoured.SMPL ACC the-bread.roll.F from-itself from-herself
 (int. ‘Theo devoured the roll of its own accord’)
 b. ha-bakbuk *nafal* **me-atsmo**.
 the-bottle fell.SMPL from-itself
 ‘The bottle fell of its own accord.’

2.2.2.2 Unaccusativity diagnostics

The syntactic literature on Hebrew has identified two main unaccusativity diagnostics. These are verb-subject order (VS) and the possessive dative, although it is important to acknowledge that their status as robust tests has been challenged in recent years (Gaftar 2014b; Linzen 2014; Kastner 2017). I will also discuss a third diagnostic, one that is less commonly adopted, namely the episodic plural.

²Alexiadou et al. (2015) emphasize that for cases where ‘by itself’ agrees with the internal argument as in Hebrew and English, what it diagnoses is the absence of an implicit (external) argument which may be an Agent or a Causer, rather than simply being sensitive to agentivity.

2 Unspecified Voice

The first test is the ordering of the subject and the verb. Modern Hebrew is typically SV(O), but promoted subjects may appear after the verb, resulting in VS ORDER. This is true for both unaccusatives and passives, presumably because the underlying object remains in its original vP-internal position. Unergatives do not allow VS, with the exception of a marked structure referred to as “stylistic inversion”. For additional discussion see Shlonsky (1987), to whom the test is attributed, as well as Shlonsky & Doron (1991), Borer (1995) and Preminger (2010) for other aspects. Transitive configurations are only possible in this kind of inversion (7a), whereas unaccusative verbs are unmarked (7b).

- (7) a. # *kafts-u* **flɔfa klavim** be-ʃmone ba-boker.
 jumped.SMPL-3PL three dogs in-eight in.the-morning
 ‘And thence jumped three dogs at 8am.’ (Marked variant)
- b. *nafl-u* **ʃalɔf kosot** be-ʃmone ba-boker.
 fell.SMPL-3PL three glasses in-eight in.the-morning
 ‘Three glasses fell at 8am.’

Passive verbs (8a) and active verbs in other templates (8b) pattern as expected; we will return to these templates later on, but the diagnostics are consistent.

- (8) a. *huʃlex-u* **ʃalɔf kosot** be-ʃmone ba-boker.
 throw.CAUS.PASS-3PL three glasses in-eight in.the-morning
 ‘Three glasses were discarded at 8am.’
- b. # *jilel-u* **flɔfa xatulim** be-ʃmone ba-boker.
 whined.INTNS-3PL three cats in-eight in.the-morning
 ‘And thence whined three cats at 8am.’ (Marked variant)

The second unaccusativity diagnostic is the POSSESSIVE DATIVE, a construction in which the possessor appears in a prepositional phrase in a separate constituent from the possessee (possessor raising). This construction is taken to be unique to internal arguments in the language (Borer & Grodzinsky 1986; Borer 1998).

A transitive construction is compatible with the possessive dative (9a), as is a non-active construction (9b), whereas an unergative verb leads to an affected interpretation of the kind discussed by Ariel et al. (2015) and Bar-Asher Siegal & Boneh (2016), (9c).

- (9) a. *dana ʃavr-a* **l-i** et ha-ʃaon.
 Dana broke.SMPL-F.SG to-me ACC the-watch
 ‘Dana broke my watch.’

- b. ha-maftexot *nafl-u* I-i.
 the-keys fell.SMPL-PL to-me
 ‘My keys fell.’
- c. # ha-klavim *kafts-u* I-i.
 the-dogs jumped.SMPL-PL to-me
 ‘The dogs jumped and I was adversely affected.’ (int. ‘My dogs jumped’)

Typical change of state predicates can also be found as unaccusatives in this template:

- (10) a. ha-bakbuk *kafa* ba-makpi.
 the-bottle froze.SMPL in.the-freezer
 ‘The bottle froze in the freezer.’
- b. *kafa* **le-teo** ha-bakbuk.
 froze.SMPL to-Theo the-bottle
 ‘Theo’s bottle froze.’

The third diagnostic is what I call the EPISODIC PLURAL, proposed by Borer (1998; 2005). This diagnostic tests whether a covert subject (*pro* in the original formulation) is compatible with plural verbs in episodic contexts. Since this diagnostic has not been subjected to the same scrutiny as others in the literature, I will briefly sketch its strengths and weaknesses as I see them.

Hebrew can express an impersonal reading by using the plural (masculine) form of the verb. When the resulting reading is generic, the argument structure makes no difference: in (11a) an unergative is followed by a passive, and in (11b) an unergative is followed by an unaccusative. All are possible (the template does not matter for present purposes).

- (11) Generic, unergative/unaccusative/passive equally acceptable (Borer 1998: 86)
- a. im *mafgin-im* bli rifajon **neesar-im**
 if demonstrate.CAUS.PRS-PL.M without license arrest.MID.PRS-PL.M
 al-jedej ha-miftara.
 by the-police
 ‘For all x, if x demonstrates without a license, x is arrested by the police.’
- b. *kfe-kofts-im* me-ha-gag **nofl-im** lemata.
 when-jump.SMPL.PRS-PL.M from-the-roof fall.MID.PRS-PL.M down
 ‘For all x, when x jumps from the roof, x falls down.’

2 Unspecified Voice

Borer (1998) notes the following contrast. In episodic contexts – unlike the generic ones in (11) – verbs with an external argument are possible (12), whereas unaccusative and passive ones are not (13). This is what I call here the episodic plural.

- (12) Episodic, unergative/transitive, acceptable
- a. (lex tiftax,) *dofk-im* ba-delet.
go open knock.SMPL.PRS-PL.M in.the-door
'(Go open up,) someone's knocking at the door.'
 - b. (lex tire ma kore,) *tsoak-im* ba-xuts.
go see what happens yell.SMPL.PRS-PL.M in-outside
'(Go see what's happening,) someone's yelling outside.'
 - c. *heftsits-u* et levanon ha-boker.
bomb.CAUS-3PL ACC Lebanon the-morning
'Lebanon was bombed this morning.' (Borer 1998: 83)
- (13) Episodic, unaccusative/passive, unacceptable
- a. * *nofl-im* / *nafl-u* ba-xatser ha-boker
fall.MID.PRS-PL.M fall.MID.PAST-3PL in.the-yard the-morning
(int. 'someone is falling in the yard this morning') (Borer 1998: 85)
 - b. * *mitkalkel-im* ba-gejem axfav
ruin.INTNS.MID-PL.M in.the-rain now
(int. 'things are getting ruined in the rain now')

In his discussion of the possessive dative, Gafter (2014b) shows that while inanimate arguments with the possessive dative are fine, animate arguments with the possessive dative are less acceptable. His critique of this diagnostic is thus based on the argument that what it diagnoses is prominence on an animacy or definiteness scale, rather than structure. Taking this work as our cue, we can try to find an animacy confound here too. Humans are fine as the reference of *pro*, but what about non-humans and inanimates? It turns out that non-humans do trip up the test. In (14) we see examples of unergative verbs with non-human arguments; the examples are ungrammatical, even though unergatives should have been acceptable.

- (14) Episodic, unergative, non-human, unacceptable
- a. * *mehavhev-im* ba-xuts
flicker.INTNS.PRS-PL.M in-outside
(int. 'some car lights are flickering outside')

- b. * *mefahak-im* ba-kalbia
 yawm.INTNS.PRS-PL.M in.the-dog.pound
 (int. ‘some dogs are yawning in the dog pound’)
- c. * *metsajts-ot* ba-xuts
 chirp.INTNS.PRS-PL.F in-outside
 (int. ‘some birds.F are chirping outside’)

Similarly, I think it is possible to find unaccusative contexts with human arguments which are relatively acceptable, something which should not be allowed:

- (15) Episodic, unaccusative, human, possibly degraded but acceptable
- a. (tiftax et ha-delet,) *kof-im* po ba-xuts.
 open ACC the-door freeze.SMPL-PL.M here in-outside
 ‘(Open the door,) we’re/someone’s freezing out here.’
- b. ? (lex tire im tsarix ezra,) *mitalf-im* ba-xuts.
 go see if need help faint.INTNS.MID-PL.M in-outside
 ‘(Go see if help is needed,) people are fainting outside.’
- c. ? (axfav adain xafux aval) be-fmone { *mitorer-im* /
 now still dark but in-eight wake.up.INTNS.MID-PL.M
ji-torer-u }.
 3M-wake.up.INTNS.MID-3PL
 ‘(It’s still dark now,) but at eight o’clock everyone will wake up.’

In sum, the episodic plural also has its pitfalls and is not possible in all contexts. Since I attempt to use non-human arguments in the unaccusative examples, I will set it aside until the discussion of figure reflexives and canonical reflexives in Chapter 3.

2.2.2.3 Non-active recap and unaccusativity tests

Before proceeding, it is important to note that the unaccusativity diagnostics do not always converge for a given datapoint (the same can be said for many other languages, of course). Fairly recent research has been able to identify why this might be: ‘by itself’ diagnoses not unaccusativity, but the lack of an independent Causer/Agent (Alexiadou et al. 2015); VS order diagnoses only surface unaccusativity (Kastner 2017); the possessive dative and the episodic plural are at the very least confounded with the prominence of the argument (Gafter 2014b; Linzen 2014).

2 *Unspecified Voice*

Throughout the book, I have attempted to provide examples where more than one test diagnoses the example as unaccusative, trying to avoid the confounds and complications just noted. In general, I have tended towards the use of VS order and the possessive dative (which often go together), and these are combined with ‘by itself’ when possible. In addition, inanimate arguments have been chosen in order to further rule out agentive readings of events, although not for all examples. Importantly in the context of the current discussion of *XaYaZ*, even with all these caveats, it is still fairly easy to see that there is no morphological difference between transitives, unergatives, ditransitives and unaccusatives in this template.

2.2.3 Summary

Recall that Hebrew templates can be viewed through two lenses: the configurations they are compatible with, and their canonical alternations with other templates. The generalization about verbs in *XaYaZ* is a negative one: there are no syntactic constraints on the kind of verb that appears in this template. For this reason, Doron (2003) does not associate it with any specific functional heads and Borer (2013; 2015) treats it as a verbalized root with no additional syntactic functors. Alternations will be discussed once we engage with the other templates of the language. The generalizations about *XaYaZ* are summarized in (16).

- (16) Generalizations about *XaYaZ*
- a. *Configurations*: Verbs appear in all possible argument structure configurations.
 - b. *Alternations*: *XaYaZ* participates in alternations with the other templates, as will be reviewed throughout the book.

I look into the patterns of *XaYaZ* in more depth in Section 2.3, where I situate them within the Trivalent Theory of Voice.

2.3 Unspecified Voice

This book promotes a theory of argument structure in which Voice can have one of three values: [+D], [-D] or unspecified for [±D]. As foreshadowed in the introductory chapter, the idea is that Voice_[+D] requires an external argument and Voice_[-D] prohibits one. We will now focus on what it means for Voice not to have a preference on the matter, thereby accounting for the patterns in Section 2.2.

First, let me define Unspecified Voice in (17). All definitions of Voice heads in this book take the same form: (a) syntactic definition, (b) semantic denotation, and (c) basic spell-out rules. I give these here and expand upon them in turn.

(17) Unspecified Voice

- a. A Voice head with no specification for a [D] feature. It has no requirements regarding whether its specifier must be filled. In transitive verbs, Voice is the locus of accusative case assignment, either itself by feature checking (Chomsky 1995) or through the calculation of dependent case (Marantz 1991).
- b. $\llbracket \text{Voice} \rrbracket = \begin{cases} \lambda P.P & / \text{---} \{ \sqrt{\text{npl}} \text{ 'FALL'}, \sqrt{\text{kpa}} \text{ 'FREEZE'}, \dots \} \\ \lambda x \lambda e. \text{Agent}(x, e) & \end{cases}$
- c. Voice \leftrightarrow *XaYaZ* (with the allomorph *XiYeZ* to follow in Section 2.5)

2.3.1 Syntax

The view of argument and event structure adopted here (see Section 1.4) builds up the verbal domain in “layers”. Taking the root $\sqrt{\text{trf}}$, which has to do with devouring, we first build up a verb by adjoining the root to the verbal category head *v*, and then merge the DP required as an internal argument. This gives us a function over events of devouring that DP, as in Figure 2.1. Adding the traditional Voice head would do little to change the event but would add an agent role to the semantics. The current Voice head is slightly different.

In the Trivalent system, the lack of a feature on Voice means that the head is not specified for any syntactic feature constraining Spec, VoiceP. That position can be filled or left unprojected, as far as the Voice head is concerned. In this state of affairs, the expectation is that differences between verbs will result from the requirements of individual roots, rather than anything in the structure. In other words, some roots will give rise to transitive verbs, other roots to unaccusative verbs, and so on.

This is exactly what we have seen in the template *XaYaZ*. There are no structural restrictions on argument structure in this template: verbs in *XaYaZ* might be transitive, unergative, ditransitive or unaccusative. Some of the examples from Section 2.2 are repeated below with minimal syntactic structures (leaving out material above VoiceP, such as Tense).

In (18) we see the core transitive verb *taraf*, which requires an internal argument. The accusative/DOM marker *et* must also appear, indicating that this is a transitive construction.

2 Unspecified Voice

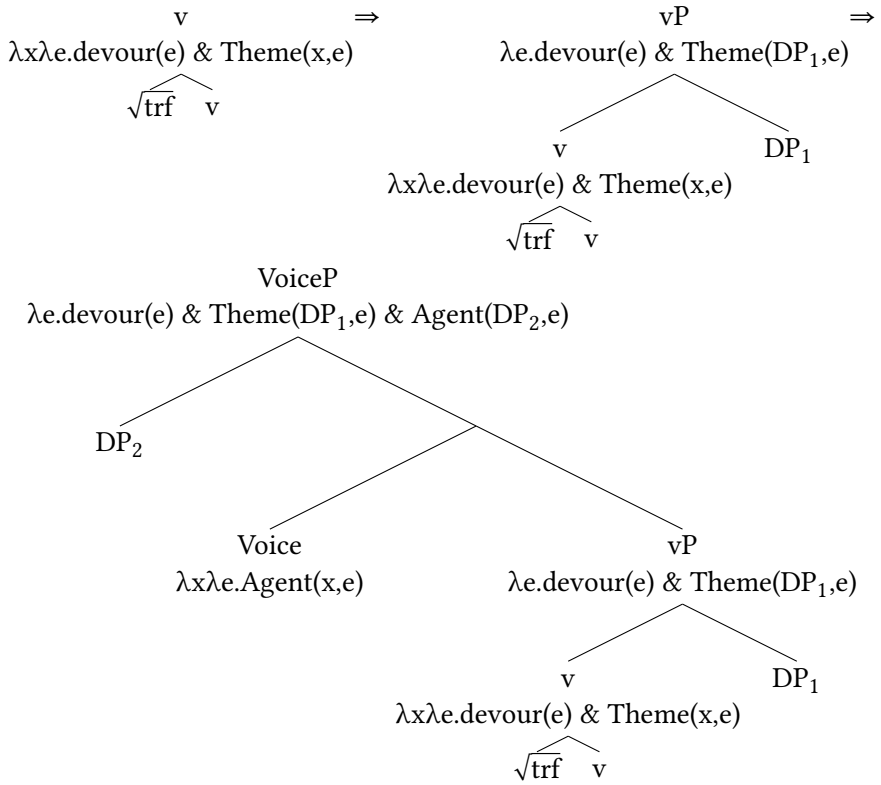
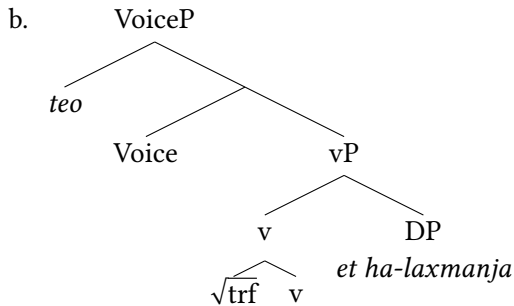

Figure 2.1: Layering the verb phrase

- (18) a. *teo taraf* *(*et ha-laxmanja*).
 Theo devoured ACC the-bread.roll
 'Theo devoured the bread roll.'



Unergative verbs are also possible, as with *rakad* ‘danced’ in (19). No internal argument is necessary, the event is an activity which can go on over a certain period of time with no concrete telos, and agent-oriented adverbs are possible.

- (19) a. *teo rakad ve-rakad ve-rakad (be-mejomanut) (kol*
 Theo danced and-danced and-danced in-skill all
ha-boker).
 the-morning
 ‘Theo danced and danced and danced (skillfully) (all morning long).’

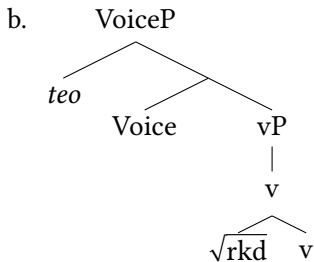

Ditransitive verbs are also possible, as in (20). I do not need to commit to any specific analysis of ditransitive verbs, so I give a general structure headed by low Appl (Pylkkänen 2008: 18).³

- (20) a. *teo natan *(le-marsel) et ha-xatif.*
 Theo gave to-Marcel ACC the-snack
 ‘Theo gave Marcel the treat.’

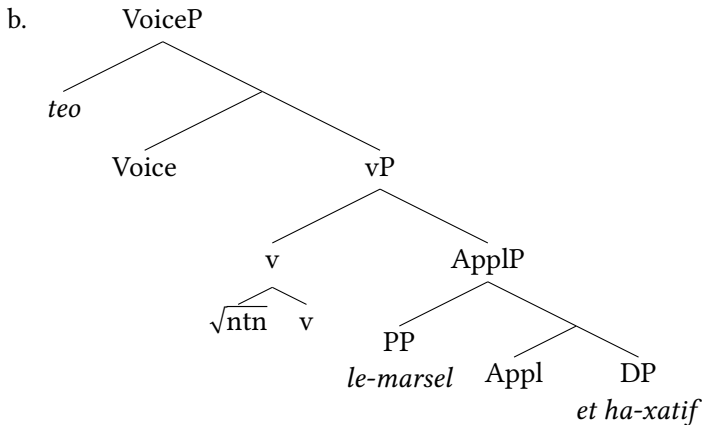

³In Section 3.4 we switch to a specific implementation of PP arguments using *p*, a PP-licenser (Koopman 1997; Svenonius 2003; Gehrke 2008; Wood 2015).

2 Unspecified Voice

Lastly, unaccusative verbs are also possible. The two traditional diagnostics are fronting of the verb and the possibility of using a possessive dative, both evident in (21). I return to discussing these diagnostics in more depth when we focus on unaccusative verbs in Section 3.2.1.2. The tree in (21b) does not present the final word order, on which see Preminger (2010).

- (21) a. *nafal le-teo ha-bakbuk.*
 fell to-Theo the-bottle
 ‘Theo’s bottle fell.’

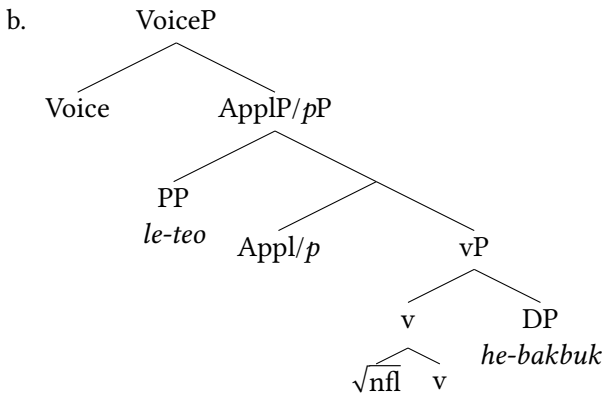

This is how Unspecified Voice captures the underspecified nature of the template *XaYaZ*. Since there are no restrictions in the syntax, the root is free to require any interpretation from *v* and Voice (save for reflexive readings, which are discussed in Section 3.7.1). The question does arise of what exactly the status of Merge is in such a system, a point of discussion I postpone until Chapter 7.

2.3.2 Semantics

The underspecification of this head – and of the resulting template – can be implemented in the semantics using contextual allosemy of Voice. As explained in Section 1.3, the meaning of a functional head can depend on the syntactic and semantic context it appears in, a situation of conditioned allosemy. This formal mechanism allows us to state which meanings arise in which contexts.

Assuming that the active variant is the Elsewhere case, certain roots will be said to require a non-active allosemy of Voice (22a) and others will be compatible with agentive verbs (22b):⁴

⁴Chapter 6 contains a brief comparison of contextual allosemy with one alternative, namely postulating homophonous heads.

- (22) $\llbracket \text{Voice} \rrbracket =$
 a. $\lambda P.P$ / $___ \{ \sqrt{\text{npl}} \text{ 'FALL'}, \sqrt{\text{kpa}} \text{ 'FREEZE'}, \dots \}$
 b. $\lambda x \lambda e. \text{Agent}(x, e)$

Other allosemes are also possible, as when Kratzer (1996) – and in the current formalism, Wood & Marantz (2017) – suggest that Voice can introduce either the Agent or Holder role, depending on the vP it combines with. While the syntax and semantics are flexible and root-specific, the phonology is consistent, uniquely identifying this head for learner and analyst alike.

2.3.3 Phonology

The basic paradigm is outlined in Table 2.1; for more examples see Schwarzwald (2008), Faust (2012) or Kastner (2019b).⁵

Table 2.1: Inflectional paradigm for *XaYaZ*

	Past		Present		Future	
	M	F	M	F	M	F
1SG	XaYaZ-ti		XoYeZ	XoYeZ-et	e-XYoZ/ji-XYoZ	
1PL	XaYaZ-nu		XoYZ-im	XoYZ-ot	ni-XYoZ	
2SG	XaYaZ-ta	XaYaZ-t	XoYeZ	XoYeZ-et	ti-XYoZ	ti-XYeZ-i
2PL	XaYaZ-tem	XaYaZ-ten/tem	XoYZ-im	XoYZ-ot	ti-XYeZ-u	
3SG	XaYaZ	XaYZ-a	XoYeZ	XoYeZ-et	ji-XYoZ	ti-XYoZ
3PL	XaYZ-u		XoYZ-im	XoYZ-ot	ji-XYeZ-u	

⁵Some verbs in this template are phonologically marked. Verbal stems are normally longer than one syllable, except for some in *XaYaZ* which flout this restriction:

- (i) *ba* ‘came’, *fav* ‘returned’, *tsats* ‘appeared’.

The intuition expressed by some authors is that if there are no overt affixes, there might not be any functional material closing off some morphological domain, and so the root will be relatively unconstrained in the phonology. For Ussishkin (2005), for example, the fact that strong prosodic constraints hold in all *other* templates exhibits effects typical of The Emergence of The Unmarked, since they are derived by overt affixation. See discussion of such verbs and their roots also by Laks (2011), Borer (2013; 2015), Tucker (2015) and Kastner (2019b).

2 Unspecified Voice

What I assume throughout is that the stem vowels spell out Voice and that affixes spell out T+Agr (Section 1.3.2). Since Voice is local to T+Agr, T+Agr can condition allomorphy on the vowels, symbolized by the dotted arrow in (23). As a result, different phi-feature values condition different stem vowels as in Table 2.1. This aspect of the theory is based on Wallace (2013) and explored more fully in Kastner (2019b).

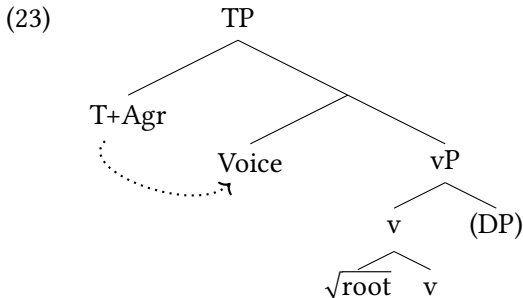

The relevant Vocabulary Items for two verbs, *taraf* ‘devoured’ and *katav* ‘wrote’, are given in (24). The verbalizer *v* is silent by hypothesis. The final /b/ of \sqrt{ktb} spirantizes to [v], a productive process in the language (Temkin Martínez & Müllner 2016; Kastner 2017; 2019b), yielding /katab/ → [katav].

- (24) *taraf* ‘devoured’, *katav* ‘wrote’:
- $\sqrt{trf} \leftrightarrow trf$
 - $\sqrt{ktb} \leftrightarrow ktb$
 - $v \leftrightarrow$ (covert)
 - Voice $\leftrightarrow a, a / T[\text{Past}] \text{ ___}$

Various other processes might apply, too. Next we will see derivations with the 3SG.F suffix *-a* as well as a process of syncope, in which a vowel is deleted (annotated <a>). Recall that spell-out proceeds cyclically, first within the VoiceP domain and then within the TP domain. First, *tarfa* ‘she devoured’:

- (25) Cycle 1, Syntax: T[Past, 3SG.F]-Voice- \sqrt{trf}
- (26) Cycle 1, VIs:
- $\sqrt{trf} \leftrightarrow trf$
 - Voice $\leftrightarrow a, a / T[\text{Past}] \text{ ___}$
- (27) Cycle 1, Phonology:
- a, a-trf*
 - /taraf/ ⇒ *taraf*

- (28) Cycle 2, Syntax: T[Past, 3SG.F]-*taraf*
 (29) Cycle 2, VIs: 3SG.F ↔ *a* / Past ___
 (30) Cycle 2, Phonology:
 a. *a-taraf*
 b. /a-taraf/ ⇒ /tar⟨a⟩f-a/ ⇒ *tarfa*

And now *katva* ‘she wrote’:

- (31) Cycle 1, Syntax: T[Past, 3SG.F]-Voice- \sqrt{ktb}
 (32) Cycle 1, VIs:
 a. \sqrt{ktb} ↔ *ktb*
 b. Voice ↔ *a,a* / T[Past] ___
 (33) Cycle 1, Phonology:
 a. *a,a-ktb*
 b. /katab/ ⇒ /katav/ ⇒ *katav*.
 (34) Cycle 2, Syntax: T[Past, 3SG.F]-*katav*
 (35) Cycle 2, VIs: 3SG.F ↔ *a* / Past ___
 (36) Cycle 2, Phonology:
 a. *a-katav*
 b. /a-katav/ ⇒ /kat⟨a⟩v-a/ ⇒ *katva*

How exactly these exponents are concatenated will not be derived here; in Kastner (2019b) I give full derivations within an OT grammar. Importantly, the derivation proceeds modularly and cyclically: first the syntax builds up structure, then VI inserts exponents, then the phonology takes over and derives the most harmonic surface forms. But for future tense forms like *ti-xtov* ‘she will write’, we will require a different contextual allomorph for Voice such as that in (37b).

- (37) Voice ↔ $\begin{cases} \text{a. } a,a & / \text{T[Past]} \text{ ___} \\ \text{b. } o & / \text{T[Fut]} \text{ ___} \end{cases}$

Abstracting away from the spell-out of specific inflectional variants within a given template, a general schematic can be stated as in (38b). In Section 2.5 below I introduce a modifier which constrains both the semantics and phonology of Voice, giving us the possibility of (38a).

2 Unspecified Voice

- (38) Voice \leftrightarrow
- a. $Xi\dot{Y}eZ / \text{---} \sqrt{\text{ACTION}}$
 - b. $XaYaZ$

The generalized spell-out rules in (38) provide only a crude approximation of how Voice is handled at PF, but it is important to keep in mind that there is no one “suffix” $XaYaZ$. Rather, there is an intricate morphophonological system of inflectional variants which needs to be taken into account. With that in mind, my focus in this book will be more in setting up basic schemas like those in (38), whereby different syntactic configurations – mostly reflecting different values of Voice – trigger different templatic shapes. The templates themselves, then, have no independent status in the theory and serve only as useful morphophonological mnemonics.

2.3.4 Interim summary

The template $XaYaZ$ is unrestricted in terms of argument structure: verbs with this morphological marking might be unergative, unaccusative, monotransitive or ditransitive, all depending (idiosyncratically) on the underlying root. Yet the morphophonology is consistent across all possible verbs in this template, regardless of their syntax and semantics.

In contrast to the traditional Voice head which introduces an external argument, the Voice head I use to capture this behavior is unspecified with regard to the EPP feature [D]. This head does not place any constraints on its specifier. As a result, there are no restrictions on the argument structure of verbs which are derived using Unspecified Voice. Since every Hebrew verb must be instantiated in one of the seven verbal templates, the appearance of Unspecified Voice can be traced in the morphology as the template $XaYaZ$ (all Hebrew verbs require Voice by assumption; Arad 2005).

In other frameworks, Doron (2003) does not introduce any special heads in order to account for verbs in $XaYaZ$. Borer (2013; 2015) takes $XaYaZ$ to be a verbalized root without functional material attaching to it. The two main reasons for this are the wide range of nominalizations possible in this template and the idiosyncratic phonology. I will return to nominalizations in Section 5.3, after covering the other variants of Voice, but all three frameworks are compatible in their treatment of the $XaYaZ$: all allow for $XaYaZ$ to be as idiosyncratic as it needs to be.

2.4 *XiȲeZ*: Descriptive generalizations

The next template to be examined is *XiȲeZ*. As can be seen from the notation, there are no unique affixes to this template, but the stem vowels are different than in *XaYaZ*. In addition, the middle root consonant Y blocks the process of spirantization mentioned briefly earlier. I borrow the non-syllabic diacritic Ȳ to indicate this.

In this section I lay out the basics of verbs in *XiȲeZ*, basically supporting the generalizations established by Doron (2003). In terms of possible constructions, verbs in this template are always active, and what's more, they are agentive in a weak sense which I will identify informally. In terms of alternations, they sometimes provide "intensive" alternants of verbs in *XaYaZ*, again in a way I will explain below. This section provides an overview of the data; the next section gives a formal analysis, based on the head Unspecified Voice we have just seen and an agentive modifier, $\sqrt{\text{ACTION}}$.

First, let me reestablish the terminology used here. I take CAUSERS to be any kind of external argument. AGENTS are a subset of Causers, typically understood as animate and volitional Causers. In the discussion below, AGENT will be used more or less interchangeably with "actor", "direct cause", and the other labels used in the literature. So, throughout this book, when I say AGENT what I mean is a stronger type of Causer, a distinction which as far as I can see is vague precisely because it is rooted in the semantics of various kinds of events rather than in syntactic features. The discussion which follows should make these distinctions clear.

To understand the syntax-semantics of *XiȲeZ*, consider the pairs in (39). In (39a), both Agents and Causers are possible. In (39b) only the Agent is possible. The (a) example has the verb in *XaYaZ*, the (b) example in *XiȲeZ*.

- (39) a. { \checkmark ha-jeladim / \checkmark ha-tiltulim ba-argaz} *favr-u* et
 the-children the-shaking in.the-box broke.SMPL-PL ACC
 ha-kosot.
 the-glasses
 ‘{The children / Shaking around in the box} broke the glasses.’
- b. { \checkmark ha-jeladim / \times ha-tiltulim ba-argaz} *fibr-u* et
 the-children the-shaking in.the-box broke.INTNS-PL ACC
 ha-kosot.
 the-glasses
 ‘{The children / *Shaking around in the box} broke the glasses to bits.’
 (Doron 2003: 20)

2 Unspecified Voice

What other readings do verbs in $Xi\bar{Y}eZ$ have? This template is traditionally called the “intensive” because of alternations such as those above and in Table 2.2 a–c, but it can also house pluractional verbs, d–f, and various others, g–i:

Table 2.2: Pretheoretical classification of some verbs in $Xi\bar{Y}eZ$

	$XaYaZ$			$Xi\bar{Y}eZ$	
a.	\sqrt{fbr}	favar	‘broke’	fiber	‘broke to pieces’
b.	\sqrt{jtsr}	jatsar	‘produced’	jitser	‘produced’
c.	$\sqrt{’kl}$	axal	‘ate’	ikel	‘corroded, consumed’
d.	\sqrt{hlx}	halax	‘walked’	hilex	‘walked around’
e.	\sqrt{rkd}	rakad	‘danced’	riked	‘danced around’
f.	$\sqrt{\hat{k}fts}$	kafats	‘jumped’	kipets/ kiftsets	‘jumped around’
g.	\sqrt{tps}	—	—	tipes	‘climbed’
h.	\sqrt{ltf}	—	—	litef	‘petted’
i.	$\sqrt{\hat{k}bl}$	—	—	kibel	‘received’

In all cases, the verbs are active: either unergative or transitive. And in all cases, the external argument is agentive. In some examples this contrast is clear: a storm cannot “intensively” break a window to bits.

- (40) a. ha-sufa *favr-a* et ha-xalon.
the-storm broke.SMPL-F ACC the-window
‘The storm broke the window.’
- b. ha-jeladim *fibr-u* et ha-xalon le-xatixot **be-xavana**.
the-children broke.INTNS-PL ACC the-window to-pieces in-purpose
‘The children broke the window to bits on purpose.’
- c. * ha-sufa *fibr-a* et ha-xalon (le-xatixot)
the-storm broke.INTNS-F ACC the-window to-pieces
(int. ‘The storm broke the window to pieces’)

But as Doron (2003) points out, even inanimate entities can be the subjects of verbs in $Xi\bar{Y}eZ$. She gives the following pair of examples. As she puts it:

The simple verb *produce* in [(41a)] has a reading where the protein is the trigger for antibodies being produced. The intensive-template verb in [(41b)] can only be interpreted such that the protein actually participates in the production process itself. (Doron 2003: 21)

- (41) a. ha-xelbon *jatsar* ba-guf nogdanim.
the-protein produced.SMPL in.the-body antibodies
‘The protein produced antibodies in the body.’
- b. ha-xelbon *jitser* ba-guf nogdanim (*be-xavana).
the-protein produced.INTNS in.the-body antibodies in-purpose
‘The protein produced antibodies in the body (*on purpose).’

The generalizations for *XiYeZ*, then, are as follows:

- (42) Generalizations about *XiYeZ*
- a. *Configurations*: Verbs appear in active (transitive/unergative) configurations. Readings are weakly agentive.
- b. *Alternations*: When alternating with *XaYaZ*, *XiYeZ* provides a more “intensive” or agentive version.

Making reference to “weak agentivity” and “intensive” readings is a fine semantic line to tread. In what follows I review what I think are some similar phenomena across languages and empirical domains, before turning to the formal analysis.

2.4.1 Agentive modifiers crosslinguistically

2.4.1.1 Agentivity ≠ animacy

A number of recent works on argument and event structure have identified a component of meaning that can be broadly described as agentive, volitional, or a “direct cause”. The most straightforward view of agentivity equates it with animacy. For example, Italian *fare*-causatives require the causee to be animate, as in (43). Similar considerations are familiar from control phenomena as discussed in a range of work from Farkas (1988) to Zu (2018).

- (43) Italian (Folli & Harley 2008: 196)
- a. Gianni ha fatto rompere la finestra a Maria.
John has made break the window to Maria
‘John had Maria break the window.’

2 Unspecified Voice

- b. # Gianni ha fatto rompere la finestra al ramo.
John has made break the window to.the branch
(int. 'John had the branch break the window.')

In their study of animacy in English, Italian, Greek and Russian, Folli & Harley (2008) considered a range of data in which the acceptability of an external argument depends on whether it is *teleologically capable* of causing the event (as opposed to an agency or animacy restriction). Even though animacy is the relevant factor within the teleological capability of the relevant argument in many cases, Folli & Harley (2008) identified cases of sound emission, possession, causation, permission and consumption where the licensing conditions on external arguments cannot be understood in terms of animacy, but in terms of whether the internal properties of the external argument can bring about the relevant event.

For example, in Italian causatives without *fare*, inanimate causers vary with respect to how acceptable they are. A branch is fine, but a storm is not. The explanation is that the branch is a direct causer but the storm is not a proximate enough causer; it is not teleologically capable.⁶

(44) Italian (Folli & Harley 2008: 195)

- a. Il ramo ha rotto la finestra.
the branch has broken the window
'The branch broke the window.'
- b. ? Il vento ha rotto la finestra.
the wind has broken the window
'The wind broke the window.'
- c. # Il temporale ha rotto la finestra.
the storm has broken the window
(int. 'The storm broke the window')

A further dissociation of animacy from agentivity (in the current sense) comes from a study of manner and causation in English by Beavers & Koontz-Garboden (2012), who showed that an animate causer is still not necessarily an Agent. The term they use is *actor*, employed to discuss events in which an animate causer is or is not responsible for the consequences of its act. For them, causation is compatible with negligence but actorhood (agentivity) is not. That is why even the animate causer in (45) is not an actor (cf. Rappaport Hovav 2014):

⁶See Irwin (2019) for an explication of some teleological properties in terms of body parts.

- (45) Kim broke my DVD player, but didn't move a muscle—rather, when I let her borrow it a disc was spinning in it, and she just let it run until the rotor gave out!
(Beavers & Koontz-Garboden 2012: 347)

2.4.1.2 Agentivity in nominalizations

What I would like to highlight next is that these kinds of readings can also be triggered by particular morphemes. Moving on to a different empirical domain, recent studies of external arguments in nominalization (Sichel 2010; Alexiadou, Cano, et al. 2013; Ahdout to appear) similarly differentiate agentivity from *direct causation*. The external arguments of Complex Event Nominals are often taken to exhibit AGENT EXCLUSIVITY, whereby only agents are possible. Examples (46–47) show a typical instantiation of this effect: the animate Agent can serve as the external argument of a nominalization, (46), but an inanimate Causer cannot, (47).

- (46) a. *The Allies* separated East and West Germany.
b. *The Allies'* separation of East and West Germany
- (47) a. *The cold war* separated East and West Germany.
b. # *The cold war's* separation of East and West Germany

Sichel (2010) points out, however, that animacy is not always the relevant factor, as observed already in different ways by Pesetsky (1995) and Marantz (1997). The core of her argument is based on natural Causers, which are compatible with some nominalizations but not with others (the following judgments are hers). She takes this to mean that *direct causation* is insufficient if it lacks *direct participation*.

- (48) a. The hurricane's *destruction* of our crops
b. The hurricane's *devastation* of ten coastal communities in Nicaragua
- (49) # The approaching hurricane's *justification* of the abrupt evacuation of the inhabitants

Alexiadou, Cano, et al. (2013) and Alexiadou, Iordăchioaia, et al. (2013) build on Sichel's proposal and suggest that depending on the language and construction, the restriction can depend on either agentivity or direct participation.

2.4.1.3 **Agentive morphemes**

Syntactic environments other than nominalization can give rise to similar effects. There are cases where a specific, overt morpheme can be identified as triggering these agentivity-like effects. In Hebrew, the external arguments of passive verbs can only be Agents, not Causers (Doron 2003). I mention two more cases from other languages here, before we return to a similar phenomenon in Hebrew which I attribute to the element $\sqrt{\text{ACTION}}$.

In their studies of the prefix *afto-* in Greek, Alexiadou (2014) and Spathas et al. (2015) identified it as an *anti-assistive* modifier, triggering agentive readings regardless of syntactic category, (50).

(50) Agentive readings of *afto-* (Alexiadou 2014: 61):

- a. *afto-katastrefome* ‘self-destroy’ (v.)
- b. *afto-kritiki* ‘self-criticism’ (n.)
- c. *afto-didaktos* ‘self-educated’ (a.)

Given its meaning and its similarity to an analytic paraphrase, (51), Spathas et al. (2015) propose the denotation in (52).

(51) Greek (Alexiadou 2014: 63–64)

- a. O Janis katigori-*te*.
the John accuses-NACT
‘John is accused.’
- b. O janis katigori *ton eafto tu*.
the John accuses the self his
‘John accuses himself.’
- c. O janis *afto-katigori-te*.
the John self-accuse-NACT
‘John accuses himself.’

(52) $\llbracket \textit{afto}_{\text{anti-assistive}} \rrbracket = \lambda f \lambda y \lambda e. f(y, e) \ \& \ \forall e' \forall x. (e' \leq e \ \& \ \text{Agent}(x, e')) \rightarrow x=y$
(Spathas et al. 2015: 1335)

Additional elaboration on these complex constructions can be found in these works and the previous works they cite. The technical conclusion is that *afto-* is an adjunct which attaches to Voice, triggering agentive meaning.

A comparable (although still distinct) phenomenon can be found in Tamil, where the suffix *-kol* adds “affective semantics” which are otherwise hard to pin down. Sundaresan & McFadden (2017) discuss the difference in meaning between

verbs with and without *-koʎ* as one of “affectedness” in a way that can be exemplified using the data in (53). With *-koʎ*, the event affects the Agent.

(53) Tamil (Sundaesan & McFadden 2017)

- a. Mansi paal- æ uutt- in- aal.
Mansi milk ACC pour.TR Past 3SG.F
‘Mansi poured the milk.’
- b. Mansi paal- æ uutti- kko- ŋɔ- aal.
Mansi milk ACC pour.TR koʎ Past 3SG.F
‘Mansi poured the milk for herself.’ (Reading 1)
‘Mansi poured the milk on herself.’ (Reading 2)

As Sundaesan & McFadden (2017: 165) put it, “the end result of some event comes back to affect one of the arguments of that same event”, where the relevant argument is the external argument if there is one, otherwise the internal one (as with unaccusatives). In any case, the semantics of *-koʎ* is such that it forces some kind of agent-oriented reading at least in clauses with external arguments.

Where does this crosslinguistic review leave us? The pretheoretical picture which emerges from these works is that natural language has a way of making a fine-grained distinction between different degrees of “direct participation” or agentivity. To the extent that this triggering of agentive semantics is the same phenomenon across languages, it seems highly unlikely that it has the same syntactic underpinnings in all of these cases. A more appropriate explanation would be given in semantic terms (that is, within the denotation of certain morphemes) or in pragmatic terms (world knowledge). As alluded to above, it seems clear that in at least some cases the effect is clearly grammatical, i.e. should be encoded in the semantics of individual morphemes directly, as with agent exclusivity in nominalizations, the anti-assistive modifier in Greek and the affective modifier in Tamil. Such a proposal for Hebrew follows.

2.5 Agentive modification: $\sqrt{\text{ACTION}}$

In this section I introduce another syntactic primitive, the agentive modifier $\sqrt{\text{ACTION}}$. Strictly speaking, this modifier is not part of the theory of Trivalent Voice. The reason it is introduced early on in this book is because it is necessary to capture the full empirical picture; specifically, it will return in the discussion of Voice_[-D] in Chapter 3. Unspecified Voice and the template *XaYaZ* have already been addressed, but the behavior of the template *XiYeZ* indicates that we need to account for additional forms.

2 Unspecified Voice

In order to explain the behavior of verbs in $Xi\tilde{Y}eZ$ I propose to use a special root $\sqrt{\text{ACTION}}$, which enforces agentive (or weakly agentive) readings.⁷ I assume that $\sqrt{\text{ACTION}}$ attaches to the verbal spine at the vP level, thereby triggering the agentive alloeme of Voice (following Doron 2003; 2014). The morphophonology produces the templates $Xi\tilde{Y}eZ$ and $hitXa\tilde{Y}eZ$, as I return to momentarily. Here is the basic proposal, followed by a deep dive into each part (syntax, semantics and phonology).

- (54) $\sqrt{\text{ACTION}}$:
- A modifier which attaches to vP.
 - $[[\text{Voice}]] = \lambda x \lambda e. \text{Agent}(x, e) / \text{---} \sqrt{\text{ACTION}}$
 - $\text{Voice} \leftrightarrow Xi\tilde{Y}eZ / \text{---} \sqrt{\text{ACTION}}$
 - $\text{Voice}_{[-D]} \leftrightarrow hitXa\tilde{Y}eZ / \text{---} \sqrt{\text{ACTION}}$

As a root, this element has phonological and semantic content but no syntactic features or requirements. Not much hinges on whether this element is a root or a functional head in this language; since it has no syntactic influence but combines predictable phonology with semantics that can be difficult to characterize formally, it behaves like any other root.⁸ The question of what other such “under-specified” roots might exist in natural language remains an open one for further crosslinguistic research.

2.5.1 Syntax

I propose that a transitive verb like *pirek* ‘dismantled’ has the basic structure in (55a), and an unergative verb like *riked* ‘danced around’ has the basic structure in (55b).

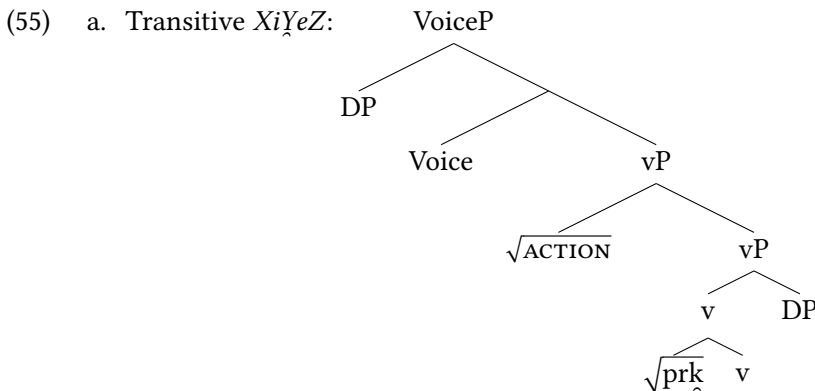

⁷Doron (2003) uses a syntactic head t ; see Section 3.9.1 on some differences between the theories.

⁸For these reasons I do not consider it to be a “flavor” of v , for example.

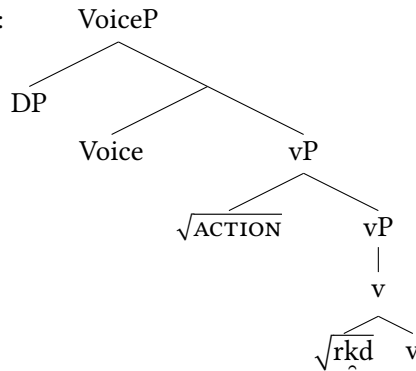
b. Unergative *XiYeZ*:

The agentive modifier forces an agentive reading, otherwise the derivation crashes at LF (Section 1.3.2). An agentive reading requires an external argument, which necessarily requires either a transitive or unergative structure. This much is enough to capture the syntactic distribution of *XiYeZ*.

Consider what this means in terms of alternations. Returning to the examples in Table 2.2, we saw an “intensive” alternation between *favar* ‘broke’ and *fiber* ‘broke to pieces’. Assuming a Layering view of argument structure (Alexiadou et al. 2015), we first build up a core vP consisting of a breaking event:

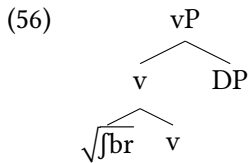

What happens next? The grammar has two options. It can either merge Voice (57a), in which case we get the verb in *XaYaZ*, or it can merge $\sqrt{\text{ACTION}}$ and then Voice (57b), in which case we get the verb in *XiYeZ*.

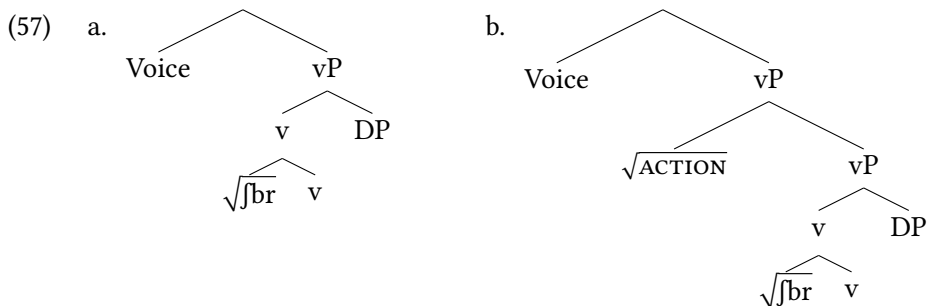

As noted in all of the major works on Hebrew morphology, alternations are not always the norm: there is no guarantee that a verb in *XaYaZ* will alternate

2 Unspecified Voice

with one in $Xi\bar{Y}eZ$, as many verbs in $XaYaZ$ have no counterpart in $Xi\bar{Y}eZ$ (and vice versa). This property is idiosyncratic and must be listed with every root. But when $XaYaZ$ and $Xi\bar{Y}eZ$ do alternate, this is how: if a given root is instantiated in both templates, then the $Xi\bar{Y}eZ$ version will always be an “intensive”, agentive version of the $XaYaZ$ verb, since $Xi\bar{Y}eZ$ is the spell-out of adding a $\sqrt{\text{ACTION}}$ layer to the core event which otherwise would be spelled out as $XaYaZ$.

The derivation of verbs in $Xi\bar{Y}eZ$ which do not alternate with $XaYaZ$ is identical. For (58), we first build up the core vP, then attach $\sqrt{\text{ACTION}}$, and then attach the external argument. The fact that the core vP cannot combine with Voice directly must be listed with the root, in whatever way regulates which functional heads can appear with which root. Now the meaning of the root is chosen by $\sqrt{\text{ACTION}}$, rather than by v (since there is no verb in $XaYaZ$) or Voice (since $\sqrt{\text{ACTION}}$ is closer to the root, Arad 2003; Marantz 2013; Anagnostopoulou & Samioti 2014), however $\sqrt{\text{ACTION}}$ is licensed by the root formally.

- (58) a. * [abaf] ($\sqrt{\text{[bf]}}$ in $XaYaZ$)
 b. **ha-xom** *fibef* et ha-medidot.
 the-heat disrupted.INTNS ACC the-measurements
 ‘The heat messed up the measurements.’
 c.
-
- ```

graph TD
 VoiceP --> DP1[DP
ha-xom]
 VoiceP --> vP1[vP]
 vP1 --> Voice[Voice
i,e]
 vP1 --> vP2[vP]
 vP2 --> sqrtACTION[sqrt(ACTION)]
 vP2 --> vP3[vP]
 vP3 --> v[sqrt[bf] v]
 vP3 --> DP2[DP
et ha-medidot]

```

Again, what “intensive” means is left intentionally vague. A few options are sketched next, after a technical aside about the height of attachment for  $\sqrt{\text{ACTION}}$ .

### 2.5.1.1 Height of attachment

In principle,  $\sqrt{\text{ACTION}}$  could be argued to adjoin to v/vP, Voice or even to the root. The benefit of adjoining it to vP is that the alternations between  $XaYaZ$  and  $Xi\bar{Y}eZ$  follow cleanly, as do those between  $Xi\bar{Y}eZ$  and *hit* $Xa\bar{Y}eZ$ . Here is a preview of

what this looks like, to be further explored in the next chapter. Both causative *pirek* ‘dismantled’ and anticausative *hitparek* ‘dismantled’ are built from the core vP in (59a). If Voice is merged, we get causative *pirek* in *XiYeZ* (59b). If Voice<sub>[-D]</sub> is merged, we get anticausative *hitparek* in *hitXaYeZ* (59c).

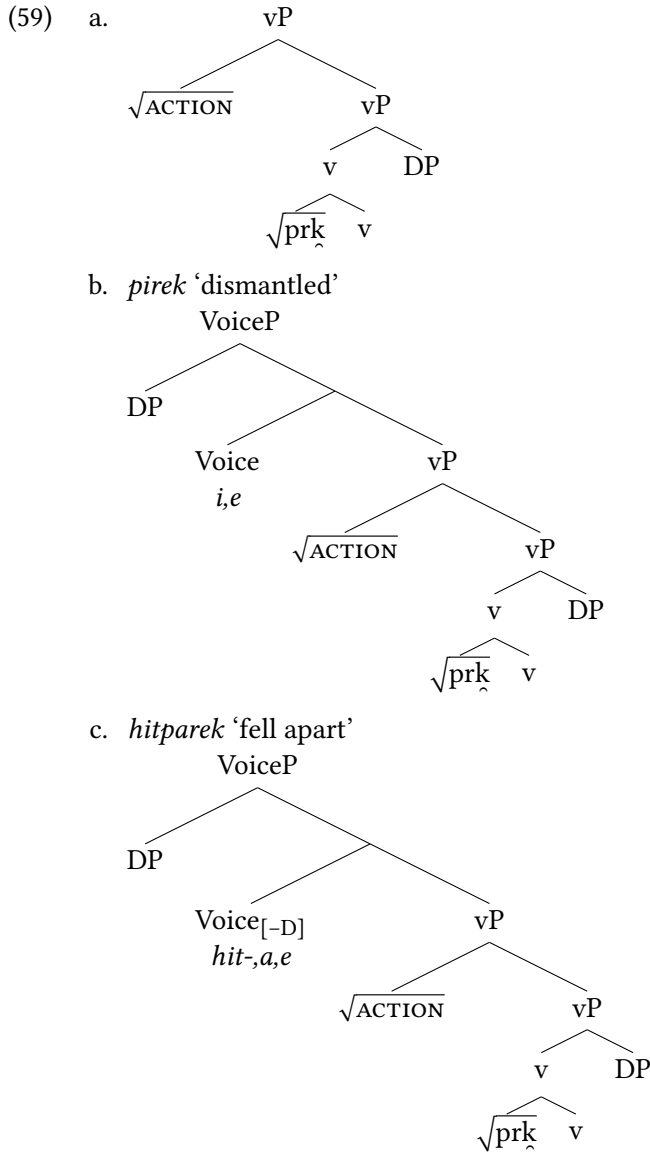

In previous work (Kastner 2016; 2017; 2019b) I assumed that  $\sqrt{\text{ACTION}}$  modifies Voice, and not vP as it does here. There were three reasons for this. The first was

## 2 Unspecified Voice

that placing  $\sqrt{\text{ACTION}}$  between Voice and a higher element such as T correctly derives certain allomorphic patterns under the strict linear adjacency hypothesis for contextual allomorphy (Embick 2010; Marantz 2013), as developed in Kastner (2019b). While I am fond of this argument, much current work argues that this restriction needs to be weakened (see e.g. Kastner & Moskal 2018; Choi & Harley 2019). The second is that adjoining  $\sqrt{\text{ACTION}}$  to Voice renders it similar to Greek *afto*. However, it is not crucial for the theory that these two elements merge in similar locations in different languages. The third is that since  $\sqrt{\text{ACTION}}$  influences the interpretation of the external argument, adjoining it to Voice seemed most appropriate. Yet it is clear that agentive semantics can be generated low: verbs like *murder* and *devour* are strongly agentive (Haspelmath 1993; Levin & Rappaport Hovav 1995; Marantz 1997; Alexiadou et al. 2015), a requirement which originates within the vP (at the root). For these reasons, I now think that  $\sqrt{\text{ACTION}}$  adjoins to vP, although there are no clinching arguments either way.<sup>9</sup> See Ahdout (in prep) for additional benefits of adjoining  $\sqrt{\text{ACTION}}$  to vP in the domain of nominalization.

### 2.5.2 Semantics

Given that  $\sqrt{\text{ACTION}}$  has just been argued to be a root, assigning a semantics to it without a theory of root semantics is difficult. What we can do is see its effects on the external argument, formalized as follows:

- (60)  $\llbracket \text{Voice} \rrbracket =$
- a.  $\lambda P.P$  /  $\_\_ \{ \sqrt{\text{npI}} \text{ '}\sqrt{\text{FALL}}\text{'}, \sqrt{\text{kpa}} \text{ '}\sqrt{\text{FREEZE}}\text{'}, \dots \}$
  - b.  $\lambda x \lambda e. \text{Agent}(x,e)$  or  $\lambda x \lambda e. \text{Causer}(x,e)$
  - c.  $\lambda x \lambda e. \text{Agent}(x,e)$  /  $\_\_ \sqrt{\text{ACTION}}$

While this formalization aims to be explicit, I have taken a few shortcuts. As already argued for by Alexiadou et al. (2015), it is the vP which provides the causative component, not Voice. The formalization in (60) is meant to indicate that both Causers and Agents are compatible with Voice, but that only Agents are possible once  $\sqrt{\text{ACTION}}$  is in the structure.

Let us expand the analysis a bit more: what readings does  $\sqrt{\text{ACTION}}$  make available? Some examples are given in Table 2.3, repeated from Table 2.2. While *XiYeZ* is traditionally called the “intensive” template, it can also house pluractional verbs, d–f, and various others which do not alternate with forms in *XaYaZ*, g–i.

<sup>9</sup>As pointed out to me by Yining Nie (p.c.), adjoining  $\sqrt{\text{ACTION}}$  to Voice would render this combination structurally similar to prepositional roots adjoining to Voice in the *i*\* system of Wood & Marantz (2017), discussed in Section 7.2.2.

Table 2.3: Pretheoretical classification of some verbs in  $Xi\check{Y}eZ$ 

|    | $XaYaZ$               |        |            | $Xi\check{Y}eZ$     |                      |
|----|-----------------------|--------|------------|---------------------|----------------------|
| a. | $\sqrt{fbr}$          | favar  | ‘broke’    | fiber               | ‘broke to pieces’    |
| b. | $\sqrt{jtsr}$         | jatsar | ‘produced’ | jitser              | ‘produced’           |
| c. | $\sqrt{k\grave{l}}$   | axal   | ‘ate’      | ikel                | ‘corroded, consumed’ |
| d. | $\sqrt{hlx}$          | halax  | ‘walked’   | hilex               | ‘walked around’      |
| e. | $\sqrt{rk\grave{d}}$  | rakad  | ‘danced’   | riked               | ‘danced around’      |
| f. | $\sqrt{k\grave{f}ts}$ | kafats | ‘jumped’   | kipets/<br>kiftsets | ‘jumped around’      |
| g. | $\sqrt{tps}$          |        | —          | tipes               | ‘climbed’            |
| h. | $\sqrt{l\grave{t}f}$  |        | —          | litef               | ‘petted’             |
| i. | $\sqrt{k\grave{b}l}$  |        | —          | kibel               | ‘received’           |

The pluractional readings and underived verbs have potentially interesting theoretical consequences, which will be touched on here before moving on to the phonological contribution of  $\sqrt{\text{ACTION}}$ .

### 2.5.2.1 Pluractionality

One possible way to describe the semantics of  $\sqrt{\text{ACTION}}$  is by extended reference to pluractionality. The intuition as it follows. Assume that  $\sqrt{\text{ACTION}}$  is a pluractional (and perhaps also agentive) affix. Building on recent work by Henderson (2012; 2017), pluractionality can be seen as a way of pluralizing an event. This pluralization can hold spatially as well as temporally. For the “intensive” forms in Table 2.3 a–c, the underlying core vP has a direct object. The corresponding pluralized events in  $Xi\check{Y}eZ$  can be individuated with respect to the direct objects, e.g. many broken pieces in “a” or many different simultaneous corrosions of parts of the material’s surface in “c”. This extension is admittedly less obvious for “production” in “b”. Greenberg (2010) makes a similar claim for verbs in  $Xi\check{Y}eZ$  that are derived from reduplicated roots.

For the “pluractional” forms in d–f, the underlying core events are unergative. The pluralizing operation has no direct object to operate on, and so I would suggest that it pluralizes the spatio-temporal event itself in  $Xi\check{Y}eZ$ .

Lastly, in g–i there is no underlying form and hence nothing to pluralize. The resulting verbs are still agentive but not necessarily pluractional.

## 2 Unspecified Voice

This way of thinking about  $Xi\bar{Y}eZ$  is speculative at this point. A number of potential counterexamples can be conjured up fairly easily. These are cases where the alternation does not plausibly result in a plural event:

- (61) a. *lamad* ‘learned’ ~ *limes* ‘taught’  
b. *ratsa* ‘wanted’ ~ *ritsa* ‘satisfied’

In the examples in (61) the event does not entail change of state, unlike with breaking and eating/corroding. So perhaps there is a tripartite division of roots to be made, as follows:

- (62) a. *Other-oriented roots (change of state)* such as  $\sqrt{\text{BREAK}}$  and  $\sqrt{\text{PRODUCE}}$ : pluralization of the object.  
b. *Activity roots or self-oriented roots* such as  $\sqrt{\text{RUN}}$  and  $\sqrt{\text{JUMP}}$ : pluralization of the spatio-temporal aspects of the event.  
c. *Other cases*: no pluralization.

Since our current focus is not on the lexical semantics of root classes and how they integrate into the syntax, I will leave proper testing of the hypothesis in (62) for future work. Evaluating this proposal will need to proceed along the lines laid out above, testing whether each root instantiated in this template does indeed fit into one of the three cases in (62).

### 2.5.2.2 Underived forms

A number of verbs in  $Xi\bar{Y}eZ$  stretch the notion of “agentivity” to the point where even a weak definition is no longer tenable. In the examples in (63), the verb can hardly be described as agentive since the subject is inanimate, while in (64) the subject is animate but non-volitional. These verbs are compatible with agentive subjects as well, but clearly do not require them.

- (63) a. **ha-midgam** *fikef* et totsot ha-emet.  
the-poll reflected.INTNS ACC results.of the-truth  
‘The polls (correctly) reflected the results.’
- b. be-ritsa axat **ha-jaon** fel garmin kimat *diek* kaafer  
in-run one the-watch of Garmin almost was.accurate.INTNS when  
hetsig stia kimat xasrat mafmaut fel axuz ve-ktsat.  
showed deviation almost devoid.of meaning of percent and-little  
‘In one run, the Garmin watch was precise as it showed an almost insignificant deviation of just over one percent.’ [www.haaretz.co.il/sport/active/.premium-1.2309128](http://www.haaretz.co.il/sport/active/.premium-1.2309128)

- (64) **ha-kadurselan-it**      *kibl-a*                      maka xazaka ba-regel.  
 the-basketball.player-F received.INTNS-F hit    strong in.the-leg  
 ‘The basketball player got hit hard in the leg.’

In these examples an external argument is still required, regardless of whether it can felicitously be called an agent or not. What these examples show is that a rigid denotation of  $\sqrt{\text{ACTION}}$  is difficult to specify, beyond some general notion of a direct cause. I believe it is significant, though, that the verbs in (63–64) do not have corresponding forms in *XaYaZ*: *fikef*  $\not\leftarrow$  \**fakaf*, *diek*  $\not\leftarrow$  \**dajak*, *kibel*  $\not\leftarrow$  \**kabal* and *fibef*  $\not\leftarrow$  \**fabaf* from earlier. They would fit with the underived group of Table 2.3 g–i: generated when  $\sqrt{\text{ACTION}}$  selects the meaning of the root directly without having to agentivize an event in *vP/XaYaZ*. If  $\sqrt{\text{ACTION}}$  really is a root rather than a functional head, its partially unpredictable contributions to the meaning of the verb are not unexpected.

### 2.5.3 Phonology

The morphophonology of *XiYeZ* consists of two parts that distinguish it from other templates: different stem vowels and the way it bleeds a regular phonological process of spirantization. In Modern Hebrew, /p/, /b/ and /k/ spirantize to [f], [v] and [x] postvocally (Adam 2002; Temkin Martínez 2008; Gouskova 2012), a process that applies to nonce words as well (Temkin Martínez & Müllner 2016). An example of this process was seen above in (39a–b), where /b/ spirantizes to [v] after a vowel except if  $\sqrt{\text{ACTION}}$  is also in the structure. The inflectional paradigm for *XiYeZ* in three tenses is given in Table 2.4.

Table 2.4: Inflectional paradigm for *XiYeZ*

|     | Past             |                    | Present           |                    | Future                  |                  |
|-----|------------------|--------------------|-------------------|--------------------|-------------------------|------------------|
|     | M                | F                  | M                 | F                  | M                       | F                |
| 1SG |                  | <i>XiYaZ-ti</i>    | <i>me-XaYeZ</i>   | <i>me-XaYeZ-et</i> | <i>a-XaYeZ/je-XaYeZ</i> |                  |
| 1PL |                  | <i>XiYaZ-nu</i>    | <i>me-XaYZ-im</i> | <i>me-XaYZ-ot</i>  | <i>ne-XaYeZ</i>         |                  |
| 2SG | <i>XiYaZ-ta</i>  | <i>XiYaZ-t</i>     | <i>me-XaYeZ</i>   | <i>me-XaYeZ-et</i> | <i>te-XaYeZ</i>         | <i>te-XaYZ-i</i> |
| 2PL | <i>XiYaZ-tem</i> | <i>XiYaZ-ten/m</i> | <i>me-XaYZ-im</i> | <i>me-XaYZ-ot</i>  | <i>te-XaYZ-u</i>        |                  |
| 3SG | <i>XiYeZ</i>     | <i>XiYZ-a</i>      | <i>me-XaYeZ</i>   | <i>me-XaYeZ-et</i> | <i>je-XaYeZ</i>         | <i>te-XaYeZ</i>  |
| 3PL |                  | <i>XiYZ-u</i>      | <i>me-XaYZ-im</i> | <i>me-XaYZ-ot</i>  | <i>je-XaYZ-u</i>        |                  |

VIs can be assigned similarly to how this was done for Unspecified Voice in Section 2.3.3. The difference is that since  $\sqrt{\text{ACTION}}$  is adjacent to Voice, it can

## 2 Unspecified Voice

condition allomorphy of the vowels; this is what we see in Table 2.4, where the stem vowels are different for  $Xi\check{Y}eZ$  than for  $XaYaZ$ . However,  $Xi\check{Y}eZ$  is separated from T by overt Voice (the vowels), so the agreement affixes are correctly predicted to be identical across the templates.

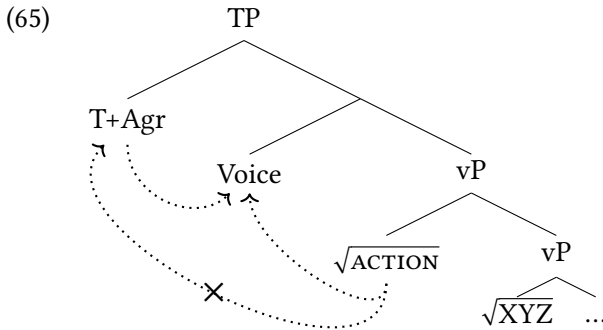

The non-spirantization can be analyzed as a floating feature docking onto the medial root consonant and preventing it from acquiring a [continuant] feature. Two basic VIs are given in (66), where the floating feature still needs a constraint to dock it onto the right segment; see Kastner (2019b) for the full implementation.

- (66) a. Voice  $\leftrightarrow$   $i, e / T[\text{Past}] \text{ \_\_ } \sqrt{\text{ACTION}}$   
 b.  $\sqrt{\text{ACTION}} \leftrightarrow [-\text{cont}]_{\text{ACT}} / \text{ \_\_ } \{ \sqrt{\text{XYZ}} \mid Y \in \text{p, b, k} \}$

## 2.6 Summary and outlook

This chapter examined the two templates  $XaYaZ$  and  $Xi\check{Y}eZ$ , treating them not as morphemic atoms but as combinations of functional heads, specifically  $v$ , Voice, and (in the case of  $Xi\check{Y}eZ$ )  $\sqrt{\text{ACTION}}$ . The following generalizations about the argument structure of both templates are repeated here from (16) and (42).

- (67) Generalizations about  $XaYaZ$
- Configurations:* Verbs appear in all possible argument structure configurations.
  - Alternations:*  $XaYaZ$  participates in alternations with the other templates, as will be reviewed throughout the book.
- (68) Generalizations about  $Xi\check{Y}eZ$
- Configurations:* Verbs appear in active (transitive/unergative) configurations. Readings are weakly agentive.
  - Alternations:* When alternating with  $XaYaZ$ ,  $Xi\check{Y}eZ$  provides a more “intensive” or agentive version.



To account for these patterns, I began to unfold the proposed theory of Trivalent Voice. This chapter concentrated on two elements: Unspecified Voice does not impose any strict constraints in the syntax but is nevertheless traceable in the morphophonology. It is compatible with whatever argument structure the root allows. The modifier  $\sqrt{\text{ACTION}}$  enforces certain agentive or agentive-like readings which, I have argued, can be found in various other languages as well. Both elements are overt.

The next chapters of Part I examine the other templates, motivating an analysis which uses different values of Voice. In Chapter 3 we will see what happens when Voice is endowed with a [-D] feature, prohibiting the merger of DPs in its specifier. The result will be a structure that allows anticausatives and, in some cases, reflexives of different kinds. In Chapter 4 we will see the consequences of a [+D] feature appearing on Voice, requiring its specifier to be filled. And in Chapter 5 we will see how these Voice heads interact with passivization, nominalization and adjectivization.



## 3 Voice<sub>[-D]</sub>

### 3.1 Introduction

In the previous chapter we saw how one morphological form in Hebrew is associated with various argument structure configurations: verbs in  $XaYaZ$  might be unaccusative, unergative, transitive or ditransitive, depending on the root. The theory developed in this book attributes this freedom to the behavior of (Unspecified) Voice, which at least in Hebrew is not specified with regard to the existence of an external argument or lack of one. We have also seen how an agentive modifier can influence possible readings of the verb. In this chapter and in the next we will consider cases in which a different value of Voice is merged, leading to specific consequences for the syntax, semantics and phonology of the resulting verb. In terms of the morphology, we will see alternations in which the same root is instantiated in different templates.

The current chapter motivates the non-active head Voice<sub>[-D]</sub>. Informally, Voice<sub>[-D]</sub> rules out the addition of an external argument. In the simplest case, this configuration leads to argument structure alternations as in Table 3.1, where the anticausative variants are essentially marked with non-active morphology. The two templates explored in this chapter are  $niXYaZ$  and  $hitXa\check{Y}eZ$ , on the right-hand side of each row in the table.

Table 3.1: Two pairs of alternations

| Templates                             | Root                          | Causative                  | Anticausative                 |
|---------------------------------------|-------------------------------|----------------------------|-------------------------------|
| $XaYaZ \sim niXYaZ$                   | $\sqrt{fbr}$                  | <i>favar</i> ‘broke’       | <i>nifbar</i> ‘got broken’    |
|                                       | $\sqrt{\overset{\wedge}{kr}}$ | <i>kara</i> ‘tore’         | <i>nikra</i> ‘got torn’       |
|                                       | $\sqrt{mtx}$                  | <i>matax</i> ‘stretched’   | <i>nimtax</i> ‘got stretched’ |
| $Xi\check{Y}eZ \sim hitXa\check{Y}eZ$ | $\sqrt{prk}$                  | <i>pirek</i> ‘dismantled’  | <i>hitparek</i> ‘fell apart’  |
|                                       | $\sqrt{ptsts}$                | <i>potsets</i> ‘detonated’ | <i>hitpotsets</i> ‘exploded’  |
|                                       | $\sqrt{bjl}$                  | <i>bifel</i> ‘cooked’      | <i>hitbafel</i> ‘got cooked’  |

The idea that non-active marking tracks intransitive morphology is certainly not new, nor is the technical innovation of a non-active variant of Voice: Schäfer (2008) and Alexiadou et al. (2015) have most notably made the case for a system contrasting Voice with non-active (“expletive” or “middle”) Voice, and I will return to a direct comparison with that theory in Chapter 6. What this chapter aims to achieve is a number of interrelated goals, as already practiced in the previous chapter: to provide a thorough description of the facts, to motivate a particular analysis, and to highlight points of divergence from existing work in preparation for the discussion in the second part of this book.

This chapter is the longest in the book, encompassing three different syntactic configurations and at least four semantic interpretation possibilities across two morphophonological templates. The names I have given these constructions are intended to be transparent and easy to compare with work on other languages. With that in mind, the richness of the system could also be confusing. What is important in terms of the big picture is that the two kinds of vPs discussed so far (one with  $\sqrt{\text{ACTION}}$  and one without it) can merge with the non-active head *Voice*<sub>[-D]</sub>, and not just with regular Voice as in the previous chapter. In addition, there is a prepositional counterpart to this head, namely *p*<sub>[-D]</sub>, which derives another kind of construction – the figure reflexive. And finally, pure reflexives are only possible when  $\sqrt{\text{ACTION}}$  is in the structure. Table 3.2 provides a preview.

Table 3.2: Verbs with [-D]

| Construction |                  | <i>niXYaZ</i>                | <i>hitXaYeZ</i>                                       |
|--------------|------------------|------------------------------|-------------------------------------------------------|
| Non-active   | Anticausative    | <i>Voice</i> <sub>[-D]</sub> | $\sqrt{\text{ACTION}}$ , <i>Voice</i> <sub>[-D]</sub> |
|              | Inchoative       | <i>Voice</i> <sub>[-D]</sub> | $\sqrt{\text{ACTION}}$ , <i>Voice</i> <sub>[-D]</sub> |
|              | Passive          | <i>Voice</i> <sub>[-D]</sub> | –                                                     |
| Active       | Figure reflexive | <i>p</i> <sub>[-D]</sub>     | $\sqrt{\text{ACTION}}$ , <i>p</i> <sub>[-D]</sub>     |
| Reflexive    | Reflexive        | –                            | $\sqrt{\text{ACTION}}$ , <i>Voice</i> <sub>[-D]</sub> |

These constructions are explored as follows. In Section 3.2 I identify the anticausatives, inchoatives and figure reflexives of *niXYaZ* (this last group underwriting a novel generalization). Section 3.3 analyzes the first two and Section 3.4 analyzes figure reflexives. Section 3.5 briefly summarizes the picture for *niXYaZ*. I then move to the right-hand side of the table, *hitXaYeZ*, in Section 3.6, and its analysis in Section 3.7: anticausatives, inchoatives and reflexives are analyzed in

Section 3.7.1; figure reflexives are discussed in Section 3.7.2. The empirical and analytical picture is recapped in Section 3.8. Section 3.9 then compares the Trivalent approach with other treatments in the literature, at which point I take stock and preview the next chapter.

## 3.2 *niXYaZ*: Descriptive generalizations

The so-called “middle” template *niXYaZ* is traditionally viewed as a passive one. This is a mischaracterization. While it is true that many verbs in *niXYaZ* have passive readings, these verbs are often mediopassive, compatible with a passive or anticausative reading. Furthermore, a large group of verbs in *niXYaZ* have decidedly different syntactic and semantic behavior: they are active verbs, FIGURE REFLEXIVES in the terminology of Wood (2014). I lay out both classes of verbs and the diagnostics used to classify them. Their uniform morphology will receive a non-uniform syntactic analysis in Sections 3.3 and 3.4.

### 3.2.1 Non-active verbs

Most verbs in *niXYaZ* have PASSIVE readings in that they are the passive variant of an active verb in *XaYaZ*. This is the majority group of verbs in *niXYaZ* and probably the reason why the template is traditionally viewed as passive. A few examples are given on the right-hand side of Table 3.3.

Table 3.3: Examples of passives in *niXYaZ*

| Root  | <i>XaYaZ</i> Causative     | <i>niXYaZ</i> Anticausative   |
|-------|----------------------------|-------------------------------|
| √'mr  | <i>amar</i> ‘said’         | <i>neemar</i> ‘was said’      |
| √bxn  | <i>baxan</i> ‘examined’    | <i>nivxan</i> ‘was examined’  |
| √rtsx | <i>ratsax</i> ‘murdered’   | <i>nirtsax</i> ‘was murdered’ |
| √kb̂  | <i>kava</i> ‘set, decided’ | <i>nikba</i> ‘was decided’    |

This section also concerns verbs like those on the right-hand side of 3.4, which I call ANTICAUSATIVE. Intuitively, these are verbs which convey the unaccusative variant of an existing active or stative verb in *XaYaZ*.

The forms in Tables 3.3 and 3.4 are unambiguous, in that e.g. *neemar* ‘was said’ does not pass the anticausativity tests described below, only the passive ones. However, many verbs are AMBIGUOUS between the two readings, like those in Table 3.5.

Table 3.4: Examples of anticausatives in *niXYaZ*

| Root                             | <i>XaYaZ</i> verb          | <i>niXYaZ</i> Anticausative |
|----------------------------------|----------------------------|-----------------------------|
| $\sqrt{\text{gm}\bar{\text{r}}}$ | <i>gamar</i> ‘finished up’ | <i>nigmar</i> ‘ended’       |
| $\sqrt{\text{dl}\bar{\text{k}}}$ | <i>dalak</i> ‘was lit’     | <i>nidlak</i> ‘lit up’      |
| $\sqrt{\text{tk}^{\wedge}}$      | <i>taka</i> ‘jammed’       | <i>nitka</i> ‘got stuck’    |

Table 3.5: Examples of ambiguity between anticausative and passive in *niXYaZ*

| Root                               | <i>XaYaZ</i> verb      | <i>niXYaZ</i> Anticausative            |
|------------------------------------|------------------------|----------------------------------------|
| $\sqrt{\text{fbr}}$                | <i>favar</i> ‘broke’   | <i>nifbar</i> ‘broke / got broken’     |
| $\sqrt{\text{sg}\bar{\text{r}}}$   | <i>sagar</i> ‘closed’  | <i>nisgar</i> ‘closed / got closed’    |
| $\sqrt{\text{m}^{\wedge}\text{k}}$ | <i>maax</i> ‘squished’ | <i>nimax</i> ‘squished / got squished’ |

But this section also concerns verbs like those on the right-hand side of Table 3.6. These INCHOATIVES do not alternate with a variant in *XaYaZ*.

Table 3.6: Examples of inchoatives in *niXYaZ*

| Root                | <i>XaYaZ</i> Causative | <i>niXYaZ</i> Inchoative     |
|---------------------|------------------------|------------------------------|
| $\sqrt{\text{rdm}}$ | —                      | <i>nirdam</i> ‘fell asleep’  |
| $\sqrt{\text{lm}}$  | —                      | <i>neelam</i> ‘disappeared’  |
| $\sqrt{\text{kxd}}$ | —                      | <i>nikxad</i> ‘went extinct’ |

Out of 415 verbs in *niXYaZ* classified by Ahdout & Kastner (2019), 275 have only passive readings, 196 have only anticausative or inchoative readings, and 88 are ambiguous (leading to totals above 415). I will return to the quantitative summary in Section 3.2.3.

In what follows, I apply the diagnostics introduced in Section 2.2.2: compatibility with Agent-oriented adverbs (Section 3.2.1.1) and the two unaccusativity tests, VS order and the possessive dative (Section 3.2.1.2). I also make use of diagnostics particular to passive configurations. All of the tests are consistent with the claim that the verbs classified as anticausative and inchoative have no Agent, hence are unaccusative, and that the verbs classified as passives have an implicit Agent (or an explicit *by*-phrase Agent).

## 3.2.1.1 Adverbial modifiers

Agent-oriented adverbs are incompatible with anticausatives (1) but possible with passives in the passive templates (2a) and in *niXYaZ* (2b).

- (1) a. \* ha-tsamid *nifbar* be-mejomanut  
 the-bracelet broke.MID in-skill  
 (int. ‘The bracelet was dismantled skillfully’)
- b. ?? dana *nirdem-a* be-xavana.  
 Dana fell.asleep.MID-F on-purpose  
 (int. ‘Dana fell asleep on purpose’)
- (2) a. ha-faon *porak* be-zehirut.  
 the-watch dismantled.INTNS.PASS in-caution  
 ‘The watch was dismantled carefully.’
- b. ha-hatsaa *nivxen-a* be-xafaf.  
 the-suggestion.F examined.MID-F in-fear  
 ‘The suggestion was considered cautiously.’

Anticausatives are also incompatible with *by*-phrases, which would otherwise refer to an Agent (3). These are naturally possible with passives (4).

- (3) a. \* ha-tsamid *nifbar* al-jedej ha-tsoref  
 the-bracelet broke.MID by the-jeweler  
 (int. ‘The bracelet was dismantled by the jeweler’)
- b. \* dana *nirdem-a* al-jedej {ha-xom / ha-kosem-et}  
 Dana fell.asleep.MID-F by the-heat the-magician-F  
 (int. ‘Dana fainted/fell asleep due to the heat/due to the magician’)
- (4) a. ha-faon *porak* al-jedej ha-tsoref.  
 the-watch dismantled.INTNS.PASS by the-jeweler  
 ‘The watch was dismantled by the jeweler.’
- b. ha-mitmodedim *nivxen-u* al-jedej ha-fofetet.  
 the-contestants examined.MID-PL by the-referee  
 ‘The contestants were judged by the referee.’

The ‘by itself’ test can be assumed to diagnose the non-existence of an external argument, regardless of whether the external argument is explicit (as in transitive verbs) or implicit (as in passives). The test is valid with anticausatives and inchoatives, (5), but not with direct objects of transitive verbs, (6a), or with passive verbs, (6b).

### 3 Voice<sub>[-D]</sub>

- (5) a. ha-kise *nifbar* me-atsmo.  
the-chair broke.MID from-itself  
'The chair fell apart (of its own accord).'
- b. ha-klavlav *nirdam* me-atsmo.  
the-puppy fell.asleep.MID from-itself  
'The puppy fell asleep of his own accord.'
- (6) a. \* miri *favr-a* et ha-kise me-atsmo.  
Miri broke.SMPL-F ACC the-chair from-itself  
(int. 'Miri broke the chair of its own accord')
- b. \* moed ha-bxina *nikba* me-atsmo.  
date.of the-exam decided.MID from-itself  
(int. 'The date of the exam was set of its own accord')

And as expected, passives allow control by the implied external argument (see Williams 2015 and Bhatt & Pancheva 2017 for qualifications to this test):

- (7) ha-delet *nisger-a* kedej **limnoa** me-ha-xatul lehikanes  
the-door closed.MID-F.SG in.order to.prevent from-the-cat to.enter.MID  
la-xeder.  
to.the-room  
'The door was closed to prevent the cat from entering the room.'

The tests thus far indicate that anticausatives and inchoatives in *niXYaZ* do not have an external argument, while passives do.

#### 3.2.1.2 Unaccusativity diagnostics

Anticausatives and inchoatives in *niXYaZ* allow VS order:

- (8) a. *nigmer-a* kol ha-bamba.  
ended.MID-F all the-bamba  
'The bamba snack ran out.'
- b. *neelm-u* me-ha-sifrija floja kraxim fel britanika.  
disappeared.MID-3PL from-the-library three volumes of Britannica  
'Three volumes of Encyclopedia Britannica disappeared from the  
library.' (Shlonsky 1987: 142)

As noted by Shlonsky (1987: 148), VS order with passives is generally fine but less so when the Agent is specified.



- (9) *neexal* le-ruti ha-kiwi (\*al-jedej ha-xatul).  
ate.MID to-Ruti the-kiwi by the-cat  
'Ruti's kiwi was eaten.'

Anticausative and inchoative verbs in *niXYaZ* are compatible with the possessive dative, again because it presumably targets the internal argument.

- (10) a. *nifbar* l-i ha-jaon.  
broke.MID to-me the-watch  
'My watch broke.'  
b. *nirdam* l-i ha-kelev al ha-regel, ma laasot?  
fell.asleep.MID to-me the-dog on the-leg what to.do  
'My dog fell asleep on my lap, what should I do?'

Taken together, these tests establish that anticausatives and inchoatives are unaccusative but the passive verbs are not (since the latter disallow 'by itself'). A common assumption in the Hebrew literature is that verbs in this template are all non-active, but we will next consider another class of verbs in *niXYaZ*, the figure reflexives, which behave differently with regard to these tests.

### 3.2.2 Figure reflexives

It has been commonly assumed that verbs in *niXYaZ* are medio-passive (non-active), but it can be shown that there is another class of verbs in this template whose properties are quite different. These verbs do have an external argument and also take an obligatory prepositional phrase as their complement. Whereas a typical prepositional phrase has a Figure and a Ground, roughly the subject and object of the preposition (Section 1.4.3), in these verbs the Figure is not explicitly named as a separate argument. It is, however, coreferential with the Agent of the verb. Verbs like these are called FIGURE REFLEXIVES, which is the term coined by Wood (2014) for a similar phenomenon in Icelandic. The name itself is meant to invoke the Figure-like, reflexive-like interpretation of a Figure in a prepositional phrase when it is the complement of certain verbs.

Figure reflexives in *niXYaZ* include verbs such as those in Table 3.7; all require a PP complement. Based on the diagnostics discussed here, Ahdout & Kastner (2019) found that 74 of the 415 verbs in *niXYaZ* are figure reflexive, or ambiguous between a non-active and a figure reflexive reading. Some of these verbs are fairly recent (e.g. *nirfam le-* 'signed up for'), indicating that we are not dealing simply with a long list of lexicalized exceptions. Nevertheless, this class of verbs was not recognized prior to Kastner (2016), as far as I can tell.

Table 3.7: Examples of figure reflexives in *niXYaZ*

|    |               |                       |                               |
|----|---------------|-----------------------|-------------------------------|
| a. | <i>nixnas</i> | *( <i>le-</i> )       | ‘entered (into)’              |
| b. | <i>nidxaf</i> | *( <i>derex/le-</i> ) | ‘pushed his way through/into’ |
| c. | <i>nirfam</i> | *( <i>le-</i> )       | ‘signed up for’               |
| d. | <i>nilxam</i> | *( <i>be-</i> )       | ‘fought (with)’               |
| e. | <i>neexaz</i> | *( <i>be-</i> )       | ‘held on to’                  |

I will repeat the diagnostics from Sections 3.2.1.1 and 3.2.1.2 – showing that figure reflexives pattern the opposite way from non-actives – before proceeding to discuss the complement to the verb.

### 3.2.2.1 Adverbial modifiers

Agent-oriented adverbs are possible with figure reflexives:

- (11) *dana nixnes-a la-kita be-bitaxon.*  
 Dana entered.MID-F to.the-classroom in-confidence  
 ‘Dana confidently entered the classroom.’

‘By itself’ is not possible with figure reflexives:

- (12) \* *dana nixnes-a la-xeder me-atsma/me-atsmo*  
 Dana entered.MID-F to.the-room from-herself/itself

*By*-phrases are an irrelevant diagnostic when the external argument is explicit.

### 3.2.2.2 Unaccusativity diagnostics

Figure reflexives fail the accepted unaccusativity diagnostics, unlike non-active verbs in *niXYaZ*. *VS order* is unavailable, again being grammatical but resulting in “stylistic inversion”:

- (13) # *nixnes-u falof xajal-ot la-kita.*  
 entered.MID-3PL three soldiers-F.PL to.the-classroom  
 (int. ‘Three soldiers entered the classroom.’)

The *possessive dative* is likewise incompatible with figure reflexives; example (14) is infelicitous on a reading where the cat is the speaker’s.

- (14) # ha-xatul *nixnas* l-i la-xeder (kol ha-zman), ma laasot?  
 the-cat enters.MID to-me to.the-room (all the-time) what to.do  
 (int. 'My cat keeps coming into into my room, what should I do?')

Shlonsky (1987: 134) provided the pair in (15), noting in a footnote that *lehikans* 'to enter' is not unaccusative (an observation he credited Hagit Borer with), but he did not pursue the matter further.

- (15) a. \* be-emtsa ha-seret *nixnes-u* li jeladim raafanim  
 in-middle.of the-movie entered.MID-F to.me children noisy  
 (int. 'In the middle of the movie (there) entered noisy children and it aggravated me')
- b. be-emtsa ha-seret *nikre-u* li ha-mixnasaim.  
 in.middle.of the-movie tore.MID-F to.me the-pants.PL  
 'In the middle of the movie my pants tore.'

This brief series of tests indicates that the subject of figure reflexives is a true agent, unlike the non-actives which share the same morphology.<sup>1</sup> That is one main difference. The second is the complement of these verbs, as I discuss next.

### 3.2.2.3 Indirect objects

The novel observation is that figure reflexives take an obligatory prepositional phrase, as seen previously in Table 3.7. Importantly, the PP complements for these verbs cannot be left out. For example, omitting the PP from (11) above results in ungrammaticality, (16a).

- (16) Prepositional phrase complements (indirect objects) to figure reflexives are obligatory:
- a. dana *nixnes-a* \*(la-kita).  
 Dana entered.MID-F to.the-classroom  
 'Dana confidently entered the classroom.'
- b. ahed *nilxem-a* \*(be-avlot).  
 Ahed fought.MID-F in-wrongs  
 'Ahed fought wrongdoings.'

<sup>1</sup>It is unclear to what extent the episodic plural is compatible with figure reflexives:

- (i) ?? *nixnas-im* pitom la-ulam!  
 enter.MID.PRS-PL.M suddenly to.the-hall!  
 (int. 'People are entering the hall all of a sudden!')

This claim has not been made before in either the traditional grammars or contemporary work, as far as I know (the closest are Berman 1978: 87, who stated that some verbs show “ingression”, and Schwarzwald 2008, who noted that some verbs in this template are active).<sup>2</sup> Hagit Borer (p.c.) notes that (17) is fine with no overt complement, even though I claim that the PP is obligatory:

- (17) *tafsik* le-hidaxef!  
 stop.CAUS to-push.MID.INF  
 ‘Stop pushing (your way in)!’

This example has the main verb in the imperative (or rather, in the future form, which is used for the imperative reading of most verbs in Modern Hebrew; cf. Bat-El 2002). I suspect that this is a general pattern because in English, too, obligatory complements can be dropped in imperatives:

- (18) a. Itamar nagged \*(Archie).  
 b. Quit nagging!

The resulting generalization is that external arguments in *niXYaZ* are possible if and only if a prepositional phrase is required. In Section 3.4 I show how this generalization can be derived from the structure.

### 3.2.3 Interim summary: *niXYaZ*

Verbs in *niXYaZ* can be classified according to their syntactic behavior and derivational relationship to other verbs. Anticausatives, inchoatives and passives are non-active; figure reflexives are active. Passives have an implied external argument, while anticausatives and inchoatives do not. And of these two, only anticausatives stand in an alternation with a verb in *XaYaZ*. Looking at things structurally, anticausatives and inchoatives are unaccusative (no external argument); passives are passive (implied external argument); and figure reflexives are unergative (require an external argument).

Based on the diagnostics above, Ahdout & Kastner (2019) were able to classify 415 verbs with a high degree of certainty (out of 462 in total), with the breakdown in Table 3.8.<sup>3</sup> It can be seen from the first row, for example, that 91 verbs in *niXYaZ* have only unaccusative readings, like those in Table 3.4. Since some verbs are ambiguous between a number of readings like those in Table 3.5, the total number of verbs with an unaccusative reading is 196 (first column). These numbers are not given here as part of any quantitative claim, only to demonstrate that all

<sup>2</sup>See Neeleman (1997) for PP complements in Dutch and English.

<sup>3</sup>These findings are the result of work by Odelia Ahdout as part of Ahdout (in prep).

### 3.2 *niXYaZ*: Descriptive generalizations

classes are well-attested in the language (but without factoring anything like token frequency into the equation). Additional examples can be found in Ahdout & Kastner (2019).

Table 3.8: Readings for verbs in *niXYaZ*

|                        | Construction |         |                  | N   | %    |
|------------------------|--------------|---------|------------------|-----|------|
|                        | Unacc        | Passive | Figure reflexive |     |      |
| Only unaccusative      | +            | –       | –                | 91  | 21.9 |
| Only mediopassive      | +            | +       | –                | 78  | 18.8 |
| Only passive           | –            | +       | –                | 172 | 41.4 |
| Only Figure reflexive  | –            | –       | +                | 32  | 7.7  |
| Ambiguous unacc/unerg  | +            | –       | +                | 17  | 4.1  |
| Ambiguous pass/unerg   | –            | +       | +                | 15  | 3.6  |
| Three-way ambiguous    | +            | +       | +                | 10  | 2.4  |
| Total per construction | 196          | 275     | 74               |     |      |

Before concluding the empirical exposition of *niXYaZ*, a few counterexamples should be noted. As far as I could find, these are the only verbs which do not fit cleanly into the classes surveyed above. There are two verbs of emission, *neenax* and *neenak*, both of which mean ‘sighed, groaned, moaned’. Verbs of emission are generally unergative in Hebrew (Siloni 2012; Gafter 2014b) but these verbs do not take a PP complement. The two verbs *nizak* and *nexpaz* ‘rushed, hurried’ take a clausal complement, probably a TP, rather than a PP. See Kastner (2016: 126) for brief discussion and speculation. And the verb *nexgar* ‘buckled up’ seems to have a purely reflexive reading, rather than non-active or figure reflexive.

These points for further research aside, the generalizations about *niXYaZ* are as follows. In terms of the constructions we see associated with this template, we have found all manner of non-active verbs as well as figure reflexives. What we never find in this template is simple transitive structures consisting of a subject, verb and direct object. There are also no purely reflexive verbs (this will contrast with *hitXaYeZ* later in the chapter). In terms of alternations, many active (and stative) verbs in *XaYaZ* have a non-active alternation with *niXYaZ*. A summary of these points is presented in (19).

### 3 Voice<sub>[-D]</sub>

(19) Generalizations about *niXYaZ*

- a. *Configurations*: Verbs appear in unaccusative, passive and figure reflexive structures, but never in a simple transitive configuration.
- b. *Alternations*: Some verbs are anticausative or passive versions of verbs in *XaYaZ*.

The non-active verbs are analyzed next, in Section 3.3. Figure reflexives are analyzed in Section 3.4.

### 3.3 Voice<sub>[-D]</sub>

In order to explain the behavior of non-active verbs in *niXYaZ* I propose the head Voice<sub>[-D]</sub>. This non-active variant of Unspecified Voice is defined in brief in (20). The syntax of Voice<sub>[-D]</sub> is similar to that of “middle Voice”, “non-active Voice”, “expletive Voice” or Voice<sub>∅</sub> of much related work in that it does not license a specifier (Lidz 2001; Schäfer 2008; Alexiadou & Doron 2012; Alexiadou et al. 2015; Bruening 2013; Wood 2015; Myler 2016; Kastner & Zu 2017). Its semantics does not introduce an open Agent role, and the Vocabulary Item spelling it out manifests as the template *niXYaZ*, and not as *XaYaZ*. The rest of this section engages more directly with the syntax, semantics and phonology of this element. In Section 3.7.1 I will refine the picture slightly by explaining what happens when  $\sqrt{\text{ACTION}}$  is added to the structure.

(20) Voice<sub>[-D]</sub>

- a. A Voice head with a [-D] feature, prohibiting anything with a [D] feature from merging in its specifier. As typically assumed for unaccusative little *v* or unaccusative Voice, Voice<sub>[-D]</sub> does not assign accusative case either itself by feature checking (Chomsky 1995) or through the calculation of dependent case (Marantz 1991).

$$b. \llbracket \text{Voice}_{[-D]} \rrbracket = \begin{cases} \lambda P \lambda e \exists x. \text{Agent}(x,e) \ \& \ P(e) & / \{ \sqrt{\text{rtsx}} \text{ ‘murder’}, \sqrt{\text{mr}} \text{ ‘say’}, \dots \} \\ \lambda P_{\langle s,t \rangle}. P & \end{cases}$$

- c. Voice<sub>[-D]</sub> ↔ *niXYaZ*  
(with the allomorph *hitXaŸeZ* to follow in Section 3.7.1)

This basic distinction between Voice and Voice<sub>[-D]</sub> in the syntax thus feeds differences across the interfaces: the spell-out is different, the semantics is different and the syntax of the resulting constructions is different.

## 3.3.1 Syntax

Voice and Voice<sub>[-D]</sub> function in a way familiar from the work cited above. External arguments are not referenced in the core vP; the position they are merged in (Spec, VoiceP) is licensed by Voice in the syntax and their thematic role (Agent) is introduced by Voice in the semantics. What this means is that a vP is a predicate of events (potentially transitive ones) with no inherent reference to the thematic role of Agent stemming from the syntax.

Continuing with an example from the previous chapter, we have seen that the verb *favar* ‘broke’ in *XaYaZ* is made up of a vP, denoting a set of breaking events, and the head Voice that introduces an external argument, (21).

(21) *XaYaZ*, *favar* ‘broke’

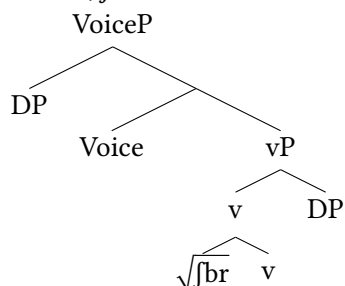

Merging Voice<sub>[-D]</sub> instead of Voice should give us the same basic breaking event with no external argument, since Voice<sub>[-D]</sub> does not allow a DP to be merged in its specifier. These are precisely the *anticausatives*: verbs which differ minimally from their active alternants in that no external argument is introduced. Continuing our example, the grammar can build a core vP as above (verbalizer, root and internal argument) and merge Voice<sub>[-D]</sub>. This configuration gives us *nifbar* ‘broke’ in (22). Since no external argument can be merged in the specifier of Voice<sub>[-D]</sub>, the structure in (22) is unaccusative. The crossed out specifier position is used as notation to make this explicit.

(22) *niXYaZ*, *nifbar* ‘got broken’

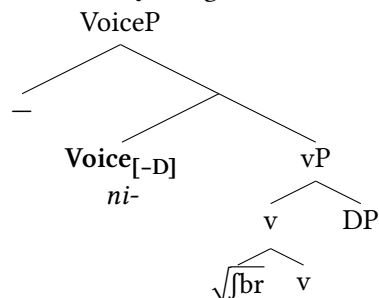

### 3 Voice<sub>[-D]</sub>

The idea that verbs in this template are anticausative variants of those in *XaYaZ* is not new. However, the explicit morphosyntactic implementation is novel (see also Kastner 2017), providing a necessary backdrop for the analyses of figure reflexives and reflexives coming up.

The same structure derives *passives* in *niXYaZ*. I subscribe to the view according to which the implicit external argument of the passive is not projected in the syntax at all (Alexiadou et al. 2015; see Bhatt & Pancheva 2017 for discussion). The analysis of *niXYaZ* provides support for this view, since otherwise Voice<sub>[-D]</sub> would need to have two distinct syntactic specifications (no specifier or implicit Agent).

In terms of structure, *inchoatives* are identical to anticausatives and passives. The only difference is that the underlying vP does not have an interpretation with Voice, a matter of the semantic interpretation, coming up next.

Two brief points should be mentioned here. First, the relevant feature on Voice has been characterized as [ $\pm$ D] throughout. This raises the immediate question of whether PPs are possible in Spec, Voice<sub>[-D]</sub>. Hebrew does not have PP subjects of the Slavic type, so the question is moot; if it turns out that a different EPP-like feature needs to be used, not much will change in the theory. The second point is that in a Trivalent Theory of Voice, Voice<sub>[-D]</sub> prohibits something from merging in its specifier. This is not the same as the bivalent theories mentioned above, in which Expletive Voice does not project a specifier. This conceptual difference, and the empirical differences it brings up, are addressed in Chapter 6.

#### 3.3.2 Semantics

The denotations of Voice<sub>[-D]</sub> are as follows:

- (23)  $\llbracket \text{Voice}_{[-D]} \rrbracket =$
- $\lambda P \lambda e \exists x. \text{Agent}(x, e) \ \& \ P(e) / \{ \sqrt{\text{rtsx}} \text{ 'murder' }, \sqrt{\text{mr}} \text{ 'say' }, \dots \}$
  - $\lambda P_{\langle s, t \rangle}. P$

Two issues need to be unpacked. The first is the difference between unaccusatives and passives. The second has to do with the composition of inchoatives.

The LF rules in (23) demonstrate a case of contextual allosemy: a functional head has one interpretation in one context, and another in another context. Specifically, I assume that the default function of Voice<sub>[-D]</sub> is the identity function in (23b): it takes an event of breaking, for example, and does not modify it. Crucially, it does not add an Agent role.

Some roots (in fact many of them) derive passive verbs when combining with *niXYaZ*. This situation is similar to that of Greek, where verbs with the non-active suffix might be unaccusative or passive. In saying this I am simplifying the



empirical picture considerably but the core point remains that a non-active head is underspecified with regard to passive and unaccusative readings. Alexiadou & Doron (2012) made this point explicit for Hebrew and Greek, and Alexiadou et al. (2015) elaborated on it for Greek. The rules in (23) implement this intuition formally.<sup>4</sup>

The second issue in the semantics of Voice<sub>[-D]</sub> has to do with composing inchoatives. In what follows I delve a bit deeper into inchoatives in an attempt to understand how a compositional syntax/semantics works in these cases, where there is no alternating active verb and no obvious vP for Voice<sub>[-D]</sub> to combine with, followed by some crosslinguistic parallels. Readers who are not troubled by the compositional details may want to skip ahead to Section 3.3.3, on the morphophonology of Voice<sub>[-D]</sub>.

### 3.3.2.1 Null allosemy in inchoatives

Recall the relevant semantics of Voice<sub>[-D]</sub>:

$$(24) \quad \llbracket \text{Voice}_{[-D]} \rrbracket = \lambda P_{\langle s,t \rangle} . P$$

This works well when the underlying vP is an event of breaking a glass, like in our running example. In principle, we expect the vP to describe an event which might then receive an Agent (with Voice) or not (Voice<sub>[-D]</sub>). But what if there is no [Voice vP] structure, i.e. no active verb in *XaYaZ*, as in *nirdam* ‘fell asleep’? It is not derived from a causative verb \**radam* because there is no such verb (nor has there been in the history of the language, as far as I know).

Two solutions come to mind, though I will not adjudicate between them. The first assumes that the vP does exist with its own semantics but cannot combine with Voice for arbitrary reasons. The second assumes that Voice<sub>[-D]</sub> is what selects the meaning of the root (rather than v).

#### 3.3.2.1.1 No licensing of Voice

One recurrent issue in the morphology of Semitic languages is that not every root can appear in every possible template. At some level a root must list which functional heads it can combine with; let us call this LICENSING in a way which does not commit to any specific implementation. For example,  $\sqrt{\text{br}}$  licenses Voice (*favar* ‘broke’),  $\sqrt{\text{ACTION}}$  (*fiber* ‘broke to pieces’) and Voice<sub>[-D]</sub> (*nifbar* ‘was broken’), but not Voice<sub>[+D]</sub> of Chapter 4 (\**hefbir*). Every root must list this kind of information; the morphological system is riddled with such arbitrary gaps.

<sup>4</sup>However, I do not have any formally insightful way of modeling the cases of ambiguity broached earlier. Perhaps both clauses of (23) need to be contextualized to lists of roots.

### 3 Voice<sub>[-D]</sub>

It could be, then, that the minimal vP in (25) is a valid syntactic object, awaiting some element at the Voice layer in order to satisfy some well-formedness condition (be it morphological or phonological; recall that the Voice layer introduces the stem vowels).

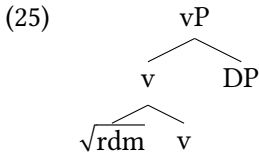

Then,  $\sqrt{\text{rdm}}$  simply does not license Unspecified Voice; accordingly, there is no verb \**radam*. But this root can still combine with Voice<sub>[-D]</sub> if it does license it. The rule of interpretation above does not need to be changed. The cost is acknowledging the idiosyncrasy of the system to a greater degree than before: why is it that precisely these roots do not license Voice and do license Voice<sub>[-D]</sub>? Is there some lexical-semantic generalization to be made? Can we find cases of the core vP embedded under another category head? Can Unspecified Voice be added in innovations? I leave these questions open.

#### 3.3.2.1.2 Weakening the Arad/Marantz hypothesis

Theories of Voice like the current one or that of Alexiadou et al. (2015) usually adopt the so-called “Arad/Marantz hypothesis” (Anagnostopoulou & Samioti 2014), according to which the first categorizing head merging with a root selects the meaning of the root (Arad 2003; Marantz 2013). For verbs, this is always *v*. What we could assume instead is that certain configurations allow for interpretations of the root conditioned by a high functional head (in this case Voice<sub>[-D]</sub>) over a lower functional head (*v*). The theory involved is one in which meaning is calculated over semantically contentful elements only, just as allomorphy is calculated over phonologically contentful (overt) elements (Embick 2010 et seq, but compare Kastner & Moskal 2018).

Consider anticausatives once more. In (26a), the combination of *v* and  $\sqrt{\text{br}}$  results in a contentful combination, the predicate of breaking events. The root can have various related meanings, but at this point in the derivation its meaning has been chosen. As a consequence, any higher material will in principle only be able to manipulate this meaning (Arad 2003), not select another meaning of the root (this point will be expanded in Section 4.4). Voice<sub>[-D]</sub> has a syntactic function: it blocks merger of a DP in its specifier. As a result, the VoiceP will be interpreted as a detransitivized version of the vP, (26b).

(26) Locality in interpretation: anticausatives.

- a.  $[v \sqrt{\text{br}}] = \lambda x \lambda e. \text{break}(e) \ \& \ \text{Theme}(x,e)$   
 b.  $[\text{Voice}_{[-D]} [\text{break}]] = \text{nifbar}$  ‘got broken’

If a given root combines with *v* to be verbalized, it is possible that *v* introduces an event variable but carries no additional semantic content when combined with this root. No verb results in this configuration, (27a). As a result, the next functional head will have a chance to select the interpretation of the root, as with Voice<sub>[-D]</sub> in (27b). In a sense, the root selects for a specific additional functional head.

(27) Locality in interpretation: inchoatives.

- a.  $[v \sqrt{\text{rdm}}] = \text{undefined}$   
 b.  $[\text{Voice}_{[-D]} [(v) \sqrt{\text{rdm}}]] = \text{‘fell asleep’}$

### 3.3.2.2 Null allosemy crosslinguistically

These are the inchoatives treated here, but similar constructions can be found in Romance languages. Burzio (1986) observes what he calls an “inherently reflexive” verb which requires the nonactive clitic *si* (Italian SE). The glosses are his.

(28) Italian (Burzio 1986: 39)

- |                                                                                                                   |                                                                                                                      |
|-------------------------------------------------------------------------------------------------------------------|----------------------------------------------------------------------------------------------------------------------|
| <p>a. Giovanni <i>si</i> sbaglia.<br/>         Giovanni himself mistakes<br/>         ‘Giovanni is mistaken.’</p> | <p>b. *Giovanni sbaglia Piero<br/>         Giovanni mistakes Piero<br/>         (int. ‘Giovanni mistakes Piero’)</p> |
|-------------------------------------------------------------------------------------------------------------------|----------------------------------------------------------------------------------------------------------------------|

(29) Giovanni *se* ne pentirá.  
 Giovanni himself of.it will.repent  
 ‘Giovanni will be sorry for it.’

(30) Giovanni *ci si* é arrangiato.  
 Giovanni there himself is managed  
 ‘Giovanni has managed it.’

(Burzio 1986: 70)

The forms *sbaglia* and *pentirá* are not possible without SE; some verbs simply require SE or the equivalent nonactive marker in their language, however encoded.<sup>5</sup>

<sup>5</sup>The facts are slightly more complicated: *sbaglia* ‘mistake’ is possible in certain contexts but I believe that the generalization about *pentirsi* ‘repent’ is robust (Burzio 1986: 40).

The famous case of deponents in Latin is similar: as discussed by various authors (e.g. Xu et al. 2007), deponents are verbs with nonactive morphology but active syntax. Although they appear with a nonactive suffix, the verbs themselves are unergative or transitive. The deponent verb *sequor* ‘to follow’ is syntactically transitive but has no morphologically active forms:

- (31) a. Regular Latin alternation: *amo-r* ‘I am loved’ < *amō* ‘I love’  
 b. Deponent Latin verb: *sequo-r* ‘I follow’ < \**sequō* ‘I follow’

Similar patterns have been discussed for various Indo-European languages by Aronoff (1994), Embick (2004b), Kallulli (2013), Wood (2015), Kastner & Zu (2017) and Grestenberger (2018), among many others. While the analyses differ, what these cases all have in common is that individual roots require nonactive morphology.

Turning to another possible crosslinguistic parallel with inchoatives, it has been pointed out that in some languages, verbalizing suffixes do not contribute eventive semantics in certain environments. That is, they are phonologically overt but semantically null, a slightly different situation than ours. Anagnostopoulou & Samioti (2013; 2014) document a pattern in Greek in which certain adjectives can only be derived if a verbalizing suffix is added to the root first. Crucially, there is no eventive semantics (unlike with our inchoatives); no weaving is entailed for (32) nor planting for (33). The authors suggest that *-tos* requires an eventive vP as its base, which is not possible with nominal roots like ‘weave’ and ‘plant’.

- (32) *if-an-tos* weave-VBLZ-ADJ ‘woven’  
 (33) *fit-ef-tos* plant-VBLZ-ADJ ‘planted’ (Anagnostopoulou & Samioti 2014: 97)

In fact, the part of the structure consisting of the root and verbalizer might not even result in an acceptable verb (Anagnostopoulou & Samioti 2014: 100):

- (34) *kamban-a* ‘bell’ ~ ??*kamban-iz-o* ‘bell (v)’ ~ *kamban-is-tos* ‘sounding like a bell’

In a similar vein, Marantz (2013) argues that an *atomized individual* need not have undergone atomization, and analyzes a similar phenomenon in Japanese “continuative” forms that must be vacuously verbalized first before being nominalized (Volpe 2005). Anagnostopoulou (2014) extends this idea of a semantically null exponent to cases like *-ify-* in *the classifieds* (but see Borer 2014a for a dissenting view).

In sum, we have evidence that *v* can be active in the semantics without selecting the meaning of the root, allowing a higher Voice<sub>[-D]</sub> head to derive nonactive verbs directly from the root rather than from an existing verb. Crucially here, though, little *v* still introduces an event variable.

### 3.3.3 Phonology

The basic Vocabulary Item for Voice<sub>[-D]</sub> can be given using the shorthand in (35). The remainder of this section provides some Vocabulary Items and schematic derivations which make the division of morphological labor between Voice<sub>[-D]</sub> and T more explicit.

(35) Voice<sub>[-D]</sub> ↔ *niXYaZ*

The ingredients of the template *niXYaZ* consist of the prefix *ni-* in the past tense, a person/number/gender-conditioned allomorph in the future, and certain stem vowels. A full paradigm is given in Table 3.9 and similar paradigms can be found elsewhere, e.g. Schwarzwald (2008). What is not often mentioned in the literature – and what I have failed to note in Kastner (2019b) myself – is that a process of de-spirantization applies in *niXYaZ* as well, namely in the “imperfect” forms (future, infinitive, imperative and nominalization), whereby the first root consonant does not spirantize ( $\underset{\sim}{X}$ ). I will not provide an analysis of this aspect of the system but I do note that an analysis in terms of a floating feature can be implemented, docking onto the first consonant along the lines of [-cont]<sub>ACT</sub> on  $\underset{\sim}{Y}$  for  $\sqrt{\text{ACTION}}$  in *Xi $\underset{\sim}{Y}$ eZ* and *hitXa $\underset{\sim}{Y}$ eZ* (Section 2.5.3).

Table 3.9: Inflectional paradigm for *niXYaZ*

|     | Past              |                       | Present          |                  | Future                                                                              |                                                |
|-----|-------------------|-----------------------|------------------|------------------|-------------------------------------------------------------------------------------|------------------------------------------------|
|     | M                 | F                     | M                | F                | M                                                                                   | F                                              |
| 1SG |                   | <i>niXYaZ-ti</i>      | <i>niXYaZ</i>    | <i>niXYeZ-et</i> | <i>e-<math>\underset{\sim}{X}</math>aYeZ/ji-<math>\underset{\sim}{X}</math>aYeZ</i> |                                                |
| 1PL |                   | <i>niXYaZ-nu</i>      | <i>niXYaZ-im</i> | <i>niXYaZ-ot</i> | <i>ni-<math>\underset{\sim}{X}</math>aYeZ</i>                                       |                                                |
| 2SG | <i>niXYaZ-ta</i>  | <i>niXYaZ-t</i>       | <i>niXYaZ</i>    | <i>niXYeZ-et</i> | <i>ti-<math>\underset{\sim}{X}</math>aYeZ</i>                                       | <i>ti-<math>\underset{\sim}{X}</math>aYZ-i</i> |
| 2PL | <i>niXYaZ-tem</i> | <i>niXYaZ-ten/tem</i> | <i>niXYaZ-im</i> | <i>niXYaZ-ot</i> | <i>ti-<math>\underset{\sim}{X}</math>aYZ-u</i>                                      |                                                |
| 3SG | <i>niXYaZ</i>     | <i>niXYeZ-a</i>       | <i>niXYaZ</i>    | <i>niXYeZ-et</i> | <i>ji-<math>\underset{\sim}{X}</math>aYeZ</i>                                       | <i>ti-<math>\underset{\sim}{X}</math>aYeZ</i>  |
| 3PL |                   | <i>niXYeZ-u</i>       | <i>niXYaZ-im</i> | <i>niXYaZ-ot</i> | <i>ji-<math>\underset{\sim}{X}</math>aYZ-u</i>                                      |                                                |



### 3.4 $p_{[-D]}$

The previous section analyzed the non-active verbs of *niXYaZ* using the head  $\text{Voice}_{[-D]}$ . This section tackles the figure reflexives; recall that these are active (agentive) verbs which obligatorily take a prepositional phrase as the complement to the verb. I propose that the head  $p_{[-D]}$  is to  $\text{Voice}_{[-D]}$  as  $p$  is to  $\text{Voice}$ : it fails to syntactically license an external argument *of a preposition*. Recall that I assume a layered theory of prepositions, according to which P introduces the “internal argument” of the preposition, the Ground, and  $p$  introduces its “external argument”, the Figure.

Much of the analysis here follows the analysis of similar constructions in Icelandic proposed by Wood (2015). Here are the basics:

- (41)  $p_{[-D]}$
- a. A  $p$  head with a  $[-D]$  feature, prohibiting anything with a  $[D]$  feature from merging in its specifier.
  - b.  $\llbracket p_{[-D]} \rrbracket = \llbracket p \rrbracket = \lambda x \lambda s. \text{Figure}(x, s)$
  - c.  $p_{[-D]} \leftrightarrow \text{niXYaZ}$   
(with the allomorph *hitXaYeZ* to follow in Section 3.7.2)

I discuss the syntax and semantics together in what follows.

#### 3.4.1 Syntax and semantics

##### 3.4.1.1 Ordinary prepositions

As noted above, I adopt the idea that subjects of prepositional phrases are introduced by a separate functional head, a suggestion which has already been made in various guises by a number of researchers interested in the structure of prepositional phrases (van Riemsdijk 1990; Rooryck 1996; Koopman 1997; Gehrke 2008; Den Dikken 2003; 2010). In particular, Svenonius (2003; 2007; 2010) implements this idea using the functional head  $p$ . Borrowing terminology from Talmy (1978) and related work, and likening the  $pP$  to  $\text{Voice}P$ , Wood (2014; 2015) suggests a parallelism: just like the verb assigns the semantic role of Theme to its complement, P assigns the semantic role of GROUND. And just like  $\text{Voice}$  assigns the semantic role of Agent to its specifier,  $p$  assigns the semantic role of FIGURE to its own specifier.

The dashed arrows in (42) show the assignment of semantic (thematic) roles in this system.<sup>7</sup>

<sup>7</sup>I take it as given that thematic roles are semantic functions but that something like the traditional theta-role does not exist (Schäfer 2008; Alexiadou et al. 2015; Wood 2014; 2015; Wood & Marantz 2017; Myler 2016; Kastner 2017); see the background given in Chapter 1.

### 3 Voice<sub>[-D]</sub>

(42) a.

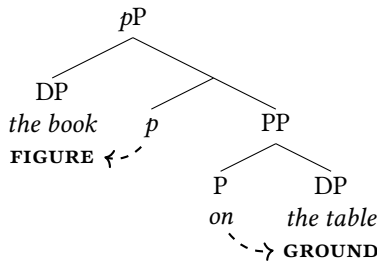

b.  $[[\text{Voice}]] = \lambda x \lambda e. \text{Agent}(x, e)$

c.  $[[p]] = \lambda x \lambda s. \text{Figure}(x, s)$

An ordinary prepositional phrase in Hebrew is given in (43), for a verb in *XaYaZ*. As seen in the previous chapter, the structure comprises the root, *v* and Unspecified Voice.

(43) a. marsel sam tsaatsua al ha-smixa.  
 Marcel put toy on the-blanket  
 ‘Marcel put a toy on the blanket.’

b.

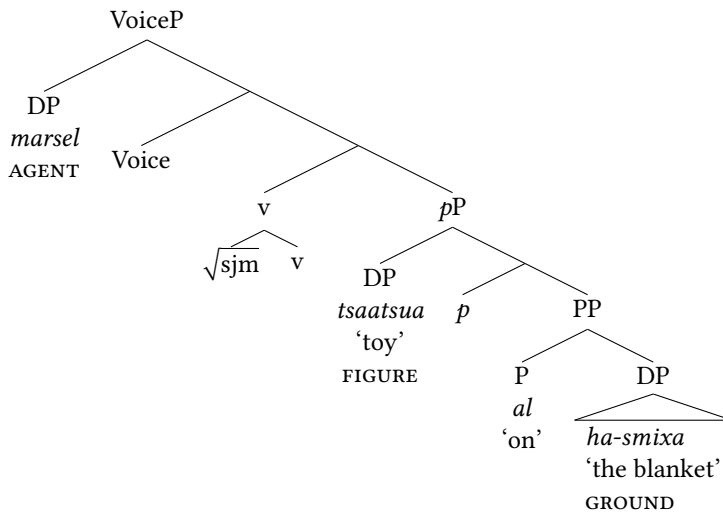

#### 3.4.1.2 Figure reflexives

Following Wood (2015), I postulate a variant of *p*, namely *p*<sub>[-D]</sub>, which prohibits the Merge of a DP in Spec,*pP*, (44).



- (44)  $p_{[-D]}$ :
- A  $p$  head with a  $[-D]$  feature, prohibiting anything with a  $[D]$  feature from merging in its specifier.
  - $\llbracket p_{[-D]} \rrbracket = \llbracket p \rrbracket = \lambda x \lambda s. \text{Figure}(x, s)$

In the current system, a given head might impose a semantic requirement which is usually fulfilled immediately if the parallel syntactic requirement is met. For example, Voice might introduce an Agent role and license Spec, VoiceP, such that the argument in the latter saturates the former. But it is also possible for a semantic predicate to be satisfied later on in the derivation, in DELAYED SATURATION. Such cases have been recently identified (sometimes as “delayed gratification”) in work on French (Schäfer 2012), Icelandic (Wood 2014; 2015), English, Quechua (Myler 2016), Japanese (Wood & Marantz 2017) and Choctaw (Tyler to appear), although the idea that a predicate may be saturated in delayed fashion is not new in and of itself (Higginbotham 1985).

Consider first the existing analysis of Icelandic. Figure reflexives in this language can appear in two configurations, one with a clitic *-st* which does not concern us here (Wood 2014), and the other without it, as in (45):

- (45) Icelandic (Wood 2015: 168)
- Hann labbaði inn í herbergið.  
 he.NOM strolled in to room.the.ACC  
 ‘He strolled into the room.’

On Wood’s (2015) analysis, the role of Figure is not saturated within the  $pP$ , since no DP is possible in Spec,  $p_{[-D]}P$ . Rather, an argument introduced later, in Spec, VoiceP, saturates this predicate. The schematic structure in Figure 3.1 shows the assignment of thematic roles using dashed arrows.

The structure for (45) is given in Figure 3.2, adapted from Wood (2015: 170). Wood’s insight is that there is no argument filling Spec,  $p_{[-D]}P$  which can saturate the Figure role of  $p_{[-D]}$ . The next DP merged in the structure, *hann* ‘he’, will then saturate both Voice’s semantic role (Agent) and the role of Figure introduced by  $p_{[-D]}$ . A variety of diagnostics for Icelandic show that the verb is agentive, with the DP *hann* merged in Spec, VoiceP, just like Hebrew figure reflexives are agentive.

Returning to Hebrew, we can adopt this proposal and give the derivation in (46) for a verb like *nixnas le-* ‘entered’ in *niXYaZ*, where  $p_{[-D]}$  introduces a Figure semantically but does not introduce an argument in the syntax.

3 Voice<sub>[-D]</sub>

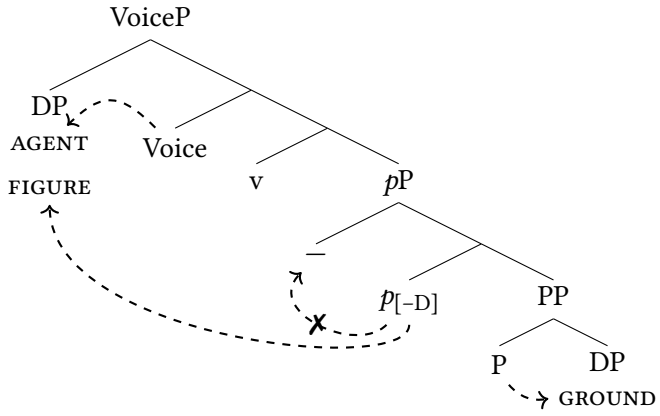

Figure 3.1: Thematic roles in the *pP*

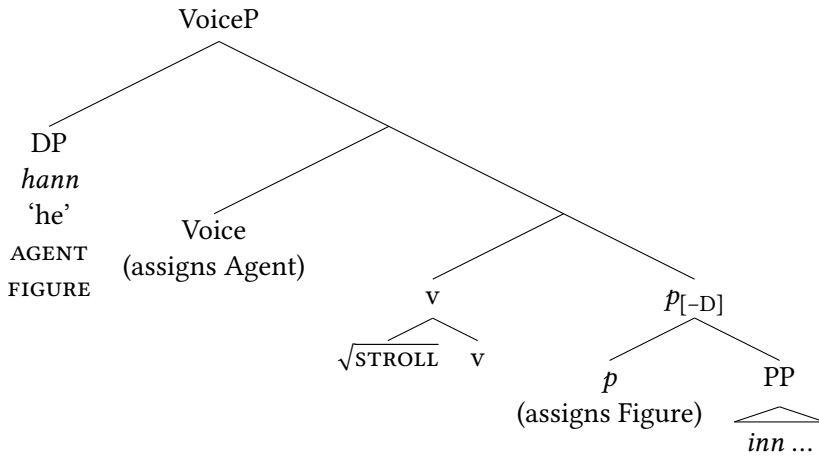
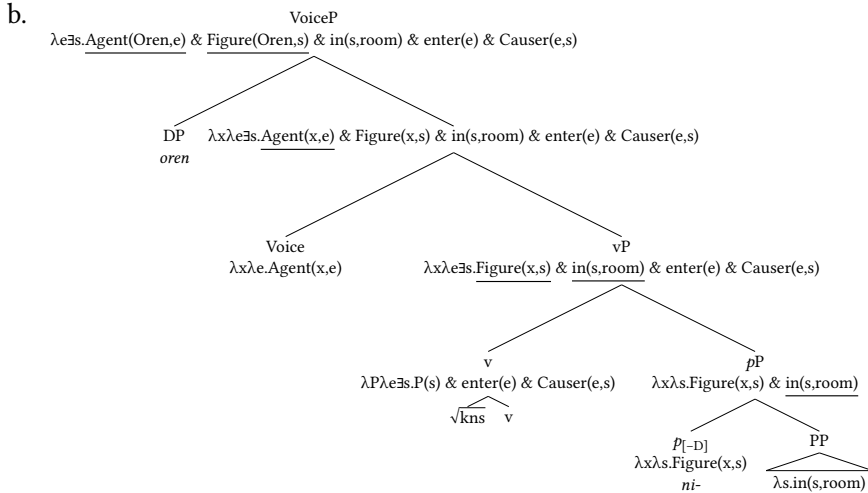

Figure 3.2: Structure for (45)

- (46) a. oren *nixnas* la-xeder.  
 Oren entered.MID to.the-room  
 ‘Oren entered the room.’



In (46) The  $pP$  is composed via Event Identification, the  $vP$  via Function Composition (cf. Restrict of Chung & Ladusaw 2004), and the VoiceP again via Event Identification.

The two main consequences of this configuration are that an external argument may be merged in Spec,VoiceP and that the obligatory prepositional phrase does not have a subject of its own. The generalization on figure reflexives can now be derived: external arguments in  $niXYaZ$  saturate the Figure role of an otherwise subjectless preposition. While in Icelandic Voice $_{[-D]}$  has overt reflexes (Wood 2015: Section 3.2) and  $p_{[-D]}$  is silent, in Hebrew we find morphological support for both.

It is interesting to note that  $p_{[-D]}$  still introduces a Figure role despite prohibiting a specifier. In this it is similar to “free variable” proposals in which Voice introduces the Agent role in the semantics but no specifier in the syntax (Legate 2014; Akkus 2019).

One would be justified in wondering whether some other argument might intervene between  $vP$  and Voice, in which case it would be able to saturate the Figure role. High applicatives would have been relevant here, but Hebrew has been argued to have only the possessive dative as a low applicative for internal arguments (Pylkkänen 2008: 46), meaning that the ApplP would be too low to influence derivation of the figure reflexive. The affected reading of these datives, however, actually implies a different structure for unergatives (Pylkkänen 2008:

59), the nature of which is still unclear. See Bar-Asher Siegal & Boneh (2015; 2016) for some ideas.

### 3.4.2 Phonology

In Hebrew, *Voice*<sub>[-D]</sub> and *p*<sub>[-D]</sub> are spelled out identically: a prefix (*ni-*) and the relevant stem vowels, resulting in *niXYaZ*. This should not be an accident. In Section 3.5 and in Chapter 7 I return to the idea that these are one and the same head, *i\**, differing only in its height of attachment.

This section concludes with an extended note on linearization and head movement. I have argued that *Voice*<sub>[-D]</sub> starts off high, above *v* and the root, while *p*<sub>[-D]</sub> starts off below them. Despite their different attachment sites, *Voice*<sub>[-D]</sub> and *p*<sub>[-D]</sub> are pronounced identically, as a prefix to the verb and certain vocalic readjustments.

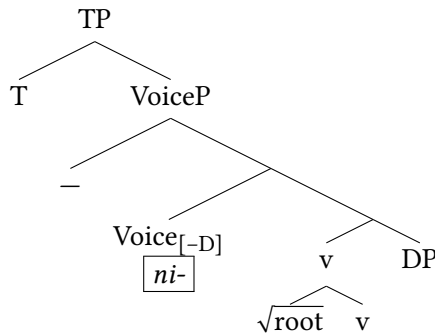
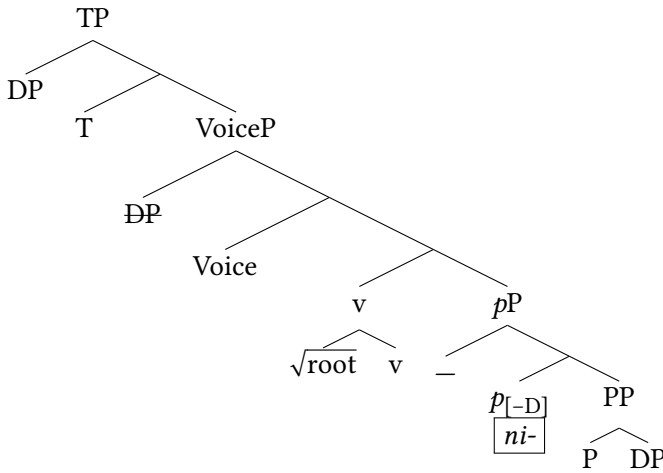

Figure 3.3: Anticausatives in *niXYaZ* with *Voice*<sub>[-D]</sub>

Not much needs to be said about the affixation in Figure 3.3 since the structure can be linearized as is: one morphophonological cycle combines the root with *Voice* and associated elements, and a second cycle attaches the prefix *T* (Section 2.3.3 and Kastner 2019b). The phonological material on *T* might end up as a suffix rather than prefix due to general phonological constraints of the language (for example, if *T* is purely vocalic).

This is a different kind of theory than that of Shlonsky (1989) and Ritter (1995), who assume that all affixation results from head movement of the verb, “picking up” affixes as it moves up the syntactic tree (Pollock 1989) and eventually reaching the tense affixes on *T*.

Not all analyses assume that *V* reaches *T* in Hebrew. According to Borer (1995) and Landau (2006), Hebrew *V* may raise to *T* in cases of ellipsis and VP-fronting,

Figure 3.4: Figure reflexives in  $niXYaZ$  with  $p_{[-D]}$ 

but not necessarily in the general case. For Landau, this V-to-T movement is driven by T's need to express inflectional features, which appear on T in Hebrew but may lower to V in other languages or be expressed via *do*-support in English. Implementing affixation using Agree between T and V absolves V of having to adjoin to T itself.

Returning to Figure 3.4, a challenge arises if we try to linearize  $p_{[-D]}$  between the root and T. The problem is that  $p_{[-D]}$  should be pronounced in the same position as  $\text{Voice}_{[-D]}$  is in Figure 3.3. The phonological consequences go beyond just one exponent which needs to be placed correctly: in  $niXYaZ$  the prefix itself is conditioned by T; see Table 3.11.

Table 3.11: The spell-out of  $p_{[-D]}$  is conditioned by T.

|    |                |                  |                    |
|----|----------------|------------------|--------------------|
| a. | T[Past, 3SG.M] | <b>ni-xnas</b>   | 'he entered'       |
| b. | T[Fut, 3SG.M]  | <b>ji-kanes</b>  | 'he will enter'    |
| c. | T[Past, 2SG.F] | <b>ni-xnas-t</b> | 'you.F entered'    |
| d. | T[Fut, 2SG.F]  | <b>ti-kans-i</b> | 'you.F will enter' |

Under the assumptions of the current theory,  $p_{[-D]}$  needs to be local to T in order to correctly spell out its own prefix and add vowels to the stem.

Standard head movement could raise  $p_{[-D]}$  and adjoin it to v (or Voice via v), deriving the correct morpheme order. The problem is not empirical but concep-

tual: all other morphological derivations in the Trivalent Theory proceed without head movement by simply linearizing structure under explicit phonological constraints. Here we would require  $p_{[-D]}$  to raise (perhaps obligatory for  $p$  as well). What feature drives this movement? Any feature that accounts for solely this movement would be suspiciously stipulative. But if head movement is more common, does the complex head then raise further, to Voice and then to T? A theory which allows phonological words to be read directly off the structure, but which also allows construction of phonological words by head movement, runs the risk of being too permissive.

Attempts to derive head movement effects have led to various proposals which I cannot contrast here. The operation Conflation (Hale & Keyser 2002; Harley 2013b) adjoins only the phonology of a complement onto that of its sister, similar to Local Dislocation. This operation can be thought of as purely phonological Incorporation (Baker 1985; 1988). See Rimell (2012: Section 2.5) for an evaluation.

Another theoretical proposal is that of head movement as remnant movement (Koopman & Szabolcsi 2000; Koopman 2005; 2015). On this approach all affixes are heads which take their base as a complement. Suffixes are endowed with an EPP feature raising their complement to Spec, resulting in the affix spelling out to the right of the stem. For this proposal to work, the structure in Figure 3.4 would need to be changed since  $p_{[-D]}$ , as a prefix, needs to take  $v+\sqrt{\text{root}}$  as its complement: [ $p_{[-D]}$  [ $v$  [ $v \sqrt{\text{root}}$ ] [PP]]]. But now it is not clear where the prepositional object PP appears. PP is, by hypothesis, the complement of  $p$ ; if we treated it as the complement of  $v$ , we would be abandoning the little  $p$  hypothesis, leaving us with no morpheme to spell out the *ni-* prefix in the first place.

One other kind of mechanism for exceptional tweaking of individual morphemes in the morphophonology is Local Dislocation (Embick & Noyer 2001). This mechanism swaps the linear order of two adjacent morphemes at spell-out. Local Dislocation is assumed to apply after Vocabulary Insertion; I keep the syntactic labels in (47) for consistency of exposition.

- (47) a. Linearized structure: T-Voice- $v-\sqrt{\text{root}}-p_{[-D]}$   
 b. Local Dislocation:  $\Rightarrow$  T-Voice- $v-p_{[-D]}-\sqrt{\text{root}}$   
 c. Pruning of silent exponents:  $\Rightarrow$  T- $p_{[-D]}-\sqrt{\text{root}}$

At the end of the day, the analysis in (47) simply formalizes the idea that  $p_{[-D]}$  is a prefix.

Local Dislocation happens after VI, so  $p_{[-D]}$  will not be able to be conditioned properly by T. Instead, I could assume that the actual VI for  $p_{[-D]}$  is *i-*, and the *n-* prefix a partial exponent of T; but this entire setup grinds to a halt once  $\sqrt{\text{ACTION}}$  intervenes between the two as in *hitXaYeZ*:

(48) T-Voice- $\sqrt{\text{ACTION}}$ -v- $p_{[-D]}$ - $\sqrt{\text{root}}$

None of the alternatives are particularly satisfying. I assume head movement and leave matters as is.

### 3.5 Interlude: From *niXYaZ* to *hitXaYeZ*

We have seen that verbal forms in *niXYaZ* are in principle compatible with internal and external arguments, though not within the same verb (there are no transitive verbs in *niXYaZ*):

(49) Generalizations about *niXYaZ*

- a. *Configurations*: Verbs appear in unaccusative, passive and figure reflexive structures, but never in a simple transitive configuration.
- b. *Alternations*: Some verbs are anticausative or passive versions of verbs in *XaYaZ*.

I proposed that two distinct verb classes exist which share the same morphology. For non-active verbs, with no external argument, it was suggested that Voice<sub>[-D]</sub> blocks the introduction of an external argument and triggers *niXYaZ* morphology. For figure reflexives, with an agent and an obligatory PP complement, I claimed that  $p_{[-D]}$  introduces the PP but does not supply a subject of its own for the preposition, while also triggering *niXYaZ* morphology. This analysis falls within a view of argument structure which distinguishes syntactic features, such as the requirement for a specifier, from semantic roles, such as the requirement for an Agent or a Figure.

In line with the basic root hypothesis of DM, none of the derivations go from a verb in *XaYaZ* to a verb in *niXYaZ*; to the extent that the Trivalent proposal is more explanatory than existing ones (and I believe it is, as I claim concretely in Section 3.9), it provides support for this assumption. In particular, *niXYaZ* is not one morpheme: it is a collection of identical morphophonological forms masking a variety of different structural configurations.

Importantly, the feature [-D] is used on both Voice<sub>[-D]</sub> and  $p_{[-D]}$ . I have already alluded to the idea that the only difference between the two verb classes in *niXYaZ* is the height of attachment of the [-D] feature; in other words, that Voice<sub>[-D]</sub> and  $p_{[-D]}$  are the same head, except that Voice<sub>[-D]</sub> is what we label it when it combines with vP and  $p_{[-D]}$  is what we label it when it combines with a PP. Recently, Wood & Marantz (2017) have proposed that heads such as Voice, Appl and  $p$  are indeed contextual variants of the same functional head, which

they call  $i^*$ . On their view, “Voice” is simply the name we give to  $i^*$  which takes a vP complement, “high Appl” is the name we give to  $i^*$  which takes a vP complement and is in turn embedded in a higher  $i^*$  (itself being Voice), “ $p$ ” is the name we give to an  $i^*$  which takes a PP complement, and so on. I return to this idea in Chapter 7.

The next section re-introduces the agentive modifier  $\sqrt{\text{ACTION}}$  from the previous chapter and explores its interaction with *Voice*<sub>[-D]</sub>. Some of these interactions are more obvious, as with figure reflexives ( $\sqrt{\text{ACTION}} + p_{[-D]}$ ). Others require slight tweaks to our understanding of specific elements, as with anticausatives; and others are more interesting still, as with reflexive verbs. There are no reflexive verbs in *niXYaZ*. The current theory will provide an answer to the “how” question of how these verbs appear in *hitXaYeZ* as well as an answer to the “why” question of why *hitXaYeZ* and not *niXYaZ*: reflexivity requires a theme (*Voice*<sub>[-D]</sub>) which is agentive ( $\sqrt{\text{ACTION}}$ ). In general, the parallels between *XaYaZ* and *heXYiZ* on the one hand, and *XiYeZ* and *hitXaYeZ* on the other hand, will reflect the Layering assumption which is at the core of the current work.

### 3.6 *hitXaYeZ*: Descriptive generalizations

The “intensive middle” template *hitXaYeZ* is traditionally viewed as the reflexive template. Yet reflexive verbs form only a small part of it. I will first show how it houses anticausative and inchoative verbs, similarly to *niXYaZ*, but not passives. I then look briefly at figure reflexives, which appear in both *niXYaZ* and *hitXaYeZ*, and true reflexives, which only appear in this template. Section 3.7 analyzes these patterns in terms of combinations of the modifier  $\sqrt{\text{ACTION}}$  from Section 2.5 with *Voice*<sub>[-D]</sub> or  $p_{[-D]}$ .

This template is also considered to be a natural one for reciprocal verbs, but Bar-Asher Siegal (2016) has shown that reciprocalization is licensed by strategies which do not have to anything do with the specific template; see also Siloni (2012) and Poortman et al. (2018). Because the relationship between templates and reciprocals is indirect, I will not discuss their place in the current theory.

#### 3.6.1 Non-active verbs

A few non-active verbs in *hitXaYeZ* are given in Table 3.12: anticausatives in rows a–c and inchoatives in rows d–f.



Table 3.12: Examples of non-active verbs in *hitXaYeZ*

|    | Root                  | <i>XiYeZ</i> active |              | <i>hitXaYeZ</i> non-active |               |
|----|-----------------------|---------------------|--------------|----------------------------|---------------|
| a. | $\sqrt{\text{prk}}$   | <i>pirek</i>        | ‘dismantled’ | <i>hitparek</i>            | ‘fell apart’  |
| b. | $\sqrt{\text{ptsts}}$ | <i>potsets</i>      | ‘detonated’  | <i>hitpotsets</i>          | ‘exploded’    |
| c. | $\sqrt{\text{bfl}}$   | <i>bifel</i>        | ‘cooked’     | <i>hitbafel</i>            | ‘got cooked’  |
| d. | $\sqrt{\text{’lf}}$   | —                   |              | <i>hitalef</i>             | ‘fainted’     |
| e. | $\sqrt{\text{’tj}}$   | —                   |              | <i>hitatef</i>             | ‘sneezed’     |
| f. | $\sqrt{\text{’rk}}$   | —                   |              | <i>hitarex</i>             | ‘grew longer’ |

*Anticausatives* in *hitXaYeZ* alternate with causatives in *XiYeZ*:

- (50) a. *josi bifel marak.*  
 Yossi cooked.INTNS soup  
 ‘Yossi cooked some soup.’
- b. *ha-marak hitbafel ba-femef.*  
 the-soup got.cooked.INTNS.MID in.the-sun  
 ‘The soup cooked in the sun.’

As expected, they are incompatible with agent-oriented adverbs and *by*-phrases:

- (51) \* *ha-tsamid hitparek { al-jedej ha-tsoref /*  
 the-bracelet dismantled.INTNS.MID by the-jeweler  
*be-mejomanut }*  
 in-skill  
 (int. ‘The bracelet was dismantled by the jeweler/skillfully’)

They are compatible with ‘by itself’:

- (52) *ha-tsamid hitparek me-atsmo.*  
 the-bracelet dismantled.INTNS.MID from-itself  
 ‘The bracelet fell apart of its own accord.’

And as expected, they are also compatible with the two unaccusativity diagnostics introduced earlier, VS order (53) and the possessive dative (54).

- (53) *hitpark-u fljofa galgalim be-fmone ba-boker.*  
 dismantled.INTNS.MID-3PL three wheels in-eight in.the-morning  
 ‘Three wheels fell apart at 8am.’

- (54) *hitparek*                      I-i    ha-*faon*.  
 dismantled.INTNS.MID to-me the-watch  
 ‘My watch broke.’

Note in this context that this view of anticausatives in *hitXaYeZ* as alternants of an agentive transitive verb in *XiYeZ* is unexpected under a certain conception which has proven popular in previous work on argument structure. The purported generalization is that decausativization can only occur if the external argument of the causative verb is not specified with respect to its thematic role, i.e. can be a Causer (Levin & Rappaport Hovav 1995; Reinhart 2002). If verbs in *XiYeZ* are indeed agentive, but can nonetheless be decausativized into an anticausative in *hitXaYeZ*, this generalization will need to be amended, but I will not do that here; see Alexiadou et al. (2015: 52) for an overview of related work and ideas.

Continuing on to *inchoatives*, these pattern with anticausatives. They are incompatible with agent-oriented adverbs and *by*-phrases:

- (55) a. \**josi hitalef*                      al-*jedej ha-kosem*  
 Yossi passed.out.INTNS.MID by        the-magician  
 (int. ‘Yossi fainted by the magician’)
- b. ?? *josi hitalef*                      be-*mejomanut*  
 Yossi passed.out.INTNS.MID in-skill  
 (int. ‘Yossi fainted skillfully’)
- (56) a. *sara hitatf-a*                      {*me-ha-avak* / ??*be-xavana*}.  
 Sarah sneezed.INTNS.MID-F from-the-dust    on-purpose  
 ‘Sarah sneezed because of the dust/??on purpose.’

They are compatible with ‘by itself’, although this is less evident with animate arguments:

- (57) a. My current visit in Israel was supposed to last a bit longer than two weeks,<sup>8</sup>  
*aval hitarex*                      me-*atsmo od va-od*.  
 but lengthened.INTNS.MID from-itself more and-more  
 ‘but kept getting longer and longer.’
- b. ?? *ha-kalb-a hitatf-a*                      me-*atsma*  
 the-dog-F sneezed.INTNS.MID-F from-herself  
 (int. ‘The dog sneezed unintentionally’)

<sup>8</sup>[http://noncentral55.rssing.com/chan-24176907/all\\_p131.html](http://noncentral55.rssing.com/chan-24176907/all_p131.html), retrieved July 2019.

And they pass the unaccusativity diagnostics:

- (58) *hitalf-u*                      **flofa xajalim** ba-hafgana.  
fainted.INTNS.MID-3PL three soldiers in.the-protest  
'Three soldiers fainted during the protest.' (Reinhart & Siloni 2005: 397)
- (59) *hitarx-u*                      **l-i** kol ha-bikurim.  
lengthened.INTNS.MID-3PL to-me all the-visits  
'All of my visits got longer.'

Curiously, there are *no passive verbs* in *hitXaYeZ*. No verb can be used with a *by*-phrase to get a passive reading, nor can some entailment relevant to an implicit agent be obtained.<sup>9</sup>

- (60) \* ha-tsamid *hitparek*                      kedej lekabel  
the-bracelet dismantled.INTNS.MID in.order to.receive.INTNS  
pitsuj                      me-ha-bituax  
compensation from-the-insurance  
(int. 'The bracelet was dismantled in order to collect the insurance')

Based on the diagnostics used throughout this book, the non-active verbs in *hitXaYeZ* are demonstrably unaccusative.

### 3.6.2 Figure reflexives

Figure reflexives in *hitXaYeZ* are compatible with agent-oriented adverbs.

- (61) a. *bjartur hiftaxel*                      **(be-xavana)** { derex ha-kahal /  
Bjartur squeezed.INTNS.MID in-purpose through the-crowd  
la-xeder }.  
to.the-room  
'Bjartur squeezed (his way) on purpose through the crowd/into the room.'
- b. ha-xatul *hitnapel*                      al ha-regel jeli **(be-zaam)**.  
the-cat pounced.INTNS.MID on the-foot mine in-wrath  
'The cat angrily pounced on my foot.'

<sup>9</sup>I suspect that a wug test would show this even for nonce verbs, but have not attempted such an experiment. Odelia Ahdout (p.c.) notes the following counterexamples from her comprehensive database which do seem to have passive readings: *hitstava* 'was ordered', *hitbatsa/hitbatsea* 'was carried out', *hitbakef* 'was asked', *hitbaser* 'was informed', *hitkabel* 'was received' and perhaps also *hitbarex* 'was blessed'. If these are true counterexamples then perhaps there is no structural reason for the paucity of passive verbs in *hitXaYeZ*, though this low rate should still receive some other kind of explanation.

They do not pass the unaccusativity diagnostics.

- (62) # *hitnapel*                    **ha-xatul** al ha-regel feli.  
 pounced.INTNS.MID the-cat    on the-foot mine  
 ‘Once the cat pounced on my foot, then...’  
 (does not mean: ‘The cat pounced angrily on my foot.’)
- (63) \* ha-xatul *hitnapel*                    **la-mita** al ha-sadin  
 the-cat    pounced.INTNS.MID to.the-bed on the-sheet  
 (int. ‘The cat pounced on the bed’s bedsheet’)

As with figure reflexives in *niXYaZ*, many of these verbs denote events of directed motion, (64a), but there are other kind of activities as well, each with its own obligatory preposition, (64b–c). It must also be acknowledged that not all have truly agentive meanings (64d).<sup>10</sup>

- (64) a. *bjartur hiftaxel*                    \*(derex ha-kahal / la-xeder).  
 Bjartur squeezed.INTNS.MID through the-crowd    to.the-room  
 ‘Bjartur squeezed (his way) through the crowd/into the room.’
- b. ha-xatul *hitnapel*                    \*(al ha-regel feli).  
 the-cat    pounced.INTNS.MID on the-foot mine  
 ‘The cat angrily pounced on my foot.’
- c. *ahed hitmard-a*                    \*(neged ha-avlot).  
 Ahed rebelled.INTNS.MID-F against the-wrongs  
 ‘Ahed rebelled against the wrongs.’
- d. ha-melex *hitmaker*                    \*(le-samim).  
 the-king    got.addicted.INTNS.MID to-drugs  
 ‘The King got addicted to drugs.’

What is particularly interesting is that these figure reflexives share morphological marking – *hitXaYeZ* – with actual reflexives (which do not exist in *niXYaZ*). These are discussed next.

### 3.6.3 Reflexives

By REFLEXIVE VERBS I mean canonical reflexive verbs as in (65):

<sup>10</sup>Siloni (2008) claims that simple unergatives exist in *hitXaYeZ*, but my view of the psych-verbs she presents is that they too require a PP complement, e.g. *hitbajef* \*(me)- ‘was shy (of)’.

- (65) Canonical reflexive verb (i) A monovalent verb whose DP internal argument X is interpreted as both Agent and Theme, *and* (ii) where no other argument Y (implicit or explicit) can be interpreted as Agent or Theme, *and* (iii) where the structure involves no pronominal elements such as *himself*.

The definition in (65) confines our discussion to reflexives that are morphologically marked, rather than construction that can use another strategy such as anaphora. As noted earlier, reflexive verbs in Hebrew are only attested in *hitXaYeZ*. Some examples are given in (66).

- (66) *hitgaleax* ‘shaved himself’, *hitraxets* ‘washed himself’, *hitnagev* ‘toweled himself down’, *hitaper* ‘applied makeup to himself’, *hitnadev* ‘volunteered himself’.

Reflexive verbs in *hitXaYeZ* may (67) or may not (68) have a causative variant in *XiYeZ*:

- (67) a. *jitsxak iper et tomi.*  
Yitzhak made.up.INTNS ACC Tommy  
‘Yitzhak applied make-up to Tommy.’  
b. *tomi hitaper.*  
Tommy made.up.INTNS.MID  
‘Tommy put on make-up.’ (\*‘Tommy got make-up applied to him’)
- (68) a. \*? *jitsxak kileax et tomi.*  
Yitzhak  $\sqrt{\text{klx}}$ .INTNS.Past ACC Tommy  
(int. ‘Yitzhak showered Tommy’)  
b. *tomi hitkaleax.*  
Tommy showered.INTNS.MID  
‘Tommy showered.’ (\*‘Tommy got showered’)

In Hebrew, verbs like those in (66) are only possible in *hitXaYeZ*. Reflexive verbs often pose puzzles in various languages, since these are cases in which one argument appears to have two thematic roles, agent and patient. The degree to which this configuration is tracked by the morphology varies by language. English shows no morphological difference between (69a–b), even though the readings clearly differ.

- (69) a. *Dana kicked.* ⇒ Dana kicked herself.  
b. *Dana shaved.* ⇒ Dana shaved herself.

While some languages, like English, do not differentiate morphologically between verbs like *shave* and verbs like *kick*, many languages do express reflexivity through morphological means. I will argue in Section 3.7.1.2 that the reflexive morphology of Hebrew reflects an internal composition of agentivity ( $\sqrt{\text{ACTION}}$ ) with no independent external argument (Voice<sub>[-D]</sub>), based on Kastner (2017).

Crosslinguistically, templates like *niXYaZ* and *hitXaYeZ* from this chapter are reminiscent of non-active markers such as Romance *se*, German *sich*, Russian *-sja* and the Greek non-active suffix *NACT*. Crosslinguistic work shows that this kind of marking is often syncretic between anticausatives, inchoatives, passives, middles, reciprocals and reflexives (Geniušienė 1987; Klaiman 1991; Alexiadou & Doron 2012; Kastner & Zu 2017). Yet unlike languages like French, for instance, where *se* might be ambiguous between a number of readings (reflexive, reciprocal and anticausative), *hitXaYeZ* is never ambiguous in Hebrew for a given root.<sup>11</sup> For while French *se* can be used in reflexive, reciprocal and non-active contexts with a variety of predicates (70), Hebrew *hitXaYeZ* is unambiguous in that a verb like *hitlabef* ‘got dressed’ is only reflexive (71). It cannot be used in an anticausative context, as shown by its incompatibility with ‘by itself’.

- (70) a. French reflexives and reciprocals, after Labelle (2008: 839)  
 Les enfants *se* sont tous soigneusement *lavés*.  
 the children *se* are all carefully washed.3PL  
 ‘The children all washed each other carefully.’ [reciprocal]  
 ‘The children all washed themselves carefully.’ [reflexive]
- b. French middle (Labelle 2008: 835)  
 Cette robe *se* *lave* facilement.  
 this dress *se* wash-3s easily  
 ‘This dress washes easily.’
- c. French anticausative (Labelle 2008: 835)  
 Le vase *se* *brise*.  
 the vase *se* breaks-3s  
 ‘The vase is breaking.’
- (71) Hebrew reflexives are not reciprocal:  
 luk ve-pjer *hitlabf-u*. (\*me-atmam).  
 Luc and-Pierre dressed.up.INTNS.MID-3PL from-themselves  
 ‘Luc and Pierre got dressed.’ [reflexive only]

<sup>11</sup>See Kastner (2017) for one possible counterexample, the verb *hitnaka* ‘cleaned up’.

Implementing the rest of our diagnostics, we see that reflexives straightforwardly allow Agent-oriented adverbs (72).

- (72) *josi hitgaleax* { **be-mejomanut / likrat ha-reajon** }.  
 Yossi shaved.INTNS.MID in-skill towards the-interview  
 ‘Yossi shaved skillfully / in preparation for his interview.’

They do not allow ‘by itself’, which is already degraded with animate arguments as we saw in (57b).

- (73) \* *josi hitgaleax* **me-atsmo**  
 Yossi shaved.INTNS.MID from-himself  
 (int. ‘Yossi’s shaving happened to him’)

They also do not pass the unaccusativity diagnostics.

- (74) # VS order:  
*hitkalx-u* **flofa xatulim** be-arba ba-boker.  
 showered.INTNS.MID-3PL three cats in-four in.the-morning  
 (int. ‘Three cats washed themselves at 4am.’)
- (75) # Possessive dative:  
*flofa xatulim hitkalx-u* **I-i** be-arba ba-boker.  
 three cats showered.INTNS.MID-3PL to-me in-four in.the-morning  
 ‘Three cats washed themselves at 4am and I was adversely affected.’  
 (# int. ‘My three cats washed themselves at 4am.’)
- (76) Episodic plural:  
*mitapr-im* **ba-rexov, bo lirot!**  
 make.up.INTNS.MID-PL.M in.the-street come see  
 ‘People are applying make-up in the street, come see!’

To summarize the empirical overview of *hitXaYeZ*, it is similar to *niXYaZ* in some respects and different in others. It, too, creates anticausatives and inchoatives (but no passives). It allows for figure reflexives and also for canonical reflexives. What we never see – again like *niXYaZ* – is a simple transitive construction consisting of subject, verb and direct object:<sup>12</sup>

<sup>12</sup>One distinct counterexample is *hitstarex* ‘needed’; see Harves & Kayne (2012: 130fn16).

(77) Generalizations about *hitXaYeZ*

- a. *Configurations*: Verbs appear in unaccusative, figure reflexive and reflexive structures, but not in a simple transitive configuration.
- b. *Alternations*: Some verbs are anticausative or reflexive versions of verbs in *XiYeZ*.

This constellation of facts can be accounted for once we clarify the composition of  $\sqrt{\text{ACTION}}$  and Voice<sub>[-D]</sub>. The root also plays an important part, as alluded to above, but that aspect of the data will not be discussed in depth here.

### 3.7 Adding $\sqrt{\text{ACTION}}$ to [-D]

The data above highlights the puzzle of reflexive verbs: why are they possible in *hitXaYeZ* and only in *hitXaYeZ*? In this section I provide analyses of the phenomena above, all based on the idea that this template is morphosyntactically (and hence morphophonologically) the most complex. Reviewing the analysis in Kastner (2017), I will propose that reflexives and anticausatives share an unaccusative structure, but that the root constrains the derivation in a specific way. Reflexive verbs are argued to be the result of unaccusative syntax (Voice<sub>[-D]</sub>) with an agentive modifier ( $\sqrt{\text{ACTION}}$ ) and particular, self-oriented lexical semantics. The crucial point for our overall purposes is that the reflexive readings fall out from the unique combinatorics of Voice<sub>[-D]</sub> and  $\sqrt{\text{ACTION}}$ , a combination of elements which no other “template” can provide.

Section 3.7.1 analyzes the combination of  $\sqrt{\text{ACTION}}$  with Voice<sub>[-D]</sub>, yielding non-active verbs and reflexives. Section 3.7.2 rounds off the picture with the derivation of figure reflexives.

#### 3.7.1 $\sqrt{\text{ACTION}}$ + Voice<sub>[-D]</sub>

##### 3.7.1.1 Non-active verbs

Syntactic structure building proceeds as usual. We will see this by deriving the alternation between causative *pirek* in *XiYeZ* and anticausative *hitparek* in *hitXaYeZ*. The combination of  $\sqrt{\text{ACTION}}$  and vP predicts that an event expressed by [ $\sqrt{\text{ACTION}}$  vP] can either receive an external argument, if we merge Voice, or not, if we merge Voice<sub>[-D]</sub>. This state of affairs is exactly what we find; much of the literature talks of *XiYeZ* and *hitXaYeZ* alternating (Doron 2003, Arad 2005, as well as much previous work and the traditional grammars).



(78) a. Core vP

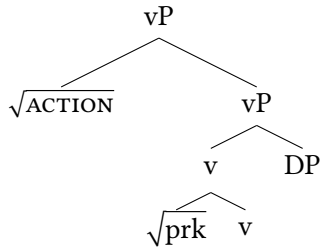

b. *pirek* 'dismantled'

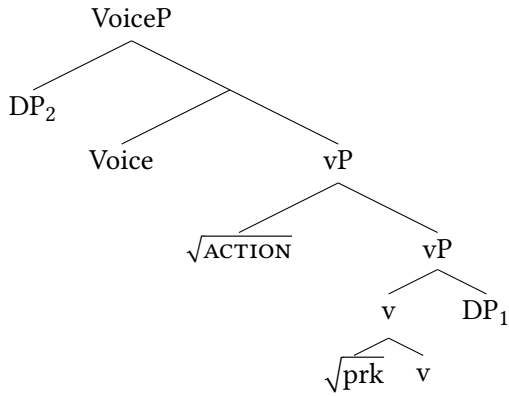

c. *hitparek* 'fell apart'

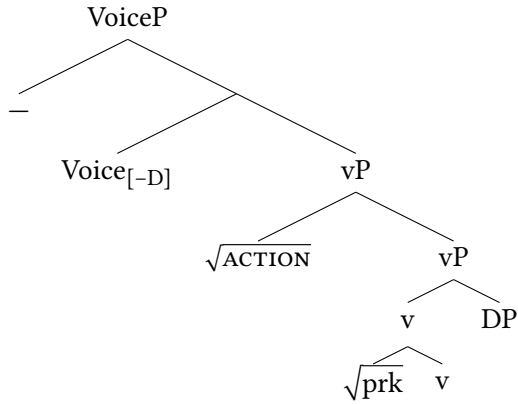

### 3 Voice<sub>[-D]</sub>

The semantics relevant to  $\sqrt{\text{ACTION}}$  is repeated in (79):

- (79)  $\llbracket \text{Voice} \rrbracket =$   
 a.  $\lambda P.P$  /  $\_\_ \{ \sqrt{\text{npI}} \text{ 'FALL'}, \sqrt{\text{kpa}} \text{ 'FREEZE'}, \dots \}$   
 b.  $\lambda x \lambda e. \text{Agent}(x,e)$  or  $\lambda x \lambda e. \text{Causer}(x,e)$   
 c.  $\lambda x \lambda e. \text{Agent}(x,e)$  /  $\_\_ \sqrt{\text{ACTION}}$

In this section we will see two allosemes of Voice<sub>[-D]</sub>, one the identity function we are familiar with (80c) and one the agentive version we would expect from  $\sqrt{\text{ACTION}}$  (80a). The passive alloseme (80b) is repeated for completeness, but there is no rule invoking it in the context of  $\sqrt{\text{ACTION}}$ .

- (80) a.  $\llbracket \text{Voice}_{[-D]} \rrbracket \leftrightarrow \lambda x \lambda e. \text{Agent}(x,e)$  /  $\_\_ \sqrt{\text{ACTION}}$   
 b.  $\llbracket \text{Voice}_{[-D]} \rrbracket \leftrightarrow \lambda P \lambda e \exists x. \text{Agent}(x,e) \ \& \ P(e)$  /  $\_\_ \{ \sqrt{\text{rtsx}} \text{ 'murder'}, \sqrt{\text{mr}} \text{ 'say'}, \dots \}$   
 c.  $\llbracket \text{Voice}_{[-D]} \rrbracket \leftrightarrow \lambda P_{\langle s,t \rangle}. P$

When we put the pieces together, however, we find that we do not get *anti-causative* (causative but non-agentive) semantics. The translations in (80) cannot be the whole story because (80a) straightforwardly entails agentive semantics for verbs in *hitXaYeZ*.

Kastner (2017) proposes that the rule of allosemy in (81) removes the agentivity requirement of  $\sqrt{\text{ACTION}}$  for roots such as  $\sqrt{\text{prk}}$  which give anticausatives. Kastner (2016; 2017) develops a view of roots according to which their lexical semantics determines, at least in part, whether they will trigger the rule in (81). This change renders the resulting verb *hitparek* 'fell apart' anticausative, rather than a potential reflexive such as 'tore himself to pieces'.

- (81)  $\llbracket \sqrt{\text{ACTION}} \rrbracket \rightarrow \emptyset$  /  $\text{Voice}_{[-D]} \_\_ \{ \sqrt{\text{XYZ}} \mid \sqrt{\text{XYZ}} \in \{ \sqrt{\text{prk}} \text{ 'DISMANTLE'}, \sqrt{\text{b}l} \text{ 'COOK'}, \sqrt{\text{ptsts}} \text{ 'EXPLODE'}, \dots \}$

The process can be likened to impoverishment (Bonet 1991; Noyer 1998) in the semantic component (cf. Nevins 2015).

Another way of encoding this information would have been to build it right back into the denotations of Voice, as in (82):

- (82) Addition to (80), to be rejected:  
 $\llbracket \text{Voice}_{[-D]} \rrbracket = \lambda P_{\langle s,t \rangle}. P$  /  $\_\_ \sqrt{\text{ACTION}} \{ \sqrt{\text{prk}} \text{ 'DISMANTLE'}, \sqrt{\text{b}l} \text{ 'COOK'}, \sqrt{\text{ptsts}} \text{ 'EXPLODE'}, \dots \}$

The problem here is one of locality: the root is separated from  $\text{Voice}_{[-D]}$  by  $\sqrt{\text{ACTION}}$ . Existing theories of contextual allosemy maintain a strict linear adjacency requirement between trigger and alloseme (Marantz 2013; Kastner 2016). The kind of action-at-a-distance typical of roots licensing a head is more similar to impoverishment, which again happens at a distance.

To summarize informally,  $\sqrt{\text{ACTION}}$  brings in an agentive requirement, but it is also close enough to the root for certain roots to disable this requirement. It is probably no accident that these roots relate to events which are OTHER-ORIENTED like dismantling and cooking; see Kastner (2017) for additional discussion of this point. But whatever the formal analysis, the current system explains why anticausatives in *hitXaYeZ* look like de-transitivized versions of causatives in *XiYeZ*:  $\text{Voice}_{[-D]}$  is added to the same structure (vP) that regular Voice would have been added to.

With anticausatives explained, not much remains to be said about *inchoatives* beyond the discussion of those in *niXYaZ* from Section 3.3.2. And finally, *passives* do not arise either. This behavior is captured by the rules in (80) but is not explained by them (we could just as well have written a rule generating the passive alloseme of  $\text{Voice}_{[-D]}$  in the context of  $\sqrt{\text{ACTION}}$ ). I have no deeper explanation to propose at this point. Returning to a simple composition of  $\text{Voice}_{[-D]}$  and  $\sqrt{\text{ACTION}}$ , however, leads us to an understanding of reflexives.

### 3.7.1.2 Reflexives

The intuition behind the analysis of reflexives is as follows: reflexive verbs in *hitXaYeZ* consist of an unaccusative structure with extra agentive semantics. This combination is only possible if the internal argument is allowed to saturate the semantic function of an external argument by delayed saturation, in the way formalized here.

The structure and semantic derivation in Figure 3.5 fleshes out the derivation of the reflexive verb in (83).

- (83) dani *hitraxets*.  
 Danny washed.INTNS.MID  
 ‘Danny washed (himself).’

The argument DP, ‘Danny’, starts off as the internal argument. No external argument is merged in the specifier of  $\text{Voice}_{[-D]}$  and the structure is built up as usual. Nevertheless, the specifier of T needs to be filled because of a syntactic requirement, namely the EPP. The internal argument then raises directly to

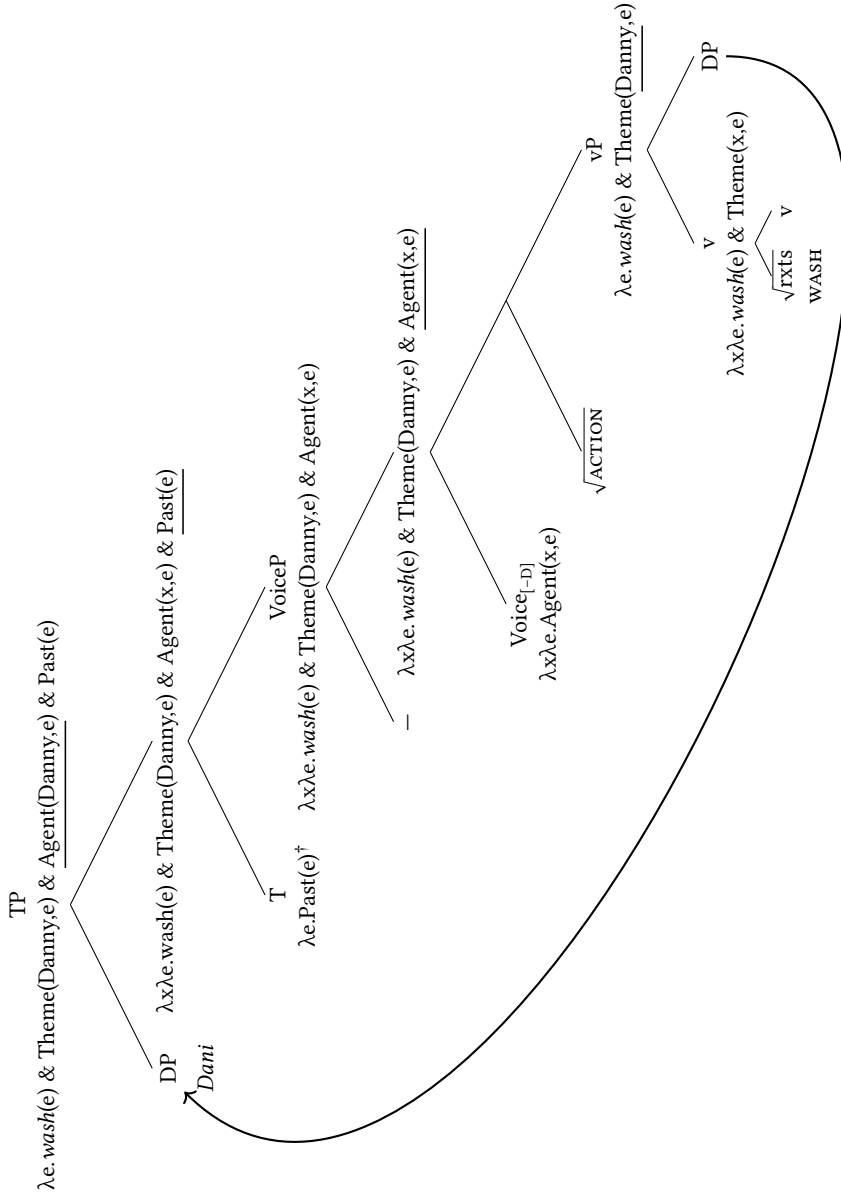

Figure 3.5: Derivation of (83). †: The exact denotation of T is immaterial here.

Spec,TP in order to satisfy the EPP, checking the syntactic feature but also satisfying the Agent role of Voice $[-D]$  in delayed saturation (Section 3.4.1.2).

The crucial points in this derivation are the VoiceP node and Spec,TP: after the internal argument raises to Spec,TP, the derivation can converge. The resulting picture is similar to that painted by Spathas et al. (2015) for certain reflexive verbs in Greek, where the agentive modifier *afto* combines with non-active Voice to derive a reflexive reading; see Spathas et al. (2015) or Kastner (2017) for further details on the Greek.<sup>13</sup>

As with figure reflexives, one would be justified in wondering whether other material between vP and TP could intervene, disrupting this derivation. And as with figure reflexives, if we try to think of how applicatives fit in we see that the exact nature of the possessive dative is unclear. If we treat the construction as transitive (since there is an internal argument), the possessive dative is a low applicative, meaning that the ApplP would be too low to influence the derivation. In any case the possessor DP never raises out of its applicative PP to Spec,TP, a configuration which would have disrupted this derivation. And if we were to treat this construction as unergative (one argument with an Agent role) then the nature of the dative is different (Bar-Asher Siegal & Boneh 2015; 2016).

What about clauses smaller than TP? Embedded clauses in Hebrew are either full CPs with an overt complementizer such as *fe-* ‘that’ or infinitival clauses. Hebrew verbs have an infinitival prefix, *le-*, which presumably spells out T, indicating that the TP layer is intact.

- (84) *josi ratsa le-hitkaleax.*  
 Yossi wanted to-shower.INTNS.MID  
 ‘Yossi wanted to take a shower.’

This leaves us with nominalizations. It is standard to assume that nominalizations preserving the argument structure of the underlying verb are derived by merging a nominalizer with the verbal constituent, here VoiceP (as discussed in Section 5.3). In this case there really is no embedded T layer.

<sup>13</sup> $\sqrt{\text{ACTION}}$  is different than Greek *afto*, and Voice $[-D]$  different from Greek Non-active Voice in a number of respects I cannot treat here but list for future reference. (i) Greek non-active is passive-like in Naturally Reflexive Verbs (*wash*) and Naturally Disjoint Verbs (*accuse/praise/destroy*). (ii) *Afto* is only possible with Non-Active Voice, whereas  $\sqrt{\text{ACTION}}$  can combine with Unspecified Voice. (iii) The combination of *Afto* and Non-active Voice always yields reflexives. (iv) *Afto* only combines with Naturally Disjoint Verbs.

### 3 Voice<sub>[-D]</sub>

I can imagine two scenarios here, both promising but neither more convincing than the other at this point. The first is that if *n* projects a covert *pro* as the external argument, then this DP will be able to take on the open Agent role.<sup>14</sup> The second is simply a prediction that reflexives in *hitXaYeZ* should not have a valid nominalization. This claim has not been made before (as far as I know) and the data is unclear, judging by a few informal consultations:

- (85) a. % *hitgalxut-o*                      *fel dani lemefex eser dakot*  
           shave.INTNS.MID.NMLZ-of of Danny during ten minutes  
           *hergiza otanu.*  
           annoyed.CAUS us  
           (int. ‘Danny’s shaving for ten minutes annoyed us’)
- b. % *ha-histarkut*                      / *ha-hitaprut*  
           the-comb.INTNS.MID.NMLZ the-makeup.INTNS.MID.NMLZ  
           *he-mejumenet fel ha-jeled.*  
           the-skilled of the-boy  
           (int. ‘the boy’s skilled combing / application of makeup’)

A much larger set of verbs would have to be tested in order to fully understand the pattern.

On another note, I have been treating reflexives as underlyingly unaccusative even though they pass agentivity diagnostics and fail unaccusativity diagnostics. The question is what these diagnostics are actually diagnosing. Assuming that the agentivity diagnostics are semantic in nature concords with the current analysis, since the Agent role is saturated (this is why passives pass these tests). The unaccusativity diagnostics are more complicated: Kastner (2017) summarizes evidence indicating that the requirement for the possessive dative might be semantic as well, and further speculates that VS order only obtains with surface unaccusatives (where the internal argument remains low; see Levin & Rappaport Hovav 1995).

Overall, the analysis showcases how complex structure (Voice<sub>[-D]</sub> and  $\sqrt{\text{ACTION}}$ ) correlates with complex meaning and complex morphology. On the meaning side of things, reflexives in Hebrew do not come from a dedicated functional or lexical item. There must be some confluence of factors in order to derive a reflexive reading. The complex structure is tracked by complex morphology:

<sup>14</sup>This is the standard assumption for nominalizations at the moment, as recapped in Section 5.3. On a theory in which *n* existentially closes over the Agent, the derivation might still be able to go through, depending on specific assumptions regarding Spec,*n* and the compositional semantics.

verbs in *hitXaYeZ* have a number of distinguishing morphophonological properties, namely the prefix, the non-spirantized medial root consonant  $\text{X}$ , and the stem vowels inherent to the template. A verb like *titnadev* ‘she will volunteer’ is derived as follows (see Kastner 2019b):

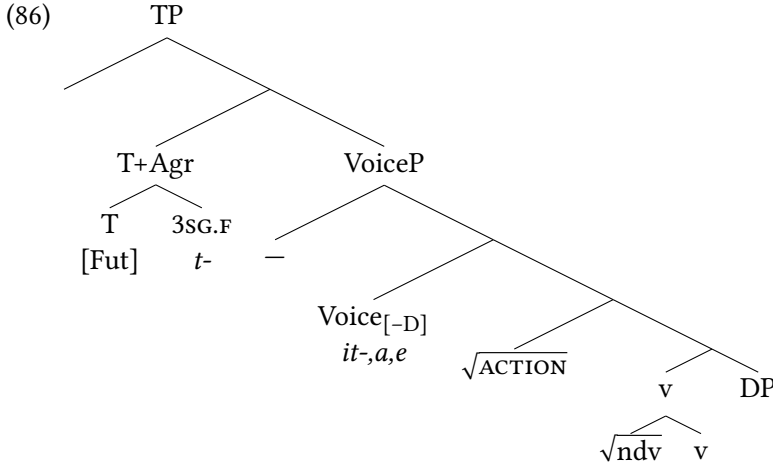

(87) Vocabulary Items:

- a.  $\sqrt{\text{ndv}} \leftrightarrow \text{ndv}$
- b.  $\sqrt{\text{ACTION}} \leftrightarrow [-\text{cont}]_{\text{ACT}} / \_ \{ \sqrt{\text{XYZ}} \mid Y \in \text{p, b, k} \}$
- c.  $\text{Voice}[-D] \leftrightarrow \text{it},a,e / \text{T}[\text{Fut},3\text{SG.F}] \_ \sqrt{\text{ACTION}}$
- d.  $3\text{SG.F} \leftrightarrow t / \_ \text{T}[\text{Fut}]$

(88) Phonology:  $t + /it-a,e-ndv/ \rightarrow t + [\text{it.na.dev}] \rightarrow [\text{tit.na.dev}]$

### 3.7.2 $\sqrt{\text{ACTION}} + p[-D]$

The final piece of the jigsaw is figure reflexives in *hitXaYeZ*. At this point, it is easy to see where this piece fits. The semantics of a figure reflexive  $p[-D]$  is augmented by the agentive requirement of  $\sqrt{\text{ACTION}}$ . Everything said about the semantics and phonology of these elements continues to hold; a representative derivation is given in Figure 3.6 for example (89).

- (89) *bjartur hiftaxel la-xeder.*  
 Bjartur squeezed.INTNS.MID to.the-room  
 ‘Bjartur squeezed his way into the room.’

Having concluded the analytical part of this chapter, I summarize the findings in Section 3.8. Some alternatives are mentioned in Section 3.9, followed by a bigger-picture view of where this fits within the book.

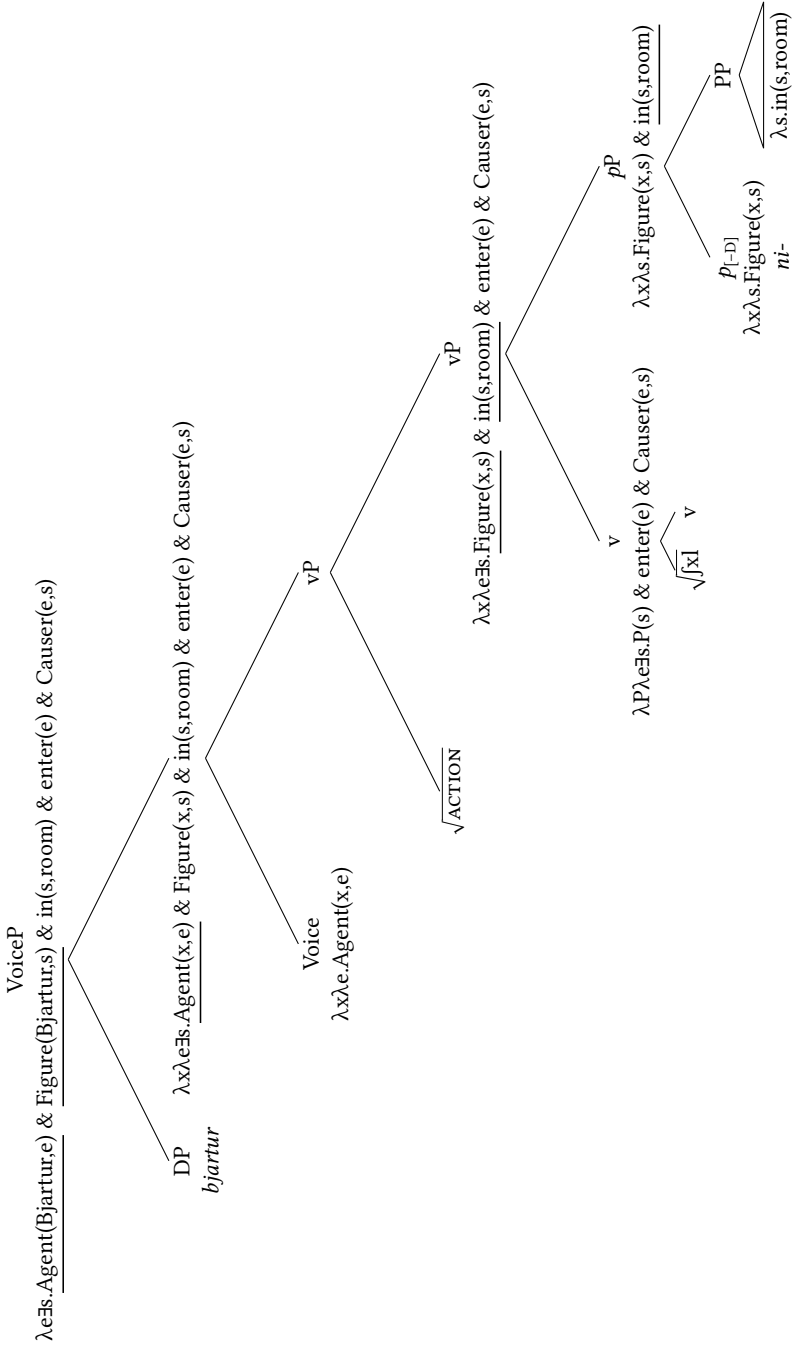

Figure 3.6: Derivation of (89)



### 3.8 Summary of generalizations and claims

The generalizations about each of *niXYaZ* and *hitXaȳeZ* are repeated in (90–91).

- (90) Generalizations about *niXYaZ*
- Configurations*: Verbs appear in unaccusative, passive and figure reflexive structures, but never in a simple transitive configuration.
  - Alternations*: Some verbs are anticausative or passive versions of verbs in *XaYaZ*.
- (91) Generalizations about *hitXaȳeZ*
- Configurations*: Verbs appear in unaccusative, figure reflexive and reflexive structures, but not in a simple transitive configuration.
  - Alternations*: Some verbs are anticausative or reflexive versions of verbs in *XiȳeZ*.

Remember, however, that *TEMPLATE* is a descriptive term for certain morphophonological forms. The traditional view is that a template is a morphological primitive with its own uniform phonology, syntax and semantics. The assumptions in this book are different: verbs are built up syntactically, and it could be that some structures end up with similar or even identical morphology. But the real distinction is between syntactic structures (and their interpretation). The anticausatives and figure reflexives that share the template *niXYaZ* are no more related syntactically than the English past tense verb and past participle sharing the suffix *-ed*; perhaps there is an underlying similarity there, but it would need to be argued for.

Summary Table 3.13, repeated from the introductory section, recaps.

Table 3.13: Verbs with [-D]

| Construction |                  | <i>niXYaZ</i>            | <i>hitXaȳeZ</i>                                   |
|--------------|------------------|--------------------------|---------------------------------------------------|
| Non-active   | Anticausative    | Voice <sub>[-D]</sub>    | $\sqrt{\text{ACTION}}$ , Voice <sub>[-D]</sub>    |
|              | Inchoative       | Voice <sub>[-D]</sub>    | $\sqrt{\text{ACTION}}$ , Voice <sub>[-D]</sub>    |
|              | Passive          | Voice <sub>[-D]</sub>    | —                                                 |
| Active       | Figure reflexive | <i>p</i> <sub>[-D]</sub> | $\sqrt{\text{ACTION}}$ , <i>p</i> <sub>[-D]</sub> |
| Reflexive    | Reflexive        | —                        | $\sqrt{\text{ACTION}}$ , Voice <sub>[-D]</sub>    |

It is not accurate to call *niXYaZ* a “passive” template, nor is *hitXaYeZ* the “reflexive” template. These constructions are possible, but what is more important is the structures giving rise to them. In addition, the existence of figure reflexives has been documented and analyzed, providing support for a non-uniform analysis of superficially similar intransitive forms.

Reflexive verbs appear only in the template *hitXaYeZ*, a fact which had not previously received any formal analysis. In a system such as the one put forward in this book, combining the agentivity requirement of  $\sqrt{\text{ACTION}}$  with the single-argumenthood of *Voice*<sub>[-D]</sub> derives this pattern. This analysis receives additional confirmation in the morphology, where the spell-out of both  $\sqrt{\text{ACTION}}$  and *Voice*<sub>[-D]</sub> can be seen.

The analyses in this chapter call into question any attempt to view templates as independent morphemes as well as other decompositional accounts. Some of these views are challenged next.

### 3.9 Discussion and outlook

The Theory of Trivalent Voice leads us to an EMERGENT view of templates, according to which they arise from the combination of functional heads.

The traditional approach to Semitic templates has been to treat them as independent atomic elements, i.e. morphemes. Contemporary work in this vein spans highly divergent implementations but includes Arad (2003; 2005), who decomposed verbal templates into flavors of *v*, spell-outs of Voice and conjugation classes; Borer (2013), for whom different templates are different “functors”; Aronoff (1994; 2007), who identifies templates with conjugation classes; and Reinhart & Siloni (2005), Schwarzwald (2008) and Laks (2011; 2014), whose lexicalist accounts similarly grant morphemic status to verbal templates.

As far as morphemic analyses are concerned, an overarching problem is that a given template does not have a deterministic syntax nor does it have a deterministic semantics. The morphemic analysis would have to say that *niXYaZ* is ambiguous between a non-active and figure reflexive reading, or that *hitXaYeZ* is three-way ambiguous between an anticausative, figure reflexive and canonical reflexive. Two crucial problems then arise. The first is that not all verbs in these templates are ambiguous. The second is that the existing readings are an accident; the templates could just as well have been ambiguous between a transitive and a reflexive reading, but no Hebrew template has this property. Decompositional theories have principled explanations for what is and is not possible, as with *niX-YaZ* where I have shown a morphological correlation between lack of Agent and

lack of Figure. In contrast, a morphemic theory might be unnecessarily powerful and would arbitrarily list what each template, and perhaps each verb, may do. To see this, I will consider two major theories of Hebrew morphology, those of Doron (2003; 2015) and Arad (2003; 2005). See Kastner & Tucker (submitted) for additional background and theoretical discussion.

These two alternative theories are exemplified below using the three-way alternation between a transitive verb in *XaYaZ*, an “intensive” transitive in *XiYēZ* and an anticausative in *hitXaYeZ*. The relevant data are as follows:

- (92) a. *ha-martsa kav'-a et moed ha-bxina.*  
 the-lecturer.F set.SMPL-F ACC date.of the-exam  
 ‘The lecturer set the exam date.’
- b. *ejet rof ha-memfala kib'-a et maamad-a*  
 wife.of head.of the-government set.INTNS-F ACC standing-hers  
*ba-xevra.*  
 in.the-society  
 ‘The Prime Minister’s wife cemented her place in society.’
- c. *maamad ejet rof ha-memfala hitkabea*  
 standing.of wife.of head.of the-government set.INTNS.MID  
*ba-xevra.*  
 in.the-society  
 ‘The Prime Minister’s wife status in society was established.’

In the Trivalent Theory, this three-way alternation is built on the core vP. Merging Voice gives the simple transitive verb (93a). Attaching  $\sqrt{\text{ACTION}}$  to the vP modifies its semantics, (93b). Merging Voice<sub>[-D]</sub> instead of Voice gives the anticausative variant (93c). I use “EA” for the external argument DP and “IA” for the internal argument DP in order to avoid ambiguity below.

- (93) a. *kava* ‘set’:

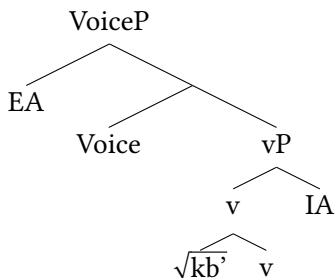

### 3 Voice<sub>[-D]</sub>

b. *kibea* ‘cemented’:

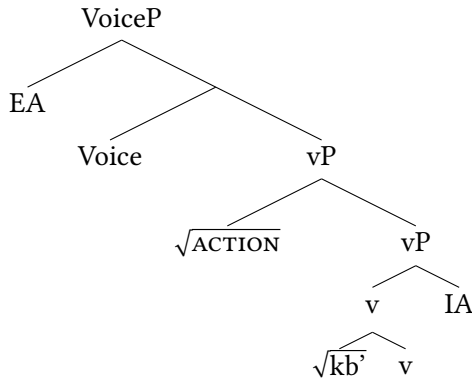

c. *hitkabea* ‘was cemented’:

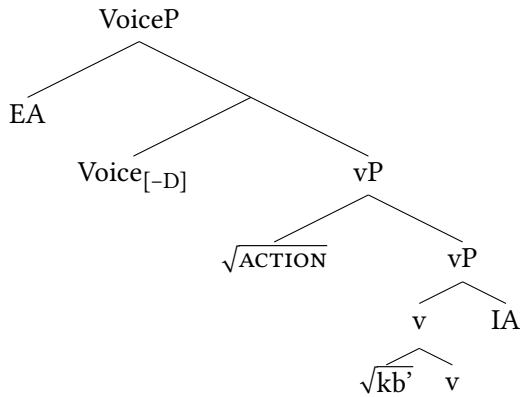

### 3.9.1 Distributed morphosemantics (Doron 2003)

Within the decompositional theories, the most obvious alternative is the morphosemantic system of Doron (2003), a direct forebear to the current theory. That system was the first to identify basic non-templatic elements that combine compositionally in order to form Hebrew verbs. For example, a MIDDLE head  $\mu$  was used to derive the “middle” template *niXYaZ*, where I make use of Voice<sub>[-D]</sub>.

#### 3.9.1.1 The three-way alternation

Let us see how the alternations in (92) are derived. In this theory, the root provides the basic semantics and introduces the internal argument itself. Little *v* introduces the external argument and the Agent role (like my Voice). This combination yields (94a). The head INTNS is the inspiration for  $\sqrt{\text{ACTION}}$ , modifying

the event and adding an Agent role if none was there yet. This head also spells out  $Xi\bar{Y}eZ$ , as in (94b). The alternation, then, “happens” very low, at the level of root-attachment. Adding the non-active head MID instead of  $v$  removes the requirement for an Agent and spells out  $hitXa\bar{Y}eZ$  together with the INTNS head, (94c). Note how the internal argument now merges later.

(94) a. *kava* ‘set’:

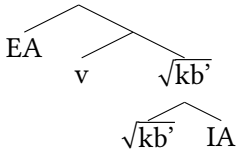

b. *kibea* ‘cemented’:

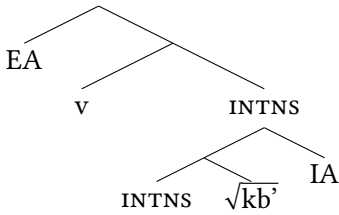

c. *hitkabea* ‘was cemented’:

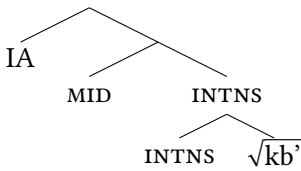

The important conceptual difference is that my elements are syntactic whereas those of Doron (2003) can be characterized as morphosemantic: each one had a distinct semantic role, but what regulates the syntactic licensing of arguments remained unclear. A Doron-style system takes the semantics as its starting point, attempting to reach the templates from syntactic-semantic primitives signified by the functional heads. Such a system runs into the basic problem of Semitic morphology: one cannot map the phonology directly onto the semantics. For example, there is no way in which a causative verb has a unique morphophonological exponent.

### 3.9.1.2 Additional issues

On the empirical side, more concretely, the morphosemantic theory did not engage with figure reflexives directly but instead derived all reflexive readings using a REFL head. This is not a useful morphosyntactic construct since it cannot

### 3 Voice<sub>[-D]</sub>

distinguish, on its own, between a figure reflexive, a reflexive verb such as ‘shave’ and a construction with an anaphor such as ‘shave yourself’. Yet we have seen that figure reflexives have specific syntactic and semantic characteristics which distinguish them from intransitive reflexives like *hitgaleax* ‘he shaved’ (which, for instance, does not require or even allow a prepositional phrase complement).

A similar problem arises when Doron (2003: 60) derives reflexives in *hitXaYeZ* by assuming that a head MID assigns the Agent role for this root. This explains why *histager* ‘secluded himself’ is agentive, hence reflexive. However, if the only relevant elements are Voice<sub>[-D]</sub> and the root, then a verb in the same root in *niXYaZ* (where I have Voice<sub>[-D]</sub> and Doron 2003 has MID) is also predicted to be agentive. This expectation is incorrect: *nisgar* ‘closed’ is unaccusative. That analysis is almost a mirror image of the one presented here: while I let  $\sqrt{\text{ACTION}}$  add agentivity to a structure with Voice<sub>[-D]</sub>, thereby deriving reflexives, the morphosemantic account invokes added agentivity for certain roots, bypassing the syntax in ways that lead to false predictions.

While each part of this problem could be overcome on its own, the system as a whole has little to say about the unaccusative (for anticausatives) and unergative (for reflexives) characteristics of verbs in *hitXaYeZ*, since it is not based strictly on the syntax. I conclude, then, that “templates” are the by-product of functional heads combining in the syntax in systematic ways, in support of the general system developed in this book. Where we have made progress is by flipping one of the assumptions on its head: that the primitives have strict syntactic content and flexible semantic content, rather than strict semantic content and unclear syntactic content.

#### 3.9.2 Templates as morphemic elements

The most explicit analysis other than Doron’s (2003) with which the Trivalent proposal can be contrasted is the foundational work by Arad (2003; 2005). Unlike Doron’s work and the current proposal, Arad (2005)’s work attempted to scale back some of the structural commitments about alternations.

##### 3.9.2.1 The three-way alternation

Syntactically, a standard structure in Arad (2005) is built up using a root, *v* and Voice. The verbalizer *v* additionally has four semantic “flavors”. The template is divided phonologically into a prosodic skeleton on *v* and vowels on Voice. In order to fit these morphosyntactic pieces, a number of additional assumptions are required. First, roots select the templates they appear in, as a given root may

idiosyncratically appear only with certain templates (as in the current theory). Second, there are four syntactic flavors of *v*: unmarked, stative, inchoative and causative, in order to account for the argument structural correlates of the templates. Finally, in order to specify which templates alternate with which, Arad must stipulate conjugation classes. For example, in Conjugation Class 4,  $Xi\check{Y}eZ$  is the causative variant and  $hitXa\check{Y}eZ$  is the inchoative variant (Arad 2005: 220). It is assumed that the anticausative alternation goes from inchoative to causative.

What this theory then does is specify spell-out rules using two sets of diacritics: which template a given flavor of *v* spells out, and which conjugation class this variant participates in.<sup>15</sup> A subset of the spell-out rules is reproduced next, with the ones relevant to the examples in (92) highlighted (Arad 2005: 230–231). Rules for individual templates are given first in each block, followed by rules for conjugation classes.

(95) Distributed Conjugation Diacritics in Arad (2005):

- |                                                                                                                                                                                                                                                                                             |                                                                                                                                                                                                                                                                             |
|---------------------------------------------------------------------------------------------------------------------------------------------------------------------------------------------------------------------------------------------------------------------------------------------|-----------------------------------------------------------------------------------------------------------------------------------------------------------------------------------------------------------------------------------------------------------------------------|
| <p>a. <math>v_{unmarked}</math>:</p> <p><math>\alpha \rightarrow XaYaZ</math></p> <p><math>\beta \rightarrow niXYaZ</math></p> <p><math>\gamma \rightarrow Xi\check{Y}eZ</math></p> <p><math>\delta \rightarrow heXYiZ</math></p> <p><math>\epsilon \rightarrow hitXa\check{Y}eZ</math></p> | <p>c. <math>v_{stat}</math>:</p> <p><math>\alpha \rightarrow XaYaZ</math></p> <p>Class 3 <math>\rightarrow XaYaZ</math></p> <p>Class 5 <math>\rightarrow XaYaZ</math></p>                                                                                                   |
| <p>b. <math>v_{inch}</math>:</p> <p><math>\alpha \rightarrow XaYaZ</math></p> <p>...</p> <p><math>\epsilon \rightarrow hitXa\check{Y}eZ</math></p> <p>...</p> <p>Conjugation 4 <math>\rightarrow hitXa\check{Y}eZ</math></p> <p>...</p>                                                     | <p>d. <math>v_{caus}</math>:</p> <p><math>\gamma \rightarrow Xi\check{Y}eZ</math></p> <p><math>\epsilon \rightarrow heXYiZ</math></p> <p>Conjugation 1 <math>\rightarrow XaYaZ</math></p> <p>...</p> <p>Conjugation 4 <math>\rightarrow Xi\check{Y}eZ</math></p> <p>...</p> |

Causative *kava* ‘set’ is derived by applying the relevant rule from (95a), which essentially allows a root to appear in  $XaYaZ$ . The alternation between  $XaYaZ$  and  $Xi\check{Y}eZ$  is not considered grammatical enough to be formalized in this theory, so we move to the alternation between *kibea* ‘cemented’ and *hitkabea* ‘was cemented’. This is an alternation in which the former verb is causative and the latter anticausative, and so we find the causative template in (95d) and the anticausative (“inchoative”) template in (95b). The two are matched up in Conjugation Class 4.

<sup>15</sup>Arad (2005: 227fn41) claims that the diacritics are notationally equivalent to rules in the Encyclopedia, allowing them to interpret large segments of syntactic structure.

### 3 Voice<sub>[-D]</sub>

Using the correct flavors of *v* and the correct conjugation class ensures that only attested interpretations of the templates arise. There are no stative verbs in *XiYeZ* or *hitXaYeZ*, for example, because stative *v* only has rules that insert *XaYaZ*.

Since the goal of this work is to reduce the amount of generality encoded by the system, the technical outcome is appropriate. This does mean, however, that the theory ends up with functional structure which does not determine argument structure but is simply correlated with it, unlike in the current approach. In addition, most of the syntactic work is carried out by the flavors of *v*, but these have no unique spell-out, raising the question of whether there is any independent motivation for them beyond accounting for the conjugation classes themselves. Almost by design, this theory of Hebrew cannot easily be adapted to the morphology of any non-Semitic language.

#### 3.9.2.2 Additional issues

Syntactic and lexicalist accounts both need to stipulate that only a subset of roots (or stems) licenses reflexive derivations. What is at issue here is the status of the template. The general problem with morphemic approaches to templates is that a given template simply does not have a deterministic syntax or semantics, as already seen time and time again in the last two chapters. Arad (2005: 197) and Borer (2013: 564) can even be read as speculating that a configurational approach (like the current theory) might be more viable than a feature-based or functor-based approach. As far as the treatment of reflexives is concerned, morphemic accounts can go no further than stipulating that *hitXaYeZ* is the template for reflexive verbs.

#### 3.9.3 Conclusion

This chapter considered a range of data and constructions in Hebrew, some familiar and some new, providing analyses based on the premise that the verbal templates are not atomic morphological elements. Instead, the Trivalent Theory of Voice allows us to distinguish Unspecified Voice from Voice<sub>[-D]</sub>, as well as their relationship to the core *vP*. Thinking in terms of features on heads lets us make use of *p*<sub>[-D]</sub>, and the data in Hebrew and other languages suggests a partly lexical, partly functional element  $\sqrt{\text{ACTION}}$ .

The kinds of questions asked here were of the following type: if *hitXaYeZ* were simply a morphological primitive (Reinhart & Siloni 2005), why would it be the only one to allow for reflexive verbs? And why should it have complex morphology? If *niXYaZ* were a morphological primitive, how can it allow for both



non-active and active constructions? These facts make sense under the current decompositional view, in which functional heads build up verbs in the syntax. Certain correlations can then be explained: that *hitXaYeZ* is both morphophonologically and semantically complex, for example, or that reflexives and anticausatives appear to have a shared base. The system developed here provides answers based on functional heads required elsewhere in the grammar.

In the next chapter I develop the system further, examining the “causative” template *heXYiZ* and the last value of Voice, Voice<sub>[+D]</sub>, in similar fashion to this chapter and the previous one.



# 4 Voice<sub>[+D]</sub>

## 4.1 Introduction

When looking at the verbal system of Hebrew, it has been my goal to understand which syntactic environments a template appears in and what alternations the templatic morphology tracks. The alternations examined in this book so far have been anticausative, descriptively speaking. Taking *XaYaZ* or *XiYeZ* to be an intuitive base form, I then derived anticausative versions in *niXYaZ* and *hitXaYeZ*. Of course, I have also argued that what is actually happening is quite different, conceptually: the core vP is always there, but we either add Voice or add Voice<sub>[-D]</sub>. The former can give us causative verbs and the latter anticausative ones.

In this chapter we turn our attention to what can be seen as causative alternations. The following basic observation has been guiding us throughout the book: Hebrew shows morphological marking of both causative and anticausative forms, in addition to a “simple” verbal form, which itself can be either causative or anticausative. See in particular the middle column of Table 4.1, repeated from Chapter 1. This three-way distinction leads to the Trivalent Theory of Voice defended in the book.

Table 4.1: Some alternations in Hebrew

| non-active                  | unspecified          | active                   |
|-----------------------------|----------------------|--------------------------|
| <i>niXYaZ</i>               | <i>XaYaZ</i>         | <i>heXYiZ</i>            |
| <i>neexal</i> ‘was eaten’   | <i>axal</i> ‘ate’    | <i>heexil</i> ‘fed’      |
| <i>nixtav</i> ‘was written’ | <i>katav</i> ‘wrote’ | <i>hextiv</i> ‘dictated’ |
| – (idiosyncratic gap)       | <i>nafal</i> ‘fell’  | <i>hepil</i> ‘dropped’   |

The formal literature on transitivity alternations has, to a large extent, focused on comparing transitive verbs to their anticausative counterparts. It is perhaps no accident that this literature has also been based for the most part on European languages. In this chapter I examine *heXYiZ* in depth and propose the addition of the head Voice<sub>[+D]</sub> to our toolbox, a functional head distinct from ordinary Voice

(and as such a novel theoretical proposal). I will first describe the general properties of the template *heXYiZ* in Section 4.2.<sup>1</sup> An analysis using *Voice*<sub>[+D]</sub> follows in Section 4.3. We will then look more closely at the relationship between a verb in *XaYaZ* and its alternants in *niXYaZ* and *heXYiZ* in Section 4.4. This discussion will be followed in Section 4.5 by a comparison with alternative approaches. Section 4.6 provides a summary.

## 4.2 *heXYiZ*: Descriptive generalizations

The template *heXYiZ* is traditionally called the “causative” one: verbs instantiated in it are often causative versions of a verb in *XaYaZ* (or *niXYaZ*; see 4.5.1). In practice, these verbs are active, i.e. transitive or unergative. I use the term CAUSATIVE informally because there is no syntactic implementation of this term which is appropriate. This is, however, the traditional name, and in most transitive uses it makes intuitive sense.

The database of Ehrenfeld (2012) and Ahdout (in prep) lists 500–600 verbs in *heXYiZ*. Of these, more than 500 are active. They are described in Section 4.2.1. There is also a small group of anticausative verbs, which obligatorily also form zero-alternations with causative readings in the same template. These verbs are presented in 4.2.2.

### 4.2.1 Causative verbs

A few full examples are given for causatives in (1–2) and for an unergative in (3).

- (1) a. ha-orxim *rakd-u* ba-mesiba  
 the-guests danced-PL in.the-party  
 ‘The guests danced at the party.’  
 b. ha-zameret *herkid-a* et ha-orxim  
 the-singer.F made.dance-F ACC the-guests  
 ‘The singer made the guests dance.’
- (2) a. ema *axl-a* uxmanjot  
 Emma ate-F blueberries  
 ‘Emma ate blueberries.’  
 b. ana *hexil-a* et ema (uxmanjot)  
 Anna fed-F ACC Emma blueberries  
 ‘Anna fed Emma (blueberries).’

<sup>1</sup>For remarks on my notation see Section 1.2.3.

- (3) *ema hemtin-a ad fe-ha-oxel haja muxan*  
 Emma waited-F until COMP-the-food was ready  
 ‘Emma waited until the food was ready.’

I am not sure whether there are *obligatory* ditransitives in this template (about 80 are at least non-obligatorily ditransitive in the database of Ahdout in prep). Four candidates are *hefil* ‘lent out’ (4), *helva* ‘lent’, *heskir* ‘rented out’ and *hezkir* ‘reminded’. Whether or not the goal argument is obligatory in contemporary speech is unclear, and in any case does not bear directly on the rest of this chapter.

- (4) *ha-safranit hefil-a (l-i) et ha-sefer*  
 the-librarian lent.CAUS-F to-me ACC the-book  
 ‘The librarian lent me the book.’

A few more alternations between an active verb in *XaYaZ* (transitive or non-core transitive) and a causative in *heXYiZ* are presented in Table 4.2.

Table 4.2: Some alternations in *heXYiZ*

|    | Root                | Active <i>XaYaZ</i> |            | Causative <i>heXYiZ</i> |                |
|----|---------------------|---------------------|------------|-------------------------|----------------|
| a. | $\sqrt{\text{kl}}$  | <i>axal</i>         | ‘ate’      | <i>heexil (be-)</i>     | ‘fed (with)’   |
| b. | $\sqrt{\text{rj}}$  | <i>raa</i>          | ‘saw’      | <i>hera (le-)</i>       | ‘showed (to)’  |
| c. | $\sqrt{\text{fm}}$  | <i>fama</i>         | ‘heard’    | <i>hefmia (le-)</i>     | ‘played (to)’  |
| d. | $\sqrt{\text{nfj}}$ | <i>nafam</i>        | ‘breathed’ | <i>henfim</i>           | ‘resuscitated’ |

The most common way of characterizing these alternations informally is by saying that *heXYiZ* is a causative version of *XaYaZ*. Yet what we see in actuality is that verbs in *heXYiZ* are active, regardless of whether they alternate with an unaccusative verb in *XaYaZ*, a transitive verb in *XaYaZ*, or nothing in *XaYaZ*. A few examples of the causative alternation in this template are given in Table 4.3 a. Many verbs are also causative without alternating, as in “b”, and others are unergative, “c”.

The template is predominantly *active*, i.e. it has an agentive, external argument. The exact nature of what this “causation” is will be outlined (but not decisively defined) in Section 4.4.1.

Table 4.3: Alternations and lack of alternations in *heXYiZ*

|    |                | anticausative/inchoative |              | active         |                |              |
|----|----------------|--------------------------|--------------|----------------|----------------|--------------|
|    |                | <i>niXYaZ</i>            | <i>XaYaZ</i> | <i>heXYiZ</i>  |                |              |
| a. | <i>nixnas</i>  | ‘entered’                |              | <i>hexnis</i>  | ‘inserted’     |              |
|    | <i>notar</i>   | ‘remained’               |              | <i>hotir</i>   | ‘left behind’  |              |
|    | <i>nikxad</i>  | ‘went extinct’           |              | <i>heksid</i>  | ‘eradicated’   |              |
|    | <i>nitsal</i>  | ‘was saved’              |              | <i>hetsil</i>  | ‘saved’        |              |
|    | <i>neetsav</i> | ‘was saddened’           |              | <i>heetsiv</i> | ‘saddened’     |              |
|    | <i>nexlaf</i>  | ‘grew weak’              |              | <i>hexlif</i>  | ‘weakened’     |              |
|    |                |                          | <i>nafal</i> | ‘fell’         | <i>hepil</i>   | ‘dropped’    |
|    |                |                          | <i>kafa</i>  | ‘froze’        | <i>heksi</i>   | ‘froze’      |
|    |                |                          | <i>baar</i>  | ‘burned’       | <i>hevir</i>   | ‘lit up’     |
|    |                |                          | <i>tava</i>  | ‘drowned’      | <i>hetbia</i>  | ‘drowned’    |
|    |                |                          | <i>xazar</i> | ‘returned’     | <i>hexzir</i>  | ‘returned’   |
|    |                |                          | <i>jafav</i> | ‘sat down’     | <i>hofiv</i>   | ‘sat down’   |
|    |                |                          | <i>paxad</i> | ‘was afraid’   | <i>hefxid</i>  | ‘scared’     |
|    |                |                          | <i>rakad</i> | ‘danced’       | <i>herkid</i>  | ‘made dance’ |
| b. |                |                          |              | <i>hefmid</i>  | ‘destroyed’    |              |
|    |                |                          |              | <i>heir</i>    | ‘illuminated’  |              |
|    |                |                          |              | <i>hevis</i>   | ‘defeated’     |              |
|    |                |                          |              | <i>hegdir</i>  | ‘defined’      |              |
|    |                |                          |              | <i>hezmin</i>  | ‘invited’      |              |
|    |                |                          |              | <i>heka</i>    | ‘struck’       |              |
|    |                |                          |              | <i>hesnif</i>  | ‘sniffed’      |              |
|    |                |                          |              | <i>heflil</i>  | ‘incriminated’ |              |
| c. |                |                          |              | <i>hedrim</i>  | ‘went south’   |              |
|    |                |                          |              | <i>hegzim</i>  | ‘exaggerated’  |              |
|    |                |                          |              | <i>heflig</i>  | ‘set sail’     |              |
|    |                |                          |              | <i>heria</i>   | ‘cheered’      |              |
|    |                |                          |              | <i>heezin</i>  | ‘listened’     |              |
|    |                |                          |              | <i>hemin</i>   | ‘waited’       |              |
|    |                |                          |              | <i>heskim</i>  | ‘agreed’       |              |

## 4.2.2 The labile alternation

### 4.2.2.1 The pattern

Hebrew does not generally have the alternation referred to as *LABILE*, “zero-derivation” or “conversion” (as with English transitive and intransitive *break~break*), with the exception of certain verbs in *heXYiZ*. A handful of examples are attested in other templates, including *atsar* ‘stopped’ (often dispreferred to *neetsar* as an inchoative), *miher* ‘hurried’ and *ixer* ‘delayed’, although the latter two are not part of my own causative vocabulary. Over 500 of the 550–600 verbs in *heXYiZ* are active. In this section, I explore the 33 that are non-active and undergo the labile alternation.

I will once again use the label *INCHOATIVE* as a descriptive term: an inchoative verb in *heXYiZ* is one in which the sole argument has undergone the change of state (or changed on a scale). *CAUSATIVE* is likewise a descriptive term in this section, identical in use to *TRANSITIVE*: a structure with an external argument and an internal argument (complement to the verb). The two kinds will receive different analyses in Section 4.3. The alternation is exemplified by *heffir* ‘thawed’ in (5). None of the inchoatives in this template have reflexive (agentive) readings.

- (5) a. ha-jaxasim ben ftej ha-medinot *heffir-u* axarej  
 the-relations between both the-states thawed.CAUS-3PL after  
 bikur rof ha-memfala  
 visit head.of the-government  
 ‘The relations between the two countries thawed after the PM’s visit.’
- b. bikur rof ha-memfala *heffir* et ha-jaxasim  
 visit head.of the-government thawed.CAUS ACC the-relations  
 ben ftej ha-medinot  
 between both the-states  
 ‘The PM’s visit thawed the relations between the two countries.’

Some examples of verbs that undergo the alternation are given in (6). Even in those cases where the inchoative is frequent, a causative context can be set up fairly easily. Full lists are given later on in this section.

- (6) Alternating unergatives in *heXYiZ*:
- a. *Full alternation*: *heits* ‘sped up’, *heemik* ‘deepened’, *heerix* ‘lengthened’, *hekfiac* ‘stiffened’, *heffir* ‘thawed’, *hefmin* ‘fattened’, *herza* ‘grew thin’,  
 ...

#### 4 Voice<sub>[+D]</sub>

- b. *Unergative preferred but causative innovation attested: hesriax* ‘stank’, *hesmil* ‘went to the left’,<sup>2</sup> *hetsxin* ‘smelled pungent’, *herkiv* ‘rotted’, ...
- c. *Unaccusative preferred but causative innovation attested: heedim* ‘reddened’, *helbin* ‘whitened’, *hefxir* ‘blackened’, *hevri* ‘got healthy’, *hexvir* ‘grew pale’,<sup>3</sup> *hertsin* ‘became serious’, ...

As mentioned in Sections 3.2.1.2 and 3.7.1.2, unaccusativity judgments can be fickle in Hebrew: the possessive dative has been critiqued by Gafter (2014b) and Linzen (2014) as diagnosing saliency rather than internal argumenthood, while VS (Verb-Subject order in an otherwise SVO language) is not necessarily reliable as a diagnostic of deep unaccusativity. Nevertheless, it is possible to find unaccusative verbs in *heXYiZ* which perform satisfactorily on the ‘by itself’ and VS diagnostics, as the examples in (7–8) show. Borer (1991: 149) likewise argues that inchoatives in *heXYiZ* can be either unergative or unaccusative. Accordingly, I will assume that all three constructions (transitive, unergative and unaccusative) are possible in this template in principle.

(7) ‘By itself’ with *heXYiZ* inchoatives.

- a. ha-glida      *heffira*      **me-atma**  
the-ice.cream thawed.CAUS-F of-herself  
‘The ice cream defrosted on its own.’
- b. ha-tnaim      le-*haffara*      ba-jaxasim      hevfilu-u  
the-conditions to-thawing in.the-relations ripened.CAUS-3PL  
**me-atmam**  
of-themselves  
‘The conditions matured enough on their own for the relations to warm.’

---

<sup>2</sup>Attested example for causative “leften”:

- (i) kol ha-kavod le-barak. *hesmil* et netanjahu  
all the-respect to-Barak. made.left ACC Netanyahu  
‘Well done to [Ehud] Barak. He made [Benjamin] Netanyahu look like a leftist.’ <http://www.ynet.co.il/Ext/App/TalkBack/CdaViewOpenTalkBack/0,11382,L-4010352,00.html>

<sup>3</sup>Attested example for causative “palen”:

- (i) “The girl looked as though someone wrapped her up in massive metallic toilet paper. ...  
afilu ha-tseva ha-meanjen [...] *hexvir* et hofa’a-ta      *fel* danst  
even the-color the-interesting      paled ACC appearance-hers of Dunst  
‘Even the interesting color ... made Dunst’s appearance pale.’ [http://www.mako.co.il/women-fashion/whats\\_in/Article-174f70ed642f121004.htm](http://www.mako.co.il/women-fashion/whats_in/Article-174f70ed642f121004.htm)



- (8) VS order with *heXYiZ* inchoatives in *heXYiZ*. No *by*-phrase possible.
- a. *heffir-a* (I-i) **kol ha-glida** (\*al jedej ha-xom)  
 thawed-F to-me all the-ice.cream by the-heat  
 ‘All (my) ice cream defrosted completely (\*by the heat).’
  - b. *hevfil-u* ha-tnaim le-haffara ba-jaxasim (\*al jedej  
 ripened-3PL the-conditions to-thawing in.the-relations by  
 ha-bikur)  
 the-visit  
 ‘The conditions matured enough for the relations to warm (\*by the visit).’

But what is special about the 33 roots such as those in (6) that allows their verbs to alternate, on the one hand, and what is special about the morphological template that allows these verbs to alternate, on the other hand? A satisfying analysis of these patterns must address two questions: why these roots and why this template. A generalization about the roots is suggested next and the analysis of the template is addressed in Section 4.3.1, summarizing claims made in Kastner (2019a).

#### 4.2.2.2 Inchoatives as degree achievements

Not many verbs take part in the labile alternation in *hitXaYeZ*. A number of estimates can be found in the recent literature: Arad (2005) counted 11 such verbs in her corpus whereas Laks (2011) found 34. Lev (2016) counted 81 in a survey taking into account many naturally attested, but perhaps spurious, forms. My 33 alternating verbs are broken down as follows: 15 alternating unergatives and 18 alternating unaccusatives. I have classified the alternating verbs by the alternations they participate in. Barring an acceptability survey, and given that I know of no comparable lists at this level of granularity, the lists below reflect my own intuitions.

I have attempted to identify, at an informal level, which roots form verbs that participate in the labile alternation. I propose a pretheoretical classification into verb classes which is based on broad lexical semantic categories. The verbs are classified according to these categories, building towards the claim that they are all DEGREE ACHIEVEMENTS.

Table 4.4 lists the alternating verbs in *heXYiZ*. The first three rows show classes where the only inchoatives are unergative. The next row (change of color) shows a class in which the only inchoatives are unaccusative. Verbs in the other classes

#### 4 Voice<sub>[+D]</sub>

may be unergative or unaccusative, decided on a verb-by-verb basis. I also list whether there are transitive verbs in this template whose lexical semantics makes them eligible to be part of the verb class.

Table 4.4: Lexical semantic classes for alternating verbs in *heXYiZ* and transitive foils

|                                                  | Unaccusative                                                                                                                                                                                        | Unergative                                                                                                                                             | Transitive                                                                                                                 |
|--------------------------------------------------|-----------------------------------------------------------------------------------------------------------------------------------------------------------------------------------------------------|--------------------------------------------------------------------------------------------------------------------------------------------------------|----------------------------------------------------------------------------------------------------------------------------|
| Emission                                         | —                                                                                                                                                                                                   | <i>hesriax</i> ‘stank’, <i>hevif</i> ‘became putrid’,<br><i>hetsxin</i> ‘smelled pungent’ <sup>4</sup>                                                 | —                                                                                                                          |
| Change of speed or direction                     | —                                                                                                                                                                                                   | <i>heits</i> ‘accelerated’,<br><i>heet</i> ‘slowed down’,<br><i>hesmil</i> ‘went left’<br><i>herif</i> ‘made loud noise’, <i>hexrif</i> ‘quieted down’ | <i>heziz</i> ‘moved’,<br><i>hotsi</i> ‘removed’,<br>...                                                                    |
| Change of sound                                  | —                                                                                                                                                                                                   |                                                                                                                                                        | <i>heftik</i> ‘shut up’                                                                                                    |
| Change of color                                  | <i>heedim</i> ‘reddened’,<br><i>helbin</i> ‘whitened’, <i>heksil</i> ‘became blue’, <i>hetshiv</i> ‘yellowed’, <i>hefxir</i> ‘blackened’, <i>hezhiv</i> ‘goldened’,                                 | —                                                                                                                                                      | —                                                                                                                          |
| Change of physical function, shape or appearance | <i>hefmin</i> ‘fattened’, <i>herza</i> ‘thinned’, <i>hezkin</i> ‘grew old’, <i>hekriax</i> ‘became bald’, <i>hevri</i> ‘became healthy’, <i>hertsin</i> ‘became serious’, <i>hexvir</i> ‘grew pale’ | <i>heemik</i> ‘deepened’,<br><i>heerix</i> ‘lengthened’,<br><i>hetser</i> ‘narrowed’,<br><i>hesmik</i> ‘blushed’                                       | <i>heffit</i> ‘undressed’,<br><i>henmix</i> ‘lowered’, <i>hextim</i> ‘stained’, ...                                        |
| Change of consistency, taste or smell            | <i>hekfiax</i> ‘stiffened’, <i>heffir</i> ‘thawed’, <i>hevfil</i> ‘ripened’, <i>hekrim</i> ‘crusted’                                                                                                | <i>hexmits</i> ‘soured’,<br><i>herkiv</i> ‘rotted’                                                                                                     | <i>hetsis</i> ‘fermented’,<br><i>heriix</i> ‘smelled’,<br><i>hetpil</i> ‘desalinated’,<br><i>heflir</i> ‘fluoridated’, ... |
| Other                                            | <i>hexmir</i> ‘deteriorated’                                                                                                                                                                        | <i>hektsin</i> ‘escalated’                                                                                                                             |                                                                                                                            |

A number of tentative generalizations can be drawn from Table 4.4. For instance, it seems clear that change of color allows for inchoative verbs (unaccusative ones). Yet a large degree of arbitrariness exists, in that we might also have expected the forms in (9) to exist, contrary to fact. The semantic criteria alone are not enough to predict how all roots in the language will behave.

- (9) a. Change of speed: \**hemhir* (≠ *mahir* ‘quick’).  
 b. Change of color: \**hesgil* (≠ *sagol* ‘purple’), \**hektim*/\**hextim* (≠ *katom* ‘orange’).

It is also not the case that any root in the categories above necessarily derives an inchoative in *heXYiZ*: *heziz* ‘moved’ is a change of direction, *heftik* ‘shut up’ is a change of sound and *henmix* ‘lowered’ is a change of physical shape, but these three verbs (and many others) are only causative, never inchoative.

One insightful claim, made recently by Lev (2016) and endorsed by Kastner (2019a), is that inchoatives in *heXYiZ* are DEGREE ACHIEVEMENTS (Dowty 1991; Hay et al. 1999; Rotstein & Winter 2004; Kennedy & Levin 2008; Bobaljik 2012; McNally 2017, a.m.o). These are change of state verbs such as *widen* and *cool* which are derived from gradable adjectives. As such, they have scalar semantics leading to a possible endpoint. Lev’s claim is that this is exactly the unifying factor for the Hebrew inchoatives in *heXYiZ*, although it is not a bidirectional implication (not all possible degree achievements are inchoatives in this template), nor does this generalization drive his own analysis.

It does play a role in my own syntactic analysis insofar as inchoatives are derived from an underlying adjective (or noun). This hypothesis covers a fair bit of empirical ground and I follow Lev (2016) in adopting it.

### 4.2.3 Summary

To summarize the empirical state of affairs, verbs in *heXYiZ* are almost always active: either transitive or unergative. They often form causative versions of other verbs. And a few dozen verbs are degree achievements, intransitive change of state verbs derived from an underlying adjective or noun.

- (10) Generalizations about *heXYiZ*  
 a. *Configurations*: Verbs appear in transitive and unergative configurations; a small class of verbs forms unaccusative degree achievements.

---

<sup>4</sup>Other verbs of emission do not entail change of state: *heki* ‘threw up’, *hezia* ‘sweat’, *heflits* ‘farted’.

- b. *Alternations*: Some verbs are causative or active versions of verbs in other templates, especially *XaYaZ*. A small class of verbs creates a labile alternation within *heXYiZ*.

### 4.3 *Voice*<sub>[+D]</sub>: An active *Voice* head

To account for this set of data I propose *Voice*<sub>[+D]</sub>, a variant of *Voice* which requires that a DP be merged in its specifier, guaranteeing that an external argument appear. It introduces the Agent/Causer role, although unaccusatives are possible when deriving degree achievements.<sup>5</sup>

(11) *Voice*<sub>[+D]</sub>:

- a. A *Voice* head with a [+D] feature, requiring that some element check the [D] feature in its specifier (usually via Merge).

$$b. \llbracket \text{Voice}_{[+D]} \rrbracket = \begin{cases} \lambda P.P & / \_ \text{ (v) a} \\ \lambda P.P & / \_ \text{ (v) n} \\ \lambda x \lambda e. \text{Agent}(x,e) \text{ or } \lambda x \lambda e. \text{Causer}(x,e) \end{cases}$$

- c. *Voice*<sub>[+D]</sub> ↔ *heXYiZ*

#### 4.3.1 Syntax and semantics

The syntax of *Voice*<sub>[+D]</sub> is as in (12), where this head obligatorily introduces an external argument. Merging that DP in *Spec, Voice*<sub>[+D]</sub> is enough to check the [D] feature, however the *Spec-Head* relationship is formalized. Note that I was careful to say that the feature must be checked, not that an element must be merged in the specifier; this is because of the analysis of inchoatives coming up.

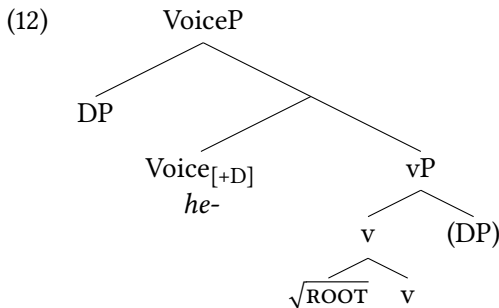

<sup>5</sup> Again abstracting away from the difference between Agents and Causers, regarding which see Section 1.3.

The relevant clause in the semantics is the Elsewhere case of (11b). Since the spell-out of *Voice<sub>[+D]</sub>* is *heXYiZ* (by hypothesis), we predict that all verbs in this template will have an external argument in the syntax and semantics.

- (13)  $\llbracket \text{Voice}_{[+D]} \rrbracket = \lambda x \lambda e. \text{Agent}(x, e)$  or  $\lambda x \lambda e. \text{Causer}(x, e)$

As we have seen, this proposal is enough to describe most of the empirical landscape. It also treats causatives in *heXYiZ* as monoclausal, “lexical” causatives, as expected.

But it is not enough to explain the inchoatives, where two questions in fact arise. First, how must we change our definition of *Voice<sub>[+D]</sub>*? And second, why is it this head alone that leads to labile alternations in the language?

The remainder of this section concerns itself with the first question of the two. I propose next that causatives have different structure than inchoatives, echoing claims made by Borer (1991). Causatives are argued to be derived from the root, whereas inchoatives are argued to be derived from an existing adjective or noun.<sup>6</sup> The more general question about labile alternations in *heXYiZ* alone will wait until Section 4.4.3.

#### 4.3.1.1 Inchoatives: Structure

As a first step, I will assume that inchoatives in *heXYiZ* are never derived directly from the root but from an underlying adjective or noun. A similar claim was already made by Borer (1991), who argued that causatives are derived directly from the root while these inchoatives are derived from an underlying adjective. As I point out here, inchoatives can also be derived from an underlying noun:

- (14) a. Underlying adjective: *heedim* < *adom* ‘red’, *hefmin* < *famen* ‘fat’.  
 b. Underlying noun: *heki* < *ki* ‘vomit’, *hetsxin* < *tsaxana* ‘stench’.

The structure is as in (15), covering both unergatives and unaccusatives.

---

<sup>6</sup>From a cross-Semitic perspective, Arabic “Form 9” *iXYaZZ* verbs show some parallels with *heXYiZ*, though the Arabic forms are exclusively nonactive.

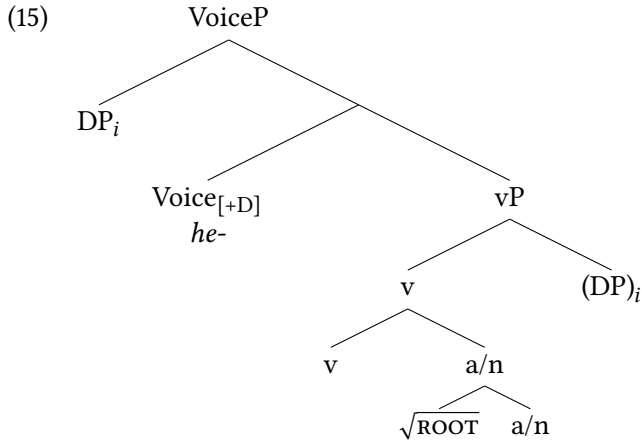

This assumption is admittedly a bit of a morphophonological stretch in certain cases.<sup>7</sup> For example, the verb *heits* ‘accelerated’ is arguably not derived from the noun *teutsa* ‘acceleration’, whose initial /t/ is not preserved. This much indicates that perhaps the claim should be weakened such that some inchoatives are derived from adjectives/nouns and others from the root. Nevertheless, the strong assumption of cross-categorical derivation carries a few benefits. First, it allows us to talk about different constructions in terms of explicit, uniform structures. Second, it allows for the degree semantics of the underlying adjective to transfer to the verb. And third, it makes a correct prediction regarding idiomatic meaning, as I show next.

My theory of morphosemantics assumes the so-called Arad/Marantz hypothesis, according to which the first categorizing head selects the meaning of the root (see Section 3.3.2). If (15) is the right structure for inchoatives, then we predict that for roots which participate in the alternation, the causative might have a meaning that the inchoative does not share. This is because in causatives Voice<sub>[+D]</sub> is local enough to the root to select a special meaning, whereas in inchoatives little *a* or little *n* will have already chosen the meaning of the root. This prediction is borne out by idioms involving *helbin* ‘whitened’ with the metaphorical meaning ‘laundered’, as in (16), and *hefxir* ‘blackened’ with the metaphorical meaning ‘tarnished’, as in (17).

- (16) a. Causative, literal meaning:  
 ha-sid            *helbin*            et    ha-kir.  
 the-lime.plaster whitened.CAUS ACC the-wall  
 ‘The lime plaster made the wall white.’

<sup>7</sup>I thank the *TLR* reviewers of Kastner (2019a) for emphasizing this point. I have not made progress on this issue since the publication of that paper.

- b. Causative, non-transparent meaning:  
 sar ha-xuts *helbin* ksafim.  
 minister the-exterior whitened.CAUS moneys  
 ‘The Minister of Foreign Affairs took part in money laundering.’
- c. Passive of causative, non-transparent meaning retained:  
 nitan je-ha-ksafim *hulben-u* al jedej  
 was.claimed COMP-the-moneys whitened.CAUS.PASS-3PL by  
 sar ha-xuts.  
 minister the-exterior  
 ‘It was claimed that the money was laundered by the Minister of Foreign Affairs.’
- d. Inchoative, only literal meaning:  
 ha-ftarot *helbin-u*.  
 the-bills whitened.CAUS-3PL  
 ‘The bills became white.’  
 (not: ‘The bills got laundered.’)
- (17) a. Causative, literal meaning:  
 ha-piax *hefxir* et ha-avir.  
 the-soot blackened.CAUS ACC the-air  
 ‘The air grew black with soot.’
- b. Causative, non-transparent meaning:  
 son’e-j israel menas-im *lehafxir* et pane-ha fel  
 haters-of Israel try.PTCP-M.PL to.blacken.CAUS ACC faces-3F of  
 medina-t israel ba-zira ha-benleumit.  
 state-of Israel in.the-arena the-international  
 ‘Israel’s haters are trying to make the State of Israel look bad on the international stage.’  
<http://www.ynet.co.il/articles/0,7340,L-4781034,00.html>
- c. ?? Inchoative, only literal meaning:  
 pane-ha fel ha-medina *hefxir-u* axarej ha-faarurija  
 faces-3F of the-state blackened.CAUS-3PL after the-scandal  
 ha-axrona  
 the-last  
 (int. ‘The country was made to look bad after the latest scandal’)

Borer (1991) provides additional arguments for deriving the inchoative from the adjective, which I scrutinize in Section 4.5.5.

#### 4 *Voice*<sub>[+D]</sub>

The full semantics for *Voice*<sub>[+D]</sub> then looks as in (18), without introducing a causer for inchoative events in (18a–b).

- (18)  $\llbracket \text{Voice}_{[+D]} \rrbracket =$
- a.  $\lambda P.P / \_\_ (v) a$  (v does not select the meaning)
  - b.  $\lambda P.P / \_\_ (v) n$  (v does not select the meaning)
  - c.  $\lambda x \lambda e. \text{Causer}(x, e)$  or  $\lambda x \lambda e. \text{Agent}(x, e)$

This formulation still suffers from a few potential problems, which I address in Section 4.4.4.

##### 4.3.1.2 Inchoatives: Derivation

Merging a DP in *Spec, Voice*<sub>[+D]</sub> will not do for the inchoatives since they are unaccusative. Allowing the internal argument to raise to the specifier and check the [D] feature there must also be ruled out because of the results of the VS diagnostic: it shows us that at least in some cases the internal argument must be allowed to remain low, (8).

To account for these cases, I assume instead that the [D] feature on *Voice*<sub>[+D]</sub> requires valuation of phi-features under Agree (Nie 2017; Schäfer 2017). This valuation proceeds straightforwardly under *Spec-Head Agreement*, as we have seen, but something else needs to be said if the sole argument in the phase is the internal argument. In this case, I propose that [D] can be checked by the internal argument *in situ*: *Voice*<sub>[+D]</sub> probes into its specifier upwards, finds no target, and so it probes downwards and is valued by the internal argument. For more in-depth discussion of the direction of Agree, see works such as Béjar & Rezac (2009), Zeijlstra (2012), Preminger (2013) and Deal (2015).

Here is what the current proposal means for an inchoative example like (19) with the structure in Figure 4.1. *Voice*<sub>[+D]</sub> probes its specifier and finds nothing, Figure 4.1 (①), so it probes downward and checks its unvalued phi-features with the internal argument *ha-xatul* ‘the cat’ (Figure 4.1, ②). The interpretation is as in (18a): no Causer is introduced.

- (19) *ha-xatul hefmin.*  
 the-cat fattened.CAUS  
 ‘The cat grew fat.’

As a consequence, ungrammatical cases like (20) must now be ruled out.



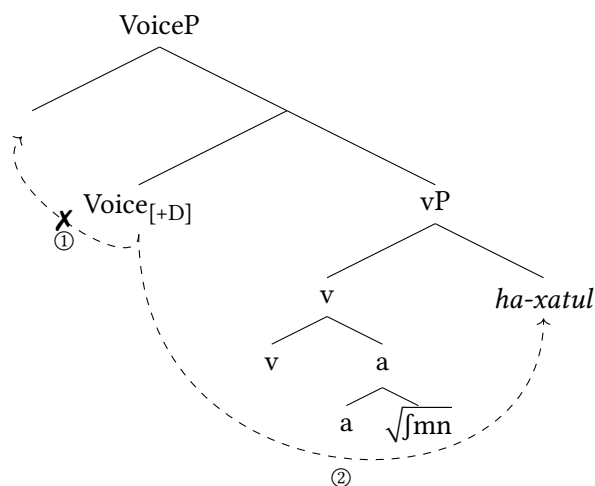

Figure 4.1: Agree in (19)

- (20) a. \* ha-xatul *hexnis*  
 the-cat inserted.CAUS  
 (int. ‘The cat got inserted’)
- b. \* ha-oto *hemhir*  
 the-car was.fast.CAUS  
 (int. ‘The car grew fast’)
- c. \* ha-xatul *hekpi*  
 the-cat froze.CAUS  
 (int. ‘The cat froze’)

For (20a) there is no adjective ‘inserted’ that could be verbalized and no inchoative can be generated. In (20b) an adjective *mahir* ‘quick’ does exist, but it cannot be instantiated in *heXYiZ* in general due to some arbitrary gap, as already mentioned in Section 4.2.2.2 (or at least, I assume that this is an arbitrary gap, in lieu of a more principled explanation).

Finally, (20c) is not a possible inchoative even though there exists an underlying adjective, namely *kafu* ‘frozen’. There are a number of possible explanations which can be pursued here. One is that *freeze* is not a degree achievement in Hebrew, and so that adjective is not a possible input to the structure. Another kind of explanation falls along the lines of extra-grammatical paradigmatic pressure, in that an inchoative (non-alternating) freezing verb already exists in another template: *kafa* ‘froze’ in *XaYaZ*. In this regard, I should note that speakers do steer

clear of *heXYiZ* for certain inchoatives, instantiating them in other, more canonically non-active templates: *hitarex* ‘grew long’ in *hitXaYeZ* rather than *heerix*, *hizdaken* ‘grew old’ in *hitXaYeZ* rather than *hezkin*, *raza* ‘thinned’ in *XaYaZ* instead of *herza*, and *hitadem* ‘reddened’ in *hitXaYeZ* rather than *heedim* (but see Doron 2003: 22 for a grammatical difference between the two).

It should go without saying that the strong claim about separate derivational strategies for causatives and inchoatives awaits a more articulated semantic analysis. As a reviewer for Kastner (2019a) pointed out, in (5) the verb *heffir* means ‘thawed’, i.e. became warmer, while the underlying adjective *pofer* means ‘lukewarm’, i.e. not warm. Yet the inchoative does not mean “became lukewarm”. Another incongruity between verb and adjective can be seen with *hefmin*, ‘grew fatter’, which does not entail that its argument becomes *famen* ‘fat’. Important discussion of the relevant scales and entailments is given by Borer (1991), which I turn to in the discussion of alternatives.

With the formal analysis in place, I flesh out the morphophonological part of the chapter before turning to more general discussion, including the question of why the labile alternation is formed with Voice<sub>[+D]</sub> specifically.

### 4.3.2 Phonology

The basic VI given in (11) was as follows:

$$(21) \text{ Voice}_{[+D]} \leftrightarrow \text{heXYiZ}$$

Using *heXYiZ* as the Vocabulary Item spelling out Voice<sub>[+D]</sub> is shorthand for a more detailed morphophonology. A sample derivation is adapted here from Kastner (2019b). I contrast the 3SG.M.PAST form with the 1SG.PAST form, which has an affix and a different stem vowel.

- (22) a. *hevfil* ‘he ripened’  
 b. *hevfal-ti* ‘I ripened’

The relevant Vocabulary Items:

- (23) a.  $\sqrt{b\bar{f}l} \leftrightarrow bfl$   
 b.  $\text{Voice}_{[+D]} \leftrightarrow \begin{cases} he,a & / \text{T}[1\text{st}] \text{ \_\_\_} \\ he,i & \end{cases}$   
 c. 1SG  $\leftrightarrow ti / \text{\_\_\_}$  Past  
 d. 3SG  $\leftrightarrow \emptyset / \text{\_\_\_}$  Past

The cyclic derivation:

- (24) a. *hevfil* ‘he ripened’: [T[*Past,3SG.M*] [Voice<sub>[+D]</sub> [v  $\sqrt{b\bar{I}}$ ]]]  
 Cycle 1 (VoiceP): he-vfil  
 Cycle 2 (TP):  $\emptyset$ -hevfil  $\Rightarrow$  hevfil
- b. *hevfalti* ‘I ripened’: [T[*Past,1SG*] [Voice<sub>[+D]</sub> [v  $\sqrt{b\bar{I}}$ ]]]  
 Cycle 1 (VoiceP): he-vfal  
 Cycle 2 (TP): ti-hevfal  $\Rightarrow$  hevfalti

See the work cited for various additional cyclic and allomorphic predictions.

## 4.4 Causation and alternation

This section contains a number of general points about causative alternations which I would like to mention. Section 4.4.1 discusses markedness in causation in general and in terms of Voice heads in particular. Section 4.4.2 notes how productive Voice<sub>[+D]</sub> is, and Section 4.4.3 returns to the labile alternation. A possible way of generalizing this account is surveyed in Section 4.4.4. For recent ways of conceptualizing causation in Hebrew in particular, see Bar-Asher Siegal & Boneh (2019).

### 4.4.1 Markedness in causation

Recall the basics of the anticausative alternation which we have been assuming. Both (marked) anticausatives and (unmarked) causatives share a common base, formally the vP. This phrase is a predicate over eventualities, to which Voice can add an external argument (Schäfer 2008; Alexiadou et al. 2015), (25).

- (25) a. *Mary Voice* [<sub>vP</sub> *broke the glass*].  
 b.  $\emptyset$  *Voice*<sub>[-D]</sub> [<sub>vP</sub> *The glass broke*].

Considering the Trivalent proposal, how and why should Voice<sub>[+D]</sub> differ from Unspecified Voice? If Voice allows the grammar to add an external argument, what’s left for an additional device (Voice<sub>[+D]</sub>) to do, the hypothetical (26)?

- (26) *Mary Voice*<sub>[+D]</sub> [<sub>vP</sub> *broke the glass*].

Since the syntactic behavior of Unspecified Voice and Voice<sub>[+D]</sub> is identical as far as licensing a specifier is concerned, in this section I will discuss the semantic difference between the resulting causative verbs. Concretely, I will suggest that

#### 4 *Voice*<sub>[+D]</sub>

Voice-causatives are more transparent than *Voice*<sub>[+D]</sub>-causatives, whereby the morphological markedness of the latter mirrors some semantic markedness or opacity. The *Voice*<sub>[+D]</sub> causatives are simply LEXICAL CAUSATIVES in the sense of Fodor (1970), Miyagawa (1998) and Harley (2008): a transitive verb which is not derived through causativization of an existing verb. Let us explore what this means when contrasting them with “regular” causative or transitive verbs. For Hebrew, this means contrasting causatives in *XaYaZ* with those in *heXYiZ*, or rather causatives derived using Unspecified Voice with causatives derived using *Voice*<sub>[+D]</sub>.

##### 4.4.1.1 Basic and marked alternations

For concreteness, let us give the two alternations the names in Table 4.5. The claim will be that the marked alternation is marked not only morphologically but also semantically – a lexical causative, i.e. a non-transparent one.

Table 4.5: Two basic alternation types

|                    | Anticausative                | Causative | Causative                    |
|--------------------|------------------------------|-----------|------------------------------|
| Basic alternation  | <i>Voice</i> <sub>[-D]</sub> | Voice     | –                            |
| Marked alternation | –                            | Voice     | <i>Voice</i> <sub>[+D]</sub> |

Very little contemporary work has analyzed causative alternations in depth within a general theory of argument structure alternations; such work normally draws on languages like Japanese (Jacobsen 1992) that are typologically distinct from Indo-European ones. Alexiadou et al. (2015: 62fn) speculate that a marked causative should entail thematic/active Voice (semantically if not syntactically), but as far as I know no formal theory has explored the implications of marked anticausatives and marked causatives existing side by side.

The first question to ask is how prevalent these two alternations are. The basic alternation was discussed at length in Section 3.3. For the marked alternation, various examples were already given in Tables 4.2 and 4.3b. Out of 300+ pairs of *XaYaZ*–*heXYiZ* alternations in my database, 64 show the marked alternation.

The second question is whether there is a difference between the semantics of the alternations, and here I believe the basic alternation is more transparent. The question is one of predictability: given the anticausative variant, can we predict the meaning of the causative variant? In the basic alternation, the answer

is usually affirmative, just like with the prototypical *break-break* and *open-open* examples in English. A few examples were given above and one is elaborated on in (27):

- (27) a. *nixtav* ‘was written’  
 Writing event of a DP, no Causer specified; or a passive reading with an implicit Agent.
- b. *katav* ‘wrote’  
 Writing event of a DP, external argument specified in the syntax and interpreted as Agent.

I suggest that the causative variant of a basic alternation introduces a direct Causer (Bittner 1999; Kratzer 2005) but that the external argument in the marked alternation is less restricted.<sup>8</sup> For the marked causative, the informal phrasing in (28) will do for now (I return below to the question of whether a writing event even holds in these cases):

- (28) *hextiv* ‘dictated’  
 Writing event of a DP, external argument specified in the syntax and understood as an (indirect) Causer.

In terms of syntax, there appears to be no difference between the constructions. The unmarked causative has a regular monoeventive reading, cannot be modified by conflicting temporal adverbs, and has two basic readings of ‘again’ (von Stechow 1996).

- (29) *ha-talmidim katv-u et ha-nosim (#aval lo be-atmam).*  
 the-students wrote-3PL ACC the-topics but not in-themselves  
 ‘The students wrote down the list of topics (# but not by themselves)’
- a. Means: The students wrote the list themselves.  
 b. Cannot mean: paid someone online to write the list for them.
- (30) \* *ha-talmidim katv-u etmol et ha-nosim maxar*  
 the-students wrote-3PL yesterday ACC the-topics tomorrow  
 (int. ‘The students wrote something down yesterday to get the list of topics tomorrow’)

---

<sup>8</sup>A similar intuition was expressed by Doron (2003), where the strongest claims about a template’s meaning were limited to cases in which a root alternates between two templates.

#### 4 Voice<sub>[+D]</sub>

- (31) ha-talimidim *katv-u* et ha-nosim *juv*.  
the-students wrote-3PL ACC the-topics again  
'The students wrote down the list of topics again.'
- Can mean: The students wrote down a list which already existed.
  - Can mean: The students wrote down a list after having written it down once before.
  - Cannot mean: Someone<sub>i</sub> had written down the list of topics, and now the students made someone<sub>i/j</sub> write the list of topics another time.

The marked causative patterns identically: monoeventive reading, no conflicting temporal adverbs, and the same readings of 'again'.

- (32) ha-more *hextiv* et ha-nosim (la-talimidim) (#bli lomar mila).  
the-teacher dictated ACC the-topics to.the-students without to.say word  
'The teacher dictated the list of topics (to the students) (# without saying a word).'
- Means: The teacher read the list out and the students wrote it down.
  - Cannot mean: He stood menacingly over the students until they started writing.
- (33) \* ha-more *hextiv* etmol et ha-nosim (la-talimidim) *maxar*  
the-teacher dictated yesterday ACC the-topics to.the-students tomorrow  
(int. 'The teacher read out the list yesterday for the students to write down tomorrow')
- (34) ha-more *hextiv* et ha-nosim (la-talimidim) *juv*.  
the-teacher dictated ACC the-topics to.the-students again  
'The teacher dictated the list of topics (to the students) again.'
- Can mean: The teacher dictated/wrote a list which (someone else) had already dictated/written.
  - Can mean: The teacher dictated/wrote a list having dictated/written it once before.
  - Cannot mean: Someone<sub>i</sub> had dictated/written the list, and now the teacher made someone<sub>i/j</sub> write/dictate it another time.

The structures are therefore virtually identical, with the only difference being the feature on Voice (other than the identity of the external argument).

- (35) a. *ha-talimidim katv-u et ha-nosim.*  
 the-students wrote-3PL ACC topics  
 ‘The students wrote down the list of topics.’

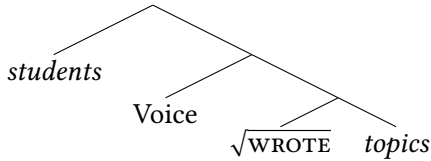

- b. *ha-more hextiv et ha-nosim (la-talimidim).*  
 the-teacher dictated ACC topics to.the-students  
 ‘The teacher dictated the list of topics (to the students).’

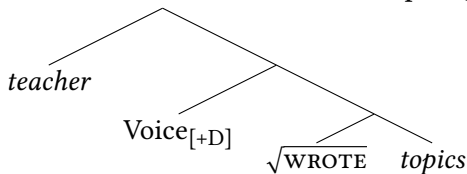

In the basic alternation, adding a Causer to writing immediately identifies the writer. But adding the marked Causer changes the event slightly: the teacher does not cause writing to occur, strictly speaking. Rather, he is the Causer of a dictating event, which itself brings about the writing down of the topics.

A similar pattern can be seen with *neexal* ‘was eaten’, where the basic variant *axal* means ‘ate’ and the marked variant *heexil (et)* means ‘fed (s.o. s.th.)’. Why should this be the meaning, and not ‘made someone eat’? The different kind of event (feeding versus causing to eat) also implies a different position for the eater: subject in the basic variant, object in the marked variant.

- (36) a. *beki axl-a uxmanjot.*  
 Becky ate-F blueberries  
 ‘Becky ate blueberries.’

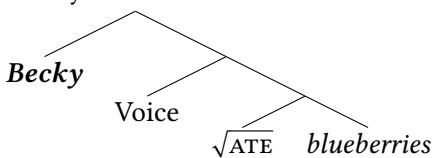

4 *Voice*<sub>[+D]</sub>

- b. ima *heexil-a* et beki (uxmanjot).  
 mom fed-F ACC Becky blueberries  
 ‘Mom fed Becky (blueberries).’

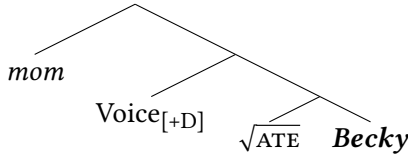

This contrast illustrates the limits of syntax within the current system: it can rigidly dictate which elements go where, but the structure itself is not driven by semantic or lexical-semantic considerations.

A few more examples of the marked alternation are given in Table 4.6, showing that the exact type of “causative” relation for the marked variant is not uniform.<sup>9</sup> We have already seen the different meanings of rows a and c.

The last examples, in rows h–j, are particularly revealing: to extradite someone is in no way an obvious semantic extension of “closing” them. More examples like this can be found, in which the basic alternant has predictable semantics but the marked one does not.

Before we go on to discuss the consequences of these differences, it is important to note a possible objection. The fact that marked causatives can vary so widely in their interpretation from the basic variants could be taken as an argument against treating these verbs as sharing the same abstract root. That is to say, why should we even think that closing and extraditing share the same root? Would that not be stretching its assumed shared semantics too thin? I believe the overall picture emerging from this book and from work treating roots more directly is that we do want to assume abstract roots, but be more specific in what their shared meaning is and under which circumstances it can vary. See also Kastner & Tucker (submitted) for related discussion of root meaning.

More concretely, however, we can make an argument from the lack of doublets. There are no *additional* verbs in *niXYaZ* that alternate with *heXYiZ*. That is to say, suppose that *nikra* ‘was read’ and *kara* ‘read’ are derived from  $\sqrt{\text{krj1}}$  and that *hekri* ‘read out’ was derived from a homophonous root  $\sqrt{\text{krj2}}$ . Assume similarly that *nisgar* ‘closed’ and *sagar* ‘closed’ were derived from  $\sqrt{\text{sgr1}}$  but that *hesgir* ‘extradited’ was derived from  $\sqrt{\text{sgr2}}$ , and so on for all cases of non-predictable causative variants. If this were the case, we would suppose that  $\sqrt{\text{krj2}}$  and  $\sqrt{\text{sgr2}}$  could

<sup>9</sup>The lexical semantics of the root could have something to do with the type of causation in the marked alternation, a question I leave open. See Doron (2003: 44) for a proposed explanation in terms of whether the *XaYaZ* form is a verb of consumption or a psych-verb, building on Cole & Sridhar (1977).



Table 4.6: Alternation types in *heXYiZ*

|    |                |                    |               |            |                |                           | Make O V | Make O be V-ed |
|----|----------------|--------------------|---------------|------------|----------------|---------------------------|----------|----------------|
| a. | <i>neexal</i>  | 'was eaten'        | <i>axal</i>   | 'ate'      | <i>heexil</i>  | 'fed'                     | ✓        | ✗              |
| b. | <i>nilbaſ</i>  | 'was worn'         | <i>lavaſ</i>  | 'wore'     | <i>helbiſ</i>  | 'dressed up'              | ✓        | ✗              |
| c. | <i>nixtav</i>  | 'was written'      | <i>katav</i>  | 'wrote'    | <i>hextiv</i>  | 'dictated'                | ✗        | ✓              |
| d. | <i>nikra</i>   | 'was read'         | <i>kara</i>   | 'read'     | <i>hekri</i>   | 'read out'                | ✗        | ✓              |
| e. | <i>nidxak</i>  | 'was pushed aside' | <i>daxak</i>  | 'shoved'   | <i>hedxik</i>  | 'suppressed' <sup>a</sup> | ✗        | ✓              |
| f. | <i>nilxats</i> | 'was pressed'      | <i>laxats</i> | 'pressed'  | <i>helxits</i> | 'pressured'               | ✗        | ✓              |
| g. | <i>nextam</i>  | 'was signed'       | <i>xatam</i>  | 'signed'   | <i>hextim</i>  | 'made sign'               | ✓        | ✓              |
| h. | <i>nidxgam</i> | 'was sampled'      | <i>dagam</i>  | 'sampled'  | <i>hedgim</i>  | 'demonstrated'            | ✗        | ✗              |
| i. | <i>niklat</i>  | 'was received'     | <i>kalat</i>  | 'received' | <i>heklit</i>  | 'recorded'                | ✗        | ✓?             |
| j. | <i>nisgar</i>  | 'closed'           | <i>sagar</i>  | 'closed'   | <i>hesgir</i>  | 'extradited'              | ✗        | ✓?             |

<sup>a</sup>E.g. memories or emotions.

also be instantiated with other functional heads, for instance with *Voice*<sub>[-D]</sub> to create an anticausative in *niXYaZ*. But this is not the case: there is no *#nikra* ‘was read out’ to alternate with *hekri* ‘read out’, and no *#nisgar* ‘got extradited’ to alternate with *hesgir* ‘extradited’. In other words, there are no *doublets* (compare the discussion of root suppletion in Harley 2014a,b; 2015 and Borer 2014b).

I conclude tentatively that *Voice*<sub>[+D]</sub> invokes some indirect notion of causation, in those cases where regular (direct) causation is already triggered by *Voice*. But why might this be the case?

#### 4.4.1.2 Markedness in *Voice* heads

The observations made so far bring us to the proposed generalization for causativity marking in (37).

(37) *The causative generalization for transitivity alternations*

If a language has both anticausative and causative marking:

- a. The anticausative alternation is transparent.
- b. The causative alternation is not (it is indirect, root-specific).

I would not be surprised if closer examination of other languages reveals similar patterns. In French, for instance, the prefixes *a-* and *en-* are often described as having a general “transitivizing” or “causative” function (Junker 1987). In some cases, especially denominal and de-adjectival ones, the causative alternation between an unprefixated anticausative verb and a prefixated causative verb is transparent (38a). But this is not always the case: in (38b) the unprefixated verb is an activity and the prefixated verb is transitive (it has the obligatory reflexive marker) but does not strictly speaking mean ‘make yourself fly’ or ‘fly yourself’. Even more strikingly – and certainly reminiscent of the Hebrew datapoints – is (38c), where the prefixated version has different meaning than the unprefixated one.

(38) French (Junker 1987)

- a. *faiblir* ‘grow weak’ ~ *affaiblir* ‘weaken s.o.’
- b. *voler* ‘fly’ ~ *s’envoler* ‘take off’
- c. *fermer* ‘close’ ~ *enfermer* ‘imprison, lock up’

It is tempting to analyze these prefixes as *Voice* heads, perhaps even *Voice*<sub>[+D]</sub>, but that idea goes beyond the scope of the current work. What we see is that there is no transparent relationship of “causation”, however defined, between a marked form and an unmarked one.

The discussion of causative marking will conclude by examining whether (37) can be derived directly from our theoretical assumptions. I believe that it can. Concretely, this generalization follows directly from the general Layering approach to transitivity alternations. If the core vP already has a causative component, then it is clear what *not* adding an external argument would mean: that is the anticausative alternant. Adding an external argument, as noted above, amounts to introducing the most direct Causer. This much derives (37a).

Say we have an event of causation, (39):

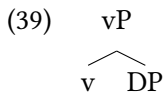

Not adding a Causer is easy, (40):

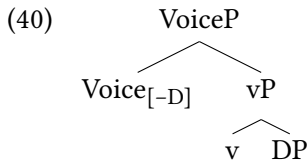

For (37b) I need to assume that structures derived with different Voice heads will have different meanings, perhaps by some principle of economy. Then, various kinds of external arguments can go with different causation events:

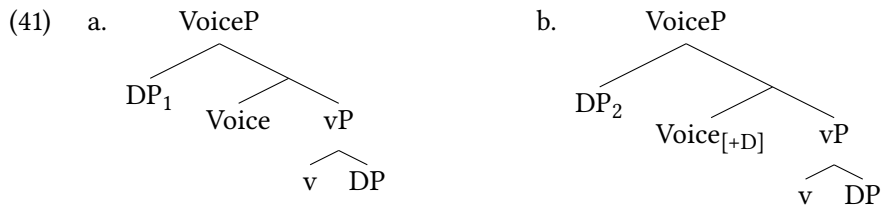

This result makes sense if  $\text{Voice}_{[+D]}$  is a marked head which only appears in the inventory of a language once this language already has Unspecified Voice (see also Chapter 6). In other words, the two heads stand in an implicational relationship and we do not expect to find a language with  $\text{Voice}_{[+D]}$  (and  $\text{Voice}_{[-D]}$ ) but without Voice.

On the other hand, it is not possible to have various kinds of *lack* of external arguments. This point brings us to a novel prediction, namely that a specific kind of argument structure triplet should be highly rare, if not impossible.

(42) *The triplet prediction for argument structure alternations*

If a language has both anticausative and causative marking:

- a. Triplets of this form may be possible:  
[marked **unaccusative** ~ unmarked causative ~ marked causative]
- b. Triplets of this form will not be possible:  
[marked **unaccusative** ~ unmarked *unaccusative* ~ marked causative]

We have already seen examples of triplets such as those predicted by (42a) to exist in Table 4.6. Those like (42b) are much more difficult to find. The two triplets in Table 4.7 could be argued to exist in Hebrew.

Table 4.7: Potential alternation triplets in Hebrew

|               | $\sqrt{xrv}$                                | $\sqrt{flm}$                         |
|---------------|---------------------------------------------|--------------------------------------|
| <i>niXYaZ</i> | <i>nexrav</i> ‘turned to ruins’             | <i>niflam</i> ‘reached conclusion’   |
| <i>XaYaZ</i>  | ?? <i>xarav</i> ‘turned to ruins’           | ?? <i>falam</i> ‘became whole’       |
| <i>heXYiZ</i> | <i>hexriv</i> ‘demolished, turned to ruins’ | <i>heflim</i> ‘made up with someone’ |

In both cases the *XaYaZ* form is archaic and exists in contemporary speech only in a few set idioms, if at all. Speakers seem to prefer the *niXYaZ* form for the anticausative, in accordance with (42).

Outside of Hebrew, Acehnese has been reported to have an unmarked anticausative and an additional marked anticausative (Ko 2009). Interestingly, this latter marked anticausative looks like it is derived from the marked causative. I therefore submit the generalization in (37) and the prediction in (42) as claims to be tested in more careful crosslinguistic work.

#### 4.4.2 Productivity

Another point about the semantic flexibility of Voice<sub>[+D]</sub> concerns its productivity. The template *heXYiZ* is a productive causative template in which speakers may innovate new forms on the fly (Lev 2016). The verb *taka* ‘stuck’, for instance, is an ordinary transitive verb in *XaYaZ*, but the online comment in (43) innovates *hetkia* in *heXYiZ* (presumably for literary or comic effect). The article concerns a roller coaster which became stuck mid-ride on a Saturday, the prescribed day of rest, stranding those riding it for the better part of an hour.

- (43) ‘Why don’t you understand that the roller coaster also wanted to observe the Sabbath and rested 40 minutes ...’  
 ... elokim hevi la-xem siman fe-lo t-aal-u al ha-mitkan  
 G-d brought to-2.PL sign that-NEG 2.FUT-rise-PL on the-device  
 be-fabat ve-hine hu *hetkia* et-xem le-40 dakot be-jom fabat  
 in-Saturday and-here he stuck ACC-2.PL for-40 minutes in-day Saturday  
 kodef  
 holy  
 ‘... G-d gave you a sign not to go on the ride on Saturday, and there you go, he made you get stuck for 40 minutes on the holy Sabbath.’ <https://www.ynet.co.il/Ext/App/TalkBack/CdaViewOpenTalkBack/0,11382,L-3441716-7,00.html>

Additional examples can be found in Lev (2016).

In such cases, there is no strong prediction with regard to the kind of causation event; my expectation would be that different kinds of causation would be possible, as was the case for the examples in Table 4.6. This much seems to be correct. The verb *hexfid*, from *xafad* ‘suspected’, is attested in both readings: ‘be suspected’, ‘be made into a suspect’ in (44) and ‘make X suspect s.th.’ in (45).

- (44) Make O V-ed (turn into a suspect)
- a. be-tviat-am toanim ha-fnaim ki gilboa *hexfid* et  
 in-lawsuit-theirs claim the-two that Gilboa suspect.CAUS ACC  
 deri be-retsixat-a fel ester verderber  
 Deri in-murder-hers of Esther Verderber  
 ‘The two claim in their lawsuit that Gilboa turned Deri into a suspect in the murder of Esther Verderber.’  
<https://www.ynet.co.il/articles/0,7340,L-2443354,00.html>
- b. ha-seruv *hexfid* et netanjahu ve-sar-av  
 the-refusal suspect.CAUS ACC Netanyahu and-ministers-his  
 ha-krovim ki retson-am litol le-atsmam samxut  
 the-close that will-theirs to.take to-themselves authority.of  
 al jexudit, ve-lo linhog bi-fkifut.  
 superior unique and-NEG to.behave in-transparency  
 ‘This refusal makes one suspect that Netanyahu and his closest ministers wish to avail themselves of unique authority, rather than conduct themselves transparently.’  
<https://www.israelhayom.co.il/opinion/294269>

- (45) Make X verb (make someone suspect s.th., make someone suspicious)
- a. *jalom lifnej beerex 5 elef hexlaf-ti galgalf kolel*  
 hello before about 5 thousand changed-1 sprocket including  
*farferet (z750 2010) ve-ha-mexir je-kibalti ktsat hexfid*  
 chain (z750 2010) and-the-price that-I.got a.little suspect.CAUS  
 ot-i  
 ACC-me  
 ‘Hello, I changed my gear and chain (z750 2010) about five years ago  
 and the price I got made me a little suspicious.’  
<http://fullgaz.co.il/forums/archive/index.php/t-793.html>
- b. *galaj ha-mataxot lo hetria u-vexol zot ha-falestini*  
 detector the-metal NEG warn and-nevertheless the-Palestinian  
*hexfid et loxamej mijmar ha-gvul*  
 suspect.CAUS ACC warriors.of the Border Patrol  
 ‘The metal detector did not give any warning but nevertheless, the  
 Palestinian aroused the suspicion of the Border Patrol soldiers.’  
<http://www.93fm.co.il/radio/445111/>

These examples confirm that there are clear compositional differences with the marked causative alternation: forms built from Voice/Voice<sub>[-D]</sub> are transparent, while those built from Voice<sub>[+D]</sub> are marked.

#### 4.4.3 The labile alternation

The main characteristic of Voice<sub>[+D]</sub> is that it is supposed to guarantee the availability of an external argument; in other words, a transitive construction is possible if the event has change-of-state semantics, i.e. an internal argument. Looking back at the labile alternation, I have not yet found any alternations in which the causative is preferred and the inchoative is a recent innovation; or inchoatives in *heXYiZ* which have no causative counterpart. I take these findings to be emblematic of the causative meaning inherent in Voice<sub>[+D]</sub>: even if inchoative verbs have arisen, contemporary usage overwhelmingly tends to coin causatives in this template rather than another kind of verb (Laks 2014).

Let us continue to assume that the process of inchoative formation in *heXYiZ* is productive, as argued for by Lev (2016), and is not merely a list of exceptions, as implicitly assumed in most of the literature (with the exception of Doron 2003, to be discussed in Section 4.5.3). Then, when the speaker is faced with the choice of a construction for their de-adjectival or denominal verb, they might choose

Voice<sub>[+D]</sub> because this structure guarantees that an external Causer can be added (we should keep in mind that *hitXaYeZ* is the more productive template for novel derived forms, e.g. Laks 2011). That is perhaps why this is the only head which is compatible with labile alternations.

One consequence of the overall analysis is that it allows us to state in formal terms the difference in argument distribution between causatives and inchoatives. I have proposed that once the structure contains a more deeply embedded a/n node, v is too far away from the root for particular selectional requirements to be stated. This idea receives potential corroboration from the behavior of *-en* in English.<sup>10</sup> As noted by Harley (2009), English verbalizers such as *-ify*, *-ize* and *-ate* can derive verbs that are uniformly unaccusative (e.g. *oscillate*), uniformly unergative (e.g. *deteriorate*) or labile (e.g. *activate*), but *-en* verbs are always labile. An examination of the list in Levin (1993: 245) confirms this claim. If we assume that these latter verbs contain additional structure, for instance [v [CMPR [a  $\sqrt{\text{Root}}$ ]]] (Bobaljik 2012), we arrive at a similar analysis to that of *heXYiZ* inchoatives: they cannot impose selectional restrictions and are “stuck” with the argument structure imposed by the syntax. But I will not develop this idea or the crosslinguistic ramifications any further.

#### 4.4.4 Generalizing to Pred/*i*\*

Before turning to alternative accounts of the patterns above, I would like to briefly consider a variant of the account given above (suggested by Jim Wood, p.c. November 2019). The intuition here is that the head deriving inchoatives in *heXYiZ* is not Voice<sub>[+D]</sub> itself but a variant of the predicative head Pred, which itself is another label for *i*\* (a generalized argument introducer I discuss later on, in Chapter 7.2).

The formal analysis builds on the notion of a predicative head Pred, which has been invoked in various ways in the literature. Since the specifics are not important for this short discussion, I will simply point out Bowers (1993; 2001) as one influential account and Matushansky (2019) for a recent reply.

According to the Pred alternative, denominal and de-adjectival verbs in this template at least are derived using the head Pred<sub>[+D]</sub>. Causatives would then have the structure in (46) and unaccusatives the structure in (47): the internal argument is introduced in Spec,PredP, which is then embedded under Voice.

---

<sup>10</sup>Thanks to Jim Wood for pointing out this observation.

#### 4 Voice<sub>[+D]</sub>

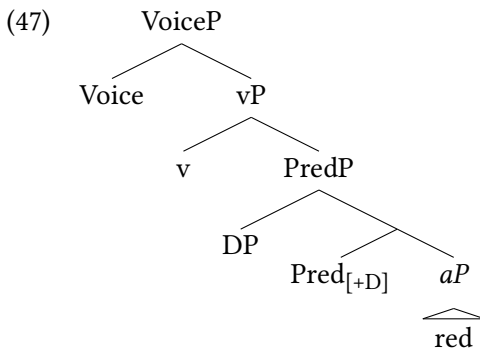
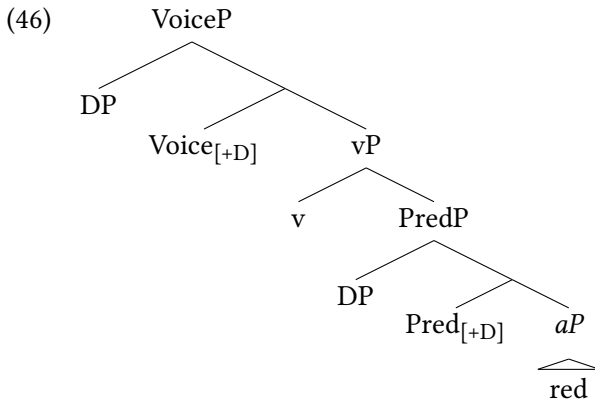

If we assume this analysis, we can then replace  $\text{Pred}_{[+D]}$  with the generalized  $i^*_{[+D]}$ , which should have the same spell-out as  $\text{Voice}_{[+D]}$ ; again, see Section 7.2.

Are there strong reasons to adopt or reject this proposal? On the one hand, we now have an explanation for why both embedded *n* and embedded *a* give *heXYiZ* non-active semantics; the formulation in (11b) and (18) makes this seem like an accident. The  $\text{Pred}$  analysis would also mean that  $\text{Voice}_{[+D]}$  no longer needs to see both *v* and the embedded *a/n* in (15), a problematic situation in terms of locality constraints.

On the other hand, a main cause for concern would be the increased combinatorics associated with an additional head, in this case  $\text{Pred}$ : what about Unspecified  $\text{Pred}$  and  $\text{Pred}_{[-D]}$ ? Evidence for  $\text{Pred}_{[-D]}$  is hard to establish, although Jim Wood (p.c.) suggests that constructions such as *The wizard turned invisible to avoid being detected* or *The fish turned red to impress its mate* could be the adjectival counterparts of figure reflexives (Section 3.2.2), at least in English.

In addition,  $\text{Pred}_{[+D]}$  would need to be morphologically conditioned by *T* over the intervening  $\text{Voice}$  head. But this issue does already arise for  $p_{[-D]}$ , as discussed in Section 3.4.2. So the analysis may be worth pursuing.



## 4.5 Alternative accounts

This section focuses on a number of competing analyses aiming to explain the behavior of verbs in *heXYiZ*, concentrating mostly on the inchoative alternation. Apart from these, Lev (2016) sketches a theory in which labile verbs are less agentive than others, a claim that could explain why *heet* ‘slowed down’ is possible as opposed to \**hemhir* (from ‘quick’). However, that idea cannot be extended to explain the existence of minimally different *heits* ‘accelerated’ so it will be set aside.

I start with a general question of how alternations should be treated, one which in a way ties together the threads of the last three chapters, before turning to more specific points about *heXYiZ*.

### 4.5.1 Where do alternations live?

As I have tried to make clear, under the current proposal there is no formal way in which an anticausative verb is derived from a causative verb, or a causative verb from an inchoative verb (Schäfer 2008). There are only different Voice heads which can be merged with a core vP. In contrast to this approach, the traditional view of argument structure alternations for Semitic (and beyond) assumes that verbs in one template are derived, or might be derived, from verbs in another template.

Arad (2005) is unique in making such a theory formally explicit and internally consistent. The precise formulation enables us to see exactly what the strengths and weaknesses of such an approach are. Some of these were already mentioned in Section 3.9.2; for others see Kastner & Tucker (submitted). I will invoke her analysis once more in order to further explain how alternations – or perceived alternations – work in different theories.

As noted in Section 3.9.2, Arad (2005) assumes that alternations hold between specific templates, as in the following conjugation classes (Arad 2005: 226). The ones relevant to *heXYiZ* are highlighted.

- (48) a. Conjugation 1: *niXYaZ* → *XaYaZ*  
 b. **Conjugation 2: *XaYaZ* → *heXYiZ***  
 c. **Conjugation 3: *niXYaZ* → *heXYiZ***  
 d. Conjugation 4: *hitXaYeZ* → *XiYeZ*  
 e. Conjugation 5: *hitXaYeZ* → *XiYeZ*  
 f. **Conjugation 6: *heXYiZ* → *heXYiZ***

Three conjugation classes are needed because *heXYiZ* ostensibly alternates with three other templates: *XaYaZ*, *niXYaZ* and *heXYiZ* itself. For example, *nirdam* ‘fell asleep’ alternates with *herdim* ‘put someone to sleep; applied anesthesia’, instantiating (48c).

The spell-out rules relevant to *heXYiZ* are highlighted in (49). In prose: If Class 2, then the inchoative is *XaYaZ* and the causative is *heXYiZ*. If Class 3, then the inchoative is *niXYaZ* and the causative is *heXYiZ*. If Class 6, then the inchoative is *heXYiZ* and the causative is also *heXYiZ*. If the root does not take part in an alternation, then a verb in *heXYiZ* can spell out unmarked *v*, inchoative *v* or causative *v* (but not stative *v*).

(49) Distributed Conjugation Diacritics in Arad (2005: 230):

- |                                                                                                                                                                                                                                                                                                                                                                                                                                                                                                                                      |                                                                                                                                                                                                                                                                                                                                                                                                                                                                                                                                                |
|--------------------------------------------------------------------------------------------------------------------------------------------------------------------------------------------------------------------------------------------------------------------------------------------------------------------------------------------------------------------------------------------------------------------------------------------------------------------------------------------------------------------------------------|------------------------------------------------------------------------------------------------------------------------------------------------------------------------------------------------------------------------------------------------------------------------------------------------------------------------------------------------------------------------------------------------------------------------------------------------------------------------------------------------------------------------------------------------|
| <p>a. <math>v_{unmarked}</math>:</p> <p><math>\alpha \rightarrow XaYaZ</math></p> <p><math>\beta \rightarrow niXYaZ</math></p> <p><math>\gamma \rightarrow Xi\check{Y}eZ</math></p> <p><math>\delta \rightarrow \mathbf{heXYiZ}</math></p> <p><math>\epsilon \rightarrow hitXa\check{Y}eZ</math></p>                                                                                                                                                                                                                                 | <p>c. <math>v_{stat}</math>:</p> <p><math>\alpha \rightarrow XaYaZ</math></p> <p>Class 3 <math>\rightarrow XaYaZ</math></p> <p>Class 5 <math>\rightarrow XaYaZ</math></p>                                                                                                                                                                                                                                                                                                                                                                      |
| <p>b. <math>v_{inch}</math>:</p> <p><math>\alpha \rightarrow XaYaZ</math></p> <p><math>\beta \rightarrow \mathbf{niXYaZ}</math></p> <p>...</p> <p><math>\delta \rightarrow \mathbf{heXYiZ}</math></p> <p><math>\epsilon \rightarrow hitXa\check{Y}eZ</math></p> <p>...</p> <p>Conjugation 2 <math>\rightarrow XaYaZ</math></p> <p>Conjugation 3 <math>\rightarrow \mathbf{niXYaZ}</math></p> <p>Conjugation 4 <math>\rightarrow hitXa\check{Y}eZ</math></p> <p>Conjugation 6 <math>\rightarrow \mathbf{heXYiZ}</math></p> <p>...</p> | <p>d. <math>v_{caus}</math>:</p> <p><math>\gamma \rightarrow Xi\check{Y}eZ</math></p> <p><math>\epsilon \rightarrow \mathbf{heXYiZ}</math></p> <p>Conjugation 1 <math>\rightarrow XaYaZ</math></p> <p>Conjugation 2 <math>\rightarrow \mathbf{heXYiZ}</math><sup>11</sup></p> <p>Conjugation 3 <math>\rightarrow \mathbf{heXYiZ}</math></p> <p>Conjugation 4 <math>\rightarrow Xi\check{Y}eZ</math></p> <p>Conjugation 5 <math>\rightarrow \mathbf{heXYiZ}</math></p> <p>Conjugation 6 <math>\rightarrow \mathbf{heXYiZ}</math></p> <p>...</p> |

In the Trivalent Theory none of this machinery is required. Alternations are an intuitive way of describing what happens when a given core *vP* combines with Unspecified Voice compared to Voice<sub>[-D]</sub> and compared to Voice<sub>[+D]</sub>.

Importantly, I am not claiming that the current theory does away with all of the idiosyncratic listing that Arad’s had. As emphasized throughout this book, all theories need to list at some level which roots can combine with which functional

<sup>11</sup>Arad (2005: 231) has this as *niXYaZ*, which as far as I can tell is a typo.

heads/templates. But I hope it is clear why the Trivalent Theory is to be preferred: beyond the empirical arguments I adduce, the overall view of the grammar is more streamlined, less stipulative, and much more in line with our theories of non-Semitic languages.

A theory using conjugation classes needs to make reference to silent flavors of *v* (whereas the elements I have proposed are all overt). It can also encode virtually any alternation. That may well be too powerful but it does absolve the theory of the need to worry about the combinatorics of individual heads, which is a potential advantage over the Trivalent Theory insofar as the behavior of  $\text{Voice}_{[+D]}$  is concerned. Concretely, my account does not contain a principled answer to the question why  $\text{Voice}_{[+D]}$  cannot attach to a  $[\sqrt{\text{ACTION}} \text{vP}]$  – this is possible, but I am not claiming that any template instantiates this combination. One possible answer is that a structure such as  $[\text{Voice}_{[+D]} [\sqrt{\text{ACTION}} \text{vP}]]$  would just entail an agentive reading, something that  $\text{Voice}_{[+D]}$  is already compatible with, or a specific causative reading from among the kinds in Table 4.6. Furthermore, the phonology of  $\sqrt{\text{ACTION}}$  could in principle be impoverished under  $\text{Voice}_{[+D]}$ . Under a functionalist view,  $\sqrt{\text{ACTION}}$  and  $\text{Voice}_{[+D]}$  do similar work. This kind of issue, however, is much more pressing when pointed right back at the conjugation class and morphemic accounts: why are these specifically the conjugation classes that exist and the templates that exist?

#### 4.5.2 Added structure

A different alternative view might counter that  $\text{Voice}_{[+D]}$  does not exist. On this view, verbs in *heXYiZ* are not derived using  $\text{Voice}_{[+D]}$  but by additional structure atop of regular, active Voice.

Let me briefly outline what such an analysis would look like. This structure would presumably consist of some higher causative head, perhaps another layer of Voice.<sup>12</sup> While this idea holds theoretical promise, there are a few reasons why I do not think it is appropriate for the Hebrew data, having to do with incorrect predictions in the phonology and in the syntax-semantics.

First,  $\text{Voice}_{[+D]}$  seems as integrated into the morphophonological system as the other Voice heads, namely Unspecified Voice and  $\text{Voice}_{[-D]}$ . In particular, the analysis in Kastner (2019b) shows that the spell-out of  $\text{Voice}_{[+D]}$  is subject to the same locality constraints as that of Voice and  $\text{Voice}_{[-D]}$ . Splitting  $\text{Voice}_{[+D]}$  into two layers of Voice will disrupt these locality relations, thereby making the wrong predictions in the phonological component.

<sup>12</sup>For variants of the idea that an analytic causative can be deriving using Voice-over-Voice, see Blanco (2011), Harley (2013a; 2017) and Nie (2020).

Second, this approach would treat *heXYiZ* as a straightforward “make”-causative (analytical causative). This much is clearly wrong for the unergative and unaccusative verbs in this template as it misses the fact that causatives in this template are “lexical”, as discussed in Section 4.4.1.

Third, assuming that another Voice head can be added to VoiceP makes the false prediction that a transitive in *XaYaZ* and a causative in *heXYiZ* will have the same internal argument. This is once again incorrect, as we saw in Section 4.4.1.

And fourth, in Section 5.1 I discuss how passives are derived by use of an additional head *Pass*. As explained there, *Pass* can only attach to *Voice*<sub>[+D]</sub> or to *Voice*+ $\sqrt{\text{ACTION}}$ , but not to *Voice* on its own. If we were to assume that *Voice*<sub>[+D]</sub> is actually *Voice*+*Voice*, we would need to make an additional stipulation regarding configurations that can be passivized. This last problem is not insurmountable but it would complicate the theory.

#### 4.5.3 CAUS and existential closure

A different kind of alternative analysis concerns itself mostly with the inchoatives of Section 4.2.2. This analysis would posit a silent, generic Causer in *Spec, Voice*<sub>[+D]</sub>. The analysis in Doron (2003: 61) – which in many ways is a precursor to the theory presented in this work – assumes that a causative head *CAUS* gives rise to *heXYiZ*. The problem for the system in Doron (2003) is that if these verbs are derived using *CAUS* rather than the middle head *MID*, we have no explanation for their unaccusativity.

As a result, Doron (2003: 62) must conclude that “*x reddened* is equivalent to *Something caused x to redden*”, with *CAUS* introducing a Causer that is existentially quantified over. This kind of account is more in line with a passive analysis than a causative one.<sup>13</sup>

Assume for the sake of the argument that a silent element fills *Spec, Voice*<sub>[+D]</sub> in inchoatives. One would need to specify the exact featural makeup of this element, for example a null subject *pro*. The result would be a transitive structure where *pro* should be assigned Nominative case and the internal argument should be assigned Accusative case. Definite accusative objects in Hebrew take the direct object marker *et*, so we would predict that *et* appears before inchoatives in *heXYiZ*. But this is incorrect: the generic Causer cannot be a silent pronoun in a transitive relationship with the internal argument.

- (50) a. \* *heʃmin et ha-xatul*  
fattened.CAUS ACC the-cat

<sup>13</sup>Although Doron’s morphosemantic head did form the direct inspiration for the current *Voice*<sub>[+D]</sub>, just as her *MID* and *INTNS* heads paved the way for *Voice*<sub>[–D]</sub> and  $\sqrt{\text{ACTION}}$ .

- b. \* *et* ha-xatul hefmin  
 ACC the-cat fattened.CAUS  
 (int. ‘The cat grew fat’)

Another tack would be to say that instead of *pro*, the silent external argument is a Weak Implicit Argument in the sense of Landau (2010): a bundle of phi-features with no [D] feature (cf. Legate 2014; Bhatt & Pancheva 2017), distinguishing it from a Strong Implicit Argument such as *pro*. If there is no [D] feature on the weak EA, it does not participate in the calculus of case and the IA will receive unmarked case, i.e. Nominative. This kind of analysis ends up being very similar to the one in the current proposal: the external argument is not taking part in any relevant syntactic process, and whatever requirements Voice<sub>[+D]</sub> has still need to be satisfied. Furthermore, this bundle of phi-features would then have no detectable effects in the syntax or phonology, rendering it purely stipulative. In the absence of a convincing account for implied Causers, I reject this analysis.

#### 4.5.4 Contextual allomorphy

Another possible analysis of inchoatives is strictly morphological in nature. Under this account, unaccusative inchoatives are true unaccusatives derived with Voice<sub>[-D]</sub>, except that the allomorphic rule in (51a) causes Voice<sub>[-D]</sub> to be pronounced like *heXYiZ* rather than like *niXYaZ*.

- (51) a. Voice<sub>[-D]</sub> ↔ *heXYiZ* / \_\_\_ {√lbn, √dm, √xlk̄, √xvr, √jmn, ...}  
 b. Voice<sub>[-D]</sub> ↔ *niXYaZ*

One question which arises is whether we would like to postulate this rule for a list of just over 30 roots. Furthermore, the mystery would remain of why it is specifically *heXYiZ* that houses inchoatives: why doesn't the rule in (51a) insert the form of any other template, such as *XaYaZ*, *niXYaZ* or *XiYeZ*? This solution is technically possible but conceptually unenlightening, and it postulates two homophonous VIs *heXYiZ* (one spelling out Voice<sub>[+D]</sub> and one spelling out Voice<sub>[-D]</sub>).

That being said, it does correctly predict that the roots to which this rule applies cannot surface in *niXYaZ*, only in *hitXaYeZ*, (52). The reason is that forms in *niXYaZ* are generated using Voice<sub>[-D]</sub>, but Voice<sub>[-D]</sub> is pronounced as *heXYiZ*.

- (52) a. *helbin* ~ \**nilban* ‘whitened’  
 b. *heedim* ~ \**nidam* ‘reddened’  
 c. *hefmin* ~ \**nifman* ‘fattened’

## 4.5.5 Verbalizing affix

In the last alternative to be considered, Borer (1991) presents an analysis of *heX-YiZ* alternations couched in Parallel Morphology (which I have translated into comparable terms in the current theory). Her account consists of two main parts. In the first, she argues that inchoative forms are derived from adjectives while causative forms are derived from a root/verb. In the second, she presents an analysis showing why it must be the case – given certain assumptions – that causatives are formed in the lexicon and inchoatives in the syntax. The Trivalent analysis is similar to hers in adopting separate structures for causatives and inchoatives, albeit using different argumentation. The content of the analysis is different, though, since for Borer (1991) *heXYiZ* is a single verbalizing morpheme which subcategorizes for an adjective.

This approach takes Hebrew *heXYiZ* and English *-en* to be verbalizers subcategorizing for an adjectival stem, be it a property root or an adjective (Borer 1991: 136). When this is done in the “lexicon” by verbalizing a root, the result is a causative verb:

$$(53) \quad [{}_v \sqrt{\text{WIDE}} -en]$$

When this is done in the syntax by verbalizing an adjective, the result is an inchoative verb:

$$(54) \quad [{}_v [{}_a \sqrt{\text{WIDE}} a] -en]$$

Crucially for us, the analysis does not answer the questions posed earlier on in the discussion of inchoatives: why this template and why these roots. Here *heXYiZ* is assumed to be a de-adjectival verbalizer, just like *-en*, without discussion of this template’s role in the overall morphosyntax of the language. While it is stipulated that *heXYiZ* as a verbalizer subcategorizes for an adjective, this is not always the case: as shown above, many inchoatives are derived from underlying nouns. More importantly, even run-of-the-mill causatives such as *hexnis* ‘inserted’, *hexil* ‘fed’ and *helbif* ‘dressed’ are not derived from underlying adjectives.

The causative *hexnis* ‘inserted’ is derived from  $\sqrt{\text{kns}}$ , but without a simple adjective  $*[{}_a \sqrt{\text{kns}} a]$ . One could posit an abstract adjective that is never lexicalized, but it is unclear what this non-existent adjective would be like or what its phonological form would have been (*\*kanus?*).

- (55) ha-malka *hexnis-a*            et    ha-sefer la-tik.  
 the-queen inserted.CAUS-F ACC the-book to.the-bag  
 ‘The queen put the book in the bag.’

The causative *heexil* ‘fed’ is derived from  $\sqrt{k\bar{l}}$ , but probably not from *axul* ‘consumed’, a rare adjectival passive of *axal* ‘ate’.

- (56) a. ha-nasix *heexil* et ha-kivsa.  
 the-prince fed.CAUS ACC the-sheep  
 ‘The prince fed the sheep.’  
 b. ≠ ha-nasix garam la-kivsa lihiot *axula*.  
 the-prince caused to.the-sheep to.be consumed  
 ‘The prince caused the sheep to be consumed.’

And the causative *helbif* ‘dressed’ is derived from  $\sqrt{l\bar{b}f}$ , but probably not from *lavuf* ‘dressed up’, the adjectival passive of *lavaf* ‘wore’, which seems to be reserved for descriptions of a full costume.

- (57) a. ha-ima *helbif-a* et ha-jeled (be-)xalifa jafa.  
 the-mom dressed.CAUS-F.SG ACC the-boy in-suit pretty  
 ‘The mother put the boy’s pretty suit on (him).’  
 b. “On making his discovery, the astronomer had presented it to the International Astronomical Congress, in a great demonstration, ...  
 aval if lo he’ezin le-dvara-v, mifum fe-haja *lavuf*  
 but nobody NEG listened to-words-his, since COMP-was dressed.up  
 be-tilobjet turkit. ka’ele hem ha-mevugarim.  
 in-outfit Turkish such 3PL the-grown.ups  
 But he was in Turkish costume, and so nobody would believe what he said. Grown-ups are like that.” (Antoine de Saint-Exupéry, *The Little Prince*, Chapter 4. Hebrew by Jude Shva<sup>14</sup>)

The analysis in Borer (1991) did not attempt to find an underlying reason for why *heXYiZ* is used for both causatives and inchoatives, as well as for general causativization in the rest of the system. Nevertheless, it remains the only in-depth study of this alternation that I know of. Recall, for the last part of this discussion, that this analysis also postulates a structural difference between *heX-YiZ* causatives, (53), and inchoatives, (54). I review this distinction next.

The logic works as follows: if an adjective passes certain diagnostics, and the inchoative does but the causative does not, then the adjective must be embedded in the inchoative (Borer 1991: 130). Starting with an English example, the adjective *wide* is said to license comparisons with *as/like* and comparative forms, whereas the inchoative *widen* does not. Borer’s claim is that comparison adverbials and the comparative must be licensed by an adjective (contrasts hers).

<sup>14</sup>[http://www.oocities.org/sant\\_exupery/c4.htm](http://www.oocities.org/sant_exupery/c4.htm)

4 Voice<sub>[+D]</sub>

- (58) a. The canal is {as **wide** as a river / **wider** than a river.}  
 b. The canal **widened** {like a river / more than a river}.  
 (int. ‘The canal became as wide as a river is wide / became more wide than a river is wide’)  
 c. \* The flood **widened** the canal {like a river / more than a river}.  
 (int. ‘The flood made the canal as wide as a river is wide / made the canal wider than a river is wide’)

I suspect that there is much more variation in acceptability for the utterances in (58), and that an adverbial reading normally overpowers the scalar one (‘The flood widened the canal like a river widens it’). Three native speaker linguists I have consulted do not share these contrasts but I am more interested in the argumentation involved with this approach.

Taking the adjective *fmen-a* ‘fat-F.SG’, it is claimed to license comparatives, (59a). Inchoatives license comparatives too, (59b), but causatives do not, (59c). Judgments are as in Borer (1991); example (59c) does not sound as degraded to me, but it does to another speaker I consulted informally.

- (59) a. Adjective:  
 ha-xatula *fmena* { kmo xazir / joter mi-xazir }.  
 the-cat fat like pig more than-pig  
 ‘The cat is fat as a pig / fatter than a pig.’  
 b. Inchoative:  
 ha-xatula *hefmina* { kmo xazir / joter mi-xazir }.  
 the-cat fattened like pig more than-pig  
 ‘The cat grew as fat as a pig / fatter than a pig.’  
 c. \* Causative:  
 ha-zrika *hefmina* et ha-xatula { \*kmo xazir / \*joter me-xazir }  
 the-injection fattened OM the-cat.F like pig more than-pig  
 (int. ‘The injection made the cat fat as a pig / more than a pig is fat.’)

Similarly, some adverbs (*haxi fe-effar* ‘as much as possible’) must be licensed by an adjective and accordingly only appear with inchoatives, not causatives.

It seems to me that the success of this diagnostic depends to a large extent on the lexical items chosen. For example, using the antonym *herza* ‘grew thin’, my judgments are slightly different:



- (60) a. Adjective:  
 ha-xatula *raza* { kmo makel / ?joter mi-makel }.  
 the-cat thin like stick more than-stick  
 ‘The cat is as thin as a rail / skinnier than a rail.’
- b. ? Inchoative:  
 ha-xatula *herzeta* { kmo makel / ??joter mi-makel }.  
 the-cat thinned like stick more than-stick  
 (int. ‘The cat became as thin as a rail / skinnier than a rail.’)
- c. ?? Causative:  
 ha-zrika *herzeta* et ha-xatula { ??kmo makel / ??joter  
 the-injection thinned OM the-cat like stick more  
 mi-makel }  
 than-stick  
 (int. ‘The injection made the cat as thin as a rail / skinnier than a  
 rail.’)

With *heet* ‘slowed down’ I judge inchoatives unacceptable and causatives slightly better though still degraded. These judgments are meant to highlight the variance, not to be taken as categorical for all alternations or all speakers.

- (61) a. Adjective:  
 ha-mexonit ha-zo *itit* { kmo tsav / joter mi-tsav }.  
 the-car the-this slow like turtle more than-turtle  
 ‘This car is as slow as a turtle / slower than a turtle.’
- b. \* Inchoative:  
 ha-mexonit ha-zo *heeta* { \*kmo tsav / \*joter mi-tsav }  
 the-car the-this slowed like turtle more than-turtle  
 (int. ‘This car slowed down to turtle speed / to sub-turtle speed.’)  
 (More acceptable on a reading of ‘The car slowed down like a  
 turtle slowed down’.)
- c. ?? Causative:  
 ha-baaja **ba-hiluxim** *heeta* et ha-mexonit { ??kmo tsav /  
 the-problem in.the-gears slowed ACC the-car like turtle  
 ??joter mi-tsav }  
 more than-turtle  
 (int. ‘The problem with the gear box slowed the car down to turtle  
 speed / to sub-turtle speed.’)

It is also left vague what precisely this diagnostic is probing. In (62), for instance, there is no underlying adjective ‘beloved’ but the utterance is completely acceptable:<sup>15</sup>

- (62) ani *ohēv*                      otxa **kmo ax**.  
 I love.SMPL.PTCP you.M like brother  
 ‘I love you like a brother.’

Since I am not sure that the argument from comparatives generalizes, and given that no explicit syntax or semantics for this modification was put forward, I do not endorse the arguments for distinct structures put forward in Borer (1991). Nevertheless, the current proposal has recast that intuition in contemporary terms and supported it using different arguments. Hopefully these were explicit enough to be similarly challenged in future work.

## 4.6 Conclusion

This chapter developed the theory of [+D] in Voice based on an in-depth analysis of various verb types in *heXYiZ*. This template predominantly instantiates active verbs, usually causatives. It is also reasonably productive. Yet a number of roots derive inchoative verbs in this template.

- (63) Generalizations about *heXYiZ*
- a. *Configurations*: Verbs appear in transitive and unergative configurations; a small class of verbs forms unaccusative degree achievements.
  - b. *Alternations*: Some verbs are causative or active versions of verbs in other templates, especially *XaYaZ*. A small class of verbs creates a labile alternation within *heXYiZ*.

The analysis proposed here showed how the influence of a certain class of roots can be accommodated in the grammar, while keeping constant the overall behavior of the functional head. The existence of unmarked and marked causatives was discussed with respect to the leeway different roots have within similar structures. The feature [+D] must have some semantic content beyond the unmarked causative.

The two factors conspiring to create a labile alternation in a language that otherwise does not allow such an alternation are the root and the syntactic structure. The roots fall under various lexical semantic classes but all appear to derive

<sup>15</sup>Thanks to Idan Landau for pointing this out to me.

degree achievements from underlying nouns or adjectives, as suggested by Lev (2016). The syntax which facilitates this derivation is one in which a noun or adjective is first formed before it is verbalized, and then combined with the causative head Voice<sub>[+D]</sub>. This theoretical approach allows us to ask more specific questions about how the idiosyncratic information associated with roots interacts with the syntactic structure in which they are embedded.

Taken together, these last three chapters cashed out the Trivalent Theory of Voice which is at the core of this book. The next chapter rounds off the empirical picture by examining cases in which these heads interact with additional structure: passivization, adjectival passives and nominalization.



## 5 Passives and nominalizations

The three preceding chapters introduced a system of Voice heads which, at present, has only been proposed for argument structure alternations in Hebrew (the next two chapters consider whether other languages should be analyzed similarly). Recapping Chapters 2–4, there are seven distinct possibilities for verbal forms (five non-passive templates), summarized in Table 5.1.

Table 5.1: Seven combinations of functional heads so far

| Voice?                | $\sqrt{\text{ACTION}}$ ? | $p_{[-D]}$ ? | Template                    |
|-----------------------|--------------------------|--------------|-----------------------------|
| Voice                 |                          |              | <i>XaYaZ</i>                |
| Voice                 | $\sqrt{\text{ACTION}}$   |              | <i>XiY<sub>̄</sub>eZ</i>    |
| Voice <sub>[-D]</sub> |                          |              | <i>niXYaZ</i>               |
| Voice <sub>[-D]</sub> | $\sqrt{\text{ACTION}}$   |              | <i>hitXaY<sub>̄</sub>eZ</i> |
| Voice <sub>[+D]</sub> |                          |              | <i>heXYiZ</i>               |
| Voice                 |                          | $p_{[-D]}$   | <i>niXYaZ</i>               |
| Voice                 | $\sqrt{\text{ACTION}}$   | $p_{[-D]}$   | <i>hitXaY<sub>̄</sub>eZ</i> |

But argument structure exists beyond just the verbal domain: some nominals and adjectives have arguments too, and in Hebrew in particular, the morphological history of some derived forms is clearly verbal. The question to be examined here is, how well does the Trivalent Theory predict behavior in derived forms?

In this chapter I look into three constructions whose behavior is generally well understood: VERBAL PASSIVES, ADJECTIVAL PASSIVES and NOMINALIZATIONS. I say “well understood” but of course implementations differ, as do some theoretical views. The scope of the current chapter is limited: I take the theory developed thus far and essentially see what happens when the different VoicePs are embedded in additional structure. Where I believe the results do bear on current debates, I highlight this, but otherwise the focus is on showing how, once the “exotic” VoiceP of a non-concatenative language has been built up, higher material combines in a fairly transparent fashion syntactically, semantically and phonologically.

In other words, I am taking the structures underlying the constructions of this chapter to be universal. Accordingly, the different sections of this chapter will look a little different than the previous ones. Section 5.1 looks at passive verbs (the head *Pass*), Section 5.2 at adjectival passives (the head *a*), Section 5.3 at nominalizations (the head *n*), and a conclusion with some discussion of denominal verbs follows in Section 5.4. In each case I begin with some general background on the state of the art. Then the Hebrew data is introduced, followed by the formal analysis (combining the general consensus with the Hebrew data). Importantly, the different templates interact with these embedding heads in different ways, so we will spend some time analyzing these interactions as well.

## 5.1 Passivization

### 5.1.1 Background

My definition of a *PASSIVE* verb is given in (1). It is not meant to be controversial in any way; see Williams (2015) for an overview of various related issues.

- (1) a. A passive verb is an intransitive verb which does not have an overt external argument in the regular subject position but does have an Agent which is either (a) implicit and existentially closed over or (b) made overt in a *by*-phrase.
- b. Formally, there is no external argument in *Spec,VoiceP* (or *Spec,TP*, for that matter) but there is an Agent role in the semantics.

I would like to clarify right from the start that what is often descriptively called “the passive” is not necessarily what I mean by my formal definition. One often reads about the “passive” in Romance languages (as with *se* in French), in Greek or in various other languages and language families. But this term is used pretheoretically and as a matter of convenience: the element tracked by French *se*, Greek non-active morphology, the Kannada non-active suffix (Lidz 2001) and so on is a non-active Voice head. As argued by Alexiadou & Doron (2012) and Alexiadou et al. (2015: 123), and emphasized again by Spathas et al. (2015) and Kastner & Zu (2017), there are two structures which can give rise to passive *readings*. One is a *VoiceP* with a non-active Voice head, as in Greek, Romance and many other languages. The other is what we obtain when we use a dedicated passive head, *Pass*. This is the case in English, German and a few other languages.<sup>1</sup> Hebrew, as

---

<sup>1</sup>The list is not very long, consisting also of Classical Greek, some Semitic languages and Fula. See Klaiman (1991) and Alexiadou & Doron (2012).

we have seen, has both options (Alexiadou & Doron 2012): existential closure as an alloeme of Voice<sub>[-D]</sub> (Section 3.3) and the head Pass which I implement next.

The literature suggests a number of characteristics of passives which can be used as diagnostics (Baker et al. 1989; Sichel 2009; Spathas et al. 2015), a few of which were already used in Section 3.2.1. Passive verbs/clauses can take *by*-phrases specifying the Agent (2), allow Agent-oriented adverbs (3), allow control into adjunct clauses (4) and show disjoint reference effects (5), i.e. no coreference of Agent and Theme. Existential binding of the implicit Agent means that it itself cannot be controlled or bound (6).

- (2) The ship was sunk (by Bill).
- (3) The ship was sunk deliberately.
- (4) EA<sub>i</sub> The ship was sunk to PRO<sub>i</sub> collect the insurance.
- (5) EA<sub>i</sub> The child<sub>\*i/j</sub> was combed.
- (6) a. Mary<sub>i</sub> wants John to be seen (\*by Mary<sub>i</sub>).
- b. Every journalist<sub>i</sub> wants the President to be interviewed (by someone<sub>\*i/j</sub>).

Synthesizing the existing literature on passive heads (Bruening 2013; Alexiadou et al. 2015), I formalize Pass as follows. In the *syntax*, Pass merges above Voice. It is incompatible with merger of a DP in Spec,VoiceP immediately below it. Bruening (2013) implements this constraint as a selectional requirement on the size of the VoiceP combining with the passive head.

In the *semantics*, Pass likewise brings about existential closure over an implicit external argument, (7). There are two ways of formalizing this idea. The one I adopt is that of Bruening (2013), where Pass takes the VoiceP as its argument and closes off the Agent role:

$$(7) \llbracket \text{Pass} \rrbracket = \lambda P \lambda e \exists x. \text{Agent}(x, e) \ \& \ P(e)$$

This denotation is identical to what I suggested for the passive alloeme of Voice<sub>[-D]</sub> in Section 3.3.2, (8).

$$(8) \llbracket \text{Voice}_{[-D]} \rrbracket =$$

- a.  $\lambda P \lambda e \exists x. \text{Agent}(x, e) \ \& \ P(e) / \{ \sqrt{\text{rtsx}} \text{ 'murder' }, \sqrt{\text{mr}} \text{ 'say' }, \dots \}$
- b.  $\lambda P_{\langle s, t \rangle}. P$

An alternative semantics is to force Voice to choose an Agent-less alloeme in the context of Pass, and then let Pass introduce an (existentially closed off) Agent itself. I note this possibility for completeness.

## 5 Passives and nominalizations

- (9)  $[[\text{Voice}]] = \lambda P.P / \text{Pass} \text{ \_\_\_}$   
 (10)  $[[\text{Pass}]] = \lambda P \lambda e \exists x.P(e) \ \& \ \text{Agent}(x,e)$

The *phonology* of Pass is language-specific. In English it spells out the auxiliary *be*, in German it spells out *werden*, and in Hebrew I will claim below that it overwrites the vowels of the stem VoiceP it merges with.

### 5.1.2 Descriptive generalizations

There are two exclusively passive templates in Hebrew: *XuYaZ* and *huXYaZ*. I have not described these templates yet. An active-passive example pair with *XuYaZ* is given in (11).

- (11) a. ha-jeled *sider* et ha-xeder.  
           the-boy organized.INTNS ACC the-room  
           ‘The boy tidied up his room.’  
       b. ha-xeder *sudar* (al-jedej ha-jeled).  
           the-room organized.INTNS.PASS by the-boy  
           ‘The room was tidied up (by the boy).’

I use *XuYaZ* and *huXYaZ* interchangeably here since there does not seem to be any difference between them, beyond the fact that they are derived from different templates.

Hebrew passives pass the standard tests above. The *by*-phrase can be seen in (11) and the rest are given below: agent-oriented adverbs (12), control into adjunct clauses (13), disjoint reference effects (14) and existential binding of the implicit Agent (15).

- (12) ha-sfina *hutbea* be-jodin.  
       the-ship sank.CAUS.PASS in-cognizance  
       ‘The ship was sunk deliberately.’  
 (13) EA<sub>i</sub> ha-sfina *hutbea* kedelj PRO<sub>i</sub> lekabel et  
       the-ship sank.CAUS.PASS in.order.to to.receive ACC  
       ha-bituax.  
       the-insurance  
       ‘The ship was sunk to collect the insurance.’  
 (14) EA<sub>i</sub> ha-jeled<sub>\*i/j</sub> *sorak*.  
       the-boy combed.INTNS.PASS  
       ‘The boy was combed.’



- (15) a. *dana<sub>i</sub> rotsa fe-ha-jeled jesorak* (\*al-jedej *dana<sub>i</sub>*).  
 Dana wants that-the-boy will.comb.INTNS.PASS by Dana  
 ‘Dana wants the boy to be combed (\*by Dana<sub>i</sub>)’.
- b. *kol hore<sub>i</sub> rotse fe-rof ha-memfala*  
 every parent wants that-head.of the-government  
*jesorak* (al-jedej *mifeu<sub>\*i/j</sub>*).  
 will.comb.INTNS.PASS by someone  
 ‘Every parent wants the Prime Minister to be combed (by someone else).’

It is generally accepted that verbal passives in Hebrew are derived from an active counterpart via some operation of passivization in the syntax, be the framework syntactic (Doron 2003; Alexiadou & Doron 2012; Borer 2013) or lexicalist (Reinhart & Siloni 2005; Ussishkin 2005; Laks 2011). The meaning of a verb in the passive is compositional and transparent in a way that non-passive templates are not. For example, verbs in the “passive intensive” *XuY<sub>i</sub>aZ* are always the passivized version of an active verb in “intensive” *XiY<sub>i</sub>eZ*, Table 5.2a, and verbs in “passive causative” *huXYaZ* are always the passivized version of an active verb in “causative” *heXYiZ*, row b.

Table 5.2: Predictable alternations in the passive templates

|                                                 | Active                                            | Passive                                               |
|-------------------------------------------------|---------------------------------------------------|-------------------------------------------------------|
| a. <i>XiY<sub>i</sub>eZ ~ XuY<sub>i</sub>aZ</i> | <i>bif<sub>i</sub>el</i> ‘cooked’                 | <i>bu<sub>i</sub>fal</i> ‘was cooked’                 |
| b. <i>heXYiZ ~ huXYaZ</i>                       | <i>he<sub>i</sub>f<sub>i</sub>mid</i> ‘destroyed’ | <i>hu<sub>i</sub>f<sub>i</sub>mad</i> ‘was destroyed’ |

A derivational view “in the syntax”, according to which an existing active verb is passivized into a passive verb, accounts for two important facts about passives in Hebrew: first, there do not exist any passive verbs (that is, verbs in *XuY<sub>i</sub>aZ* and *huXYaZ*) without an active base from which they are derived; and second, that passive verbs cannot mean anything other than passivization of the active form, where PASSIVIZATION means suppression of the external argument as defined above.

Morphophonologically, verbs in the two passive templates have two important characteristics. The first, as mentioned above, is that they form predictable alternations. Verbs in *XuY<sub>i</sub>aZ* are derived from active verbs in *XiY<sub>i</sub>eZ*, while verbs in *huXYaZ* are derived from active verbs in *heXYiZ*. The second characteristic had not been discussed explicitly before Kastner (2019b), although some aspects

5 *Passives and nominalizations*

of it were noticed in a number of works (Ussishkin 2005; Borer 2013): the form of the stem uniformly has the vowels *u-a*, regardless of underlying active template, root, tense or any other variable. This can be seen in the full paradigms in Tables 5.3–5.4 and stands in stark contrast to the active forms seen throughout this book.

Table 5.3: Past of passive *gudal* ‘was raised’ and *hugdal* ‘was enlarged’

|    | $Xu\bar{Y}aZ \sqrt{gdl}$ |                  | $huXYaZ \sqrt{gdl}$ |                    |
|----|--------------------------|------------------|---------------------|--------------------|
|    | SG                       | PL               | SG                  | PL                 |
| 1  | <i>gudal-ti</i>          | <i>gudal-nu</i>  | <i>hugdal-ti</i>    | <i>hugdal-nu</i>   |
| 2M | <i>gudal-ta</i>          | <i>gudal-tem</i> | <i>hugdal-ta</i>    | <i>hugdal-tem</i>  |
| 2F | <i>gudal-t</i>           | <i>gudal-tem</i> | <i>hugdal-t</i>     | <i>hugdal-tem</i>  |
| 3M | <i>gudal</i>             | <i>gud⟨a⟩l-u</i> | <i>hugdal</i>       | <i>hugd⟨a⟩el-u</i> |
| 3F | <i>gud⟨a⟩l-a</i>         | <i>gud⟨a⟩l-u</i> | <i>hugd⟨a⟩el-a</i>  | <i>hugd⟨a⟩el-u</i> |

Table 5.4: Future of passive *jegudal* ‘will be raised’ and *jugdal* ‘will be enlarged’

|    | $Xu\bar{Y}aZ \sqrt{gdl}$ |                      | $huXYaZ \sqrt{gdl}$ |                     |
|----|--------------------------|----------------------|---------------------|---------------------|
|    | SG                       | PL                   | SG                  | PL                  |
| 1  | <i>j-e-gudal</i>         | <i>n-e-gudal</i>     | <i>j-ugdal</i>      | <i>n-ugdal</i>      |
| 2M | <i>t-e-gudal</i>         | <i>t-e-gud⟨a⟩l-u</i> | <i>t-ugdal</i>      | <i>t-ugd⟨a⟩el-u</i> |
| 2F | <i>t-e-gud⟨a⟩l-i</i>     | <i>t-e-gud⟨a⟩l-u</i> | <i>t-ugd⟨a⟩el-i</i> | <i>t-ugd⟨a⟩el-u</i> |
| 3M | <i>j-e-gudal</i>         | <i>j-e-gud⟨a⟩l-u</i> | <i>j-ugdal</i>      | <i>j-ugd⟨a⟩el-u</i> |
| 3F | <i>t-e-gudal</i>         | <i>j-e-gud⟨a⟩l-u</i> | <i>t-ugdal</i>      | <i>j-ugd⟨a⟩el-u</i> |

These are the last two verbal templates we will address as such, so here is a summary of their (identical) behavior.

- (16) Generalizations about  $Xu\bar{Y}aZ$  and  $huXYaZ$
- Configurations*: Verbs appear in passive configurations only.
  - Alternations*: Verbs in  $Xu\bar{Y}aZ$  are always the passive version of an active verb in  $Xi\bar{Y}eZ$ . Verbs in  $huXYaZ$  are always the passive version of an active verb in  $heXYiZ$ .

## 5.1.3 The head Pass in Hebrew

Following the argument for independent Pass in Doron (2003) and Alexiadou & Doron (2012), I have argued that Pass combines with VoiceP in fairly uninteresting ways in Hebrew, although some aspects of the results are informative (Kastner & Zu 2017; Kastner 2019b). I summarize the findings here.

An existing VoiceP can be passivized by Pass. To make things precise, the structure for active *hegdil* ‘enlarged’ is given in (17a) and for passive *hugdal* ‘was enlarged’ in (17b).

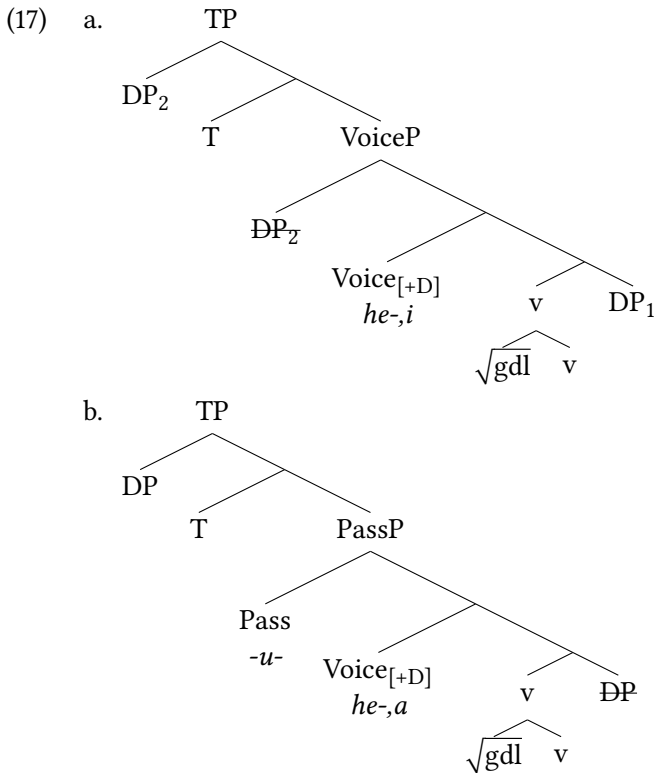

These structures derive the syntactic and semantic generalizations, in that the passive verbs are derived directly from active verbs in two specific templates.

Kastner (2019b) shows in detail how this structural configuration also predicts the right allomorphic interactions. For the example above, Voice<sub>[+D]</sub> is structurally adjacent to T and so its stem vowels can be conditioned by the value of Tense or the phi-features on T. Such contextual conditioning of Voice<sub>[+D]</sub> is not possible once Pass intervenes, leading to the uniform *u-a* pattern. The same holds for *XuYaZ*.

5 Passives and nominalizations

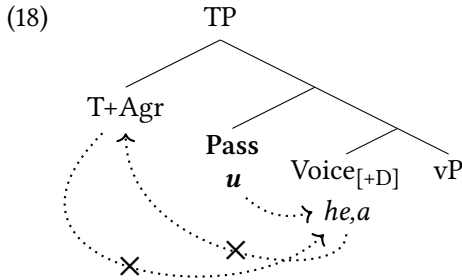

- (19) a.  $\sqrt{\text{gdl}} \leftrightarrow \text{gdl}$   
 b.  $\text{Voice}_{[+D]} \leftrightarrow \begin{cases} \text{he,a} & / \text{Pass} \text{ \_\_\_\_} \\ \text{he,i} & / \text{\_\_\_\_} \end{cases}$   
 c.  $\text{Pass} \leftrightarrow [+high +round]_{\text{Pass}}$

- (20) a. Cycle 1 (VoiceP):  $/\text{he,a}/ + / \text{gdl}/ \Rightarrow \text{hegdal}$   
 b. Cycle 2 (PassP):  $/\text{u}/ + \text{hegdal} \Rightarrow \text{hugd al}$

Consider next why it is not possible to posit an additional, passive variant of Voice for Hebrew (an additional non-active Voice head). If *heXYiZ* is derived using  $\text{Voice}_{[+D]}$ , as assumed, then a transparent passivization cannot be accomplished by changing the Voice head: we would end up with an entirely different construction, one that loses all connection (semantic and phonological) to  $\text{Voice}_{[+D]}/\text{heXYiZ}$ . I conclude that passive verbs really are derived by use of a Pass head above Voice and below T, and that combining the Pass analysis of passives with the system presented in this book correctly predicts the syntactic, semantic and phonological behavior of passive verbs in Hebrew.

What remains to be discussed is the combinatorics of Pass with the different VoicePs. The combinations in Table 5.5 should be considered.

Table 5.5: Combinations of Pass and VoiceP

|    |      |                       |                        | Attested? |
|----|------|-----------------------|------------------------|-----------|
| a. | Pass | Voice                 |                        | <b>X</b>  |
| b. | Pass | Voice                 | $\sqrt{\text{ACTION}}$ | $XuY_aZ$  |
| c. | Pass | $\text{Voice}_{[-D]}$ |                        | <b>X</b>  |
| d. | Pass | $\text{Voice}_{[-D]}$ | $\sqrt{\text{ACTION}}$ | <b>X</b>  |
| e. | Pass | $\text{Voice}_{[+D]}$ |                        | $huXYaZ$  |

There is no overt morphological evidence for Pass combining with Unspecified Voice. As far as I can tell, this is a historical accident: classical Hebrew had a template encoding “the passive of *XaYaZ*”, i.e. [Pass VoiceP]. Kastner (2016: 120) speculates that in Modern Hebrew, Pass can only combine with structures which “guarantee” an external argument; these are rows b and e of Table 5.5, but not the others.

It could also be suggested that what I have called the passive alloseme of Voice<sub>[-D]</sub> is in fact the spell-out of [Pass Voice]. But Ahdout & Kastner (2019) marshal a number of arguments against this possibility. First, Pass-passives (in *XuYaZ* and *heXYiZ*) cannot ever undergo nominalization or form infinitives and imperatives (Kastner & Zu 2017), but Voice<sub>[-D]</sub>-passives can. And second, Pass has the predictable morphological properties mentioned above, while Voice<sub>[-D]</sub> is morphologically unrelated to other forms.

## 5.2 Adjectival passives

### 5.2.1 Background

The distinction between VERBAL PASSIVES and ADJECTIVAL PASSIVES is well established in the literature, although accounts differ on where the line should be drawn (Wasow 1977; Levin & Rappaport 1986; Borer & Wexler 1987; Embick 2004a; Alexiadou et al. 2014; 2015; Bruening 2014). However diagnosed and analyzed, verbal passives are taken to be part of the verbal system and adjectival passives to pattern distributionally with adjectives.

What I wish to highlight is the place of Voice in adjectival passives, a point for which we will need a bit more background on the different readings associated with these constructions. It has by now become standard to assume that adjectival passives which entail prior events are compatible with at least some Agents of these events. The main insights are as follows.

Adjectives can be distinguished according to whether they describe a stative characteristic of an entity or a state that has come about as the result of some previous event; this is the stative/resultative distinction from Embick (2004a), who presented the following diagnostics to distinguish between stative *open* and resultative *opened* by way of example.

- (21) Event-oriented adverbs: resultatives only for agent-oriented adverbs as in (a), disambiguated readings for other adverbs as in (b).
- a. *The package remained **carefully** ✗open/✓opened.*
  - b. *The **recently** open door.* [it was open recently]  
*The **recently** opened door.* [ambiguous: door was open recently or door was being opened recently]

5 *Passives and nominalizations*

- (22) Verbs of creation (statives only).  
*The door was {built/created/made} ✓open/✗opened.*
- (23) Secondary predicates (statives only).  
*Mary kicked the door ✓open/✗opened.*
- (24) Prefixation of *-un* (mostly resultatives).  
*✗unopen / ✓unopened*

In some cases the morphology indicates whether a certain form is stative or resultative: *open* and *molten* are stative, whereas *opened* and *melted* are resultative. In many cases, however, the form is ambiguous: *closed*, *fractured* and so on. The tests above distinguish “simple” adjectives from adjectives embedding an event. In Embick’s analysis, the former are derived by adjectivizing a root, and the latter by adjectivizing an event (vP/VoiceP). Embick’s resultatives thus fold in both “target state” and “result state” adjectival passives, a semantic distinction which can be diagnosed by whether the adjectival passive can be modified by ‘still’ (Kratzer 2000; Alexiadou et al. 2014).

Work since has investigated the kind of modifiers that can be attached to an adjectival passive (Meltzer-Asscher 2011; McIntyre 2013; Alexiadou et al. 2014; Bruening 2014; Gehrke & Marco 2014). At least the following constructions are available for (resultative) adjectival passives in English, German, Hebrew and Spanish. Agent implication is not possible:

- (25) a. The door is *opened*, but no one has opened it.  
 b. \* German (Alexiadou et al. 2014: 124)  
 Die Münze ist schon lange *versunken* \*aber keiner hat sie je  
 the coin is already long sunk.Adj but nobody has she ever  
 versenkt  
 sunk.PASS.PTCP  
 ‘The coin has been sunk for a while, but nobody has sunk it.’

*By*-phrases are possible only if their modification of the Agent, and therefore of the event, is discernible by examining the end state. One can tell that an editor did good work but not that the editor was bored:

- (26) ha-sefer *arux* al-jedej orex {✓*metsujan* / ✗*mefoamam*}.  
 the-book edited.Adj by editor excellent bored  
 ‘The book was edited by an excellent/\*bored editor.’ (Meltzer-Asscher 2011: 823)

Similarly, instruments are possible only if their modification of the event can be discerned by examining the end state. The writing of a blue pencil is distinguished from that of other pencils but the writing of a pretty pencil is not (though cf. McIntyre 2013 and Bruening 2014):

- (27) ha-mixtav *katuv*      be-iparon { ✓*kaxol* / ✗*jafe* }.  
 the-letter written.Adj in-pencil      blue      pretty  
 ‘The letter was written with a blue/\*pretty pencil.’ (Meltzer-Asscher 2011: 825, attributed to Julia Horvath)

The exact syntactic structure is a matter discussed from a crosslinguistic perspective by Alexiadou et al. (2014; 2015) based on fine differences between English and Greek. What I take from their discussion and the existing literature are the basic structures in (28), which are intended to be uncontroversial:

- (28) a. Adjective (stative): [ $\sqrt{\text{Root}}$  a]  
 b. Adjectival passive (resultative): [[a [Voice [ $\sqrt{\text{Root}}$  v]]]]

I will not commit to a specific semantics for adjectives or adjectival passives, on any reading, but one could begin from the semantics of a resultant state adjective proposed by Kratzer (2000):

- (29)  $[[\text{Adj}]] = \lambda R \lambda t \exists e, y. R(e)(y) \ \& \ \tau(e) \leq t$

### 5.2.2 Descriptive generalizations

This section goes through a few of the established diagnostics in Hebrew. Adjectival passives appear in one of the two passive participial forms *meXuYaZ* and *muXYaZ* (participles of *XuYaZ* and *huXYaZ* respectively), or in the *XaYuZ* form associated with *XaYaZ*.

Hebrew participles serve as present tense verbal forms and as Romance-style participles, by which I mean a mixed nominal-adjectival category. The Hebrew participle is, in general, ambiguous in form between a verb and an adjective or noun (Boneh 2013; Doron 2013). In *XaYaZ* the active participle can be either a verb or a noun. In other templates (and in the *XaYuZ* passive participle) an adjectival reading is also available, as with *metsujan* ‘excellent’ in (30b).

- (30) a. ha-felet *more*      al ha-derex la-park.  
 the-sign indicates.PTCP.SMPL on the-road to.the-park  
 ‘The sign is indicating the way to the park.’

5 *Passives and nominalizations*

- b. *josi more metsujan.*  
 Yossi teacher.PTCP.SMPL excellent.INTNS.PASS.PRS  
 ‘Yossi is an excellent teacher.’

The forms *meXuYaZ* and *muXYaZ* are ambiguous between a verbal form and an adjectival form, just like English *closed* is. Doron (2000) establishes ten diagnostics distinguishing verbal passives from adjectival passives (in fact, many of them distinguish verbs from adjectives in general). Here I give a few examples of what these differences look like. Importantly, only bounded events (change-of-state and inchoatives) can serve as input to adjectival passives (which are resultative).

In active forms, the finite verb often contrasts with a combination of copula and participle. Consider future verbs (31a) and future participles (31b).

- (31) a. Future verb:  
*maxar ani {oxal / akli}.*  
 tomorrow I will.eat.SMPL will.record.CAUS  
 ‘Tomorrow I’ll eat/record something.’
- b. # Future copula with a participle:  
*maxar ani eheje {oxél / makli}.*  
 tomorrow I will.be.SMPL eat.SMPL.PRS record.SMPL.CAUS  
 (int. ‘Tomorrow I will be eating/recording.’)

Doron (2000) shows that *verbs are not allowed after a copula*, so the forms in (31b) must be adjectives or nominals. They can be used when the participle is used in a generic context as a noun, as in “eater of vermin” (32a) or “recorder of things” (32b). This is to be expected if the complement of the copula in (32) is a participle.

- (32) a. Participle of *XaYaZ*:  
*az ta-gid-i, fe-rak ani eheje oxél fratsim ve-ʃar*  
 so 2.FUT-say-F COMP-only I will.be eat.SMPL.PRS vermin and-rest  
*mini basar ha-ʻasurin al jehudim? ;-)*  
 kinds.of meat the-proscribed on Jews  
 ‘So say so! What, you want me to be the only one here who eats vermin and other kinds of meat that are proscribed for Jews? ;-)’<sup>2</sup>

<sup>2</sup><http://www.tapuz.co.il/forums2008/archive.aspx?ForumId=1277&MessageId=96791273> (retrieved November 2014). The example appears in a forum conversation in which participants discuss their experiences eating shrimp in Norway. *fratsim* ‘vermin’ is a common term for non-Kosher foods such as seafood. The adjective *asurin* ‘proscribed’ is written in an intentionally jocular/archaic way, with a final *-n* that has changed to *-m* in the modern language.



b. Participle of *heXYiZ*:

kanir'e je-ani **eheje maklit** kavua fel ze.  
 probably COMP-I will.be record.CAUS.PRS constant of this

'Looks like I'll be the one recording this', 'Looks like I'll be a constant recorder of this.' <http://www.forumtvnetil.com/index.php?showtopic=18312>

It is thus possible to distinguish verbal passives from adjectival passives in Hebrew, and to tease apart different readings of the participle. Recall that for English, Embick (2004a) demonstrated that if the door is *closed*, it could have been built closed (adjectival passive, stative) or been closed from an open state (verbal passive, eventive). The same logic holds for verbs like *record* and *cover* in Hebrew. The implied present tense in (33a) is ambiguous between a verbal (progressive) reading and an adjectival (stative) reading. However, in Hebrew the future copula diagnoses an adjectival passive form (Doron 2000). Accordingly, the future tense in (33b) is unambiguously adjectival (Doron 2000; Horvath & Siloni 2008; Meltzer-Asscher 2011).

- (33) a. ha-kontsert *muklat*.  
 the-concert record.CAUS.PASS.PRS  
 'The concert is being recorded.'  
 'The concert has been recorded.'
- b. ha-kontsert *jihie muklat*.  
 the-concert will.be.SMPL record.CAUS.PASS.PRS  
 'The concert will have (already) been recorded.'
- (34) a. ha-sir *mexuse*.  
 the-pot cover.INTNS.PASS.PRS  
 'Someone is covering the pot.' (verbal)  
 'The pot is covered.' (adjectival)
- b. ha-sir *jihie mexuse*.  
 the-pot will.be.SMPL cover.INTNS.PASS.PRS  
 'The pot will be covered.' (adjectival only)

Two additional differences between verbal and adjectival passives have been mentioned in the literature (Horvath & Siloni 2008; 2009; Meltzer-Asscher 2011; Kastner & Zu 2017). First, whereas the adjectival forms may have an *idiomatic reading* (35a), passive verbs (35b) are always compositional.





## 5 Passives and nominalizations

- (40) a. *barur* ‘clear’ (XaYuZ)    b. *katan* ‘small’ (XaYaZ)    c. *famen* ‘fat’ (XaYeZ)

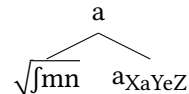
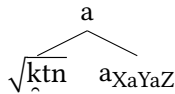
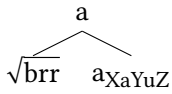

Two of these patterns are homophonous with the present-tense (participle) verbal passives *meXuYaZ* and *muXYaZ*. Therefore, I am forced to assume the existence of two separate adjectival heads, namely  $a_{\text{INTNS}}$  and  $a_{\text{CAUS}}$ , alongside any other possible patterns, just like English shows evidence of adjectival *-ed* (*wingéd*, *learnéd*) alongside verbal *-ed*. A given root typically has one basic adjectival form like the ones in (40). So an adjective might appear in this form or in the participial-like forms, with either subtle (41a–b) or substantial (42a–b) differences in meaning.

- (41) a. *kaur* ‘ugly’ (XaYuZ)    b. *mexoar* ‘ugly’

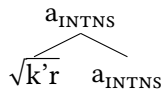
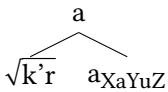

- (42) a. *parua* ‘wild’ (XaYuZ)    b. *mufra* ‘deranged’

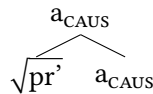
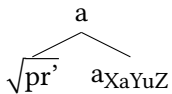

An alternative would be to assume that even these stative adjectives have underlying verbal structure, except that this structure is not interpreted. This approach is reminiscent of the inchoatives and the Greek facts mentioned in Section 3.3.2. Perhaps in the Hebrew cases above there is only one adjectivizing head  $a$ , which takes a verbal structure that is not interpreted. I do not have particular reason to support one view or the other, and so I stick to the analyses in (41–42) simply because they involve less structure. The same point can be made for complex event nominals in the next section. Note, however, that this alternative should then extend to English cases such as (39b): what is to stop us from assuming underlying verbal structure in *closed* which is simply not interpreted before being adjectivized by *-ed*?

### 5.2.3.2 Adjectival passives

The difference between stative adjectives and adjectival passives is that the latter embed VoiceP. The internal argument of adjectival passives has been argued by

Bruening (2014: 386) to be an Operator, bound by the noun interpreted as the argument. Implementing this for Hebrew gives us structures like the following (where the exact nature of the copula is irrelevant). Like with stem vowels in verbs, I assume that the stem vowels originate on Voice and are conditioned by the embedding *a* head.

(43) Adjectival passive in *XaYuZ* (from *XaYaZ*):

- a. *ha-sefer jihie katuv be-et kaxol.*  
 the-book will.be.SMPL written in-pen blue  
 ‘The book will be (will have been) written in blue ink.’

b.

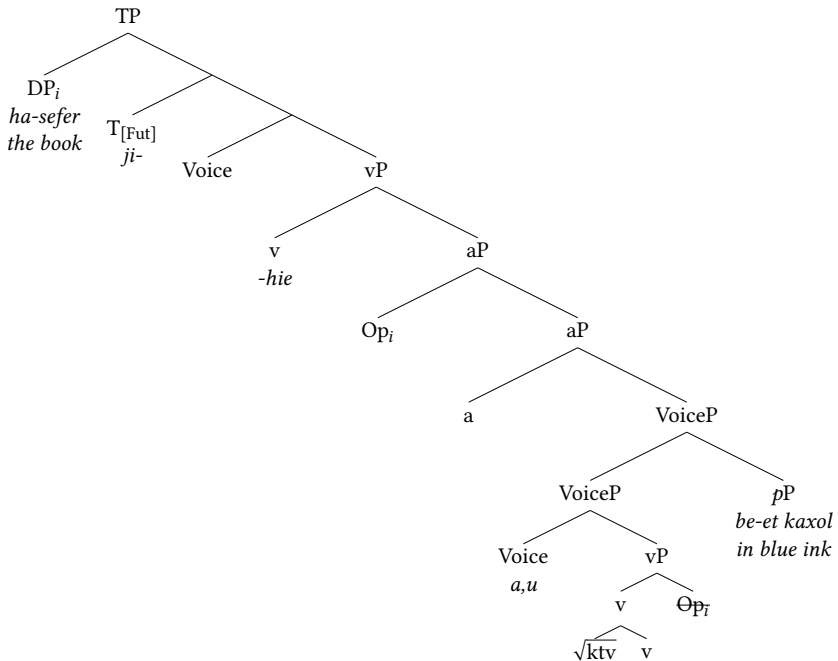

(44) Adjectival passive in *meXuYaZ* (from *XiYeZ*):

- a. *dani jihie mesorak.*  
 Danny will.be.SMPL combed.INTNS.PASS.PRS  
 ‘Danny will be combed (already).’

b.

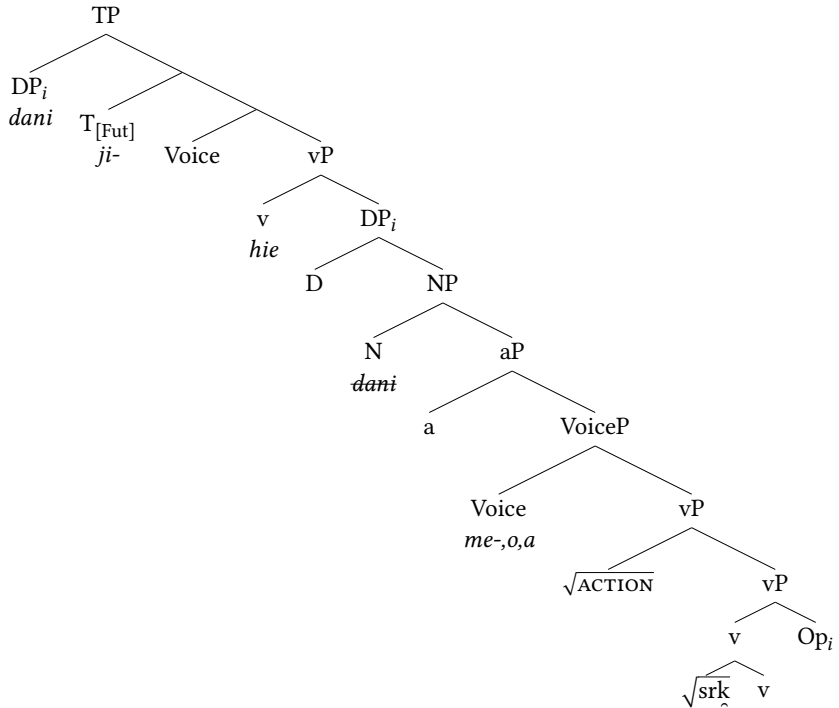

The derivations in this section are similar to the ones in Doron (2014), though I depart from her specific implementation for a number of reasons. First – as already discussed in previous chapters – the functional heads used by Doron are semantic primitives which drive the semantics but do not translate straightforwardly into the morphophonology as syntactic heads usually do, nor is their exact syntactic job clear. Additionally, and more specifically to adjectival passives, Doron (2014) utilizes an active Voice head introducing the EA-related head *v*, which in turn introduces the external argument. In order to produce a verb in active voice, then, her system needs a lower head that requires Active Voice – this is CAUS – so that CAUS introduces Active Voice, Active Voice introduces *v*, and *v* introduces the external argument. Some of these heads split up the semantic work that can be done by one head (Voice and *v* in particular), and not all of them have overt spell-out. There are consequently more syntactic elements than seems necessary.

## 5.2.3.3 Templates

In terms of the combinatorics involved with different VoicePs in Hebrew, the picture is similar to that of verbal passives except that row a in Table 5.6 is possible.

Table 5.6: Combinations of little *a* and VoiceP

|    |   |                       |                        | Attested?      |
|----|---|-----------------------|------------------------|----------------|
| a. | a | Voice                 |                        | <i>XaYuZ</i>   |
| b. | a | Voice                 | $\sqrt{\text{ACTION}}$ | <i>meXuYaZ</i> |
| c. | a | Voice <sub>[-D]</sub> |                        | <b>X</b>       |
| d. | a | Voice <sub>[-D]</sub> | $\sqrt{\text{ACTION}}$ | <b>X</b>       |
| e. | a | Voice <sub>[+D]</sub> |                        | <i>muXYaZ</i>  |

Voice<sub>[-D]</sub> is incompatible with adjectival passives. Informally, adjectival passives denote the result of an event without explicitly naming the cause, though one is assumed; in this sense they are similar to verbal passives. Alexiadou et al. (2014) and Bruening (2014) implement this by allowing Adj (and Pass) to only select for Voice that needs to fill its specifier. Voice<sub>[-D]</sub> is not such a Voice head (although Embick 2004a does allow his non-active Voice to derive unaccusative adjectival passives in English): since there is no expectation of an external argument, there is no adjectival passive.

What remains is to see what special interactions arise from the combination of other [D] values (or  $\sqrt{\text{ACTION}}$ ) with little *a*. First, recall the claim in Doron (2000) that change-of-state roots are better inputs to adjectival passives than atelic events. All three templatic forms are compatible with both stative adjectives and adjectival passives, as already mentioned. Doron (2014: 170) shows that STATIVE ADJECTIVES are incompatible with event modifications or event readings. Some of them even have no corresponding underlying verb:

- (45) a. ti'un      *barur* (\*bekfida)  
           argument clear    carefully  
           'A clear argument'
- b. beged    *mexoar* (\*beriful)  
           garment ugly.INTNS    carelessly  
           'An ugly garment'

## 5 Passives and nominalizations

- c. pîrxax *mufra* (\*bexipazon)  
 brat deranged.CAUS hastily  
 ‘A deranged brat’

And while all three *adjectival passive* forms are *compatible* with external arguments, Doron (2014: 175) observes that (resultative) adjectival passives in “causative” *muXYaZ* require an implied Causer to be interpreted, even if it is implicit and not overtly represented. So, while an adjectival passive in *meXuY<sub>2</sub>aZ* does not entail the existence of a Causer, (46a), every adjectival passive in *muXYaZ* does, (46b). In a telling near-minimal pair, the athletes in (46a) might have trained on their own, but the athletes in (46b) must have been trained through some kind of organized program.

- (46) a. sportaim *meuman-im* bekfida (*meXuY<sub>2</sub>aZ*)  
 athletes trained.INTNS.PASS-PL carefully  
 ‘Carefully trained athletes’
- b. sportaim *muxfar-im* bekfida (*muXYaZ*)  
 athletes prepared.CAUS.PASS-PL carefully  
 ‘Carefully trained athletes’

Doron (2014) attributes this difference to the behavior of the causative head CAUS which for her underlies *heXYiZ*. My analysis, using Voice<sub>[+D]</sub>, follows in the same vein. Note that the implied EA is not syntactically represented; it cannot, for example, create a new discourse referent.

- (47) \* *nadia komanetji haj-ta* sportait (EA<sub>i</sub>) *muxfer-et*  
 Nadia Comănesci was.SMPL-F athlete.F prepared.CAUS.PASS-F  
 bekfida. **hu<sub>i</sub>** asa avoda tova aval safag harbe bikoret  
 carefully he did.SMPL job good but absorbed.SMPL much criticism  
 (int. ‘Nadia Comănesci was a carefully trained athlete. He (=Béla Károlyi) did a good job but was heavily criticized.’)

I conclude with additional observations by template, collected here for completeness, and drawing heavily on Doron (2000) as well as Doron (2014) and Meltzer-Asscher (2011).

### 5.2.3.3.1 *XaYaZ* (adjectival form *XaYuZ*)

No verbal passive exists for *XaYaZ* but stative and resultative adjectives are both possible.



Doron (2000) argues that only change of state roots are possible inputs to adjectives in this template. For example, the unattested form *\*karu/\*karuj* (int. ‘read’) does not exist as a stative adjective or as an adjectival passive:

- (48) ha-mixtav **katuv** / **\*karuj**.  
 the-letter written read  
 ‘The letter is written (\*is read).’

For those roots that can form adjectives, the main difference is between roots that derive intransitive verbs in *XaYaZ* and those that derive transitive verbs. The former lead to stative adjectives and the latter to adjectival passives (see Meltzer-Asscher 2011 for a lexicalist account).

- (49) a. Stative adjectives from intransitives: *kafu* ‘frozen’ < *kafa* ‘froze’; *davuk* ‘glued’ < *davak* ‘stuck to’.  
 b. Adjectival passives are possible with change of state roots: *favur* ‘broken’ < *favar* ‘broke’; *sagur* ‘closed’ < *sagar* ‘closed’; *saruf* ‘burnt’ < *saraf* ‘burned’.  
 c. Stative adjectives with no corresponding verb in *XaYaZ*: *pafut* ‘simple’, *savux* ‘complex’, *pazur* ‘scatterd’, *saluv* ‘intertwined’, *akum* ‘crooked’, *tarud* ‘preoccupied’.

The roots underlying (49c) do not appear as verbs in *XaYaZ*, meaning that they cannot combine with *v* and Voice. If this is the case, they cannot form the underlying VoiceP necessary for an adjectival passive and are only possible as input to stative adjectives. For the roots in (49a), their corresponding *XaYaZ* verbs are intransitive. This means that the interpretation of [Voice [v  $\sqrt{\text{dbk}}$ ]], for example, is unaccusative. If this is the case, then an implicit Agent cannot be licensed.

#### 5.2.3.3.2 *XiYeZ* (adjectival form *meXuYaZ*)

This template can serve as input to both verbal and adjectival passives. Laks & Cohen (2016) argue (and provide experimental evidence for the claim) that the middle stem vowel might be pronounced differently for verbs and adjectives, further supporting the split between the two (one that can be encoded regardless of theoretical framework).

Among the adjectives, there are two kinds of stative adjectives: those that do not have a corresponding verb, (50a), and those that are homophonous with an adjectival passive like English *closed* is, as it can be stative or resultative, (50b).

## 5 Passives and nominalizations

- (50) a. No corresponding verb: *megufam* ‘clumsy’ (↯ \**gifem*), *meunax* ‘vertical’ (↯ \**inex*), *memufma* ‘disciplined’ (↯ \**mifmea*), *metupaf* ‘silly’ (↯ \**tipef*).
- b. Ambiguous between resultative and stative: *megune* ‘obscene’, *mekubal* ‘accepted’, *mefuzar* ‘scattered’, *meluxlax* ‘dirty’, *megulgal* ‘rolled up’, *mekulkal* ‘out of order’.

The verbs underlying (50b), and any which do not fall under (50a), can form adjectival passives. For the forms in (50b), the stative reading is more salient and is often different than the compositional adjectival passive reading. For instance, the adjectival passive *megune* ‘obscene’ literally means ‘that which has been censured’.

### 5.2.3.3.3 *heXYiZ* (adjectival form *muXYaZ*)

This template can serve as input to both verbal and adjectival passives.

Stative adjectives are only possible from roots that do not have a corresponding verb in *heXYiZ*, (51a). A form ambiguous with a resultative might also exist, in which case its meaning is different, as with *muflam* ‘perfect (stative adj.)’/‘that which has been completed (adj. pass)’.

- (51) a. No corresponding verb: *muda* ‘aware’, *muflag* ‘snowy’, *mugaz* ‘carbonated’.
- b. Ambiguous between resultative and stative: *muflam* ‘perfect’, *muffat* ‘abstract’.

As an innovation, a verb might be back-formed based on adjectives like those in (51a) or derived from the related noun. For example, the substandard verb *heflig* ‘snowed’ is attested in the poet Bialik’s work and can be found in use online.

Adjectival passives are available for all roots that have verbs in *heXYiZ*. As discussed above, these constructions entail an implied EA.

## 5.2.4 Summary of adjectival passives

I have now accounted for the existing generalizations regarding what kind of passive (verbal or adjectival) and what kind of adjective (stative or resultative) can appear with what kind of root in each of the templates. The summary in Table 5.7 concludes this section.

Table 5.7: The head little *a* in different configurations

|                     | Interpretation | Heads/structure                                                     | EA? | Form           | (template)        |
|---------------------|----------------|---------------------------------------------------------------------|-----|----------------|-------------------|
| Adjectives          | stative        | $[\sqrt{\text{root}} a_{\text{SMPL}}]$                              | ✗   | <i>XaYuZ</i>   | ( <i>XaYaZ</i> )  |
|                     |                | $[\sqrt{\text{root}} a_{\text{INTNS}}]$                             | ✗   | <i>meXuYaZ</i> | ( <i>XiYeZ</i> )  |
|                     |                | $[\sqrt{\text{root}} a_{\text{CAUS}}]$                              | ✗   | <i>muXYaZ</i>  | ( <i>heXYiZ</i> ) |
| Adjectival passives | resultative    | $[a [\text{Voice} [\sqrt{\text{root}} v]]]$                         | ✓/✗ | <i>XaYuZ</i>   | ( <i>XaYaZ</i> )  |
|                     |                | $[a [\text{Voice} [\sqrt{\text{ACTION}} [\sqrt{\text{root}} v]]]]]$ | ✓/✗ | <i>meXuYaZ</i> | ( <i>XiYeZ</i> )  |
|                     |                | $[a [\text{Voice}_{[+D]} [\sqrt{\text{root}} v]]]$                  | ✓   | <i>muXYaZ</i>  | ( <i>heXYiZ</i> ) |

## 5 Passives and nominalizations

The analysis of Hebrew provides further evidence for an eventive layer in adjectival passives. Hebrew also supports the claim that the same morphophonological form can spell out both stative and adjectival passives.

Finally, it is worth pointing out that the adjectival passive is still productive, especially since passives have been characterized as no longer productive in Hebrew, a claim that seems too strong for adjectival passive novel forms such as *meturgat* ‘targeted’:

- (52) “For whatever reason, after years of complete openness with Google, and full access to all of the data and information that I produce, it looks like the only thing they know about [me] is that I’m a man. Enough already! I’m tired of ads for shaving, cars, insurance and cologne! ...”
- ex ani *jaxol*                      ligrom le-gugel latet l-i pirsom-ot  
how I    can.PTCP.SMPL to.cause to-Google to.give to-me ad-F.PL  
je-beemet    **meturgat-ot**                                              el-aj?!
- COMP-really targeted.INTNS.PASS.PRS-F.PL to-me
- ‘How can I get Google to give me ads that are really targeted at me?’
- <http://www.facebook.com/elad.lerner/posts/1207164259295353>

### 5.3 Nominalization

This section addresses the deverbal nominalization in Hebrew, also known as *gerund*, *gerundive*, *action noun* and *masdar*. The claim I am building up to will be similar to that made for adjectival passives in Section 5.2: nominal forms can arise in two ways. One is by nominalizing a root using a nominalizer with a specific morphophonological form, which may or may not be similar to that of eventive nominalizations. The other is by nominalization of an existing verbal form (a VoiceP), in which case the nominalizer is little *n* and the result is a nominal with internal verbal structure.

#### 5.3.1 Background

To start, we need to recap some basic observations and proposals from the general literature. It has famously been proposed (Grimshaw 1990) that three different kinds of NOMINALIZATIONS exist, (53). Much of the literature is devoted to discussing whether these classes really are mutually exclusive and what the best way to diagnose membership in one class or the other is (Alexiadou 2001; 2009; 2010; 2017; Borer 2013; 2014a). This question is inherently tied to formal proposals for how these classes might differ (Chomsky 1970; Marantz 1997; Harley 2009; Bruening 2013; Wood 2019).

- (53) a. SIMPLE NOMINALS appear monomorphemic.  
 b. RESULT NOMINALS are nominalizations without argument structure whose semantics does carry the implication – if not entailment – of a completed event. They usually appear polymorphemic and are often homophonous with a CEN (seen next).  
 c. COMPLEX EVENT NOMINALIZATIONS are nominalizations of verbal forms. They have internal argument structure.

Whether or not result nominals are a distinct class has been debated. I will not enter that debate here, referring the reader instead to Ahdout (2019; in prep) for an in-depth investigation of nominalizations in Hebrew (including some striking findings for result nominals, such as their varying acceptability with different templates). I focus instead on the two simplest cases: uncontroversially simple nominals and uncontroversial CENs, treating purported result nominals as simple nominals for present purposes.

Simple nominals like *book* have no internal structure: there are no arguments to bookhood.

- (54) The enemy's book (\*of the city) (\*in less than a day)

CENs can be diagnosed in various ways, all converging on the conclusion that the noun contains a verb and its internal argument, together with possible modifiers.

- (55) The *destruction* \*(of the city) (in less than a day)

The meaning of a CEN is always transparently related to that of the underlying verb.

Two additional points of contention are the status of the implied external argument, and the internal structure of polymorphemic simple nominals. For the implicit external argument, views are converging on the conclusion that it is projected in the syntax (as *pro*) in the specifier of little *n*, although implementations still differ (Bruening 2013; Alexiadou et al. 2015). For nouns like *nominal-iz-ation*, *exam-in-ation* and perhaps even *trans-miss-ion*, some overt verbalizer seems to be embedded in a simple nominal. The issue is whether the noun does involve internal structure which is somehow defused, or whether these nouns are still derived directly from the root with some complex suffix (Alexiadou 2001; 2008; 2009; 2017; Borer 2014a; Moulton 2014; Wood 2019). To the extent that the Hebrew data is relevant, I lean towards a complex suffixation analysis, but cannot provide novel evidence that tells the two possibilities apart.

### 5.3.2 Descriptive generalizations

Most templates have dedicated nominal forms, given in Table 5.8. The exceptions are *XaYaZ*, which has a number (varying by root; Borer 2013; Ahdout in prep), and the passive templates *XuYaZ* and *huXYaZ*, which have no nominalizations of their own (Kastner & Zu 2017).

Table 5.8: Deverbal nouns in Hebrew

| Verbal form     | Derived nominal form |
|-----------------|----------------------|
| <i>XiYeZ</i>    | <i>XiYuZ</i>         |
| <i>heXYiZ</i>   | <i>haXYaZa</i>       |
| <i>niXYaZ</i>   | <i>hiXaYZut</i>      |
| <i>hitXaYeZ</i> | <i>hitXaYZut</i>     |

Hebrew CENs behave as would be expected, patterning like their English counterparts with regard to possible arguments and adverbs.

- (56) a. *ha-ojev hefmid et ha-ir (tox jom).*  
the-enemy destroyed.CAUS ACC the-city within day  
‘The enemy destroyed the city (in a day).’
- b. *hafmada-t ha-ojev et ha-ir (tox jom)*  
destruction.CAUS-of the-enemy ACC the-city within day  
‘The enemy’s destruction of the city (in a day)’
- (57) a. *ha-mitnadvim fikmu et ha-jaar (be-zrizut).*  
the-volunteers rehabilitated.INTNS ACC the-forest in-quickness  
‘The volunteers rehabilitated the forest (quickly).’
- b. *ha-fikum (ha-zariz) sel ha-jaar (al-jedej)*  
the-rehabilitation.INTNS the-quick of the-forst by  
ha-mitnadvim)  
the-volunteers  
‘The (quick) rehabilitation of the forest (by the volunteers)’

### 5.3.3 The head n in Hebrew

Simple nouns exist in various patterns in Hebrew. I assume that these patterns spell out variants of the nominalizer little n; there are potentially dozens of these.

Assuming a decomposition into root and nominalizer, example structures for simple nouns are as follows:

- (58) a. *kelev* ‘dog’                      b. *telefon* ‘phone’
- 
- The diagram shows two morphological trees. Tree (a) for 'kelev' has a root node 'n' branching into a radical  $\sqrt{\text{klb}}$  and a nominalizer  $n_{XeYeZ}$ . Tree (b) for 'telefon' has a root node 'n' branching into a radical  $\sqrt{\text{tfn}}$  and a nominalizer  $n_{XeYeZoW}$ .

To derive a CEN, in Hebrew as in other languages, we simply add little *n* above an existing VoiceP structure (Hazout 1995; Engelhardt 2000). Since my main interest is in the morphology and how it reflects the syntax and semantics, I do not engage with questions such as where the arguments are generated (as full DPs within vP, or base-generated as an operator with the full DP adjoined to the noun, like for internal arguments of adjectival passives).<sup>4</sup>

- (59) *hafmada* ‘destruction’

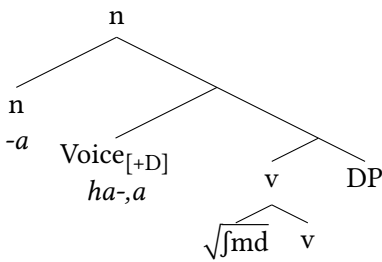

It seems reasonable to assume that the nominalizer is spelled out as (the feminine singular) *-a* while conditioning allomorphy of the vowels on Voice<sub>[+D]</sub>, but I do not develop a detailed morphophonological analysis here. Most of what has been said about verbs should carry over to nouns as well.

It is well-known that some forms are ambiguous between a simple and a CEN reading; English *transmission* and *examination* are famous examples, or Hebrew *kibuts*, which can mean either ‘gathering’ (CEN) or a kibbutz (simple noun). The analysis I have sketched here ends up saying that in Hebrew, the form is ambiguous between a CEN of the verb *kibets* ‘gathered’, (60a), and a noun derived directly from the root, (60b).

<sup>4</sup>The nominalizer *n* might attach even higher for some constructions e.g. [*n* TP] (Alexiadou 2017). I do not explore larger structures like that one here; see Wood (2020) for a recent review and synthesis of the question, Kastner (2015) on nominalization of entire clauses in Hebrew, and Kastner & Zu (2017) on the incompatibility of *n* with Pass in Hebrew.

5 *Passives and nominalizations*

- (60) a. medina-t israel *tihie* ptuxa le-alia jehudit  
state-of Israel will.be.SMPL open to-immigration Jewish  
ve-le-kibuts galujot  
and-to-gathering.INTNS.of diasporas  
‘The State of Israel will be open for Jewish immigration and for the  
Ingathering of the Exiles.’ (Israeli Declaration of Independence)

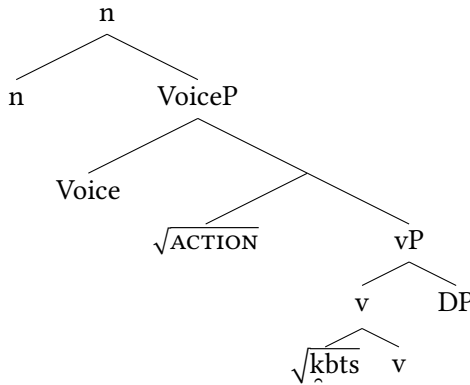

- b. “According to his testimony, in the early 60s, before he began his  
political career in the USA, ...  
*jaha* sanderz kama xoda<sup>5</sup>im be-israel  
stayed.SMPL Sanders a.few months in-Israel  
ve-*hitnadev* be-kibuts  
and-volunteered.INTNS.MID in-kibbutz  
...Sanders stayed in Israel for a few months and volunteered in a  
Kibbutz.”<sup>5</sup>

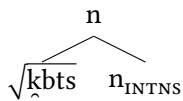

This view fits with the original argument for roots within a syntactic approach to Semitic morphology as put forward by Arad (2003), who showed how nouns may be derived either from roots or from existing nouns. In the context of the Trivalent proposal, verbal templates are special: each functional head in the verbal domain has deterministic spell-out, modulo contextual allomorphy. In contrast, nouns and adjectives can be derived using a range of nominal patterns, perhaps because there is nothing to signal about their argument structure. This much seems to be supported by the data: while there are five active verbal templates, there are dozens of nominal patterns (especially if we wish to assume

<sup>5</sup><https://goo.gl/GzqQUQ> (retrieved April 2016).



that a loanword like *entsiklopedja* ‘encyclopedia’ instantiates the one-off pattern *CeCCiCCoCeCCa*.

Another consideration points towards this conclusion (Kastner 2019b): a simple noun might not even have any corresponding action nominal if there is no underlying verb. The noun *kibuf* ‘occupation’ is not derived from an underlying verb in *XiYeZ*, meaning that the morphophonological nominal pattern INTNS must exist independently of a verb with similar morphology.

- (61) a. *daj la-kibuf!*  
           enough to.the-occupation  
           ‘Down with the occupation!’  
       b. \* *kibef*

What the Hebrew data do show, however, is that CENs contain a Voice layer because the Voice-level morphology is overt. This point is consistent with existing analyses of embedded Voice in CENs, many of which are agnostic regarding whether Voice is or is not embedded under *n* in languages where Voice is covert (Alexiadou 2017; Wood 2019).

Few differences between templates have been noticed, having to do with variation within *XaYaZ* (Borer 2013) and a gap in *niXYaZ* (Siloni & Preminger 2009; Ahdout & Kastner 2019); again, see Ahdout (2019; in prep) for some proposed distinctions. Further discussion of the nominal system is beyond the scope of this book, but see for instance Faust & Hever (2010) and Laks (2015). Borer (2013: 534fn13, 555) outlines a theory in which template-specific nominalizers merge above templatic verbalizers. The meanings of these nominal forms are similar to those of the underlying verbs, but they need not be. In that system a noun derived from a verb can still have different meaning than the verb; the Trivalent system adheres to a stricter view of locality which forces a proliferation of morphophonological patterns. But if every noun that looks like a potential (verbal) CEN is derived from a verbal form, the Exo-Skeletal model needs to admit an underlying verb-like piece which might not otherwise exist, like (61b).

## 5.4 Conclusion

This chapter analyzed cases in which the existing structures presented in the previous three chapters are embedded under the passive, adjectival and nominal heads that have been proposed elsewhere in the literature. The architectural bottom line is that a VoiceP can serve as the input to further derivation. If Pass, little *a* or little *n* are merged above it, the result is entirely predictable: a passive verb,

an adjectival passive or a CEN. Adjectives and nominalizations have forced us to make the theory slightly weaker in that there exist independent adjectivizers and nominalizers which look like the existing templates. For example, we have seen evidence for a nominalizer  $n_{\text{INTNS}}$  which has the same output as nominalizing an existing verb, [n XiYeZ]. All templates have such analogous simple nominalizations. This result seems to be a necessary evil on the morphophonological side, leading to predictable results on the syntactic-semantic side. But nominalizations and adjectivizations of the root do not have internal verbal structure (contra a strong reading of “verb equivalence” in Borer 2013: 544) and might carry different meaning than that of the homophonous complex form derived from the verb.

This all seems like a welcome result, since we would not expect Hebrew to be radically different in terms of architecture than any other language. The fact that different functional heads can be merged with predictable results once the basic verb has been built, and that these derivational processes appear to be essentially identical in Hebrew and in other languages, is a strong argument in favor of the general approach. See Ahdout (in prep) for related explorations of the nominal system.

Before concluding, one last word ought to be said about DENOMINAL VERBS, i.e. verbs derived from underlying nouns. In these cases a verb seems to be derived from another word instead of the root (Bat-El 1994; Ussishkin 1999; 2005; Arad 2003). In Hebrew, this phenomenon is evident in that the verb carries along affixal material that was attached to the “base” noun before it was verbalized, as in (62). The boldfaced affixes arguably attach only to nouns, making their appearance in the corresponding verb inexplicable unless the verb is itself denominal.

(62) Denominal verbs contain nominal affixes:

- a. *kamts-an*, ‘stingy person’ → *hitkamtsen*, ‘was stingy’
- b. *kits-on-i*, ‘extreme’ → *hektsin*, ‘brought to extremity’
- c. *ta-xzuk-a*, ‘maintenance’ → *tixzek*, ‘maintained’
- d. *mi-spar*, ‘number’ → *misper*, ‘enumerated’

As Arad (2003) points out, these denominal verbs have compositional semantics insofar as they have predictable meanings when compared to their underlying nouns. Kastner & Tucker (submitted) point out how Arad noticed that these facts indicate a derivational “point of no return” for non-concatenative morphology, based on cyclic spell-out.<sup>6</sup>

---

<sup>6</sup>Omer Preminger (p.c.) points out the pair *izker* ‘commemorated, mentioned’ and *azkara* ‘memorial service’, where the noun seems to have a meaning that the underlying verb does

A substantial body of work considers denominal verbs to pose a problem for root-centric views of Semitic morphology such as the current one. Bat-El (1994; 2003; 2017) suggests a denominal derivation for these verbs, one which is not possible in theories in which verbs can only be derived from roots. The argument is that some word-formation processes in Hebrew need to be analyzed in terms which allow word-like inputs to subsequent word formation, and hence all word formation is based on words (or stems) and not roots. Yet there are two problems with this view. First, no word-based analysis has shown that a root-based analysis is unable to capture the same patterns when allowing word-based derivation as well, whereas root-based analyses have been able to show the inadequacy of word-based analyses (Kastner 2019b). The second issue is even more general. As much work has already argued (Arad 2003; 2005; Doron 2003), and as we have just seen in this chapter, this kind of objection is fundamentally misdirected. The syntactic approach inherent in DM accounts of Hebrew (not just the Trivalent one) obviates much of the debate on whether word-formation in the language is “root-based” or “word-based” because DM accounts have as a matter of theoretical hypothesis the notion that word-formation takes as input whatever the syntax can generate (Kastner & Tucker submitted). We have seen in this chapter that the syntax can passivize, nominalize or adjectivize complex constituents regardless of the language. Taking this as a given, it is not surprising that denominal verbs show morphophonological and morphosyntactic properties that suggest that they are derived from an underlying verb – these are precisely the sorts of effects that one would expect in a syntactic approach to word-building.

With this conclusion, according to which Hebrew is not all that different from other languages after all, we turn to Part II of the book: general crosslinguistic considerations.

---

not. Setting aside the question of whether a memorial service counts as a commemoration, this case is especially interesting because the verb is quadrilateral (Schwarzwald 2016). Could it be that a quadrilateral root  $\sqrt{zkr}$  was innovated and then used for the other form, i.e. the noun and verb have different derivational histories? Checking the database, I found 24 verbs in *iXYeZ* that are plausibly derived from nouns. Perhaps back-formation from nouns is deriving new quadrilateral roots, or vice versa:

- (i) a. *ixles* ‘populated’ < *uxlusija* ‘population’, *ifjen* ‘characterized’ < *ofen* ‘facet’, *irgen* ‘organized’ < *irgun* ‘organization’
- b. *ifpez* ‘hospitalized’  $\overset{?}{>}$  *ifpuz* ‘hospitalization’, *ifrer* ‘ratified’  $\overset{?}{>}$  *ifrur* ‘ratification’, *itxel* ‘rebooted’  $\overset{?}{>}$  *itxul* ‘reboot’.

In all of these cases except for *izker* the Arad-style generalization holds. Whether these *a*-nouns and *i*-verbs have different structure than in the original *m*-nouns and regular verbs discussed by Arad (2003) is an interesting question for future work. See also Ouhalla (2016) for a different line of argumentation and Brice (2016) for experimental evidence supporting root embedding.



## **Part II**

# **Crosslinguistic consequences**



# 6 Syntactic vs. semantic transitivity

## 6.1 Introduction

The first part of this book developed a theory of Voice which recognizes three possible values: Voice<sub>[+D]</sub>, Voice<sub>[-D]</sub> and Unspecified Voice. We have seen that the syntactic features of Voice are correlated with semantic interpretation in ways which themselves are informative: Voice<sub>[+D]</sub> introduces a thematic external argument, although this requirement can be voided in de-adjectival and de-verbal inchoatives, indicating that the semantics is still sensitive to syntactic structure (Chapter 4); Voice<sub>[-D]</sub> does not introduce a syntactic external argument, but it can trigger existential closure over an Agent, and  $p_{[-D]}$  does introduce a Figure role, indicating that the thematic interpretation is sensitive to the extended verbal projection (Chapter 3); and Voice places no requirements either in the syntax or in the semantics, although the two are once again correlated (Chapter 2).

The Trivalent Theory assumes that every verbal projection contains Voice. In this chapter I would like to highlight some differences between this theory and the one most closely related to it, which I will call for simplicity the LAYERING approach (Schäfer 2008; Alexiadou et al. 2015). I discuss the two basic premises behind Layering in Section 6.2, and show how they are manifested in the current theory and how they are different in Section 6.3. The differences will pattern as follows: everything that can be expressed using Layering can be expressed in the current approach, but causative alternations are beyond the purview of Layering and require a Trivalent system. In addition, a number of necessary stipulations are arguably less stipulative in the Trivalent Theory. Sections 6.4 and 6.5 verify that Layering cannot be applied to the Hebrew data. This comparison between theories sets up expectations for additional crosslinguistic study, which I turn to in the Conclusion (Section 6.6) and in the next chapter.

## 6.2 Layering

Many recent syntax-based theories of argument structure adopt two central assumptions which have been most notably defended in the work of Schäfer (2008)

and colleagues (Alexiadou et al. 2006b; 2015). These are the shared core for causative and anticausative alternants (reviewed in Section 6.2.1) and the dissociation of syntactic and semantic transitivity (reviewed in Section 6.2.2).

### 6.2.1 Causative core

This component is crucial for the current approach and was reviewed in Section 1.3.1.2. Its main parts are summarized here.

In argument structure alternations such as (1), it is not accurate to think that the transitive variant is derived from the intransitive one, nor is it accurate to think that the intransitive variant is derived from the transitive one.

- (1) a. Mary broke the vase.  
b. The vase broke.

Alexiadou et al. (2015) propose that both variants have the same base: a core vP (2a) containing the verb (a verbalized root) and the internal argument. The difference between the two variants is that the transitive one, (2b), then has the external argument added by additional functional material, namely Voice.

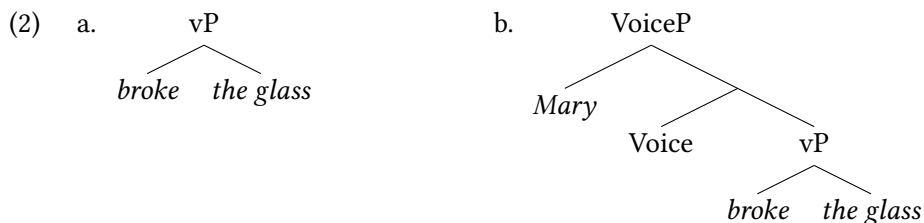

There is therefore no single direction of derivation which is marked by the morphology across languages: some languages mark the transitive variants, others mark the intransitive variants, and sometimes both variants are marked in the same language (as we have already seen for Hebrew).

In addition to the morphological reasoning, Alexiadou et al. (2015) provide a series of arguments showing that the core causative component of the vP is present even in the anticausative variants, like the anticausative examples in (3) which nevertheless have Causer PPs.

- (3) a. The flowers wilted {from the heat / \*from the gardener}.  
b. The window cracked {from the pressure / \*from the worker}.



The causative component is thereby dissociated from the external argument, the latter being introduced in an additional structural layer. Voice is the functional head enabling this layer, both in terms of licensing Spec,VoiceP in the syntax and in opening the semantic predicate Agent. This much suffices to account for the English alternation.

### 6.2.2 The transitivity of Voice

The second tenet of Layering is informed by alternations in additional languages. The existence of marked anticausatives as in (4) raises the question of what their morphology is tracking in the syntax.

- (4) Die Tür hat *sich* geöffnet.  
 the door has SICH opened  
 ‘The door opened.’ (German)

Alexiadou et al. (2015) propose a system in which Voice can be TRANSITIVE both in syntactic and semantic terms. In the syntax, Voice might be either associated with a specifier or not; in the semantics, it might introduce a thematic Agent role or not. This conceptual innovation is implemented by using a syntactic feature [D], an EPP feature on Voice.<sup>1</sup>

The important consequence is that there are five possible configurations. Four are derived using Voice, depending on whether it is syntactically active and whether it is semantically thematic. The fifth is the complete lack of Voice, as suggested for unmarked anticausatives. With this basic setup, Layering is able to handle cases in which syntactic elements like expletives do not involve thematic roles as well as cases in which the anticausative variant is marked morphologically, as we will see below. Taken together, the two main components of Layering combine to provide substantial empirical coverage and theoretical insight.

Let us get to the details. Assuming that Voice may or may not have a [D] feature, and that it may or may not introduce an Agent, the four-celled typology of Alexiadou et al. (2015: 109) emerges in Table 6.1. This typology can be augmented by including the Voiceless unmarked anticausative, vP, giving us the full table in Table 6.2.

I examine the cells of Table 6.2 one by one. The structure in cell a is a straightforward transitive derivation, at least since Kratzer (1996) and Pylkkänen (2008). The [D] feature on Voice licenses a DP in its specifier, and the Agent role is introduced in the semantics (notated here simply as  $\lambda x$ ).

<sup>1</sup>Unlike the Trivalent system – in which [D] is a feature that must simply be checked, or intuitively some kind of filter – the [D] feature in Layering is inherent to Voice and is structure-building, being the only thing that can license/project the specifier position; see Section 6.5.

Table 6.1: The typology of the Layering approach

|                          |                     | Syntax D | Syntax $\emptyset$      |
|--------------------------|---------------------|----------|-------------------------|
| Semantics<br>$\lambda x$ | a. Thematic active  |          | b. Thematic non-active  |
|                          |                     |          |                         |
| Semantics<br>$\emptyset$ | c. Expletive active |          | d. Expletive non-active |
|                          |                     |          |                         |

Table 6.2: The typology of Voice under Layering

|                          |    | Syntax D | vP    | Syntax $\emptyset$ |
|--------------------------|----|----------|-------|--------------------|
| Semantics<br>$\lambda x$ | a. |          | b. —  | c.                 |
|                          |    |          |       |                    |
| Semantics<br>$\emptyset$ | d. |          | e. vP | f.                 |
|                          |    |          |       |                    |

The structure in cell f of Table 6.2 derives a marked anticausative, similar to *niXYaZ* from Section 3.3. There is no [D] feature, so no DP can be merged in Spec,Voice. The lack of a specifier is spelled out as non-active morphology, *NACT* in short, via a rule we return to in (6). No Agent is introduced in the semantics. The result is a marked anticausative (unaccusative) construction. The unmarked anticausative is derived in cell e, by not merging any Voice head at all. Since no Voice head exists in the structure, there is no agentive semantics either, so cell b is undefined.

The particularly interesting cases are those in which we find “mismatches” between the values of the syntactic feature and semantic specification, namely cells c–d. Starting with cell d we have a situation in which no agentive semantics is introduced but Voice still requires a specifier. The Layering analysis proposes that this is the situation for the Romance expletive *SE* and the German *sich*, which appear in marked anticausatives but contribute nothing to the semantics. Similar analyses have been proposed for Icelandic by Wood (2014; 2015) and for various phenomena in English and Quechua by Myler (2016).

Finally, the configuration in cell c is also possible. Here, Voice does not have a [D] feature and does not project a specifier. However, it does introduce a thematic role. Alexiadou et al. (2015) propose that this is the correct analysis of passive verbs in Greek, which are morphologically identical to anticausatives; the analysis captures the fact that the morphology of cells c and f is identical, since in neither case is a specifier projected. The open predicate must presumably be closed off by existential closure later in the derivation. It is worth keeping in mind that regardless of combination with thematic non-active Voice, every root must still need to state whether the *NACT* variant will be anticausative, passive, or compatible with both (Alexiadou & Anagnostopoulou 2004; Alexiadou et al. 2015: 88).

## 6.3 Comparison

The Trivalent Theory differs from Layering in two concrete ways. First, Layering assumes that no Voice layer is projected for unmarked non-active constructions. I assume that a VoiceP is always projected but that its specifier might not be filled. We have seen this in the difference between active and non-active verbs in *XaYaZ* (Chapter 2), and in the difference between Voice<sub>[-D]</sub> and Voice<sub>[+D]</sub> (Chapters 3–4). The morphological reflexes of this difference are briefly highlighted in Section 6.3.1. The second difference is more substantial, building on the first: there are three possible values of the [D] features, closely associated with semantic interpretation (Section 6.3.2).

### 6.3.1 Non-active layers

Marked anticausatives show consistent morphological marking on the anticausative member of an alternation. The Latin example in (5) is adapted from sources cited in Kastner & Zu (2017):

- (5) Latin (Kastner & Zu 2017: 662)  
 vulnus        *claudi-t-ur*.  
 wound.NOM close-3SG-NACT  
 ‘The wound heals.’

To account for the appearance of non-active morphology in marked anticausatives, Layering proposes the VI in (6), following Embick (2004b):

- (6) Voice  $\leftrightarrow$  NACT / \_\_\_ No Spec

The cases in cells c and f of Table 6.2 can both be accounted for using the rule in (6), if we assume that Voice<sub>[-D]</sub> is in fact the Voice head in those structures. A theory of Vocabulary Insertion which allows (6) must then be able to make reference to syntactic contexts such as “lack of a specifier”. While this is not impossible, it does complicate the theory somewhat.

I have made a different claim: non-active morphology such as NACT and *niX-YaZ* is the spell-out of Voice<sub>[-D]</sub>. In other words, it is the flavor of Voice which is spelled out as non-active morphology, not Voice when it has no specifier. Recall the reason for this preference: Unspecified Voice in Hebrew is spelled out as *XaYaZ* regardless of whether it has a specifier or not. The spell-out rule in (7) is thus more consistent crosslinguistically.

- (7) Voice<sub>[-D]</sub>  $\leftrightarrow$  NACT (always No Spec)

This technical difference aside, in what follows I address more substantive differences between the theories.

### 6.3.2 The trivalency of transitivity

The two systems ended up looking as shown in Tables 6.3 and 6.4.

While the semantics of the cells in Layering is deterministic (modulo existential closure), the Trivalent Theory relies on contextual allosemy of the Voice head.<sup>2</sup> Its semantics looks broadly as in (8), summarizing what we have seen in previous chapters:

---

<sup>2</sup>Layering can also be formalized using allosemy, as in Schäfer (2017).

Table 6.3: The typology of Voice under Layering

|                 | Syntax D                                    | vP    | Syntax $\emptyset$                          |
|-----------------|---------------------------------------------|-------|---------------------------------------------|
| Sem $\lambda x$ | a. <div style="text-align: center;"> </div> | b. —  | c. <div style="text-align: center;"> </div> |
| Sem $\emptyset$ | d. <div style="text-align: center;"> </div> | e. vP | f. <div style="text-align: center;"> </div> |

Table 6.4: The Trivalent typology

|                           | Voice <sub>[+D]</sub>                       | Voice                                       | Voice <sub>[-D]</sub>                       |
|---------------------------|---------------------------------------------|---------------------------------------------|---------------------------------------------|
| Sem $\lambda x$           | a. <div style="text-align: center;"> </div> | b. <div style="text-align: center;"> </div> | c. (Figure reflexives)                      |
| Sem $\emptyset/\exists x$ | d. (Voice <sub>[+D]</sub> inchoatives)      | e. <div style="text-align: center;"> </div> | f. <div style="text-align: center;"> </div> |

(8) Semantics (abstracting away from Agent  $\neq$  Causer):

- a.  $\llbracket \text{Voice}_{[+D]} \rrbracket = \lambda x \lambda e. \text{Agent}(x, e)$
- b.  $\llbracket \text{Voice} \rrbracket = \begin{cases} \lambda x \lambda e. \text{Agent}(x, e) & / \text{---} \{ \sqrt{\text{EAT}}, \dots \} \\ \lambda e. e & / \text{---} \{ \sqrt{\text{FALL}}, \dots \} \end{cases}$
- c.  $\llbracket \text{Voice}_{[-D]} \rrbracket = \begin{cases} \lambda e \exists x. \text{Agent}(x, e) & / \text{---} \{ \sqrt{\text{WRITE}}, \dots \} \\ \lambda e. e & \end{cases}$

There are two points to be made about how powerful the current approach is: first, that it has all the empirical coverage necessary for the Layering patterns. Very little has to be said in order to maintain the coverage of Layering as applied to English, German and Greek. For instance, expletive constructions in Germanic and Romance are derived by simply adding the expletive in Spec, VoiceP, as in cell e of Table 6.4.

The second is that this power actually comes from a system that is just as constrained as Layering (if not more so). While in Layering all features may combine freely, in the Trivalent Theory semantic interpretation tracks the syntactic feature on the functional head: barring exceptional cases, the active head  $\text{Voice}_{[+D]}$  has an agentive reading and the non-active head  $\text{Voice}_{[-D]}$  has either a non-active reading or a passive reading. So  $\text{Voice}_{[+D]}$  does not have a straightforward non-active alloseme, and  $\text{Voice}_{[-D]}$  is the only one with a passive alloseme. In this sense, at least, the interpretation of these heads is natural.

I take this correlation to be a welcome result, though I will not attempt to derive how the syntax feeds the semantics in this way. With that in mind, however, one might still wonder whether cells c and e in Table 6.4 could be possible. In fact, we have already seen that these configurations are possible, but only when additional *syntactic* constraints are at play.

Section 3.4 analyzed figure reflexives in *niXYaZ*. This was a situation in which a  $[-D]$  head introduced an external argument, specifically the Figure role of  $p_{[-D]}$ . As noted in Section 3.5,  $p_{[-D]}$  and  $\text{Voice}_{[-D]}$  may be considered contextual variants of each other and of the generalized head  $i^*$ ; I return to this point in Chapter 7. Still, why can  $p_{[-D]}$  introduce a thematic role? One answer can be found in the work of Wood (2015). He suggests that the allosemic sensitivity of a head depends on its place in the extended projection of the verb. Metaphorically speaking, since  $p_{[-D]}$  “knows” that it is not the last head in the VoiceP, it can introduce a Figure role knowing that this role can be saturated later on. Importantly, this

is not a case of lookahead: the derivation will crash if no DP is merged to saturate that role. So a generalized version of cells c and e is possible after all, if the syntactic configuration is just right (as expected).<sup>3</sup>

The second case is cell d in Table 6.4, a situation in which a causative-marked verb turns out to be inchoative. As we saw in Section 4.3, this is no hypothetical. Inchoatives do exist in *heXYiZ*, but only in specific syntactic configurations (when the verb is de-adjectival or denominal). The allosemantic rule in Chapter 4, (18), stated this explicitly.<sup>4</sup>

As a final point of comparison before returning to Hebrew, it is important to consider how Layering allows languages to pick and choose between features to be combined. For example, Greek passives are derived as in Table 6.3, where existential closure applies to the open Agent role. Schäfer (2017) later adopts a position similar to the one here, whereby  $\exists x$  is another possible semantic value for Voice heads, thus removing the need for existential closure of  $\lambda x$ .

Either way, given that existential closure can apply at some level as in Greek, the question arises of why it does not apply in situations where an overt DP appears. Specifically, there is nothing to prevent an expletive such as German *sich* from being the DP in cell a of Table 6.3. The expletive would not have a semantic role to saturate, but an Agent would still be entailed. The result should be a construction with an expletive whose reading is not anticausative but passive. Yet this is impossible in German:

- (9) Die Tür hat sich (\*absichtlich) geöffnet, (\*um das Zimmer zu  
the door has SICH on.purpose opened in.order the room to  
lüften).  
air.out  
(int. ‘The door opened on purpose and/or in order to air out the room.’)

What is relevant in this regard is that Greek and German might avail themselves of different cells of the typology. Specifically, German can be argued not to have  $\exists x$  Voice heads (passivization applies above the VoiceP in German; cf.

<sup>3</sup>As mentioned earlier, Legate (2014) and Akkus (2019) suggest that the Agent role can be introduced and then closed off. Perhaps deponent verbs can also be treated in similar fashion.

<sup>4</sup>One crosslinguistic correlate might be the ADVERSITY CAUSATIVE of Japanese (Pylkkänen 2008; Wood & Marantz 2017), where the Voice head itself is potentially Voice<sub>[+D]</sub> (see Section 7.2.1) but does not have its own agentive semantics, instead taking a possessor role passed up from lower in the tree.

Section 5.1). Schäfer (2017) discusses similar cases of passivization in depth, concluding that  $\exists x$  is a necessary semantic possibility for Voice heads (as already mentioned above) and providing an analysis explaining why French and other languages do allow passives as in (9), albeit without *by*-phrases.

The problem is, then, that e.g. French might have Voice $\{\exists x, D\}$  for these passives but does not have Voice $\{\exists x, \emptyset\}$ ; the selection of features from the universal pool appears arbitrary. A similar problem arises for Layering when turning to causative marking: we would expect that a language with causative marking could combine it with an expletive. This does not seem to be correct, although I have not conducted enough crosslinguistic work to make this assertion conclusively.

In the Trivalent Theory, these issues do not arise, because the dichotomy of thematic/expletive Voice is abandoned, as is the idea that languages pick only a subset of features to instantiate across cells. Instead, Voice is allosemic in ways which are constrained both by the root and by the feature [D].

## 6.4 Hebrew with Layering

The last issue to be tackled here is whether the Trivalent Theory is a necessary development. Could we tweak Layering to account for the patterns analyzed in this book?

Recall that Hebrew has trivalent morphological marking, and, crucially, that verbs in *XaYaZ* might be unaccusative or transitive (Chapter 2); see Table 6.5.

Table 6.5: Basic analysis of the templates as proposed in this book

| Voice $_{[+D]}$ |            | Voice        |         | Voice $_{[-D]}$ |               |
|-----------------|------------|--------------|---------|-----------------|---------------|
| <i>heXYiZ</i>   |            | <i>XaYaZ</i> |         | <i>niXYaZ</i>   |               |
| <i>heexil</i>   | ‘fed’      | <i>axal</i>  | ‘ate’   | <i>neexal</i>   | ‘was eaten’   |
| <i>hextiv</i>   | ‘dictated’ | <i>katav</i> | ‘wrote’ | <i>nixtav</i>   | ‘was written’ |
| <i>hepil</i>    | ‘dropped’  | <i>nafal</i> | ‘fell’  |                 | —             |

Trying to analyze Hebrew using the machinery of Layering will require us to take *XaYaZ* as the spell-out of *v*, not Voice as in Chapter 2. Then, the distinction between active and non-active Voice would derive the distinction between active verbs in *XaYaZ* and verbs in *niXYaZ*. To derive the active verbs in *heX-YiZ*, additional functional structure would be necessary (since there are only two



Voice heads under Layering, regular/transitive and non-active). This alternative approach to Hebrew is summarized in Table 6.6.

I can identify a number of problems with this approach. First, it is not possible to treat *XaYaZ* akin to English or Greek unmarked alternations because *XaYaZ* does not have the zero-alternation. If *kafa* ‘froze’ is an unaccusative verb derived without Voice, adding Voice should simply give us transitive ‘froze’ with identical pronunciation, contrary to fact. While it is true that various constraints dictate whether zero-derivation is possible in a given language, it is striking that the alternation is not possible in Hebrew (setting aside the discussion in Section 4.4.3). This version of Layering predicts that zero-alternation should be fairly prevalent. Note that this point is crucial to maintaining the current view. If I am wrong about this, the way is paved for a theory of Hebrew-as-Greek consisting of *vP*, *VoiceP* and *Voice*<sub>[-D]</sub>*P* (without *Voice*<sub>[+D]</sub>).

Second, there is no convincing argument for positing extra structure in *heX-YiZ* (“lexical” causatives, Section 4.4.1). This template seems to be as integrated into the morphological system as any other, meaning that *Voice*<sub>[+D]</sub> is as integrated into the system as the other heads. In Kastner (2019b) I explained how the current system derives a number of allomorphic interactions correctly. The behavior of *Voice*<sub>[+D]</sub> with regard to constraints such as locality in allomorphy is qualitatively identical to that of *Voice*<sub>[-D]</sub> and *Voice*. Adding structure for *heX-YiZ* would lose a number of morphophonological generalizations regarding the interplay of roots and functional structure.

Third, it is unclear what the relevant function of an additional head would be. As a distinct causative head, it would be an odd type of causativizer, since it would not necessarily add any argument; it would take a transitive structure and turn it into a different transitive structure. As discussed in Section 4.4, transitive verbs in *heXYiZ* are lexical causatives, not analytic causatives.

And fourth, nominalizations clearly contain the morphology of the underlying verbal template (Section 5.3). But then why should deverbal nouns be derived from *Voice* when they can all be derived from *v*?

We could also imagine a mixed view, under which what I have called *Voice*<sub>[-D]</sub> is not a syntactic requirement on *Spec,Voice* but a semantic one: *Voice*<sub>[-D]</sub> simply has only the non-active alloemes, but does not ban DPs in its specifier as such. This would mean, for example, that in the reflexive derivation of Section 3.7.1.2 the Theme raises to *Spec,Voice*<sub>[-D]</sub> and not to *Spec,TP*. Such a view also opens the door for derivations in which an internal argument raises through *Spec,VoiceP*, as has been proposed for some ergative languages (Deal 2019). The problem with such a system is conceptual, in that *Voice*<sub>[-D]</sub> now has no syntactic feature distinguishing it from Unspecified *Voice*. Given that Unspecified *Voice* has a non-active

Table 6.6: Layering-style analysis of Hebrew (to be rejected)

|            | unmarked anticausative | unmarked transitive          | marked anticausative                                   | marked transitive                |
|------------|------------------------|------------------------------|--------------------------------------------------------|----------------------------------|
| Derivation | vP                     | VoiceP<br>/ \<br>DP Voice vP | VoiceP<br>/ \<br>Voice{ $\emptyset$ , $\emptyset$ } vP | cAUSP<br>/ \<br>CAUS DP Voice vP |
| Spell-out  | <i>XaYaZ</i>           | <i>XaYaZ</i>                 | <i>niXYaZ</i>                                          | <i>heXYiZ</i>                    |

alloseme, it is not clear what this semantic Voice<sub>[-D]</sub> would be signaling to the learner. This view also severs the similarity between modified Voice<sub>[-D]</sub> (which has no syntactic requirements and does not introduce a thematic role) and  $p_{[-D]}$  or a modified  $p_{[-D]}$  (which has a syntactic requirement and does introduce a thematic role).<sup>5</sup>

One final alternative would maintain the basics of Layering while placing an emphasis on processes of Impoverishment. This possibility is discussed next.

## 6.5 An alternative with Impoverishment

As mentioned already, in the Trivalent system [D] acts as a feature that needs to be checked or as a sort of “filter”, rather than as a structure-building feature. Work in the Layering tradition – most explicitly that of Schäfer (2008) and Wood (2015) – differentiates between Voice with {D}, which necessarily projects a specifier, and Voice with empty {}, which does not. Recent discussions with Jim Wood (p.c. Sep–Nov 2019) helped clarify how this specific view of [D] and Merge could be maintained in the face of the Hebrew data. I present this alternative first in Section 6.5.1, and then list my reasons for rejecting it in Section 6.5.2.

Since much of the discussion will have to do with TRIPLETS, let us recall the empirical picture. The most complicated cases are those where a given root occurs in the three templates *XaYaZ*, *niXYaZ* and *heXYiZ*. These are the ones I take to be simplest structurally, as they do not involve  $\sqrt{\text{ACTION}}$  or Pass. As far as I know, there is no curated list of all such triplets in Hebrew. Searching the database of Ehrenfeld (2012), I found 147 roots that are instantiated in all three templates out of 1,875 roots in total. Not all of these make for clear triplets, and so I searched for good examples by hand. Table 6.7 (page 212) lists the ten clearest cases I have found, in which a semantic relationship holds between all three forms and at least two of these are transparently related.

### 6.5.1 An Impoverished Layering Theory of Hebrew

#### 6.5.1.1 Basics

This alternative attempts to maintain the structure-building view of [D], whereby there is no Unspecified Voice, only Voice<sub>{D}</sub> which projects a specifier, and Voice<sub>{}</sub>  which does not. The [D] feature, like any other feature, can undergo Impoverishment.

---

<sup>5</sup>Thanks to Yining Nie for noting this possibility and its implications.

Table 6.7: Derivational triplets in Hebrew

| Root                    | <i>XaYaZ</i>           | <i>niXYaZ</i>                  | <i>heXYiZ</i>              |
|-------------------------|------------------------|--------------------------------|----------------------------|
| a. $\sqrt{\text{axl}}$  | <i>axal</i> ‘ate’      | <i>neexal</i> ‘was eaten’      | <i>heexil</i> ‘fed’        |
| b. $\sqrt{\text{xjb}}$  | <i>xafav</i> ‘thought’ | <i>nexfav</i> ‘was considered’ | <i>hexfiv</i> ‘considered’ |
| c. $\sqrt{\text{jd}}$   | <i>jada</i> ‘knew’     | <i>noda</i> ‘was known’        | <i>hodia</i> ‘announced’   |
| d. $\sqrt{\text{ktb}}$  | <i>katav</i> ‘wrote’   | <i>nixtav</i> ‘was written’    | <i>hextiv</i> ‘dictated’   |
| e. $\sqrt{\text{mtsa}}$ | <i>matsa</i> ‘found’   | <i>nimtsa</i> ‘was found’      | <i>hemtsi</i> ‘invented’   |
| f. $\sqrt{\text{sgr}}$  | <i>sagar</i> ‘closed’  | <i>nisgar</i> ‘was closed’     | <i>hesgir</i> ‘extradited’ |
| g. $\sqrt{\text{ark}}$  | <i>arax</i> ‘edited’   | <i>neerax</i> ‘was edited’     | <i>heerix</i> ‘estimated’  |
| h. $\sqrt{\text{pnj}}$  | <i>pana</i> ‘faced’    | <i>nifna</i> ‘turned towards’  | <i>hefna</i> ‘directed to’ |
| i. $\sqrt{\text{krj}}$  | <i>kara</i> ‘read’     | <i>nikra</i> ‘was read’        | <i>hekri</i> ‘read out’    |
| j. $\sqrt{\text{raj}}$  | <i>raa</i> ‘saw’       | <i>nira</i> ‘was seen’         | <i>hera</i> ‘showed’       |

The most basic spell-out rules, to be revised immediately, are in (10). The transitive Voice head is spelled out as the “causative” template *heXYiZ*, and the non-active Voice head as the non-active template (*niXYaZ*).

- (10) Initial VIs (to be revised)
- Voice<sub>{D}</sub> ↔ *heXYiZ*
  - Voice<sub>∅</sub> ↔ *niXYaZ*

We also know that some roots simply need to appear in certain templates. In particular, some agentive verbs do not appear in *heXYiZ* but in *XaYaZ* (Chapter 4), and some unaccusative verbs do not appear in *niXYaZ* but in *XaYaZ* (Chapter 3). Calling these simply  $\sqrt{\text{Root1}}$ ,  $\sqrt{\text{Root2}}$  and so on for the time being, we have the revised VIs in (11).<sup>6</sup>

- (11) Revised VIs (to be revised further)
- Voice<sub>{D}</sub> ↔  $\begin{cases} \textit{heXYiZ} & / \text{ } \_\_\_ \sqrt{\text{Root1}}, \sqrt{\text{Root2}}, \dots \\ \textit{XaYaZ} \end{cases}$
  - Voice<sub>∅</sub> ↔  $\begin{cases} \textit{niXYaZ} & / \text{ } \_\_\_ \sqrt{\text{Root3}}, \sqrt{\text{Root4}}, \dots \\ \textit{XaYaZ} \end{cases}$

<sup>6</sup>The listed roots could appear under either the marked or unmarked template in each case; I give them in the marked cases here.

## 6.5.1.2 Appl

It is now that the challenge posed by triplets can be re-introduced. Here the theory makes use of the applicative head Appl. The intuition is that when an alternation holds between  $XaYaZ$  and  $heXYiZ$ , the latter form can be derived by using an Appl head.

Since I have spent some time discussing the relationship between  $XaYaZ$  and  $heXYiZ$  in Chapter 4, I will not repeat the details here; see the list in Table 4.6 for some examples. This idea does receive empirical support from pairs like those in rows a and d of Table 6.7, where ‘feed’ and ‘dictate’ arguably take an additional argument when compared to ‘eat’ and ‘write’. But it is a bit more of a stretch with cases like row e of Table 4.6, *daxak* ‘shoved’ ~ *hedxik* ‘suppressed (emotions)’. In this case, the latter would have to involve some kind of low Appl-INTO, and it would be far less clear what it means to be an applied argument.

In any case, if we were to accept this premise, we would have the revised VIs in (12), again not a final proposal.

(12) Revised VIs (pre-final version)

- a.  $\text{Voice}_{\{D\}} \leftrightarrow \begin{cases} heXYiZ & / \text{ ___ Appl, } \sqrt{\text{Root1}}, \sqrt{\text{Root2}}, \dots \\ XaYaZ & \end{cases}$
- b.  $\text{Voice}_{\emptyset} \leftrightarrow \begin{cases} niXYaZ & / \text{ ___ } \sqrt{\text{Root3}}, \sqrt{\text{Root4}}, \dots \\ XaYaZ & \end{cases}$

## 6.5.1.3 Additional diacritic

Finally, we need to account for the triplets that cannot be handled with Appl. Consider a triplet like that in row e of Table 6.7, where it is highly doubtful that ‘invent’ is an applicative version of ‘find’. Since this root appears with both templates, they cannot be differentiated by listing a  $\sqrt{\text{Root5}}$  in both cases for  $\text{Voice}_{\{D\}}$ . Some additional diacritic (or feature) would be necessary, call it simply F like in (13).

(13) VIs in the Impoverishment alternative (final version)

- a.  $\text{Voice}_{\{D\}} \leftrightarrow \begin{cases} heXYiZ & / \text{ ___ F, Appl, } \sqrt{\text{Root1}}, \sqrt{\text{Root2}}, \dots \\ XaYaZ & \end{cases}$
- b.  $\text{Voice}_{\emptyset} \leftrightarrow \begin{cases} niXYaZ & / \text{ ___ } \sqrt{\text{Root3}}, \sqrt{\text{Root4}}, \dots \\ XaYaZ & \end{cases}$

### 6.5.2 Discussion

I have tried to lay out this alternative as explicitly as possible so that its strengths and weaknesses may be evaluated. The main gain would be a theory-internal one: as mentioned at the outset, a theory with only  $\text{Voice}_{\{D\}}$  and  $\text{Voice}_{\emptyset}$  preserves a specific conceptualization of Merge, one which is no longer available once Unspecified Voice enters the picture in a Trivalent system. An additional benefit is a closer connection with extant theories insofar as Appl can be used in similar fashion.

These strengths are outweighed by the weaknesses, in my eyes, and these are of a conceptual as well as empirical nature. Starting with the use of Impoverishment, the following points arise. First, since the choice of template for a given root has syntactic and semantic effects, this means that Impoverishment would have to apply in the syntax proper and not early in Spell-Out, as commonly assumed, where it does not have semantic effects (e.g. Harbour 2003). Second, Impoverishment would need to be triggered by particular roots and not by marked features or feature combinations. Third, this would only happen some of the time, because many roots can appear in more than one template, e.g. in both *heXYiZ* and *XaYaZ*. This last point could be discounted due to the use of Appl, which is the next point of discussion.

As already mentioned, the definition of the semantics of Appl might be stretched fairly thin, depending on which specific cases it should be applied to. In addition, even in the cases in which an applicative *semantics* is easier to motivate, an applicative *syntax* is only optional. That is to say, even in row i of Table 6.7 – *hekri* ‘read out’ – a Goal argument does not have to be expressed. This issue could be addressed by assuming that an expletive  $\text{Appl}_{\emptyset}$  is possible (Wood 2015; p.c.) with no argument introduced in its specifier.

As a last conceptual point, the system as a whole makes reference to an additional mechanism sorting out triplets, namely the diacritic/feature [F]. Taken together, this approach is increasingly reminiscent of Arad (2005), where the grammar lists the conjugation classes a given root participates in. It is also noteworthy that Appl and [F] form a natural class somehow.

Finally, there is also one important empirical point: this alternative is able to derive labile alternations in *XaYaZ* as a general rule. Imagine a root  $\sqrt{\text{Root5}}$  which is not on either of the lists for  $\text{Voice}_{\{D\}}$  and  $\text{Voice}_{\emptyset}$  in (13). Then it would be spelled out as *XaYaZ* for  $\text{Voice}_{\{D\}}$ , but also as *XaYaZ* for  $\text{Voice}_{\emptyset}$ . As noted in Section 4.2.2, this is not the case with any verb except for perhaps *atsar* ‘stopped’.

In conclusion, even though I have identified various reasons to doubt a Layering approach to Hebrew (whether implemented as in this section or as in Sec-

tion 6.4), it is important to acknowledge that not all of the explanations given here are particularly deep. For instance, I have implicitly assumed that all Hebrew verbs need Voice, in contrast to existing assumptions for certain verbs in English, German and Greek. This assumption raises the question of whether Voice should be obligatory for all verbs in all languages, a point leading us to the concluding remarks for this comparison.

## 6.6 Conclusion

This chapter presented a direct comparison of the theory developed in this book with what I have called the Layering approach, the prevalent syntax-based theory of transitivity alternations as implemented by Schäfer (2008; 2017) and Alexiadou et al. (2015). I have identified a number of weaknesses with the Layering approach and illustrated how its considerable explanatory power can be mirrored in the Trivalent approach. Furthermore, I have identified cases which require a concrete departure from the features of Layering.

Aside from the specific weaknesses discussed here, the main empirical difference underlying the most substantial need for a revised theory is that the Layering Theories were based on an exploration of anticausative marking, not of causative marking (see the discussion in Chapter 4). The languages on which this approach is based show anticausative marking, including English (Myler 2016), German (Schäfer 2017) and Greek (Spathas et al. 2015), but also Albanian (Kallulli 2013), Icelandic (Wood 2015), Latin (Embick 2004b; Kastner & Zu 2017) and Spanish (Schäfer & Vivanco 2016).

The theory developed here on the basis of Hebrew makes explicit room to accommodate causative marking. The Trivalent View of Voice is most useful when considering languages that show reflexes of this marking, including Japanese (Os eki 2017) and a number of Austronesian and Polynesian languages (Nie 2017), as in the next chapter. In other words, it becomes clear that causative marking has much to tell us about argument structure alternations, alongside anticausative marking and, ideally, in a joint theory like the one presented thus far.

To conclude, let us put the pieces together and speculate on what the Voice inventory of a given language might be. I see three possibilities.

On the one hand, it is possible that all languages have the Trivalent system of Table 6.4. We would then assume that in English, German and so on Voice<sub>[+D]</sub> and Voice are syncretic. On the other hand, it might be the case that only Voice heads that are morphophonologically distinct can be argued to exist in a given language. This is essentially the view of Alexiadou et al. (2015), who proposed that learners

of English do not hypothesize the existence of expletive Voice because there is no morphological evidence for it. If this is the case, then languages with marked anticausatives and marked causatives are Trivalent languages, whereas languages with only marked anticausatives are Layering languages. Finally, one could also come up with a hybrid view, in which all languages are at least active/non-active Layering languages, even when there is no morphological evidence (as in English), following from the basic active/non-active distinction that came up in the context of causative marking (Section 4.4).

I will not argue for any of these views explicitly, although I do maintain that the Trivalent Theory is simultaneously the most constrained and the most flexible (whether this flexibility means that Trivalent Voice should be hard-coded into the grammar is debatable). In addition, treating transitivity alternations in terms of various features on Voice – extending the original Layering view – paves the way for a more nuanced view of what these features might be. In Section 4.4.1.2 I speculated that French could be treated as a Trivalent language if certain prefixes spell out Voice<sub>[+D]</sub>. I do not know if that view can be maintained – it probably cannot – but it does highlight what new perspectives can be gained by looking at different argument structure phenomena in terms of Layering with a certain feature set. In the next chapter I discuss some recent proposals that extend the coverage of feature-based approaches beyond transitivity marking, by considering their interaction with case and agreement.



## 7 The features of Voice

This book presents a theory of argument structure and its relation to morphology which was developed with two goals in mind: to remain as close as possible to existing analyses of non-Semitic languages (theoretical parsimony) and to explain the templatic system of verbs in Modern Hebrew (empirical adequacy). I have contended that this theory should be seen not only as a theory of Hebrew but as a theory of argument structure crosslinguistically. Accordingly, two questions should be distinguished when we ask about the crosslinguistic validity of the Trivalent Theory:

1. Does the syntactic inventory of every language always contain these heads (Voice, *v* and *p*)?
2. Does every language have the kinds of features on these heads that Hebrew does, i.e. Voice<sub>[+D]</sub>, *p*<sub>[-D]</sub>, etc.?

In the current chapter I summarize the generalizations pointed out throughout the book and the means used to explain them (Section 7.1). I then discuss some related issues in the theory of Voice, chiefly the identity of this head (Section 7.2, addressing the first question) and the identity of its features (Section 7.3, addressing the second question). Section 7.4 concludes the chapter, and with it the book, although it will surely not be the final word (or template) on Hebrew morphology.

### 7.1 Summary of the Trivalent approach

The two questions I posed regarding verbal templates were as follows:

- What are the possible readings associated with a given template (and why)?
- What templates does a given template alternate with (and why)?

The summary of this work is divided into the empirical generalizations which an adequate theory of Hebrew morphology must derive, and the formal system I have implemented to do so. Readers who have jumped directly to this section may want to consult Section 1.3 for some formal background.

### 7.1.1 Summary of generalizations

Every description or discussion of Hebrew morphology begins with the templatic system. The current book was also organized this way, laying out the empirical landscape template by template. The list below recaps the generalizations made about each template.

- (1) Generalizations about *XaYaZ*
  - a. *Configurations*: Verbs appear in all possible argument structure configurations.
  - b. *Alternations*: *XaYaZ* participates in alternations with the other templates.
- (2) Generalizations about *XiYeZ*
  - a. *Configurations*: Verbs appear in active (transitive/unergative) configurations. Readings are weakly agentive.
  - b. *Alternations*: When alternating with *XaYaZ*, *XiYeZ* provides a more “intensive” or agentive version.
- (3) Generalizations about *niXYaZ*
  - a. *Configurations*: Verbs appear in unaccusative, passive and figure reflexive structures, but never in a simple transitive configuration.
  - b. *Alternations*: Some verbs are anticausative or passive versions of verbs in *XaYaZ*.
- (4) Generalizations about *hitXaYeZ*
  - a. *Configurations*: Verbs appear in unaccusative, figure reflexive and reflexive structures, but not in a simple transitive configuration.
  - b. *Alternations*: Some verbs are anticausative or reflexive versions of verbs in *XiYeZ*.
- (5) Generalizations about *heXYiZ*
  - a. *Configurations*: Verbs appear in transitive and unergative configurations; a small class of verbs forms unaccusative degree achievements.

- b. *Alternations*: Some verbs are causative or active versions of verbs in other templates, especially  $XaYaZ$ . A small class of verbs creates a labile alternation within  $heXYiZ$ .
- (6) Generalizations about  $XuYaZ$  and  $huXYaZ$
- a. *Configurations*: Verbs appear in passive configurations only.
- b. *Alternations*: Verbs in  $XuYaZ$  are always the passive version of an active verb in  $XiYeZ$ . Verbs in  $huXYaZ$  are always the passive version of an active verb in  $heXYiZ$ .

Some of these generalizations are quite unnatural. To take one example,  $niX-YaZ$  has both unaccusative and unergative verbs, but no transitive verbs; how should a formal analysis account for this? Having acknowledged that unergative and unaccusative verbs have different structures (the Unaccusativity Hypothesis), contemporary theories can hardly refer to “intransitivity” as a theoretical primitive. These generalizations are summarized in Table 7.1, where a naïve view of the templates defies economical description – at least at first sight.<sup>1</sup>

Table 7.1: A descriptive view of the templates

|    | Template   | Unacc | Unerg | Transitive | Reflexive | Pass | Alternations |
|----|------------|-------|-------|------------|-----------|------|--------------|
| a. | $XaYaZ$    | ✓     | ✓     | ✓          | ✗         | ✗    | b, c, e      |
| b. | $XiYeZ$    | ✗     | ✓     | ✓          | ✗         | ✗    | a, d, f      |
| c. | $niXYaZ$   | ✓     | ✓     | ✗          | ✗         | ✓    | a, e         |
| d. | $hitXaYeZ$ | ✓     | ✓     | ✗          | ✓         | ✗    | b, g         |
| e. | $heXYiZ$   | ✓     | ✓     | ✓          | ✗         | ✗    | a, c, e      |
| f. | $XuYaZ$    | ✗     | ✗     | ✗          | ✗         | ✓    | b            |
| g. | $huXYaZ$   | ✗     | ✗     | ✗          | ✗         | ✓    | g            |

Table 7.1 clearly shows the many-to-many mapping problem that arises when trying to link morphology and syntax/semantics in Hebrew (with the exception of the two passive templates, perhaps the sole topic of consensus in the morphosyntactic literature on Hebrew). What is the reading of a verb in  $hitXaYeZ$ ? The answer is not deterministic: sometimes unaccusative, sometimes unergative, sometimes reflexive. What morphology do you choose if you want to express

<sup>1</sup>This table does not distinguish plain unergatives from figure reflexives, precisely because traditional views do not make this distinction.

an unaccusative verb? The answer is again not deterministic: sometimes *XaYaZ*, sometimes *niXYaZ*, sometimes *hitXaYeZ* and sometimes *heXYiZ*. So form cannot map directly to meaning, if by “form” we mean templates. My critique of Arad (2005) in previous chapters hopefully showed just how important that work was in clearing up this point.

And once you have chosen a template, how do you know which template to derive an alternation in? Should you go from an anticausative in *niXYaZ* to *XaYaZ* or to *heXYiZ*? We have seen that both are possible, as shown in Table 7.2.

Table 7.2: Causative and anticausative alternations

|                     |              |   | Anticausative | Causative     |               |               |
|---------------------|--------------|---|---------------|---------------|---------------|---------------|
|                     |              |   | <i>niXYaZ</i> | <i>XaYaZ</i>  | <i>heXYiZ</i> |               |
| $\sqrt{\text{fbr}}$ | broke        | ~ | broke         | <i>nifbar</i> | <i>favar</i>  | –             |
| $\sqrt{\text{kxd}}$ | went extinct | ~ | eradicated    | <i>nikxad</i> | –             | <i>hekkid</i> |

Again, some patterns exist but looking at the templates in terms of primitives makes it hard to understand why precisely these patterns arise, above and beyond the idiosyncrasy of individual roots.

Some of the generalizations tallied above are novel. The entire formal conception of figure reflexives in Hebrew (Kastner 2016) and indeed in this general framework is recent (Wood 2012; 2014). The characterization of unaccusatives in *heXYiZ* as degree achievements is recent, although not my own (Lev 2016). The observation that *heXYiZ* is not a causative template but a general active one, which might also have lexical causatives, is novel as far as I can tell, at least when put in these terms. The idea that the distinction between anticausatives and reflexives in *hitXaYeZ* reflects the lexical semantics of the roots is also very recent (Kastner 2017). And the allomorphic interactions which I have identified have also only been noticed recently in a unified way (Kastner 2019b). Even if the analysis ends up being inadequate, I believe that these generalizations are important and hope that future work can engage with them rigorously.

### 7.1.2 D-composing the templates

Instead of talking about templates, I have proposed that we talk about syntactic structure and cyclic derivations. This was done using the head Voice and allowing it to take one of three values: [+D], [–D] or unspecified for [D]. Informal definitions are given in (7).

- (7) Overt Voice heads in Hebrew
- a. Voice<sub>[+D]</sub>: requires a DP in its specifier.
  - b. Voice<sub>[-D]</sub>: prohibits a DP in its specifier.
  - c. Unspecified Voice: places no restrictions on its specifier.

Acknowledging the existence of an overt agentive modifier whose semantics is difficult to pin down but which does not seem to be active in the syntax adds  $\sqrt{\text{ACTION}}$  to our toolbox.

- (8)  $\sqrt{\text{ACTION}}$ : an overt modifier adding ACTION (agentive) semantics to an event. In practice, this often creates a requirement for an Agent role to be saturated.

Assuming that prepositional phrases are derived similarly to verbs gives us the functional head  $p$  and its  $[-D]$  variant  $p_{[-D]}$  (more on this in Section 7.2.2).

- (9) a.  $p$ : the prepositional equivalent of Voice; introduces the Figure role (the subject of a preposition).  
 b.  $p_{[-D]}$ : prohibits a DP in its specifier.

The passive head Pass rounds off the picture.

- (10) Pass: prevents the projection of an argument in Spec,VoiceP and closes off the Agent role existentially in the semantics.

When these elements are combined, the resulting picture is not the confusing one in Table 7.1 but the principled one in Table 7.3. These elements and the values of their features explain what structures give rise to what spell-outs, or in other words, what CONFIGURATIONS a given template is possible in.

The combinatorics of these heads – specifically unattested combinations – were addressed in the individual chapters. See Kastner (2016: Section 2.4.1.1) for a summary.

The hierarchical structure – that is to say, the layering of Voice above vP – explains what ALTERNATIONS are possible. Since Voice merges above a core vP, the three values of Voice can give rise to three templates in transitivity alternations ( $XaYaZ$ ,  $niXYaZ$  and  $heXYiZ$ ). Because  $\sqrt{\text{ACTION}}$  merges with the core vP,  $Xi\check{Y}eZ$  has a less transparent, but still fairly consistent, relationship with  $XaYaZ$ . And given that the core vP with  $\sqrt{\text{ACTION}}$  can then combine with either unspecified Voice or Voice<sub>[-D]</sub>, we derive the alternation between  $Xi\check{Y}eZ$  and  $hitXa\check{Y}eZ$ . The final alternation, between active  $Xi\check{Y}eZ$  and  $heXYiZ$  on one side and passive  $Xu\check{Y}aZ$  and  $huXYaZ$  on the other, follows from merging Pass with the active

## 7 The features of Voice

Table 7.3: Functional heads in the Hebrew verb

|      | Heads                                        | Syn         | Sem    | Phono            | Section |
|------|----------------------------------------------|-------------|--------|------------------|---------|
|      | Voice                                        |             |        | <i>XaYaZ</i>     | 2.3     |
|      | Voice $\sqrt{\text{ACTION}}$                 |             | Action | <i>XiYeZ</i>     | 2.5     |
| Pass | Voice $\sqrt{\text{ACTION}}$                 | Passive     | Action | <i>XuYaZ</i>     | 5.1.3   |
|      | Voice <sub>[+D]</sub>                        | EA          |        | <i>he-XYiZ</i>   | 4.3     |
| Pass | Voice <sub>[+D]</sub>                        | Passive, EA |        | <i>hu-XYaZ</i>   | 5.1.3   |
|      | Voice <sub>[-D]</sub>                        | No EA       |        | <i>ni-XYaZ</i>   | 3.3     |
|      | Voice $p_{[-D]}$                             | EA = Figure |        |                  | 3.4     |
|      | Voice <sub>[-D]</sub> $\sqrt{\text{ACTION}}$ | No EA       | Action |                  | 3.7.1   |
|      | Voice $\sqrt{\text{ACTION}}$ $p_{[-D]}$      | EA = Figure | Action | <i>hit-XaYeZ</i> | 3.7.2   |

VoiceP. Alternations are therefore not listed extrinsically nor are they the property of templates. They are what we see if a given root is instantiated in a number of structures which share a core vP, similar to Schäfer's (2008) conclusion for the causative alternation in European languages.

Let me reiterate the role of ROOTS in this theory and in any theory of Semitic: at some level it must be listed what functional heads are licensed by what roots. I have not attempted to formalize this matter. Arad (2005) makes a strong case for the view under which the combination is almost entirely arbitrary, in that each combination of root and template must be listed. I do not know whether this is necessarily true, but currently have no better way of describing the system. As emphasized throughout the book, the same issue arises regardless of language or theoretical framework.

This analysis aims to be simple: the child only posits variants of basic elements if she has evidence for them. Hebrew has phonological (and of course syntactic and semantic) evidence for all and only the elements in Table 7.3, obviating the need for additional silent structure. In the next section I try to take a step back from Semitic, considering the conceptual and crosslinguistic inventory of syntactic heads.

### 7.2 Voice heads

The framework as a whole allows for Voice heads and *p* heads, alongside verbalizers (little *v*, *n* and *a*). I also assume that applicatives are introduced using the

head Appl, although I made no claims about applicatives in Hebrew. These heads all appear to be empirically necessary, but recent work suggests that they need not be distinguished theoretically. In what comes next I review how the Trivalent proposal can be applied to an unrelated language, Japanese (Section 7.2.1), as well as a recent theoretical proposal which dovetails nicely with the current proposal (Section 7.2.2), and the crosslinguistic prospects for the Trivalent approach to Voice (Section 7.2.3).

### 7.2.1 Japanese

The morphology of transitivity alternations in Japanese has received significant attention over the years (Suga 1980; Jacobsen 1992; Miyagawa 1998; Nishiyama 1998; Volpe 2005; Harley 2008). Recently, Oseki (2017) proposed an analysis of argument structure alternations and their expression in the morphology of Japanese which builds on the Trivalent system. Here is an outline and quick evaluation.

Some verbs like *hirak* ‘open’ have the labile alternation:

- (11) Japanese (Oseki 2017)
- a. John-ga doa-o *hirak-Ø-ta*.  
John-NOM door-ACC open-Ø-Past  
‘John opened the door.’
  - b. Doa-ga *hirak-Ø-ta*.  
door-NOM open-Ø-Past  
‘The door opened.’

With many other verbs, overt transitivity markers can be found, namely -s- (and allomorphs) for marked transitives and -r- (and allomorphs) for marked intransitives:

- (12) a. John-ga posutaa-o *hag-as-ta*.  
John-NOM poster-ACC peel-s-Past  
‘John took down a poster.’
- b. Syatsu-ga *chijim-ar-ta*.  
shirt-NOM shrink-r-Past  
‘A shirt shrank.’

Tellingly, Japanese has “minimal triplets” similar to those which motivated the current proposal for Hebrew. Oseki (2017) reproduces data such as those in Table 7.4 from Suga (1980).

Table 7.4: Minimal triplets in Japanese

|                      | Marked intransitive | Unmarked intransitive | Marked transitive |
|----------------------|---------------------|-----------------------|-------------------|
| $\sqrt{\text{PEEL}}$ | hag-er-u            | hag- $\emptyset$ -u   | hag-as-u          |
| $\sqrt{\text{CUT}}$  | kur-er-u            | kir- $\emptyset$ -u   | kir-as-u          |

These patterns can be understood if we assume something like the following for Japanese:

- (13) a. Voice  $\leftrightarrow \emptyset$   
 b. Voice<sub>[-D]</sub>  $\leftrightarrow$  -R-  
 c. Voice<sub>[+D]</sub>  $\leftrightarrow$  -S-

Oseki (2017) then goes on to show how this system predicts the behavior of the causative *-sase* applicatives as *-s-* over *-s-* (potentially Voice<sub>[+D]</sub> over Voice<sub>[+D]</sub>) and of the passive *rare* as *-r-* over *-r-* (potentially Voice<sub>[-D]</sub> over Voice<sub>[-D]</sub>).<sup>2</sup>

Appealing as this analysis of Japanese may be, I must note two aspects in which it diverges from the Trivalent proposal for Hebrew. First, *s*-marked verbs are always transitive. In fact, Nie (2017: 26) notes that the alternation between a marked and unmarked transitive resembles a Differential Object Marking pattern, correlating with the appearance of the object marker *-o* (glossed ACC) for some speakers. Marked transitives are only possible with *-o*, but zero-marking is possible regardless of whether the object marker appears. Yet Hebrew Voice<sub>[+D]</sub> does not enforce transitivity, only an external argument.

- (14) a. John-ga posutaa-**o** hag- $\emptyset$ /as-ta.  
 John-NOM poster-ACC peel- $\emptyset$ /s-Past  
 ‘John took down (a specific) poster.’  
 b. John-ga posutaa hag- $\emptyset$ /(\*as)-ta.  
 John-NOM poster-ACC peel- $\emptyset$ /s-Past  
 ‘John took down a poster (some poster).’

<sup>2</sup>In Hebrew this specific combination cannot be examined because Hebrew does not have a “morphological” Appl affix; benefactive and malefactive arguments are introduced using the preposition *le-* ‘to’.

- (i) ha-arje bifel fuit (la-jeladim).  
 the-lion cooked beans (to.the-children)  
 ‘The lion cooked (the children) beans.’



Second, these patterns are not necessarily the entire story. Oseki (2017: 9) also gives the patterns in Table 7.5 from Suga (1980), in which *-er-* is now the transitivity marker and the marked intransitive *-R-* form is *-ar-*.

Table 7.5: Alternative minimal triplets in Japanese

|                        | Marked intransitive | Unmarked transitive    | Marked transitive |
|------------------------|---------------------|------------------------|-------------------|
| $\sqrt{\text{SHRINK}}$ | chijim-ar-u         | chijim- $\emptyset$ -u | chijim-e-ru       |
| $\sqrt{\text{MOVE}}$   | tsutaw-ar-u         | tsutaw- $\emptyset$ -u | tsutaw-e-ru       |

To what extent these patterns are phonologically predictable and to what extent there is accidental syncretism are important questions. But they are tangential to my current reservation, which is simply that more work needs to be done in order to understand Japanese transitivity alternations. The Trivalent system therefore provides a good starting point for investigating Japanese, especially if it can provide novel explanations for the morphology of applicatives and passives, and if it can explain DOM-like patterns (Section 7.3.4).

### 7.2.2 $i^*$

In a recent account of the way argument structure is derived and interpreted, Wood & Marantz (2017) propose to reduce the overall inventory of functional heads. Working within a similar framework, they suggest that non-internal arguments (external and applied arguments introduced by Voice, Appl,  $p$  and P) are in fact introduced by contextual variants of the same predicational head. This head is called  $i^*$ .

If Wood & Marantz (2017) are correct, the difference between  $p$ , Appl and Voice is an illusion: they are all the same predicational head underlyingly, albeit in different contexts. Voice is but  $i^*$  that merges with a vP. Little  $p$  is but  $i^*$  that merges with a PP. And P itself is  $i^*$  modified by a (prepositional) root; see the work cited for full details. The analytical possibilities opened up by this view have already been pursued in a range of recent work, including Appl and Voice in German psych-predicates (Hirsch 2018), and P and Appl in Russian datives (Boneh & Nash 2017).

My goal here is not to evaluate this proposal, which is supported by conceptual considerations as well as empirical study of figure reflexives in Icelandic, the Adversity Causative in Japanese and possession in Quechua and other languages. Instead, I want to highlight one welcome point of convergence between the  $i^*$

hypothesis and my proposal for Hebrew. In the inventory of functional heads I have laid out, Voice<sub>[-D]</sub> and *p*<sub>[-D]</sub> are conspicuously similar: they do similar work in the syntax and have the same spell-out. If we follow the *i*<sup>\*</sup> hypothesis, the two *should* be similar: they are the same functional head, only in different contexts (15).

- (15) a. Anticausative in *niXYaZ*

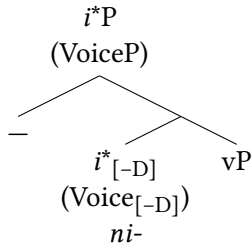

- b. Figure reflexive in *niXYaZ*

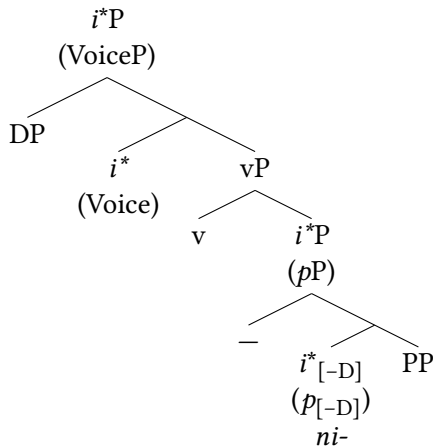

To be clear, I do not believe that the *i*<sup>\*</sup> hypothesis must be true for the Trivalent account to go through. But if this hypothesis is on the right track, a strong version can be formulated under which all exponents of *i*<sup>\*</sup> (as well as its variants *i*<sup>\*</sup><sub>[-D]</sub> and *i*<sup>\*</sup><sub>[+D]</sub>) should be identical to each other. Such a hypothesis would immediately predict the similarity between Voice and *p* – both default and silent – and that between Voice<sub>[-D]</sub> and *p*<sub>[-D]</sub>.

### 7.2.3 Trivalent Voice/*i*<sup>\*</sup> crosslinguistically

This chapter began by asking whether the syntactic inventory of every language always contains the heads Voice, *v*, *p* and potentially Appl. My working hypothesis is that the answer is yes. I assume that Voice, *v* and *p* are an inherent part

of the syntactic system of every language. I am less certain about the applicative head Appl, although under the  $i^*$  hypothesis there is no difference between Appl and Voice or  $p$ .

In Kinyarwanda, the causative and instrumental applicative suffixes are spelled out identically (Jerro 2017), and in the Algonquian language Penobscot, many “relational predicates” have similar if not identical morphology for causatives and applicatives (Quinn 2006: Section 2.3.7.1). The  $i^*$  hypothesis would lead us to expect similar correlations between different heads crosslinguistically. Combining the outlined analysis of Japanese above with the basics of  $i^*$ , we arrive at the picture in Table 7.6.

Table 7.6: Flavors of  $i^*$  in Hebrew and Japanese

| Head         | Hebrew        | Japanese |
|--------------|---------------|----------|
| $i^*$        | <i>XaYaZ</i>  | -e-      |
| $i^*_{[-D]}$ | <i>niXYaZ</i> | -r-      |
| $i^*_{[+D]}$ | <i>heXYiZ</i> | -s-      |

How far can this idea extend? Within Semitic, Standard Arabic and some Arabic dialects might be informative. Little contemporary work has investigated the morphosyntax of templates in Semitic languages in depth (Kastner & Tucker submitted): even though a significant number of studies have explored morphosyntactic processes and their interaction with phonological exponence in languages such as Amharic, Mehri and Maltese (e.g. Kramer 2014; 2016; Doron & Khan 2016; Faust 2016; 2018; 2019; Rood 2017; Winchester 2017; 2019; Akkus 2019; Kalin 2020), these works do not usually discuss verbal morphology as such.

One recent contribution to the study of Semitic verbal morphology is that of Al Kaabi & Ntelitheos (2019), who put forward a formal account of verbal morphology in Emirati Arabic. This DM analysis recasts the heads proposed by Doron (2003) as features on the heads  $v$  and Voice. One drawback of this approach is that features such as [CAUS] and [APPL], which are spelled out as templates in a fashion similar to the Trivalent account, do not have predictable syntactic or semantic properties; the causative feature does carry out any syntactic work (e.g. introducing an additional argument) or semantic work (e.g. introducing causative semantics) consistently. I believe that this specific work showcases what may well be the case in many other Semitic languages: that templates do not have syntactic and semantic requirements which are as stringent as those in Hebrew.

If that is the case, then a Trivalent analysis would not be suitable and a number of options would deserve a closer look. Maybe an Arad-style analysis would be more appropriate, where conjugation classes must be listed (beyond perhaps maintaining a Passive head and a Non-Active Voice head). Some work might alternatively be done by invoking semi-lexical roots similar to  $\sqrt{\text{ACTION}}$ . Or maybe “flavors” of *v* might be necessary after all (Wallace 2013), listing different verbalizers instead of making syntactic commitments, as with Al Kaabi & Ntelitheos’ features.

Generalizing beyond Semitic, a strong view restricting structure-building of verbs to *v*, Voice/*i*\* and Pass means there is no room for specialized heads such as Reflexive (Ahn 2015, cf. Spathas 2017a,b) or Reciprocal (Bruening 2004). There is also the question of languages with dedicated “slots” for different argument structure affixes, like the CARP template of Bantu and similar phenomena (Hyman 2003; Paster 2005). I believe that exploring this strong claim will lead to new discoveries and refute the dedicated-heads approaches (although tough talk comes cheap), aiming for a constrained and therefore more Minimalist inventory of functional heads. One reason for my optimism is that data which had received analysis in terms of lexicalist affix slots was later shown to be analyzable in more decompositional terms; here I have in mind the Nimboran debate between Inkelas (1993) and Noyer (1998).

It thus appears to be potentially useful to adopt this framework for additional languages and map out which heads and features are instantiated in which language. The heads were discussed in this section; features are the topic of the next section, which is also the last one of this book before concluding.

### 7.3 Features on Voice

The second question opening this chapter had to do with the inventory of features which might exist on *i*\*/*Voice*. It is interesting to note that virtually all work on the features of Voice assumes the [D] feature and/or phi-features.

In Hebrew, I have made the case that Voice can be [+D] as in Voice<sub>[+D]</sub>, [-D] as in Voice<sub>[-D]</sub> or not inherently valued as in Unspecified Voice. In principle, however, the architecture allows any syntactic feature to appear on Voice. Nothing in the theory prohibits Voice<sub>[wh]</sub>, for instance, which would require a *wh*-phrase in Spec,VoiceP. Now granted, any theory of syntax must stipulate in one way or another which features are possible on which functional elements. One way to restrict the theory is to require only UNINTERPRETABLE features (Chomsky 1995), being purely syntactic features, to exist on Voice. The EPP feature [D] is

one such feature. This kind of solution would rely on a certain view of which features are interpretable and which are not (the notion of uninterpretable features and whether they are necessary has itself been questioned in recent work, e.g. Preminger 2014).

Another issue that I have not addressed so far is the extent to which [D] really is an EPP feature. Even though I have referred to it as an EPP feature in passing – see Sections 1.3.1.1, 2.3.4 and 6.2.2 – the original characterization of the EPP on Voice by Chomsky (2000; 2001) cast it as the strong feature  $v^*$ , providing a landing site for arguments not selected by the head itself: a position for shifted objects in Spec, $v^*$ . In this strict sense, then, the EPP on T or contemporary Voice and the EPP on Chomskian  $v^*$  are not the same. Current theories that make use of [D] in order to regulate the syntactic projection of the external argument have a different conception of the EPP on  $v^*/$ Voice, converging on the STRONG FEATURE use of Adger (2003). See Adger & Svenonius (2011) for related general discussion.

If [D] is a feature like all others, or at least an EPP feature like the one often postulated on T, then we would be led to expect trivalent  $[\pm D]$  on T and perhaps other heads as usual. It is not clear whether such cases exist, in which case we would have additional reason to think that the verbal domain (i.e. VoiceP) is privileged in the ways it can introduce arguments (Grimshaw 2000; Wood & Marantz 2017). The existence of  $[-D]$  as a feature prohibiting Merge is also a theoretical innovation, although Harbour (2011; 2014) has already argued for the relevance of  $[-\alpha]$  features on logical as well as empirical grounds.<sup>3</sup>

Ideally, a theory of features on argument-introducing heads would be part of a general theory of argument structure, feeding processes such as case assignment and specifying the triggers for A-movement. Some recent theories do exactly that by recourse to [D] and phi-features.

### 7.3.1 Layering

Within the standard Layering approach, two sets of features have been associated with Voice. The first involves syntactic and semantic transitivity, as discussed in Chapter 6. The second is a set of phi-features (Schäfer 2008; 2012; 2017). These are used mainly to explain the behavior of reflexive/expletive pronouns such as French *se* or German *sich*, case assignment and agreement. Since Hebrew does not have expletives such as these, I have not invoked phi-features alongside  $[\pm D]$ .

---

<sup>3</sup>The idea of a feature on specific heads banning merge might be reminiscent of the anti-locality account of Grohmann (2003), and see also Baier (2018), although the details differ considerably.

- (16) Features of Voice under Layering:
- a. [D] regulating Spec,VoiceP.
  - b.  $\lambda x/\exists x/\emptyset$  regulating the semantics of the external argument (if any).
  - c. Phi-features regulating case assignment (primarily with expletives).

In this theory, [D] is still the feature regulating most of the argument structure; the discussion is mostly based on data from Germanic and Romance.

### 7.3.2 Restriction

Legate (2012; 2014) presents a different theory, one in which phi-features on Voice serve to Restrict the arguments with which they are associated. RESTRICT is meant in both an intuitive sense and in the formal sense of Chung & Ladusaw (2004): a 3rd person specification on Voice means that a 2nd person argument will not be possible. The bundle of phi-features may appear either on Voice or in Spec,VoiceP (instead of a regular external argument). Object licensing features are generated on Voice and inherited by *v*.

If the features are on Voice, they serve to restrict the Agent. This can be either the subject of an active clause (merged in Spec,VoiceP), or the Agent of a passive clause, regardless of whether it is implied or overt in a *by*-phrase.<sup>4</sup> Crosslinguistically, these features appear overtly as a prefix denoting person and familiarity on the verb (in Acehnese), as a dedicated form of the passive prefix alternating according to number (in Chamorro), or as a specific suffix for 3SG passive verbs (in Balinese).

If the features are merged in Spec,VoiceP they can only restrict the DP in the *by*-phrase of a passive and are covert (in Ukrainian and the Icelandic New Passive). This is a kind of Weak Implicit Argument in the terminology of Landau (2010).

Impersonal constructions are analyzed as structures in which a silent pronoun in Spec,VoiceP has both a [D] feature and phi-features; this is essentially *pro*, or the Strong Implicit Argument of Landau (2010).

- (17) Features of Voice under the Restriction Theory inspired by Acehnese:
- a.  $\lambda x$  for Agent semantics.
  - b. Phi-features restricting the Agent.
  - c. Phi-features can be merged either directly on Voice (overt) or in Spec, VoiceP (covert).

---

<sup>4</sup>The exact mechanics require existential closure to apply to the Agent role if no *by*-phrase appears, but this issue arises for all mainstream analyses of the passive; see Williams (2015) for background.

In this theory, phi-features regulate argument structure, at least in the relevant constructions. The data come from three Austronesian languages (features on Voice) and from Ukrainian and Icelandic (features on Spec,VoiceP).

### 7.3.3 Restructuring

Another kind of theory was proposed by Wurmbrand & Shimamura (2017). For them, Voice has two main sets of features. VOICE FEATURES regulate whether the clause is active or passive, and introduce Agent/Causer semantics. Voice also carries *phi-features* which may be inserted valued or unvalued. And Voice is responsible for object licensing (ACC) as well.

In an active clause, unvalued phi-features on Voice need to be valued by the external argument DP. Its merger is thus triggered by the phi-features and not by the feature Voice[AGENT]. In a passive clause, Voice carries valued phi-features as proposed by Legate (2014) and the PASS feature. Feature checking between Voice and v/V spells out the appropriate participial morphology on V (in English), and incorporation of v/V to Voice results in affixal morphology.

This is the basic architecture. Things get interesting when Wurmbrand & Shimamura (2017) propose to incorporate restructuring into their theory. This happens if Voice is unvalued for the Voice feature, i.e. gets merged without an AGENT or PASS feature, in another sort of trivalent setup. The unvalued phi-features on Voice will then be valued by the higher Agent/Voice. Importantly for this analysis, there is also a V feature on v which needs to be valued. There are two possibilities for how this is accomplished, each predicting a different kind of restructuring language (voice matching languages and default voice languages). Empirical details aside, the main contribution of this work to the general issue of Voice lies in bringing in considerations from long object movement and restructuring, motivating a series of agreement interactions between Voice, v, V and higher elements in the clause.

- (18) Features relevant to Voice under the Restructuring-inspired Theory:
- a. AGENT/PASSIVE/ $\emptyset$  on Voice.
  - b. Valued or unvalued phi-features on Voice.
  - c. V feature on v.

Feature valuation regulates argument structure. Since the focus of this work was on accounting for restructuring patterns in languages as diverse as Acehnese, Chamorro, Japanese and Mayrinax Atayal, the combinatorics of the theory were not investigated in full.

### 7.3.4 Valuation

The final theory to be mentioned here is the Trivalent Valuation Theory developed by Nie (2017). Following cues from all this recent work, including the Trivalent proposal, Nie proposes that Voice carries a trivalent [D] feature and phi-features. Taking a page out of Wurmbrand & Shimamura's playbook, she assumes that features may be LEXICAL (inherent, merged as-is) or DERIVED, i.e. valued in the course of the derivation. Nie then explores this idea in detail, making the case for a lexical [ $\pm$ D] feature, regulating the external argument, and derived phi-features, which are normally valued by the internal argument but which may remain unvalued. This combination allows her, first, to apply the Trivalent approach to additional languages. For example, she analyzes Niuean and the Formosan language Puyuma as exhibiting the Trivalent distinction:

(19) Puyuma (Formosan; Nie 2017)

- a. Voice<sub>[+D]</sub> is marked with an infix; obligatory external argument.  
*s<em>a-senay i baeli.*  
 <AV>-sing NOM.SG my.elder.sibling  
 'My elder sister is/was singing.' (Teng 2007: 68)
- b. Unmarked Voice is spelled out by a prefix; optional external argument.  
*mu-atel la na ladru (dra balri).*  
 MU-fall PERF NOM.DEF mango OBL.IND wind  
 'The mango fell. / Wind made the mango fall.' (Chen & Fukuda 2017: 5)
- c. Voice<sub>[-D]</sub> is unmarked morphologically.  
*drua nantu lalak.*  
 came her.NOM child  
 'Her child came.' (Teng 2007: 222)

Second, the Austronesian distinction between what are traditionally called Agent Voice and Patient Voice can be seen as a difference in transitivity, and hence is analyzed as a difference in phi-features. In these languages, the pivot receives privileged marking: nominative in Puyuma, as in (20), or *ang* in Tagalog.

- (20) a. *tr<em>akaw dra paisu i Isaw.*  
 <AV>steal OBL.IND money NOM.SG Isaw  
 'Isaw stole money.'



- b. tu=trakaw-aw na       paisu kan Isaw.  
 3.GEN=steal-PV NOM.DEF money OBL.SG Isaw  
 ‘Isaw stole the money.’

Both Agent Voice and Patient Voice are assumed to be reflexes of Voice<sub>[+D]</sub> (see Nie 2017 for details on the other “Voices”). However, the choice *between* them depends on the case and agreement properties of the internal argument. If the internal argument values the phi-features on *v*, then it is marked as the pivot. These phi-features are then transferred from *v* to Voice, valuing Voice. This is “Patient Voice”. If the internal argument does not agree with *v*, then *v* does not transfer phi-features to Voice. Instead, Voice has them valued by the external argument, with predictable consequences: Voice gets “Agent Voice” and the subject is marked as pivot. Nie (2017) equates this kind of interaction with patterns of case and agreement in ergative languages and with DOM effects in nominative languages. She argues, for example, that a similar difference in transitivity marking explains the distribution of the object marker *-o* and transitive morphology in Japanese.

- (21) Features of Voice under the Valuation Theory:
- a. [D] regulates the licensing of an external argument.
  - b. Phi-features on Voice can be valued from either below (internal argument) or above (external argument).

Broadly speaking, [D] regulates argument structure and the phi-features regulate case and agreement marking.

### 7.3.5 Towards a uniform inventory

Where does this proliferation of recent theories leave us? It seems unlikely to me that the Trivalent proposal can be restated in terms of approaches that do not assume Trivalent Voice. While many parts of the current approach are compatible with translation to phi-features, others are less so: the restriction enforced by Voice<sub>[-D]</sub> is not one that can be easily captured in terms of phi-features on Voice, unless it is specified that these features can only be valued by the *internal* argument. Similarly, Unspecified Voice (or *XaYaZ*) cannot be the deterministic spell-out of configurations whose phi-features are at times valued by an external argument and at times are not valued (or are valued by the internal argument).

Generally speaking, the question whether a unified account of all these Voice-related phenomena would be possible is still open (Wurmbbrand & Shimamura 2017: 191fn12). The various approaches to the content of Voice have converged on

[D] and phi-features being the most important pieces in the syntax, with various possible interactions with case and agreement. How much or how little of each is needed, what other possible values of Voice might be relevant, and what elements we expect to be overt are questions that will likely occupy syntacticians for some time to come.

## 7.4 Conclusion

This book set out to analyze the verbal system of Hebrew in a way that is formally explicit, internally consistent, and easily translatable to accounts implemented for other languages and phenomena. The basic idea was that a core vP can be modified by an agentive modifier (or not) and combined with a Voice head specified as [+D], specified as [-D], or unspecified for [D]. As a result, what looks like templates and alternations between templates in Hebrew can be reduced to the interpretation of well-understood syntactic structures by the semantics and the phonology (fed by some idiosyncrasy associated with lexical roots). The templates have been decomposed.

In my inherently biased view these goals have been reached; the generalizations, analyses and predictions of Part I were summarized at the outset of this chapter. Where possible, the connection to the phonology was also elaborated on. And Part II laid out how I see this theory's place in the current landscape of theories investigating argument structure. I will conclude with some open questions for research, followed by a few final words.

### 7.4.1 Open questions

The study of Hebrew does not conclude with this book, of course; even if everything I proposed were correct – which it is surely not – there would still remain many open questions for the study of this language and Semitic as a whole, not to mention argument structure in general. Here are the most pressing ones.

First, the data and generalizations. Even though I have tried to base my generalizations on as much data as possible, I was not always able to quantitatively examine the entire verbal lexicon of Hebrew. When this was possible, as with *niXYaZ* in Section 3.2 or *heXYiZ* in Section 4.2, I have provided exact counts. But it is important to keep in mind that even these numbers cannot be considered authoritative, since the way I classify a given verb might be different than another analyst's. The trailblazing works of Doron (2003) and Arad (2005) make it clear just how much variation one can find between different roots; so when I suggest that verbs in *hitXaYeZ* are unambiguous between readings whereas those

in *niXYaZ* might be associated with different readings, the door is always open for counterexamples.

This is particularly the case given that a few such observations are not predicted by the current system. I have no explanation to offer for this difference between *hitXaYeZ* and *niXYaZ*. Furthermore, *niXYaZ* verbs allow for passive readings but those in *hitXaYeZ* might not. While I can encode this difference in the rules of semantic interpretation, I have not offered an explicit analysis.

Zooming out even more, one major component of the system which has been relegated to arbitrary listing in the current theory is the role of roots. Formally, I have not provided an explicit theory of how a given root licenses a given functional head (or vice versa) beyond encoding co-occurrence in VI lists. And empirically, even though authors throughout the ages have emphasized that Semitic roots are simply idiosyncratic, a number of possible avenues for further exploration remain. Here and there I have noted places where the lexical semantics of the root seems to influence its place in a formal ontology. These include the pluractional events of *XiYeZ*, the divide between anticausatives and reflexives in *hitXaYeZ*, the degree achievements and the forms of causation in *heXYiZ*, the change-of-state adjectival passives of Section 5.2, and quite clearly the passives in *niXYaZ*. It remains to be seen whether other cases can be attributed to the lexical semantics of the underlying event (Kastner 2016: 114).

Similarly, the question of root meaning in general is one we are only beginning to scratch the surface of. I will not belabor the point here, as it has recently come back to the fore; see Harley (2014a) for a good starting point and Kastner & Tucker (submitted) for an outline of the current state of affairs. Beyond formal work, computational modeling might provide new insights into how roots cluster in an abstract n-dimensional space.

Finally, looking beyond theoretical analyses, we would ideally like to know how well our formal accounts allow us to understand processing, neurophysiological behavior and acquisition. In all cases the level of formal analyses has been far more detailed than the level of granularity currently tracked in these allied fields. Nevertheless, Kastner et al. (2018) have attempted to generate predictions from this kind of decompositional approach in a neurolinguistic experiment on Hebrew, and the work of Frost et al. (1997), Moscoso del Prado Martín et al. (2005), Deutsch & Kuperman (2018) and colleagues can facilitate further work probing more specific theories of roots. Hebrew is no stranger to the developmental literature either (Berman 1982; 1993; Ashkenazi et al. 2016; Ravid et al. 2016; Havron & Arnon 2017, a.m.o), but even there discussion based on contemporary theories has not relied on formal specifics (Borer 2004; Kastner & Adriaans 2018). Yet.

### 7.4.2 Epilogue: From templates to heads

Morphological systems like the templatic system of Hebrew pose an immediate puzzle for formal analyses: the mapping between form and meaning is not one-to-one, with phonology, morphology, syntax and semantics intertwining in ways which seem to defy explanation. It has traditionally been assumed that each template is simply its own construction, and that relations hold – sometimes – between specific templates. This view, in which each template is in effect its own morpheme, is unsatisfactory, leaving more questions than answers. Why does a given template have the meanings it has, and not others? Why do two (or three, or four) templates stand in an “alternation”? What does the morphology actually track?

And so a new wave of analyses emerged on the scene, which in my mind were no less than visionary. These accounts attempted to decompose the templates and see what made them tick. Maya Arad’s theory of Hebrew was explicit about how this can be done, but ultimately unsatisfactory because it had to rely on extrinsically listing alternations between semantic atoms which had no grounding in the morphology. Edit Doron’s theory was explicit about how the semantic primitives might combine but lacked clear syntactic underpinnings, and furthermore was not fully committed to mapping these elements to the morphology. So we needed a modern morphophonemics of Hebrew, if you will.

In this book, I have proposed a formal theory of argument structure which explains why each “template” is the way it is, and why templates stand in certain relationships to each other. The account ended up looking a lot like accounts of other phenomena and languages within the same framework. The fact that one can understand crosslinguistic variation in more concrete terms – for example, the phonological constraints that linearize the same structures might look different in Semitic than in non-Semitic languages – is, to me, a clear sign of progress. And even though we still need to understand exactly how lexical information fits into the rigid syntax, the resulting picture is one which is fairly easy to navigate: the syntax generates, and the interfaces interpret.

## References

- Adam, Galit. 2002. *From variable to optimal grammar: Evidence from language acquisition and language change*. Tel Aviv: Tel Aviv University. (Doctoral dissertation).
- Adger, David. 2003. *Core syntax: A Minimalist approach*. Oxford: Oxford University Press.
- Adger, David & Peter Svenonius. 2011. Features in Minimalist syntax. In Cedric Boeckx (ed.), *The handbook of linguistic Minimalism*, 27–51. Oxford: Blackwell.
- Ahdout, Odelia. in prep. *Nominalizations in Hebrew and beyond*. Berlin: Humboldt-Universität zu Berlin. (Doctoral dissertation).
- Ahdout, Odelia. to appear. Agent exclusivity effects in Hebrew nominalizations. In Elitzur Bar-Asher Siegal & Nora Boneh (eds.), *Perspectives on causation*. Dordrecht: Springer.
- Ahdout, Odelia. 2019. No results with middles: On non-eventive readings in Hebrew nominalizations. In *GLOW 42*.
- Ahdout, Odelia & Itamar Kastner. 2019. Non-active verbs in Hebrew and the input to nominalization. In Maggie Baird, Duygu Göksu & Jonathan Pesetsky (eds.), *Proceedings of NELS 49*. Amherst, MA: GLSA.
- Ahn, Byron. 2015. *Giving reflexivity a voice: Twin reflexives in English*. Los Angeles, CA: University of California, Los Angeles. (Doctoral dissertation).
- Akkus, Faruk. 2019. Variable embedded agent in Sason Arabic. Ms., UPenn. linguibuzz/004341.
- Al Kaabi, Meera & Dimitrios Ntelitheos. 2019. Rethinking templates: A syntactic analysis of verbal morphology in Emirati Arabic. *Glossa* 4(1). DOI: 10.5334/gjgl.428.
- Alexiadou, Artemis. 2001. *Functional structure in nominals: Nominalization and ergativity*. Philadelphia, PA: John Benjamins.
- Alexiadou, Artemis. 2008. Tense marking in the nominal domain: Implications for grammar architecture. In Jeroen Van Craenenbroeck (ed.), *Linguistic variation yearbook*, 33–60. Amsterdam/Philadelphia: John Benjamins.
- Alexiadou, Artemis. 2009. On the role of syntactic locality in morphological processes: The case of (Greek) derived nominals. In Anastasia Giannakidou

## References

- & Monika Rathert (eds.), *Quantification, definiteness and nominalization*, 253–280. Oxford: Oxford University Press.
- Alexiadou, Artemis. 2010. Nominalizations: A probe into the architecture of grammar. Part II: The aspectual properties of nominalizations, and the lexicon vs. syntax debate. *Language and Linguistics Compass* 4(7). 512–523.
- Alexiadou, Artemis. 2014. Roots in transitivity alternations: *afto/ auto* reflexives. In Artemis Alexiadou, Hagit Borer & Florian Schäfer (eds.), *The syntax of roots and the roots of syntax*, 57–80. Oxford: Oxford University Press.
- Alexiadou, Artemis. 2017. Ergativity in nominalization. In Jessica Coon, Diane Massam & Lisa deMena Travis (eds.), *The Oxford handbook of ergativity*, 355–372. Oxford: Oxford University Press.
- Alexiadou, Artemis & Elena Anagnostopoulou. 2004. Voice morphology in the causative-inchoative alternation: Evidence for a non-unified structural analysis of unaccusatives. In Artemis Alexiadou, Elena Anagnostopoulou & Martin Everaert (eds.), *The unaccusativity puzzle: Explorations of the syntax-lexicon interface*, 114–136. Oxford: Oxford University Press.
- Alexiadou, Artemis, Elena Anagnostopoulou & Florian Schäfer. 2006a. The fine structure of (anti-)causatives. In Chris Davis, Amy Rose Deal & Youri Zabbal (eds.), *Proceedings of NELS 36*, 115–128. Amherst, MA: GLSA.
- Alexiadou, Artemis, Elena Anagnostopoulou & Florian Schäfer. 2006b. The properties of anticausatives crosslinguistically. In Mara Frascarelli (ed.), *Phases of interpretation*, 187–211. Berlin: Mouton de Gruyter.
- Alexiadou, Artemis, Elena Anagnostopoulou & Florian Schäfer. 2015. *External arguments in transitivity alternations: A layering approach*. Oxford: Oxford University Press.
- Alexiadou, Artemis, Mariangeles Cano, Gianina Iordăchioaia, Fabienne Martin & Florian Schäfer. 2013. “Direct participation” and “agent exclusivity” effects in derived nominals and beyond. In Gianina Iordăchioaia, Isabelle Roy & Kaori Takamine (eds.), *Categorization and category change*, 153–180. Newcastle upon Tyne: Cambridge Scholars Publishing.
- Alexiadou, Artemis & Edit Doron. 2012. The syntactic construction of two non-active Voices: Passive and middle. *Journal of Linguistics* 48. 1–34.
- Alexiadou, Artemis, Berit Gehrke & Florian Schäfer. 2014. The argument structure of adjectival participles revisited. *Lingua* 149. 118–138.
- Alexiadou, Artemis, Gianina Iordăchioaia, Mariángeles Cano, Fabienne Martin & Florian Schäfer. 2013. The realization of external arguments in nominalizations. *The Journal of Comparative Germanic Linguistics* 16(2/3). 73–95. DOI: 10.1007/s10828-014-9062-x.

- Alexiadou, Artemis & Florian Schäfer. 2011. *There*-insertion: An unaccusativity mismatch at the syntax-semantics interface. In Mary Byram Washburn, Sarah Ouwayda, Chuoying Ouyang, Bin Yin, Canan Ipek, Lisa Marston & Aaron Walker (eds.), *Online proceedings of WCCFL 28*.
- Anagnostopoulou, Elena. 2014. Roots and domains. *Theoretical Linguistics* 40(3/4). 299–310.
- Anagnostopoulou, Elena & Yota Samioti. 2013. Allosemy, idioms and their domains: Evidence from adjectival participles. In Raffaella Folli, Christina Sevdali & Robert Truswell (eds.), *On linguistic interfaces*, 2nd edn., 218–250. Oxford: Oxford University Press.
- Anagnostopoulou, Elena & Yota Samioti. 2014. Domains within words and their meanings: A case study. In Artemis Alexiadou, Hagit Borer & Florian Schäfer (eds.), *The syntax of roots and the roots of syntax*, 81–111. Oxford: Oxford University Press.
- Arad, Maya. 2003. Locality constraints on the interpretation of roots: The case of Hebrew denominal verbs. *Natural Language & Linguistic Theory* 21. 737–778.
- Arad, Maya. 2005. *Roots and patterns: Hebrew morpho-syntax*. Dordrecht: Springer.
- Ariel, Mira, Elitzur Dattner, John W. Du Bois & Tal Linzen. 2015. Pronominal datives: The royal road to argument status. *Studies in Language* 39(2). 257–321.
- Aronoff, Mark. 1994. *Morphology by itself: Stems and inflectional classes*. Cambridge, MA: MIT Press.
- Aronoff, Mark. 2007. In the beginning was the word. *Language* 83(4). 803–830.
- Ashkenazi, Orit, Dorit Ravid & Steven Gillis. 2016. Breaking into the Hebrew verb system: A learning problem. *First Language* 36(5). 505–524. DOI: 10.1177/0142723716648865.
- Baier, Nicholas. 2018. *Anti-agreement*. Berkeley, CA: University of California, Berkeley. (Doctoral dissertation).
- Baker, Mark. 1985. The mirror principle and morphosyntactic explanation. *Linguistic Inquiry* 16(3). 373–415.
- Baker, Mark. 1988. *Incorporation: A theory of grammatical function changing*. Chicago: University of Chicago Press.
- Baker, Mark, Kyle Johnson & Ian Roberts. 1989. Passive arguments raised. *Linguistic Inquiry* 20(2). 219–251.
- Bar-Asher Siegal, Elitzur. 2016. The Semitic templates from the perspective of reciprocal predicates. In Jenny Audring, Francesca Masini & Wendy Sandler (eds.), *Proceedings of the 10th Mediterranean morphology meeting (MMM 10)*, 16–30.

## References

- Bar-Asher Siegal, Elitzur & Nora Boneh. 2015. Decomposing affectedness: Truth-conditional non-core datives in Modern Hebrew. In Nurit Melnik (ed.), *Proceedings of the 30th annual conference of the Israel association for theoretical linguistics (IATL 30)*, 1–23. MIT Press.
- Bar-Asher Siegal, Elitzur & Nora Boneh. 2016. Discourse update at the service of mirativity effects: The case of the discursive Dative. In Mary Moroney, Carol-Rose Little, Jacob Collard & Dan Burgdorf (eds.), *Proceedings of the 26th semantics and linguistic theory conference*, 103–121. LSA: LSA & CLC Publications.
- Bar-Asher Siegal, Elitzur & Nora Boneh. 2019. Sufficient and necessary conditions for a non-unified analysis of causation. In Richard Stockwell, Maura O’Leary, Zhongshi Xu & Z.L. Zhou (eds.), *Proceedings of the 36th West Coast conference on formal linguistics (WCCFL)*, 55–60. Somerville, MA: Cascadilla Press.
- Bat-El, Outi. 1989. *Phonology and word structure*. Los Angeles, CA: UCLA. (Doctoral dissertation).
- Bat-El, Outi. 1994. Stem modification and cluster transfer in Modern Hebrew. *Natural Language & Linguistic Theory* 12. 571–596. DOI: 10.1007/BF00992928.
- Bat-El, Outi. 2002. True truncation in colloquial Hebrew imperatives. *Language* 78. 651–683.
- Bat-El, Outi. 2003. The fate of the consonantal root and the binyan in Optimality Theory. *Recherches Linguistiques de Vincennes* 32. 31–60.
- Bat-El, Outi. 2017. Word-based items-and processes (WoBIP): Evidence from Hebrew morphology. In Claire Bowerman, Laurence Horn & Raffaella Zanuttini (eds.), *On looking into words (and beyond)*, 115–135. Berlin: Language Science Press. DOI: 10.5281/zenodo.495441.
- Beavers, John & Andrew Koontz-Garboden. 2012. Manner and result in the roots of verbal meaning. *Linguistic Inquiry* 43(3). 331–369.
- Béjar, Susana & Milan Rezac. 2009. Cyclic Agree. *Linguistic Inquiry* 40(1). 35–73.
- Belletti, Adriana & Luigi Rizzi. 1988. Psych verbs and theta-theory. *Natural Language & Linguistic Theory* 6. 291–352.
- Berman, Ruth. 1978. *Modern Hebrew structure*. Tel Aviv: University of Tel Aviv Publishing Projects.
- Berman, Ruth. 1982. Verb-pattern alternation: The interface of morphology, syntax and semantics in Hebrew. *Journal of Child Language* 9. 169–191. DOI: 10.1017/S030500090000369X.
- Berman, Ruth. 1993. Marking of verb transitivity by Hebrew speaking children. *Journal of Child Language* 20. 1–28. DOI: 10.1017/S0305000900008527.
- Bhatt, Rajesh & Roumyana Pancheva. 2017. Implicit arguments. In Martin Everaert & Henk C. van Riemsdijk (eds.), *The Blackwell companion to syntax*, 2nd edn. London: Blackwell.



- Bittner, Maria. 1999. Concealed causatives. *Natural Language Semantics* 7(1). 1–78. DOI: 10.1023/a:1008313608525.
- Blanco, Mercedes Tubino. 2011. *Causatives in Minimalism* (Linguistik Aktuell 179). Amsterdam/Philadelphia: John Benjamins.
- Bobaljik, Jonathan D. 2012. *Universals in comparative morphology*. Cambridge, MA: MIT Press.
- Bolozky, Shmuel. 1978. Word formation processes in the Hebrew verb system: Denominative verbs. *Afroasiatic Linguistics* 5. 1–26.
- Bolozky, Shmuel. 1999. *Measuring productivity in word formation: The case of Israeli Hebrew*. New York, NY: Brill.
- Boneh, Nora. 2013. Tense: Modern Hebrew. In Geoffrey Khan (ed.), *Encyclopedia of Hebrew language and linguistics*. Leiden: Brill.
- Boneh, Nora & Léa Nash. 2017. The syntax and semantics of dative DPs in Russian ditransitives. *Natural Language & Linguistic Theory* 35(4). 899–953. DOI: 10.1007/s11049-017-9360-5.
- Bonet, Eulàlia. 1991. *Morphology after syntax: Pronominal clitics in Romance*. Cambridge, MA: Massachusetts Institute of Technology. (Doctoral dissertation).
- Bonet, Eulàlia & Daniel Harbour. 2012. Contextual allomorphy. In Jochen Trommer (ed.), *The morphology and phonology of exponence*, 195–235. Oxford: Oxford University Press.
- Bopp, Franz. 1826. Vergleichende Zergliederung des Sanskrits und der mit ihm verwandten Sprachen. Erste Abhandlung. Von den Wurzeln und Pronomina erster und zweiter Person. 117–148.
- Borer, Hagit. 1991. The causative-inchoative alternation: A case study in Parallel Morphology. *The Linguistic Review* 8. 119–158.
- Borer, Hagit. 1995. The ups and downs of Hebrew verb movement. *Natural Language & Linguistic Theory* 13(3). 527–606.
- Borer, Hagit. 1998. Deriving passive without theta roles. In Steven G. Lapointe, Diane K. Brentari & Patrick M. Farrell (eds.), *Morphology and its relations to phonology and syntax*, 60–99. Stanford, CA: CSLI Publications.
- Borer, Hagit. 2004. The grammar machine. In Artemis Alexiadou, Elena Anagnostopoulou & Martin Everaert (eds.), *The unaccusativity puzzle: Explorations of the syntax-lexicon interface*, 288–331. Oxford: Oxford University Press.
- Borer, Hagit. 2005. *Structuring sense, vol. 2: The normal course of events*. Oxford: Oxford University Press.
- Borer, Hagit. 2013. *Structuring sense, vol. 3: Taking form*. Oxford: Oxford University Press.
- Borer, Hagit. 2014a. Derived nominals and the domain of content. *Lingua* 141. 71–96.

## References

- Borer, Hagit. 2014b. Wherefore roots? *The Linguistic Review* 40. 343–359.
- Borer, Hagit. 2015. Beyond roots. In *Roots IV, New York University*.
- Borer, Hagit & Yosef Grodzinsky. 1986. Syntactic cliticization and lexical cliticization: The case of Hebrew dative clitics. In Hagit Borer (ed.), *Syntax and semantics*, vol. 19, 175–217. New York: Academic Press.
- Borer, Hagit & Kenneth Wexler. 1987. The maturation of syntax. In Thomas Roeper & Edwin Williams (eds.), *Parameter setting* (Studies in Theoretical Psycholinguistics), 123–172. Dordrecht: Springer.
- Bowers, John. 1993. The syntax of predication. *Linguistic Inquiry* 24. 591–656.
- Bowers, John. 2001. Predication. In Mark Baltin & Chris Collins (eds.), *The handbook of contemporary syntactic theory*, 299–333. Oxford: Blackwell.
- Brice, Henry. 2016. The root and word distinction: An experimental study of Hebrew denominal verbs. *Morphology* 27. 159–177.
- Bruening, Benjamin. 2004. Verbal reciprocals. In B. Lyngfelt T. Solstad & M. F. Krave (eds.), *Demoting the agent: Proceedings of the Oslo workshop on passive and other voice-related phenomena*, 3–12. Oslo: University of Oslo.
- Bruening, Benjamin. 2013. By phrases in passives and nominals. *Syntax* 16. 1–41.
- Bruening, Benjamin. 2014. Word formation is syntactic: Adjectival passives in English. *Natural Language & Linguistic Theory* 32(2). 363–422.
- Burzio, Luigi. 1986. *Italian syntax*. Dordrecht: Reidel.
- Chen, Victoria & Shin Fukuda. 2017. Re-labeling “ergative”: Evidence from Formosan. In *Proceedings of AFLA 23*, 50–64.
- Choi, Jaehoon & Heidi Harley. 2019. Locality domains and morphological rules: Phases, heads, node-sprouting and suppletion in Korean honorification. *Natural Language & Linguistic Theory* 37. 1319–1365.
- Chomsky, Noam. 1951. *Morphophonemics of Modern Hebrew*. Philadelphia, PA: University of Pennsylvania. (MA thesis).
- Chomsky, Noam. 1970. Remarks on nominalization. In Roderick A. Jacobs & Peter S. Rosenbaum (eds.), *Readings in English transformational grammar*, 184–221. Waltham, MA: Ginn.
- Chomsky, Noam. 1995. *The minimalist program*. Cambridge, MA: MIT Press.
- Chomsky, Noam. 2000. Minimalist inquiries: The framework. In Roger Martin, David Michaels & Juan Uriagereka (eds.), *Step by step: Essays on Minimalist syntax in honor of Howard Lasnik*, 89–155. Cambridge, MA: MIT Press.
- Chomsky, Noam. 2001. Derivation by phase. In Michael Kenstowicz (ed.), *Ken Hale: A life in language*, 1–52. Cambridge, MA: MIT Press.
- Chung, Sandra & William A. Ladusaw. 2004. *Restriction and saturation*. Cambridge, MA: MIT Press.

- Cole, Peter & S. N. Sridhar. 1977. Clause union and Relational Grammar: Evidence from Hebrew and Kannada. *Linguistic Inquiry* 8(4). 700–713.
- Cuervo, María Cristina. 2014. Alternating unaccusatives and the distribution of roots. *Lingua* 141. 48–70.
- Danon, Gabi. 2001. Syntactic definiteness in the grammar of Modern Hebrew. *Linguistics* 39(6). 1071–1116.
- Darden, Bill. 1992. The Cairene Arabic verb without form classes. In Diane Brentari, Gary N. Larson & Lynn A. MacLeod (eds.), *The joy of grammar*, 11–24. Amsterdam/Philadelphia: John Benjamins.
- de Sacy, Sylvestre Antoine Isaac. 1810. *Grammaire arabe à l'usage des élèves de l'école spéciale des langues orientales vivantes*. Paris: Imprimerie Royale.
- Deal, Amy Rose. 2015. Interaction and satisfaction in  $\phi$ -agreement. In Thuy Bui & Deniz Özyıldız (eds.), *Proceedings of NELS 45*, 179–192. Amherst, MA: GLSA.
- Deal, Amy Rose. 2019. Raising to ergative: Remarks on applicatives of unaccusatives. *Linguistic Inquiry* 50(2). 388–415. DOI: 10.1162/ling\_a\_00310.
- Den Dikken, Marcel. 2003. On the syntax of locative and directional adpositional phrases. Ms., CUNY.
- Den Dikken, Marcel. 2010. Directions from the GET-GO. *Catalan Journal of Linguistics* 9. 23–53.
- Deutsch, Avital. 2016. The separability of morphological processes from semantic meaning and syntactic class in production of single words: Evidence from the Hebrew root morpheme. *Journal of Psycholinguistic Research* 45. 1–28.
- Deutsch, Avital & Victor Kuperman. 2018. Formal and semantic effects of morphological families on word recognition in Hebrew. *Language, Cognition and Neuroscience* 34(1). 87–100. DOI: 10.1080/23273798.2018.1513541.
- Deutsch, Avital, Hadas Velan & Tamar Michaly. 2016. Decomposition in a non-concatenated morphological structure involves more than just the roots: Evidence from fast priming. *The Quarterly Journal of Experimental Psychology* 71(1). 85–92. DOI: 10.1080/17470218.2016.1250788.
- Doron, Edit. 2000. *habeynoni hasavil* [The passive participle]. *Balshanut Ivrit [Hebrew Linguistics]* 47. 39–62.
- Doron, Edit. 2003. Agency and voice: The semantics of the Semitic templates. *Natural Language Semantics* 11. 1–67. DOI: 10.1023/A:1023021423453.
- Doron, Edit. 2013. Participle: Modern Hebrew. In Geoffrey Khan (ed.), *Encyclopedia of Hebrew language and linguistics*. Leiden: Brill.
- Doron, Edit. 2014. The interaction of adjectival passive and voice. In Artemis Alexiadou, Hagit Borer & Florian Schäfer (eds.), *The syntax of roots and the roots of syntax*, 164–191. Oxford: Oxford University Press.

## References

- Doron, Edit. 2015. Voice and valence change. In Artemis Alexiadou & Tibor Kiss (eds.), *Syntax: Theory and analysis*, vol. 1, 749–776. Berlin: Walter de Gruyter.
- Doron, Edit & Geoffrey Khan. 2016. The morphosyntax of definiteness agreement in Neo-Aramaic and Central Semitic. In Jenny Audring, Francesca Masini & Wendy Sandler (eds.), *Proceedings of the 10th Mediterranean morphology meeting (MMM 10)*, 45–54.
- Dowty, David. 1991. Thematic proto-roles and argument selection. *Language* 67. 547–619.
- Ehrenfeld, Lior. 2012. *The morphology of the Hebrew causative alternation*. Jerusalem: Hebrew University of Jerusalem. (MA thesis).
- Embick, David. 2004a. On the structure of resultative participles in English. *Linguistic Inquiry* 35(3). 355–392.
- Embick, David. 2004b. Unaccusative syntax and verbal alternations. In Artemis Alexiadou, Elena Anagnostopoulou & Martin Everaert (eds.), *The unaccusativity puzzle: Explorations of the syntax-lexicon interface*, 137–158. Oxford: Oxford University Press.
- Embick, David. 2010. *Localism versus globalism in morphology and phonology* (Linguistic Inquiry Monographs 60). Cambridge, MA: MIT Press.
- Embick, David & Rolf Noyer. 2001. Movement operations after syntax. *Linguistic Inquiry* 32(4). 555–595.
- Engelhardt, Miriam. 2000. The projection of argument-taking nominals. *Natural Language & Linguistic Theory* 18. 41–88.
- Enguehard, Guillaume & Noam Faust. 2018. Guttural ghosts in Modern Hebrew. *Linguistic Inquiry* 49(4). 685–721.
- Ewald, Georg Heinrich August. 1827. *Kritische Grammatik der hebräischen Sprache*. Leipzig: Hahn.
- Farkas, Donka. 1988. On obligatory control. *Linguistics and Philosophy* 11. 27–58.
- Faust, Noam. 2012. Non-concatenative realization in the verbal inflection of Modern Hebrew. *Morphology* 22(4). 453–484.
- Faust, Noam. 2016. Weak radicals, weak suppletion, and phonological indices in Semitic. *Morphology* 26(3). 379–397.
- Faust, Noam. 2018. Exponence, allomorphy and haplogy in the number and state morphology of Modern Hebrew. *Glossa* 3(1). DOI: 10.5334/gjgl.228.
- Faust, Noam. 2019. New reasons to root for the Semitic root from Mehri and Neo-Aramaic. *The Linguistic Review* 36(3). 575–599. DOI: 10.1515/tlr-2019-2030.
- Faust, Noam & Ya'ar Hever. 2010. Empirical and theoretical arguments in favor of the discontinuous root in Semitic languages. *Brill's Annual of Afroasiatic Languages and Linguistics* 20. 80–118.

- Fodor, Jerry. 1970. Three reasons for not deriving “kill” from “cause to die”. *Linguistic Inquiry* 16. 35–56.
- Folli, Raffaella & Heidi Harley. 2008. Teleology and animacy in external arguments. *Lingua* 118. 190–202.
- Frost, Ram, Kenneth I. Forster & Avital Deutsch. 1997. What can we learn from the morphology of Hebrew? A masked-priming investigation of morphological representation. *Journal of Experimental Psychology: Learning, Memory, and Cognition* 23(4). 829–856.
- Gafter, Roey. 2014a. “The most beautiful and correct Hebrew”: Authenticity, ethnic identity and linguistic variation in the greater Tel Aviv area. Stanford, CA: Stanford University. (Doctoral dissertation).
- Gafter, Roey. 2014b. The distribution of the Hebrew possessive dative construction: Guided by unaccusativity or prominence? *Linguistic Inquiry* 45(3). 482–500.
- Gehrke, Berit. 2008. *Ps in motion: On the semantics and syntax of P elements and motion verbs*. Utrecht: Utrecht University. (Doctoral dissertation).
- Gehrke, Berit & Cristina Marco. 2014. Different *by*-phrases with adjectival and verbal passives: Evidence from Spanish corpus data. *Lingua* 149. 188–214.
- Geniušienė, Emma. 1987. *The typology of reflexives*. Berlin: Mouton de Gruyter.
- Gesenius, F. H. W. 1813/1919. *Gesenius’ Hebrew grammar*. E. Kautzsch & A. E. Cowley Cowley (eds.). Oxford: Clarendon Press.
- Gouskova, Maria. 2012. Unexceptional segments. *Natural Language & Linguistic Theory* 30. 79–133.
- Gouskova, Maria. 2019. Phonological words in the syntax and the lexicon: A study of Russian prepositions. *Journal of Slavic Linguistics* 27(2). 161–211.
- Gouskova, Maria & Jonathan D. Bobaljik. Submitted. Allomorphy and vocabulary insertion. In Artemis Alexiadou, Ruth Kramer, Alec Marantz & Isabel Oltra Massuet (eds.), *The Cambridge handbook of Distributed Morphology*. Cambridge: Cambridge University Press.
- Gouskova, Maria, Luiza Newlin-Lukowicz & Sofya Kasyanenko. 2015. Selectional restrictions as phonotactics over sublexicons. *Lingua* 167. 41–81.
- Greenberg, Yael. 2010. Event internal pluractionality in Modern Hebrew: A semantic analysis of one verbal reduplication pattern. *Brill’s Annual of Afroasiatic Languages and Linguistics* 2(1). 119–164.
- Grestenberger, Laura. 2018. Deponency in finite and non-finite contexts. *Language* 94(3). 487–526.
- Grimshaw, Jane. 1990. *Argument structure*. Cambridge, MA: MIT Press.

## References

- Grimshaw, Jane. 2000. Locality and extended projection. In Peter Coopmans, Martin Everaert & Jane Grimshaw (eds.), *Lexical specification and insertion*, 115–133. Amsterdam/Philadelphia: John Benjamins.
- Grohmann, Kleanthes K. 2003. *Prolific domains: On the anti-locality of movement dependencies*. Amsterdam/Philadelphia: John Benjamins.
- Hale, Ken & Samuel Jay Keyser. 2002. *Prolegomenon to a theory of argument structure* (Linguistic Inquiry Monographs 39). Cambridge, MA: MIT Press.
- Halle, Morris & Alec Marantz. 1993. Distributed Morphology and the pieces of inflection. In Ken Hale & Samuel Jay Keyser (eds.), *The view from building 20: Essays in linguistics in honor of Sylvain Bromberger*, 111–176. Cambridge, MA: MIT Press.
- Harbour, Daniel. 2003. The Kiowa case for feature insertion. *Natural Language & Linguistic Theory* 21. 543–578.
- Harbour, Daniel. 2008. On homophony and methodology in morphology. *Morphology* 18. 75–92.
- Harbour, Daniel. 2011. Valence and atomic number. *Linguistic Inquiry* 42(4). 561–594.
- Harbour, Daniel. 2014. Paucity, abundance, and the theory of number. *Language* 90(1). 185–229. DOI: 10.1353/lan.2014.0003.
- Harley, Heidi. 2008. On the causative construction. In Shigeru Miyagawa & Mamoru Saito (eds.), *The Oxford handbook of Japanese linguistics*, 20–53. Oxford: Oxford University Press.
- Harley, Heidi. 2009. The morphology of nominalizations and the syntax of vP. In Monika Rathert & Anastasia Giannakidou (eds.), *Quantification, definiteness and nominalization*, 320–342. Oxford: Oxford University Press.
- Harley, Heidi. 2013a. External arguments and the Mirror Principle: On the distinctness of Voice and v. *Lingua* 125. 34–57.
- Harley, Heidi. 2013b. Getting morphemes in order: Affixation and head movement. In Lisa Lai-Shen Cheng & Norbert Corver (eds.), *Diagnosing syntax*, 44–74. Oxford: Oxford University Press.
- Harley, Heidi. 2014a. On the identity of roots. *Theoretical Linguistics* 40(3/4). 225–276.
- Harley, Heidi. 2014b. Reply to commentaries, “On the identity of roots”. *Theoretical Linguistics* 40(3/4). 447–474.
- Harley, Heidi. 2015. Hiaki verbal number suppletion really is suppletion. In *Roots IV, New York University*.
- Harley, Heidi. 2017. The “bundling” hypothesis and the disparate functions of little v. In Roberta D’Alessandro, Irene Franco & Ángel Gallego (eds.), *The verbal domain*, 3–28. Oxford: Oxford University Press.

- Harley, Heidi & Rolf Noyer. 2000. Formal versus encyclopedic properties of vocabulary: Evidence from nominalisations. In Bert Peeters (ed.), *The lexicon/encyclopaedia interface*, 349–374. Amsterdam/Philadelphia: Elsevier Press.
- Harley, Heidi & Megan S. Stone. 2013. The “No agent idioms” hypothesis. In Raffaella Folli, Christina Sevdali & Robert Truswell (eds.), *Syntax and its limits*, 283–311. Oxford: Oxford University Press.
- Harris, Zellig. 1941. Linguistic structure of Hebrew. *Journal of the American Oriental Society* 62. 143–167.
- Harves, Stephanie & Richard S. Kayne. 2012. Having ‘need’ and needing ‘have’. *Linguist Inquiry* 43(1). 120–132.
- Haspelmath, Martin. 1993. More on the typology of inchoative/causative verb alternations. In Bernard Comrie & Maria Polinsky (eds.), *Causatives and transitivity*, 87–120. Amsterdam/Philadelphia: John Benjamins.
- Havron, Naomi & Inbal Arnon. 2017. Minding the gaps: Literacy enhances lexical segmentation in children learning to read. *Journal of Child Language* 44. 1516–1538.
- Hay, Jennifer, Christopher Kennedy & Beth Levin. 1999. Scalar structure underlies telicity in “degree achievements”. In Tanya Mathews & Devon Strolovitch (eds.), *Proceedings of Semantics and Linguistic Theory (SALT IX)*, 127–144. CLC Publications.
- Hazout, Ilan. 1995. Action nominalizations and the lexicalist hypothesis. *Natural Language & Linguistic Theory* 13. 355–404.
- Heller, Daphna & Boaz Ben David. 2015. Morphological activation during spoken word recognition: Beyond sound and meaning? In *IATL* 31.
- Henderson, Robert. 2012. *Ways of pluralizing events*. Santa Cruz, CA: University of California, Santa Cruz. (Doctoral dissertation).
- Henderson, Robert. 2017. Swarms: Spatiotemporal grouping across domains. *Natural Language & Linguistic Theory* 35(1). 161–203.
- Higginbotham, James. 1985. On semantics. *Linguistic Inquiry* 16(4). 547–593.
- Hirsch, Nils. 2018. *German psych-verbs: Insights from a decompositional perspective*. Berlin: Humboldt-Universität zu Berlin. (Doctoral dissertation). DOI: 10.18452/19574.
- Horvath, Julia. 1981. On the status of vowel patterns in Modern Hebrew: Morphological rules and lexical representation. *UCLA Occasional Papers in Linguistics* 4. 228–261.
- Horvath, Julia & Tal Siloni. 2008. Active lexicon: Adjectival and verbal passives. In Sharon Armon-Lotem, Gabi Danon & Susan Rothstein (eds.), *Current issues in Generative Hebrew linguistics*, 105–134. Amsterdam & Philadelphia: John Benjamins.

## References

- Horvath, Julia & Tal Siloni. 2009. Hebrew idioms: The organization of the lexical component. *Brill's Annual of Afroasiatic Languages and Linguistics* 1. 283–310.
- Hyman, Larry M. 2003. Suffix ordering in Bantu: A morphocentric approach. In Geert Booij & Jaap van Marle (eds.), 245–281. Dordrecht: Springer.
- Inkelas, Sharon. 1993. Nimboran position class morphology. *Natural Language & Linguistic Theory* 11. 559–624.
- Irwin, Patricia. 2019. How do you smile along a path? Bodies and the semantic content of unergative roots. *The Linguistic Review* 36(3). 343–363. DOI: 10.1515/tlr-2019-2021.
- Jacobsen, Wesley. 1992. *The transitive structure of events in Japanese*. Tokyo: Kuro-sio.
- Jerro, Kyle. 2017. The causative–instrumental syncretism. *Journal of Linguistics* 53(4). 751–788. DOI: 10.1017/s0022226717000044.
- Johnson, Kyle. 1991. Object positions. *Natural Language & Linguistic Theory* 9(4). 577–636. DOI: 10.1007/bf00134751.
- Junker, Marie-Odile. 1987. Transitive, intransitive, and reflexive uses of deadjectival verbs in French. In David Birdsong & Jean-Pierre Montreuil (eds.), *Advances in Romance linguistics*, 189–199. Dordrecht: Foris.
- Kalin, Laura. 2020. Morphology before phonology: A case study of Turoyo (Neo-Aramaic). Ms., Princeton. [lingbuzz/004258](https://lingbuzz/004258).
- Kallulli, Dalina. 2013. (Non-)canonical passives and reflexives: Deponents and their like. In Artemis Alexiadou & Florian Schäfer (eds.), *Non-canonical passives*, vol. 205 (Linguistik Aktuell/Linguistics Today), 337–358. Amsterdam/Philadelphia: John Benjamins.
- Kastner, Itamar. 2015. Factivity mirrors interpretation: The selectional requirements of presuppositional verbs. *Lingua* 164. 156–188.
- Kastner, Itamar. 2016. *Form and meaning in the Hebrew verb*. [lingbuzz/003028](https://lingbuzz/003028). New York, NY: New York University. (Doctoral dissertation).
- Kastner, Itamar. 2017. Reflexive verbs in Hebrew: Deep unaccusativity meets lexical semantics. *Glossa* 2(1). 75. DOI: 10.5334/gjgl.299.
- Kastner, Itamar. 2019a. Inchoatives in causative clothing: Change of state in Modern Hebrew heXYiZ. *The Linguistic Review* 36(3). 437–451. DOI: 10.1515/tlr-2019-2025.
- Kastner, Itamar. 2019b. Templatic morphology as an emergent property: Roots and functional heads in Hebrew. *Natural Language & Linguistic Theory* 37(2). 571–619. DOI: 10.1007/s11049-018-9419-y.
- Kastner, Itamar & Frans Adriaans. 2018. Linguistic constraints on statistical word segmentation: The role of consonants in Arabic and English. *Cognitive Science* 42(S2). 494–518. DOI: 10.1111/cogs.12521.



- Kastner, Itamar & Beata Moskal. 2018. Non-local contextual allomorphy: Introduction to the special issue. *Snippets* 34. 1.
- Kastner, Itamar, Liina Pyllkkänen & Alec Marantz. 2018. The form of morphemes: MEG evidence from masked priming of two Hebrew templates. *Frontiers in Psychology* 9(2163). DOI: 10.3389/fpsyg.2018.02163.
- Kastner, Itamar & Matthew A. Tucker. Submitted. Non-concatenative morphology. In Artemis Alexiadou, Ruth Kramer, Alec Marantz & Isabel Oltra Massuet (eds.), *The Cambridge handbook of Distributed Morphology*. Cambridge: Cambridge University Press.
- Kastner, Itamar & Vera Zu. 2017. Blocking and paradigm gaps. *Morphology* 27(4). 643–684.
- Kennedy, Christopher & Beth Levin. 2008. Measure of change: The adjectival core of degree achievements. In Louise McNally & Christopher Kennedy (eds.), *Adjectives and adverbs: Syntax, semantics and discourse*, 156–182. Oxford: Oxford University Press.
- Klaiman, M. H. 1991. *Grammatical voice*. Cambridge: Cambridge University Press.
- Ko, Seongyeon. 2009. Two types of anticausatives in Acehnese. In *Proceedings of AFLA 16*, 93–107.
- Koontz-Garboden, Andrew. 2009. Anticausativization. *Natural Language & Linguistic Theory* 27(1). 77–138.
- Koopman, Hilda. 1997. Prepositions, postpositions, circumpositions and particles: The structure of Dutch PPs. Ms., UCLA.
- Koopman, Hilda. 2005. Korean (and Japanese) morphology from a syntactic perspective. *Linguistic Inquiry* 36(4). 601–633.
- Koopman, Hilda. 2015. Generalized U20 and morpheme order. Ms., UCLA.
- Koopman, Hilda & Anna Szabolcsi. 2000. *Verbal complexes*. Cambridge, MA: MIT Press.
- Kramer, Ruth. 2014. Gender in Amharic: A morphosyntactic approach to natural and grammatical gender. *Language Sciences* 43. 102–115.
- Kramer, Ruth. 2016. A split analysis of plurality: Number in Amharic. *Linguistic Inquiry* 47. 527–559.
- Kratzer, Angelika. 1996. Severing the external argument from its verb. In Johan Rooryck & Laurie Zaring (eds.), *Phrase structure and the lexicon*, 109–137. Dordrecht: Kluwer.
- Kratzer, Angelika. 2000. Building statives. In Lisa J. Conathan, Jeff Good, Darya Kavitskaya, Alyssa B. Wulf & Alan C. L. Yu (eds.), *Proceedings of the twenty-sixth annual meeting of the Berkeley Linguistics Society*, 385–399. Berkeley, CA: University of California, Berkeley Linguistics Society.

## References

- Kratzer, Angelika. 2005. Building resultatives. In Claudia Maienborn & Angelika Wöllstein (eds.), *Event arguments: Foundations and applications*, 177–212. Berlin: de Gruyter.
- Labelle, Marie. 2008. The French reflexive and reciprocal *se*. *Natural Language & Linguistic Theory* 26. 833–876.
- Laks, Lior. 2011. *Morpho-phonological and morpho-thematic relations in Hebrew and Arabic verb formation*. Tel Aviv: Tel Aviv University. (Doctoral dissertation).
- Laks, Lior. 2013. Why and how do Hebrew verbs change their form? A morpho-thematic account. *Morphology* 23. 351–383.
- Laks, Lior. 2014. Morpho-thematic mismatches in Hebrew: What happens when morphological and thematic criteria collide? *Lingua* 138. 107–127.
- Laks, Lior. 2015. Variation and change in instrument noun formation in Hebrew and its relation to the verbal system. *Word Structure* 8(1). 1–28.
- Laks, Lior. 2018. Morphological compensation for empty paradigm cells. *Lingue e linguaggio* 17(2). 233–260. DOI: 10.1418/91867.
- Laks, Lior & Evan-Gary Cohen. 2016. Component-dependent allomorphy and paradigm accessibility: Evidence from Hebrew. *Morphology* 26. 425–452.
- Landau, Idan. 2006. Chain resolution in Hebrew V(P)-fronting. *Syntax* 9(1). 32–66.
- Landau, Idan. 2010. The explicit syntax of implicit arguments. *Linguistic Inquiry* 41(3). 357–388.
- Legate, Julie Anne. 2012. Subjects in Acehnese and the nature of the passive. *Language* 12(3). 495–525.
- Legate, Julie Anne. 2014. *Voice and v: Lessons from Acehnese* (Linguistic Inquiry Monographs 69). Cambridge, MA: MIT Press.
- Lev, Shaul. 2016. *Hebrew labile alternation*. Tel Aviv: Tel Aviv University. (MA thesis).
- Levin, Beth. 1993. *English verb classes and alternations: A preliminary investigation*. Chicago: University of Chicago Press.
- Levin, Beth & Malka Rappaport Hovav. 1995. *Unaccusativity: At the syntax–lexical semantics interface* (Linguistic Inquiry Monographs 26). Cambridge, MA: MIT Press.
- Levin, Beth & Malka Rappaport. 1986. The formation of adjectival passives. *Linguistic Inquiry* 17(4). 623–661.
- Lidz, Jeffrey. 2001. The argument structure of verbal reflexives. *Natural Language & Linguistic Theory* 19(2). 311–353.
- Linzen, Tal. 2014. Parallels between cross-linguistic and language-internal variation in Hebrew possessive constructions. *Linguistics* 52(3). 759–792.

- Marantz, Alec. 1984. *On the nature of grammatical relations* (Linguistic Inquiry Monographs 10). Cambridge, MA: MIT Press.
- Marantz, Alec. 1991. Case and licensing. In German Westphal, Benjamin Ao & Hee-Rahk Chae (eds.), *Proceedings of ESCOL*, 234–253. Columbus, OH: Ohio State University, Cornell Linguistics Club.
- Marantz, Alec. 1997. No escape from syntax: Don't try morphological analysis in the privacy of your own lexicon. In Alexis Dimitriadis, Laura Siegel, Clarissa Surek-Clark & Alexander Williams (eds.), *University of Pennsylvania working papers in linguistics: Proceedings of PLC 21*, 4 vols., 201–225. Philadelphia, PA: University of Pennsylvania.
- Marantz, Alec. 2001. Words. In *The 20th West Coast conference on formal linguistics (WCCFL 20)*. Los Angeles, CA.
- Marantz, Alec. 2013. Locality domains for contextual allomorphy across the interfaces. In Alec Marantz & Ora Matushansky (eds.), *Distributed Morphology today: Morphemes for Morris Halle*, 95–115. Cambridge, MA: MIT Press.
- Matushansky, Ora. 2019. Against the PredP theory of small clauses. *Linguistic Inquiry* 50(1). 63–104.
- McCarthy, John J. 1979. *Formal problems in Semitic phonology and morphology*. Massachusetts Institute of Technology. (Doctoral dissertation).
- McCarthy, John J. 1981. A prosodic theory of nonconcatenative morphology. *Linguistic Inquiry* 12. 373–418.
- McCarthy, John J. 1989. Linear order in phonological representation. *Linguistic Inquiry* 20. 71–99.
- McCarthy, John J. & Alan S. Prince. 1990. Prosodic morphology and templatic morphology. In Mushira Eid & John J. McCarthy (eds.), *Perspectives on Arabic linguistics*, vol. 2, 1–54. Amsterdam/Philadelphia: John Benjamins.
- McCloskey, James. 2014. Irish existentials in context. *Syntax* 17(4). 343–384.
- McIntyre, Andrew. 2013. Adjectival passives and adjectival participles in English. In Artemis Alexiadou & Florian Schäfer (eds.), *Non-canonical passives*, 21–42. Amsterdam/Philadelphia: John Benjamins.
- McNally, Louise. 2017. On the scalar properties and telicity of degree achievements. In Olga Fernández-Soriano, Elena Castroviejo Miró & Isabel Pérez-Jiménez (eds.), *Linguistik aktuell/Linguistics today*, 174–192. Amsterdam/Philadelphia: John Benjamins. DOI: 10.1075/la.239.09mcn.
- McOmbler, Michael. 1995. Morpheme edges and Arabic infixation. In Mushira Eid (ed.), *Perspectives on Arabic linguistics*, vol. 7, 173–188. Amsterdam/Philadelphia: John Benjamins.

## References

- Meltzer-Asscher, Aya. 2011. Adjectival passives in Hebrew: Evidence for parallelism between the adjectival and verbal systems. *Natural Language & Linguistic Theory* 29(3). 815–855.
- Miyagawa, Shigeru. 1998. (S)ase as an elsewhere causative and the syntactic nature of words. *Journal of Japanese Linguistics* 16. 67–110.
- Moore-Cantwell, Claire. 2013. Over- and under-generalization in learning derivational morphology. In Stefan Keine & Shayne Sloggett (eds.), *Proceedings of the 42nd meeting of the North East Linguistic Society (NELS)*, 41–54. Amherst, MA: GLSA.
- Moscoso del Prado Martín, Fermín, Avital Deutsch, Ram Frost, Robert Schreuder, Nivja H. De Jong & R. Harald Baayen. 2005. Changing places: A cross-language perspective on frequency and family size in Dutch and Hebrew. *Journal of Memory and Language* 53. 496–512.
- Moulton, Keir. 2014. Simple event nominalizations: Roots and their interpretation. In Ileana Paul (ed.), *Cross-linguistic investigations of nominalization patterns*, vol. 210 (Linguistik Aktuell/Linguistics Today), 119–144. Amsterdam/Philadelphia: John Benjamins.
- Muysken, Pieter. 1988. Affix order and interpretation: Quechua. In Martin Everaert & Mieke Trommelen (eds.), *Morphology and modularity*, 259–279. Dordrecht: Foris.
- Myler, Neil. 2016. *Building and interpreting possession sentences*. Cambridge, MA: MIT Press.
- Myler, Neil. 2017. Exceptions to the “Mirror Principle” and morphophonological “action at a distance”. In Heather Newell, Máire Noonan, Glyne Piggott & Lisa deMena Travis (eds.), *The structure of words at the interfaces*, 100–125. Oxford: Oxford University Press.
- Myler, Neil & Alec Marantz. Submitted. Allosemy. In Artemis Alexiadou, Ruth Kramer, Alec Marantz & Isabel Oltra Massuet (eds.), *The Cambridge handbook of Distributed Morphology*. Cambridge: Cambridge University Press.
- Neeleman, Ad. 1997. PP-complements. *Natural Language & Linguistic Theory* 15(1). 89–137. DOI: 10.1023/a:1005700831534.
- Nevins, Andrew. 2015. The exponent list and the encyclopedic list: Structurally parallel, mutually mute. In *Roots IV, New York University*.
- Nie, Yining. 2017. Voice morphology and the features of transitivity. Ms., NYU. [lingbuzz/003750](https://lingbuzz/003750).
- Nie, Yining. 2020. Morphological causatives are Voice over Voice. *Word Structure* 13(1). 102–126.
- Nishiyama, Kunio. 1998. *The morphosyntax and morphophonology of Japanese predicates*. Cornell University. (Doctoral dissertation).

- Noyer, Rolf. 1998. Impoverishment theory and morphosyntactic markedness. In Steve Lapointe, Diane Brentari & Patrick Farrell (eds.), *Morphology and its relation to phonology and syntax*, 264–285. Stanford: CSLI.
- Oltra Massuet, Isabel. 1999. *On the notion of theme vowel: A new approach to Catalan verbal morphology*. Cambridge, MA: Massachusetts Institute of Technology. (MA thesis).
- Oseki, Yohei. 2017. Voice morphology in Japanese transitivity alternations. Ms., NYU. [lingbuzz/003374](https://lingbuzz/003374).
- Ouhalla, Jamal. 2016. Root-extraction: Roots, verbs and nouns ‘need’ in Arabic. *Brill’s Journal of Afroasiatic Languages and Linguistics* 8. 200–222.
- Owens, Jonathan. 1988. *The foundations of grammar: An introduction to medieval Arabic grammatical theory*. Amsterdam/Philadelphia: John Benjamins.
- Pak, Marjorie. 2016. How allomorphic is English article allomorphy? *Glossa* 1(1). 20.
- Paster, Mary. 2005. Pulaar verbal extensions and phonologically driven affix order. In Geert Booij & Jaap van Marle (eds.), *Yearbook of morphology 2005*, 155–200. Dordrecht: Springer.
- Pesetsky, David. 1995. *Zero syntax: Experiencers and cascades*. Cambridge, MA: MIT Press.
- Pollock, Jean-Yves. 1989. Verb movement, UG, and the structure of IP. *Linguistic Inquiry* 20(3). 365–424.
- Poortman, Eva B., Marijn E. Struiksmā, Nir Kerem, Naama Friedmann & Yoad Winter. 2018. Reciprocal expressions and the maximal typicality hypothesis. *Glossa* 3(1). 18. DOI: [10.5334/gjgl.180](https://doi.org/10.5334/gjgl.180).
- Preminger, Omer. 2010. Failure to agree is not a failure:  $\phi$ -agreement with post-verbal subjects in Hebrew. In Jeroen van Craenenbroeck & Johan Rooryck (eds.), *Linguistic variation yearbook 9*, 241–278. Amsterdam/Philadelphia: John Benjamins.
- Preminger, Omer. 2013. That’s not how you agree: A reply to Zeijlstra. *The Linguistic Review* 30(3). 491–500.
- Preminger, Omer. 2014. *Agreement and its failures* (Linguistic Inquiry Monographs 68). Cambridge, MA: MIT Press.
- Prince, Alan & Paul Smolensky. 1993/2004. *Optimality theory: Constraint interaction in generative grammar*. Revision of 1993 technical report, Rutgers University Center for Cognitive Science. ROA 537. Malden, MA, & Oxford: Blackwell.
- Pylkkänen, Liina. 2008. *Introducing arguments* (Linguistic Inquiry Monographs 49). Cambridge, MA: MIT Press.
- Quinn, Conor. 2006. *Referential-access dependency in Penobscot*. Cambridge, MA: Harvard University. (Doctoral dissertation).

## References

- Rappaport Hovav, Malka. 2014. Building scalar changes. In Artemis Alexiadou, Hagit Borer & Florian Schäfer (eds.), *The syntax of roots and the roots of syntax*, 259–281. Oxford: Oxford University Press.
- Ratcliffe, Robert. 1997. Prosodic templates in a word-based morphological analysis of Arabic. In Mushira Eid & Robert Ratcliffe (eds.), *Perspectives on Arabic linguistics*, vol. 10, 157–171. Amsterdam/Philadelphia: John Benjamins.
- Ratcliffe, Robert. 1998. *The “broken” plural problem in Arabic and comparative Semitic*. Amsterdam/Philadelphia: John Benjamins.
- Ravid, Dorit. 1990. Internal structure constraints on new-word formation devices in Modern Hebrew. *Folia Linguistica* 24. 289–347.
- Ravid, Dorit, Orit Ashkenazi, Ronit Levie, Galit Ben Zadok, Tehila Grunwald, Ron Bratslavsky & Steven Gillis. 2016. Foundations of the early root category: Analyses of linguistic input to Hebrew-speaking children. In Ruth Berman (ed.), *Acquisition and development of Hebrew: From infancy to adolescence* (Trends In Language Acquisition Research (TILAR) 19), 95–134. Amsterdam/Philadelphia: John Benjamins.
- Reinhart, Tanya. 2002. The theta system: An overview. *Theoretical Linguistics* 28. 229–290.
- Reinhart, Tanya & Tal Siloni. 2005. The lexicon-syntax parameter: Reflexivization and other arity operations. *Linguistic Inquiry* 36(3). 389–436.
- Rimell, Laura. 2012. *Nominal roots as event predicates in English denominal conversion verbs*. New York, NY: New York University. (Doctoral dissertation).
- Ritter, Elizabeth. 1995. On the syntactic category of pronouns and agreement. *Natural Language & Linguistic Theory* 13(3). 405–443.
- Rood, Morgan. 2017. *The morphosyntax of pronominal possessors and diminutives in Mehri*. Washington, DC: Georgetown University. (Doctoral dissertation).
- Rooryck, Johan. 1996. Prepositions and minimalist case marking. In Höskuldur Thráinsson, Samuel Epstein & Steve Peter (eds.), *Studies in comparative Germanic syntax*, vol. 2, 226–256. Dordrecht: Kluwer.
- Rosén, Haim. 1977. *Contemporary Hebrew*. The Hague: Mouton.
- Rotstein, Carmen & Yoad Winter. 2004. Total adjectives vs. partial adjectives: Scale structure and higher-order modifiers. *Natural Language Semantics* 12. 259–288.
- Schäfer, Florian. 2008. *The syntax of (anti-)causatives*. Amsterdam/Philadelphia: John Benjamins.
- Schäfer, Florian. 2012. The passive of reflexive verbs and its implications for theories of binding and case. *The Journal of Comparative Germanic Linguistics* 15(3). 213–268.

- Schäfer, Florian. 2017. Romance and Greek medio-passives and the typology of Voice. In Roberta D'Alessandro, Irene Franco & Ángel Gallego (eds.), *The verbal domain*, 129–152. Oxford: Oxford University Press.
- Schäfer, Florian & Margot Vivanco. 2016. Anticausatives are weak scalar expressions, not reflexive expressions. *Glossa* 1(18). DOI: 10.5334/gjgl.36.
- Schwarzwald, Ora (Rodrigue). 1973. Roots and patterns in the Modern Hebrew lexicon. *Hebrew Abstracts* 14. 95–96.
- Schwarzwald, Ora (Rodrigue). 1981a. *Dikduk u-metzi'ut ba-po'al ha-ivri* [Grammar and reality in the Hebrew verb]. Ramat Gan: Bar Ilan University Press.
- Schwarzwald, Ora (Rodrigue). 1981b. Frequency factors as determinants in the *binyanim* meanings. *Hebrew Studies* 22. 131–137.
- Schwarzwald, Ora (Rodrigue). 2008. The special status of Nif'al in Hebrew. In Sharon Armon-Lotem, Gabi Danon & Susan Rothstein (eds.), *Current issues in Generative Hebrew linguistics*, 61–75. Amsterdam/Philadelphia: John Benjamins.
- Schwarzwald, Ora (Rodrigue). 2016. Innovative elements in newly formed Hebrew four-consonantal verbal roots. In Livia Körtvélyessy, Pavol Štekauer & Salvador Valera (eds.), *Word-formation across languages*, 311–336. Newcastle upon Tyne: Cambridge Scholars Publishing.
- Shlonsky, Ur. 1987. *Null and displaced pronouns*. Cambridge, MA: Massachusetts Institute of Technology. (Doctoral dissertation).
- Shlonsky, Ur. 1989. The hierarchical representation of subject verb agreement. Ms., University of Haifa.
- Shlonsky, Ur & Edit Doron. 1991. Verb second in Hebrew. In Dawn Bates (ed.), *Proceedings of the tenth West Coast conference on formal linguistics (WCCFL 10)*, 431–445. Stanford, CA: CSLI.
- Sichel, Ivy. 2009. New evidence for the structural realization of the implicit external argument in nominalizations. *Linguistic Inquiry* 40(4). 712–723.
- Sichel, Ivy. 2010. Event structure constraints in nominalization. In Artemis Alexiadou & Monika Rathert (eds.), *The syntax of nominalizations across languages and frameworks*, 151–190. Berlin: Mouton de Gruyter.
- Siloni, Tal. 1997. *Noun phrases and nominalizations: The syntax of DPs*. Dordrecht: Kluwer.
- Siloni, Tal. 2008. *al binyan hitpa'el* [On the hitpa'el template]. In Galia Hatav (ed.), *balshanut ivrit teoretit [Theoretical Hebrew linguistics]*, 111–138. Jerusalem: Magnes Hebrew University Press.
- Siloni, Tal. 2012. Reciprocal verbs and symmetry. *Natural Language & Linguistic Theory* 30. 261–320.

## References

- Siloni, Tal & Omer Preminger. 2009. Nominal voices. In Anastasia Giannakidou & Monika Rathert (eds.), *Quantification, definiteness and nominalization*, 365–385. Oxford: Oxford University Press.
- Spathas, Giorgos. 2017a. *No designated Voice for English reflexive anaphors*. Paper presented at the 2017 Cambridge, UK workshop on Voice.
- Spathas, Giorgos. 2017b. *On the semantic non-uniformity of reflexive anaphors*. Paper presented at the 2017 Debrecen workshop on pronouns.
- Spathas, Giorgos, Artemis Alexiadou & Florian Schäfer. 2015. Middle Voice and reflexive interpretations: *afto*-prefixation in Greek. *Natural Language & Linguistic Theory* 33. 1293–1350.
- Suga, Kazuyoshi. 1980. Heizon-suru zidoshi/tadoshi no imi [*The meaning of coexistent intransitive/transitive verbs*]. *Kokugogaku* 120. 31–41.
- Sundaresan, Sandhya & Thomas McFadden. 2017. The articulated v layer: Evidence from Tamil. In Roberta D'Alessandro, Irene Franco & Ángel Gallego (eds.), *The verbal domain*, 153–178. Oxford: Oxford University Press.
- Svenonius, Peter. 2003. Limits on P: Filling in holes vs. falling in holes. *Nordlyd* 31(2). 431–445.
- Svenonius, Peter. 2007. Adpositions, particles and the arguments they introduce. In Eric Reuland, Tanmoy Bhattacharya & Giorgos Spathas (eds.), *Argument structure*, 63–103. Amsterdam/Philadelphia: John Benjamins.
- Svenonius, Peter. 2010. Spatial P in English. In Guglielmo Cinque & Luigi Rizzi (eds.), *Mapping spatial PPs: The Cartography of syntactic structures*, vol. 6, 127–160. Oxford: Oxford University Press.
- Talmy, Leonard. 1978. Figure and ground in complex sentences. In Joseph Greenberg (ed.), *Universals in human language*, 625–49. Stanford, CA: Stanford University Press.
- Temkin Martínez, Michal. 2008. Exceptions encoded at the segmental level. In Charles B. Chang & Hannah J. Haynie (eds.), *Proceedings of WCCFL 26*, 463–470. Somerville, MA: Cascadilla Press.
- Temkin Martínez, Michal & Ivana Müllner. 2016. Specific exceptions driving variation: The role of orthography in Modern Hebrew spirantization. In *Supplemental proceedings of the annual meeting on phonology (AMP) 2015*.
- Teng, Stacy Fang-Ching. 2007. *A reference grammar of Puyuma, an Austronesian language of Taiwan*. Australian National University. (Doctoral dissertation).
- Trachtman, Einat. 2016. *ha-gorem le-alternatsiot be-hafakat ha-tnu'a be-he habinjan be-tsurut he'avar Sel binjan hif'il [the source of alternations in the production of the vowel on -h- in the past tense of hiXYiZ]*. Haifa: University of Haifa. (MA thesis).



- Tucker, Matthew A. 2015. Your roots are showing: On root-sensitive allomorphy in Arabic. In *Roots IV, New York University*.
- Tyler, Matthew. to appear. Two kinds of external possession in Mississippi Choctaw. *Syntax*.
- Ussishkin, Adam. 1999. The inadequacy of the consonantal root: Modern Hebrew denominal verbs and output-output correspondence. *Phonology* 16(3). 401–442.
- Ussishkin, Adam. 2000. *The emergence of fixed prosody*. Santa Cruz, CA: University of California, Santa Cruz. (Doctoral dissertation).
- Ussishkin, Adam. 2005. A fixed prosodic theory of nonconcatenative templatic morphology. *Natural Language & Linguistic Theory* 23. 169–218. DOI: 10.1007/s11049-003-7790-8.
- van Riemsdijk, Henk. 1990. Functional prepositions. In Harm Pinkster & Inge Genee (eds.), *Unity in diversity: Papers presented to Simon C. Dik on his 50th birthday*, 229–242. Dordrecht: Foris.
- Volpe, Mark Joseph. 2005. *Japanese morphology and its theoretical consequences: Derivational morphology in Distributed Morphology*. Stony Brook, NY: Stony Brook University. (Doctoral dissertation).
- von Stechow, Arnim. 1996. The different readings of *wieder* ‘again’: A structural account. *Journal of Semantics* 13(2). 87–138.
- Wallace, Katherine. 2013. A concatenative approach to Semitic templatic morphology. Ms., NYU. lingbuzz/002299.
- Wasow, Thomas. 1977. Transformations and the lexicon. In Peter Culicover, Thomas Wasow & Adrian Akmajian (eds.), *Formal syntax*, 327–360. New York, NY: Academic Press.
- Williams, Alexander. 2015. *Arguments in syntax and semantics*. Cambridge: Cambridge University Press.
- Winchester, Lindley. 2017. Morphosyntactic features and contextual allomorphy: Evidence from Modern Standard Arabic. In Andrew Lamont & Katerina Tetzloff (eds.), *Proceedings of the 47th annual meeting of the North East Linguistic Society (NELS 47)*, vol. 3, 247–260. Amherst, MA: GLSA.
- Winchester, Lindley. 2019. *The Morphosyntax of the Maltese determiner phrase*. Washington, DC: Georgetown University. (Doctoral dissertation).
- Wood, Jim. 2012. *Icelandic morphosyntax and argument structure*. New York, NY: New York University. (Doctoral dissertation).
- Wood, Jim. 2014. Reflexive *-st* verbs in Icelandic. *Natural Language & Linguistic Theory* 32(4). 1387–1425.
- Wood, Jim. 2015. *Icelandic morphosyntax and argument structure* (Studies in Natural Language & Linguistic Theory 90). Dordrecht: Springer.

## References

- Wood, Jim. 2016. How roots do and don't constrain the interpretation of Voice. *Working Papers in Scandinavian Syntax* 96. 1–25.
- Wood, Jim. 2019. High attachment for arguments of nominalizations. In *Annual meeting of the Linguistic Society of America (LSA 93)*. New York, NY.
- Wood, Jim. 2020. Icelandic nominalizations and allosemy. Ms., Yale.
- Wood, Jim & Alec Marantz. 2017. The interpretation of external arguments. In Roberta D'Alessandro, Irene Franco & Ángel Gallego (eds.), *The verbal domain*, 255–278. Oxford: Oxford University Press.
- Wurmbrand, Susi & Koji Shimamura. 2017. The features of the voice domain: Actives, passives, and restructuring. In Roberta D'Alessandro, Irene Franco & Ángel J. Gallego (eds.), *The verbal domain*, 179–204. Oxford: Oxford University Press. DOI: 10.1093/oso/9780198767886.003.0008.
- Xu, Zheng, Mark Aronoff & Frank Anshen. 2007. Deponency in Latin. In Matthew Baerman, Greville G. Corbett, Dunstan Brown & Andrew Hippisley (eds.), *Deponency and morphological mismatches*, 127–143. Oxford: Oxford University Press. DOI: 10.5871/bacad/9780197264102.001.0001.
- Zeijlstra, Hedde. 2012. There is only one way to agree. *The Linguistic Review* 29. 491–539.
- Zu, Vera. 2018. *Discourse participants and the structural representation of the context*. lingbuzz/003884. New York, NY: New York University. (Doctoral dissertation).
- Zukoff, Sam. 2017. Arabic nonconcatenative morphology and the syntax-phonology interface. In Andrew Lamont & Katerina Tetzloff (eds.), *Proceedings of the forty-seventh annual meeting of the North East Linguistic Society (NELS 47)*, 295–314. Amherst, MA: GLSA.

# Name index

- Adam, Galit, 63  
Adger, David, 229  
Adriaans, Frans, 235  
Ahdout, Odelia, 11, 53, 60, 70, 73, 76,  
77, 124, 125, 173, 189, 190,  
193, 194  
Ahn, Byron, 228  
Akkus, Faruk, 91, 207, 227  
Al Kaabi, Meera, 227, 228  
Alexiadou, Artemis, 4, 5, 14–17, 24,  
26, 35, 39, 53, 54, 57, 60, 68,  
78, 80–82, 87, 98, 102, 139,  
140, 166, 167, 169, 171, 173–  
175, 183, 188, 189, 191, 193,  
199–201, 203, 215  
Anagnostopoulou, Elena, 14, 35, 58,  
82, 84, 203  
Arad, Maya, 5, 10, 11, 13, 14, 17, 48,  
58, 82, 104, 114, 115, 118–120,  
129, 153, 154, 192, 194, 195,  
214, 220, 222, 228, 234  
Ariel, Mira, 36  
Arnon, Inbal, 235  
Aronoff, Mark, 84, 114  
Ashkenazi, Orit, 235  
  
Baier, Nicholas, 229  
Baker, Mark, 21, 94, 167, 178  
Bar-Asher Siegal, Elitzur, 36, 92, 96,  
109, 139  
Bat-El, Outi, 10, 76, 194, 195  
Beavers, John, 52, 53  
  
Béjar, Susana, 136  
Belletti, Adriana, 15  
Ben David, Boaz, 19  
Berman, Ruth, 7, 10, 11, 76, 235  
Bhatt, Rajesh, 72, 80, 157  
Bittner, Maria, 141  
Blanco, Mercedes Tubino, 155  
Bobaljik, Jonathan D., 19, 131, 151  
Bolzoky, Shmuel, 7  
Boneh, Nora, 36, 92, 109, 139, 175, 225  
Bonet, Eulália, 19, 106  
Bopp, Franz, 7  
Borer, Hagit, 7, 10, 33, 36–38, 40, 45,  
48, 84, 92, 114, 120, 128, 133,  
135, 138, 146, 158–160, 162,  
169, 170, 173, 188–190, 193,  
194, 235  
Bowers, John, 27, 151  
Brice, Henry, 195  
Bruening, Benjamin, 78, 167, 173–175,  
181, 183, 188, 189, 228  
Burzio, Luigi, 83  
  
Cano, Mariangeles, 53  
Chen, Victoria, 232  
Choi, Jaehoon, 60  
Chomsky, Noam, 7, 13, 14, 16, 41, 78,  
188, 228, 229  
Chung, Sandra, 91, 230  
Cohen, Evan-Gary, 185  
Cole, Peter, 144  
Cuervo, María Cristina, 5

*Name index*

- Danon, Gabi, 33  
Darden, Bill, 11  
De Sacy, Sylvestre Antoine Isaac, 7  
Deal, Amy Rose, 136, 209  
Den Dikken, Marcel, 87  
Deutsch, Avital, 19, 235  
Doron, Edit, 5, 10, 11, 26, 28, 35, 36,  
40, 48–51, 54, 56, 78, 81, 102,  
104, 115–118, 138, 141, 144,  
150, 156, 166, 167, 169, 171,  
175–177, 182–185, 195, 227,  
234  
Dowty, David, 131  
Ehrenfeld, Lior, 11, 124, 211  
Embick, David, 14, 20, 21, 60, 82, 84,  
94, 173, 174, 177, 179, 183,  
204, 215  
Engelhardt, Miriam, 191  
Enguehard, Guillaume, 12  
Ewald, Georg Heinrich August, 7  
Farkas, Donka, 51  
Faust, Noam, 12, 18, 45, 193, 227  
Fodor, Jerry, 140  
Folli, Raffaella, 28, 51, 52  
Frost, Ram, 235  
Fukuda, Shin, 232  
Gafter, Roey, 12, 35, 38, 39, 77, 128  
Gehrke, Berit, 43, 87, 174  
Geniušienė, Emma, 102  
Gesenius, F. H. W., 7  
Gouskova, Maria, 14, 19, 20, 63  
Greenberg, Yael, 61  
Grestenberger, Laura, 84  
Grimshaw, Jane, 188, 229  
Grodzinsky, Yosef, 36  
Grohmann, Kleantes K., 229  
Hale, Ken, 94  
Halle, Morris, 13  
Harbour, Daniel, 7, 19, 23, 214, 229  
Harley, Heidi, 14, 15, 18, 28, 51, 52,  
60, 94, 140, 146, 151, 155, 188,  
223, 235  
Harris, Zellig, 7  
Harves, Stephanie, 103  
Haspelmath, Martin, 4, 5, 17, 60  
Havron, Naomi, 235  
Hay, Jennifer, 131  
Hazout, Ilan, 191  
Heller, Daphna, 19  
Henderson, Robert, 61  
Hever, Ya'ar, 193  
Higginbotham, James, 89  
Hirsch, Nils, 225  
Horvath, Julia, 10, 177, 179  
Hyman, Larry M., 228  
Inkelas, Sharon, 228  
Iordăchioaia, Gianina, 53  
Irwin, Patricia, 52  
Jacobsen, Wesley, 140, 223  
Jerro, Kyle, 227  
Johnson, Kyle, 14  
Junker, Marie-Odile, 146  
Kalin, Laura, 227  
Kallulli, Dalina, 84, 215  
Kastner, Itamar, 7, 9, 10, 18–21, 35,  
39, 45–47, 59, 60, 64, 70, 73,  
76–78, 80, 82, 84–87, 92, 102,  
104, 106, 107, 109–111, 115,  
129, 131, 134, 138, 144, 153,  
155, 166, 169, 171, 173, 177,  
190, 191, 193–195, 204, 209,  
215, 220, 221, 227, 235

- Kayne, Richard S., 103  
Kennedy, Christopher, 131  
Keyser, Samuel Jay, 94  
Khan, Geoffrey, 227  
Klaiman, M. H., 102, 166  
Ko, Seongyeon, 148  
Koontz-Garboden, Andrew, 4, 5, 35, 52, 53  
Koopman, Hilda, 43, 87, 94  
Kramer, Ruth, 227  
Kratzer, Angelika, 14, 15, 21, 24, 45, 141, 174, 175, 201  
Kuperman, Victor, 19, 235  
  
Labelle, Marie, 5, 102  
Ladusaw, William A., 91, 230  
Laks, Lior, 10, 45, 114, 129, 150, 151, 169, 185, 193  
Landau, Idan, 92, 93, 157, 230  
Legate, Julie Anne, 91, 157, 207, 230, 231  
Lev, Shaul, 129, 131, 148–150, 153, 163, 220  
Levin, Beth, 4, 5, 17, 35, 60, 98, 110, 131, 151, 173  
Lidz, Jeffrey, 78, 166  
Linzen, Tal, 35, 39, 128  
  
Marantz, Alec, 13, 14, 17, 20, 21, 41, 45, 53, 58, 60, 78, 82, 84, 87, 89, 95, 107, 188, 207, 225, 229  
Marco, Cristina, 174  
Matushansky, Ora, 151  
McCarthy, John J., 9–11  
McCloskey, James, 27  
McFadden, Thomas, 54, 55  
McIntyre, Andrew, 174, 175  
McNally, Louise, 131  
McOmber, Michael, 11  
  
Meltzer-Asscher, Aya, 174, 175, 177, 184, 185  
Miyagawa, Shigeru, 140, 223  
Moore-Cantwell, Claire, 11  
Moscoso del Prado Martín, Fermín, 19, 235  
Moskal, Beata, 60, 82  
Moulton, Keir, 189  
Müllner, Ivana, 46, 63  
Muysken, Pieter, 21  
Myler, Neil, 17, 18, 21, 78, 87, 89, 203, 215  
  
Nash, Léa, 225  
Neeleman, Ad, 76  
Nevins, Andrew, 106  
Nie, Yining, 60<sup>9</sup>, 136, 155, 211<sup>5</sup>, 215, 224, 232, 233  
Nishiyama, Kunio, 223  
Noyer, Rolf, 14, 18, 94, 106, 228  
Ntelitheos, Dimitrios, 227, 228  
  
Oltra Massuet, Isabel, 21  
Oseki, Yohei, 4, 215, 223–225  
Ouhalla, Jamal, 195  
Owens, Jonathan, 7  
  
Pak, Marjorie, 20  
Pancheva, Roumyana, 72, 80, 157  
Paster, Mary, 228  
Pesetsky, David, 53  
Pollock, Jean-Yves, 92  
Poortman, Eva B., 96  
Preminger, Omer, 36, 44, 136, 193, 229  
Prince, Alan, 18  
Prince, Alan S., 9, 11  
Pylkkänen, Liina, 43, 91, 201, 207  
  
Quinn, Conor, 227

*Name index*

- Rappaport Hovav, Malka, 4, 5, 17, 35,  
52, 60, 98, 110  
Rappaport, Malka, 173  
Ratcliffe, Robert, 11  
Ravid, Dorit, 7, 235  
Reinhart, Tanya, 10, 98, 99, 114, 120,  
169  
Rezac, Milan, 136  
Rimell, Laura, 94  
Ritter, Elizabeth, 92  
Rizzi, Luigi, 15  
Rood, Morgan, 227  
Rooryck, Johan, 87  
Rosén, Haim, 7  
Rotstein, Carmen, 131  
  
Samioti, Yota, 14, 58, 82, 84  
Schäfer, Florian, 4, 5, 14, 68, 78, 87, 89,  
136, 139, 153, 199, 204, 207,  
208, 211, 215, 222, 229  
Schwarzwald, Ora (Rodrigue), 8, 11,  
12, 45, 76, 85, 114, 195  
Shimamura, Koji, 231–233  
Shlonsky, Ur, 36, 72, 75, 92  
Sichel, Ivy, 53, 167, 178  
Siloni, Tal, 10, 33, 77, 96, 99, 100, 114,  
120, 169, 177, 179, 193  
Smolensky, Paul, 18  
Spathas, Giorgos, 54, 109, 166, 167,  
215, 228  
Sridhar, S. N., 144  
Stone, Megan S., 15  
Suga, Kazuyoshi, 223, 225  
Sundaresan, Sandhya, 54, 55  
Svenonius, Peter, 27, 43, 87, 229  
Szabolcsi, Anna, 94  
  
Talmy, Leonard, 87  
Temkin Martínez, Michal, 46, 63  
  
Teng, Stacy Fang-Ching, 232  
Trachtman, Einat, 12  
Tucker, Matthew A., 7, 9, 10, 45, 115,  
144, 153, 194, 195, 227, 235  
Tyler, Matthew, 89  
  
Ussishkin, Adam, 7, 10, 11, 45, 169,  
170, 194  
  
Van Riemsdijk, Henk, 87  
Vivanco, Margot, 215  
Volpe, Mark Joseph, 84, 223  
Von Stechow, Arnim, 141  
  
Wallace, Katherine, 21, 46, 228  
Wasow, Thomas, 173  
Wexler, Kenneth, 173  
Williams, Alexander, 72, 166, 230  
Winchester, Lindley, 227  
Winter, Yoad, 131  
Wood, Jim, 5, 15, 17, 18, 21, 27, 43,  
45, 60, 69, 73, 78, 84, 87–89,  
91, 95, 188, 189, 191, 193, 203,  
206, 207, 211, 214, 215, 220,  
225, 229  
Wurmbrand, Susi, 231–233  
  
Xu, Zheng, 84  
  
Zeijlstra, Hedde, 136  
Zu, Vera, 51, 78, 84, 102, 166, 171, 173,  
177, 190, 191, 204, 215  
Zukoff, Sam, 21

# Language index

Acehnese, 148, 230, 231

Arabic, 9, 10, 133<sup>6</sup>, 227

Atayal, 231

Balinese, 230

Bantu languages, 228

Chamorro, 230, 231

Choctaw, 89

Classical Greek, 166<sup>1</sup>

French, 89, 102, 146, 166, 203, 208,  
229

Fula, 166<sup>1</sup>

German, 3, 4, 168, 174, 201, 203, 207,  
229

Greek, 3, 4, 54, 84, 166, 203, 207

Icelandic, 89, 203, 230

Italian, 51, 52, 83

Japanese, 4, 89, 207<sup>4</sup>, 223, 227, 231

Kannada, 166

Kinyarwanda, 227

Latin, 84, 204

Nimboran, 228

Niuean, 232

Penobscot, 227

Puyuma, 232

Quechua, 89, 203

Spanish, 174, 203

Tagalog, 232

Tamil, 54, 55

Ukrainian, 230





# Subject index

- adverbial modifiers, *see* agentivity
- Agent, 14, 17, 24, 26, 28, 34, 35, 35<sup>2</sup>,  
39, 41, 43, 45, 49, 52, 53, 55,  
63, 70–75, 78–81, 87, 89, 91,  
95, 97–99, 101, 103, 109, 110,  
110<sup>14</sup>, 114, 116–118, 132, 167,  
168, 173, 174, 185, 199, 201,  
203, 207, 207<sup>3</sup>, 230, 230<sup>4</sup>,  
231–233
- agentivity, 34, 35, 35<sup>2</sup>, 39, 40, 51–55,  
62, 71, 73, 97, 98, 102, 103,  
110, 114, 118, 128
- Agree, 93, 136, 228, 231–233
- allomorphy, 20, 21, 46, 60, 64, 86, 191,  
192, 209
- allosemy, 21, 22, 44, 44<sup>4</sup>, 80, 107, 204,  
204<sup>2</sup>
- animacy, 38, 51, 52
- applicative, 43, 91, 95, 96, 109, 213,  
214, 223, 225–227
- by itself*, *see* agentivity
- case, 14, 33, 33<sup>1</sup>, 41, 109, 156, 157, 216,  
229, 232–234
- causative, 2–5, 9, 13, 14, 16, 17, 24,  
52, 53, 59, 60, 81, 98, 101,  
104, 106, 117, 119, 121, 123–  
125, 127, 131, 134, 139–142,  
144, 144<sup>9</sup>, 146–150, 153–155,  
155<sup>12</sup>, 156, 158, 159, 162, 163,  
169, 184, 199–201, 207, 207<sup>4</sup>,  
208, 209, 212, 215, 216, 220,  
222, 227
- Causer, 15, 17, 35<sup>2</sup>, 39, 53, 98, 132, 136,  
156, 183, 184, 200, 231
- conjugation class, 5, 7, 114, 119, 120,  
153–155, 214, 228
- contextual allomorphy, *see* allomorphy
- contextual allosemy, *see* allosemy
- de-spirantization, *see* spirantization
- degree achievements, 129, 131, 132,  
137, 163, 220
- deponents, 84
- ditransitives, 28, 34, 40, 41, 43, 48, 67,  
125
- episodic plural, *see* unaccusativity  
tests
- EPP, 16, 48, 80, 94, 107, 109, 228
- Figure, 27, 68, 73, 74, 77, 78, 87, 89, 91,  
95, 99, 115, 199, 206
- figure reflexives, 39, 68, 69, 73–75,  
75<sup>1</sup>, 76, 77, 80, 87, 89, 91, 95,  
96, 100, 103, 104, 109, 111, 113,  
114, 117, 118, 152, 206, 219<sup>1</sup>,  
220, 225
- Ground, 27, 73, 87
- head movement, 92–95

*Subject index*

- i*<sup>\*</sup>, 60<sup>9</sup>, 151, 152, 206, 225–228  
Impoverishment, 211, 214
- Layering, 16<sup>4</sup>, 28, 199, 201, 203, 204,  
204<sup>2</sup>, 206–209, 211, 214–216,  
229
- licensing, 3, 14, 17, 18, 52, 58, 78, 79,  
82, 87, 89, 96, 107, 117, 139,  
159, 160, 178, 185, 201, 222,  
231
- linearization, 92–94, 236
- locality, 107, 152, 155, 193, 209
- markedness, 4, 5, 12, 16, 17, 27, 45<sup>5</sup>,  
67, 101, 119, 139–144, 144<sup>9</sup>,  
146–148, 150, 154, 157, 162,  
200, 201, 203, 204, 207, 209,  
212<sup>6</sup>, 214, 216, 223–225, 233
- mediopassive, 26, 69, 77, 178
- Merge, 13, 44, 88, 214
- movement, 92–95, 229, 231, 265
- nominalizations, 48, 53–55, 60, 65,  
109, 110, 110<sup>14</sup>, 163, 165, 166,  
173, 179, 188–191, 191<sup>4</sup>, 193,  
194, 209
- passive, 2, 8, 9, 19, 26, 37, 54, 69–71,  
73, 76, 77, 80, 81, 99, 99<sup>9</sup>, 106,  
107, 109<sup>13</sup>, 114, 156, 159, 165–  
169, 171–175, 177–179, 184–  
186, 188, 190, 193, 194, 203,  
207, 219, 221, 230, 230<sup>4</sup>, 231,  
235
- possessive dative, *see* unaccusativity  
tests
- prepositional phrases, 17, 27, 43<sup>3</sup>, 73,  
75, 76, 76<sup>2</sup>, 77, 80, 87, 88, 91,  
94–96, 100<sup>10</sup>, 109, 118, 221,  
225
- productivity, 11, 46, 139, 148, 150, 151,  
162, 188
- spirantization, 11, 28, 49, 63, 64
- Theme, 21, 87, 209
- transitive, 2, 3, 5, 16, 17, 22, 25, 26, 33,  
35, 36, 41, 50, 56, 67, 71, 77,  
79, 84, 95, 98, 103, 109, 114,  
115, 123–125, 127, 128, 130,  
131, 140, 146–148, 150, 156,  
185, 200, 201, 208, 209, 212,  
215, 216, 219, 221, 223–225,  
229, 233
- unaccusativity tests, 35, 36, 38–40,  
44, 70, 72–74, 75<sup>1</sup>, 91, 97, 109,  
110, 128
- Unspecified Voice, 23, 25–28, 33, 41,  
44, 48, 49, 55, 65, 78, 82, 88,  
109<sup>13</sup>, 120, 139, 140, 147, 154,  
155, 173, 199, 204, 209, 211,  
214, 233
- VS order, *see* unaccusativity tests



# Did you like this book?

This book was brought to you for free

Please help us in providing free access to linguistic research worldwide. Visit <http://www.langsci-press.org/donate> to provide financial support or register as a community proofreader or typesetter at <http://www.langsci-press.org/register>.

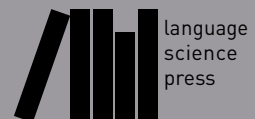



# Voice at the interfaces

This book presents the most comprehensive description and analysis to date of Hebrew morphology, with an emphasis on the verbal templates. Its aim is to develop a theory of argument structure alternations which is anchored in the syntax but has systematic interfaces with the phonology and the semantics. Concretely, the monograph argues for a specific formal system centered around possible values of the head Voice. The formal assumptions are as similar as possible to those made in work on non-Semitic languages. The first part of the book (four chapters) is devoted to Hebrew; the second part (two chapters) compares the current theory with other approaches to Voice and argument structure in the recent literature.

ISBN 978-3-96110-257-0



9 783961 102570