

Phospholipids as functional excipients in solid oral dosage forms

Dissertation zur Erlangung des akademischen Grades des
Doktors der Naturwissenschaften (Dr. rer. nat.)
eingereicht im **Fachbereich Biologie, Chemie, Pharmazie**
der **Freien Universität Berlin**

vorgelegt von

MARINA KOLBINA

Aus Narva, Estland

Berlin 2018

Die vorliegende Arbeit wurde von Oktober 2013 bis Juni 2018 unter der
Leitung von Prof. Dr. Roland Bodmeier im Institut für Pharmazie angefertigt.

1. Gutachter: Prof. Dr. Roland Bodmeier

2. Gutachter: Prof. Dr. Philippe Maincent

Disputation am: 12.10.2018

Acknowledgements

I am very thankful to Prof. Dr. Roland Bodmeier for giving me the opportunity to work and to study in his extraordinary research group. I thank for his scientific support and professional guidance and for the chance to be educated in more than research skills but also to gain valuable life experience.

I kindly thank Prof. Dr. Philippe Maincent for co-evaluating my thesis.

I thank sincerely Dr. Martin Körber for supervising, guiding and truly advancing my work. I have always appreciated your patience and our discussions.

I would like to thank Phospholipid Research Center for financial support and particularly, Dr. Peter van Hoogevest for his contribution and enduring interest in my work.

Furthermore, I want to thank Eva Ewest, Stefan Walter and Andreas Krause for their essential technical support and readiness to help with any trouble I have faced.

I would like to thank Erasmus students, who worked with me, Damaris Sanz Martín, Vittoria Ferraro and Marzia Bonizzoni.

I thank my present and former colleagues from Kelchstraße for great working atmosphere, for endless laughter at lunch breaks, for unforgettable barbecues and dinners, for yearly “Happy birthday” songs and cakes.

Special thanks to my lab partner Dr. Rebaz Ali, for pleasant atmosphere and delicious eastern goodies, that have sweetened my bitterest moments and pleased my best days.

Additional gratitude is extended to Lisa Beßlich, Prutha Gaitonde, Miriam Colombo and Friederike Zühl for correcting and proofreading my thesis.

I heartfully thank the “Supergirls” team, Miriam and Prutha for sincere friendship, essential scientific and indispensable emotional support during my work.

Finally, I want to thank, my family for their support and encouragement, and most of all, my husband Miguel, for his endless love, patience and contribution to our family, without his support this work would just not be possible.

Contents

| | |
|---|-----------|
| Acknowledgements | i |
| 1 Introduction | 1 |
| 1.1 Phospholipids General | 1 |
| 1.1.1 Phospholipid Classes | 1 |
| 1.1.2 Phospholipid Sources and Processing | 2 |
| 1.1.3 Properties and Characterization | 7 |
| 1.1.4 Polymorphism | 9 |
| 1.2 Phospholipids in Oral Drug Delivery | 15 |
| 1.2.1 Phospholipids fate after oral ingestion | 15 |
| 1.2.2 Functionality of Phospholipids in Oral Formulations | 19 |
| 2 Research Objectives | 36 |
| 3 Results and Discussion | 37 |
| 3.1 Characterization of Rheological Properties of Phospholipid Powders and Evaluation of Their Processability into Solid Oral Dosage Forms | 37 |
| 3.1.1 Background | 37 |
| 3.1.2 Materials and Methods | 38 |
| 3.1.3 Results and Discussion | 41 |
| 3.1.4 Conclusions | 55 |
| 3.2 Saturated Phosphatidylcholine as Matrix Former for Oral Extended Re- lease Dosage Forms | 58 |
| 3.2.1 Introduction | 59 |
| 3.2.2 Materials and Methods | 61 |
| 3.2.3 Results and Discussion | 64 |
| 3.2.4 Conclusions | 72 |

| | | |
|-------|---|------------|
| 3.3 | pH-dependent Behaviour of Phosphatidylcholine: Mechanism Elucidation and Approaches to Minimize It | 74 |
| 3.3.1 | Background | 74 |
| 3.3.2 | Materials and Methods | 75 |
| 3.3.3 | Results and Discussion | 77 |
| 3.3.4 | Conclusions | 89 |
| 3.4 | Evaluation of Hydrogenated Soybean Phosphatidylcholine Matrices Prepared by Hot Melt Extrusion for Oral Controlled Delivery of Freely Soluble Drugs | 90 |
| 3.4.1 | Introduction | 91 |
| 3.4.2 | Materials and Methods | 93 |
| 3.4.3 | Results and Discussion | 95 |
| 3.4.4 | Conclusions | 105 |
| 4 | Summary | 106 |
| 5 | Zusammenfassung | 110 |
| 6 | References | 115 |
| 7 | List of Publications | 133 |

List of Figures

| | | |
|----|--|----|
| 1 | Molecular structures and ionization status of common phospholipids. . . | 2 |
| 2 | World supply of soybean, rapeseed and sunflower in the tie period between 2012-2017. | 3 |
| 3 | Flow sheet of lecithin producing unit. | 5 |
| 4 | Specificity of phospholipases and lipases towards the phospholipid structure. | 6 |
| 5 | The high-temperature high-lipid region of the egg lecithin-water system. . | 10 |
| 6 | Structures of lipid phases. | 12 |
| 7 | DSC thermogram of 1,2-diacyl-L-phosphatidylcholine monohydrates. . . | 13 |
| 8 | Lipid digestion and drug solubilization in the small intestine. | 16 |
| 9 | <i>In vitro</i> lipolysis set-up. | 18 |
| 10 | Different phases of lipid-based formulation after digestion and ultracentrifugation. | 18 |
| 11 | Schematic molecular model of putative phosphatidylcholine enriched monolayer at the interface between the gastric mucus gel and the gastric juice. . | 21 |
| 12 | Summary of studies employing solid phospholipid-based formulations for oral drug bioavailability enhancement. | 29 |
| 13 | X-ray diffractogram of studied phospholipids. | 42 |
| 14 | Isotherm plots of studied phospholipids. | 43 |
| 15 | Equilibrium moisture content of phospholipid samples at 45, 75 and 98% relative humidity levels. | 44 |
| 16 | Sorption and desorption rate profiles for (A) saturated Phospholipon 90 H; (B) unsaturated Phospholipon 90 G and (C) monoacyl- Lipoid S LPC 80. . | 45 |
| 17 | Effect of 90 H content in tablets with different formulation on (A) compactability and (B) disintegration time. | 47 |

| | | |
|----|--|----|
| 18 | Effect of 90 G content on (A) compactability and (B) disintegration time in tablets. | 49 |
| 19 | Compressibility index of phospholipids Prosolv [®] powders at different phospholipid loadings. | 51 |
| 20 | Compactability profiles of phospholipid-Prosolv [®] powders. (A) 90 G; (B) S 75; (C) S 45; (D) LPC 80. | 52 |
| 21 | Compressibility index of Aeroperl- and Neusilin-based PL powders. | 53 |
| 22 | Effect of highly porous carrier type on (A) compactability of 1:1 phospholipid: carrier blends and (B) disintegration time of tablets with 45% phospholipid content. | 53 |
| 23 | S 45 untreated material (left) and Aeroperl-based S 45 powder (60% PL content) (right) after 3 months storing at room conditions. | 55 |
| 24 | Particle size distribution measured by powder laser diffraction (A) and optical microscopy picture of phosphatidylcholine powder (B). | 64 |
| 25 | Compactibility profile of saturated phosphatidylcholine powder: (A) tensile strength (B) air porosity as a function of compaction pressure with (C) enlarged initial porosity scale. | 65 |
| 26 | Contribution of plastic work as a function of (A) compaction pressure in absolute terms and (B) as a % to total work of compaction. | 66 |
| 27 | Effect of drug loading (A) on resulted air porosity and (B) tablet tensile strength as a function of compaction pressure. | 66 |
| 28 | Effect of drug solubility on the release from phosphatidylcholine matrix at drug: lipid 30:70 weight ratio in phosphate buffer pH 6.8. | 67 |
| 29 | Effect of caffeine loading on drug release from saturated phosphatidylcholine matrix tablets in phosphate buffer pH 6.8. | 68 |
| 30 | Effect of tablet size on caffeine release from saturated phosphatidylcholine matrix tablets in phosphate buffer pH 6.8 (60% drug loading) | 68 |
| 31 | Effect of particle size of phospholipid powder on caffeine release in phosphate buffer pH 6.8 (60% drug loading). | 69 |
| 32 | Effect of paddle rotation speed on caffeine release from saturated phosphatidylcholine matrix tablets (20% drug loading). | 71 |

| | | |
|----|--|----|
| 33 | Effect of pH on caffeine release from saturated phosphatidylcholine matrix tablets (20% drug loading). | 71 |
| 34 | Determination of powder true densities by fitting experimental data into non-linear regression; (A) Avicel 102, (B) Phospholipon 90H. | 73 |
| 35 | Effect of dissolution medium pH on (A) placebo matrix water uptake and (B) caffeine release from phosphatidylcholine matrix tablet. | 77 |
| 36 | Schematic representation of phosphatidylcholine molecule with a net 0 charge. | 78 |
| 37 | Effect of dissolution medium pH on caffeine release from phosphatidylcholine matrix tablets. | 78 |
| 38 | Effect of (A) buffer anion species and (B) buffer pH on phosphatidylcholine matrix hydration extent. | 79 |
| 39 | Caffeine release at (A) 60% drug loading and (B) 20% loadings from tablets composed of phosphatidylcholine chloride powder at different pH. | 80 |
| 40 | Effect of phosphatidylcholine spray drying with calcium chloride salt on water uptake at different pH (A); Macroscopic images of precipitated crystals of calcium phosphate on the placebo matrix surface (B). | 81 |
| 41 | Effect of tablet preparation methods on caffeine release (60%) from phosphatidylcholine matrix tablets at different pH. | 82 |
| 42 | Effect of SDS amount in the formulation on (A) drug release from 20% caffeine tablets at different pH; (B) extension of drug release in phosphate buffer and on drug release difference at different pH. | 83 |
| 43 | Effect of (A) magnesium hydroxide (2.5%) on caffeine (60%) release at pH 1.2 and 6.8; (B) magnesium hydroxide amount on caffeine (20%) release at pH 1.2; (C) medium switch after 2 hours from pH 1.2 to 6.8 for formulation with 20% caffeine and 2.5% magnesium hydroxide. | 84 |
| 44 | Effect of (A) ethyl cellulose and (B) hydroxypropyl methyl cellulose phthalate addition to tablet formulation on caffeine release from phosphatidylcholine matrices (60% drug loading) at different pH. | 86 |
| 45 | Effect of (A) ethyl cellulose (B) hydroxypropyl methyl cellulose phthalate and (C) shellac addition to the formulation of 60% caffeine tablet by wet granulation on drug release at different pH. | 87 |

| | | |
|----|---|-----|
| 46 | Caffeine release at (A) 20% drug loading and (B) 60% drug loadings from tablets composed of co-processed phosphatidylcholine (PC) with EC and HPMCP polymers by means of spray-drying at different medium pH. | 88 |
| 47 | Comparison of caffeine release (A) 60% drug loading and (B) 20% drug loadings from phosphatidylcholine (PC) and phosphatidic acid calcium salt matrices at different medium pH. | 88 |
| 48 | DSC thermogram of saturated phosphatidylcholine in dry state coupled with hot stage microscopy images. | 96 |
| 49 | Macroscopic pictures of extrudates: (upper) placebo saturated phosphatidylcholine (lower) 50% theophylline loaded extrudate. | 98 |
| 50 | Powder X-ray diffraction pattern of caffeine - phospholipid extrudate with 50% drug loading, caffeine - phosphatidylcholine powders physical mixture (50%), phosphatidylcholine and caffeine. | 99 |
| 51 | Experimental (symbols) and fitted (dotted lines) drug release profiles from extrudates. | 100 |
| 52 | Effect of drug solubility on apparent diffusion coefficient from extruded phosphatidylcholine matrices at 50% drug loading. | 101 |
| 53 | Drug release from (A) 10% and (B) 50% loaded diprophylline tablets and extrudates with identical composition. | 102 |
| 54 | Effect of drug loading on phospholipid matrix recovery for 8 mm caffeine tablets (*) and extrudates with caffeine (O) and diprophylline (Δ). | 104 |
| 55 | SEM images of 30% caffeine matrices at 600x magnification. | 105 |

List of Tables

| | | |
|----|--|-----|
| 1 | Phospholipid composition of vegetable de-oiled lecithins, % | 4 |
| 2 | Fatty acid composition of typical batches or vegetable de-oiled lecithins, area % | 4 |
| 3 | Apparent pK_a values of ionizable groups of some common double-chain phospholipids. ^a | 8 |
| 4 | Commercially available Lipid-based products for oral administration. . . | 23 |
| 5 | Solid lipids used in sustained release drug delivery systems. | 31 |
| 6 | Examples of lipid excipient-based, sustained-release dosage forms prepared using twin-screw extrusion process. | 34 |
| 7 | Summary on appearance and composition of studied phospholipid powders. | 41 |
| 8 | Compressibility index and Hausner ratio of saturated phospholipids. . . . | 42 |
| 9 | Scale of flowability. | 42 |
| 10 | Tablet formulations for direct compression with 90 H. | 47 |
| 11 | Phospholipid tablets formulations prepared by wet granulation. | 48 |
| 12 | Phospholipids content in Prosolv-based powders. | 50 |
| 13 | Phospholipid content in Aeroperl- and Neusilin-based powders. | 51 |
| 14 | Moisture content in S 45 powder and Aeroperl-based S 45. | 54 |
| 15 | Summary of methods applied for phospholipid tableting and contents achieved | 57 |
| 16 | Particle size and flow properties of phosphatidylcholine powder (Phospholipon 90 H). | 65 |
| 17 | Degree of PLA-mediated hydrolysis of placebo phospholipid tablets. . . . | 70 |
| 18 | Overview of model drugs used in present study. | 98 |
| 19 | Calculated D_{app} values for extruded and compressed matrices. | 102 |

List of Abbreviations

| | |
|--------------|--|
| API | Active pharmaceutical ingredient |
| BCS | Biopharmaceutical Classification System |
| CI | Compressibility index |
| CMC | Critical micelle concentration |
| COX | Cyclooxygenase |
| DC | Direct compression |
| DG | Dry granulation |
| DVS | Dynamic vapor sorption |
| DSC | Differential scanning calorimetry |
| EC | Ethyl cellulose |
| EMC | Equilibrium moisture content |
| FDA | Food and drug administration |
| FTIR | Fourier-transform infrared spectroscopy |
| GIT | Gastrointestinal tract |
| GRAS | Generally recognised as safe |
| HPMCP | Hydroxypropyl methyl cellulose phthalate |
| HR | Hausner ratio |
| LPC | Lysophospholipid |
| MCC | Microcrystalline cellulose |
| NDA | New drug application |
| NLT | Not less than |
| NMR | Nuclear magnetic resonance spectroscopy |
| NSAID | Nonsteroidal anti-inflammatory drug |
| PA | Phosphatidic acid |
| PC | Phosphatidylcholine |
| PE | Phosphatidylethanolamine |
| PG | Phosphatidylglycerol |
| PI | Phosphatidylinositol |
| PL | Phospholipid |
| PLA | Phospholipase A |
| PLC | Phospholipase C |
| PLD | Phospholipase D |

| | |
|--------------|--|
| PVP | Polyvinylpyrrolidone |
| RH | Relative humidity |
| SDS | Sodium dodecyl sulphate |
| SEDDS | Self-emulsifying drug delivery systems |
| TLC | Thin layer chromatography |
| USP | United States Pharmacopeia |
| WG | Wet granulation |
| XRD | X-ray diffraction |

1 Introduction

1.1 Phospholipids General

Phospholipids are widely used as active ingredients and pharmaceutical excipients. In oral applications they have recently become attractive due to the variety of functions they could perform in formulations; exceptional biocompatibility of phospholipids in general, and phosphatidylcholine (PC) in particular.

1.1.1 Phospholipid Classes

There are two main classes of natural phospholipids which occur in sufficient quantities to allow industrial manufacturing and application: glycerophospholipids with a glycerol and sphingophospholipids with a sphingosine backbone, latter being out of the scope of this work.

Glycerophospholipids (further referred as phospholipids) are the derivatives of triacylglycerols with one fatty acid substituted by a phosphoric acid ester of an amino alcohol (e.g. choline, ethanolamine), a polyol (e.g. glycerol, inositol) or, in the case of phosphatidic acid, by free phosphoric acid, resulting in phosphatidylcholine (PC), phosphatidylethanolamine (PE), etc., respectively. Depending on the structure of polar the head and medium pH, phospholipids would have different ionization status and, thus, net charge. PC and PE are zwitterionic and have neutral charge at pH 7, while phosphatidylglycerol and -inositol (PG and PI) are negatively charged (Figure 1).

The most common phospholipid is phosphatidylcholine. Phosphatidylcholines represent the most abundant lipid class in mammalian membranes and a major membrane component in eukaryotic organisms. Therefore, it is also the main component of lecithin. United States Pharmacopeia (USP) defines lecithin as a “complex mixture of acetone-insoluble phosphatides, which consist chiefly of phosphatidylcholine, phosphatidylserine, and phosphatidylinositol, combined with various amounts of other substances such

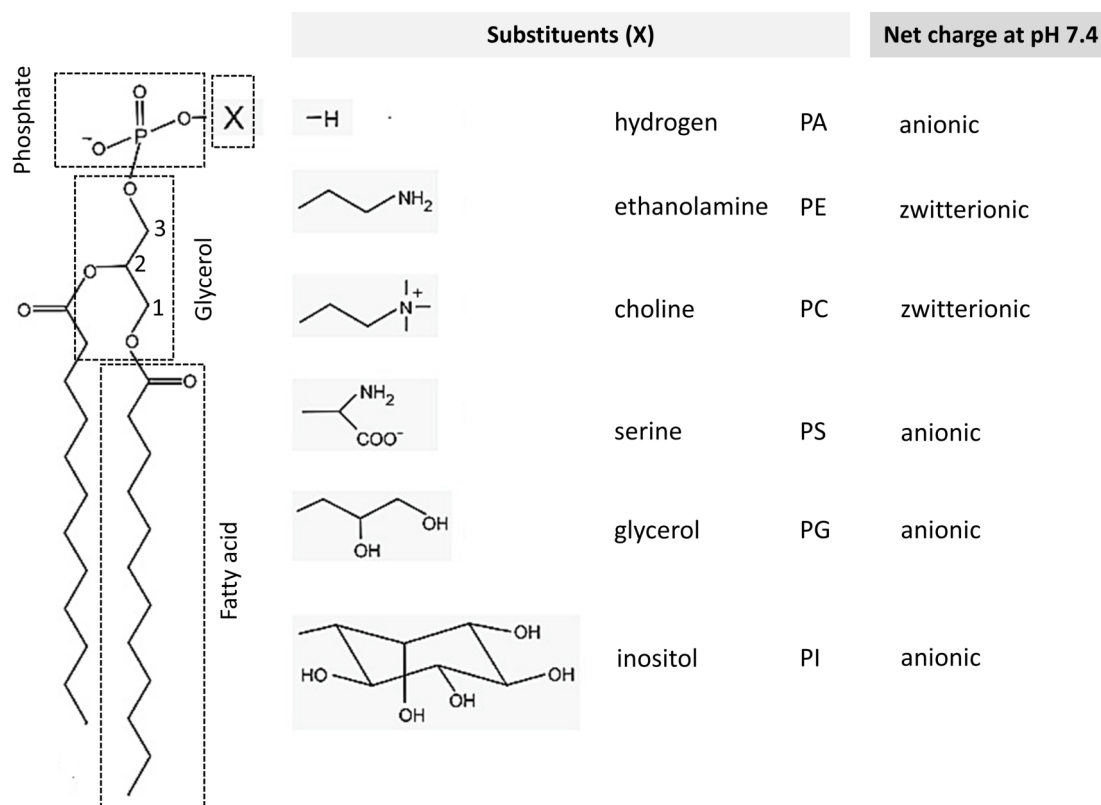

Figure 1. Molecular structures and ionization status of common phospholipids.

as triglycerides, fatty acids, and carbohydrates, as separated from the crude vegetable oil source. It contains NLT 50.0% of acetone-insoluble matter". There is, however, slight confusion with a term "lecithin", since originally it was assigned to the pure PC precedent from egg-yolk, and it is still used in some medicinal literature and documents of health authorities in regard to PC, although it does not comply with modern USP definition of lecithin. In the food and cosmetic industry "lecithin" became a tradename for a mixture of phosphatides as a nutrition supplement. In this work, it is referred to lecithin as a purified or impurified product of extraction from the raw material, which can be considered as an excipient on its own or starting material for further separation of phosphatidylcholine.

1.1.2 Phospholipid Sources and Processing

Phospholipids may be obtained from natural sources or by various synthesis routes. Synthetic phospholipids have defined desirable fatty acids compositions and polar head groups. Historically, they were used in biophysical and biochemical fields as models to understand mechanistic aspects of bio-membranes. Further, synthetic phospholipids

were designed to optimize drug targeting of parenteral dosage forms, such as liposomes. There are several approaches to synthesize diacyl-PC using organic chemical synthesis and/or enzymatic synthesis steps. Apart from defined composition (i.e. exact phase transition temperature), synthetic phospholipids have elevated costs, due to numerous and complex steps of production, low yields and necessity to recycle hazardous solvents, used in the synthesis.

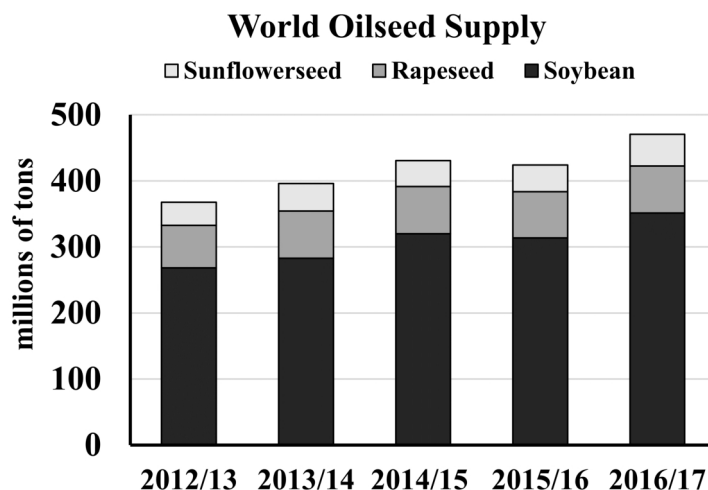

Figure 2. World supply of soybean, rapeseed and sunflower in the time period between 2012-2017. Source: United States Department of Agriculture, National Agricultural Statistics Service www.nass.usda.gov.

Phospholipids obtained from natural sources are defined as natural phospholipids. Main sources of raw materials are soybean, rape seeds, wheat germs, sunflower, egg yolk, milk and krill. Due to their importance in a food industry, these materials are produced worldwide on a very large scale (Figure 2), and there is clearly adequate supply also for pharmaceutical industry needs.

The phospholipids composition and fatty acids profiles depend on the raw material sources (Table 1 and Table 2) as well as may slightly vary due to climatic conditions during plant maturation and its genetic origin. Therefore, there should be a strict quality control of the raw material applied, as well as validated production methods used to guarantee reproducibility of phospholipid excipient batches obtained from lecithin by extraction and chromatographic purification.

Table 1. Phospholipid composition of vegetable de-oiled lecithins, %. Adopted from Hoogevest and Wendel, 2014.

| Phospholipid | Soybean | Sunflower seed | Rapeseed |
|--------------|---------|----------------|----------|
| PC | 20-22 | 20-26 | 23-31 |
| PE | 16-22 | 4-10 | 9015 |
| PI | 13-16 | 15-19 | 15-18 |
| PA | 5-10 | 2-5 | 5-10 |
| LPC | <3 | <3 | <3 |

Table 2. Fatty acid composition of typical batches of vegetable de-oiled lecithins, area %. Adopted from Hoogevest and Wendel, 2014.

| Fatty acid | Soybean | Sunflower seed | Rapeseed |
|------------|---------|----------------|----------|
| C14:0 | 0.1 | 0.1 | 0.1 |
| C16:0 | 21 | 16 | 10 |
| C18:0 | 4.7 | 5.3 | 0.8 |
| C18:1 | 9.9 | 21 | 49 |
| C18:2 | 57 | 54 | 31 |
| C18:3 | 5.0 | 0.2 | 4.4 |
| C20:0 | 0.1 | 0.5 | 0.1 |
| C22:0 | 0.4 | 1.5 | 0.1 |

To explain the production process of natural phospholipid excipients from plant oil, soybean lecithin is taken as an example (Figure 3).

Crude soybean lecithin, is a result of degummed soybean oil, extracted from soybeans, which further serves as a starting material for production of lecithin with high PC contents. High yields are achieved by extraction methods using non-toxic solvents, acetone and ethanol, followed by chromatographic purification procedures and appropriate solvent removal, which is often recycled and reused (Wendel, 2001).

Lecithins with different PC-fractions (PC 20-80%) and up to pure PC (98%) can be obtained by selecting appropriate sequential extraction and purification methods. Although, phospholipid composition and fatty acids ratios would slightly change between lecithins with different PC fractions, there are 5 fatty acids types, which account 95% of the total fatty acid composition. These are palmitic acid (C16:0), stearic acid (C18:0), oleic

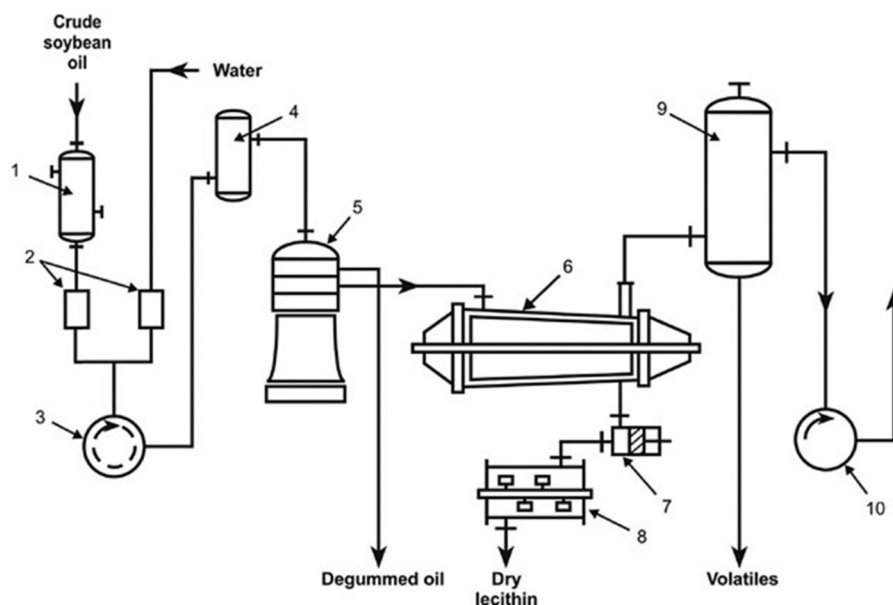

Figure 3. Flow sheet of lecithin producing unit. Crude soybean oil is heated in the preheater, 1, to 80°C, mixed with 2% water in the proportion control unit, 2, and intensively agitated in 3. The mixture goes to a dwelling container, 4, and is then centrifuged after a residence time of 2–5 min. The degummed oil flows without further drying to the storage tanks. The lecithin sludge is dried in the thin-film evaporator, 6, at 100°C and 6 kPa (60 mbar) for 1–2 min and is discharged after cooling to 50–60°C in the cooler, 8. 9 and 10 are the condenser and vacuum pump, respectively. Reprinted from Wendel, 2001 with kind permission of John Wiley and Sons.

acid (C18:1), linoleic acid (C18:2) and linolenic acid (C18:03). Moreover, inter-batch variability is low, resulting in high quality pharmaceutical excipients, which comply with pharmacopeia and regulatory requirements for parenteral and other specific formulations (Hoogevest and Wendel, 2014).

1.1.2.1 Hydrogenated lecithin

Natural phospholipid mixtures (lecithins) contain high levels of unsaturated fatty acids (Table 2). The acyl chain unsaturation, lowers the phase transition temperature from gel to liquid crystalline state to below zero degrees, thus, at ambient and physiological temperatures these phospholipids form flexible structures upon hydration, which are suitable for specific pharmaceutical technological applications (e.g. liposomes). However, in order to achieve more physically stable liposome formulations (Senior and Gregoriadis, 1982), or address other technological needs (Fini et al., 2008), phospholipids with higher phase transition temperatures are required.

The catalytic hydrogenation of natural phospholipids is performed. In this process, the

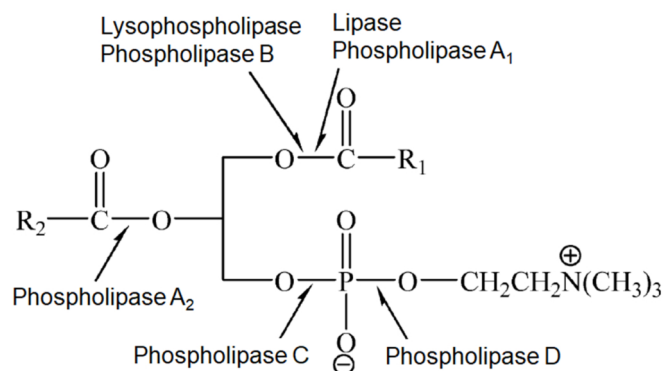

Figure 4. Specificity of phospholipases and lipases towards the phospholipid structure. Adopted from Gunstone, 2008.

unsaturated fatty acids are saturated by hydrogen gas in a catalytic reaction involving metal catalysts (e.g. nickel, palladium, and platinum) bound to porous carrier, typically in a heterogeneous system (Baer, 1965; Jacini, 1954). The attempts to produce partially hydrogenated phospholipids have not been successful so far, since it is very difficult to terminate hydrogenation reproducibly at a defined point of hydrogen uptake. Therefore, only fully saturated products are available (Gunstone, 2008). As a result, resulting phospholipids are more stable against oxidation, but at the same time less soluble in fats and oils. Another effect of hydrogenation is a complete elimination of most of the natural pigments, resulting in white to off-white free-flowing phospholipid powders.

1.1.2.2 Enzyme-modified phospholipids

Due to fast recent advances in biotechnology, enzyme catalysed reactions serve as a viable alternative to organic chemical synthesis reactions, nowadays. Thus, the use of enzymes for phospholipid modifications has been growing not only in academic research but also in industry (Gunstone, 2008). There is a number of reasons for the fast-growing use of enzymes for polar lipid modification, such as milder reaction conditions, less environmental pollution, better specificity for improved quality, and higher efficiency of reactions. For industrial applications, the economic balance of the processes is, however, the key factor, and there has been a steady advance in enzyme production and enzyme technology in the past few years as well.

There is a number of bond-specific enzymes, which can be used for different modification purposes of PL ester bonds (Figure 4). For acyl modifications, the phospholipase A₁ and A₂ (PLA₁ and PLA₂, respectively) are specific and position selective (sn-1 and sn-2,

respectively). The triacylglycerol lipases in general can also be used for such purposes, in particular for modifications at the sn-1 position, however there is no lipase known to react selectively at the sn-2 position. For polar group modification, phospholipase D (PLD) is the only potential enzyme known, while phospholipase C (PLC) can hydrolyse the bond between the glycerol OH group and the phosphate group. The examples of enzyme-modified natural phospholipids are monoacyl-phospholipids (lyso PC, LPC), soy PE, soy and egg PG, and their saturated analogues (Hoogevest and Wendel, 2014).

1.1.3 Properties and Characterization

Phospholipids have a bipolar, amphiphilic molecular structure, which consists of lipophilic part in the form of two fatty acids and a hydrophilic group in the form of a phosphoric acid based esters. Due to their amphiphilic character, phospholipids show a tendency to form bilayers or micelles and liposomes, once hydrated. As a result, they find many applications in foods, cosmetic and pharmaceutical products as natural emulsifiers, wetting and dispersing agents.

The physical chemistry of polar lipids, including phospholipids, has been thoroughly reviewed in a number of textbooks and individual chapters (Cevc, 1993; Larsson, 1994).

Most phospholipids are soluble in chloroform, dichloromethane, hexane, methanol, ethanol, isopropanol, pyridine and their mixtures. The mixtures of hexane and isopropanol are commonly used in HPLC for the dissolution and elution of phospholipids are, sometimes with a small portion of water added (Letter, 1992). Water and aqueous solutions, on the other hand, are poor solvents for phospholipids; although phospholipids disperse readily in aqueous media, the maximum solubility of double-chain phosphatidylcholines with 14–18 carbon atoms in water at room temperature is only about 10^{-10} M (Cevc, 1993). Zwitterionic phospholipids contain both a negative and a positive charge under physiological conditions. Depending on the medium pH they can be cationic or zwitterionic. Despite the low water solubility, it is possible to attribute an apparent acid dissociation constant, pKa, to the different functional groups (e.g. phosphate, amine, carboxyl moieties) in the phospholipid polar head group (Boggs, 1987; Marsh, 1990). Due to the surface effects of phospholipids, the pKa values of these groups are slightly different from the intrinsic values in bulk water. However, due to the sensitive experimental procedures employed, values also differ depending on the determination method applied (Koynova

and Caffrey, 1998). Nevertheless, it has been possible to determine apparent pK_a values from the titration of the gel-to-liquid bilayer transition temperature at different bulk proton concentrations, and some pK_a values are listed in Table 3 for the most common double-chain phospholipids (Tatulian, 1993).

Table 3. Apparent pK_a values of ionizable groups of some common double-chain phospholipids.^a

| Phospholipid | Medium | Temperature (°C) ^b | pK _a (PO ₄) | pK _a (COO ⁻) | pK _a (NH ₃ ⁺) |
|--------------|--------------|-------------------------------|------------------------------------|-------------------------------------|---|
| DLPA | 0.1 M NaCl | T _t | 4.0, 8.1 | - | - |
| DMPA | 0.1 M NaCl | T _t | 4.0, 8.5 | - | - |
| DLPE | Triton X-100 | 40 | ~1 | - | 9.8 |
| DMPE | 0.1 M NaCl | T _t | 1.7 | - | 11.2 |
| DMPC | 0.1 M HCl | T _t | ~1 | - | - |
| DPPC | 0.1 M HCl | T _t | ~1 | - | - |
| DMPG | 0.1 M NaCl | T _t | 3.5 | - | - |
| DPPG | 0.1 M NaCl | T _t | 3.1 | - | - |
| DMPS | 0.1 M NaCl | T _t | 2.6 | 5.5 | 11.6 |
| DPPS | 0.1 M NaCl | 25 | NA | 4.6 | NA |

^a The enthalpy of protonation is much higher for the amino group than for the phosphate and carboxylate groups and it is, thus, more dependent on the temperature (Marsh, 1990).

^b T_t is the temperature deduced at the gel-to-liquid phase transition from titration of the transition temperature. NA = data not available; - = not applicable. Adopted from Gunstone, 2008.

The protonation / deprotonation of the phospholipid head groups caused by a pH change in the aqueous environment has a great impact on the physical properties of the phospholipid molecule. A change of charge sign and/or net charge may influence the molecular conformation and the overall polarity, which may further affect phase transitions, hydration/swelling, and interactions with ions and solutes, such as peptides and proteins, and the colloidal stability of aqueous dispersions of phospholipid aggregates. Furthermore, changes in pH have also an influence on the hydrolytic stability of the phospholipids (Grit, Underberg, and Crommelin, 1993).

Furthermore, polar lipids may be divided into three different classes depending on their interaction with bulk water and their behaviour in the water–air interface (Small, 1968). The Class I comprises the insoluble, non-swelling lipids; Class II includes the insoluble and swelling lipids; and Class III describes the soluble lipids. According to this

classification, the double-chain phospholipids belong to Class II while the single-chain phospholipids – to Class III. The Class II lipids are particularly interesting from a phase behavioural perspective. As it is previously mentioned, they are virtually insoluble in water, however the interaction with water or swelling in water in temperature-dependent fashion results in the formation of various liquid crystalline phases.

1.1.4 Polymorphism

The term ‘polymorphism’ is traditionally used to indicate that more than one (liquid) crystalline phase is formed by a substance. Phospholipids are most often regarded fully or partially hydrated, therefore present a polymorphic behaviour.

Thermotropic mesomorphism

On heating of phospholipids, an endothermic transition is observed at a temperature well below the true melting point of the material. At this transition a change of solid state occurs, resulting in different liquid-crystalline, or mesomorphic states. In these mesomorphic states the hydrocarbon chains have a conformation similar to that observed in liquid hydrocarbons whilst the polar moieties of the molecules hold the structure together in some particular manner. Thus, at this crystal to liquid-crystal transition melting of the hydrocarbon chains occurs. The formation of different phases under effect of temperature is called thermotropic mesomorphism.

In contrast to phospholipid-water rich systems, there are just few records regarding the structure of mesophases of non-hydrated (i.e. anhydrous) phospholipids. In 1960s temperature-resolved X-ray diffraction techniques were applied to characterize mesophases of anhydrous egg lecithin (Luzzati, Gulik-Krzywicki, and Tardieu, 1968; Small, 1967). Luzzati et al. have published a detailed crystallographic examination of the phases obtained in the egg-yolk lecithin with water content less than 6% (w/w) (Figure 5).

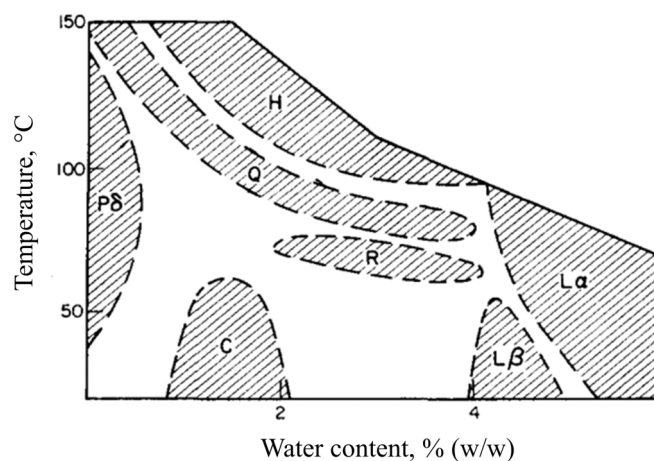

Figure 5. The high-temperature high-lipid region of the egg lecithin-water system; the one-phase regions are hatched: the limits are not precisely known; two or three phases are usually observed in the intermediate regions. The phases noted are: C : three-dimensionally crystalline; L_{β} : lamellar, with stiff hydrocarbon chains packed in an hexagonal subcell (phase L_{β} was never found quite pure in this system); P_{δ} : two-dimensional centred rectangular lattice, hydrocarbon chains partly ordered; Q : cubic, body centred, disordered hydrocarbon chains. Adopted from Luzzati et al., 1968, with a kind permission from Springer Nature.

Lytotropic mesomorphism

The addition of solvents can also induce phase transition in liquid crystalline materials, this phenomenon is called lyotropic mesomorphism. The lyotropic phases obtained are thus a function of both, water content and temperature. The characteristic phase transition temperature (T_o), depends on numerous factors, e.g. length, saturation and symmetry of hydrocarbon chains, chemical link between the chains and the polar headgroup, phospholipid heterogeneity, medium composition and pH (Koynova and Caffrey, 1998). As it has been reviewed by Koynova and Tenchov (2013), a generalized phase sequence of thermotropic phase transitions in membrane lipids (i.e. fully hydrated phospholipids and glycolipids) may be written as follows (Tenchov, 1991):

$$L_c \longleftrightarrow L_{\beta} \longleftrightarrow L_{\alpha} \longleftrightarrow Q_{||}^{[B]} \longleftrightarrow H_{||} \longleftrightarrow Q_{||}^{[M]} \longleftrightarrow M_{||}$$

On heating, a lamellar crystalline (subgel) L_c phase transforms into lamellar gel L_{β} phase; the latter phase undergoes a melting transition into the lamellar liquid-crystalline L_{α} phase. Upon further increase in temperature, a series of mesomorphic phase transitions follow the sequence L_{α} —bilayer cubic $Q_{||}^{[B]}$ —inverted hexagonal $H_{||}$ —inverted micellar cubic $Q_{||}^{[M]}$ —micellar $M_{||}$. Some lipids can form two or more modifications of a given

phase, for example, gel phases of different structures (interdigitated, tilted, rippled; Figure 6 C, D, E) and bilayer cubic phases of different topology (Figure 6 P, Q, R).

With the increase in water content at constant temperature, the mesomorphic lipid phases arrange themselves in the following sequence (Seddon, 1990):

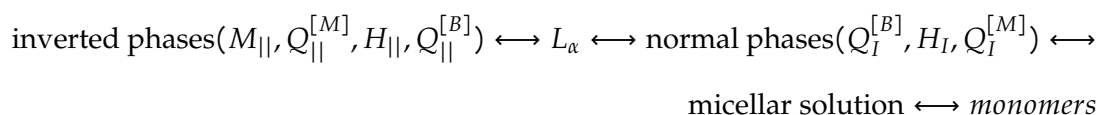

Typically, double-chain lipids only form L_{α} and inverted phases, whereas single-chain lipids can also form normal phases and micellar solutions. This phase sequence is rationalized by the effect of water content on the effective shape of the lipid molecules. Low hydration levels lead to tighter packing and smaller-surface molecular areas of lipid polar head groups, resulting in negative interfacial curvature and a tendency to form inverted phases. With an increase in water content, the surface molecular area expands; consequently, the concave interfaces of inverted phases sequentially transform into the flat interface of the L_{α} phase and into the convex interfaces of the normal mesomorphic phases. Further dilution results in dissipation of periodic lipid structures and formation of micellar solutions (and eventually monomer solutions at high dilutions, below the critical micellar concentration, CMC) (Koynova and Tenchov, 2013).

Phosphatidylcholines have been extensively studied in regard to aqueous interaction and phase properties, because of their importance in biological membrane functions, as well as interest in liposome development (Larsson, 1994). It has been illustrated by numerous publications in the field, reviewed and indexed by Koynova and Caffrey, 2002, who presented more than 2000 phase diagrams of various lipids, including phospholipids. Most of the presented phase diagrams referred to binary (two-component, i.e. phospholipid–water) temperature–composition phase diagrams, but also more complex (ternary, quaternary) phase diagrams were listed.

1.1.4.1 Experimental techniques for studying the phase behaviour of phospholipids

There is a great variability of experimental techniques to determine the physical properties of a phospholipid system. Some of the most important techniques are polarized light

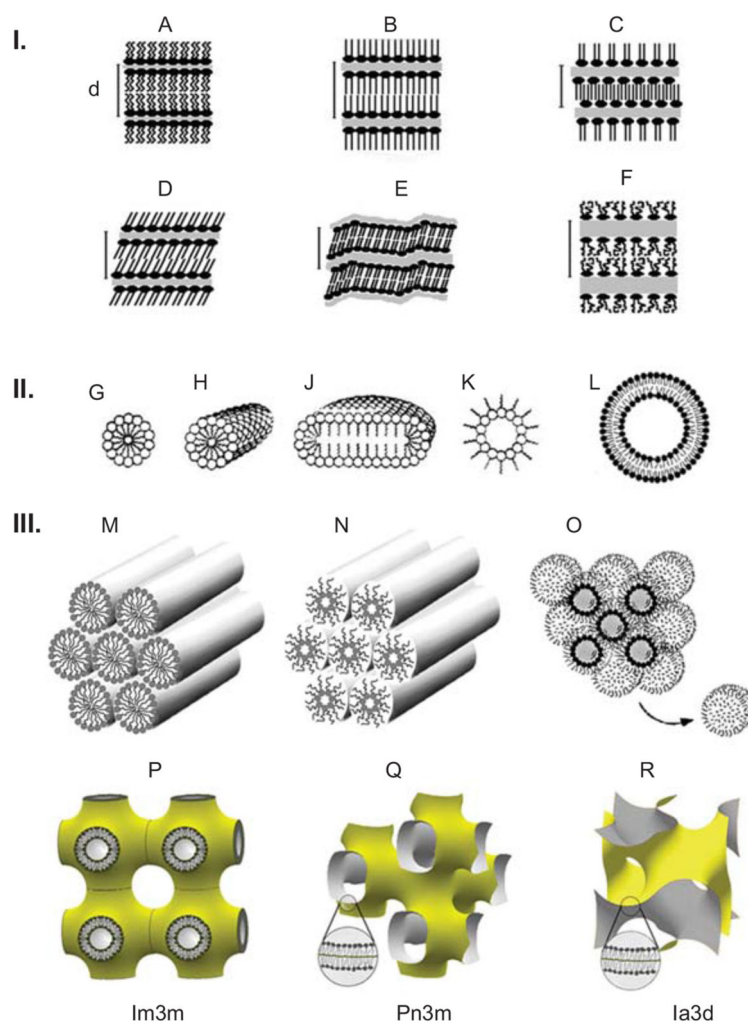

Figure 6. Structures of lipid phases. I. Lamellar phases: (A) subgel, L_C ; (B) gel, L_β ; (C) interdigitated gel, $L_\beta^{[int]}$; (D) gel, tilted chains, L_β' ; (E) rippled gel, P_β' ; (F) liquid crystalline, L_α . II. Micellar aggregates; (G) spherical micelles, M_I ; (H) cylindrical micelles (tubules); (J) disks; (K) inverted micelles, M_{II} ; (L) liposome; III. Non-lamellar liquid-crystalline phases of various topology; (M) hexagonal phase H_{II} ; (N) inverted hexagonal phase H_{II} ; (O) inverted micellar cubic phase $Q_{II}I^{[M]}$; (P) bilayer cubic ($Q_{II}I$) phase $Im3m$; (Q) bilayer cubic phase $Pn3m$; (R) bilayer cubic phase $Ia3d$. (Koynova and Tenchov, 2013).

microscopy, X-ray crystallography, NMR spectroscopy, rheology, and differential scanning calorimetry.

The easiest way to characterize a sample is to observe if it scatters the light by ocular inspection or turbidity measurement using a spectrophotometer. Isotropic micellar solutions and cubic liquid crystals are clear and transparent, whereas the anisotropic liquid crystals scatter light and appear more or less cloudy (Holmberg, 2003).

Polarized light microscopy, can be used to judge if a sample is isotropic or not, as well as to distinguish between the different anisotropic phases, such as lamellar and hexagonal phases. It is often possible to guess the phase structure from the appearance in the

microscope, when composition is known, however, for precision the structure must be concluded by a more reliable technique. Traditionally, X-ray diffraction has been used to accomplish this (Fontell, 1981), complemented by various NMR techniques (Holmberg, 2003; Lindman, 1987) in recent years.

Viscosity measurements may provide useful information on the rheological properties of phospholipid–water systems in a relatively simple manner. For micellar solutions, the viscosity is generally related to the micelle size and shape. The most important effect is the dramatic increase in viscosity occurring on formation of rod-like micelles. Generally, the viscosity of liquid crystals increases in the order lamellar < hexagonal < cubic. For the lamellar phase, the lipid bilayers can easily move over each other, but motion perpendicular to the layered structure is difficult. For hexagonal phases (both normal and reversed), motion along the cylinders is easy, but motion perpendicular to the cylinders is difficult since it involves changes in cylinder packing. Finally, for cubic phases there is no easy flow direction, since a three-dimensional structure exists and often a complex rheological behaviour is observed (e.g. shear thinning at low shear rates, increased viscosity at high shear rates, etc.).

Differential scanning calorimetry (DSC) is a common technique for the thermal analysis

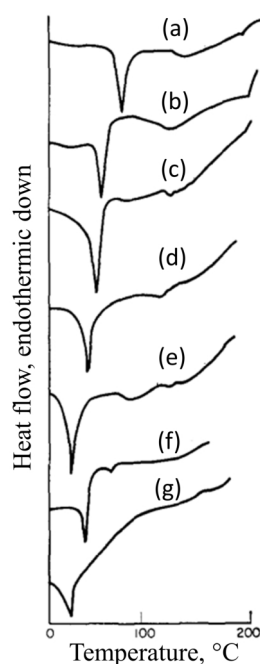

Figure 7. DSC thermogram of 1,2-diacyl-L-phosphatidylcholine monohydrates: (a) distearoyl-; (b) dipalmitoyl-; (c) dimyristoyl-; (d) dilauroyl-; (e) dicapryl-; (f) 1-stearoyl-2-oleoyl-; (g) egg yolk. Adopted from Chapman. et al. 1967, with

of pure and, ideally, anhydrous phospholipids, used for example for determination of the melting point, but more often for the determination of chain-melting temperatures and phase equilibria in binary phospholipid–water mixtures (Figure 7) (Ladbrooke and Chapman, 1969).

Various infra-red spectroscopy techniques may be used to understand molecular interactions during phospholipid phase transitions, interactions with proteins and drug molecules (Bensikaddour et al., 2008; Fookson and Wallach, 1978; Fringeli, 1981; Yang, Kamiya, and Goto, 2012). Detailed assignment of absorption wavelengths for anhydrous 1,2-distearoyl-L-phosphatidylcholine crystallized from chloroform / diethyl ether has been given by Chapman, Williams, and Ladbrooke, 1967.

1.2 Phospholipids in Oral Drug Delivery

Phospholipids become increasingly important as formulation excipients, as well as active ingredients. Due to the diversity and the biocompatibility, phospholipids application spectrum within oral drug formulation comprised bioavailability enhancement of drugs with low aqueous solubility and/or low membrane penetration potential, as well as protection of sensitive active agents from degradation in the gastrointestinal tract (GIT), reduction of gastrointestinal side effects of non-steroidal anti-inflammatory drugs and taste masking of bitter drugs. Technological strategies to achieve these effects are highly diverse and offer various possibilities of liquid, semi-liquid and solid lipid-based formulations for drug delivery optimization.

1.2.1 Phospholipids fate after oral ingestion

The fate of phospholipid-based formulations inside the gastrointestinal tract and their impact on drug absorption had been discussed in detail (Chakraborty et al., 2009, Fricker et al., 2010 and Porter, Trevaskis, and Charman, 2007). Shortly, the digestion of lipids begins in the oral cavity through exposure to lingual lipases and continues in the stomach through the effects of both lingual and gastric enzymes. The stomach further contributes to lipid processing by mechanical mixing, which when combined with the presence of the amphiphilic products of initial lipid digestion (diglycerides and fatty acids) facilitates formation of a crude emulsion. In the small intestine, pancreatic lipase completes the breakdown of triglycerides into diglyceride, monoglyceride and fatty acid. Pancreatic lipase acts primarily at the sn-1 and sn-3 positions of triglycerides to produce 2-monoglyceride and free fatty acid. The presence of exogenous lipids in the small intestine also stimulates secretion of endogenous biliary lipids, including bile salt, phospholipids and cholesterol from the gall bladder. In the presence of raised bile salts concentrations, the products of lipid digestion (monoglyceride, fatty acid and lysophospholipids) are subsequently incorporated into a series of colloidal structures, including multilamellar and unilamellar vesicles, mixed micelles and micelles. Together these species significantly expand the solubilization capacity of the small intestine for lipid digestion products and, potentially, for the incorporated drugs (Figure 8).

The primary mechanisms by which lipid-based drug formulations enhance drug solubilization in GI tract are by presentation as a solubilized formulation (thereby avoiding solid-state limitations) and by induction of changes to the character of the GI environment (Porter, Trevaskis, and Charman, 2007). Upon the dispersion of the lipid based formulation, oily ester components are subjected to the digestion in the small intestine, thus the solubilization capacity of the formulation may change. This can lead either to drug precipitation, resulting in the loss of advantage of the lipid formulation, or in contrary, to the formation of endogenous colloidal phases such as vesicles and micelles, that increases the solubilization of co-administered drug in the small intestine (Yeap, Trevaskis, and Porter, 2013, Yeap et al., 2013).

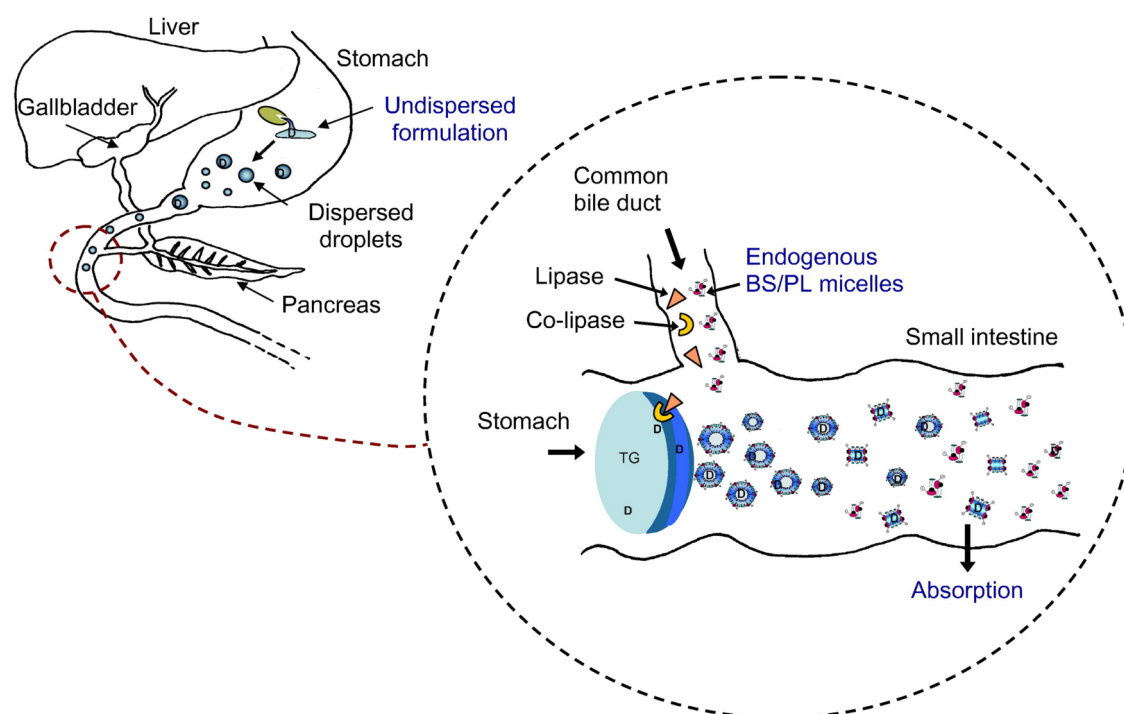

Figure 8. Lipid digestion and drug solubilization in the small intestine. Reprinted from Porter et al., 2008, with kind permission from Elsevier.

In general, as it has been thoroughly reviewed by Porter (Porter et al., 2008), non-digestible lipids such as mineral oils (e.g. liquid paraffin) and sucrose polyesters (which remain essentially unabsorbed in the intestinal lumen), reduce drug absorption by retaining part of the co-administered drug in the undigested formulation and impeding transfer to the colloidal species in the luminal aqueous phase where absorption is thought to occur.

Therefore, digestible lipids such as soybean oil, corn oil or olive oil are typically preferred for lipid solution formulations. Bioavailability improvement is usually attributed to enhanced drug solubilization in the colloidal species formed by digestion of the lipid vehicle and intercalation of the lipid digestion products into endogenous bile salts and phospholipid micellar structures. In addition to the digestibility of the lipid vehicle, the nature of the lipid used, in terms of fatty acid chain length, the degree of unsaturation and the lipid class, may also alter the oral bioavailability of poorly water-soluble drugs.

1.2.1.1 *In vitro* lipolysis model

Due to the complexity of the events taking place after ingestion of lipid based formulations, conventional dissolution, or dispersion, tests are often not feasible for *in vitro* evaluation of drug release, because these tests do not take into account that excipients can be prone to lipase catalysed hydrolysis in the gastrointestinal tract. Therefore, *in vitro* digestion models, also known as *in vitro* lipolysis models, are used to assess the destiny of lipid based formulation *in vivo* (Larsen, Sassene, and Müllertz, 2011).

The existing models are simulating lipid digestion in the upper small intestine. Buffers with physiological concentrations of bile salts, phospholipids are used as release medium. Lipid-based systems containing drug are mixed and incubated at 37°C. The levels of bile salts and phospholipid are selected to simulate either the fasted or the fed state, depending on the purpose of the study. The lipolysis is initiated by the addition of pancreatic enzymes (i.e. pancreatic extract). The action of pancreatic lipase and other esterases present in the pancreatic extract induces the hydrolysis of triacyl glycerides and other excipients, releasing free fatty acids, which are neutralized by addition of sodium hydroxide by the pH-stat. Furthermore, in order to prevent FA accumulation on the surface of the lipid droplet and thus, inhibition of the activity of pancreatic lipase, they are precipitated from the medium by addition of calcium ions, which form insoluble calcium fatty acid soaps (Figure 9).

Samples are collected at different time points and lipolysis is immediately inhibited by using 4-bromobenzenboronic acid solution.

The samples are separated by ultracentrifugation into three different phases, namely, oil, micellar and pellet phase (Figure 10). The oil phase on the top of the tube is generally

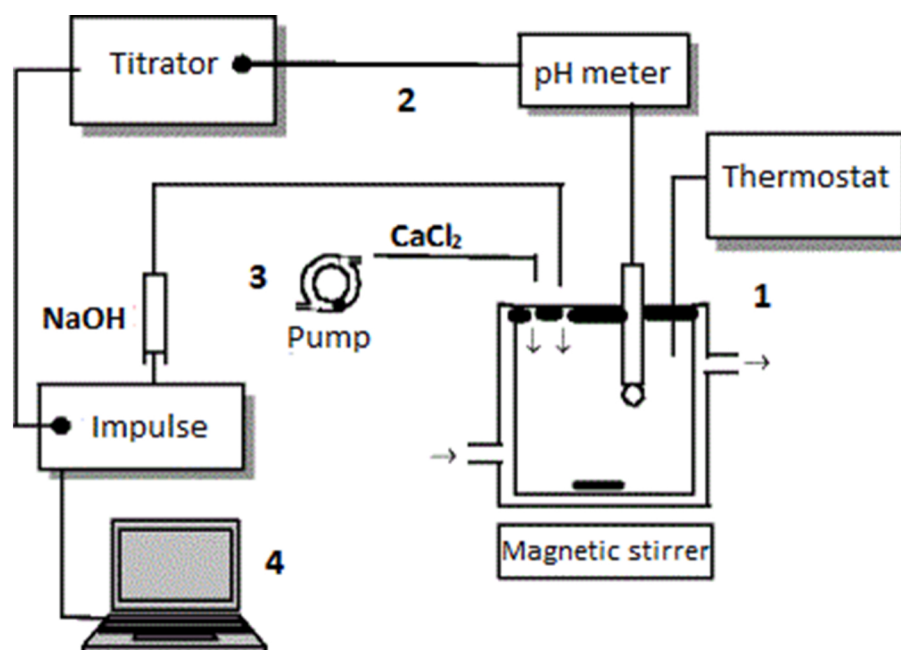

Figure 9. *In vitro* lipolysis set-up. 1 thermostatic double wall reaction vessel; 2 pH-stat with the auto burette for the addition of NaOH; 3 peristaltic pump for addition of CaCl₂; 4 the computer with the software for the titration experiments. The temperature is monitored during the experiment with a thermocouple. The experiment is performed under continuous agitation at 37°C. Adopted from Larsen, Sassene, and Müllertz, 2011 with kind permission from Elsevier.

only seen at the beginning of the experiment, and originates from non-digestible formulation. The pellet phase consists of calcium soap of free fatty acid and precipitated drug, while the micellar phase contains the drug fraction, which, supposedly, is available for absorption and has been correlated with the bioavailability of drug *in vivo*.

Furthermore, to assess the nature of colloidal structures formed during “digestion” phase, cryogenic transmission electron microscopy can be applied on non-centrifuged sample

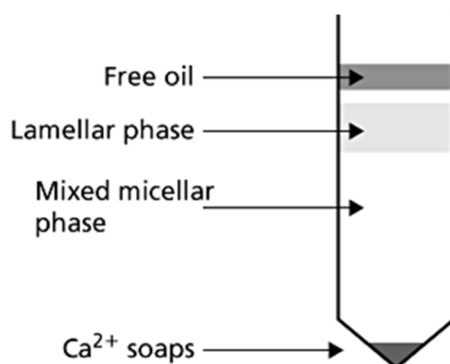

Figure 10. Different phases of lipid-based formulation after digestion and ultracentrifugation. Adopted from Müllertz et al., 2010 with a kind permission from John Wiley and Sons.

(Fatouros, Bergenstahl, and Mullertz, 2007; Kleberg et al., 2010), as well as small-angle X-ray scattering can be measured online to study the formation of liquid crystalline phases (Fatouros, Bergenstahl, and Mullertz, 2007), while solid state of precipitated drugs can be analysed by X-ray diffraction (Sassene et al., 2010).

However, whether or not a lipid excipient is subject to gastric and/or pancreatic lipolysis highly depends on its molecular structure, accessibility of ester bonds and interactions with water and bile salts, as well as the dosage form. Semi-solid formulations containing medium chain fatty acids are more readily digested than solid formulations comprising long chain fatty acids (Bonnaire et al., 2008). The impact of digestion should be determined in the final solid dosage form rather than from the pure lipid excipients in biorelevant media.

1.2.2 Functionality of Phospholipids in Oral Formulations

1.2.2.1 Phospholipids as active ingredients

Beneficial effects of dietary phospholipids (PLs) have been mentioned since the early 1900's in relation to different illnesses and symptoms, e.g. coronary heart disease, inflammation or cancer. There are several reviews that summarize most common therapeutic uses of dietary PLs and provide an overview of their approved and proposed benefits (Gundermann et al., 2016; Küllenberg et al., 2012).

Naturally occurring phospholipids of either plant or animal origin, predominantly contain unsaturated fatty acids in the sn-2 position, such as oleic, linoleic or linolenic acid, or the proinflammatory arachidonic acid (usually from animal origin) or the anti-inflammatory eicosapentaenoic acid (usually from marine origin), while the sn-1 position predominantly carries a saturated fatty acid, such as stearic acid or palmitic acid. In a normal diet, the daily intake of PC is approximately 2-8 grams (Cohn et al., 2010).

Although there was an extensive research done regarding effects of dietary phospholipids on different groups of illnesses, including human clinical trials supporting positive effects, the underlying physiological mechanisms have not been fully addressed so far.

1.2.2.2 Decrease of stomach irritation by NSAIDs

Non-steroidal anti-inflammatory drugs (NSAIDs) inhibit the activity of the cyclooxygenase (COX enzymes; COX-1 and -2), reducing the production of prostaglandins, which are responsible for the pain symptoms and the related inflammatory reactions. However, gastroduodenal ulceration and bleeding are the major limitations to the chronic use of NSAIDs. The damage to the gastroduodenal mucosa is caused via several mechanisms, including the topical irritant effect of these drugs on the epithelium, impairment of the barrier properties of the mucosa, suppression of gastric prostaglandin synthesis, reduction of gastric mucosal blood flow and interference with the repair of superficial injury (Wallace, 2000). Though one of the main reasons could be attributed to systemic COX inhibition (mainly COX-1), there are several indications, that NSAIDs are also acting locally on the gastrointestinal mucosa (Langenbach et al., 1995; Ligumsky et al., 1983). Lichtenberger et al. investigated the hydrophobic lining of the gastric surface by contact angle analysis (Hills, Butler, and Lichtenberger, 1983; Lichtenberger et al., 1983). It has been demonstrated that highly hydrophobic, non-wettable properties of the stomach mucosa were responsible for protecting the underlying epithelium from gastric acid and other luminal toxins. This biophysical property was contributed to the presence of extracellular lining of zwitterionic phospholipids. On the other hand, aspirin and other NSAIDs have the ability to transform rapidly, within minutes after administration, the gastric mucosa from non-wettable to a wettable state, thereby increasing the tissue's susceptibility to the corrosive actions of gastric acid (Lichtenberger et al., 2006) (Figure 11).

Based on these findings, the concept of pre-associating NSAIDs with zwitterionic phospholipids prior to administration was introduced (Lichtenberger et al., 1995) and tested in clinical studies, where a significant decrease in toxicity was found (Anand et al., 1999). Overall, the drug and phospholipid are dissolved in organic solvent with or without heating under reflux followed by solvent evaporation. The remaining drug-lipid film represents the final product, which further could be processed into final dosage forms by granulation or filling into capsules. It was hypothesized, that the carboxylic function in acidic NSAIDs (which is undissociated at the acidic pH value of gastric juice) ionized and associated with the quaternary ammonium group of zwitterionic phosphatidylcholine, as the drug was exposed to the pH gradient within the mucus layer (Lichtenberger et al.,

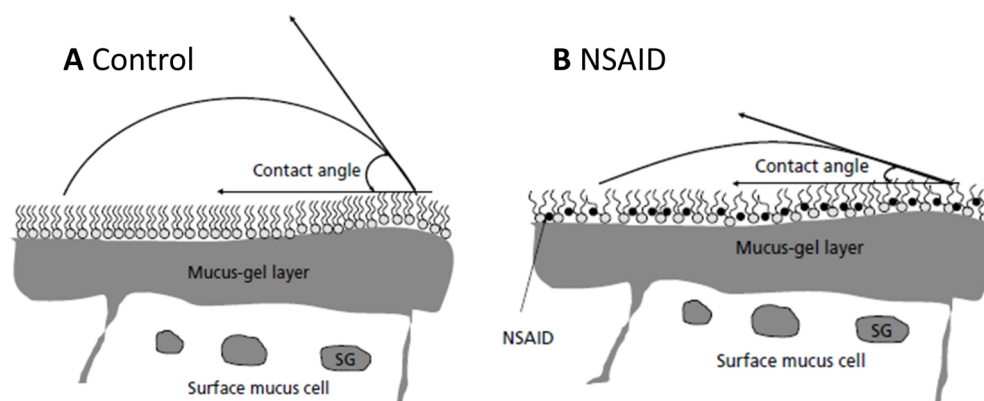

Figure 11. Schematic molecular model of putative phosphatidylcholine enriched monolayer at the interface between the gastric mucus gel and the gastric juice to provide an acid repellent surface hydrophobic barrier. This property can be determined by measuring the contact angle at the air–liquid–solid interface. Schematic depiction of the hydrophobic properties of the gastric mucosa under control conditions (**A**) (contact angle readings between 60–80°) and after the stomach has been exposed to a luminal NSAID and surface hydrophobicity is reduced (**B**) (contact angle readings <40°). SG, secretory granule. Adopted from Lichtenberger et al., 2006, with a kind permission from John Wiley and Sons.

1995). Furthermore, numerous studies have been performed to elucidate the nature of NSAID–phospholipid interaction (Lopes et al., 2004; Marlene Lúcio et al., 2008; Moreno et al., 2009; Panicker et al., 1995). It has been suggested, that the formation of isolated 1:1 drug–phospholipid-complexes with a preferential location at the polar head group, were stabilized by cation- π interaction, and seemed reasonable in organic solvents, whereas it was found, that mainly liposomal and micellar structures were formed upon hydration of the drug–phospholipid-complexes. Hence, the term “NSAID–phospholipid-complex” could be misleading in the context of physiologically relevant aqueous media (Hüsch et al., 2011).

Finally, the product, Aspertec[®] 325 mg, based on the PLxGuard[™] technology, has been NDA-approved by the FDA. PLxGuard[™] delivery system used phospholipids and free fatty acids to modify the physicochemical properties of various drugs and to selectively release these drugs to targeted portions of the GI tract. Unlike tablet or capsule polymer coating technologies (e.g. enteric coating), which rely drug release on pH differences in the GI tract, the PLxGuard[™] system used the differential in pH as well as bile acid contents between the stomach and duodenum to target the release of the NSAID. This approach was intended to release active pharmaceutical ingredients more reliably in the duodenum and decrease their exposure to the stomach, which is more susceptible

to NSAID-induced bleeding and ulceration (Cryer et al., 2011; Lanza et al., 2008; PLX Pharma Inc., 2017).

1.2.2.3 Taste masking

The unpleasant taste of drug formulations attributed to the active ingredients or additives reduces the acceptance of several medications and hence may result in low patient compliance.

Phosphatidic acid was successfully used to mask bitter taste, as demonstrated by a study, where an electronic taste sensor was developed in order to measure the masking efficiency of the quinine (Nakamura et al., 2002). Furthermore, the selectivity of phospholipids to mask only bitter flavours, while not affecting others, was established in a study on volunteers, where soy lecithin, phosphatidic acid and phosphatidylinositol were used (Katsuragi et al., 1997). Takagi et al. had similar findings, applying a cocktail comprised of 15–20% phosphatidic acid, 40% phosphatidyl inositol, 10–15% phosphatidyl ethanolamine and 5% phosphatidylcholine in an electronic tongue device (Takagi et al., 2001). Besides phosphatidic acid, hydrated PC can also be used to mask the taste of active ingredients, as shown by Fini et al., who masked the taste of ibuprofen in tablets (Fini et al., 2008).

1.2.2.4 Bioavailability enhancement

The increasing number of poorly water-soluble drug candidates in the pipelines of pharmaceutical industry leads to emerging of the advanced drug delivery systems, which would be able to increase their bioavailability. Many of these drugs, are class 2 drugs, according to Biopharmaceutics Classification System (BCS) (low solubility, high permeability). Consequently, the solubility and dissolution rates in the gastrointestinal tract are the limiting steps for their absorption. Furthermore, BCS class 4 drugs (low solubility, low permeability), also constitute substantial portion of drug candidates. Thus, intestinal permeability is the rate limiting step, however, before these drugs still need to dissolve.

There are two general principles to improve bioavailability of BCS 2 and 4 class drugs. First, to increase dissolution rate and second, to deliver compounds already molecularly dispersed in suitable solvent system. The first approach includes dosage systems, where

dissolution rate is enhanced either by increasing surface area (e.g. nanoparticle) or by stabilizing an amorphous form of the drug in matrix (i.e. polymer, lipid etc.) (solid dispersions). The second principle covers a wide number of systems, where lipids and surfactants are used to deliver drug in solution (i.e. oil solutions and emulsions to self-emulsifying drug delivery systems).

There is a number of drug delivery systems implying phospholipids for drugs, that exhibit poor water solubility (e.g. liposomes, mixed micelles, emulsions, self-emulsifying drug delivery systems, solid lipid nanoparticles, suspensions, solid dispersions) (Fricker et al., 2010).

Most of these delivery systems would result in liquid or semi-liquid systems, which require either solidification techniques for further processing into final dosage forms (Janin, Musakhanian, and Marchaud, 2008) by capsule filling and/or tableting (Bremmell et al., 2013 or liquid filling into capsules (Savla et al., 2017). Additionally, these are complex multicomponent systems, comprised of several lipid phase components and emulsifiers (Pouton and Porter, 2008). There is quite extensive list of commercialized products (Table 4), however, very few of them actually contain phospholipids, which would mainly serve as an oil phase constituents or co-emulsifiers.

As it appears from Table 4, there are few products on the market, that contain lecithin or particular phospholipids, while majority contains digestible oils (i.e. soybean oil) and/or surfactant systems.

Table 4. Commercially available Lipid-based products for oral administration.

| Trade name | Molecule | Therapeutic use | Company | Oils phase components |
|-------------------------|----------------|--------------------|-----------------|---|
| Drisdol [®] | Ergocalciferol | Vitamin D analog | GlaxoSmithKline | Soybean oil |
| Rocaltrol [®] | Calcitriol | Calcium regulator | Roche | Fractionated triglycerides of coconut oil |
| Depakene [®] | Valproic acid | Anti-epileptic | AbbVie | Corn oil |
| Accutane [®] + | Isotretinoin | Anticomedogenic | Roche | Beeswax, hydrogenated soybean oil flakes, hydrogenated vegetable oil, soybean oil |
| Sandimmune [®] | Cyclosporin A | Immuno-suppressant | Novartis | Olive oil |

| Trade name | Molecule | Therapeutic use | Company | Oils phase components |
|--------------------------|---------------------|--|-----------------------------------|---|
| Marinol [®] | Dronabinol | Antiemetic | AbbVie | Sesame oil |
| Lamprene [®] + | Clofazimine | Treatment of leprosy | Alliance laboratories | Beeswax |
| Zantac [®] + | Ranitidine | Antihistaminic | Glaxo Group Ltd | Medium chain triglycerides |
| Neoral [®] | Cyclosporin A | Immuno-suppressant | Novartis | Corn oil mono-di-triglycerides |
| Vesanoid [®] + | Tretinoin | Anticomedogenic | Cheplapharm | Beeswax, hydrogenated soybean oil flakes, hydrogenated vegetable oil, soybean oil |
| Norvir [®] | Ritonavir | HIV antiviral | Abott | Oleic acid, polyoxyl 35 castor oil |
| Fortovase [®] + | Saquinavir | HIV antiviral | Roche | Medium chain mono- and di-glycerides |
| Prometrium [®] | Progesterone | Hormone therapy for menopausal symptoms | AbbVie | Peanut oil, lecithin |
| Agenerase [®] + | Amprenavir | HIV antiviral | GlaxoSmithKline | |
| Targretin [®] | Bexarotene | Treatment of cutaneous manifestations of cutaneous T-cell lymphoma | Valeant Pharmaceutical Luxembourg | Fractionated triglyceride of coconut oil |
| Hectorol [®] | Doxercalciferol | Vitamin D analogue | Genzyme | Coconut oil |
| Rapamune [®] | Sirolimus | Immuno-suppressant | Pfizer | Phosphatidylcholine mono- and di-glycerides, soy fatty acids, ascorbyl palmitate |
| Gengraf [®] | Cyclosporin A | Immuno-suppressant | Abott | |
| Kaletra [®] + | Ritonavir/lopinavir | HIV antiviral | Abott | Oleic acid, polyoxyl 35 castor oil |

| Trade name | Molecule | Therapeutic use | Company | Oils phase components |
|-----------------------|---------------------------|---|-----------------------------------|---|
| Avodart [®] | Dutasteride | Treatment of symptomatic benign prostatic hyperplasia | GlaxoSmithKline | Mono-di-glycerides of caprylic/capric acid |
| Claravis [®] | Isotretinoin | Anticomedogenic | Teva | Hydrogenated vegetable oil, soybean oil, white wax |
| Lovaza [®] | Omega-3-acid ethyl esters | Lipid-regulating agent | SmithKline Beecham | Soybean oil |
| Aptivus [®] | Tipranavir | HIV antiviral | Boehringer Ingelheim | Mono-/di-glycerides of caprylic/capric acids |
| Zemplar [®] | Paricalcitol | Vitamin D analogue | AbbVie | Medium chain triglycerides fractionated from coconut oil or palm kernel oil |
| Amitiza [®] | Lubiprostone | Management of chronic idiopathic constipation | Sucampo Pharma, LLC | Medium chain triglycerides |
| Lipofen [®] | Fenofibrate | Lipid regulating agent | Cipher Pharmaceuticals Inc. | |
| Hycamtin [®] | Topotecan HCl | Cancer drug | Novartis | Hydrogenated vegetable oil |
| Claritin [®] | Loratadine | Antihistaminic | Bayer | Caprylic/capric glycerides |
| Absorica [®] | Isotretinoin | Anticomedogenic | Sun Pharmaceutical Industries Ltd | Soybean oil, stearyl polyoxyglycerides |
| Xtandi [®] | Enzalutamide | Cancer drug | Astellas Pharma | Caprylocaproyl polyoxyglycerides |
| Ofev [®] | Nintedanib | Treatment of idiopathic pulmonary fibrosis | Boehringer Ingelheim | Medium-chain triglycerides, hard fat |

| Trade name | Molecule | Therapeutic use | Company | Oils phase components |
|------------|--------------------------|-----------------------------|----------------------|--|
| Rayaldee™ | Calcifediol | Vitamin D analogue | Opko Ireland Global | Mixture of lipophilic emulsifier with a HLB <7 and an absorption enhancer with HLB of 13-18; Oily vehicle - mineral oil, liquid paraffins, or squalene |
| Cipro® | Ciprofloxacin | Antibiotic | Bayer | Medium-chain triglycerides soy-lecithin |
| Sustiva® | Efavirenz | HIV antiviral | Bristol-Meyers | Medium-chain triglycerides |
| Fenogal® | Finofibrate | Lipid regulating agent | Genus | |
| Restandol® | Testosterone undecanoate | Hormone replacement therapy | Organon laboratories | Castor oil |
| Convulex® | Valproic acid | Anti-epileptic | Pharmacia | |

⁺ discontinued

Prometrium® contains progesterone (100 mg and 200 mg), which is used in combination with estrogens mainly in hormone therapy for menopausal symptoms and low sex hormone levels in women. Drug was micronized as a suspension in peanut oil, whereas lecithin (approx. 0.4%) was used as a stabilizer, further the system is filled into soft capsules.

Oral solution of ciprofloxacin (Cipro®) is indicated in numerous bacterial infections (urinary tract infections; lower respiratory tract infections skin and skin structure infections etc.) and was formulated to achieve flexible dosing for paediatric population as well as to improve patient compliance among geriatric population. Ciprofloxacin, however, has particularly unpleasant long-lasting bitter taste. Besides complete concealment of the taste, a rapid and complete release of the active ingredient is unconditionally to be demanded, in order to guarantee bioavailability equivalent to the tablets. The successful

taste-masking with simultaneously rapid and complete bioavailability of the active ingredient was achieved by microencapsulation of the active ingredient and further microcapsules redispersion in the oily digestible vehicle. Lecithin contained in the formulation (approx. 0.5 to 5%) is one of the wetting agents used to increase the water tolerance of an oily formulation and, on the other hand, facilitate the wettability of the microcapsules during incorporation into the oily excipient liquid (US Patent US08191741).

Rapumine[®] is the only product so far, which contains phospholipids as a main solubilizing vehicle. It is an oral formulation of the immunosuppressant rapamycin, sirolimus[®] (marketed under the trade name Rapamune[®] by Pfizer), which is mainly used to prevent rejection of kidney transplants. PHOSAL[®] 50 PG is a standardized phosphatidylcholine concentrate with at least 50% PC in propylene glycol, containing lecithin, sunflower mono- and diglycerides and ascorbyl palmitate. The manufacturer of Rapamune[®] recommends to mix the dose with at least 60 ml of water or orange juice, but not any other liquids, to stir the emulsion vigorously, to drink it immediately followed by another 120 ml of water or orange juice. A previous study investigated the impact of two different formulations of Sirolimus[®] on blood levels and the development of arthritis induced in rats (Carlson et al., 1998). On the one hand, Sirolimus[®] was formulated as a suspension with TWEEN[™] 80 (Polysorbate 80) (polyethylene glycol sorbitan monoelate), and on the other hand as a highly water-diluted emulsion containing PHOSAL[®] 50 PG and 1% TWEEN[™] 80. With all orally administered doses (0.5 mg/kg, 1.5 mg/kg and 4.5 mg/kg), the blood levels of the active ingredient were higher with the vehicle containing phosphatidylcholine. These higher blood levels correlated positively with the therapeutic effect on arthritic symptoms in the animals. With the PHOSAL[®] 50 PG formulation, approximately one-sixth of the dose proved sufficient to inhibit the arthritis, demonstrating that the application of phosphatidylcholine improved the absorption, effectiveness, and therapeutic index of the active ingredient.

Solid dispersions of drugs in phospholipid matrix is another popular approach being addressed extensively in the research field. It is intended to “solubilize” crystalline drug in phospholipid matrix, producing solid dispersions, with several points in mind. Namely,

amorphization of poorly soluble crystalline drug would potentially increase its dissolution rate and extent. Further, it is believed, that once orally administered diacylphospholipids form liposome-like vesicles upon hydration, which further promote drug dissolution rate due to increased surface area of colloidal suspension formed. Additionally, as it was previously discussed, initiated digestion process of the liposomal phospholipids, may increase the solubilizing capacity by forming endogenous mixed micelles. The most recent and extensive review and meta-analysis prepared by Fong et al. compiled (Fong, Ibisogly, and Professor, 2015) 112 research articles and 82 patents, which involved solid phospholipid-based formulations, out of which 54 articles and 13 patents were described in detail (Figure 12).

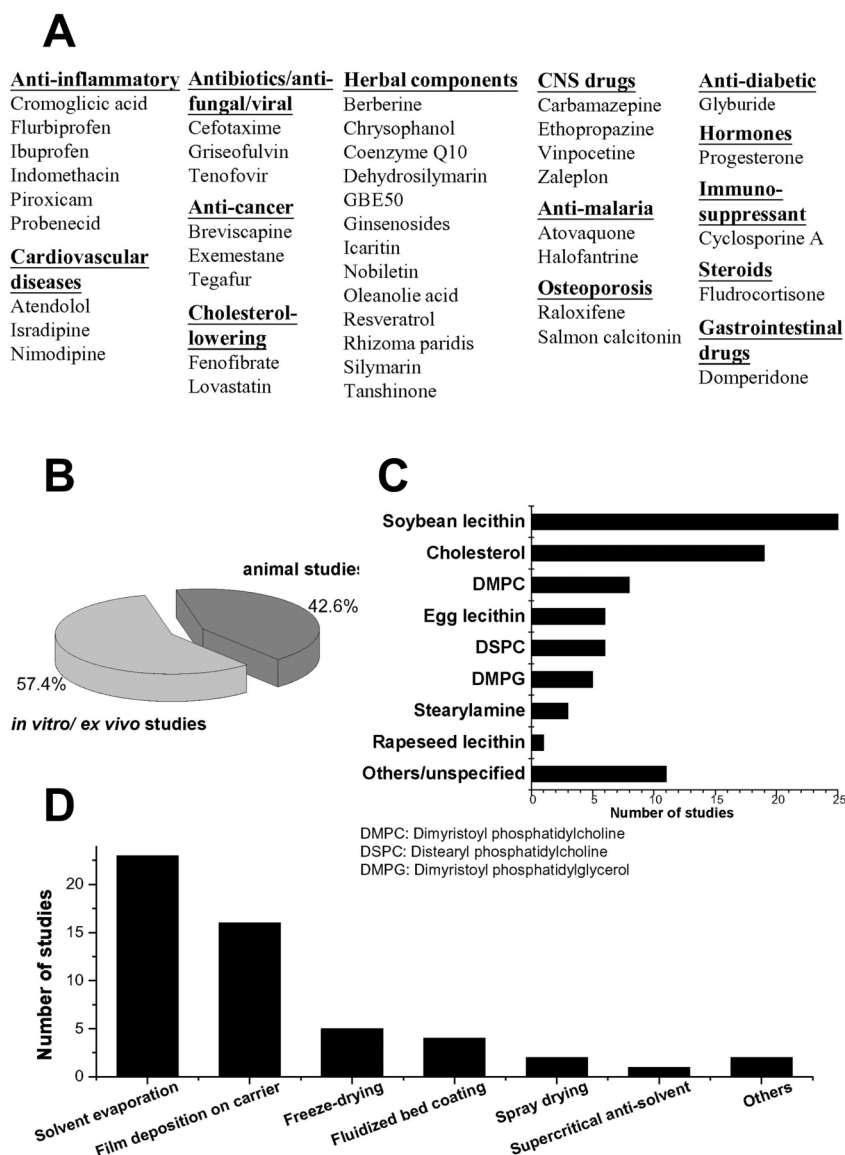

Figure 12. Summary of studies employing solid phospholipid-based formulations for oral drug bioavailability enhancement in terms of (A) drugs being formulated; (B) the types of study for evaluating their biopharmaceutical performance; (C) the lipid excipients employed; and (D) the process methods Adopted from Fong, Brandl, and Bauer-Brandl, 2015 with permission from Elsevier.

The summary from meta-analyses revealed that PL-based solid formulation produced favourable biopharmaceutical enhancement effects on drugs. The highest enhancement effect (in average) was found on drug solubility (2.27-fold), followed by permeability (1.6-fold) and oral bioavailability (1.18-fold); whereas it has negligible effect on C_{max} .

Furthermore, an optimization of the drug to lipid ratio and the selection of the most suitable phospholipid for the formulation with drug in question should be performed.

Although, there were attempts made, to predict the technical feasibility of amorphous

drug-phospholipid systems, with respect to degree of solubilization of the drug in the dry and hydrated state (Fong et al., 2016, Fong, Ibisogly, and Professor, 2015, Gautschi, Van Hoogevest, and Kuentz, 2015). So far, there was no systematic research published, which compared saturated and unsaturated mono- and diacyl-phospholipids in order to assess reasoned selection of phospholipid and its ratio to the drug. Moreover, the reliable and easy to apply screening methods are also still lacking in this field, as well as stability data of phospholipid / drug solid dispersions. On the one hand, solid phospholipid formulations have improved physical and chemical stability during storage, since they can avoid the stability problems associated with the conventional liposomes such as aggregation, susceptibility to hydrolysis and oxidation, while on the other hand, the ability to maintain dispersed drug in amorphous state during long term storage, as well as factors which would impact drug physical stability and formulation performance are not reported in research literature.

1.2.2.5 Controlled release of lipid-based formulations

The term “lipid” describes a family of products with diverse physicochemical properties, which includes oils, fats, waxes and fatty acids. Naturally occurring lipids are typically triglycerides, esters of glycerol and three fatty acids (triacylglycerols). These glycerides exhibit wide variety in acid chain length and saturation. In oral drug delivery, short chain and unsaturated long chain fatty acids are widely adopted to effectively maintain the solubility and increase the bioavailability of poorly soluble drug compounds (discussed in Section 2.2.2), while long chain saturated fatty acids are solid at ambient temperature and water insoluble, showing potential for sustained release of water soluble drugs.

Over last decades naturally occurring triglycerides have been physicochemically modified to develop excipients suitable for the development of drug delivery systems (Fahy et al., 2005). In contrast to polymers, solid lipids are crystalline in nature and do not exhibit a glass transition (T_g) or minimum film forming temperature (MFT). Instead they have reasonable melting ranges or melting points (approx. 45 to 85°C), which are determined by their chemical structure (and composition). The versatility of lipid excipients has been successfully illustrated by the variety of processing techniques including cold (compression) and hot (melt) processes.

Table 5. Solid lipids used in sustained release drug delivery systems. Adopted from Rosiaux et al., 2014 with permission from Elsevier.

| Lipid excipient | Chemical composition | Properties | Examples | Process |
|--------------------|---|------------------------------------|--|-----------|
| Waxes | Esters of fatty acids and long chain alcohols | Hydrophobic MP = 62–86 °C | Carnauba wax, candelilla wax, rice bran wax, beeswax, solid paraffin (Sasolwax [®] 6403), cetyl palmitate (Precifac [®]) | Cold, hot |
| Vegetables oils | Mixture of triglycerides, free fatty acids, phospholipids | Often digestible MP = 60–71 °C | Hydrogenated cottonseed oil (Lubritab [®] , Sterotex [®]), hydrogenated soybean oil (Sterotex [®] K) | Cold, hot |
| Polyoxylglycerides | Mixture of glycerides and esters of fatty acid and PEG | Partially digestible MP ≈ 50 °C | Stearoyl polyoxyl-6 glycerides (Gelucire [®] 50/02), stearoyl polyoxyl-32 glycerides (Gelucire [®] 50/13) | Hot |
| Fatty acids | Long chain fatty acids | MP = 60–90 °C | Palmitic acid, stearic acid, behenic acid | Cold, hot |
| Triglycerides | Monoacid triglycerides | MP = 46–73 °C | Glyceryl tripalmitate (Dynasan [®] 116), Glyceryl tristearate (Dynasan [®] 118) | Cold, hot |
| Partial glycerides | Mixtures of mono-, di-, and triglycerides | MP = 54–74 °C | Glyceryl distearate (Precirol [®] ATO 5), glyceryl monostearate (Myvaplex [™] 600; Imwitor [®] 491), glyceryl behenate (Compritol [®] 888 ATO) | Cold, hot |
| Fatty alcohol | Mixture of fatty alcohols | MP = 48–56 °C | Cetostearyl alcohol, cetyl alcohol | Cold, hot |

Surprisingly, there were only few articles found using phospholipids, (i.e. hydrogenated soy bean lecithin) compared to a vast number of reports with other lipids as it has been extensively revised in literature (Table 5) (Feng and Zhang, 2017; Rosiaux et al., 2014). Fujii et al. evaluated the release rates of acetaminophen from matrix tablets prepared by direct compression as an effect of release medium pH and phospholipid species used as a matrix former (Fujii et al., 1998). The direct relationship between the drug release rate and matrix hydration rate was established, which was conditioned by the phospholipid ionization state at different pH, and therefore should be taken into account when controlled release formulations are intended with phospholipids.

Fini et al, reported that the ibuprofen release was delayed compared to pure ibuprofen,

when was previously wet granulated with hydrogenated phosphatidylcholine powder (Phospholipon[®] 80H, PC content 60%, reported as lecithin). Ibuprofen and lecithin were granulated at 4:1 weight ratio with water and compressed into fast dispersing tablets at ca. 40% (w/w) content.

Another study also confirmed the controlled release potential of hydrogenated soybean lecithin (Nishihata, Nakano, and Yamazaki, 1987). The sustained-release tablet of sodium diclofenac (SR-tablet) was prepared compressing granules of sodium diclofenac and theophylline with hydrogenated soya lecithin without any other additives. Granulation was achieved by kneading drug and lecithin powders at 1:4 weight ratios with ethanol, followed by drying. The dissolution of sodium diclofenac from the sustained release tablet occurred in an apparent zero-order kinetics with 90% released at 24 hours. The human subjects to whom the sustained release tablet was administered excreted diclofenac in urine gradually up to 24 hours, while control formulation of diclofenac, was excreted rapidly within 9 hours after administration. Similarly, extended release *in vivo* was confirmed for diclofenac sodium and theophylline in beagle dogs. The oral administration of SR-tablets to dogs avoided a transient peak of drug concentration in the plasma and maintained plasma drug concentrations at higher levels for a longer period, in comparison to the orally administered theophylline suspension and commercial (immediate release) tablet of sodium diclofenac (Nishihata, Nakano, and Yamazaki, 1987).

The straightforward processing methods such as direct compression and wet granulation are sometimes unsuitable for the formulation properties or the desired drug release profile and, therefore, other techniques are applied.

Molding is one of the simplest and functionally effective ways to produce lipid-based sustained drug delivery systems. The lipid excipient is completely melted and the drug dispersed within the melt. The molten drug–lipid mass is directly filled into a casting mold system allowing for different shapes and sizes. Chime et al. has reported the use of hydrogenated phosphatidylcholine (Phospholipon[®] 90H) in mixture with hydrogenated palm oil (Softisan[®] 154) at different weight ratios to prepared sustained release moulded tablets of diclofenac sodium (Chime, 2013). The mixtures of phospholipid and hydrogenated palm oil were prepared by fusion. In each case the lipids were weighed, melted

together and stirred at a temperature of 70°C using a magnetic stirrer until a homogeneous, transparent white melt was obtained, further drug powder was dispersed in resulting melt followed by filling into mould and solidification at room temperature.

The hot techniques are manifold and their use generally depends on the equipment available and the desired product application. The use of phospholipids, however is almost inexistent, compared to the conventional and synthetic lipids (Table 6).

Melt granulation is rapid, single-step, solvent-free method, it can be advantageous for extended release formulations which require high drug loadings or use freely water-soluble drugs. Generally, all ingredients are pre-blended in a high shear mixer before the temperature is slowly increased to the lipid melting point. Due to subsequent (partial) fusion of the lipid, particles bind together and build free flowing granules. Temperature is a critical processing parameter and must be well controlled to avoid insufficient granulation or 'over wetting' resulting in undesired particle agglutination. Using lipid excipients as binder for solvent-free granulation facilitates drug bonding and reduces dosage form wettability, which subsequently leads to slower drug release. This technique has the advantages of simplicity, high drug loading and the flexibility to produce different dosage forms; however, the reproducibility of conventional melt granulation can be an issue due to the inherent physicochemical properties of the lipid excipients.

Furthermore, an increasingly popular is hot melt extrusion (HME), a continuous production process, which is reported to be straightforward to scale up. The combination of low melt viscosity of certain lipid excipients and the shear forces developed during extrusion, enable the processing of higher drug contents, whilst providing very homogeneous drug in lipid dispersions (Feng and Zhang, 2017).

Table 6. Examples of lipid excipient-based, sustained-release dosage forms prepared using twin-screw extrusion process. Adopted from Feng and Zhang, 2017 with permission from Springer Nature.

| Lipid excipients | Pore-forming agents | Manufacturing processes |
|--|---|---|
| Glycerol distearate, hydrogenated vegetable oil | Microcrystalline cellulose and lactose | Melt granulation |
| Glyceryl palmitostearate, glyceryl trimyristate | None | Extrusion and direct shaping into cylinders |
| Microcrystalline wax | None | Extrusion and direct shaping to cylinders |
| Calcium stearate, glycerol stearate | None | Extrusion and pelletization |
| Glycerol tristearine, various low melting point lipids | PEG 4000 and PEG 6000 (intra-extrudate) | Extrusion into rods, then milling into granules |
| Glyceryl palmitostearate, glycerol behenate | Hypromellose and polyethylene oxide (intra-extrudate) | Direct moulding |
| Glycerol behenate | Sorbitol (extra-extrudate) | Melt granulation and compression |
| Stearic acid | Hydroxypropyl cellulose (intra-extrudate) | Melt granulation and compression |
| Stearic acid, white wax, carnauba wax | PEG and poloxamer (intra-extrudate) | Coextrusion and direct shaping into rods |
| Stearic acid | Polyethylene oxide (intra-extrudate) | Melt granulation and compression |
| Stearic acid | None | Melt granulation and compression |

1.2.2.6 Release mechanism

Solid dosage forms made with insoluble lipid excipients were reported remaining intact during drug release without gel formation or erosion of the dosage form/device. This suggested pure Fickian diffusion mechanism, where: (i) water penetrated into the matrix, (ii) dissolved the drug, (iii) occupied the pores generated by the diffusion of dissolved drug particles and (iv) created water-filled channels which increased matrix porosity and drug mobility, allowing for continuous drug diffusion out of the dosage form and into

the release medium. Assuming, that this release mechanism is correct (i.e. that the lipid matrix completely maintains its geometric form during dissolution and pure Fickian diffusion is the underlying drug release mechanism) water diffusion into the device is an important release rate controlling factor. Matrix wettability as well as initial air porosity are hence a key factors, which mainly depend on the properties of the lipid and the drug, as it has been demonstrated (Kreye et al., 2011b). According to the predominant diffusion mechanism, the dosage form dimension should also affect drug release rates from lipid matrices (Güres et al., 2012; Kreye et al., 2011a). Roberts et al. described the need to increased lipid concentrations to obtain sustained release profiles from mini-tablets compared to standard tablets (Roberts et al., 2012). Indeed, larger dimensions lead to longer diffusion pathways (i.e. more time is needed to penetrate the matrix), which delayed drug dissolution, pore creation and drug diffusion. However, it is believed that the effect of device dimension on the entire drug release kinetics becomes minor with drugs being extremely water-soluble (e.g. metformine HCl, bupropion HCl), which require very little water to be completely dissolved and released. Therefore, dissolution and diffusion of the drug after penetration of water into the device take place more rapidly compared to water-soluble drugs, reducing the effect of product dimension.

2 Research Objectives

- To characterize phospholipid materials in terms of processability into solid dosage forms suitable for oral drug delivery
- To evaluate methods to process high amounts of phospholipids in the tablets, thus allow to consider them as functional excipients to serve variety of needs
- To evaluate the general applicability of hydrogenated phosphatidylcholine as a release retarding matrix-former for direct compression and to establish clear cause-effect relationships between formulation parameters and drug release rate
- To understand the mechanism of pH- dependent behaviour of phosphatidylcholine powder and to explore methods to minimize or disguise it in drug formulations
- To evaluate the feasibility of processing hydrogenated phosphatidylcholine by hot melt extrusion and to explore release rate controlling potential of resulting matrices with special attention to high loadings of water-soluble model drugs

3 Results and Discussion

3.1 Characterization of Rheological Properties of Phospholipid Powders and Evaluation of Their Processability into Solid Oral Dosage Forms

3.1.1 Background

Phospholipids (PL) have become attractive candidates as carriers for oral formulations during the last years, due to their physiological role in absorption processes and physico-chemical diversity, capacity to enhance oral bioavailability of poorly water-soluble drugs, their favorable biocompatibility and lack of toxicity (Fong, Brandl, and Bauer-Brandl, 2015).

A number of described lipid based systems, (pro)liposomes, oils, emulsions, self-emulsifying drug delivery systems (SEDDS), solid lipid nanoparticles, suspensions and solid dispersions (Fricker et al., 2010) requires capsule filling for successful oral delivery, which could be technologically challenging. Tablets, on the other hand, are the most popular and preferred oral dosage forms in terms of precision of unit dose, low cost, patient compliance, and good physical and chemical stability. There are, however, just few studies, which have evaluated conventional dosage forms such as tablets containing phospholipids. In the reported studies, phospholipids were used as gastric mucosa protector in administration with NSAIDs (Anand et al., 1999; Dial et al., 2008), taste masking agent (Fini et al., 2008; Katsuragi et al., 1997) and drug release retarding agent (Chime, 2013; Fini et al., 2008; Raffin et al., 2009). Phospholipids have been wet granulated with model drugs and their effect on studied parameters has been determined, however, general effects on tablet processing have not been addressed. It is, therefore, of an interest to evaluate the processability of phospholipids in tablets, irrespective of whether solubilisation / bioavailability enhancement of insoluble drugs or the controlled release of soluble drugs

at higher loadings is in focus.

Powder flow and hygroscopicity were identified as essential material properties to assess its general applicability for tableting and to define suitable methods for its processability (Banker and Rhodes, 1990).

Uniform weight of tablets is achieved by feeding constant volumes of homogeneous materials to the dies of the tableting press. Therefore, to avoid material segregation during mixing and feeding, excipients should possess comparable particle size and bulk densities, hence material powder characteristics would strongly influence the choice of tableting methods (e.g. direct compression, wet and/or dry granulation).

Additionally, moisture content present in the material during manufacture, as well as that in the final product contributes to the behaviour of many tablet formulations, in addition to its potentially adverse effect on stability. Therefore, the material behaviour at different relative humidity levels is essential knowledge for choosing strategies for its further processing.

The aim of this work was, thus, to characterise phospholipid powders in terms of processability to solid dosage forms suitable for oral drug delivery and to evaluate the methods to achieve high amounts of phospholipids in the tablets, thus allow to consider them as functional excipients to serve variety of needs.

3.1.2 Materials and Methods

Lipoid S 45, Lipoid S 75, PHOSPHOLIPON[®] 90 G, PHOSPHOLIPON[®] 80 H, PHOSPHOLIPON[®] 90 H, Lipoid R LPC 20, Lipoid S LPC 80 (Lipoid GmbH, Ludwigshafen, Germany); Avicel[®] PH101, Avicel[®] PH 102, Ac-Di-Sol[®] (FMC Corp. Pennsylvania, United States); Ludipress[®] 200 (BASF Group, Ludwigshafen, Germany); GranuLac 200[®] (Meggler Pharma, Wasserburg, Germany); Emcompress[®], Prosolv[®] SMCC (JRS PHARMA GmbH & Co. KG, Rosenberg, Germany); Aeroperl[®] 300 pharma (Evonik Industries AG, Essen, Germany); Neusilin[®] US2 (Fuji Chemical Industries Co., Ltd., Japan).

3.1.2.1 Powder flowability

Powder flow properties were assessed with Compressibility Index (Carr's Index) (CI) and Hausner Ratio (HR) measurement. Both were determined according to the method outlined in the USP (Entry 1174). Samples (50-75 g) were passed into a pre-weighed

250 ml graduated cylinder with 2 ml markings. The bulk volume (V_0) was measured after gently shaking the cylinder few times to achieve leveled filling. The tapped volume (V_t) was measured with the Erweka Tap Density Tester (Erweka GmbH, Heusenstamm, Germany) after tapping 1250 taps. Bulk and tapped densities were used to calculate Compressibility Index and Hausner Ratio as follows:

$$CI = \frac{\rho_{\text{tapped}} - \rho_{\text{bulk}}}{\rho_{\text{bulk}}} \times 100\% \quad (\text{Eq. 1})$$

$$HR = \frac{\rho_{\text{tapped}}}{\rho_{\text{bulk}}} \quad (\text{Eq. 2})$$

where, ρ_{tapped} is the tapped density and ρ_{bulk} is the bulk density

3.1.2.2 Characterisation of phospholipids solid state by X-ray diffraction (XRD)

Samples as received were analysed by X-ray diffraction using a Philips X-ray generator PW 1830 (Philips Industrial and Electroacoustic Systems Division, Netherlands) with a diffraction angle range between 4° and $40^\circ 2\Theta$ and a step size of $0.02^\circ 2\Theta$.

3.1.2.3 Powder hygroscopicity: Dynamic Vapor Sorption (DVS)

The moisture uptake studies were performed with a DVS instrument (DVS 1000, Surface Measurement Systems Ltd., UK) at $25 \pm 0.1^\circ\text{C}$. The instrument consisted of a microbalance housed inside a temperature-controlled chamber. The humidity was controlled via switching valves, which control the flow of a dry gas (nitrogen) through a humidification stage. Samples (10 ± 2 mg) were loaded onto a tared sample pan and an empty pan was used as the reference. The samples were dried at $25^\circ\text{C}/0\%$ RH for 180 min and the instrument was programmed for moisture sorption from 0 to 98% RH in 14% RH steps for 90 H; 80 H; 90 G; S 75; S 45 and S LPC 80 and from 0 to 87.5% RH in 12.5% RH steps and 10.5% step till 98% RH for R LPC 20 at $25 \pm 0.1^\circ\text{C}$, at equilibrium condition. The equilibrium condition was set to $<0.05\%$ total mass change within 5 min and with a maximum dwell time of 180 min.

Isotherms were calculated using the DVS Advanced Analysis Suite from the complete sorption and desorption profiles. Sorption and desorption rates of different PL were compared by converting polynomial sorption profiles into linear function and comparing resulting slopes' values.

3.1.2.4 Wet granulation

Pestle and mortar was used for wet granulation. Combination of microcrystalline cellulose (MCC) (Avicel[®] 101) and lactose (GranuLac[®] 200) at the 1:3 ratio was used as fillers for granulation. Ethanol 96% (v/v) was used as a granulating fluid. Wet mass was passed through 800 μ m sieve, resulted granules were dried in ventilated oven at 40°C overnight. Batches of ca. 10 g were produced.

3.1.2.5 Direct compression

Phospholipid powders (as received) were blended with additional excipients for 10 min in a Turbula mixer (Willy A. Bachofen AG, Basel, Switzerland), then, 1% w/w magnesium stearate was added and further mixed for 3 min.

3.1.2.6 Tableting

Flat-faced, 8 mm diameter, tablets were compressed using single punch tablet press (Korsch EKO, Korsch Pressen GmbH, Berlin, Germany). The tablets were characterized for their dimensions and hardness (Multicheck, Erweka GmbH, Heusenstamm, Germany). Disintegration time was determined by PharmaTest Dist-3 (Pharma Test Apparatebau AG, Hainburg, Germany) in 0.1N HCl at 37°C.

3.1.2.7 Phospholipids adsorption onto carrier

Phospholipids were dissolved in warm ethanol (50°C) at the 50% w/v and added to a carrier under continuous mixing in a Mixer Torque Rheometer (Caleva Process Solutions Ltd. Dorset, England) at different lipid to carrier ratios. The resulted wetted powder or past-like mass was dried in the ventilated oven at 40°C overnight and once dry, sieved if needed.

3.1.3 Results and Discussion

3.1.3.1 Physical characterization and rheological properties of PL powders

Grades of phospholipid differing in purity, side chains and saturation were evaluated (Table 7). Unsaturated phospholipids presented as coarse agglomerates ranging from brown-yellow to pale yellow color as a function of phosphatidylcholine (PC) content, while saturated phospholipids were fine white powders.

Table 7. Summary on appearance and composition of studied phospholipid powders.

| Unsaturated phospholipids | | Saturated phospholipids |
|--|---|--|
| Monoacyl- | Diacyl- | |
| Lipoid R-LPC 20 min. 20° PC, min. 20% MA-PC, brown agglomerates | PHOSPHOLIPON [®] 90 G min. 90% PC yellowish, waxy granules | PHOSPHOLIPON [®] 90 H min. 90% PC* fully hydrogenated, fine white powder |
| Lipoid S LPC 80 min. 80% MA-PC, 10%PC, yellow agglomerates | Lipoid S 75 min. 70% PC, 7% PE**, max. 3% MA-PC, brown agglomerates | PHOSPHOLIPON [®] 80 H min. 70% PC fully hydrogenated, fine white powder |
| | Lipoid S 45 min. 45% PC*, 10% PE, max. 4% MA-PC***, brown agglomerates | |

*PC – Phosphatidylcholine; **PE – Phosphatidylethanolamine;
***MA-PC – Monoacyl-phosphatidylcholine

The solid state of phospholipid powders was determined with X-ray diffractometer. According to XRD, phospholipids with fully saturated fatty acid chains, as well as monoacyl-PL LPC 80 had crystalline and semi-crystalline structure, while unsaturated 90 G, S 45, S 75 and monoacyl-PL R LPC 20 were amorphous (Figure 13).

Powder flow properties

Powder flow properties of saturated phospholipids, 90 H and 80 H, were assessed with compressibility index and Hausner ratio (Table 8). According to USP provided reference table (Table 9) 90 H presented good flow properties suitable for direct compression,

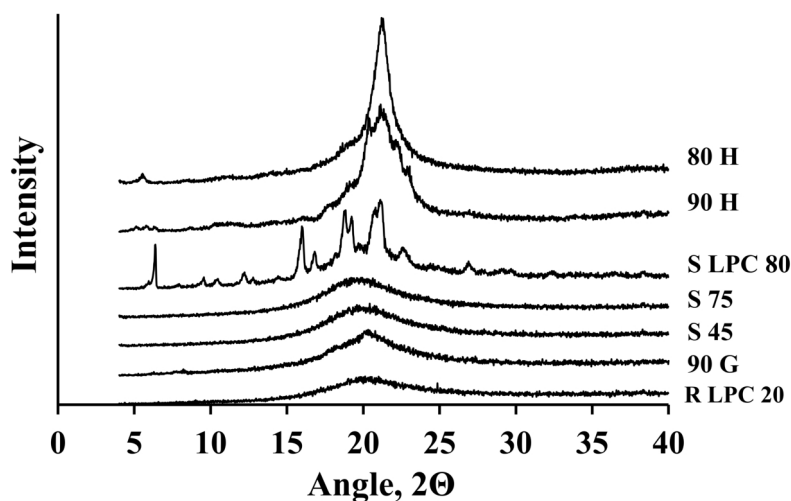

Figure 13. X-ray diffractogram of studied phospholipids (up to down): 80 H; 90 H; LPC 80; S 75; S 45; 90 G; R LPC 20.

whereas 80 H had very poor powder flow capacity. Further laser diffraction particle size analysis of powders revealed that 80 H had fraction with finer particles, which could be responsible for its higher cohesiveness and thus poor flow.

Table 8. Compressibility index and Hausner ratio of saturated phospholipids.

| | Bulk density, g/cm^3 | Tapped density, g/cm^3 | Compressibility index (%) | Hausner ratio |
|------|----------------------------------|------------------------------------|------------------------------|-------------------|
| 80 H | 0.335 ± 0.005 | 0.496 ± 0.027 | 32.45 ± 2.804 | 1.468 ± 0.060 |
| 90 H | 0.567 ± 0.002 | 0.65 ± 0.008 | 12.64 ± 1.207 | 1.154 ± 0.016 |

Table 9. Scale of flowability.

| Compressibility index (%) | Flow character | Hausner ratio of | Compressibility index (%) | Flow character | Hausner ratio |
|------------------------------|-------------------|---------------------|------------------------------|-------------------|------------------|
| ≤ 10 | excellent | 1.00 - 1.11 | 21-25 | passable | 1.26 - 1.34 |
| 11-15 | good | 1.12 - 1.18 | 26-31 | poor | 1.35 - 1.45 |
| 16-20 | fair passable | 1.19 - 1.25 | 32-37 | very poor | 1.46 - 1.59 |

Moisture uptake by phospholipids

Dynamic vapor sorption study was performed with all phospholipid samples, in order to obtain equilibrium moisture content (EMC) at different relative humidity (RH) levels. Furthermore, the sorption and desorption rates of different phospholipids have been

calculated and compared. Equilibrium moisture content at 45% RH was 5.38 and 7.41% for 80H and 90 H, respectively, elevating to 9.30 and 11.00% at 75% RH, and reaching maximum of 24.11% and 20.22 at 98% RH (Figure 14 A and 14 B).

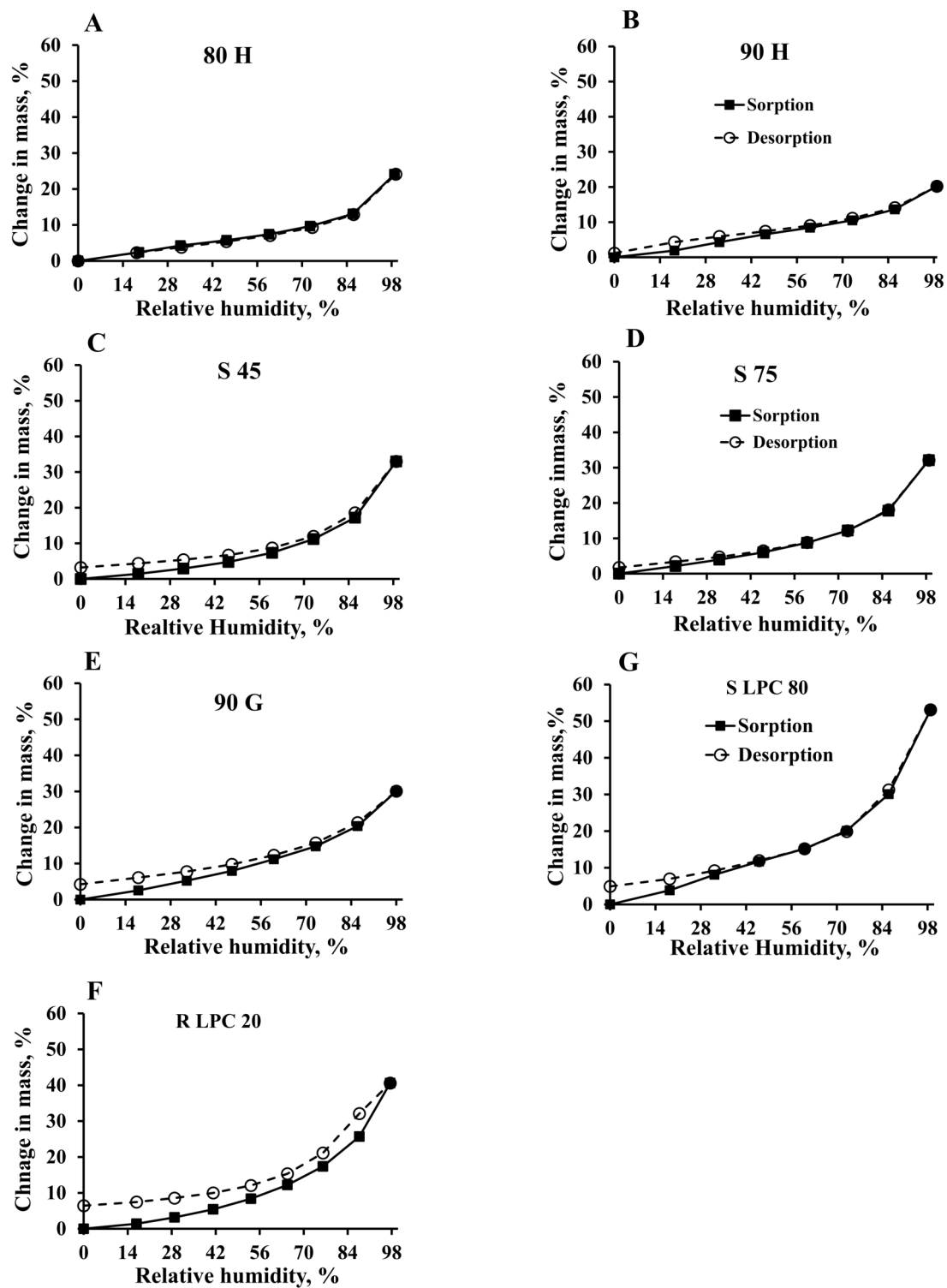

Figure 14. Isotherm plots of studied phospholipids.

Unsaturated phospholipids S 45, S 75, and 90 G at 45% RH had equilibrium moisture content 4.78, 6.04, and 7.94%, respectively, which was comparable the ones of saturated 90 H and 80 H. Further, at RH of 75% these substances reached 17-20% EMC and finally 30-35% at 98% RH (Figure 14 C, D and E). Moreover, isotherms of unsaturated diacyl-PL, S 45, S 75 and 90 G presented open hysteresis loop, hence moisture did not desorb completely even after drying at 0% RH, indicating moisture-induced phase transition, which was in agreement with the observation, that even small amount of absorbed humidity from the environment (e.g. exposure to open air for 1-2 hours) induced visible irreversible morphological changes, converting these phospholipids into paste like substances. Unsaturated monoacyl-PL S LPC 80 and R LPC 20, presented as the most hygroscopic substances. The highest EMC at all RH levels, as well as fastest moisture sorption rate were observed for S LPC 80 (Figure 14 C), however it did not turn into semi-solid paste at room conditions as the other unsaturated PL did. The equilibrium moisture contents for different phospholipids at relative humidity levels of 45, 75 and 98% were summarized in Figure 15.

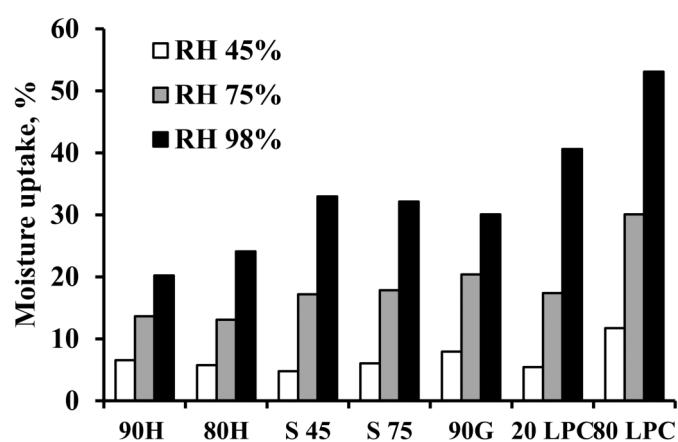

Figure 15. Equilibrium moisture content of phospholipid samples at 45, 75 and 98% relative humidity levels.

In order to estimate how fast moisture uptake occurred, sorption rates have been calculated and compared. First, the relative moisture uptake curves for each humidity step were linearized by applying square roots of time, thus slopes of the resulting linear regression corresponded to the rate of moisture uptake, and were further plotted against corresponding relative humidity values (Figure 16). All studied phospholipids had similar constant sorption rate over wide range of humidity levels, from 14 to 84%, and finally

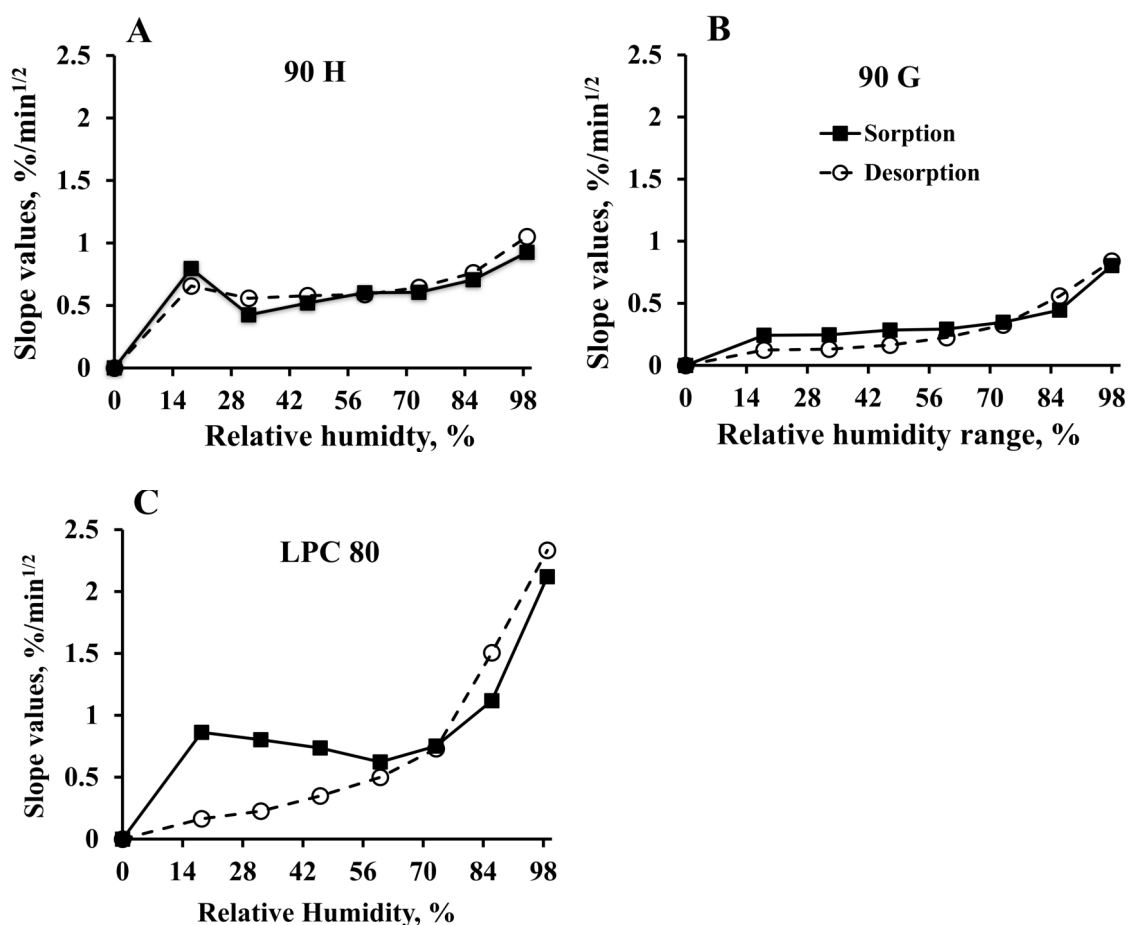

Figure 16. Sorption and desorption rate profiles for (A) saturated Phospholipon 90 H; (B) unsaturated Phospholipon 90 G and (C) monoacyl-Lipoid S LPC 80.

increased rate, corresponding to the RH step from 84 to 98%. Desorption rates were similar to sorption over the whole range of relative humidity levels for saturated PL. On the other hand, for unsaturated PL desorption was faster than sorption at RH 98 to 75%, which corresponded to elimination of bulk water, and then slower at lower relative humidity levels, indicating the difficulty to remove moisture (Figure 16 B), which was in accordance with open hysteresis loop previously observed on the moisture isotherm. Especially remarkable difference was observed for S LPC 80, indicating its hygroscopic nature (Figure 16 C).

According to classification proposed by J.C Callahan (Callahan et al., 1982) samples could be divided into 4 groups according to their equilibrium moisture content. Overall, moisture sorption study showed, that saturated phospholipids could be considered as slightly hygroscopic substances with low constant moisture sorption rate over the wide range of relative humidity levels. Unsaturated phospholipids could be classified as moderately

hygroscopic substances, the moisture uptake at 25°C had low constant rate over wide range of RH, however even amount of moisture adsorbed from the air within few hours on the bench, produced visible morphological changes, converted phospholipid aggregates into semisolid mass. Special packaging and storing conditions were needed for these materials (refrigeration, desiccator chambers and aluminium sacs). Unsaturated S LPC 80 had the highest equilibrium moisture content, and could be considered as highly hygroscopic material, however no visible morphological changes were observed upon moisture uptake. Further treatments should be considered to convert unsaturated phospholipids into flowing powders (e.g. wet granulation), while moisture should be avoided in the manufacture processes, as well as the room humidity and temperature should be controlled.

3.1.3.2 Tableability of phospholipids (placebo study)

Taking into account, that potential solubility enhancing effect by phospholipid dispersions was generally achieved at low drug to lipid ratios, significant phospholipid content should be formulated into solid dosage forms. Therefore, the main goal of this study was to evaluate processability of high PL content by the means of compression. Thus, powders compactability and tablets disintegration times were identified as challenging parameters for immediate release dosage forms formulation, due to stiff and un-porous nature of material, and therefore, were further studied and optimized. As it was suggested in the previous section, direct compression approach was merely feasible for saturated phospholipid 90 H powder in terms of powder density and flow, while for unsaturated phospholipids wet granulation feasibility was explored. Additionally, phospholipid adsorption onto porous carrier was performed in order to increase processable phospholipid amount for tableting. Three different carriers have been studied: silicified microcrystalline cellulose (Prosolv[®]), granulated fumed silica (Aeroperl[®]) and magnesium aluminometasilicate (Neusilin[®]).

Direct compression: Phospholipon 90 H

Phospholipon 90 H powder, as received, was blended with 0.5% of magnesium stearate and compressed on single punch press. Resulted 8 mm diameter tablets had relatively low tensile strength, which was independent of compression force and plateaued at

0.85 N/mm². 90 H placebo tablets resulted in insoluble matrix, which did not disintegrate after at least two hours of disintegration test. The use of common tablet excipients with Phospholipon 90 H was investigated for an effect on blend compactability and tablets disintegration time. Tablets with high loadings of 90 H powder (50 and 70%) were formulated with addition of microcrystalline cellulose (MCC) and additional disintegrant, croscarmellose sodium, and compared to formulations with ready-to-use direct compression excipient, Ludipress[®], which combines lactose monohydrate as a filler, polyvinylpyrrolidone (PVP, Kolidon 30[®]) as a binder and crosslinked PVP (Kolidon CL[®]) as a disintegrant (Table 10).

Table 10. Tablet formulations for direct compression with 90 H.

| | Batch A | Batch B | Batch C | Batch D |
|-------------------------|---------|---------|---------|---------|
| 90 H | 50 | 70 | 50 | 70 |
| Avicel [®] 102 | 40 | 20 | - | - |
| Ac-Di-Sol [®] | 9.5 | 9.5 | - | - |
| Ludipress [®] | - | - | 49.5 | 29.5 |
| MgSt | 0.5 | 0.5 | 0.5 | 0.5 |

Overall, all blends had a good processability and adequate flow for direct compression. The combination of MCC and additional disintegrant (Batches A and B) was superior in terms of tablet hardness and had shorter disintegration time (Figure 17).

However, disintegration time at 37°C, with high loadings of saturated phospholipids was generally longer than 15 minutes, indicating 90 H suitability as a matrix forming excipient for extended release dosage forms, rather than immediate release formulations.

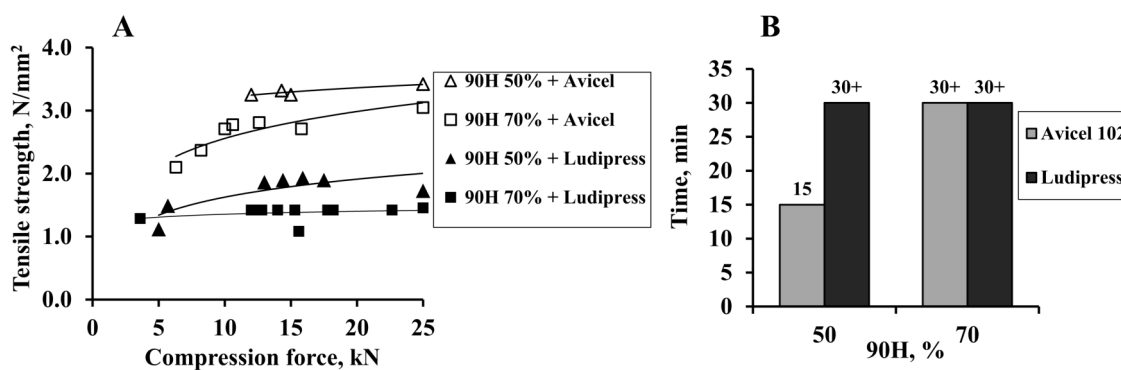

Figure 17. Effect of 90 H content in tablets with different formulation on (A) compactability and (B) disintegration time.

presents effect of 90 G content in resulting tablets on their tensile strength and disintegration time. At low PL content tablets had increasing tensile strength with increasing compression force; effect was more pronounced on tablets formulated by Method A, due to more homogeneous distribution of diluents in the tablets. At 15% phospholipid content tablet tensile strength was low and independent of compression force. It was hypothesized that due to low-porous nature of the material, tablets porosity was at its minimum already at the 5 kN compression force, and further increase in force did not contribute to interparticle bonding and hence no increase in tablets tensile strength was observed. On the other hand, addition of diluent granules (Method B) into tablet formulation improved disintegration time (Figure 18 B).

Overall, wet granulation with ethanol 96% (v/v) was feasible process for tableting of unsaturated and monoacyl- phospholipids. Up to a 30% PL content could be processed, resulting, however, in soft granules, which were not directly processable into the tablets. Tablets with maximum phospholipid loadings of 15% could be achieved by means of wet granulation method. Faster disintegration time could be achieved by adding diluent granules. Sticking to the tablet punch was a major issue when compressing phospholipids at all contents.

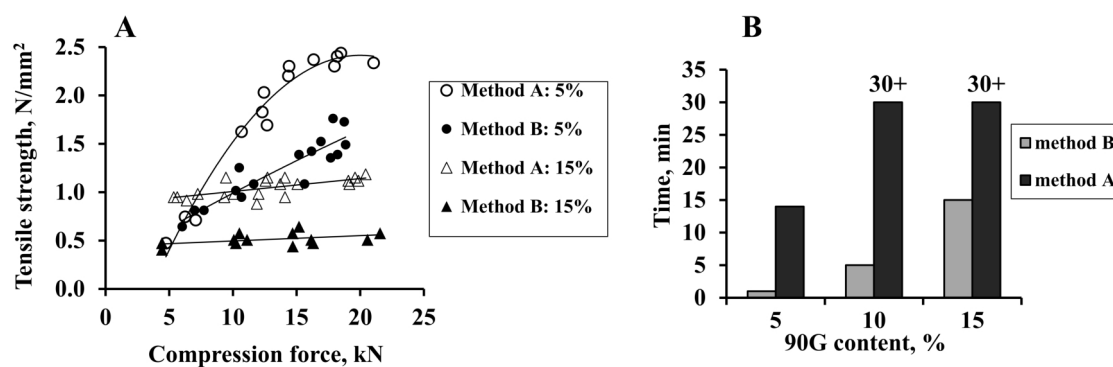

Figure 18. Effect of 90 G content on (A) compactability and (B) disintegration time in tablets.

Further steps should be considered to minimize it by using brittle porous diluents materials such as sugars, dicalcium phosphate, addition of antiadherents and glidants like colloidal silicates.

Adsorption onto porous carrier

Adsorption onto porous carrier was performed in order to increase maximum processable content of unsaturated phospholipids in a tablet. Two groups of carriers have been studied: common tableting excipient – microcrystalline cellulose, and highly porous materials with very high specific area: colloidal silicates.

Silicified microcrystalline cellulose

Prosolv[®] SMCC 90LM is combination of microcrystalline cellulose (MCC) and colloidal silicon dioxide, which results in a five-fold specific surface area increase and 30-50% compaction increase compared to traditional MCC. (JRS Pharma brochure). Powders with the different PL to Prosol[®] ratios (w/w) have been studied (Table 12).

Table 12. Phospholipids content in Prosol[®]-based powders.

| PL, g | Prosol [®] , g | PL to Prosol [®] w/w ratio | PL to Prosol [®] loading, % | Final PL content in powder, % |
|-------|-------------------------|--|---|----------------------------------|
| 1 | 5 | 1:5 | 20 | 16.7 |
| 1 | 2.5 | 2:5 | 40 | 28.6 |
| 1 | 1.67 | 3:5 | 60 | 37.5 |
| 1 | 1.25 | 4:5 | 80 | 44.4 |
| 1 | 1 | 1 | 100 | 50 |

Resulting powders presented as coarse granule-like particles and according to USP specifications (Table 9) had a good flow (Figure 19). Starting from phospholipids to Prosol[®] loadings of 80%, carrier surface started to get saturated with phospholipids and resulted in increasingly sticking powder. Blending with 1% of Aerosil[®] helped to reduce the stickiness.

For tableting, powders with different loadings of phospholipids to Prosol[®] (Table 12) were blended with 0.5% magnesium stearate and compressed at 5, 10, 15, 20 kN compression force (Figure 20). Unsaturated phospholipids had similar compactability profiles at all loadings. S LPC 80 generally formed slightly harder tablets, probably due to its more crystalline nature than other unsaturated phospholipids. With increasing phospholipid content, tablets hardness decreased, independently of PL grade. When more than a 60% phospholipids loading was used, the tablet hardness was independent of the compression force applied, due to high content of soft un-porous material.

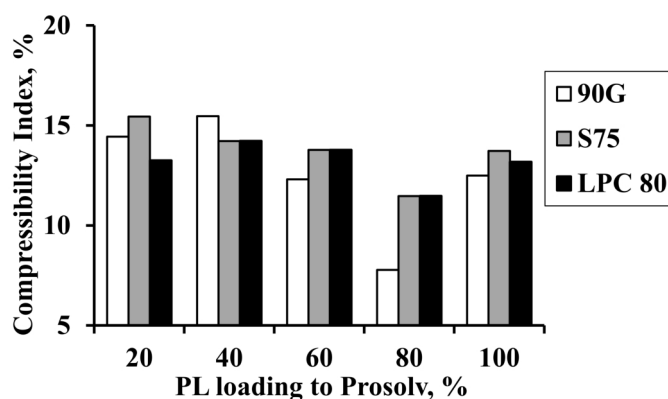

Figure 19. Compressibility index of phospholipids Prosolv[®] powders at different phospholipid loadings.

To determine the disintegration time 90 G: Prosolv[®] 1:1 powder was blended with 9.5% AcDiSol[®] and 0.5% magnesium stearate and compressed at 8-10 kN into flat 8 mm tablets. Disintegration time of resulted tablets was over 30 minutes, and was independent of PL grade.

Overall, phospholipids:Prosolv[®] powders had good flow properties and the resulting tablets had an acceptable hardness over the range of studied loading ratios. However, due to long disintegration times, these powders could be rather considered as excipients for extended release formulations. Taking into consideration, that tablets hardness was independent of compression force at high phospholipids loadings, low compression force of 5-10 kN could be recommended for tableting adsorbed phospholipids powders.

Highly porous carriers

Aeroperl[®] and Neusilin[®] are highly porous carriers, with specific area of ca. 300 m²/g and particle size below 100 μm. Both powders had improved bulk density and flow, suitable for processing and direct compression. Ethanolic solutions of phospholipid were adsorbed onto these carriers at the phospholipid to carrier ratios (w/w) of 1:1 and 1.5:1 (Table 13).

Table 13. Phospholipid content in Aeroperl- and Neusilin-based powders.

| PL, g | Carrier, g | PL to carrier w/w ratio | Final PL content in powder, % |
|-------|------------|-------------------------|-------------------------------|
| 1 | 1 | 1:1 | 50 |
| 1.5 | 1 | 3:2 | 60 |

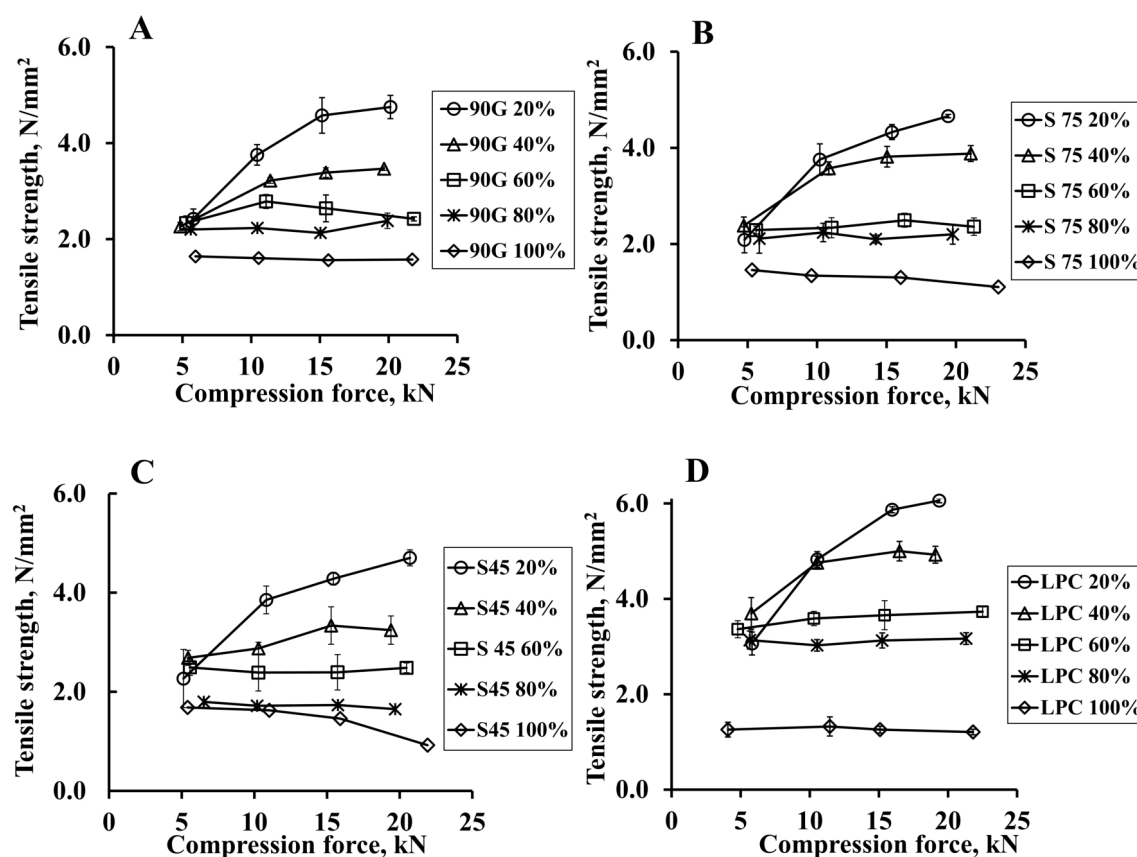

Figure 20. Compactability profiles of phospholipid-Prosolv[®] powders. (A) 90 G; (B) S 75; (C) S 45; (D) LPC 80.

Resulting powders presented as fine granule-like particles and had a good to excellent flow (Figure 21).

For tableting, the resulted powders were blended with 0.5% magnesium stearate and compressed at 5, 10, 15, 20 kN compression force.

Aeroperl- and Neusilin-based phospholipid powders had similar compactability profiles, almost independent of compression force applied. Neusilin-based phospholipid powders formed slightly harder tablets than Aeroperl-based tablets. For disintegration test, adsorbed powders were mixed with 9.5% croscarmellose sodium (AcDiSol[®]) and compressed at 8-10 kN compression force. Aeroperl-based tablets resulted in faster disintegration times, permitting to achieve 45% PL loading in the tablet with reasonable disintegration times (5-10 minutes) (Figure 22).

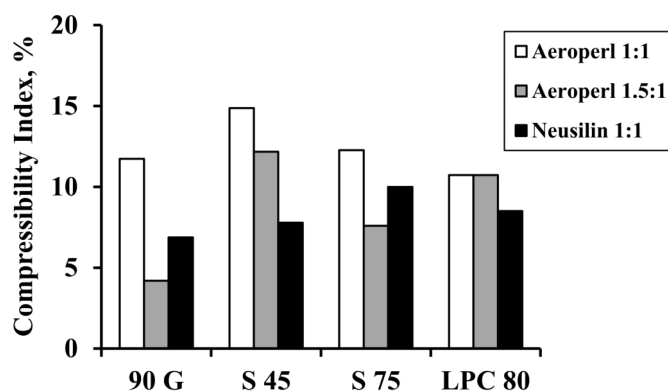

Figure 21. Compressibility index of Aeroperl- and Neusilin-based PL powders.

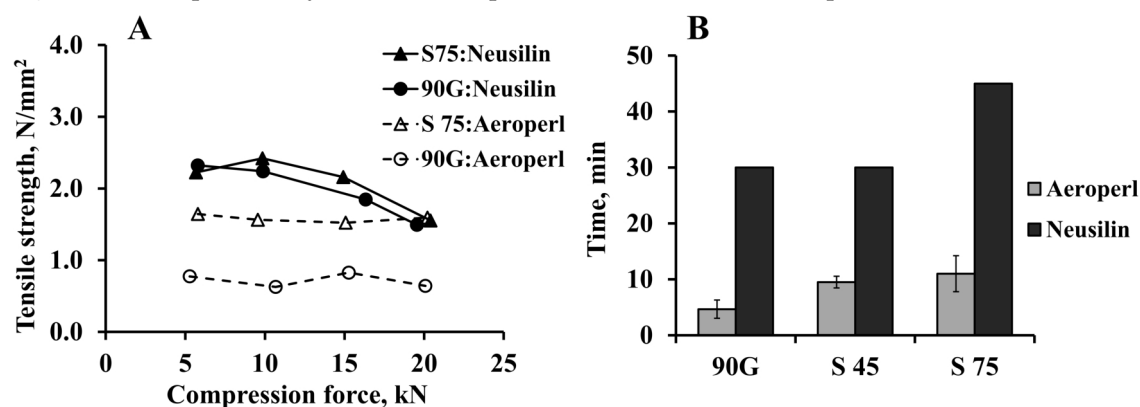

Figure 22. Effect of highly porous carrier type on (A) compactability of 1:1 phospholipid: carrier blends and (B) disintegration time of tablets with 45% phospholipid content.

Up-scaled process for Aeroperl-based phospholipid powders

Adsorption of unsaturated phospholipids onto highly porous carriers, resulted in flowing, well compactible blends with high phospholipid loadings. To evaluate feasibility to apply this method at a bigger production scale, batches of 250 g were prepared for 90 G and S 45 by means of Diosna Mixer Granulator P 100 with following settings:

| | |
|--------------------------------|--------------|
| Aeroperl [®] loading: | 100 g |
| Chopper speed: | 450-300 rpm |
| 90 G/S 45 ethanol solution: | 50-60% (w/w) |
| Spraying nozzle: | 4/30° |
| Pump speed: | 16 g/min |

Wet powder was dried for 24 hours in vacuum oven at room temperature. Resulted dried compacts were sieved through 500 μ m sieve by Frewitt GLA-ORV Laboratory oscillating Granulator.

General recommendations

- Phospholipid ethanol solution should be at least 50% w/w in order to reach 1.5:1 loading (60% PL content): 100 g of carrier can adsorb ca 300 ml volume. At 50% w/w PL concentration, it results in 100 g carrier to 150 g PL
- **Use a Moderate mixing speed**, high shear should not be applied; ca 450 rpm till reaching 1:1 carrier: phospholipid ratio, later slow down to 300 rpm to ensure uniform wetting of the carrier without forming compacts
- Ensure uniform distribution of phospholipid ethanolic solution, a fine nozzle with moderate pump speed is preferred Ensure that the residual moisture content after drying is not more than 3%, otherwise sieving can be compromised
- Do not use a small sieve pore size (<500 μm) at the first step of sieving; at high friction phospholipids may form solid film on the sieve, making the further sieving impossible

Powder residual moisture was determined after powder drying for 24 hours in vacuum oven by loss on drying method and was 1.61 and 1.79% for 90 G and S 45, respectively. To respond to the concerns regarding resulted powder hygroscopicity and thus long-term stability, due to significantly increased surface area (PL aggregates vs. fine powder), moisture content was measured in initial unprocessed phospholipid powder and Aeroperl-based powder after 24 hours and 3 months of storage in bottles closed with a screw lid at room conditions (RH 40%; 23°C) (Table 14).

Table 14. Moisture content in S 45 powder and Aeroperl-based S 45.

| Powder | Moisture content, % | |
|----------------------------|---------------------|--------------------------|
| | 24h vacuum oven | 3 months room conditions |
| S 45:Aeroperl [®] | 1.79±0.170 | 2.017±0.008 |
| S 45 | 1.4±0.071 | 4.815±0.064 |

Aeroperl-based S 45 powder, had no increase in moisture content through out the storage period, while unprocessed S 45 presented 3 folds moisture content increase. Therefore, the additional excipients to convert PL aggregates into free-flowing powders have had

positive impact on equilibrium moisture content at room conditions. Additionally no visible changes neither in morphology nor in rheological behavior of the resulted powders were observed (Figure 23).

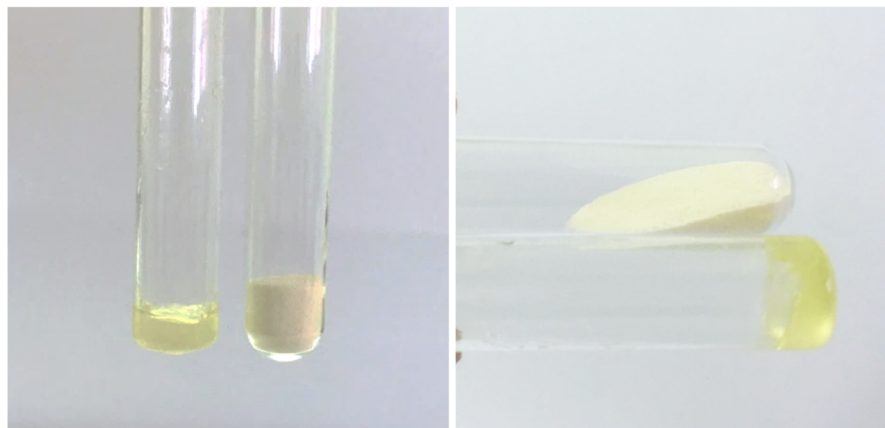

Figure 23. S 45 untreated material (left) and Aeroperl-based S 45 powder (60% PL content) (right) after 3 months storing at room conditions. S 45 converted into semi-solid paste, while Aeroperl-based S 45 remained freely-flowing powder with no visible morphological changes.

3.1.4 Conclusions

Overall, phospholipids could be processed into solid oral dosage forms (e.g. tablets) by different methods: direct compression (saturated phospholipids), wet granulation and adsorption onto carrier (unsaturated phospholipids). Main limiting factors for wet granulation were stickiness of the materials (unprocessable mass) and resulting tablets softness. Sticking to the tableting machine punch could partly be managed by addition of 1% of colloidal silica, as well as the use of brittle materials as additional tableting/granulation excipients increasing tablets hardness. The phospholipid content affected disintegration time and tablets hardness. Although, resulting tablets tensile strength was not very high, due to very low friability, even at high phospholipid content, tablets could withstand further processing, whereas, the disintegration time could be managed by additional excipients (disintegrants, and diluents). Free flowing powders with a high phospholipid content could be produced by using adsorbents. Main factors that limited the phospholipid content in the powder are the carrier adsorption capacity and the phospholipid solubility in ethanol. The method could be easily scaled up using common

pharmaceutical lab/production equipment. Tablets with up to 60% of unsaturated phospholipids content could be achieved by this method. Disintegration time, was the most affected parameter with increased phospholipids content, could be reduced by adding intra- and extra granular disintegrants, and diluent excipients. Table 15 summarizes the previously discussed methods and achieved phospholipids contents.

Table 15. Summary of methods applied for phospholipid tableting and contents achieved

| PL | | Direct Compression | | Wet granulation | | | Adsorption onto carrier | | |
|-------------|--|--|-------------------------------|---|--------------------------------|-------------------------------|--|-------------------------------|-------------------------------|
| | | Limiting factor | PL content in tablet | Limiting factor | PL content in granule | PL content in tablet | Limiting factor | PL content in powder | PL content in tablet |
| Saturated | 90 H | - | Up to 99.5% | - | Up to 99.5% | Up to 99.5% | - | - | - |
| | 80 H | Powder flow | Up to 50% | - | Up to 99.5% | Up to 99.5% | - | - | - |
| Unsaturated | 80 H S 75 S 45 S LPC 80 | Not possible | Not possible | Not processable mass over 30% Sticking to punch at compression Soft "smashable" tablets | Up to 30% | 5 - 15% | Carrier adsorption capacity PL solubility in ethanol | 50 - 60% | Up to 60% |
| | Disintegration time (DT) adjustment | <ul style="list-style-type: none"> - Adjust PL content - Add disintegrant - Up to 50% PL content + 9.5% disintegrant resulted in up to 15 minutes DT | | <ul style="list-style-type: none"> - Adjust PL content - Add intra- /extra granular disintegrant - Add diluent granules - 70% saturated PL content + 9.5% disintegrant resulted in 20 minutes DT - 15% unsaturated PL content 9.5% disintegrant resulted in 15 minutes DT | | | <ul style="list-style-type: none"> - Adjust PL content - Add extragranular disintegrant - Add diluent excipients - Up to 50% PL content + extragranular disintegrant and additional excipients results in up to 15 minutes DT | | |

3.2 Saturated Phosphatidylcholine as Matrix Former for Oral Extended Release Dosage Forms¹

Abstract

The aim of this study was to evaluate the suitability of saturated phosphatidylcholine (Phospholipon[®] 90H) as extended release excipient in matrix tablets for three model drugs with different aqueous solubility (theophylline, caffeine and diprophylline). The tablets could be prepared by direct compression because of the favourable phospholipid powder flow properties (Carr's index: 12.64 and angle of repose: 28.85) and good compactibility. Tablets of low porosity were formed already at low pressure of 40 MPa and with drug loadings up to 70% due to high plasticity of the phospholipid. Extended drug release was achieved with the drugs of different solubility and at various drug loadings. For example, the caffeine release time t_{80} from 8 mm tablets ranged from 1.5 h to 18 h at 70% and 10% drug loading, respectively. The drug release was governed by diffusion and could therefore be modelled by Fick's law of diffusion. Drug release profiles were thus a function of drug solubility, drug loading and tablet dimension. Matrix tablets of caffeine (20% drug loading) showed robust dissolution with regard to agitation (50–100 rpm) and ionic strength of the release media (100–600 mOsmol/kg). Caffeine release was pH-dependent with a faster drug release at acidic pH, which was attributed to a protonization of the phosphatidyl group of the matrix-former and thus a higher hydrophilicity.

Keywords

Phosphatidylcholine; Phospholipids; Direct compression; Extended release; Matrix tablet

¹Kolbina, M., Bodmeier, R., Korber, M., 2017. Saturated phosphatidylcholine as matrix former for oral extended release dosage forms. *Eur. J. Pharm. Sci.* 108, 86-92. doi:10.1016/j.ejps.2017.07.017

3.2.1 Introduction

Phospholipids are isolated from natural sources like egg, soybean, rapeseed, and sunflower seed. The most common phospholipid is phosphatidylcholine, which is also the most abundant component of lecithin. Normally, lecithin grades containing more than 80% phosphatidylcholine are called arbitrarily phosphatidylcholine, whereas grades containing less than 80% phosphatidylcholine can be arbitrarily called lecithin (Hoogevest and Wendel, 2014). Structurally, phospholipids comprise a glycerol backbone, which is esterified in positions 1 and 2 with fatty acids and in position 3 with phosphate and other functional groups. The length and degree of saturation of fatty acids chains as well the variation of functional groups, leads to the existence of a wide variety of phospholipids. Phospholipids have become attractive candidates as carriers for oral formulations during the last years, due to their favorable biocompatibility, biodegradability and diversity (Chakraborty et al., 2009).

Phospholipids have been used in two major applications in drug delivery. Firstly, their solubility- and bioavailability-enhancing properties for poorly water-soluble drugs have been investigated for several decades. Several lipid-based drug delivery systems have been developed, which make use of their amphiphilic nature and the ability to form vesicular structures in aqueous environments (Fricker et al., 2010). In addition, phospholipids have been studied in extended release drug delivery systems to some extent. Acetaminophen tablets were prepared by direct compression with different hydrogenated phospholipids rich in phosphatidylcholine, phosphatidylethanolamine and phosphatidylinositol fractions in order to determine effect of phospholipid species and pH on drug release (Fujii et al., 1998). Orally disintegrating ibuprofen tablets with controlled release were formulated (Fini et al., 2008). Granules of ibuprofen and hydrogenated phosphatidylcholine at 4:1 weight ratio prepared by wet granulation showed a slower drug release compared to pure drug granules. In another study, unsaturated lecithin (Lipoid S 45) was used as a binder to form soft agglomerates of gastro-resistant pantoprazole microparticles for an oral, delayed release dosage form (Raffin et al., 2009). Likewise, soy phosphatidylcholines have been used for extended release tablets prepared by wet granulation or compression moulding of drug-phospholipid blends (Chime, 2013; Nishihata,

Nakano, and Yamazaki, 1987). Phospholipids have also been studied as potential protectants of the gastric mucosa in combination with non-steroidal anti-inflammatory drugs (Anand et al., 1999; Dial et al., 2008), as well as potential taste masking agents (Katsuragi et al., 1997).

Direct compression is usually preferred for tablet manufacture due to its simplicity and cost-effectiveness. This approach has been successfully applied to synthetic or semi-synthetic polymers such as Kollidon[®] SR (polyvinyl acetate-based), Eudragit[®] RS (poly-methacrylate derivatives) or ethyl cellulose (Boza et al., 1999; Crowley et al., 2004; Grund et al., 2014; Kranz, Brun, and Wagner, 2005). Potential matrix-formers of natural origin, with regulatory acceptance and the feasibility to control the drug release from a blend matrix are rare (e.g. carnauba wax, bees wax and shellac). In contrast to other natural waxes such as carnauba or bees wax, saturated phosphatidylcholines could be an interesting alternative as tableting excipients due to their natural origin, proven safety (GRAS listed compound) and biocompatibility as well as a reproducible quality, high melting temperature and their availability in fine powder form (Hoogevest and Wendel, 2014).

In this study, saturated phosphatidylcholine, composed of stearic and palmitic acids and manufactured by hydrogenation of unsaturated phospholipids and chemically identical to the fraction of saturated phosphatidylcholines naturally contained in lecithin, was evaluated as matrix former for extended drug release due to its insoluble nature in aqueous medium (solubility of dipalmitoyl phosphatidylcholine: 0.3 ng/ml; (Smith and Tanford, 1972). The drug release from insoluble matrices is predominantly governed by diffusion (Grund, Körber, and Bodmeier, 2013; Kreye, Siepmann, and Siepmann, 2008). Therefore, a number of formulation factors which affect the drug diffusivity (i.e. drug loading, matrix former particle size, tablet porosity, etc.), and hence the drug release rate, were studied. Diprophylline, caffeine and theophylline, with corresponding aqueous solubilities (at 25°C) of 330, 20 and 8 mg/mL (Remington and Gennaro, 1990), were used as model drugs. Direct compression of binary blends of drug and phospholipid was used in order to establish clear cause-effect relationships and to evaluate the general applicability of this excipient as release retarding matrix-former.

3.2.2 Materials and Methods

3.2.2.1 Materials

Saturated phosphatidylcholine of stearic and palmitic acid (Phospholipon[®] 90H, Lipoid GmbH, Ludwigshafen, Germany), caffeine anhydrous fine powder, theophylline anhydrous micronized powder, diprophylline (BASF SE, Ludwigshafen, Germany); TLC plates silicagel 60, β -(N-Morpholino)ethanesulfonic acid (MES) monohydrate (Merck KGaA, Darmstadt, Germany), polysorbate 80 (Sigma-Aldrich); PLA₂ (DSM, Heerlen, Netherlands); purified water (Fresenius Kabi Deutschland GmbH, Bad Homburg); magnesium stearate (Baerlocher GmbH, Unterschleissheim, Germany).

3.2.2.2 Particle size measurements

The particle size of phosphatidylcholine powder was measured in triplicates by powder laser diffraction (Sympatec[®] Helos Rodos GmbH, Clausthal-Zellerfeld, Germany) after eliminating particles larger than 850 micrometer by sieving (Fritsch GmbH, Idar-Oberstein Germany).

3.2.2.3 Powder densities and flow properties

The bulk and tapped densities were determined by filling 100 g powder into 250 mL measuring cylinder undergoing 1250 taps (Erweka GmbH, Heusenstamm, Germany) and were calculated as ratio of powder weight to volume occupied before and after tapping, respectively. The Carr's index (Eq. 3) and Hausner ratio (Eq. 4) were calculated as follows:

$$CI = \frac{(\rho_{\text{tapped}} - \rho_{\text{bulk}})}{\rho_{\text{bulk}}} \times 100(\%) \quad (\text{Eq. 3})$$

$$HR = \frac{\rho_{\text{tapped}}}{\rho_{\text{bulk}}} \quad (\text{Eq. 4})$$

where, ρ_{tapped} is the tapped density and ρ_{bulk} is the bulk density. The angle of repose was measured with Erweka Powder Flow tester (Erweka GmbH, Heusenstamm, Germany).

3.2.2.4 Preparation of tablets

The phosphatidylcholine powder (sieve fraction 90-180 μm) was blended with the drug for 10 min in a Turbula mixer (Willy A. Bachofen AG, Basel, Switzerland). The drug loadings ranged from 10 to 90% w/w. Then, 1% w/w magnesium stearate was added to the blend and further mixed for 3 min. The powders were compressed into 8 mm diameter, flat-faced tablets (160 ± 2 mg) at pressures ranging from 5 to 400 MPa using a single punch tablet press at 10 rpm (Korsch EK0, Korsch AG, Berlin, Germany). The compression force was recorded (MGCplus, Catman, HBM Inc, USA). Tablets prepared with the powder particle size fractions 0- 90 μm and 180 -315 μm were used to study the effect of particle size on drug release. Placebo tablets were prepared by compressing phosphatidylcholine powder into 11 mm flat-faced tablets with a compaction simulator (Huxley Bertram, Cambridge, UK) at pressures ranging from 5 to 210 MPa and dwell time of 23 millise. Data acquisition was recorded with a time interval of 0.02 millise. The plastic work of compaction was calculated as the area under the curve of the force-displacement diagram with MS Excel software, applying the trapezoidal approximation method. The compensated upper punch position was used in calculations.

3.2.2.5 Tablets characterization

The tablet thickness and the diameter were measured by an electronic micrometer (± 0.01 mm, Digi-Met; Helios Preisser, Gammertingen, Germany). The weight was recorded (± 0.1 mg; Mettler AT200) 24 h after compression. The tablet breaking force was measured on a tablet hardness tester (Multicheck, Erweka GmbH, Heusenstamm, Germany), and the tensile strength (Eq. 5) was calculated as follows:

$$\sigma = \frac{2F}{\phi dh} \quad (\text{Eq. 5})$$

where σ is radial tensile strength [MPa]; F is breaking force [N]; d is tablet diameter [mm]; h is tablet thickness [mm].

The tablet porosity was calculated as the ratio of apparent and true density. The true density of phosphatidylcholine was determined by the method described by C. Sun, (Sun, 2005), where the compaction pressure and tablet apparent densities are fitted into the

non-linear regression of the modified Heckel equation (Kuentz and Leuenberger, 1999) (Eq. 7, Appendix). The method was validated with Avicel[®] 102, and the results were in accordance with published data (Fig.34 Appendix).

3.2.2.6 Determination of the degree of phospholipid hydrolysis in incubation medium with PLA₂

Incubation buffer was prepared as follows: 6.11 g of β -(N-Morpholino)ethanesulfonic acid (MES) monohydrate, 6.19 g of NaCl and 0.15 g of polysorbate 80 were dissolved in purified water. The pH was adjusted to 6.50 with 0.1 M solution of NaOH. Water was added to give a total volume of 1.0 L of buffer solution. Calcium acetate (1 g) was dissolved in 40 ml of the buffer solution, matrix tablet and PLA₂ (44,372 U) were added and the resulting mixture was stirred at 37°C. Samples were taken after 2 h, 4 h, 6 h, 8 h and 24 h and analyzed by thin layer chromatography (TLC). After 24 h the tablet was removed from the medium by filtration, rinsed with water and lyophilized to determine the dried tablet weight.

3.2.2.7 Drug release

Drug release was performed using a USP paddle apparatus (900 mL, hydrochloric acid solution pH 1.2 and pH 2, phosphate buffer pH 3, 0.05 M phosphate buffer pH 4.5 and 0.05 M phosphate buffer pH 6.8 at 37°C, 75 rpm, n=3). (VK 7000, Agilent Technologies Deutschland GmbH, Böblingen, Germany). Sodium chloride was added to adjust the osmolality. Samples were taken at predetermined time points and analysed UV-spectrophotometrically ($\lambda=273$ nm).

3.2.3 Results and Discussion

3.2.3.1 Phosphatidylcholine powder characterization and tableability

Good powder flow and compactibility are obligatory requirements for excipients for direct compression to ensure process reproducibility and product quality. The particle shape and size distribution were analysed since powder flowability is a consequence of the combined effects of various physical, chemical and environmental variables (Schulze, 2008). The particle size distribution of phosphatidylcholine powder contained a primary mode centering around $100\ \mu\text{m}$ and a minor mode around $475\ \mu\text{m}$ (Figure 24). The d_{50} was $102.0 \pm 0.71\ \mu\text{m}$. The particles were spherical (Figure 24).

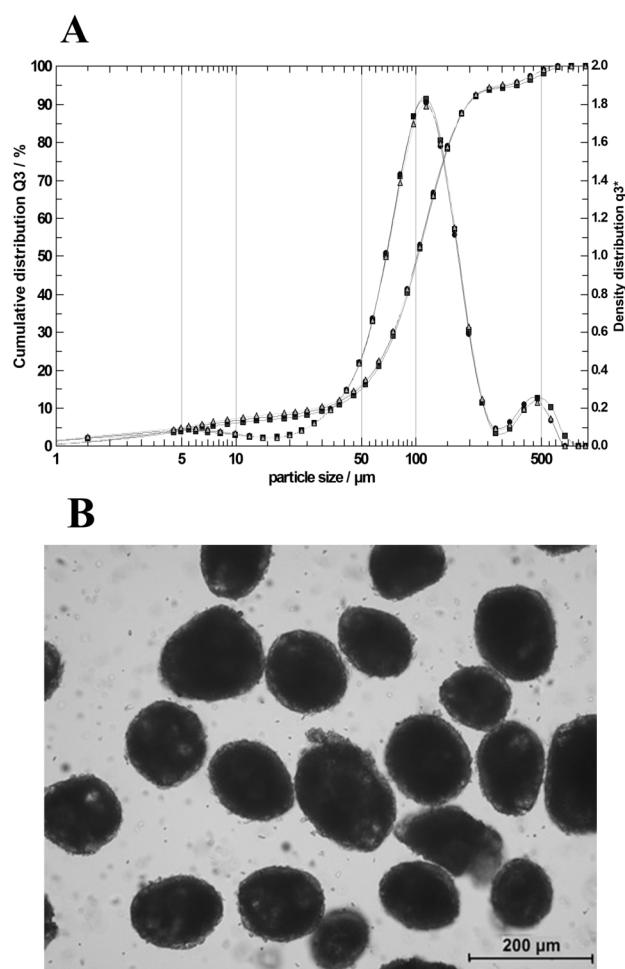

Figure 24. Particle size distribution measured by powder laser diffraction (A) and optical microscopy picture of phosphatidylcholine powder (B).

Phosphatidylcholine powder had good flow properties according to USP [1174] (Table 16) with a Carr index of 12.6, a Hausner ratio of 1.15 and an angle of repose of 28.8, thus

being suitable for direct compression.

Table 16. Particle size and flow properties of phosphatidylcholine powder (Phospholipon 90 H).

| Particle size μm | | | Particle shape | True density g/cm^3 | Bulk density g/cm^3 | Car's index | Hausner ratio | Angle of repose |
|-----------------------------|------------|------------|----------------|-------------------------------------|-------------------------------------|-------------|---------------|-----------------|
| d10 | d50 | d90 | | | | | | |
| 31.30 | 102.00 | 198.47 | Regular | 1.044 | 0.567 | 12.64 | 1.15 | 28.85 |
| ± 2.75 | ± 0.71 | ± 1.62 | round | ± 0.007 | ± 0.002 | ± 1.21 | ± 0.02 | ± 1.32 |

The ability of saturated phosphatidylcholine to form compacts by compression was evaluated. Compacts of the pure excipient were characterized by a relatively low tensile strength and a low friability (0.1%). The tensile strength was independent of compaction pressure above 40 MPa. The porosity of tablets decreased with increasing compaction pressure up to about 40-50 MPa, thereafter, tablets approached to close to 0% porosity (Figure 25).

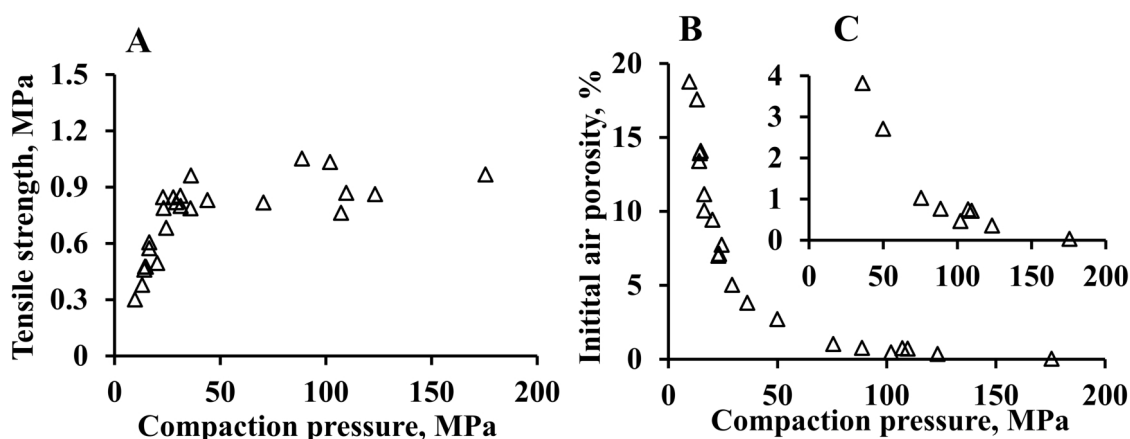

Figure 25. Compactibility profile of saturated phosphatidylcholine powder: (A) tensile strength (B) air porosity as a function of compaction pressure with (C) enlarged initial porosity scale.

The work of compaction spent for irreversible plastic deformation in absolute terms was independent of the compaction pressure above 30-40 MPa, as determined from punch force-displacement curves (Figure 26 A). The fraction of the plastic work of the total compaction energy decreased gradually (Figure 26 B) on the expense of the increasing elastic recovery of the compact, reaching almost 0% porosity (Figure 26 C).

Only elastic deformation of the compact occurred once the density of the matrices reached its maximum, which was in line with the observed plateauing of the tensile strength of the tablets. Diprophylline was formulated with the phospholipid at drug loadings from

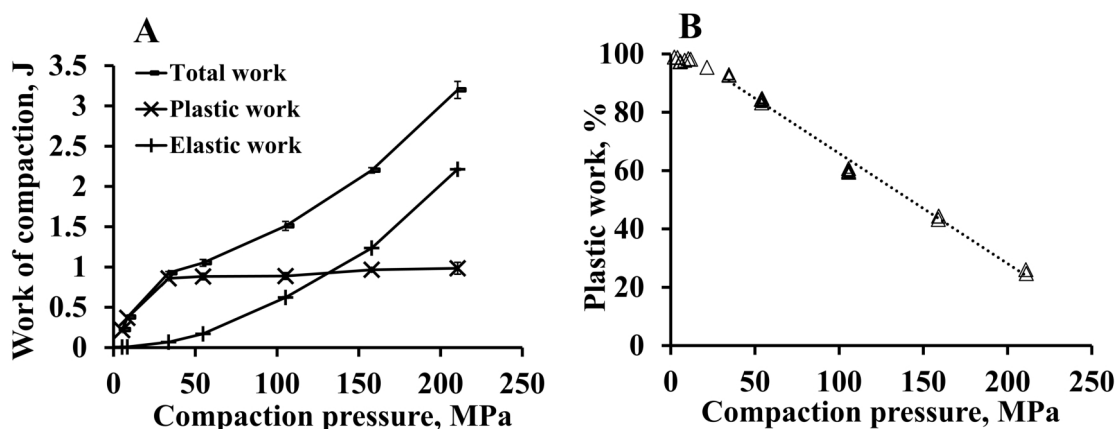

Figure 26. Contribution of plastic work as a function of (A) compaction pressure in absolute terms and (B) as a % to total work of compaction.

10 to 90% w/w. The effect of drug loading on tablets porosity and tensile strength was assessed (Figure 27). The porosity of pure diprophylline tablets gradually declined to 6% at 400 MPa. Formulations with 90 and 80% drug loading had similar profiles, reaching 5.5 and 4.9% porosity, respectively. Starting from 70% drug loading, the decrease in porosity was similar to the phospholipid. Therefore, dense matrices were obtained at low compression pressure. The tablets tensile strength was independent of the drug loading in the range of 10 to 50% but overall was higher for drug-containing tablets compared to pure phospholipid tablets. Tablets with a tensile strength of about 1.5 MPa were obtained, which is usually considered acceptable for conventional tablet formulations (Eyjolfsson, 2014).

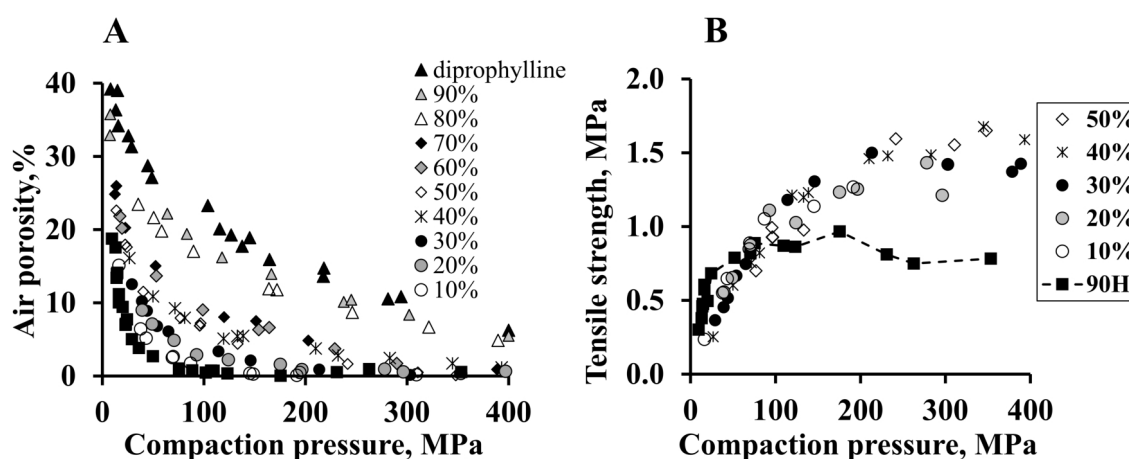

Figure 27. Effect of drug loading (A) on resulted air porosity and (B) tablet tensile strength as a function of compaction pressure.

3.2.3.2 Effect of drug solubility on drug release

The release from tablets prepared from blends of theophylline, caffeine or diprophylline and phospholipid (30:70 w/w) was studied (Figure 28). As expected, a higher drug solubility resulted in faster drug release due to the higher concentration gradient between the saturated drug solution formed inside the matrix and the drug concentration in the dissolution medium. A drug release of 80% was achieved in 3.5 h for diprophylline, 6 h for caffeine and 24 h for theophylline. This reflects that retardation is feasible with phospholipid matrices.

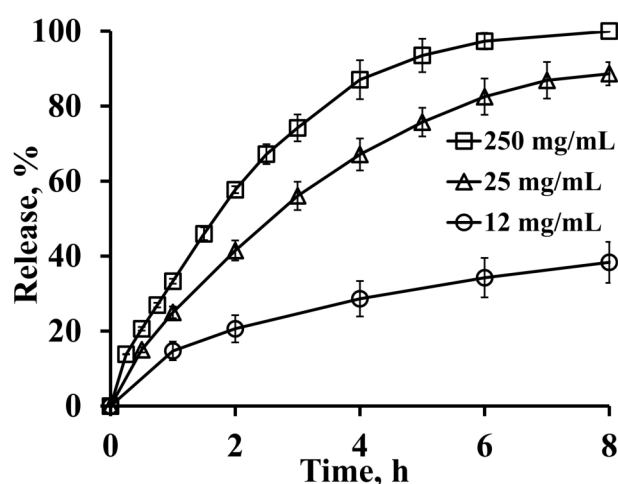

Figure 28. Effect of drug solubility on the release from phosphatidylcholine matrix at drug: lipid 30:70 weight ratio in phosphate buffer pH 6.8.

3.2.3.3 Effect of drug loading on drug release

One of the main formulation factors influencing drug release of matrices is drug loading (Frenning, 2011).

The caffeine release increased with increasing drug loading and typical diffusion-governed dissolution profiles were obtained (Figure 29). The tablets maintained their integrity during release up to 50% drug loading, at higher loadings, an increased surface erosion was visually observed. Time to 80% drug release varied from 1.5 h for formulation with 70% drug loading to 18 h for 10% drug loading. Thus, a wide range of release patterns was achievable.

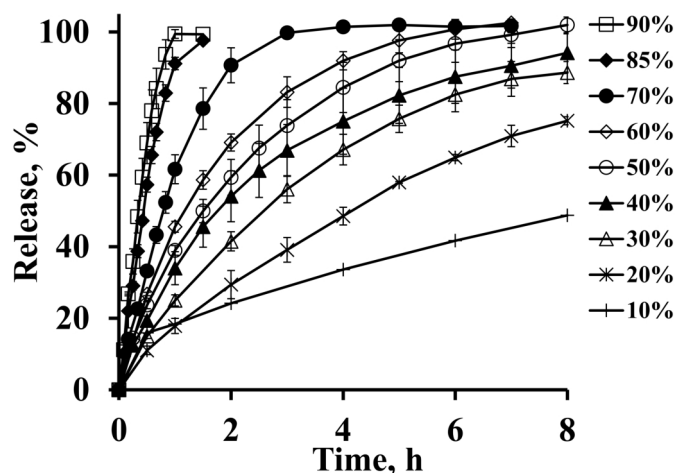

Figure 29. Effect of caffeine loading on drug release from saturated phosphatidylcholine matrix tablets in phosphate buffer pH 6.8.

3.2.3.4 Effect of tablet size on drug release

Tablet dimensions affect the drug release from insoluble matrices (Siepmann, 2008). The drug release decreased with increasing matrix diameter resulting in t_{80} of 1, 2 and 4 h (Figure 30).

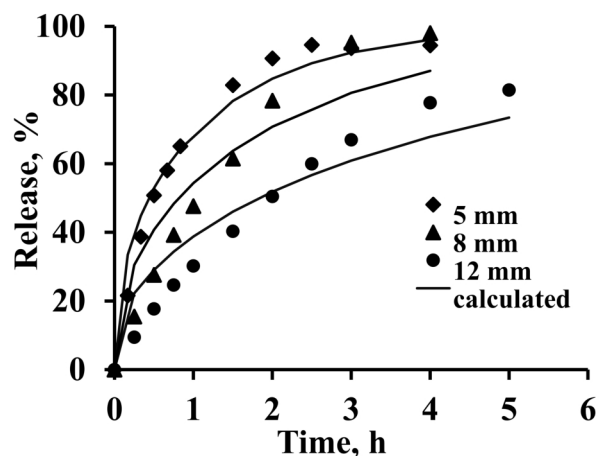

Figure 30. Effect of tablet size on caffeine release from saturated phosphatidylcholine matrix tablets in phosphate buffer pH 6.8 (60% drug loading); the closed symbols represent experimental results; the curves represent calculated release.

The experimental data fitted well to the appropriate solution of Fick's second law of diffusion (Eq. 6) (R^2 0.94-0.98), considering the given initial and boundary conditions (Vergnaud, 1993).

Similar D_{app} values were calculated ($5.70 \pm 0.158, * 10^{-7} \text{ cm}^2/\text{s}$) for tablets with different dimensions, which was in line with a diffusional release mechanism. Tools for adjusting

$$\frac{Mt}{M\infty} = 1 - \frac{32}{\pi^2} \sum_{n=1}^{\infty} \frac{1}{q_n^2} \exp\left(-\frac{q_n^2 n}{R^2} D_{app} t\right) \sum_{p=0}^{\infty} \frac{1}{(2p+1)^2} \exp\left(-\frac{(2p+1)^2 \pi^2}{H^2} D_{app} t\right) \quad (\text{Eq. 6})$$

where Mt and $M\infty$ are the absolute cumulative amounts of drug released at time t , and infinite time, respectively; q_n are the roots of the Bessel function of the first kind of zero order [$J_0(q_n) = 0$], and R and H are the radius and height of the cylinder.

to desirable drug release were elucidated: Smaller dimensions and higher drug loadings are more appropriate for poorly soluble drugs, and vice versa for more soluble drugs.

3.2.3.5 Formulation robustness with regard to drug release

The effect of particle size of phospholipid powder on caffeine release from matrix tablets was studied with three phospholipid size fractions / sieve cuts: 0-90 μm ; 90-180 μm and 180-315 μm .

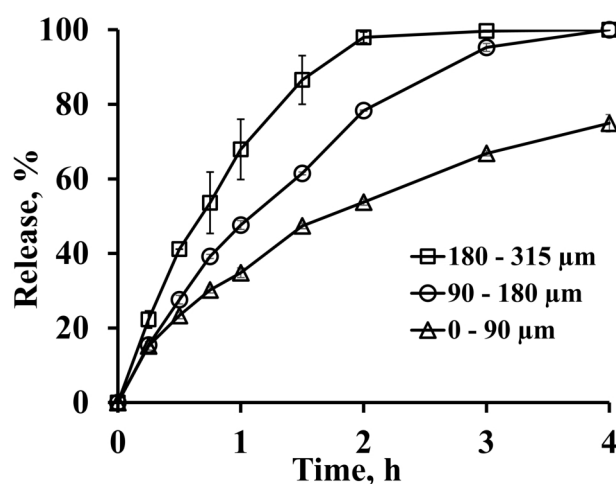

Figure 31. Effect of particle size of phospholipid powder on caffeine release in phosphate buffer pH 6.8 (60% drug loading).

Tablets produced from the fine powder fraction (0-90 μm) resulted in a slower drug release, with 80% drug being released in 5 h, compared to 2 and 1 h for the fractions 90-180 and 180-315 μm , respectively (Figure 31). Smaller particles thus produced a tighter matrix with smaller pores, hindering the penetration of release medium and drug diffusion. Moreover, tablets compressed from powders with a larger particle size were more prone to erosion, which was in accordance with literature findings (Barra, Falson-Rieg, and Doelker, 2000; Caraballo, Millan, and Rabasco, 1996). Therefore, the use of the fine particles fraction of the phospholipid is recommended for extended release formulations.

Although, the digestion of a phospholipid-based matrix tablet is rather unlikely due to very limited surface area exposed to enzymes, hydrolysis by mainly phospholipase A₂ (PLA₂) was reported for small particles in the duodenum (Massing Ulrich, 2008). To investigate a potential risk for the integrity of the release controlling phospholipid matrix, an *in vitro* study was performed to assess the stability of saturated phosphatidylcholine-based matrix tablets against PLA₂-mediated hydrolysis and against detergents, simulating bile salt/phospholipid mixed micelles.

The tablet weight loss due to diacyl phosphatidylcholine hydrolysis was normalized by initial moisture content (1.9%) and weight loss due to tablet erosion (0.3%) in incubation medium. As determined by TLC, 4% of the total mass of phospholipids in the matrix tablets were hydrolyzed to free fatty acids and monoacyl-phospholipids after 8 h incubation at 37°C and 10 - 15% after 24 h (Table 17). Overall, the matrix tablets were proved to be stable up to 8 h of exposure to GI tract medium at 37°C.

Table 17. Degree of PLA-mediated hydrolysis of placebo phospholipid tablets.

| Sampling time, h | 2 | 4 | 6 | 8 | 24 |
|--------------------------|------|------|------|---|----|
| Free fatty acids, % | 1 | 2 | 2 | 4 | 14 |
| Monoacylphospholipids, % | n.d. | n.d. | n.d. | 4 | 10 |

n.d. = not detectable (i.e. < 1.1 %)

Tablets with 20% caffeine loading were studied under different dissolution conditions i.e. pH, ionic strength and agitation speed. Tablet robustness to mechanical stress was studied at paddle rotation speeds of 50, 75 and 100 rpm (Figure 32).

There was little effect on the initial drug release rate observed at 100 rpm, which could be attributed to a faster dissolution rate of the drug particles at the tablet surface. Overall, the matrices were robust in terms of mechanical stress during dissolution testing. The drug release decreased with increasing pH of the release medium. An about 3-times faster release of caffeine was observed at pH 1.2 and 2 compared to pH 4.5 and 6.8, with an intermediate behaviour at pH 3 (Figure 33). Because of the pH-dependent solubility of caffeine, pH-differences in drug release were attributed to faster hydration of phosphatidylcholine matrix, which was in line with a previous study (Fujii et al., 1998). There

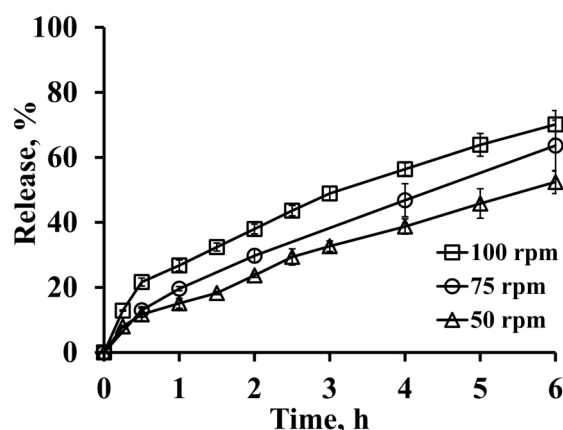

Figure 32. Effect of paddle rotation speed on caffeine release from saturated phosphatidylcholine matrix tablets (20% drug loading).

was no ionic or osmotic effect involved as similar characteristics were obtained in media with different ionic strengths (data not shown). Phosphatidylcholine tablets swelled at low pH, followed by rapid erosion and then tablet disintegration, whereas at pH 4.5 and 6.8, tablets remained intact throughout the release test. The tablet swelling at pH 1.2 was attributed to the protonated phosphate group of the phosphatidylcholine, resulting in a net positive charge at the choline group and hence a higher hydrophilicity. This pH-dependent release could potentially be beneficial in some cases for oral drug delivery (taste masking, pH-dependent drug solubility). The inclusion of gastroresistant excipients could be a way to obtain a more pH-independent release.

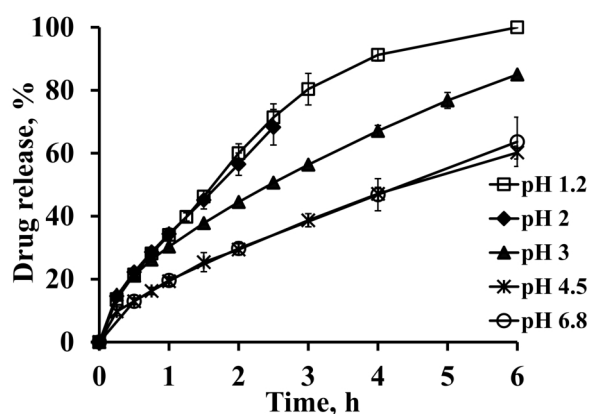

Figure 33. Effect of pH on caffeine release from saturated phosphatidylcholine matrix tablets (20% drug loading).

3.2.4 Conclusions

The evaluation of saturated phosphatidylcholine as a direct compression excipient was performed. The phospholipid powder had good flow properties and a good compactibility due to its high plasticity. Tablets with very low porosity were formed with up to 70% drug loading. Extended drug release could be achieved with drugs with different solubilities, combining different drug loadings and tablets sizes. The drug release was robust to media ionic strength and mechanical forces; however, a pH-dependent release was observed.

Acknowledgements

This work was supported by Phospholipid Research Center (Heidelberg, Germany). The authors thank Dr. A. Schulte (Lipoid GmbH) for performing *in vitro* PLA₂ -mediated hydrolysis study and Dr. P. van Hoogevest (Phospholipid Research Center) for his scientific support.

Appendix

Modified Heckel equation (Kuentz and Leuenberger, 1999):

$$P = \frac{1}{C} \left[(1 - \varepsilon_c) - \frac{\rho_{tablet}}{\rho_{true}} - \varepsilon_c \ln \left(\frac{1 - \frac{\rho_{tablet}}{\rho_{true}}}{\varepsilon_c} \right) \right] \quad (\text{Eq. 7})$$

where P is compaction pressure, C is constant indicating the deformability, ε_c denotes critical state, where mass starts to gain rigidity or strength.

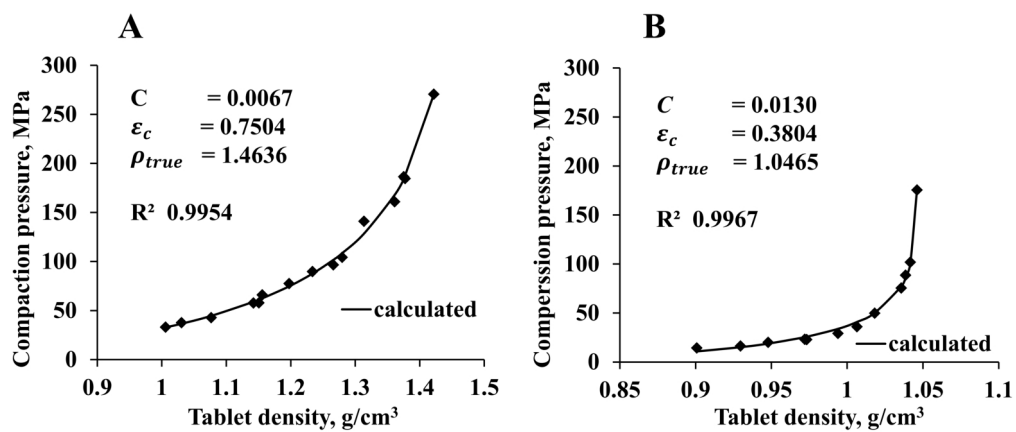

Figure 34. Determination of powder true densities by fitting experimental data into non-linear regression; (A) Avicel 102, (B) Phospholipon 90H.

3.3 pH-dependent Behaviour of Phosphatidylcholine: Mechanism Elucidation and Approaches to Minimize It

3.3.1 Background

The main goal of extended drug delivery is to maintain effective drug concentration in blood through a longer period of time, for drugs with high water solubility and/or short half-life, thus reducing dosing frequency and preventing therapeutic concentration fluctuations. Therefore, the extended release products optimize therapeutic effect and safety of a drug and at the same time improve patient convenience and compliance.

Matrix tablets are one of the dosage forms which allow controlled drug release. Generally, they consist of matrix-forming excipient and dispersed drug, which is released from matrix network by diffusion through water filled channels and pores and/or additional matrix erosion. In order to successfully control drug release rate during matrix properties should not change drastically during tablet passage through gastrointestinal tract (GIT). There, however, is a variety of different conditions met in GIT in physiological conditions, i.e. pH and osmolality fluctuations, presence of bile salts, changes in the intestinal motility and hydrodynamics, which can significantly impact dissolution and absorption of the drug.

In order to design pH-independent delivery system, it is important to consider the range of usual values for GI pH and their variations under normal physiological conditions as well as understand the drugs and excipients behaviour under these conditions.

There have been numerous studies reported on pH fluctuation and residence time in the stomach. Although, there is high degree of variability present for gender, age, health conditions, fed or fasted states, it is generally considered that pharmaceutical dosage form would spent ca. 2 hours in stomach at pH 1-2. Therefore, these conditions were further adopted for dissolution testing of phosphatidylcholine matrix tablets to evaluate methods applied to achieve pH independent release.

Furthermore, once mechanism of pH-dependent behaviour was studied in detail, attempts to suitably modify material were made, as well as common formulation adjustments were explored to achieve pH independent release from phosphatidylcholine matrix tablets.

3.3.2 Materials and Methods

PHOSPHOLIPON[®] 90H (Lipoid GmbH, Ludwigshafen, Germany); anhydrous caffeine (BASF, Ludwigshafen, Germany); hydroxypropyl methyl cellulose phthalate HPMCP HP 50 (Shin Etsu Chemicals Co., Ltd.); ethyl cellulose Ethocel[™] Premium 10 cp (Dow Chemical Co, Midland, MI, USA), Shellac (SSB[®] 57 Pharma Flake Shellac), magnesium hydroxide, sodium dodecyl sulfate, magnesium stearate

3.3.2.1 Phosphatidylcholine powder coupling with chloride ions

Soaking

Hydrochloric acid (0.1N) solution prepared in MilliQ[®] water was poured onto phosphatidylcholine powder. 90H powder was recovered by filtering the suspension through paper filter (Whatman[™]Grade1) under vacuum and drying in vacuum oven at room temperature. Conductivity and pH were measured with corresponding electrodes (Seven-Multi[™] dual meter pH/conductivity, Mettler Toledo, Greifensee, Switzerland).

Spray drying

Solutions of phosphatidylcholine (90H) 3% (w/w) with ethyl cellulose or hydroxypropyl methyl cellulose phthalate (at 10:1 weight ratio) were prepared in 95:5 mixture of isopropanol and water. Suspensions of 90H were prepared in calcium chloride (CaCl₂) MilliQ[®] water solution (at 1:1 molar ratio, phosphatidylcholine to calcium chloride). The following settings were used: inlet temperature, 110-90°C; outlet temperature, 55°C; liquid feeding rate, 5-8 g/min; atomising gas flow rate, 30 m³/h and 100% for the aspirator rate.

3.3.2.2 Tablet preparation

Tablets (8 mm, flat) were prepared with 20 and 60% drug loadings with phosphatidylcholine treated or untreated powder or phosphatidylcholine blends with additional excipients at different w/w ratios on a single punch tableting press (Korsch EK0, Berlin, Germany) at 10 kN compression force.

Dry granulation

Dry granulation was performed by slugging method. Corresponding amounts of caffeine and 90H were properly mixed and tableted into 20 mm porous tablets, which were crashed into granules and classified. Granule size fraction of 180-425 μm was used for tableting, after adding 1% w/w magnesium stearate.

Wet granulation

Wet granulation was performed in mixer torque rheometer (Caleva, Dorset, England). Corresponding amounts of caffeine and 90H were weighted and mixed for 10 minutes, followed by wetting with 6% w/w solution of ethyl cellulose or hydroxypropyl methyl cellulose phthalate in 88:12 and 80:20 isopropanol:water mixture correspondingly or 10% w/w shellac solution in ethanol until reaching total amount of 2.5% polymer in formulation. Wet mass was sieved and resulted granules dried in ventilated oven at 40°C.

3.3.2.3 Tablets water uptake

Water uptake by placebo tablets was determined gravimetrically. Samples were incubated in corresponding solutions hydrochloric acid solution pH 1.2 and pH 3 (hydrochloric acid solution with pH 3 was prepared by suitable dilution of 0.1N solution, sodium chloride was added to adjust the osmolality (Osmomat 3000, Gonotec, Berlin, Germany)), acetate buffer pH 3, phosphate buffer pH 3, and pH 6.8 at 37°C and 85 rpm horizontal shaker. Weight gain in % was calculated as follows:

$$\text{Water uptake \%} = \frac{\text{wet weight} - \text{dry weight}}{\text{dry weight}} \times 100\% \quad (\text{Eq. 8})$$

3.3.2.4 Dissolution testing

Drug release was performed using a USP paddle apparatus (900 mL, hydrochloric acid solution pH 1.2 and pH 2, phosphate buffer pH 3, 0.05 M phosphate buffer pH 4.5 and 0.05 M phosphate buffer pH 6.8 at 37°C, 75 rpm, n=3) (VK 7000, Agilent Technologies Deutschland GmbH, Böblingen, Germany). Samples were taken at predetermined time points and analysed UV-spectrophotometrically ($\lambda=273$ nm).

3.3.3 Results and Discussion

3.3.3.1 Elucidation of underlying mechanism for pH dependent behaviour of phosphatidylcholine powder

There was a remarkable difference in drug release rates from saturated phosphatidylcholine matrix tablets at different pH (Figure 35 A). Formulations of binary mixtures of PC and non-ionizable model drug, caffeine, were studied, thus pH dependent drug release was attributed to the phosphatidylcholine properties. Previously, the differences in release of paracetamol (another non-ionizable drug) from phospholipid matrices were related to different hydration kinetics at acidic and neutral pH (Fujii et al., 1998). Water uptake study was performed on placebo phosphatidylcholine matrix in hydrochloric acid solution (pH 1.2) and phosphate buffer (pH 6.8) (Figure 35 A). Indeed, significantly higher water uptake was observed at pH 1.2 HCl which was in line with drug release results (Figure 35 B), thus confirming that it was matrix pH dependent hydration rate, which was responsible for differences in drug release.

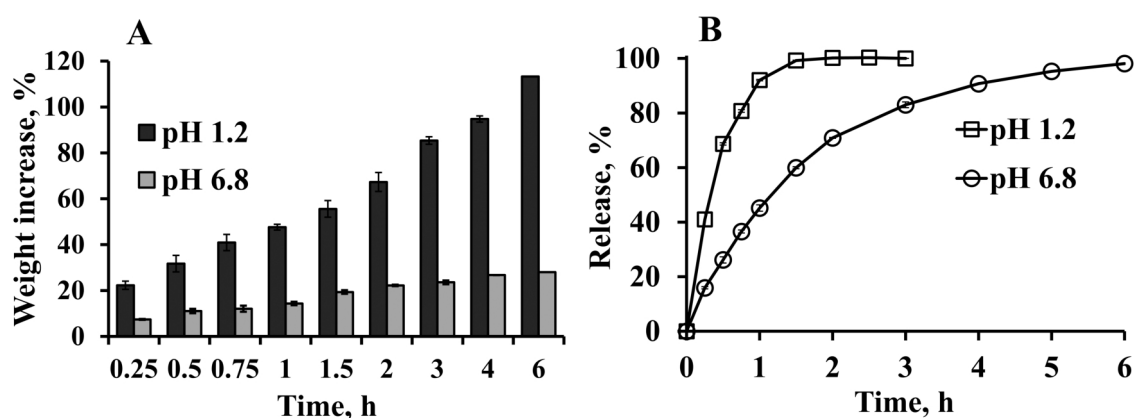

Figure 35. Effect of dissolution medium pH on (A) placebo matrix water uptake and (B) caffeine release from phosphatidylcholine matrix tablet.

Hydration kinetics were further related to the ionization state of PC. Taking a closer look at the PC molecular structure of a polar head, two functional moieties could be identified: phosphate group with apparent pKa 3 (Boggs, 1987) and quaternary ammonium group (Figure 36). At pH over 3, phosphate group is mainly deprotonated and thus, negatively charged, while quaternary ammonium is always positively charged, regardless medium pH, hence PC molecule is present as zwitterion. On the other hand, in the acidic medium,

pH < 3, phosphate remains protonated, and PC has only positive charge of quaternary ammonium group.

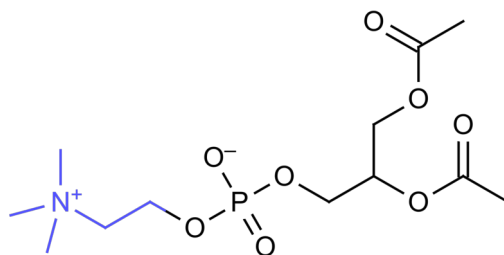

Figure 36. Schematic representation of phosphatidylcholine molecule with a net 0 charge. Image source: Wikimedia Commons, Public domain.

It has been suggested, that in acidic medium the uncompensated positive charge of quaternary ammonium group strongly attracted counterions from the medium, favoring matrix hydration and consequently drug release. Drug release from phosphatidylcholine tablets containing 20% caffeine was performed in different pH media (Figure 37). Results were in accordance with suggested mechanism of hydration. It was observed that at the acidic pH (1.2 and 2, HCl) drug release was significantly accelerated compared to the release in phosphate buffer at pH 4.5 and 6.8, whereas caffeine release rate at pH 3 (phosphate buffer) was intermediate.

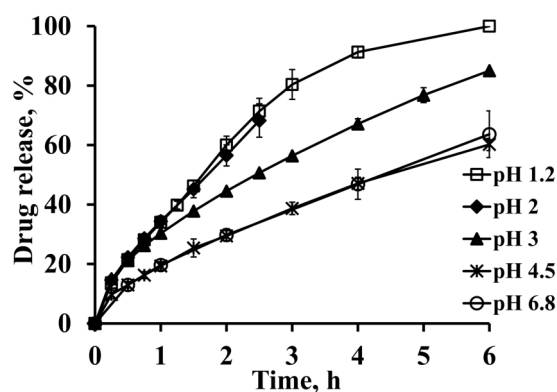

Figure 37. Effect of dissolution medium pH on caffeine release from phosphatidylcholine matrix tablets.

Furthermore, buffer anionic species had strong effect on hydration as it was previously described for acrylic insoluble polymers (Eudragit[®] RS/RL) with similar quaternary ammonium cations in the structure (Bodmeier et al., 1996, Wagner and McGinity, 2002). Water uptake in different buffers at pH 3 was measured for placebo phosphatidylcholine

matrix. Similarly to Eudragit[®] RS/RL, the extent of phosphatidylcholine matrix hydration was proportional to the hydrodynamic radius (i.e. ion hydration shell) of buffer ions (e.g. acetate > phosphate > chloride) (Figure 38 A) (Simon, 1991).

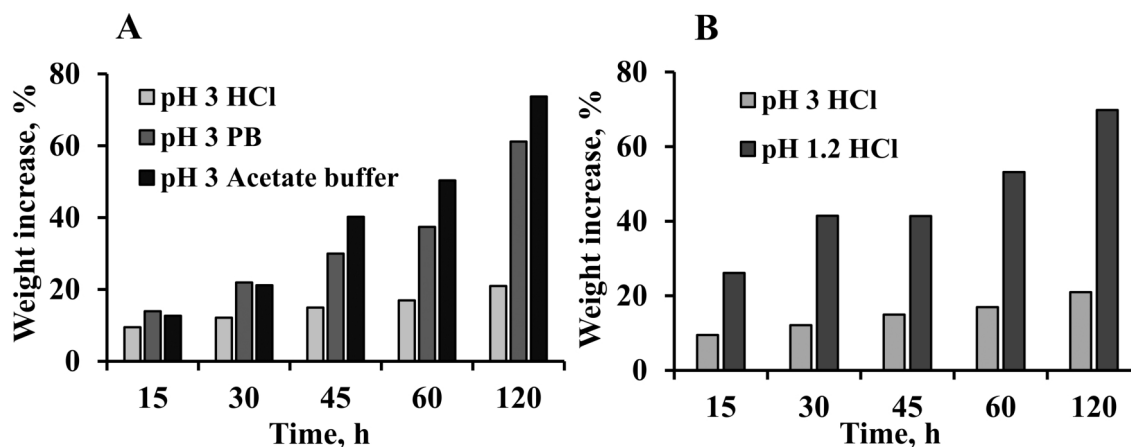

Figure 38. Effect of (A) buffer anion species and (B) buffer pH on phosphatidylcholine matrix hydration extent.

Overall, hydration extent of phosphatidylcholine matrix depended strongly on medium pH which defined ionization status of phosphate group and thus, the degree of quaternary ammonium affinity for buffer anions (Figure 38 B) and on the present buffer anionic species.

3.3.3.2 Phosphatidylcholine powder coupling with chloride ions

In order, to decelerate the ions attraction and matrix hydration in acidic medium, material modification by previous coupling of quaternary ammonium group with chloride ions was intended. It has been speculated, that associated chloride ions would bring medium ions exchange rate into equilibrium, rather than uncontrolled ion flux to uncompensated positive charge of quaternary ammonium group, thus matrix hydration rate could be slowed down.

Phosphatidylcholine powder treatment with hydrochloric acid

In order to couple quaternary ammonium with chloride ions, the phosphatidylcholine powder was treated with 0.1N HCl solution in MilliQ[®] water. Solution conductivity decrease was proportional to amount of PC added, confirming chloride ions uptake by

quaternary ammonium groups. Further, to ensure phosphatidylcholine stability in acid medium, the contact time was greatly reduced to few seconds, by pouring 0.1N HCl solution onto PC powder during the vacuum filtering. To confirm the lack of hydrolysis due to acidic treatment, FTIR was performed. There was no significant shift in wavelength corresponding to the ester bond of initial 90H powder to lower frequencies in treated (90H Cl) powder observed (1728 and 1735 nm, accordingly), which would indicate hydrolysis. The spectrum of palmitic acid was used as a control, presenting peak corresponding to carboxylic acid at 1700 nm (data not shown) (Pavia et al., 2009).

Finally, drug release from tablets composed of treated phosphatidylcholine powder and caffeine at 20 and 60% drug loading was compared to untreated phosphatidylcholine powder formulations. At 60% drug loading, there was similar drug release at pH 1.2 and pH 6.8 in formulation with treated 90H powder, which contrasted with pH dependent profile of untreated powder (Figure 39 A). The pH independent release was observed for first two hours of release, which could potentially be translated into pH independent drug release *in vivo*, since gastric transition time is ca. 2 hours (Davis, Hardy, and Fara, 1986).

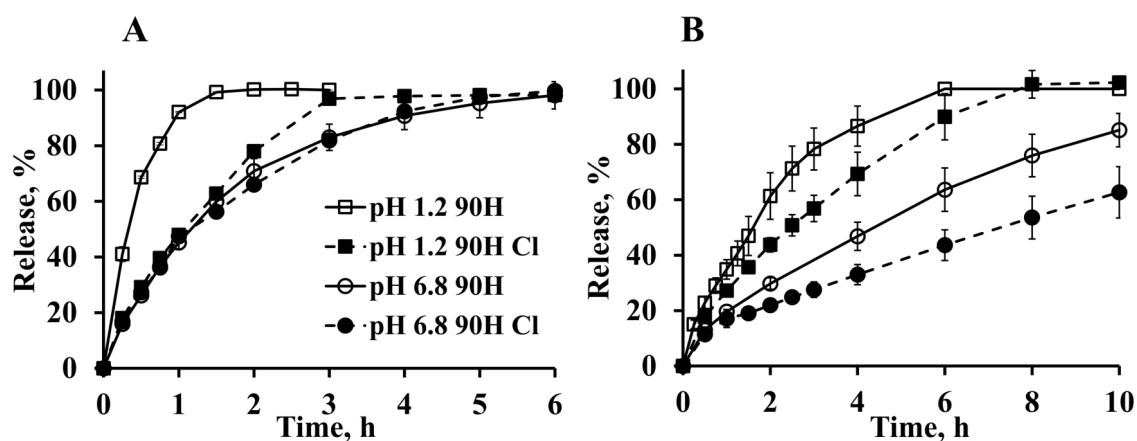

Figure 39. Caffeine release at (A) 60% drug loading and (B) 20% loadings from tablets composed of phosphatidylcholine chloride powder at different pH.

At lower drug loading (higher PC content), caffeine release was overall slower both in acidic medium and in phosphate buffer, however the pH dependent release maintained (Figure 39 B). The decrease observed in caffeine release rate was in line with initial suggestion that in acidic medium coupled chloride ion prevented massive influx of medium

ions into matrix and slowed down hydration; while in phosphate buffer – hindered hydration due to higher selectivity of quaternary ammonium group for chloride compared to phosphate ions (Fritz, 2005).

To estimate the gap in drug release at different pH, the ratio of drug released at 2 hours in HCl to PB was calculated both for treated and untreated powders. With bigger difference in drug release, higher ratio would be expected, whereas with pH independent behaviour it would be equal to 1. In effect, for formulations with 60% drug loading calculated ratio reduced from 1.43 to 1.18 for untreated and treated powders respectively, while at 20% drug loading, it was 2 for both, thus indicating that coupling 90H powder with chloride ions was a fair option to minimize pH dependent drug release only in formulations with high drug loadings.

Phosphatidylcholine powder spray-drying with calcium chloride

In order to avoid 90H powder treatment with 0.1N HCl and hence potential hydrolysis, spray drying of 90H dispersion in calcium chloride MilliQ[®] water solution at equimolar ratio was performed in mini spray dryer. Very fine cohesive powder with poor compaction properties was recovered. Water uptake study on placebo matrix, suggested that added chloride was not associated with quaternary ammonium, but rather resulted in physical mixture.

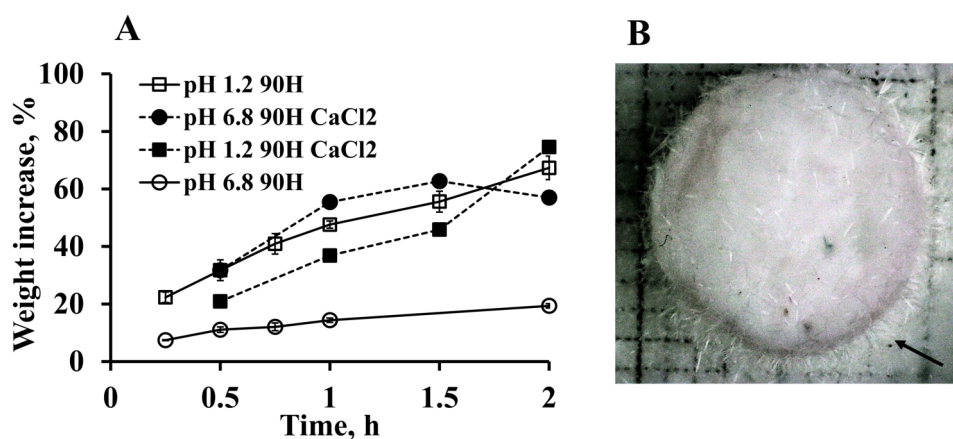

Figure 40. Effect of phosphatidylcholine spray drying with calcium chloride salt on water uptake at different pH (A); Macroscopic images of precipitated crystals of calcium phosphate on the placebo matrix surface (B).

Very slight reduction of hydration extent in acidic medium was observed between untreated PC powder and spray-dried with calcium chloride (Figure 40 A). Even more,

there was strong erosion of matrix in phosphate buffer, probably due to calcium phosphate precipitation, as it was revealed by macroscopic images (Figure 40 B). Furthermore, it was confirmed with conductivity measurements, that no complexation of chloride ion with quaternary ammonium occurred in non-acidic medium (i.e. while phosphate group was deprotonated and thus, negatively charged).

3.3.3.3 Formulation adjustment for pH independent release

Since PC powder complexation with chloride ions did not eliminate pH dependent matrix behaviour completely, common formulation adjustments were intended to disguise it. First, different methods were used to prepare matrix tablets with 60% caffeine loading: direct compression (DC); dry granulation (DG) and wet granulation (WG)

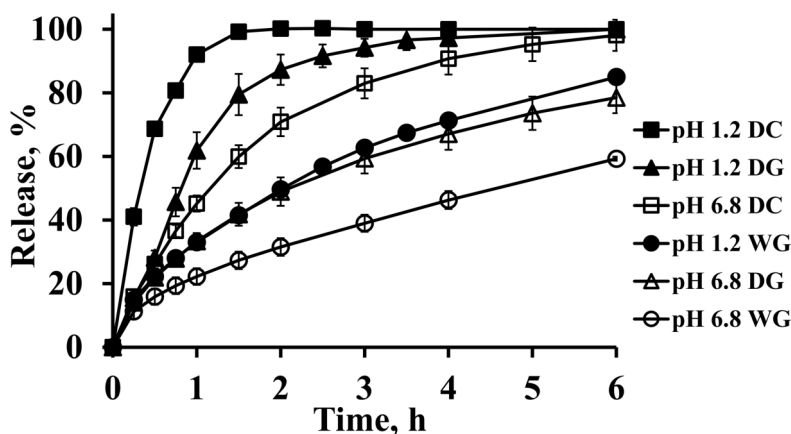

Figure 41. Effect of tablet preparation methods on caffeine release (60%) from phosphatidylcholine matrix tablets at different pH.

Caffeine release rate changed in the following order: direct compression > dry granulation > wet granulation (Figure 41), whereas the pH effect magnitude was very similar for all methods, ratio of drug released in HCl to PB at 2 hours ranged between 1.4-1.8 for all methods.

Addition of sodium dodecyl sulphate

The hydration of the materials containing cationic group is influenced by the ions present in dissolution media (Guo, X.D., Bodmeier, R., Sarabia, R., and Skultety, 1993) and can be altered by the mechanism of ion exchange. Sodium dodecyl sulphate (SDS) has been

shown to modify indomethacin release from Eudragit® RS-based matrix tablets by competing for the cationic sites of the latter (Khanfar et al., 1997). Furthermore, it has been reported that incorporation of up to 5% w/w sodium dodecyl sulphate (SDS) in the coating membrane of Eudragit RL/RS resulted in substantial increases in lag times in acidic and neutral media during diltiazem release (Heinicke and Schwartz, 2007).

Sulphate groups have a high affinity for quaternary ammonium and while, fatty acid chain exhibits interaction to hydrophobic moieties of PC. Therefore, it has been suggested that SDS could compete with medium anions in order to prevent fast matrix hydration in acidic medium. Since ion coupling was not feasible at neutral pH (MilliQ® water) and spray drying strongly affected powder properties, SDS was added to formulations as a physical mixture.

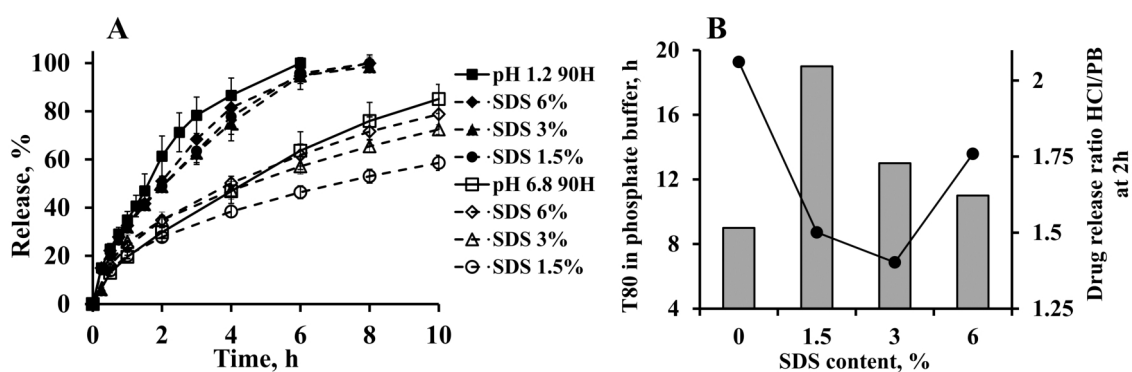

Figure 42. Effect of SDS amount in the formulation on (A) drug release from 20% caffeine tablets at different pH; (B) extension of drug release in phosphate buffer and on drug release difference at different pH.

Presence of SDS in formulation had very slight effect on drug release in acidic medium and was similar to 90H powder coupled with chloride ions, while, in phosphate buffer drug release was overall slower for SDS containing formulations. The effect was inversely proportional to the amount of SDS added (t_{80} 19, 13 and 11 hours for 1.5, 3 and 6% SDS, respectively, vs. 9 hours for 90H) (Figure 42 B). It was suggested, that dodecyl sulphate competed with phosphate ions hindering matrix hydration, hence extending caffeine release, however, at higher SDS content in formulation (6%) release was similar to 90H, probably due to solubilizing effect of SDS on API. Furthermore, the ratio of drug released at 2 hours in HCl to phosphate buffer was calculated, advocating that there should be an optimum SDS concentration in the formulation to effectively minimize pH dependent drug release.

Addition of basic agents: magnesium hydroxide

Control over microenvironmental pH inside the matrix was shown as a viable method to achieve pH independent release of weakly basic and acidic drugs (Doherty and York, 1989; Streubel et al., 2000). In particular, magnesium hydroxide, an insoluble salt of a strong base, was used to achieve pH independent release for acidic drug (Riis et al., 2007). It has been suggested, that magnesium hydroxide would react with HCl medium, neutralizing the microenvironmental pH, hence, leading to phosphate group of PC from deprotonation, and thus, slower matrix hydration. Therefore, tablets with different amount of magnesium hydroxide (2.5, 5, and 10% w/w) were prepared by direct compression.

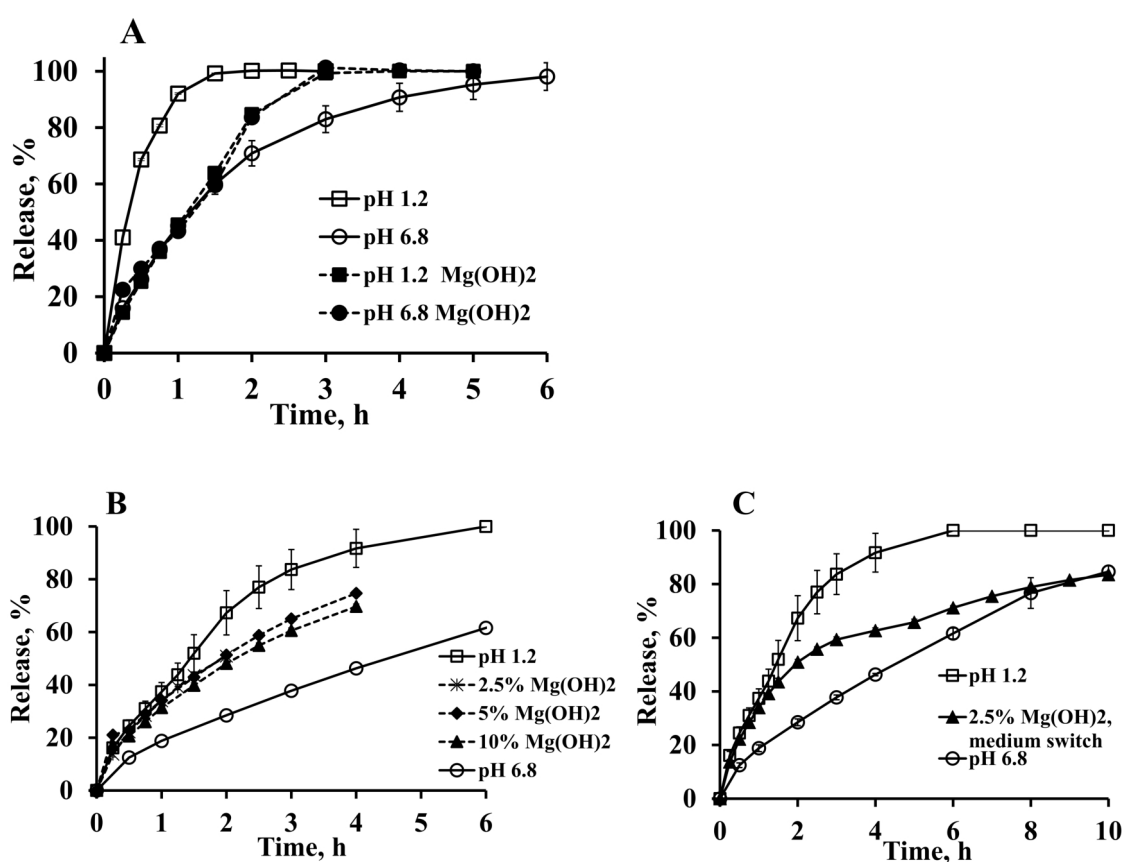

Figure 43. Effect of (A) magnesium hydroxide (2.5%) on caffeine (60%) release at pH 1.2 and 6.8; (B) magnesium hydroxide amount on caffeine (20%) release at pH 1.2; (C) medium switch after 2 hours from pH 1.2 to 6.8 for formulation with 20% caffeine and 2.5% magnesium hydroxide.

Addition of magnesium hydroxide to the formulation with 60% caffeine, resulted in pH independent drug release for 2 hours, very similar as when formulated with 90H powder treated with chloride ions (Figure 43 A). Furthermore, formulations with 20% drug

loading (i.e. higher PC amount) were tested. Addition of magnesium hydroxide to the formulation with 20% caffeine had no effect on drug release rate in first 2 hours, however, prevented tablets from complete disintegration in acidic medium (Figure 43 B). Although, the gap between drug releases at different pH maintained, the preservation of the matrix integrity allowed overall to achieve extended release, comparable to the one in phosphate buffer, once the medium was switched (Figure 43 C). Overall, addition of basifying agent was a viable approach to minimize pH dependent drug release from 90H matrix tablets.

Addition of insoluble and enteric polymers: ethyl cellulose, HPMCP, shellac

Addition of insoluble and enteric polymers with pH dependent behaviour has also been regarded as a viable method for adjustment of ionisable drug releases (Dashevsky, Kolter, and Bodmeier, 2004; Lecomte et al., 2003; Thoma and Ziegler, 1998). Therefore, the use of the enteric polymers hydroxypropyl methyl cellulose phthalate (HPMCP) and shellac as well as insoluble ethyl cellulose (EC) was considered.

HPMCP is a cellulose derivative, insoluble in gastric fluid while at pH 5-5.5 (i.e. upper intestine) it swells and dissolves rapidly (enteric properties). Similarly, shellac is a lac of natural origin with enteric solubility, regarded as GRAS material, whereas ethyl cellulose is water insoluble at any pH. It was hypothesized that polymers could prevent matrix swelling in acidic medium and therefore reduce pH effect by partially covering 90H particles in formulation.

Direct compression

90H was blended with ethyl cellulose (EC) and hydroxypropyl methyl cellulose phthalate (HPMCP) at 1:1 weight ratio. The powder blend was further formulated into the tablets with 60% of caffeine prepared by direct compression.

Addition of ethyl cellulose to the formulation resulted in pH independent drug release, however, it was significantly accelerated, comparable to the one from phosphatidylcholine matrix in acidic medium. On the other hand, drug release from HPMCP to 90H at 1:1 weight ratio minimized the pH gap and was comparable to caffeine release in phosphate buffer (Figure 44 A and B).

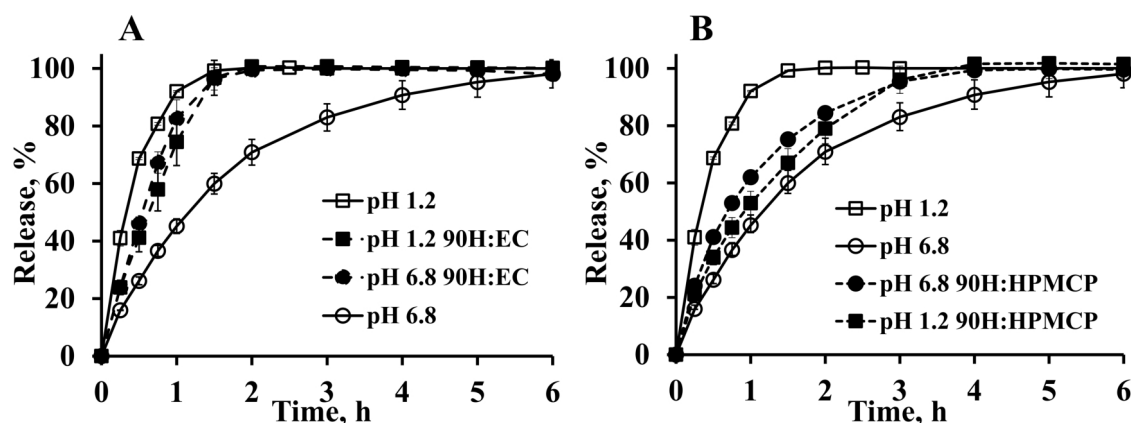

Figure 44. Effect of (A) ethyl cellulose and (B) hydroxypropyl methyl cellulose phthalate addition to tablet formulation on caffeine release from phosphatidylcholine matrices (60% drug loading) at different pH.

Wet granulation

To achieve a better coverage of 90H by polymers and to reduce polymers total amount in the formulation, wet granulation method was investigated to prepare tablets with 60% caffeine.

Addition of EC or HPMCP did not reduce the pH gap and overall caffeine release was faster in both media. However, tablets stayed intact (without noticeable erosion) during first 2 hours of release, indicating the possibility of extended release (Figure 45 A and B) once the media is switched. In contrast, shellac performed as expected, reducing the pH difference between drug releases and maintaining similar extended release as a control formulation (Figure 45 C). Despite positive outcome, there are several factors to consider before using shellac. Shellac is natural polymer and its composition and properties change noticeable with different providers. Furthermore, excipient performance may be compromised by aging due to storage, not to mention, that it is a colourful (strongly yellow) material, thus, may require additional coating (Farag and Leopold, 2011).

Spray drying

In order to achieve more effective polymer protection, 90H was spray dried with EC and HPMCP from alcoholic solution at 9:1 weight ratio and resulted powder was used to prepare tablets with different caffeine loadings by direct compression.

HPMCP containing formulations resulted in pH independent release at all drug loadings. EC provided pH independent release for low drug loading (20%) (Figure 46 A). However,

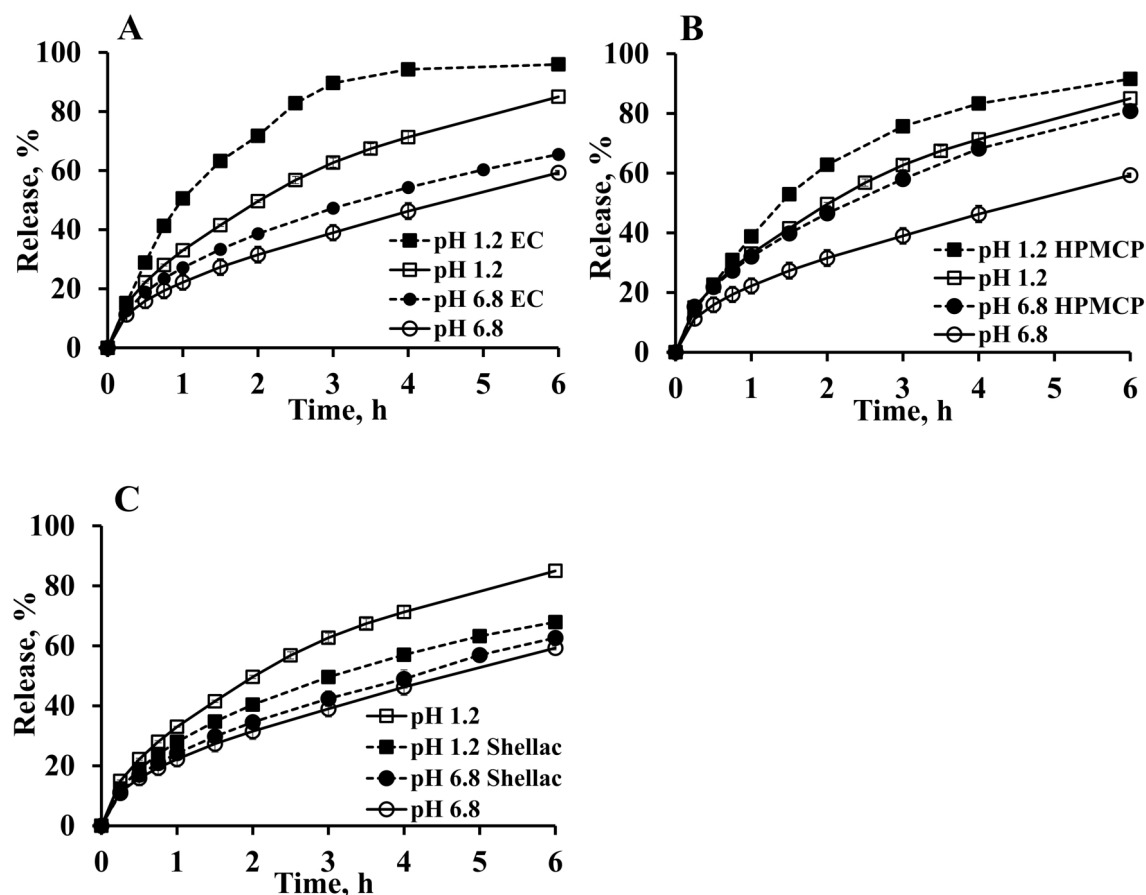

Figure 45. Effect of (A) ethyl cellulose (B) hydroxypropyl methyl cellulose phthalate and (C) shellac addition to the formulation of 60% caffeine tablet by wet granulation on drug release at different pH.

with increasing drug loading (60%) release curve had sigmoidal profile (Figure 46 B), suggesting a rupture of rigid coating-like EC layer due to high osmotic pressure after two hours of dissolution testing (Bodmeier and Paeratakul, 1994).

3.3.3.4 Alternative excipients

As it has been previously discussed, conventional methods regarding formulation adjustment can further help to disguise pH dependent drug release from phosphatidylcholine matrices. However, the understanding of the mechanism of pH dependent behaviour was crucial in order to minimize such effect or completely eliminate it. Once, the presence of the two ionisable groups in PC structure and in particular, quaternary ammonium group was identified as a “trouble-maker” in terms of pH, an effort has been directed to

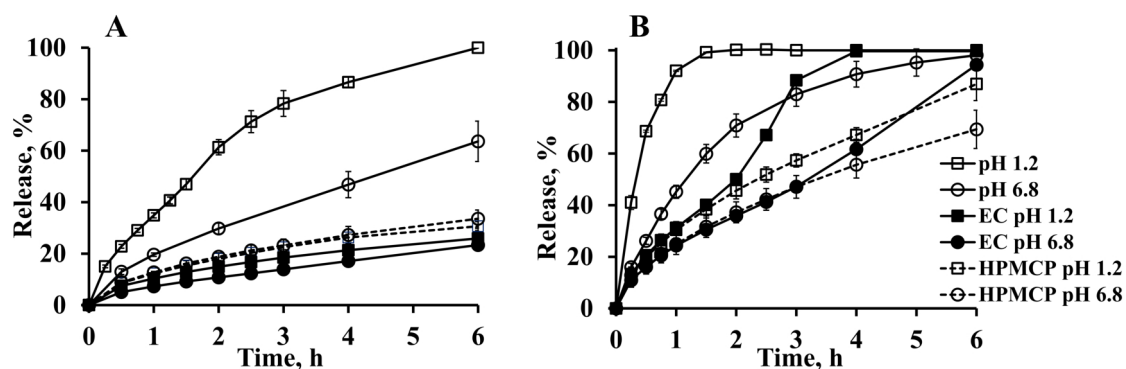

Figure 46. Caffeine release at (A) 20% drug loading and (B) 60% drug loadings from tablets composed of co-processed phosphatidylcholine (PC) with EC and HPMCP polymers by means of spray-drying at different medium pH.

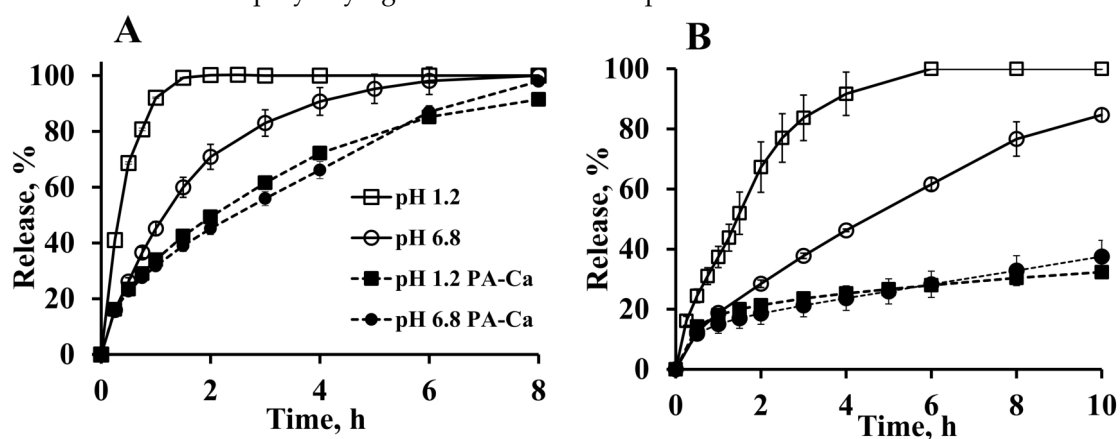

Figure 47. Comparison of caffeine release (A) 60% drug loading and (B) 20% drug loadings from phosphatidylcholine (PC) and phosphatidic acid calcium salt matrices at different medium pH.

screen for similar “family” excipients which would include the advantages of hydrogenated phosphatidylcholine, lacking its pH sensitivity.

Hydrogenated phosphatidic acid calcium salt has been identified as such excipient. The hydrogenation of fatty acid side chains allowed the material to stay in suitable powder form, the absence of quaternary ammonium group excluded pH dependent hydration, while calcium salt assures insolubility of material, thus, its potential suitability for providing extended drug release.

As it was speculated, caffeine release from hydrogenated phosphatidic acid calcium salt was pH independent at all drug loadings and was remarkably slower than from phosphatidylcholine matrix (Figure 13), potentially promising ability to sustain release of very water-soluble drugs at increased matrix loadings as well.

3.3.3.5 Outlook

In this work the main effort was made to “correct” pH dependent behaviour of phosphatidylcholine in order to assure its extended release matrix forming qualities. However, it might be interesting, in contrary, to further explore described effect e.g. for taste masking formulation approaches or enhancing solubility of weakly acidic drugs (e.g. NSAID), as well as to consider PC as a candidate for parenteral matrix drug delivery systems.

3.3.4 Conclusions

The mechanism of pH dependent hydration of phosphatidylcholine matrices was elucidated and discussed. Several approaches to minimize apparently pH dependent drug release have been suggested, both including modifications of initial phosphatidylcholine powder, as well as conventional formulation adjustments. Although, none of proposed methods alone offered complete solution *in vitro* (e.g. at low drug loadings, compromised powder properties, flow and compactability, etc.), some approaches had promising results, which potentially could result in suitable *in vivo* performance.

3.4 Evaluation of Hydrogenated Soybean Phosphatidylcholine Matrices Prepared by Hot Melt Extrusion for Oral Controlled Delivery of Freely Soluble Drugs

Abstract

The aim of this study was to prepare controlled release matrices from hydrogenated soybean phosphatidylcholine powder by hot melt extrusion for oral drug delivery of water-soluble drugs. The liquid crystalline nature of phosphatidylcholine allowed its extrusion at 120°C, which was below its capillary melting point. Model drugs with a wide range of water solubilities (8, 20 and 240 mg/mL) and melting temperatures (160-270°C) were used. Extrudates with up to 70% drug loading were prepared at temperatures below the melting points of the drugs. The crystalline states of the drugs remained unchanged through the process as it was confirmed by XRD and hot stage microscopy. The time to achieve 80% release (t_{80}) from extrudates with 50% drug loading were 3, 8 and 18 h for diprophylline, caffeine and theophylline, respectively. The effect of matrix preparation method (extrusion vs. compression) on drug release was evaluated. For non-eroding formulations, the drug release retarding properties of the phosphatidylcholine matrix were mostly not influenced by the preparation method. However, with increasing drug loadings, compressed tablets eroded significantly more than extruded matrices, resulting in 2 to 11 times faster drug release. Diffusion was identified as the main mechanism of drug release from phosphatidylcholine extrudates. There were no signs of erosion observed in extrudates with different drugs up to 70% loadings. The mechanical robustness of phosphatidylcholine extrudates was attributed to the formation of a skin-core structure and was identified as the main reason for the drug release controlling potential of matrices produced by hot melt extrusion.

Keywords

Hydrogenated soybean phosphatidylcholine; hot melt extrusion; extended release matrix; mathematical modelling; oral controlled release

3.4.1 Introduction

In oral drug delivery, the control over drug release rates from the dosage forms is often achieved by application of coatings or by formulation of matrix systems. A variety of swellable or non-swellable synthetic polymers are used as matrix-forming excipients with some being suitable for controlling the release of drugs over a broad range of drug solubility and drug loading (Grund et al., 2014; Maderuelo, Zarzuelo, and Lanao, 2011; Roberts et al., 2015).

Hydrogenated soybean phosphatidylcholine was recently investigated as a promising excipient to form matrix tablets by direct compression (Kolbina, Bodmeier, and Körber, 2017). Besides its natural origin, it is chemically defined and available in pharmaceutical grade quality (Hoogevest, 2017). Hydrogenated soybean phosphatidylcholine powder had excellent flow properties, processability by compression as well as sufficient potential to extend release of water-soluble drugs. However, the ability to control release of highly soluble drugs was compromised due to matrix erosion / disintegration at higher drug loadings (>30%).

The preparation of matrices by thermal processing techniques has been regarded as more efficient to control release of water-soluble drugs compared to direct compression due to the formation of less porous, tortuous matrices. The drug release mechanism from ethyl cellulose (EC) matrix tablets prepared by either direct compression or hot melt extrusion of binary mixtures of water-soluble drug (guaifenesin) and the polymer was investigated by (Crowley et al., 2004). Further, an extended release with up to 50% diltiazem hydrochloride was achieved from pellets prepared by hot melt extrusion with ethylcellulose, cellulose acetate butyrate, poly(ethylene-co-vinyl acetate) and polymethacrylate derivatives (Follonier, Doelker, and Cole, 1994). Hydrophobic lipids and waxes with low melting points have also been used to prepare controlled-release oral dosage forms by hot melt extrusion. The dissolution mechanism from lipophilic matrices prepared by hot melt extrusion is mainly governed by diffusion (Güres et al., 2012; Siepmann et al., 2006), whereas release kinetics depended on physicochemical properties (such as swelling ability and solubility) of added rate-controlling agents (Sato et al., 1997).

The effect of drug loading and the type of lipid excipient on drug release was investigated by De Brabander et al., 2000. Microcrystalline wax with different melting temperatures

was used as a matrix excipient for melt granulation of ibuprofen. *In vitro* drug release rate decreased with decreasing drug loading and with increasing melting temperature of wax used. Furthermore, effects of different formulation parameters on drug release from tablets compressed from hot melt granules and those, prepared by high shear melt granulation, were studied (Liu, Zhang, and McGinity, 2001). Tailored release of paracetamol from calcium stearate pellets prepared by hot melt extrusion was achieved by addition of plasticizers, glyceryl monostearate (GMS) and tributyl citrate (Roblegg et al., 2011). Furthermore, to achieve flexible individual dosing, extended release formulations with co-extruded wax coating were prepared (Laukamp et al., 2015).

Melt extrusion is generally carried out under elevated temperature, therefore, significant physicochemical changes can take place during the process. Drugs can either be dispersed as crystalline particles or dissolved and/or amorphized in the formulation, depending on the miscibility between the drug and various lipid excipients, pore formers, and processing conditions (Hasa et al., 2011; Vithani et al., 2014). The solubilization of metoprolol tartrate in stearic acid during melt extrusion was described (Monteyne et al., 2016). Additionally, combination of stearic acid and high molecular weight polyethylene oxide (PEO) at different ratios also resulted in different drug release profiles due to the hindered hydration of the polymer as a result of molecular interactions between the excipients.

High dose formulations of highly water-soluble drugs were achieved by using lipid excipients at a low level (less than 15%) as a thermal lubricant to facilitate the melt granulation process. The granules were then compressed into sustained-release tablets containing also conventional polymers, such as hydroxypropyl cellulose and ethyl cellulose as drug release retardants (Nart et al., 2017; Vaingankar and Amin, 2017).

In contrast to triglycerides and synthetic lipids, phosphatidylcholine capillary melting occurs at very high temperature of 230°C followed by material decomposition, which could be a hurdle for its thermal processing or the stability of the incorporated drug.

The aim of this study was to evaluate the feasibility of processing hydrogenated soybean phosphatidylcholine by hot melt extrusion and, furthermore, to evaluate the release rate controlling potential of the matrices with special attention to high loadings of water-soluble model drugs.

3.4.2 Materials and Methods

3.4.2.1 Materials

Hydrogenated soybean phosphatidylcholine containing mainly esterified stearic and palmitic acid (Phospholipon[®] 90H, Lipoid GmbH, Ludwigshafen, Germany), caffeine anhydrous fine powder, theophylline anhydrous micronized powder, diprophylline (BASF SE, Ludwigshafen, Germany), micronized dexamethasone (Fagron GmbH, Barsbeuttel, Germany), magnesium stearate (Baerlocher GmbH, Unterschleissheim, Germany).

3.4.2.2 Thermal Analysis by Dynamic Scanning Calorimetry

Thermograms of phospholipid powder were recorded using a DSC 6000 (PerkinElmer, Inc. Waltham, MA, USA). Samples of about 10 mg were accurately weighted in 50 μ L aluminium pans. DSC scans were recorded using a heating rate of 10°C/min at an interval from 25 to 250°C.

3.4.2.3 Preparation of Extrudates

Homogeneous drug and phospholipid blends were prepared at different weight ratios (10, 20, 30, 50 and 70%) with mortar and pestle. Blends were loaded into a syringe-die extrusion device (Ghalanbor, Körber, and Bodmeier, 2010), heated at 135°C for 5 to 9 min depending on the drug to lipid ratio and then extruded manually. Cylindrical matrices with diameter of 1.1 and 2 mm were obtained and cut in 2 and/or 8 mm extrudates for further characterization.

3.4.2.4 Characterization of Extrudates

X-ray diffraction (XRD) measurements were performed to evaluate solid state of drugs after extrusion with hydrogenated soybean phosphatidylcholine with PANalytical XPert PRO diffractometer (Bragg-Brentano geometry, Cu-K α radiation, PANalytical B.V., Almelo, The Netherlands). The diffraction angle range was between 10° and 80° 2 Θ (data shown till 40° 2 Θ) with a step size of 0.026°.

Scanning electron microscopy (gold sputtering, Quanta 200 SEM, FEI Corporate, Hillsboro, OR, USA) was used to evaluate the surface morphology of extrudates.

Light microscopy images (Zeiss Axioskop, Carl Zeiss Microscopy GmbH, Jena, Germany)

were taken to confirm anisotropic behaviour of phosphatidylcholine during thermal transitions. Temperature control was achieved by hot stage (FP 90 Central Processor, Mettler Toledo, Greifensee, Switzerland).

Matrix erosion was evaluated by calculating percent of mass recovery of insoluble phosphatidylcholine matrix after the completed drug released to initial phosphatidylcholine mass in the extrudates and/or tablets.

3.4.2.5 Preparation of Tablets

The phosphatidylcholine powder (sieve fraction 90-180 μm) was blended with the drug for 10 min in a Turbula mixer (Willy A. Bachofen AG, Basel, Switzerland), 1% w/w magnesium stearate was added to the blend and further mixed for 3 min. The powders were compressed into 8 mm diameter, flat-faced tablets (160 ± 2 mg) at 300 MPa using a single punch tablet press at 10 rpm (Korsch EK0, Korsch AG, Berlin, Germany). The compression force was recorded (MGCplus, Catman, HBM Inc, USA).

3.4.2.6 Porosity Measurement

The matrix porosity was calculated as the percent ratio of apparent and true densities. The true density of phosphatidylcholine was determined by helium pycnometer (AccuPyc II1340, Micromeritics Instrument Corp., Norcross, USA).

3.4.2.7 *In Vitro* Drug Release Studies

Drug release was performed using a USP II apparatus (VK 7000, Agilent Technologies Deutschland GmbH, Böblingen, Germany). (75-100 rpm, 900 mL, 0.05 M phosphate buffer pH 6.8 at 37°C, n=3. Samples were taken at predetermined time points and analysed UV-spectrophotometrically ($\lambda=273$ nm for all drugs).

3.4.2.8 Mathematical modelling

Non-linear fitting was performed with Solver Add-in MS Office, applying the least sum of squares method. f_2 values were calculated to assess similarity of calculated and experimentally obtained curves using the following Equation:

$$f_2 = 50 \log_{10} \left(\left[1 + \frac{1}{n} \sum_{t=1}^n (R_t - T_t)^2 \right]^{-0.5} \times 100 \right) \quad (\text{Eq. 9})$$

where R_t and T_t are the cumulative percentages dissolved at each of the selected n time points, t , of the reference and the test sample.

f_2 values of 50 or higher ensure equivalence of the two considered curves; a value of lower than 50 indicates significant difference between two curves (Shah et al., 1998).

3.4.3 Results and Discussion

3.4.3.1 Thermal characterization of saturated phosphatidylcholine in dry state

Phosphatidylcholines are materials with reported melting temperatures of 220-235°C (Koynova and Caffrey, 1998). Several transitions to liquid crystalline states occur at lower temperatures (Chapman, Williams, and Ladbrooke, 1967). To assess extrudability of the material and explore temperatures, at which transitions occur, the thermal behaviour of hydrogenated phosphatidylcholine powder was characterized by differential scanning calorimetry (DSC).

A number of endothermic events were observed (Figure 48 A). A major endothermic peak was detected at 125°C, which corresponded to side chains partial melting and thus, phosphatidylcholine transition to the liquid crystalline state (Chapman, Williams, and Ladbrooke, 1967). Furthermore, transitions at 145, 160 and 180°C were observed, reflecting further phase transitions. Finally, a small peak was observed at 233-235°C, where the capillary melting of the phosphatidylcholine was expected (Figure 48 B) (Koynova and Caffrey, 1998). The considerably lower enthalpy of the melting peak could probably be explained by material's already largely fluidized state, and corresponded to the breakage of ionic network between polar head groups (Williams and Chapman, 1971).

The endothermic peaks of the DSC thermogram were correlated with temperatures, where visible morphological changes could be observed under a hot-stage microscope (Figure 48 C). At room temperature phosphatidylcholine particle presented characteristic crystalline birefringence under polarized light. The intensity of the birefringence decreased

and the particle shape changed slightly to a more diffuse structure at about 125°C, indicating a certain degree of deformability. With further temperature increase the particle became more molten (spherical), however, a liquid crystalline character was maintained up to 235°C, confirming the presence of ordered structures until reaching the capillary melting of phosphatidylcholine.

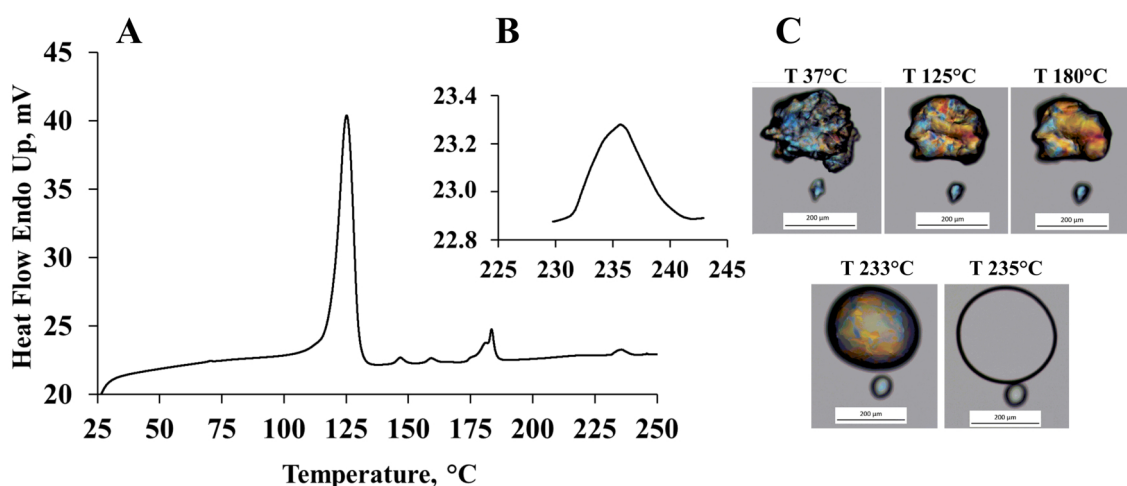

Figure 48. DSC thermogram of saturated phosphatidylcholine in dry state coupled with hot stage microscopy images.

In general, hydrogenated soybean phosphatidylcholine behaved as anisotropic fluids i.e. rotated the plane of polarization of light and, at the same time, could flow as a liquid under applied pressure (Byrne and Chapman, 1964; Ladbroke and Chapman, 1969; Williams and Chapman, 1971) and thus, could be potentially extruded at the transition temperature of liquid crystalline state.

However, due to the natural origin of the material and therefore not completely defined composition of side acyl chains, reported transition temperatures could vary between batches, as well as could depend on previous material thermal history, the presence of ions and, especially, on powder moisture content. The plasticizing effect of moisture on reducing polymer glass transition temperature as well as melt viscosity is known for other materials and has been used to enhance the processability of polymers by hot melt extrusion and other pharmaceutical processes (Bravo-Osuna, Ferrero, and Jiménez-Castellanos, 2006; Hancock and Zografi, 1997). Although, there was no systematic study performed, moisture content of the powder appeared to effect the phosphatidylcholine

powder processability. Hydrogenated soybean phosphatidylcholine powder with initial moisture content ranging between 1.5 and 2.5% (w/w) was easily processed at 120°C, whereas powders with moisture content of less than 1.5% (w/w) could not be extruded with a studied set up (mini-ram extruder) up to 170°C. Molecular mechanisms behind the observed effect might be explained by the ability of phosphatidylcholine to form certain mesomorphic phase structures of liquid crystal domains, which could have an effect on rheology and thus, processability of phosphatidylcholine powder by extrusion. It has been demonstrated, that also in apparently dry phospholipid powder (< 6% water) transitions to lamellar, cubic and hexagonal phases (typical for phospholipid water-rich systems) occurred as a function of water content, however, at significantly higher temperatures, i.e. above liquid crystalline transitions (Luzzati, Gulik-Krzywicki, and Tardieu, 1968). The inability to form rod-like mesophases in completely anhydrous phospholipids has also been stated (Chapman, Williams, and Ladbrooke, 1967). Thus, moisture content in hydrogenated soybean phosphatidylcholine powder is a critical material attribute, which should be further investigated in regard to hot melt extrusion process.

3.4.3.2 Extrudate preparation and characterization

Drug loaded extrudates were prepared at a temperature above the liquid crystal transition temperature of the hydrogenated phosphatidylcholine but below the drug melting temperature, thus, no changes in drug crystallinity were expected. The transition of phosphatidylcholine powder with initial moisture content of 1.5% resulted in sufficiently plastic viscous mass and allowed successful phospholipid extrusion at 135°C. The model drugs were selected to cover wide range of water solubility and melting temperatures (Table 18). Extrudates with up to 50% (w/w) drug loading were prepared with caffeine, and with up to 70% (w/w) with diprophylline and theophylline.

Table 18. Overview of model drugs used in present study.

| Drug | Solubility* | Melting temperature | Molecular weight | Particle size |
|---------------|-------------|---------------------|------------------|-----------------|
| | mg/ml | °C | g/mol | D ₅₀ |
| Diprophylline | 240 | 162 | 254 | 6.41 ± 0.58 |
| Caffeine | 20 | 235 | 194 | 12.69 ± 0.20 |
| Theophylline | 8 | 273 | 180 | 7.32 ± 0.44 |

* in phosphate buffer pH 6.8, at room temperature

All matrices could be easily extruded, however, longer heating times were required at increasing drug loading from 5 to 9 minutes for 10 to 70% loadings, respectively, i.e. extrudates had smooth surfaces, without visible cracks or pores. They were increasingly white and shiny at increasing amount of dispersed drug (Figure 49). Extrudates at all drug loadings were not brittle and could be handled without problems during the experiments.

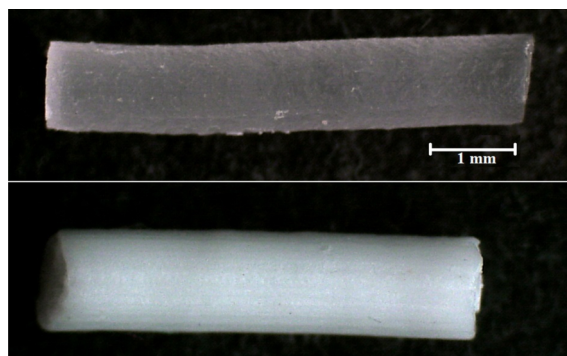

Figure 49. Macroscopic pictures of extrudates: (upper) placebo saturated phosphatidylcholine (lower) 50% theophylline loaded extrudate.

XRD was performed on extrudates to characterize the drugs' crystallinity before and after the extrusion process below their melting temperature. Unchanged peak characteristics gave no indication for any polymorphic transformation of the drug. The resulting extrudates were thus, composed of crystalline drug particles of its original polymorph (anhydrous caffeine in form II) dispersed in a (recrystallized) matrix of phosphatidylcholine (Figure 50).

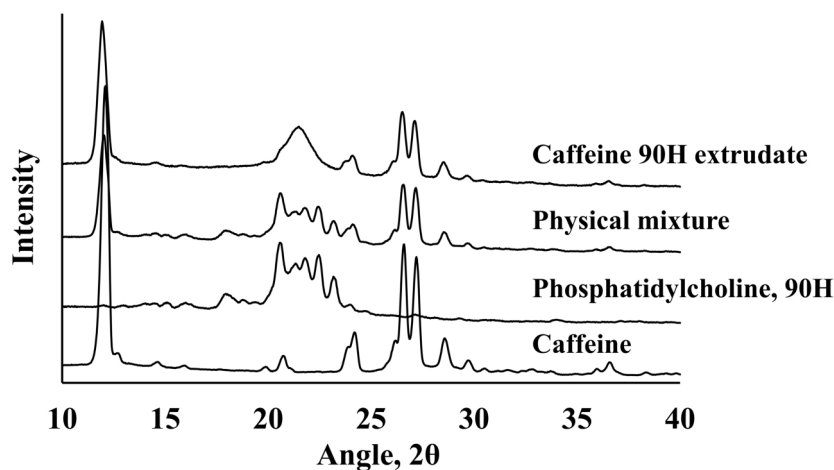

Figure 50. Powder X-ray diffraction pattern of caffeine - phospholipid extrudate with 50% drug loading, caffeine - phosphatidylcholine powders physical mixture (50%), phosphatidylcholine and caffeine.

Furthermore, to confirm the absence of potential solubilizing effect of molten acyl chains of phosphatidylcholine during extrusion, physical mixtures of caffeine and phospholipid were observed under polarized light on the hot stage microscope. During heating the powder blends up to the processing temperature, the transition of the phospholipid to liquid crystalline state could be observed, however, drug crystals remained undissolved (data not shown). Similar XRD and hot stage microscopy results were obtained with theophylline and diprophylline. Thus, no effect on drugs' crystallinity and hence solid state was seen during extrusion with hydrogenated soybean phosphatidylcholine.

3.4.3.3 Dissolution performance

Drug release from extruded matrices at different drug loadings and water solubility was studied. The times to achieve 80% release (t_{80}) from matrices loaded with 10% drug were 3, 12 and 24 hours for diprophylline, caffeine and theophylline, and for matrices with 50% drug loadings they were 3, 8 and 18 hours, respectively (Figure 51). Release rates were decreasing with decreasing drug water solubility and drug loadings. Interestingly, with matrices loaded with highly soluble diprophylline, no appreciable changes in release rates with increasing drug loading were observed.

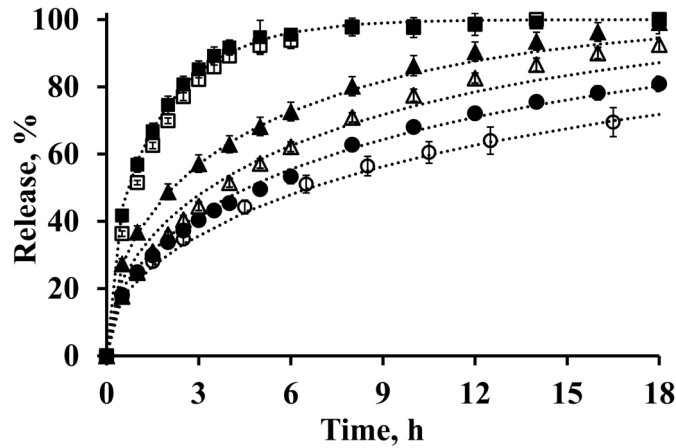

Figure 51. Experimental (symbols) and fitted (dotted lines) drug release profiles from extrudates with 10 and 50% loadings of diprophylline (\square , \blacksquare) (radius (R)=0.5 and height (H)=8 mm) and caffeine (Δ , \blacktriangle) (R =1 and H =2 mm), respectively; and 30 and 50% loadings of theophylline (\circ , \bullet) (R =1 and H =2 mm).

The experimental release data could be well approximated to the mathematical solution of Fick's second law of diffusion (Eq. 10 by Vergnaud, 1993), indicating that main mass transport mechanism was diffusion. The applicability was supported by the observation of constant matrix dimensions, hence absence of matrix erosion and/or remarkable swelling effects during dissolution testing.

$$\frac{Mt}{M\infty} = 1 - \frac{32}{\pi^2} \sum_{n=1}^{\infty} \frac{1}{q_n^2} \exp\left(-\frac{q_n^2 n}{R^2} D_{app} t\right) \sum_{p=0}^{\infty} \frac{1}{(2p+1)^2} \exp\left(-\frac{(2p+1)^2 \pi^2}{H^2} D_{app} t\right) \quad (\text{Eq. 10})$$

where Mt and $M\infty$ are the absolute cumulative amounts of drug released at time t , and infinite time, respectively; q_n are the roots of the Bessel function of the first kind of zero order [$J_0(q_n) = 0$], D_{app} apparent diffusion coefficient, and R and H are the radius and height of the cylinder.

Furthermore, the correlation of the apparent diffusion coefficients obtained from Equation Eq. 10 and the aqueous solubility of the drugs (Figure 52) showed behaviour similar to what was previously observed for drug matrices based on the synthetic polymer Kolidon SR (Grund et al., 2013) and was also in agreement with other reports, stating that drug solubility strongly affected drug release rate up to a certain extent, beyond which the release from the matrix system was less dependent on drug solubility (Harland et al., 1988; Yang and Fassihi, 1997) (Figure 52).

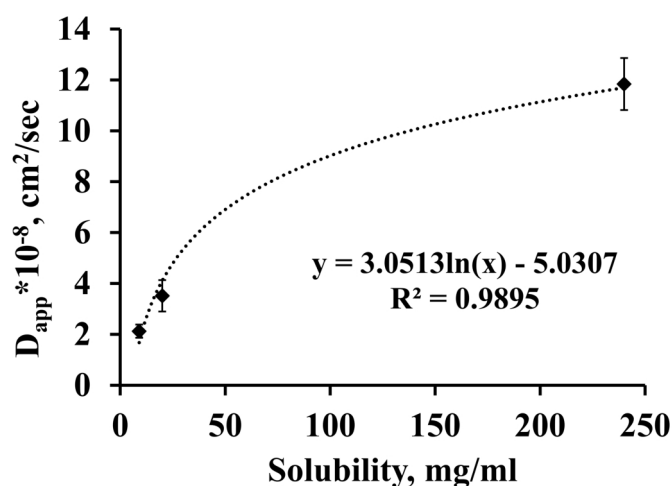

Figure 52. Effect of drug solubility on apparent diffusion coefficient from extruded phosphatidylcholine matrices at 50% drug loading.

3.4.3.4 Effect of matrix preparation on drug release

To evaluate the impact of matrix preparation method, the drug release of matrices prepared by either extrusion (1 or 2 mm diameter) or by direct compression (8 mm diameter) were compared at different drug loadings. The release profiles were normalized for actual matrix dimensions, by calculating apparent diffusion coefficients from the individual release profiles according to Eq. 10 in order to account for the dimensional differences between tablets and extrudates.

Previously, the slower drug release from hot melt extruded matrices in comparison to tablets was described for ethyl cellulose matrices, which was attributed to a reduced porosity of extrudates (Crowley et al., 2004). In case of phosphatidylcholine, although, the air porosity was indeed slightly lower in extrudates (no more than 1% vs. 2-4% for tablets loaded with 10-50% caffeine), calculated D_{app} of extruded and compressed matrices resulted in very similar values for non-eroding formulations (caffeine 10% and theophylline 30%) (Table 19), indicating that matrix retarding capacity was not influenced by the used preparation method. In contrary, for formulations with 50% drug loadings, the calculated D_{app} values were 11, 7 and 2 times lower for diprophylline, caffeine and theophylline matrices prepared by hot melt extrusion, respectively.

Table 19. Calculated D_{app} values for extruded and compressed matrices.

| Drug | Drug loading, % | $D_{app} * 10^{-8}, \text{cm}^2/\text{sec}$ | |
|---------------|-----------------|---|---------|
| | | Extrudates | Tablets |
| theophylline | 30 | 1.11 | 0.72 |
| caffeine | 10 | 3.21 | 3.35 |
| diprophylline | 10 | 6.69 | 11.22* |
| theophylline | 50 | 2.23 | 4.62* |
| caffeine | 50 | 4.07 | 37.0* |
| diprophylline | 50 | 10.81 | 126* |

*compressed matrices eroded significantly, therefore the D_{app} values were only calculated for comparison reasons

A reason for higher retardation capacity of extruded matrices could be the complete lack of erosion at all drug loadings observed during dissolution testing. To evaluate the effect of matrix erosion on release rate, 10% diprophylline tablets with early onset of erosion were compared to corresponding extrudates. While the initial phase of release was governed by diffusion and was in agreement with predicted profile, calculated based on non-eroding extrudate, further deviation of experimental release illustrated accelerating effect of matrix erosion on drug release (Figure 53 A).

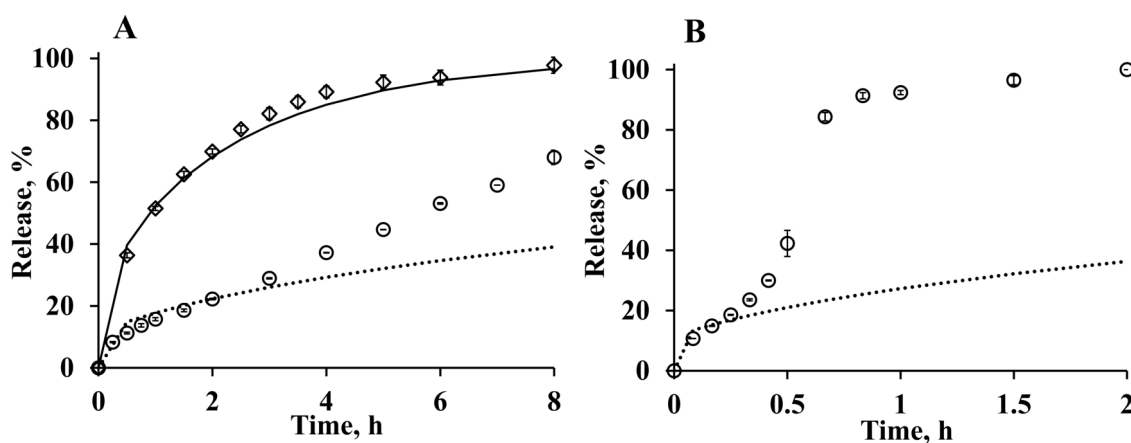

Figure 53. Drug release from (A) 10% and (B) 50% loaded diprophylline tablets and extrudates with identical composition. Open symbols (\diamond) with solid line represent experimental and fitted drug release from extrudates ($R=0.5$; $H=8$ mm), open symbols (\circ) and dotted lines – experimental and predicted release from tablets ($R=4$; $H=2.8$ mm), respectively.

Additionally, to evaluate controlling potential of extruded phosphatidylcholine matrices

same calculations were performed for 50% diprophylline tablets (Figure 53 B). In order, to observe erosion driven S-shape release profile from tablets, time-axes were enlarged, and therefore significantly slower release from extruded matrices was not shown. The gap between experimental release from tablets and the prediction based on non-eroding extrudate, indicated the control gained over the drug release, once matrix integrity could be preserved through the dissolution testing, and which was successfully achieved by phosphatidylcholine extrusion.

Thus, the mechanical resistance to erosion through a wide range of drug loadings and solubility was the main reason for the release controlling potential of extruded phosphatidylcholine matrices, while slightly reduced air porosity did not primarily affect drug release.

3.4.3.5 Erosion of phosphatidylcholine matrices

To establish the extent of extrudate resistance to erosion, the phospholipid matrix recovery (% w/w) after complete drug release was determined for caffeine and diprophylline extrudates and compared with tablets (Figure 54). Caffeine tablets showed no erosion up to 30% drug loading. The weight of insoluble phospholipid fraction remaining after the completed drug release was recovered fully (approx. 100%), followed by gradual decrease in recovery at increasing drug loadings (85.5 ± 3.7 and $52.3 \pm 13.9\%$ for 40 and 50% caffeine loading), while at 70% drug loading, tablets completely disintegrated and no matrix could be collected. In contrary, extruded matrices were fully recovered after completed drug release at drug loadings up to 70%.

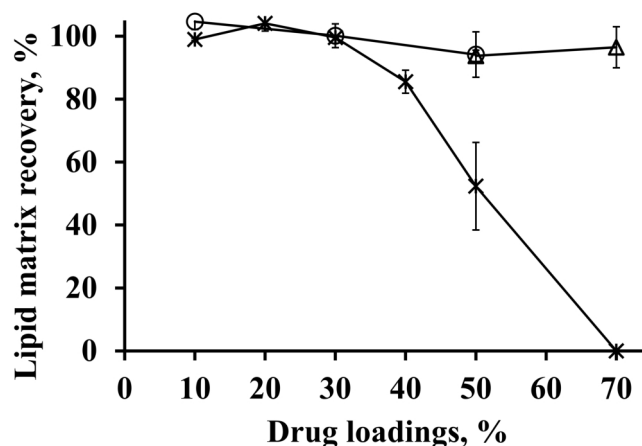

Figure 54. Effect of drug loading on phospholipid matrix recovery for 8 mm caffeine tablets (*) and extrudates with caffeine (O) and diprophyline (Δ).

The remarkable mechanical strength and, in particular, the resistance to erosion of extruded matrices was attributed to a high degree of molecular interaction of molten acyl-chains during processing. Scanning electron microscope images of extruded matrices after completed drug release showed a highly interconnected network (axial direction) with pores of about 20-30 μm probably corresponding to previous drug clusters (Figure 55 A₁ and A₂). The radial surface, however, remained smooth and tight with just small pores of few μm diameter (Figure 55 B₁ and B₂), representing a skin-core structure of extruded matrices, which could explain its mechanical resistance to erosion.

On the other hand, in compressed matrix very limited interparticulate bonding between deformed phospholipid particles was observed, confirming matrix susceptibility to erosion (Figure 55 C₁ and C₂). It was believed, that due to its liquid crystalline nature, molten domains of phosphatidylcholine were stretched by elongational flow, and rod-like acyl chains become aligned to the flow direction during extrusion, yielding indistinct boundaries, while being attached to phosphate choline head which maintained high degree of order. Similar behaviour during extrusion was studied and described in detail for thermotropic liquid crystalline polymers, where it has been associated with enhanced mechanical properties of final extrudates (Ide and Ophir, 1983; Weiss, Huh, and Nicolais, 1987).

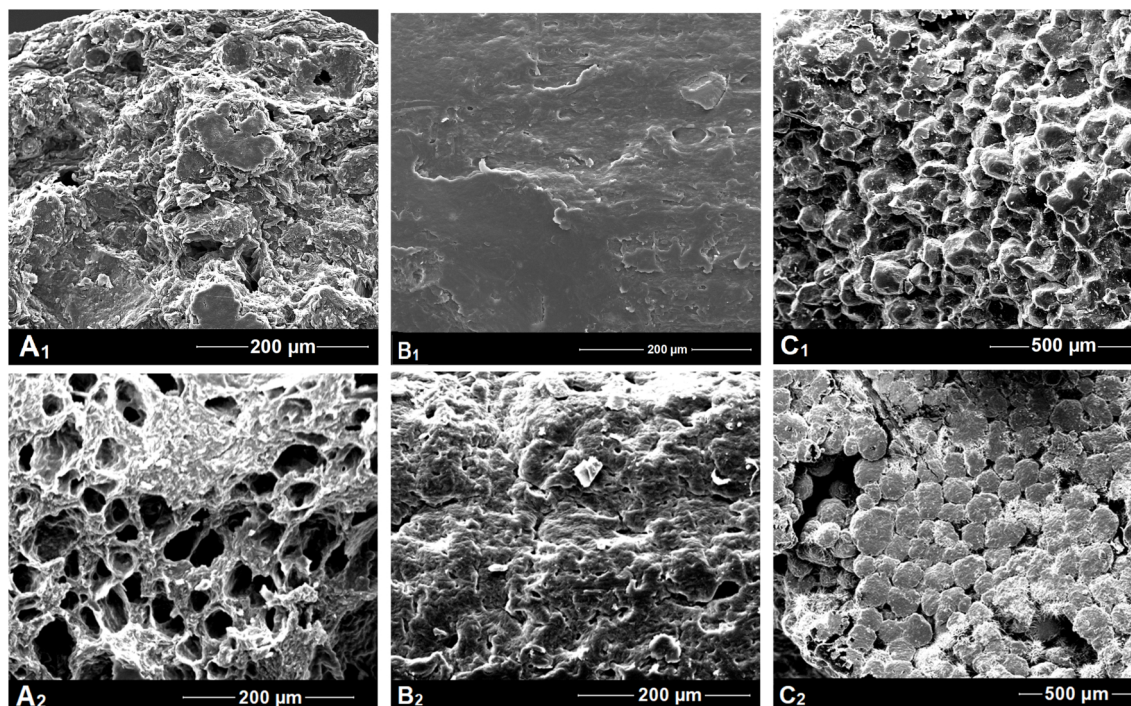

Figure 55. SEM images of 30% caffeine matrices at 600x magnification. From left to right: Extruded matrix cross section surface: (A₁) before dissolution and (A₂) after the completed drug release; Extruded matrix side surface (B₁) before dissolution and (B₂) after the completed drug release; Compressed matrix cross section surface (C₁) before dissolution and (C₂) after the completed drug release.

3.4.4 Conclusions

Hydrogenated soybean phosphatidylcholine powder was extruded at a temperature lower than its capillary melting point, due to its liquid crystalline nature. Release controlling matrices could be prepared by extrusion with up to 70% loadings of micronized drugs and no changes in their solid state were observed. Phosphatidylcholine matrices produced by hot melt extrusion resulted mechanically stronger and denser compared to directly compressed tablets and thus, were capable of effective retardation of highly water-soluble drugs at elevated drug loadings for oral delivery. Diffusional mass transport was assured by complete lack of erosion of extruded phosphatidylcholine matrices at all drug loadings, and therefore, was the main mechanism controlling drug release.

Acknowledgements

This work was supported by Phospholipid Research Center (Heidelberg, Germany).

4 Summary

In this work, phospholipids (PL) were evaluated as functional excipients for oral delivery of solid dosage forms. The processability of lecithins with different phospholipid fractions into solid dosage forms and the performance of hydrogenated phosphatidylcholine as matrix forming excipient were studied.

Different manufacturing methods to obtain free-flowing powders of unsaturated and saturated phospholipids were evaluated as well as physical and rheological characteristics influencing the tableability of the powders were studied.

The study of the physical characteristics of the phospholipids revealed that at room conditions (25°C, RH 40%) unsaturated phospholipids were in amorphous or partially crystalline state. Moisture sorption profiles suggested that saturated phospholipids could be considered as slightly hygroscopic substances (less than 20% moisture content after storing at RH over 90%). On the other hand, unsaturated phospholipids were classified as moderately hygroscopic substances (less than 40% moisture content after storing at RH over 80%). Moreover, small amounts of absorbed moisture (3-5%) irreversibly converted phospholipid aggregates into a semisolid mass, which was inadequate for further powder processing. Special packaging and storing conditions (refrigeration, desiccator chambers and aluminum sacs) were needed for these materials.

Direct compression could be performed on saturated phospholipids, which were delivered as fine powders, had adequate flow properties and could be processed into tablets with sufficient crushing strength (1.5 -2 MPa) at more than 50% phospholipid content with or without addition of other tableting excipients. To process unsaturated phospholipids into a powder, wet granulation with ethanol was found to be a feasible process. Granules with up to 30% phospholipid contents were obtained by this method, and further could be compressed into tablets with up to 15% loadings. The main limitations were

the softness of the resulting tablets and the tendency for punch-sticking during the compression. To maximize the content of unsaturated phospholipids in the resulting powder (i.e. in the final dosage form), the adsorption of phospholipid ethanolic solution onto porous carriers was performed. Silicified microcrystalline cellulose (Prosolv[®]) and highly porous materials (Aeroperl[®] and Neusilin[®]) were used as carriers. Free flowing powders (i.e. granules) were obtained with up to 60% unsaturated phospholipids. Corresponding tablets with up to 50-60% phospholipid content and reasonable hardness could be manufactured with or without additional tableting excipients. Moreover, Aeroperl-based S 45 powder had a lower equilibrium moisture content than corresponding unformulated S 45 (2.0 vs. 4.8%, respectively), which converted into semi-solid mass after 3 months storing at room RH in closed bottles, indicating a lower sensitivity for environmental humidity.

Further, saturated phosphatidylcholine (PHOSPHOLIPON[®] 90 H) was evaluated as matrix forming excipient for extended drug release. A number of formulation factors which affect the drug diffusivity (e.g. drug loading, matrix former particle size, tablet porosity, etc.), and hence the drug release rate, were studied. Direct compression of binary blends of model drugs (diprophylline, caffeine and theophylline) and phospholipid was used in order to establish clear cause-effect relationships and to evaluate the general applicability of this excipient as release retarding matrix-former.

The compactability of saturated phosphatidylcholine was first evaluated. Compacts of the pure excipient were characterized by a relatively low tensile strength (0.9-1 MPa) and a low friability (0.1%). The tensile strength was independent of the compaction pressure above 40 MPa, which was associated with achieving close to 0% air porosity of the compact. Similar results were observed for drug:phospholipid blends at different drug loadings. The tablets tensile strength was independent of the drug loading in the range of 10 to 50%, but overall was higher for drug-containing tablets compared to pure phospholipid tablets.

Furthermore, extended drug release was achieved with drugs of different solubility and at various drug loadings. For example, the caffeine release time (t_{80}) from 8 mm tablets ranged from 1.5 h to 18 h at 70% and 10% drug loading, respectively. The drug release was governed by diffusion and could therefore be modelled by Fick's law of diffusion. Drug release profiles were thus a function of drug solubility, drug loading, and tablet

dimensions. Matrix tablets of caffeine (20% drug loading) showed robust dissolution with regard to agitation (50-100 rpm) and ionic strength of the release media (100-600 mOsmol/kg). However, strong pH-dependent behavior of phosphatidylcholine matrix was observed. Caffeine release was about 3-times faster at acidic pH compared to phosphate buffer.

To understand the pH-dependent behavior, the mechanism of saturated phosphatidylcholine matrix hydration was studied. Furthermore, methods to resolve or minimize this effect were evaluated, implying suitable powder modifications and adjustments of matrix formulation parameters. Differences in phosphatidylcholine matrix hydration kinetics at different pH were attributed to the ionization status of the functional groups, i.e. phosphate (pKa 3) and quaternary ammonium. At pH over 3, the molecule is present as a zwitterion, while in acidic medium (pH lower than 3) the phosphate group remains protonated, and phosphatidylcholine has only the positive charge of the quaternary ammonium group. It has been suggested that in acidic medium the uncompensated positive charge of the quaternary ammonium group strongly attracted counterions from the medium, favoring matrix hydration and consequently drug release, which was further supported by experimental data. Further, it was established that buffer anion species also had an effect on the extent of matrix hydration, following the order of ion hydration volume i.e. chloride < phosphate < acetate. The *in vitro* drug release from phosphatidylcholine matrix would thus also be buffer dependent.

The complexation of phosphatidylcholine with chloride ions was intended to reduce the matrix hydration rate. The results were promising: at 60% drug loadings, formulations with treated phosphatidylcholine powder resulted in pH-independent drug release for 2 hours. Additionally, numerous formulation parameters were evaluated on the extent of pH-dependent behavior, e.g. addition of competing anionic species (SDS), basifying agents (magnesium hydroxide), insoluble and enteric polymers (EC, HPMCP, shellac) combined with different matrix preparation methods. Although none of the proposed methods alone resulted in an ultimate solution (e.g. formulations with low drug loadings, compromised powder properties, flow and compactability), some approaches had promising results, which could lead to suitable *in vivo* performance. Moreover, once the matrix hydration mechanism was explored, engineering of phospholipid excipients with

required properties was feasible. Thus, phosphatidic acid calcium salt was explored as a matrix forming excipient, resulting in pH-independent drug release with retardation capacity higher than phosphatidylcholine matrix: t_{80} 5 vs. 3 hours for 60% caffeine loading from PA-Ca and PC 8 mm tablets, respectively.

Finally, the feasibility of processing hydrogenated phosphatidylcholine by hot melt extrusion was evaluated, as well as the release rate controlling potential of resulting matrices with attention to high loadings of water-soluble model drugs.

The liquid crystalline nature of phosphatidylcholine allowed its extrusion at the temperature of 120°C, which was below its capillary melting point (235°C). Model drugs with a wide range of water solubility (8, 20 and 240 mg/ml) and high melting temperatures (over 150°C) were used. Extrudates with up to 70% drug loadings were prepared at temperatures below their melting points, hence the drugs' solid state remained unchanged throughout the process, as confirmed by XRD and hot stage microscopy. The times to achieve 80% drug release (t_{80}) from extrudates with 50% drug loadings were 3, 8 and 18 h for diprophylline, caffeine and theophylline, respectively. This confirmed the matrix capacity to extend the release of water-soluble drugs at high drug loadings. Furthermore, the influence of the matrix preparation method (extrusion vs. compression) on drug release from identically composed phosphatidylcholine matrices was evaluated. Since diffusion was recognised as the main mechanism of drug release, the drug apparent diffusion coefficients were used to compare the performances of different size matrices. Interestingly, non-eroding compressed matrices (drug loadings up to 30%) had very similar release-controlling potential as the extruded matrices. However, at higher drug loadings, compressed matrices eroded significantly, resulting in accelerated drug release. In contrast, extruded phosphatidylcholine matrices had no signs of erosion at any drug loadings (up to 70%) and solubility. The drugs apparent diffusion coefficient values were 2 to 11 times lower for the extrudates, reflecting their higher retardation capacity. The mechanical robustness of the extrudates was attributed to the formed skin-core structure (confirmed by SEM) and was identified as the main reason for the major release controlling potential of extruded matrices compared to compressed ones.

5 Zusammenfassung

In dieser Arbeit wurden Phospholipide als funktionelle Hilfsstoffe für die orale Gabe von festen Arzneiformen bewertet. Die Verarbeitbarkeit von Lecithinen mit verschiedenen Phospholipidfraktionen in festen Arzneiformen und das Verhalten von hydriertem Phosphatidylcholin als Matrixbildner wurde untersucht.

Verschiedene Herstellungsmethoden wurden bewertet, um frei fließende Pulver von ungesättigten und gesättigten Phospholipiden zu erhalten, und physikalische und rheologische Charakteristika untersucht, die die Tablettierbarkeit der Pulver beeinflussen.

Die Untersuchung der physikalischen Charakteristika der Phospholipide zeigte, dass ungesättigte Phospholipide bei Raumtemperatur (25°C, 40% RH) in amorphem oder teilkristallines Zustand vorliegen. Feuchtigkeitsabsorptionsprofile lassen vermuten, dass gesättigte Phospholipide als leicht hygroskopische Substanzen angesehen werden können (weniger als 20% Wassergehalt nach Lagerung bei relativer Feuchtigkeit über 90%). Auf der anderen Seite wurden ungesättigte Phospholipide als moderat hygroskopische Substanzen klassifiziert (weniger als 40% Wassergehalt nach Lagerung bei relativer Feuchtigkeit über 80%). Zudem wandelten geringe absorbierte Wassermengen (3-5%) Phospholipidaggregate irreversibel in eine halbfeste Masse um, die zur weiteren Pulververarbeitung ungeeignet war. Spezielle Verpackung und Lagerungsbedingungen (Kühlung, Desiccator und Aluminiumbeutel) waren daher für diese Materialien nötig.

Eine Direktverpressung konnte mit gesättigten Phospholipiden durchgeführt werden, die als feine Pulver verfügbar sind, adäquate Fließeigenschaften besitzen und in Tabletten mit ausreichender Bruchfestigkeit (1.5–2 MPa) mit mehr als 50% Beladung mit oder ohne Zusatz von anderen Tablettierhilfsstoffen verarbeitet werden können. Um ungesättigte Phospholipide in Pulver zu verarbeiten, wurde die Feuchtgranulation mit Ethanol als machbarer Prozess identifiziert. Mit dieser Methode wurden Granulate mit bis zu

30% Phospholipidgehalt erhalten, und konnten folglich in Tabletten mit bis zu 15% Beladung verpresst werden. Die hauptsächlichsten Einschränkungen waren die Weichheit der resultierenden Tabletten und die Tendenz, während des Verpressvorgangs am Tablettierstempel zu kleben. Um den Gehalt der ungesättigten Phospholipide im resultierenden Pulver und damit in der finalen Arzneiform zu maximieren, wurde eine Adsorption von ethanolischer Phospholipidlösung an porösen Trägern durchgeführt. Silifizierte mikrokristalline Zellulose (Prosolv[®]) und hochporöse Materialien (Aeroperl[®] und Neusilin[®]) wurden als Träger verwendet. Frei-fließende Pulver (Granulate) mit bis zu 60% ungesättigten Phospholipiden wurden erhalten. Entsprechende Tabletten mit bis zu 50-60% Phospholipidgehalt und angemessener Bruchfestigkeit konnten mit oder ohne zusätzliche Tablettierhilfsstoffe hergestellt werden. Zudem hatte auf Aeroperl-basierendes S45-Pulver einen niedrigeren Gleichgewichtswassergehalt als das korrespondierende, unformulierte S45 (2.0% statt 4.8%), welches nach Lagerung bei Raumbedingungen in geschlossenen Flaschen nach drei Monaten in eine halb feste Masse umgewandelt wurde, was eine niedrigere Empfindlichkeit gegenüber umweltbedingter Feuchte zeigt.

Weiterhin wurde gesättigtes Phosphatidylcholin (Phospholipon[®] 90 H) als Matrixbildner für Formulierungen mit verzögerter Wirkstofffreisetzung untersucht. Eine Anzahl von Formulierungsfaktoren, die die Arzneistoffdiffusionsfähigkeit (z. B. Arzneistoffbeladung, Partikelgröße des Matrixbildners, Porosität der Tabletten, usw.) und damit die Arzneistofffreisetzungsraten beeinflussen, wurden untersucht. Direktverpressung von binären Mischungen von Modellsubstanzen (Diprophyllin, Coffein und Theophyllin) und Phospholipiden wurden verwendet, um klare Ursache-Effekt-Zusammenhänge herzustellen und die generelle Anwendbarkeit dieses Hilfsstoffes als retardierender Matrixbildner zu untersuchen.

Die Verpressbarkeit von gesättigtem Phosphatidylcholin wurde zunächst untersucht. Presslinge bestehend aus reinem Hilfsstoff wiesen eine relative niedrige Zugfestigkeit (0.9-1.0 MPa) und einen niedrigen Abrieb auf. Die Zugfestigkeit war unabhängig vom Verdichtungsdruck über 40 MPa, was mit dem Erreichen von nahezu 0% Luftporosität erklärt werden kann. Gleiche Ergebnisse wurden bei Arzneistoff-Phospholipid-Mischungen erzielt, auch bei verschiedenen Arzneistoff-Beladungen. Die Zugfestigkeit der Tabletten

war von der Arzneistoffbeladung zwischen 10 und 50% unabhängig, war bei arzneistoffbeladenen Tabletten aber insgesamt höher als bei reinen Phospholipidtabletten. Zudem wurde eine verlängerte Arzneistofffreisetzung mit Arzneistoffen unterschiedlicher Löslichkeit und bei unterschiedlichen Arzneistoffbeladungen erreicht. Beispielsweise variierte die Freisetzungszeit von Coffein (t_{80}) bei 8 mm-Tabletten zwischen 1.5 und 18 Stunden bei 70% und 10% Arzneistoffbeladung. Die Arzneistofffreisetzung wurde durch Diffusion bestimmt und konnte daher mit dem Fick'schen Diffusionsgesetz modelliert werden. Arzneistofffreisetzungprofile waren daher ein Resultat aus Arzneistofflöslichkeit, Arzneistoffbeladung und Tablettengeometrie. Matrixtabletten mit Coffein (20% Arzneistoffbeladung) zeigten robuste Freisetzung in Hinsicht auf Rühren (50-100 rpm) und Ionenstärke des Freisetzungsmediums (100-600 mOsmol/kg). Trotzdem wurde ein stark pH-abhängiges Verhalten der Phosphatidylcholinmatrix beobachtet. Die Coffein-Freisetzung war in saurem pH ungefähr dreimal schneller als in Phosphatpuffer.

Um die pH-Abhängigkeit zu verstehen, wurde der Mechanismus der Hydratation der Phosphatidylcholinmatrix untersucht. Weiterhin wurden Methoden entwickelt, um diese Effekte zu lösen oder zu minimieren, welche passende Pulvermodifikationen und Anpassungen der Formulierung der Matrix implizieren. Unterschiede in den Kinetiken der Hydratation der Phosphatidylcholinmatrix bei verschiedenen pH-Werten konnten dem Ionisierungsstatus der funktionellen Gruppen zugeordnet werden, genauer dem Phosphat (pK_a 3) und dem quartären Ammonium. Bei pH-Werten über 3 liegt das Molekül als Zwitterion vor, während in sauren Medien (pH niedriger als 3) die Phosphatgruppe protoniert bleibt, und Phosphatidylcholin nur die positive Ladung vom quartären Ammonium aufweist. Es wurde angenommen, dass in sauren Medien die unkompenzierte positive Ladung der quartären Ammonium-Funktion Gegenionen aus dem Medium anzieht, was die Matrizenhydratation fördert und so auch die Arzneistofffreisetzung, was durch weitere experimentelle Daten unterstützt wurde. Weiterhin wurde festgestellt, dass die Pufferanionen-Art entsprechend der Reihenfolge des Ionenhydratationsvolumens (Chlorid < Phosphat < Acetat) ebenfalls einen Einfluss auf das Ausmaß der Matrixhydratation hatte. Die *in vitro* Freisetzung aus einer Phosphatidylcholinmatrix wäre dementsprechend ebenfalls Puffer-abhängig.

Die Komplexierung von Phosphatidylcholin mit Chloridionen sollte die Matrixhydratationsrate reduzieren. Die Ergebnisse waren vielversprechend: bei einer Arzneistoffbeladung von 60% konnte mit behandeltem Phosphatidylcholinpulver eine pH-unabhängige Arzneistofffreisetzung über einen Zeitraum von zwei Stunden erreicht werden. Zusätzlich wurde der Einfluss zahlreicher Formulierungsparameter auf das pH-abhängige Verhalten untersucht, wie beispielsweise der Zusatz von konkurrierenden anionischen Zusätzen (SDS), basifizierenden Mitteln (Magnesiumhydroxid), unlöslichen und magensaftresistenten Polymeren (EC, HPMCP, Schellack) in Kombination mit verschiedenen Matrixherstellmethoden. Obwohl keine dieser Methoden allein zu einer Lösung geführt hat (z. B. Formulierungen mit niedriger Arzneistoffbeladung, Kompromisse in den Pulver- und Fließeigenschaften sowie in der Verpressbarkeit), hatten manche Ansätze vielversprechende Ergebnisse, welche zu einem angemessenen *in vivo*-Verhalten führen könnten. Zudem war die Herstellung von Phospholipidhilfsstoffen mit entsprechend benötigten Eigenschaften möglich, nachdem der Matrixhydratationsmechanismus untersucht war. Dadurch konnte das Phosphatidsäure-Calciumsalz als Matrixbildner untersucht werden, welches in einer pH-unabhängigen Arzneistofffreisetzung mit einer höheren Retardationskapazität als bei einer Phosphatidylcholin-Matrix resultierte: PA-Ca- bzw. PC-Tabletten (8 mm) resultierten in t_{80} -Werten von 5 bzw. 3 Stunden für eine Coffeinbeladung von 60%.

Zum Schluss wurde die Machbarkeit der Verarbeitung von hydriertem Phosphatidylcholin mit Hot-Melt-Extrusion untersucht, zusammen mit dem Potential der resultierenden Matrix, die Freisetzungsraten in Hinblick auf hohe Arzneistoffbeladungen mit wasserlöslichen Modellsubstanzen zu kontrollieren.

Der flüssig-kristalline Zustand von Phosphatidylcholin erlaubte die Extrusion bei einer Temperatur von 120°C, die niedriger war als der Kapillar-Schmelzpunkt (235°C). Modellsubstanzen mit einem breiten Bereich von Löslichkeiten (8, 20 und 240 mg/ml) und hohen Schmelzpunkten (über 150°C) wurden verwendet. Extrudate mit bis zu 70% Arzneistoffbeladung wurden bei Temperaturen unterhalb ihrer Schmelzpunkte hergestellt, sodass der Festzustand der Arzneistoffe während des Prozesses unverändert blieb, was durch XRD und Hot-Stage-Mikroskopie bestätigt wurde. Die jeweiligen Zeiten, um 80% Arzneistofffreisetzung aus Extrudaten mit 50% Arzneistoffbeladung zu erreichen (t_{80}),

waren 3, 8 und 18 Stunden für Diprophyllin, Coffein und Theophyllin. Dies bestätigte die Kapazität der Matrix, die Freisetzung von wasserlöslichen Arzneistoffen bei hohen Arzneistoffbeladungen zu verzögern. Zudem wurde der Einfluss der Matrixherstellungsmethode (Extrusion, Verpressung) auf die Arzneistofffreisetzung bei identisch zusammengesetzten Phosphatidylcholinmatrizen untersucht. Da die Diffusion als Hauptmechanismus der Freisetzung angesehen wurde, wurden die scheinbaren Diffusionskoeffizienten der Arzneistoffe verwendet, um das Verhalten der verschiedenen Matrizengrößen zu vergleichen. Interessanterweise hatten nicht-erodierende verpresste Matrizen (Arzneistoffbeladungen von bis zu 30%) ein sehr ähnliches freisetzungskontrollierendes Potential wie die extrudierten Matrizen. Trotzdem erodierten verpresste Matrizen bei höheren Arzneistoffbeladungen signifikant, was in einer beschleunigten Freisetzung resultierte. Im Gegensatz dazu zeigten extrudierte Phosphatidylcholinmatrizen keine Anzeichen von Erosion bei allen Arzneistoffbeladungen (bis zu 70%) und Löslichkeiten. Die scheinbaren Diffusionskoeffizienten der Arzneistoffe waren 2 bis 11-mal niedriger als die der Extrudate, was deren Retardationskapazität widerspiegelt. Die mechanische Robustheit der Extrudate wurde der Kern-Mantelstruktur (bestätigt durch SEM) zugeordnet und als Hauptursache für das überlegene freisetzungskontrollierende Potential der extrudierten Matrizen im Vergleich zu dem der verpressten Matrizen identifiziert.

6 References

- Anand, B S et al. (1999). "Phospholipid association reduces the gastric mucosal toxicity of aspirin in human subjects." In: *The American journal of gastroenterology* 94.7, pp. 1818–22. ISSN: 0002-9270. DOI: [10.1111/j.1572-0241.1999.01211.x](https://doi.org/10.1111/j.1572-0241.1999.01211.x).
- Baer, Erich (1965). "From the trioses to the synthesis of natural phospholipids: A research trail of forty years". In: *Journal of the American Oil Chemists' Society* 42.4, pp. 257–266. ISSN: 0003021X. DOI: [10.1007/BF02540126](https://doi.org/10.1007/BF02540126).
- Banker, G. S. and C. T. Rhodes (1990). *Modern Pharmaceutics*. 2nd edition. Taylor & Francis Inc.
- Barra, Jérôme, Françoise Falson-Rieg, and Eric Doelker (2000). "Modified drug release from inert matrix tablets prepared from formulations of identical composition but different organisations". In: *Journal of Controlled Release* 65.3, pp. 419–428. ISSN: 01683659. DOI: [10.1016/S0168-3659\(99\)00220-5](https://doi.org/10.1016/S0168-3659(99)00220-5).
- Bensikaddour, Hayet et al. (2008). "Interactions of ciprofloxacin with DPPC and DPPG: Fluorescence anisotropy, ATR-FTIR and ³¹P NMR spectroscopies and conformational analysis". In: *Biochimica et Biophysica Acta (BBA) - Biomembranes* 1778.11, pp. 2535–2543. ISSN: 0005-2736. DOI: [10.1016/J.BBAMEM.2008.08.015](https://doi.org/10.1016/J.BBAMEM.2008.08.015).
- Bodmeier, Roland and Ornlaksana Paeratakul (1994). "Mechanical Properties of Dry and Wet Cellulosic and Acrylic Films Prepared from Aqueous Colloidal Polymer Dispersions Used in the Coating of Solid Dosage Forms". In: *Pharmaceutical Research* 11.6, pp. 882–888. ISSN: 07248741. DOI: [10.1023/A:1018942127524](https://doi.org/10.1023/A:1018942127524).
- Bodmeier, Roland et al. (1996). "The Influence of Buffer Species and Strength on Diltiazem HC1 Release from Beads Coated with the Aqueous Cationic Polymer Dispersions,

- Eudragit RS, RL 30D". In: *Pharmaceutical Research* 13.1, pp. 52–56. ISSN: 07248741. DOI: [10.1023/A:1016021115481](https://doi.org/10.1023/A:1016021115481).
- Boggs, J M (1987). "Lipid intermolecular hydrogen bonding: influence on structural organization and membrane function." In: *Biochimica et biophysica acta* 906.3, pp. 353–404. ISSN: 0006-3002.
- Bonnaire, Lucile et al. (2008). "Influence of Lipid Physical State on the in Vitro Digestibility of Emulsified Lipids". In: *Journal of Agricultural and Food Chemistry* 56.10, pp. 3791–3797. ISSN: 0021-8561. DOI: [10.1021/jf800159e](https://doi.org/10.1021/jf800159e).
- Boza, A. et al. (1999). "Evaluation of Eudragit® RS-PO and Ethocel® 100 Matrices for the Controlled Release of Lobenzarit Disodium". In: *Drug Development and Industrial Pharmacy* 25.2, pp. 229–233. ISSN: 0363-9045. DOI: [10.1081/DDC-100102164](https://doi.org/10.1081/DDC-100102164).
- Bravo-Osuna, I, C Ferrero, and M R Jiménez-Castellanos (2006). "Influence of moisture content on the mechanical properties of methyl methacrylate–starch copolymers". In: DOI: [10.1016/j.ejpb.2006.08.003](https://doi.org/10.1016/j.ejpb.2006.08.003).
- Bremmell, Kristen E. et al. (2013). "Tableting Lipid-Based Formulations for Oral Drug Delivery: A Case Study with Silica Nanoparticle–Lipid–Mannitol Hybrid Microparticles". In: *Journal of Pharmaceutical Sciences* 102.2, pp. 684–693. ISSN: 00223549. DOI: [10.1002/jps.23406](https://doi.org/10.1002/jps.23406).
- Byrne, P. and D. Chapman (1964). "Liquid Crystalline Nature of Phospholipids". In: *Nature* 202.4936, pp. 987–988. ISSN: 0028-0836. DOI: [10.1038/202987a0](https://doi.org/10.1038/202987a0).
- Callahan, J. C. et al. (1982). "Equilibrium Moisture Content of Pharmaceutical Excipients". In: *Drug Development and Industrial Pharmacy* 8.3, pp. 355–369. ISSN: 0363-9045. DOI: [10.3109/03639048209022105](https://doi.org/10.3109/03639048209022105).
- Caraballo, Isidore, Mónica Millan, and Antonio María Rabasco (1996). "Relationship Between Drug Percolation Threshold and Particle Size in Matrix Tablets". In: *Pharmaceutical Research* 13.3, pp. 387–390. ISSN: 07248741. DOI: [10.1023/A:1016088424993](https://doi.org/10.1023/A:1016088424993).

- Carlson, R. P. et al. (1998). "Sirolimus (rapamycin, Rapamune®) and combination therapy with cyclosporin A in the rat developing adjuvant arthritis model: Correlation with blood levels and the effects of different oral formulations". In: *Inflammation Research* 47.8, pp. 339–344. ISSN: 1023-3830. DOI: [10.1007/s000110050339](https://doi.org/10.1007/s000110050339).
- Cevc, Gregor (1993). *Phospholipids Handbook*. Marcel Dekker, INC. New York. ISBN: 0-8247-9050-2.
- Chakraborty, Subhashis et al. (2009). "Lipid—an emerging platform for oral delivery of drugs with poor bioavailability." In: *European journal of pharmaceuticals and biopharmaceutics : official journal of Arbeitsgemeinschaft für Pharmazeutische Verfahrenstechnik e.V* 73.1, pp. 1–15. ISSN: 1873-3441. DOI: [10.1016/j.ejpb.2009.06.001](https://doi.org/10.1016/j.ejpb.2009.06.001).
- Chapman, D., R.M. Williams, and B.D. Ladbrooke (1967). "Physical studies of phospholipids. VI. Thermotropic and lyotropic mesomorphism of some 1,2-diacyl-phosphatidylcholines (lecithins)". In: *Chemistry and Physics of Lipids* 1.5, pp. 445–475. ISSN: 00093084. DOI: [10.1016/0009-3084\(67\)90023-0](https://doi.org/10.1016/0009-3084(67)90023-0).
- Chime, S. (2013). "Formulation, in vitro and in vivo Characterisation of Diclofenac Potassium Sustained Release Tablets Based on Solidified Reverse Micellar Solution (SRMS)". In: *British Journal of Pharmaceutical Research* 3.1, pp. 90–107. ISSN: 22312919. DOI: [10.9734/BJPR/2013/1567](https://doi.org/10.9734/BJPR/2013/1567).
- Cohn, Jeffrey S et al. (2010). "Dietary phospholipids and intestinal cholesterol absorption." In: *Nutrients* 2.2, pp. 116–27. ISSN: 2072-6643. DOI: [10.3390/nu2020116](https://doi.org/10.3390/nu2020116).
- Crowley, Michael M. et al. (2004). "Physicochemical properties and mechanism of drug release from ethyl cellulose matrix tablets prepared by direct compression and hot-melt extrusion". In: *International Journal of Pharmaceutics* 269.2, pp. 509–522. ISSN: 03785173. DOI: [10.1016/j.ijpharm.2003.09.037](https://doi.org/10.1016/j.ijpharm.2003.09.037).
- Cryer, Byron et al. (2011). "Low-Dose Aspirin-Induced Ulceration Is Attenuated by Aspirin-Phosphatidylcholine: A Randomized Clinical Trial". In: *The American Journal of Gastroenterology* 106.2, pp. 272–277. ISSN: 0002-9270. DOI: [10.1038/ajg.2010.436](https://doi.org/10.1038/ajg.2010.436).

- Dashevsky, A, K Kolter, and R Bodmeier (2004). "pH-independent release of a basic drug from pellets coated with the extended release polymer dispersion Kollicoat® SR 30 D and the enteric polymer dispersion Kollicoat® MAE 30 DP". In: *European Journal of Pharmaceutics and Biopharmaceutics* 58.1, pp. 45–49. ISSN: 0939-6411. DOI: [10.1016/J.EJPB.2004.03.013](https://doi.org/10.1016/J.EJPB.2004.03.013).
- Davis, S S, J G Hardy, and J W Fara (1986). "Transit of pharmaceutical dosage forms through the small intestine." In: *Gut* 27.8, pp. 886–92. ISSN: 0017-5749. DOI: [10.1136/GUT.27.8.886](https://doi.org/10.1136/GUT.27.8.886).
- De Brabander, C. et al. (2000). "Matrix mini-tablets based on starch/microcrystalline wax mixtures". In: *International Journal of Pharmaceutics* 199.2, pp. 195–203. ISSN: 0378-5173. DOI: [10.1016/S0378-5173\(00\)00383-5](https://doi.org/10.1016/S0378-5173(00)00383-5).
- Dial, Elizabeth J et al. (2008). "Oral phosphatidylcholine preserves the gastrointestinal mucosal barrier during LPS-induced inflammation." In: *Shock (Augusta, Ga.)* 30.6, pp. 729–33. ISSN: 1540-0514. DOI: [10.1097/SHK.0b013e318173e8d4](https://doi.org/10.1097/SHK.0b013e318173e8d4).
- Doherty, Chris and Peter York (1989). "Microenvironmental pH control of drug dissolution". In: *International Journal of Pharmaceutics* 50.3, pp. 223–232. ISSN: 0378-5173. DOI: [10.1016/0378-5173\(89\)90126-9](https://doi.org/10.1016/0378-5173(89)90126-9).
- Eyjolfsson, Reynir (2014). *Design and manufacture of pharmaceutical tablets*. Elsevier Reference Monographs. ISBN: 9780128021873.
- Fahy, Eoin et al. (2005). "A comprehensive classification system for lipids." In: *Journal of lipid research* 46.5, pp. 839–61. ISSN: 0022-2275. DOI: [10.1194/jlr.E400004-JLR200](https://doi.org/10.1194/jlr.E400004-JLR200).
- Farag, Yassin and Claudia S. Leopold (2011). "Investigation of drug release from pellets coated with different shellac types". In: *Drug Development and Industrial Pharmacy* 37.2, pp. 193–200. ISSN: 0363-9045. DOI: [10.3109/03639045.2010.504210](https://doi.org/10.3109/03639045.2010.504210).
- Fatouros, Dimitrios G, Bjorn Bergenstahl, and Anette Mullertz (2007). "Morphological observations on a lipid-based drug delivery system during in vitro digestion." In: *European journal of pharmaceutical sciences : official journal of the European Federation for*

- Pharmaceutical Sciences* 31.2, pp. 85–94. ISSN: 0928-0987. DOI: [10.1016/j.ejps.2007.02.009](https://doi.org/10.1016/j.ejps.2007.02.009).
- Feng, Xin and Feng Zhang (2017). “Twin-screw extrusion of sustained-release oral dosage forms and medical implants”. In: *Drug Delivery and Translational Research*. ISSN: 2190-393X. DOI: [10.1007/s13346-017-0461-9](https://doi.org/10.1007/s13346-017-0461-9).
- Fini, Adamo et al. (2008). “Fast dispersible/slow releasing ibuprofen tablets.” In: *European journal of pharmaceutics and biopharmaceutics : official journal of Arbeitsgemeinschaft für Pharmazeutische Verfahrenstechnik e.V* 69.1, pp. 335–41. ISSN: 0939-6411. DOI: [10.1016/j.ejpb.2007.11.011](https://doi.org/10.1016/j.ejpb.2007.11.011).
- Follonier, Nicolas, Eric Doelker, and Ewart T. Cole (1994). “Evaluation of hot-melt extrusion as a new technique for the production of polymer-based pellets for sustained release capsules containing high loadings of freely soluble drugs”. In: *Drug Development and Industrial Pharmacy* 20.8, pp. 1323–1339. ISSN: 0363-9045. DOI: [10.3109/03639049409038373](https://doi.org/10.3109/03639049409038373).
- Fong, Sophia Yui Kau, Martin Brandl, and Annette Bauer-Brandl (2015). “Phospholipid-based solid drug formulations for oral bioavailability enhancement: A meta-analysis.” In: *European journal of pharmaceutical sciences : official journal of the European Federation for Pharmaceutical Sciences* 80, pp. 89–110. ISSN: 1879-0720. DOI: [10.1016/j.ejps.2015.08.005](https://doi.org/10.1016/j.ejps.2015.08.005).
- Fong, Sophia Yui Kau, Asiye Ibisogly, and Annette Bauer-Brandl Professor (2015). “Solubility enhancement of BCS Class II drug by solid phospholipid dispersions: spray drying versus freeze-drying.” In: *International journal of pharmaceutics*. ISSN: 1873-3476. DOI: [10.1016/j.ijpharm.2015.10.029](https://doi.org/10.1016/j.ijpharm.2015.10.029).
- Fong, Sophia Yui Kau et al. (2016). “Solid Phospholipid Dispersions for Oral Delivery of Poorly Soluble Drugs: Investigation Into Celecoxib Incorporation and Solubility-*In Vitro* Permeability Enhancement”. In: *Journal of Pharmaceutical Sciences* 105.3, pp. 1113–1123. ISSN: 00223549. DOI: [10.1016/S0022-3549\(15\)00186-0](https://doi.org/10.1016/S0022-3549(15)00186-0).

- Fontell, Krister (1981). "Liquid Crystallinity in Lipid-Water Systems". In: *Molecular Crystals and Liquid Crystals* 63.1, pp. 59–82. ISSN: 0026-8941. DOI: [10.1080/00268948108071987](https://doi.org/10.1080/00268948108071987).
- Fookson, Jeffrey E. and Donald F.H. Wallach (1978). "Structural differences among phosphatidylcholine, phosphatidylethanolamine, and mixed phosphatidylcholine/ phosphatidylethanolamine multilayers: An infrared absorption study". In: *Archives of Biochemistry and Biophysics* 189.1, pp. 195–204. ISSN: 0003-9861. DOI: [10.1016/0003-9861\(78\)90132-7](https://doi.org/10.1016/0003-9861(78)90132-7).
- Frenning, Göran (2011). "Modelling drug release from inert matrix systems: From moving-boundary to continuous-field descriptions". In: *International Journal of Pharmaceutics* 418.1, pp. 88–99. ISSN: 03785173. DOI: [10.1016/j.ijpharm.2010.11.030](https://doi.org/10.1016/j.ijpharm.2010.11.030).
- Fricker, Gert et al. (2010). "Phospholipids and lipid-based formulations in oral drug delivery." In: *Pharmaceutical research* 27.8, pp. 1469–86. ISSN: 1573-904X. DOI: [10.1007/s11095-010-0130-x](https://doi.org/10.1007/s11095-010-0130-x).
- Fringeli, U P (1981). "A new crystalline phase of L-alpha-dipalmitoyl phosphatidylcholine monohydrate." In: *Biophysical journal* 34.2, pp. 173–87. ISSN: 0006-3495. DOI: [10.1016/S0006-3495\(81\)84844-8](https://doi.org/10.1016/S0006-3495(81)84844-8).
- Fritz, James S (2005). "Factors affecting selectivity in ion chromatography." In: *Journal of chromatography. A* 1085.1, pp. 8–17. ISSN: 0021-9673.
- Fujii, M et al. (1998). "Influence of pH and phospholipid species on release of acetaminophen from tablets containing phospholipids." In: *Chemical & pharmaceutical bulletin* 46.2, pp. 304–8. ISSN: 0009-2363.
- Gautschi, Nicolas, Peter Van Hoogevest, and Martin Kuentz (2015). "Amorphous drug dispersions with mono- and diacyl lecithin: On molecular categorization of their feasibility and UV dissolution imaging". In: *International Journal of Pharmaceutics* 491.1, pp. 218–230. ISSN: 03785173. DOI: [10.1016/j.ijpharm.2015.06.039](https://doi.org/10.1016/j.ijpharm.2015.06.039).
- Ghalanbor, Zahra, Martin Körber, and Roland Bodmeier (2010). "Improved Lysozyme Stability and Release Properties of Poly(lactide-co-glycolide) Implants Prepared by

- Hot-Melt Extrusion". In: *Pharmaceutical Research* 27.2, pp. 371–379. ISSN: 0724-8741. DOI: [10.1007/s11095-009-0033-x](https://doi.org/10.1007/s11095-009-0033-x).
- Grit, Mustafa, Willy J.M. Underberg, and Daan J.A. Crommelin (1993). "Hydrolysis of Saturated Soybean Phosphatidylcholine in Aqueous Liposome Dispersions". In: *Journal of Pharmaceutical Sciences* 82.4, pp. 362–366. ISSN: 0022-3549. DOI: [10.1002/JPS.2600820405](https://doi.org/10.1002/JPS.2600820405).
- Grund, Julia, Martin Körber, and Roland Bodmeier (2013). "Predictability of drug release from water-insoluble polymeric matrix tablets." In: *European journal of pharmaceutics and biopharmaceutics : official journal of Arbeitsgemeinschaft fur Pharmazeutische Verfahrenstechnik e.V* 85.3 Pt A, pp. 650–5. ISSN: 1873-3441. DOI: [10.1016/j.ejpb.2013.08.007](https://doi.org/10.1016/j.ejpb.2013.08.007).
- Grund, Julia et al. (2014). "The effect of polymer properties on direct compression and drug release from water-insoluble controlled release matrix tablets". In: *International Journal of Pharmaceutics* 469.1, pp. 94–101. ISSN: 03785173. DOI: [10.1016/j.ijpharm.2014.04.033](https://doi.org/10.1016/j.ijpharm.2014.04.033).
- Gundermann, Karl-Josef et al. (2016). "Essential phospholipids in fatty liver: a scientific update." In: *Clinical and experimental gastroenterology* 9, pp. 105–17. ISSN: 1178-7023. DOI: [10.2147/CEG.S96362](https://doi.org/10.2147/CEG.S96362).
- Gunstone, F. D. (2008). *Phospholipid technology and applications*, p. 201. ISBN: 9780857097880.
- Guo, X.D., Bodmeier, R., Sarabia, R., and Skultety, P. (1993). "The effect of buffer species on hydration and mechanical properties of polymeric films prepared from aqueous colloidal cationic polymer dispersions." In: *Polymer Preprints* 34.1, pp. 633–634.
- Güres, Sinan et al. (2012). "Drug release from extruded solid lipid matrices: Theoretical predictions and independent experiments". In: *European Journal of Pharmaceutics and Biopharmaceutics* 80.1, pp. 122–129. ISSN: 0939-6411. DOI: [10.1016/J.EJPB.2011.10.002](https://doi.org/10.1016/J.EJPB.2011.10.002).
- Hancock, Bruno C. and George Zografi (1997). "Characteristics and Significance of the Amorphous State in Pharmaceutical Systems". In: *Journal of Pharmaceutical Sciences* 86.1, pp. 1–12. ISSN: 00223549. DOI: [10.1021/js9601896](https://doi.org/10.1021/js9601896).

- Harland, Ronald S. et al. (1988). "Drug/Polymer Matrix Swelling and Dissolution". In: *Pharmaceutical Research* 05.8, pp. 488–494. ISSN: 07248741. DOI: [10.1023/A:1015913207052](https://doi.org/10.1023/A:1015913207052).
- Hasa, Dritan et al. (2011). "Melt extruded helical waxy matrices as a new sustained drug delivery system". In: *European Journal of Pharmaceutics and Biopharmaceutics* 79.3, pp. 592–600. ISSN: 0939-6411. DOI: [10.1016/J.EJPB.2011.07.012](https://doi.org/10.1016/J.EJPB.2011.07.012).
- Heinicke, Grant and Joseph B. Schwartz (2007). "The Influence of Surfactants and Additives on Drug Release from a Cationic Eudragit Coated Multiparticulate Diltiazem Formulation". In: *Pharmaceutical Development and Technology* 12.4, pp. 381–389. ISSN: 1083-7450. DOI: [10.1080/10837450701369170](https://doi.org/10.1080/10837450701369170).
- Hills, B A, B D Butler, and L M Lichtenberger (1983). "Gastric mucosal barrier: hydrophobic lining to the lumen of the stomach." In: *The American journal of physiology* 244.5, G561–8. ISSN: 0002-9513. DOI: [10.1152/ajpgi.1983.244.5.G561](https://doi.org/10.1152/ajpgi.1983.244.5.G561).
- Holmberg, Krister (2003). *Surfactants and polymers in aqueous solution*. John Wiley & Sons, p. 545. ISBN: 9780471498834.
- Hoogevest, Peter van (2017). "Review – An update on the use of oral phospholipid excipients". In: *European Journal of Pharmaceutical Sciences* 108, pp. 1–12. ISSN: 09280987. DOI: [10.1016/j.ejps.2017.07.008](https://doi.org/10.1016/j.ejps.2017.07.008).
- Hoogevest, Peter van and Armin Wendel (2014). *The use of natural and synthetic phospholipids as pharmaceutical excipients*. DOI: [10.1002/ejlt.201400219](https://doi.org/10.1002/ejlt.201400219).
- Hüsch, Jan et al. (2011). "Structural properties of so-called NSAID-phospholipid-complexes." In: *European journal of pharmaceutical sciences : official journal of the European Federation for Pharmaceutical Sciences* 44.1-2, pp. 103–16. ISSN: 1879-0720. DOI: [10.1016/j.ejps.2011.06.010](https://doi.org/10.1016/j.ejps.2011.06.010).
- Ide, Yoshiaki and Zohar Ophir (1983). "Orientation development in thermotropic liquid crystal polymers". In: *Polymer Engineering and Science* 23.5, pp. 261–265. ISSN: 0032-3888. DOI: [10.1002/pen.760230505](https://doi.org/10.1002/pen.760230505).
- Jacini, Giovanni (1954). *Hydrogenation of phosphatides*.

- Jannin, V, J Musakhanian, and D Marchaud (2008). "Approaches for the development of solid and semi-solid lipid-based formulations." In: *Advanced drug delivery reviews* 60.6, pp. 734–46. ISSN: 0169-409X. DOI: [10.1016/j.addr.2007.09.006](https://doi.org/10.1016/j.addr.2007.09.006).
- Katsuragi, Y et al. (1997). "Basic studies for the practical use of bitterness inhibitors: selective inhibition of bitterness by phospholipids." In: *Pharmaceutical research* 14.6, pp. 720–4. ISSN: 0724-8741.
- Khanfar, M S et al. (1997). "Dissolution behaviour of sustained release formulations of indomethacin with Eudragit RS." In: *Acta pharmaceutica Hungarica* 67.6, pp. 235–9. ISSN: 0001-6659.
- Kleberg, Karen et al. (2010). "Biorelevant Media Simulating Fed State Intestinal Fluids: Colloid Phase Characterization and Impact on Solubilization Capacity". In: *Journal of Pharmaceutical Sciences* 99.8, pp. 3522–3532. ISSN: 0022-3549. DOI: [10.1002/JPS.22122](https://doi.org/10.1002/JPS.22122).
- Kolbina, Marina, Roland Bodmeier, and Martin Körber (2017). "Saturated phosphatidylcholine as matrix former for oral extended release dosage forms". In: *European Journal of Pharmaceutical Sciences* 108, pp. 86–92. ISSN: 09280987. DOI: [10.1016/j.ejps.2017.07.017](https://doi.org/10.1016/j.ejps.2017.07.017).
- Koynova, R and B Tenchov (2013). "Transitions between lamellar and nonlamellar phases in membrane lipids and their physiological roles". In: *OA Biochemistry*. ISSN: 2052-9651. DOI: [10.13172/2052-9651-1-1-602](https://doi.org/10.13172/2052-9651-1-1-602).
- Koynova, Rumiana and Martin Caffrey (1998). "Phases and phase transitions of the phosphatidylcholines". In: *Biochimica et Biophysica Acta (BBA) - Reviews on Biomembranes* 1376.1, pp. 91–145. ISSN: 03044157. DOI: [10.1016/S0304-4157\(98\)00006-9](https://doi.org/10.1016/S0304-4157(98)00006-9).
- (2002). "An index of lipid phase diagrams." In: *Chemistry and physics of lipids* 115.1-2, pp. 107–219. ISSN: 0009-3084.
- Kranz, H., V. Le Brun, and T. Wagner (2005). "Development of a multi particulate extended release formulation for ZK 811 752, a weakly basic drug". In: *International Journal of Pharmaceutics* 299.1-2, pp. 84–91. ISSN: 03785173. DOI: [10.1016/j.ijpharm.2005.04.026](https://doi.org/10.1016/j.ijpharm.2005.04.026).

- Kreye, F. et al. (2011a). "Drug release mechanisms of cast lipid implants". In: *European Journal of Pharmaceutics and Biopharmaceutics* 78.3, pp. 394–400. ISSN: 0939-6411. DOI: [10.1016/J.EJPB.2011.02.011](https://doi.org/10.1016/J.EJPB.2011.02.011).
- Kreye, Frauke, Florence Siepman, and Juergen Siepman (2008). "Lipid implants as drug delivery systems." In: *Expert opinion on drug delivery* 5, pp. 291–307. ISSN: 1742-5247. DOI: [10.1517/17425247.5.3.291](https://doi.org/10.1517/17425247.5.3.291).
- Kreye, Frauke et al. (2011b). "Cast Lipid Implants for Controlled Drug Delivery: Importance of the Tempering Conditions". In: *Journal of Pharmaceutical Sciences* 100.8, pp. 3471–3481. ISSN: 00223549. DOI: [10.1002/jps.22574](https://doi.org/10.1002/jps.22574).
- Kuentz, Martin and Hans Leuenberger (1999). "Pressure susceptibility of polymer tablets as a critical property: A modified Heckel equation". In: *Journal of Pharmaceutical Sciences* 88.2, pp. 174–179. ISSN: 00223549. DOI: [10.1021/js980369a](https://doi.org/10.1021/js980369a).
- Küllenberg, Daniela et al. (2012). "Health effects of dietary phospholipids". In: DOI: [10.1186/1476-511X-11-3](https://doi.org/10.1186/1476-511X-11-3).
- Ladbrooke, B.D. and D. Chapman (1969). "Thermal analysis of lipids, proteins and biological membranes a review and summary of some recent studies". In: *Chemistry and Physics of Lipids* 3.4, pp. 304–356. ISSN: 0009-3084. DOI: [10.1016/0009-3084\(69\)90040-1](https://doi.org/10.1016/0009-3084(69)90040-1).
- Langenbach, R et al. (1995). "Prostaglandin synthase 1 gene disruption in mice reduces arachidonic acid-induced inflammation and indomethacin-induced gastric ulceration." In: *Cell* 83.3, pp. 483–92. ISSN: 0092-8674.
- Lanza, F. L. et al. (2008). "Clinical trial: comparison of ibuprofen-phosphatidylcholine and ibuprofen on the gastrointestinal safety and analgesic efficacy in osteoarthritic patients". In: *Alimentary Pharmacology & Therapeutics* 28.4, pp. 431–442. ISSN: 02692813. DOI: [10.1111/j.1365-2036.2008.03765.x](https://doi.org/10.1111/j.1365-2036.2008.03765.x).

- Larsen, Anne T., Philip Sassene, and Anette Müllertz (2011). "In vitro lipolysis models as a tool for the characterization of oral lipid and surfactant based drug delivery systems". In: *International Journal of Pharmaceutics* 417.1-2, pp. 245–255. ISSN: 0378-5173. DOI: [10.1016/J.IJPHARM.2011.03.002](https://doi.org/10.1016/J.IJPHARM.2011.03.002).
- Larsson, Kare (1994). *Lipids : molecular organization, physical functions and technical applications*. Oily Press, p. 237. ISBN: 0951417142.
- Laukamp, Eva Julia et al. (2015). "Development of sustained and dual drug release co-extrusion formulations for individual dosing". In: *European Journal of Pharmaceutics and Biopharmaceutics* 89, pp. 357–364. ISSN: 0939-6411. DOI: [10.1016/J.EJPB.2014.12.027](https://doi.org/10.1016/J.EJPB.2014.12.027).
- Lecomte, F et al. (2003). "Blends of enteric and GIT-insoluble polymers used for film coating: physicochemical characterization and drug release patterns". In: *Journal of Controlled Release* 89.3, pp. 457–471. ISSN: 0168-3659. DOI: [10.1016/S0168-3659\(03\)00155-X](https://doi.org/10.1016/S0168-3659(03)00155-X).
- Letter, W. S. (1992). "A Rapid Method For Phospholipid Class Separation by HPLC using an Evaporative Light-Scattering Detector". In: *Journal of Liquid Chromatography* 15.2, pp. 253–266. ISSN: 0148-3919. DOI: [10.1080/10826079208017168](https://doi.org/10.1080/10826079208017168).
- Lichtenberger, L M et al. (1983). "Role of surface-active phospholipids in gastric cytoprotection." In: *Science (New York, N.Y.)* 219.4590, pp. 1327–9. ISSN: 0036-8075.
- Lichtenberger, Lenard M. et al. (1995). "Non-steroidal anti-inflammatory drugs (NSAIDs) associate with zwitterionic phospholipids: Insight into the mechanism and reversal of NSAID-induced gastrointestinal injury". In: *Nature Medicine* 1.2, pp. 154–158. ISSN: 1078-8956. DOI: [10.1038/nm0295-154](https://doi.org/10.1038/nm0295-154).
- Lichtenberger, Lenard M. et al. (2006). "NSAID injury to the gastrointestinal tract: evidence that NSAIDs interact with phospholipids to weaken the hydrophobic surface barrier and induce the formation of unstable pores in membranes". In: *Journal of Pharmacy and Pharmacology* 58.11, pp. 1421–1428. ISSN: 00223573. DOI: [10.1211/jpp.58.10.0001](https://doi.org/10.1211/jpp.58.10.0001).

- Ligumsky, M et al. (1983). "Aspirin can inhibit gastric mucosal cyclo-oxygenase without causing lesions in rat." In: *Gastroenterology* 84.4, pp. 756–61. ISSN: 0016-5085.
- Lindman, Bjorn (1987). "NMR Studies of Structure and Dynamics in Surfactant Systems*". In: *Zeitschrift für Physikalische Chemie* 153.Part_1_2, pp. 15–26. ISSN: 0942-9352. DOI: [10.1524/zpch.1987.153.Part_1_2.015](https://doi.org/10.1524/zpch.1987.153.Part_1_2.015).
- Liu, Jiping, Feng Zhang, and James W McGinity (2001). "Properties of lipophilic matrix tablets containing phenylpropanolamine hydrochloride prepared by hot-melt extrusion". In: *European Journal of Pharmaceutics and Biopharmaceutics* 52.2, pp. 181–190. ISSN: 0939-6411. DOI: [10.1016/S0939-6411\(01\)00162-X](https://doi.org/10.1016/S0939-6411(01)00162-X).
- Lopes, L.B. et al. (2004). "Studies on the encapsulation of diclofenac in small unilamellar liposomes of soya phosphatidylcholine". In: *Colloids and Surfaces B: Biointerfaces* 39.4, pp. 151–158. ISSN: 0927-7765. DOI: [10.1016/J.COLSURFB.2004.09.004](https://doi.org/10.1016/J.COLSURFB.2004.09.004).
- Luzzati, Vittorio, T. Gulik-Krzywicki, and A. Tardieu (1968). "Polymorphism of Lecithins". In: *Nature* 218.5146, pp. 1031–1034. ISSN: 0028-0836. DOI: [10.1038/2181031a0](https://doi.org/10.1038/2181031a0).
- Maderuelo, Cristina, Aránzazu Zarzuelo, and José M. Lanao (2011). "Critical factors in the release of drugs from sustained release hydrophilic matrices". In: *Journal of Controlled Release* 154.1, pp. 2–19. ISSN: 0168-3659. DOI: [10.1016/J.JCONREL.2011.04.002](https://doi.org/10.1016/J.JCONREL.2011.04.002).
- Marlene Lúcio et al. (2008). "Binding of Nonsteroidal Anti-inflammatory Drugs to DPPC: Structure and Thermodynamic Aspects". In: DOI: [10.1021/LA703584S](https://doi.org/10.1021/LA703584S).
- Marsh, Derek (1990). *Handbook of Lipid Bilayers*. CRC Press, p. 1145. ISBN: 9781420088328.
- Massing Ulrich, Bauer-Brandl Annette (2008). *Tablet containing hydrogenated phospholipids*.
- Monteyne, Tinne et al. (2016). "Stearic acid and high molecular weight PEO as matrix for the highly water soluble metoprolol tartrate in continuous twin-screw melt granulation". In: *International Journal of Pharmaceutics* 512.1, pp. 158–167. ISSN: 0378-5173. DOI: [10.1016/J.IJPHARM.2016.07.035](https://doi.org/10.1016/J.IJPHARM.2016.07.035).
- Moreno, Marcela Manrique et al. (2009). "The membrane-activity of Ibuprofen, Diclofenac, and Naproxen: A physico-chemical study with lecithin phospholipids". In: *Biochimica*

- et Biophysica Acta (BBA) - Biomembranes* 1788.6, pp. 1296–1303. ISSN: 0005-2736. DOI: [10.1016/J.BBAMEM.2009.01.016](https://doi.org/10.1016/J.BBAMEM.2009.01.016).
- Müllertz, Anette et al. (2010). “New perspectives on lipid and surfactant based drug delivery systems for oral delivery of poorly soluble drugs”. In: *Journal of Pharmacy and Pharmacology* 62.11, pp. 1622–1636. ISSN: 00223573. DOI: [10.1111/j.2042-7158.2010.01107.x](https://doi.org/10.1111/j.2042-7158.2010.01107.x).
- Nakamura, Tomoko et al. (2002). “The effect of various substances on the suppression of the bitterness of quinine-human gustatory sensation, binding, and taste sensor studies.” In: *Chemical & pharmaceutical bulletin* 50.12, pp. 1589–93. ISSN: 0009-2363.
- Nart, Viviane et al. (2017). “Carnauba wax as a promising excipient in melt granulation targeting the preparation of mini-tablets for sustained release of highly soluble drugs”. In: *Materials Science and Engineering: C* 70, pp. 250–257. ISSN: 0928-4931. DOI: [10.1016/J.MSEC.2016.07.070](https://doi.org/10.1016/J.MSEC.2016.07.070).
- Nishihata, Toshiaki, Yuhko Nakano, and Masuru Yamazaki (1987). “Use of hydrogenated soya phospholipids as a diluent: Preparation of sustained-release tablets of theophylline and sodium diclofenac.” In: *Chemical & Pharmaceutical Bulletin* 35.10, pp. 4271–4276. ISSN: 0009-2363. DOI: [10.1248/cpb.35.4271](https://doi.org/10.1248/cpb.35.4271).
- Panicker, Lata et al. (1995). “Interaction of Aspirin with DPPC in the Lyotropic, DPPC-Aspirin-H₂O/D₂O Membrane”. In: *Molecular Crystals and Liquid Crystals Science and Technology. Section A. Molecular Crystals and Liquid Crystals* 260.1, pp. 611–621. ISSN: 1058-725X. DOI: [10.1080/10587259508038734](https://doi.org/10.1080/10587259508038734).
- Pavia, Donald L. et al. (2009). *Introduction to spectroscopy*. Brooks/Cole, Cengage Learning, p. 15. ISBN: 0495114782.
- Porter, Christopher J H, Natalie L Trevaskis, and William N Charman (2007). “Lipids and lipid-based formulations: optimizing the oral delivery of lipophilic drugs.” In: *Nature reviews. Drug discovery* 6.3, pp. 231–48. ISSN: 1474-1776. DOI: [10.1038/nrd2197](https://doi.org/10.1038/nrd2197).

- Porter, Christopher J H et al. (2008). "Enhancing intestinal drug solubilisation using lipid-based delivery systems." In: *Advanced drug delivery reviews* 60.6, pp. 673–91. ISSN: 0169-409X. DOI: [10.1016/j.addr.2007.10.014](https://doi.org/10.1016/j.addr.2007.10.014).
- Pouton, Colin W. and Christopher J.H. Porter (2008). "Formulation of lipid-based delivery systems for oral administration: Materials, methods and strategies". In: *Advanced Drug Delivery Reviews* 60.6, pp. 625–637. ISSN: 0169409X. DOI: [10.1016/j.addr.2007.10.010](https://doi.org/10.1016/j.addr.2007.10.010).
- Raffin, Renata P et al. (2009). "Agglomerates containing pantoprazole microparticles: modulating the drug release." In: *AAPS PharmSciTech* 10.2, pp. 335–45. ISSN: 1530-9932. DOI: [10.1208/s12249-009-9214-5](https://doi.org/10.1208/s12249-009-9214-5).
- Riis, Therese et al. (2007). "pH-independent drug release of an extremely poorly soluble weakly acidic drug from multiparticulate extended release formulations". In: *European Journal of Pharmaceutics and Biopharmaceutics* 65.1, pp. 78–84. ISSN: 09396411. DOI: [10.1016/j.ejpb.2006.07.001](https://doi.org/10.1016/j.ejpb.2006.07.001).
- Roberts, Matthew et al. (2012). "Development and evaluation of sustained-release Compritol [®] 888 ATO matrix mini-tablets". In: *Drug Development and Industrial Pharmacy* 38.9, pp. 1068–1076. ISSN: 0363-9045. DOI: [10.3109/03639045.2011.638302](https://doi.org/10.3109/03639045.2011.638302).
- Roberts, Matthew et al. (2015). "Preparation and characterization of Compritol 888 ATO matrix tablets for the sustained release of diclofenac sodium". In: *Pharmaceutical Development and Technology* 20.4, pp. 507–512. ISSN: 1083-7450. DOI: [10.3109/10837450.2013.871035](https://doi.org/10.3109/10837450.2013.871035).
- Roblegg, Eva et al. (2011). "Development of sustained-release lipophilic calcium stearate pellets via hot melt extrusion". In: *European Journal of Pharmaceutics and Biopharmaceutics* 79.3, pp. 635–645. ISSN: 0939-6411. DOI: [10.1016/J.EJPB.2011.07.004](https://doi.org/10.1016/J.EJPB.2011.07.004).
- Rosiaux, Yvonne et al. (2014). "Solid lipid excipients - matrix agents for sustained drug delivery." In: *Journal of controlled release : official journal of the Controlled Release Society* 188, pp. 18–30. ISSN: 1873-4995. DOI: [10.1016/j.jconrel.2014.06.004](https://doi.org/10.1016/j.jconrel.2014.06.004).

- Sassene, Philip J. et al. (2010). "Precipitation of a Poorly Soluble Model Drug during In Vitro Lipolysis: Characterization and Dissolution of the Precipitate". In: *Journal of Pharmaceutical Sciences* 99.12, pp. 4982–4991. ISSN: 0022-3549. DOI: [10.1002/JPS.22226](https://doi.org/10.1002/JPS.22226).
- Sato, Hiroshi et al. (1997). "Dissolution Mechanism of Diclofenac Sodium from Wax Matrix Granules". In: *Journal of Pharmaceutical Sciences* 86.8, pp. 929–934. ISSN: 0022-3549. DOI: [10.1021/JS960221W](https://doi.org/10.1021/JS960221W).
- Savla, Ronak et al. (2017). "Review and analysis of FDA approved drugs using lipid-based formulations". In: *Drug Development and Industrial Pharmacy* 43.11, pp. 1743–1758. ISSN: 0363-9045. DOI: [10.1080/03639045.2017.1342654](https://doi.org/10.1080/03639045.2017.1342654).
- Schulze, Dietmar (2008). *Powders and bulk solids : behavior, characterization, storage and flow*. Springer, p. 511. ISBN: 3540737677.
- Senior, Judith and Gregory Gregoriadis (1982). "Stability of small unilamellar liposomes in serum and clearance from the circulation: The effect of the phospholipid and cholesterol components". In: *Life Sciences* 30.24, pp. 2123–2136. ISSN: 0024-3205. DOI: [10.1016/0024-3205\(82\)90455-6](https://doi.org/10.1016/0024-3205(82)90455-6).
- Shah, Vinod P. et al. (1998). "In Vitro Dissolution Profile Comparison—Statistics and Analysis of the Similarity Factor, f_2 ". In: *Pharmaceutical Research* 15.6, pp. 889–896. ISSN: 07248741. DOI: [10.1023/A:1011976615750](https://doi.org/10.1023/A:1011976615750).
- Siepmann, F. (2008). "Mathematical modeling of drug delivery". In: *International Journal of Pharmaceutics* 364.2, pp. 328–343. ISSN: 03785173. DOI: [10.1016/j.ijpharm.2008.09.004](https://doi.org/10.1016/j.ijpharm.2008.09.004).
- Siepmann, F. et al. (2006). "Controlled drug release from Gelucire-based matrix pellets: Experiment and theory". In: *International Journal of Pharmaceutics* 317.2, pp. 136–143. ISSN: 0378-5173. DOI: [10.1016/J.IJPHARM.2006.03.006](https://doi.org/10.1016/J.IJPHARM.2006.03.006).
- Simon, George P. (1991). "Ion Exchange Perspectives". In: *Ion Exchange Training Manual*. Dordrecht: Springer Netherlands, pp. 3–9. DOI: [10.1007/978-94-015-7440-2_1](https://doi.org/10.1007/978-94-015-7440-2_1).

- Small, D M (1967). "Phase equilibria and structure of dry and hydrated egg lecithin." In: *Journal of lipid research* 8.6, pp. 551–7. ISSN: 0022-2275.
- Small, Donald M. (1968). "A classification of biologic lipids based upon their interaction in aqueous systems". In: *Journal of the American Oil Chemists' Society* 45.3, p. 108. ISSN: 0003021X. DOI: [10.1007/BF02915334](https://doi.org/10.1007/BF02915334).
- Smith, Ross and Charles Tanford (1972). "The critical micelle concentration of 1- α -dipalmitoylphosphatidylcholine in water and water/methanol solutions". In: *Journal of Molecular Biology* 67.1, pp. 75–83. ISSN: 00222836. DOI: [10.1016/0022-2836\(72\)90387-7](https://doi.org/10.1016/0022-2836(72)90387-7).
- Streubel, A et al. (2000). "pH-independent release of a weakly basic drug from water-insoluble and -soluble matrix tablets". In: *Journal of Controlled Release* 67.1, pp. 101–110. ISSN: 0168-3659. DOI: [10.1016/S0168-3659\(00\)00200-5](https://doi.org/10.1016/S0168-3659(00)00200-5).
- Sun, Changquan (Calvin) (2005). "True Density of Microcrystalline Cellulose". In: *Journal of Pharmaceutical Sciences* 94.10, pp. 2132–2134. ISSN: 00223549. DOI: [10.1002/jps.20459](https://doi.org/10.1002/jps.20459).
- Takagi, S et al. (2001). "Quantification of suppression of bitterness using an electronic tongue." In: *Journal of pharmaceutical sciences* 90.12, pp. 2042–8. ISSN: 0022-3549.
- Tatulian, Suren A (1993). "Tatulian, SA (1993) Ionization and ion binding. In: Phospholipids Handbook, Marcel Dekker, New York". In: *Phospholipids Handbook*. Marcel Dekker, New York. Chap. Ionization, pp. 511–552.
- Tenchov, B. (1991). "On the reversibility of the phase transitions in lipid-water systems". In: *Chemistry and Physics of Lipids* 57.2-3, pp. 165–177. ISSN: 0009-3084. DOI: [10.1016/0009-3084\(91\)90074-L](https://doi.org/10.1016/0009-3084(91)90074-L).
- Thoma, Karl and Iris Ziegler (1998). "The pH-independent release of fenoldopam from pellets with insoluble film coats". In: *European Journal of Pharmaceutics and Biopharmaceutics* 46.1, pp. 105–113. ISSN: 0939-6411. DOI: [10.1016/S0939-6411\(97\)00164-1](https://doi.org/10.1016/S0939-6411(97)00164-1).

- Vaingankar, Pradnya and Purnima Amin (2017). "Continuous melt granulation to develop high drug loaded sustained release tablet of Metformin HCl". In: *Asian Journal of Pharmaceutical Sciences* 12.1, pp. 37–50. ISSN: 1818-0876. DOI: [10.1016/J.AJPS.2016.08.005](https://doi.org/10.1016/J.AJPS.2016.08.005).
- Vergnaud, J. M. (1993). *Controlled drug release of oral dosage forms*. E. Horwood, p. 410. ISBN: 9780131749542.
- Vithani, K. et al. (2014). "Diclofenac sodium sustained release hot melt extruded lipid matrices". In: *Pharmaceutical Development and Technology* 19.5, pp. 531–538. ISSN: 1083-7450. DOI: [10.3109/10837450.2013.805775](https://doi.org/10.3109/10837450.2013.805775).
- Wagner, Karl G and James W McGinity (2002). "Influence of chloride ion exchange on the permeability and drug release of Eudragit RS 30 D films". In: *Journal of Controlled Release* 82.2, pp. 385–397. ISSN: 01683659. DOI: [10.1016/S0168-3659\(02\)00145-1](https://doi.org/10.1016/S0168-3659(02)00145-1).
- Wallace, J L (2000). "How do NSAIDs cause ulcer disease?" In: *Bailliere's best practice & research. Clinical gastroenterology* 14.1, pp. 147–59.
- Weiss, R. A., Wansoo Huh, and L. Nicolais (1987). "Novel reinforced polymers based on blends of polystyrene and a thermotropic liquid crystalline polymer". In: *Polymer Engineering and Science* 27.9, pp. 684–691. ISSN: 0032-3888. DOI: [10.1002/pen.760270913](https://doi.org/10.1002/pen.760270913).
- Wendel, Armin (2001). "Lecithin". In: *Kirk-Othmer Encyclopedia of Chemical Technology*. Hoboken, NJ, USA: John Wiley & Sons, Inc. ISBN: 9780471238966. DOI: [10.1002/0471238961.1205030923051404.a01.pub2](https://doi.org/10.1002/0471238961.1205030923051404.a01.pub2).
- Williams, R.M. and D. Chapman (1971). "Phospholipids, liquids crystals and cell membranes". In: *Progress in the Chemistry of Fats and other Lipids* 11, pp. 1–79. ISSN: 0079-6832. DOI: [10.1016/0079-6832\(71\)90003-6](https://doi.org/10.1016/0079-6832(71)90003-6).
- Yang, Fan, Noriho Kamiya, and Masahiro Goto (2012). "Transdermal delivery of the anti-rheumatic agent methotrexate using a solid-in-oil nanocarrier." In: *European journal of pharmaceuticals and biopharmaceutics : official journal of Arbeitsgemeinschaft für Pharmazeutische Verfahrenstechnik e.V* 82.1, pp. 158–63. ISSN: 1873-3441. DOI: [10.1016/j.ejpb.2012.05.016](https://doi.org/10.1016/j.ejpb.2012.05.016).

- Yang, Libo and Reza Fassihi (1997). "Examination of drug solubility, polymer types, hydrodynamics and loading dose on drug release behavior from a triple-layer asymmetric configuration delivery system". In: *International Journal of Pharmaceutics* 155.2, pp. 219–229. ISSN: 0378-5173. DOI: [10.1016/S0378-5173\(97\)00164-6](https://doi.org/10.1016/S0378-5173(97)00164-6).
- Yeap, Yan Yan, Natalie L. Trevaskis, and Christopher J. H. Porter (2013). "Lipid Absorption Triggers Drug Supersaturation at the Intestinal Unstirred Water Layer and Promotes Drug Absorption from Mixed Micelles". In: *Pharmaceutical Research* 30.12, pp. 3045–3058. ISSN: 0724-8741. DOI: [10.1007/s11095-013-1104-6](https://doi.org/10.1007/s11095-013-1104-6).
- Yeap, Yan Yan et al. (2013). "Intestinal Bile Secretion Promotes Drug Absorption from Lipid Colloidal Phases via Induction of Supersaturation". In: *Molecular Pharmaceutics* 10.5, pp. 1874–1889. ISSN: 1543-8384. DOI: [10.1021/mp3006566](https://doi.org/10.1021/mp3006566).

7 List of Publications

Original research articles

- **Kolbina, M.**, Bodmeier, R., Körber, M., 2017. *Saturated phosphatidylcholine as matrix former for oral extended release dosage forms*. Eur. J. Pharm. Sci. 108, 86–92. doi:10.1016/j.ejps.2017.07.017
- **Kolbina, M.**, Körber, M., van Hoogevest, P., Bodmeier, R., *Evaluation of hydrogenated soybean phosphatidylcholine matrices prepared by hot melt extrusion for oral controlled delivery of freely soluble drugs*. Manuscript in preparation.

Oral presentations

- **M. Kolbina**, M. Körber, R. Bodmeier; *Preparation of tablets loaded with telmisartan-phospholipid blend as potential solubilization approach for poorly soluble drugs*. Symposium “Phospholipids in Pharmaceutical Research”, Heidelberg, Germany, September 2015
- **M. Kolbina**, M. Körber, R. Bodmeier; *Extruded phosphatidylcholine matrices for oral controlled delivery*. Researcher’s Day, organized by Phospholipid Research Centre, Mannheim, Germany, June 2018

Poster presentations

- **M. Kolbina**, M. Körber, R. Bodmeier; *Saturated phosphatidylcholine as matrix former for oral extended release dosage forms*, Symposium “Phospholipids in Pharmaceutical Research”, Heidelberg, Germany, September 2017
- **M. Kolbina**, M. Körber, R. Bodmeier; *Saturated Phosphatidylcholine as Matrix Former for Extended Oral Drug Release*, AAPS Annual Meeting 2017, San Diego, USA, # T2039, November 2017
- **M. Kolbina**, R. Bodmeier, M. Körber; *Dexamethasone extrudates based on phosphatidylcholine*. 11th PBP World Meeting 2018, Granada, Spain, # 93, March 2018