

Tafeln

Form A-1

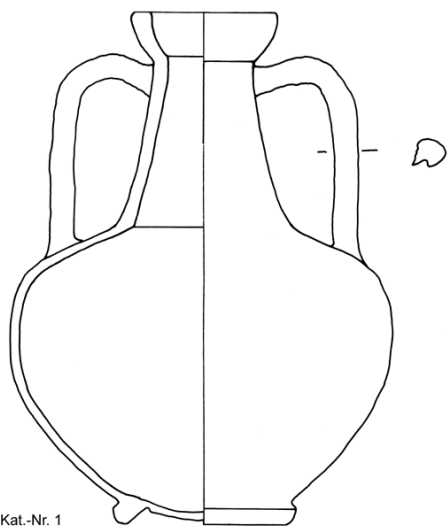

Kat.-Nr. 1

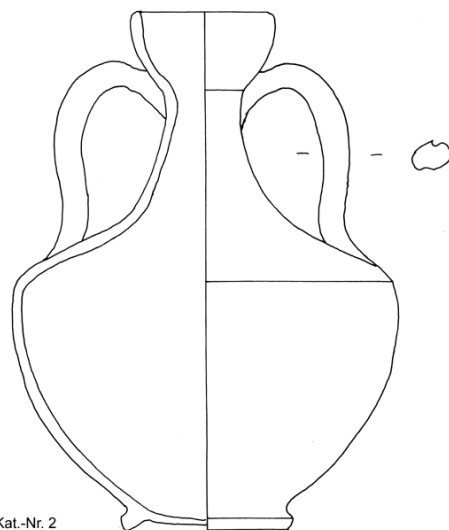

Kat.-Nr. 2

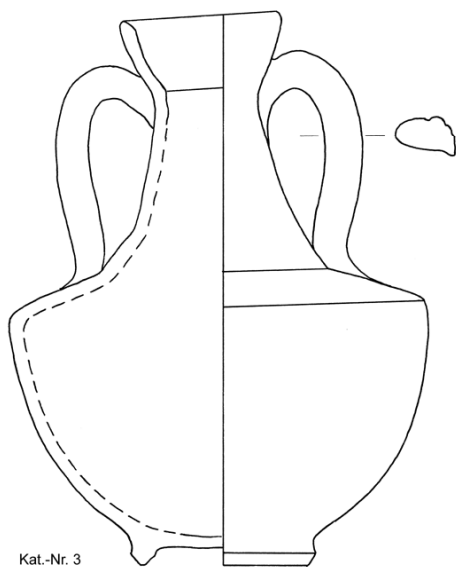

Kat.-Nr. 3

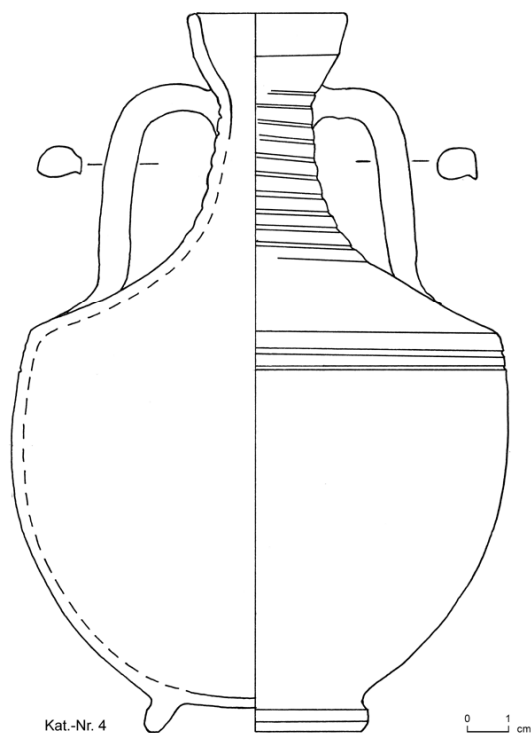

Kat.-Nr. 4

0 1 cm

Form A-2

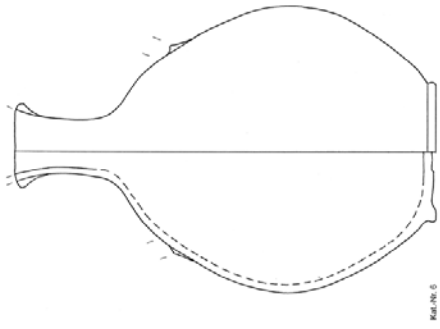
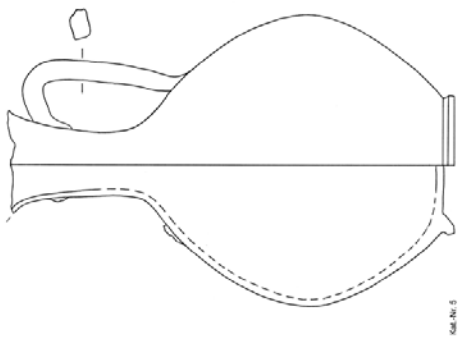

Form A-2a

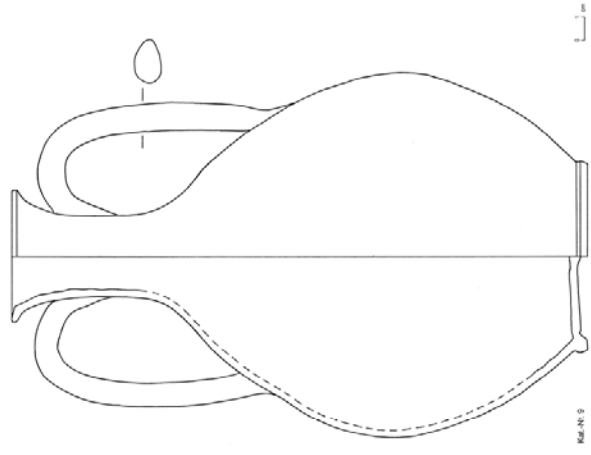
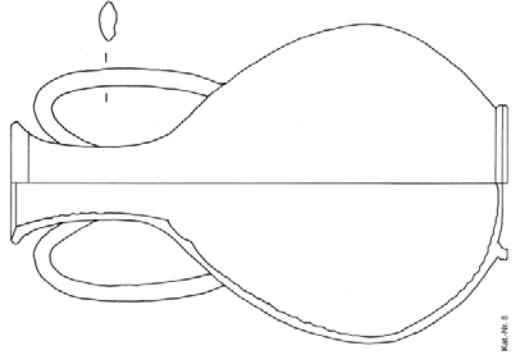
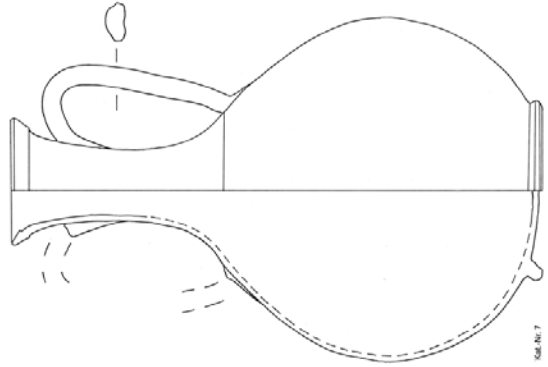

Form A-2b

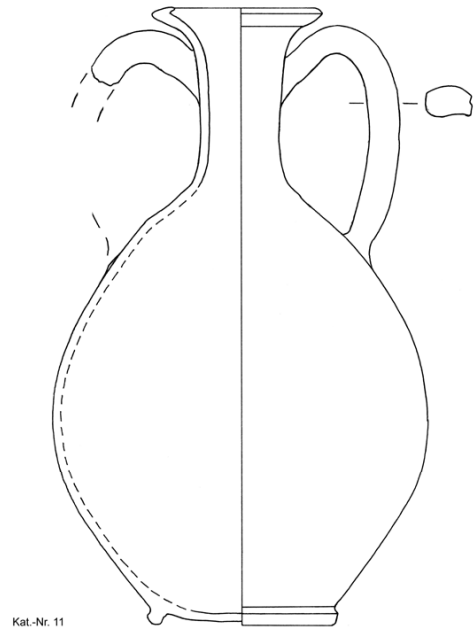
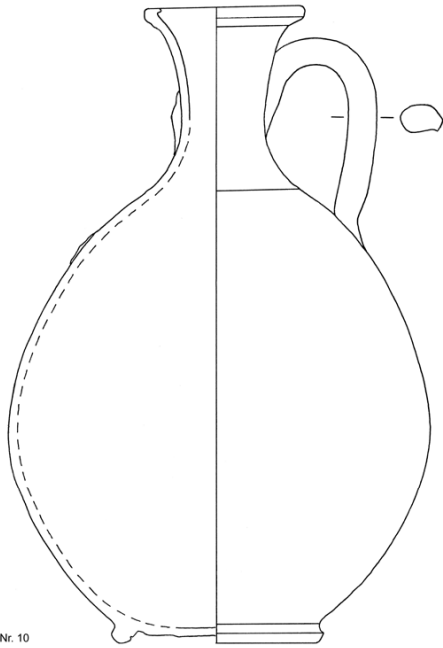

Form A-2c

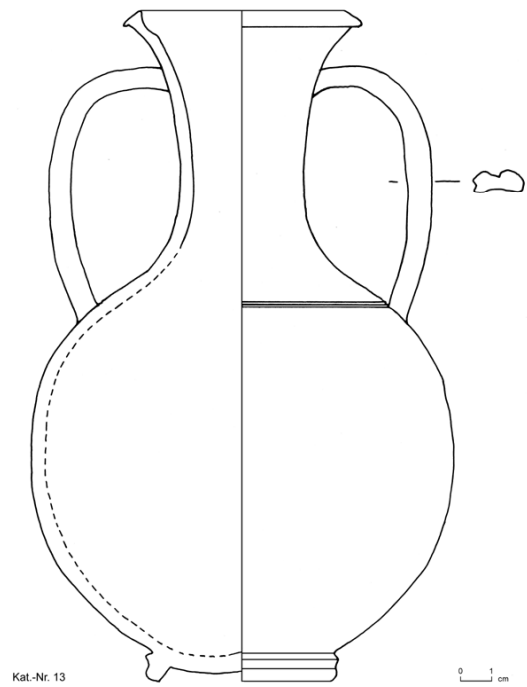
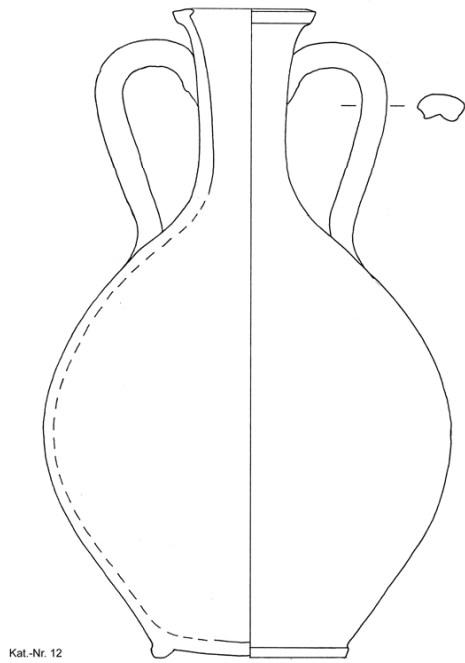

Form A-3

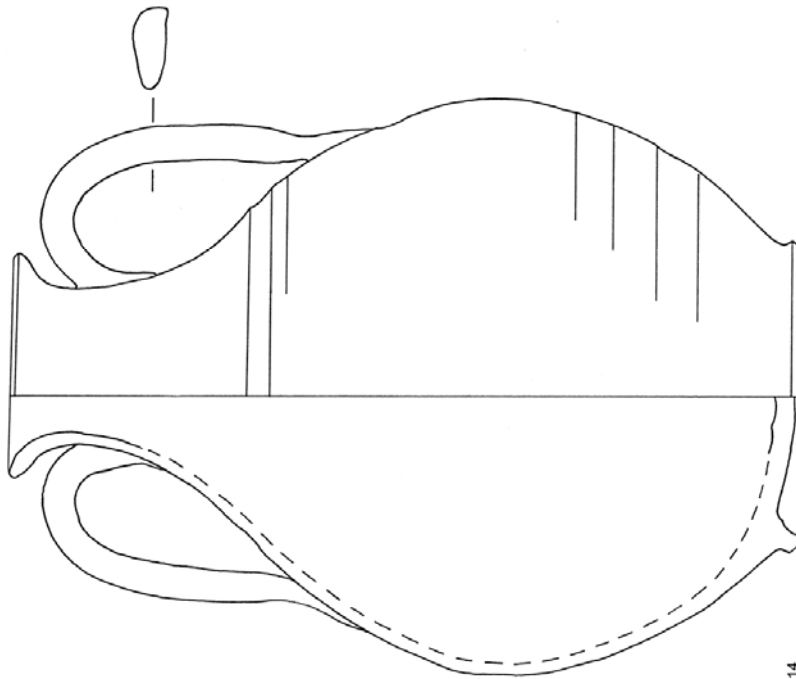

Kat.-Nr. 14

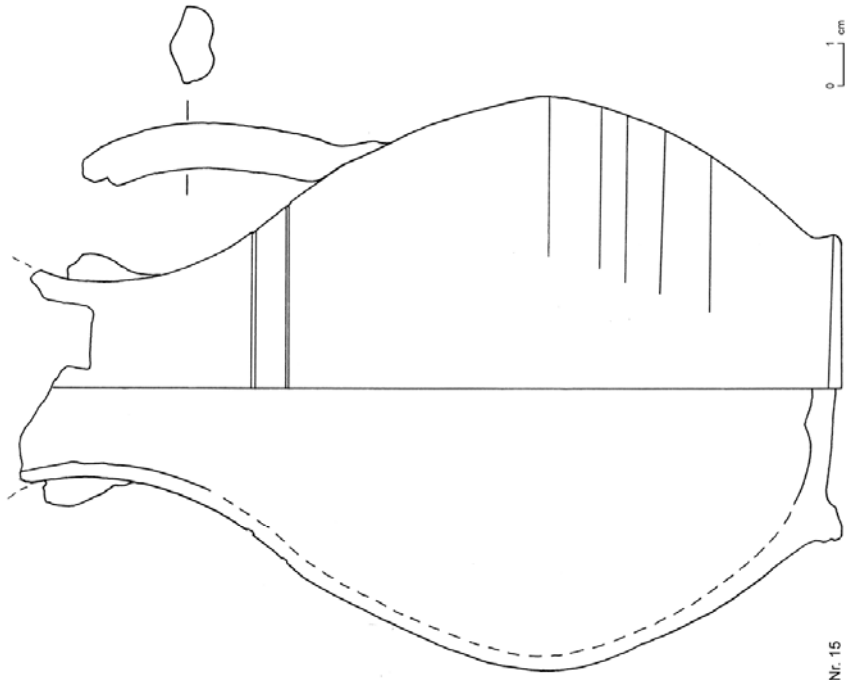

Kat.-Nr. 15

Form A-4

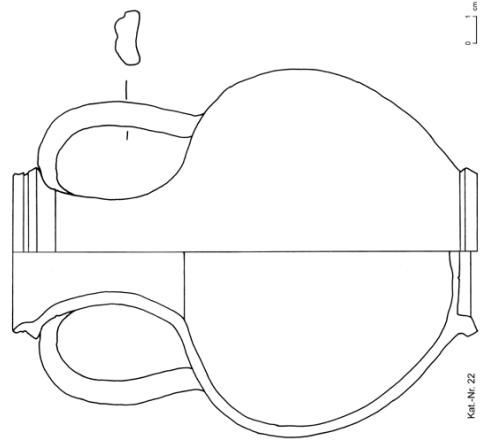
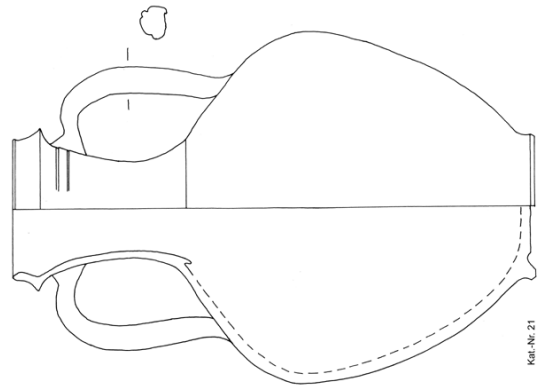
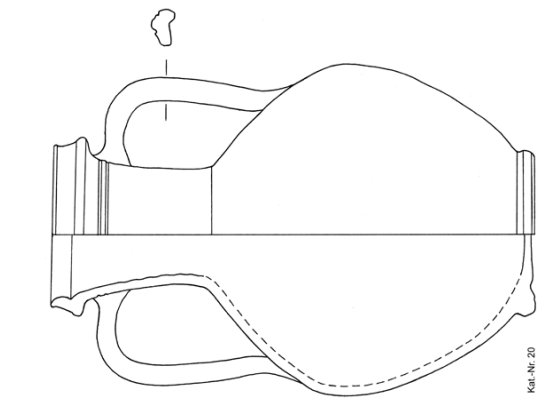
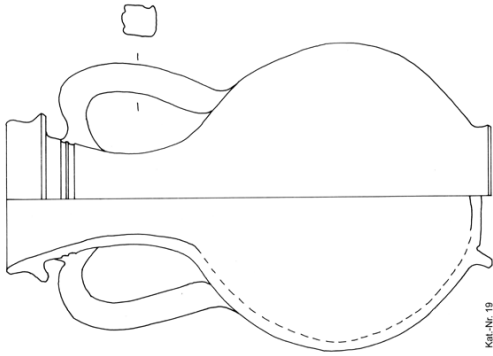
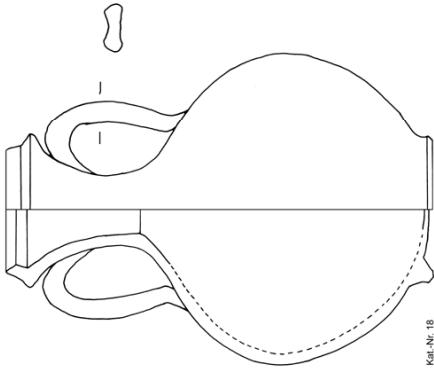
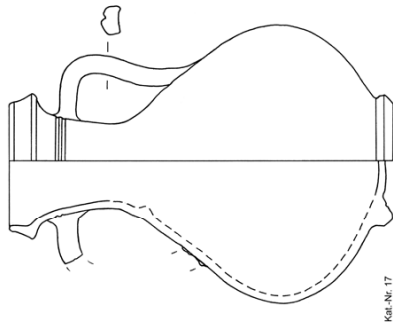
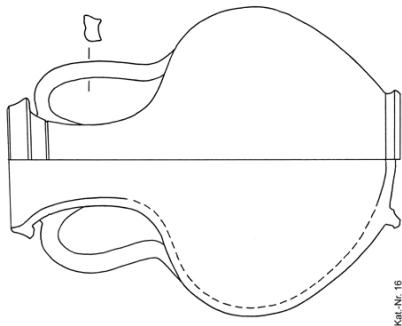

Form A-5

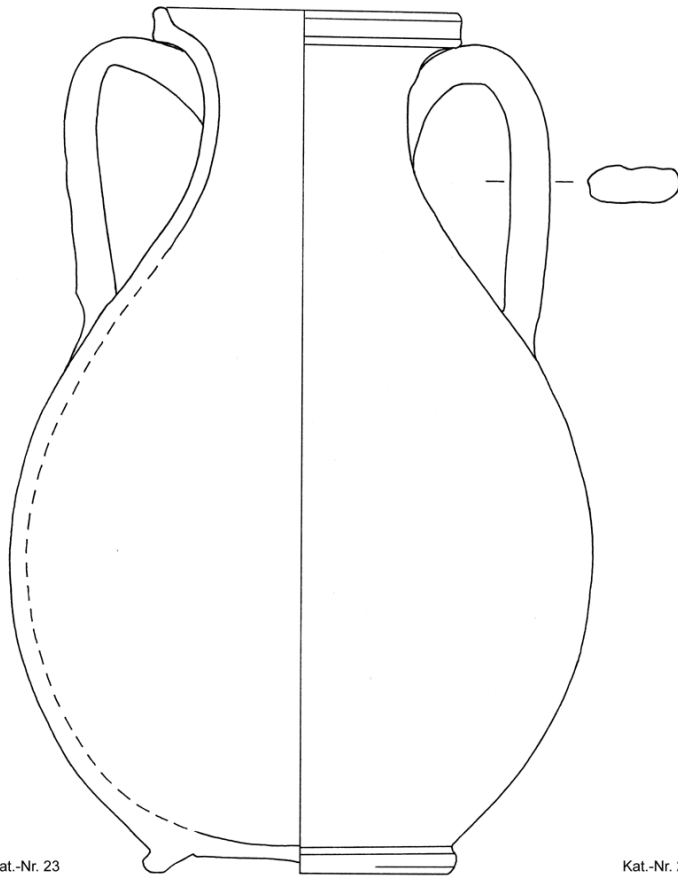

Kat.-Nr. 23

Form A-6

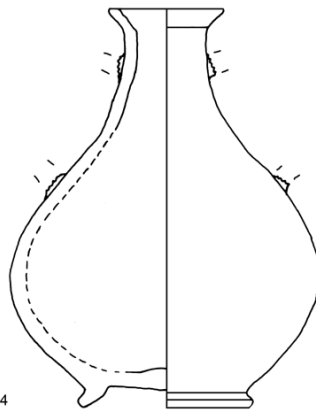

Kat.-Nr. 24

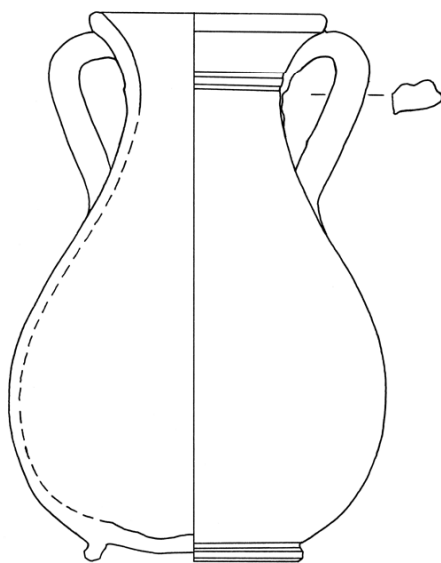

Kat.-Nr. 25

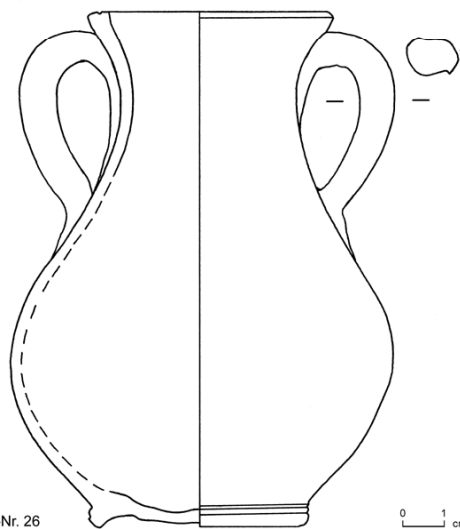

Kat.-Nr. 26

0 1 cm

Form K-1a (Teil 1)

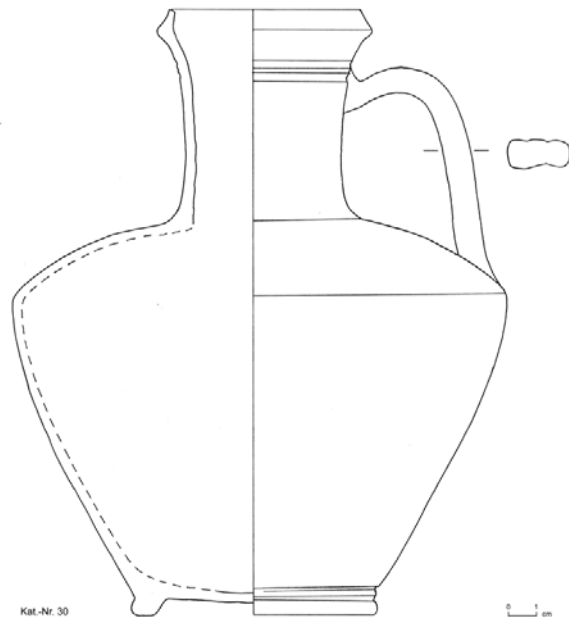
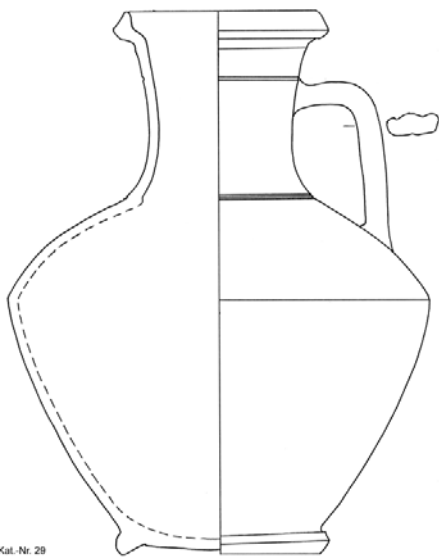
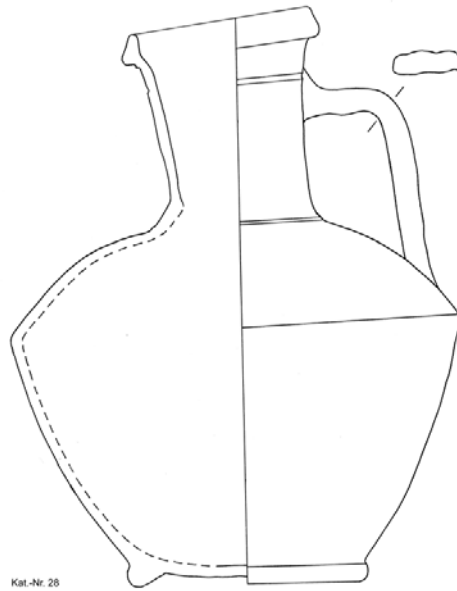
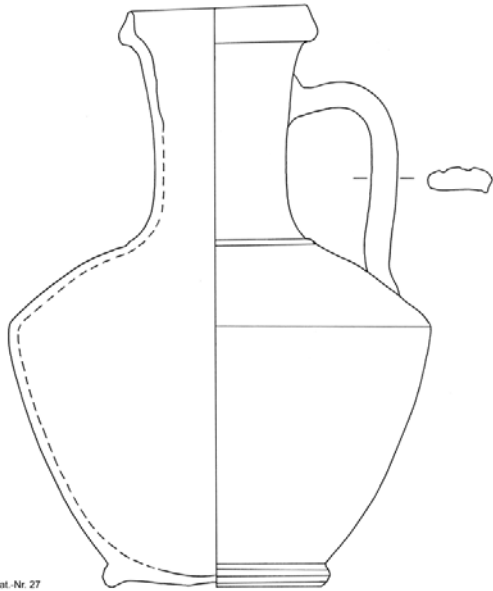

Form K-1a (Teil 2)

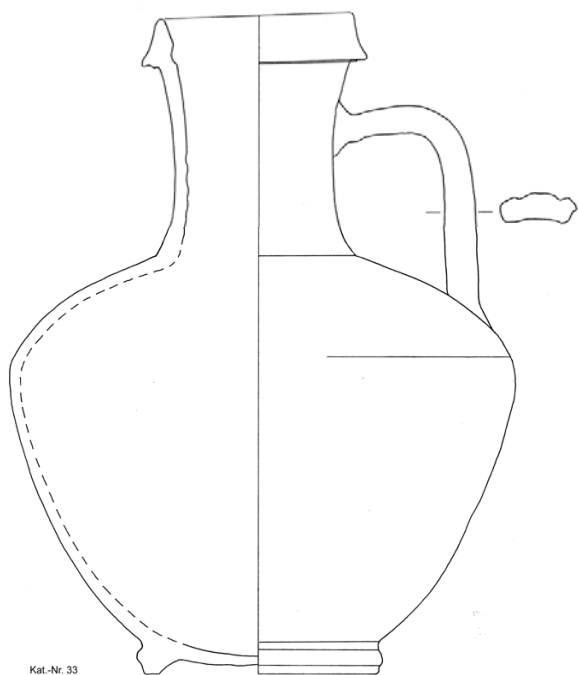
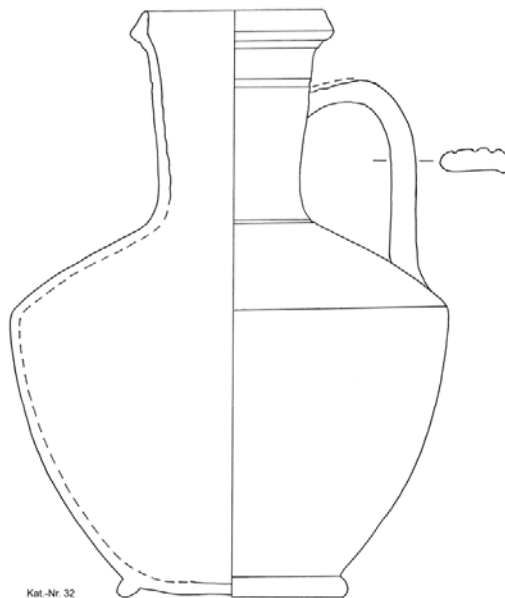
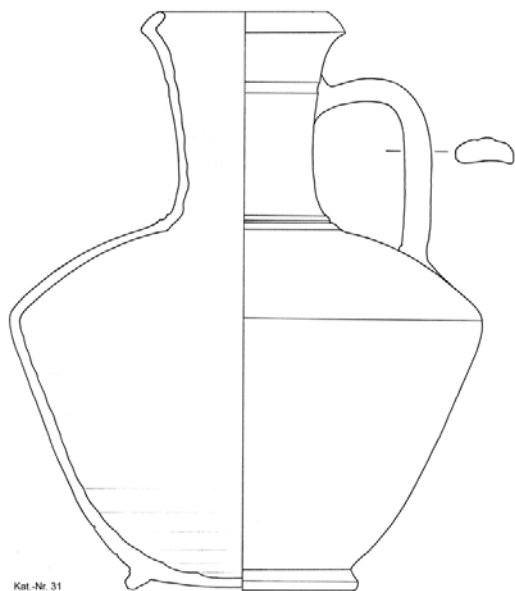

0 1 cm

Form K-2a

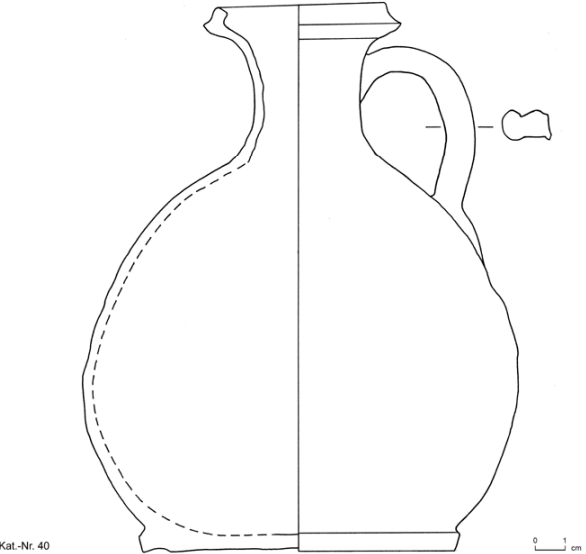
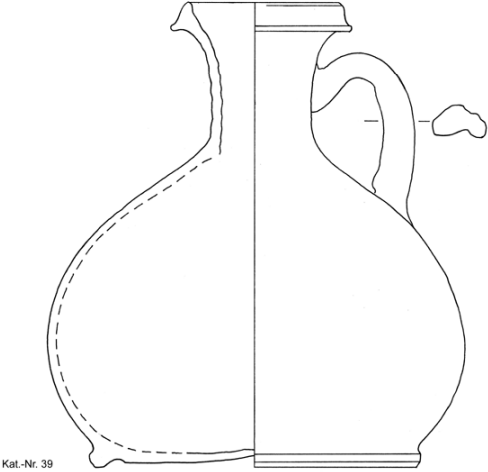
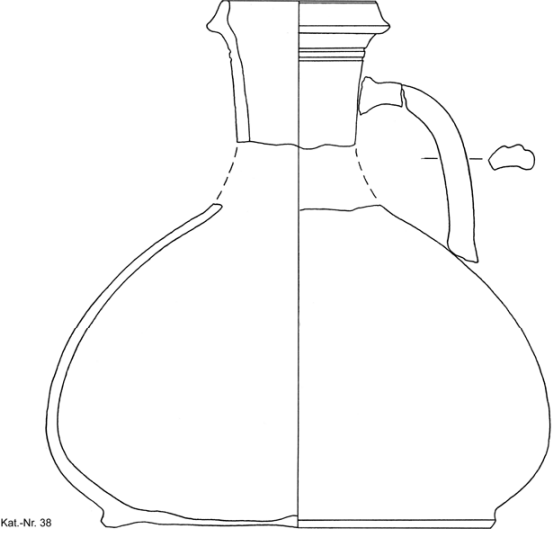
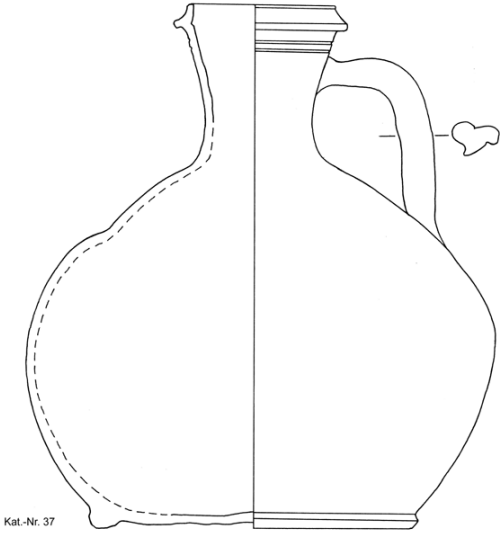

Form K-2c

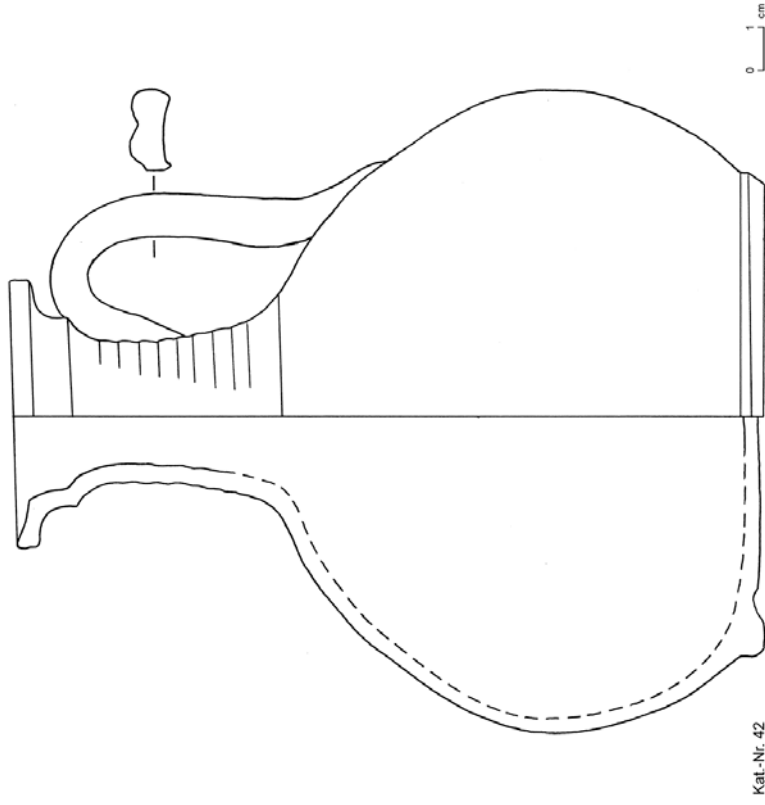

Kat.-Nr. 42

Form K-2b

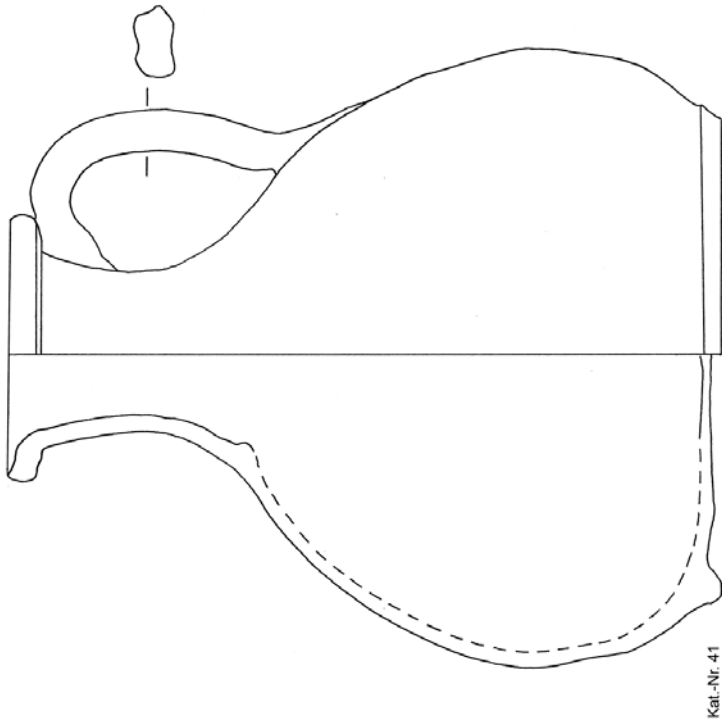

Kat.-Nr. 41

Form K-3a (Teil 1)

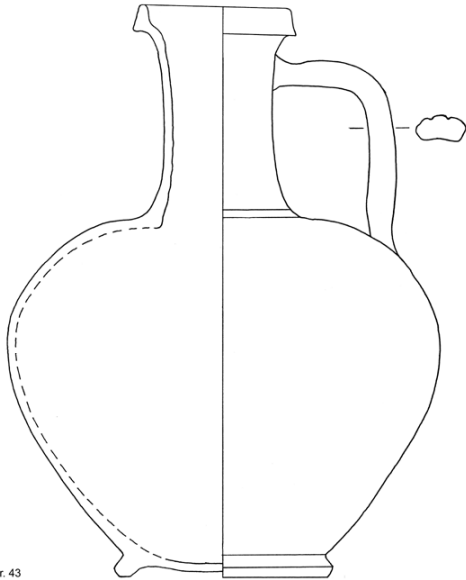

Kat.-Nr. 43

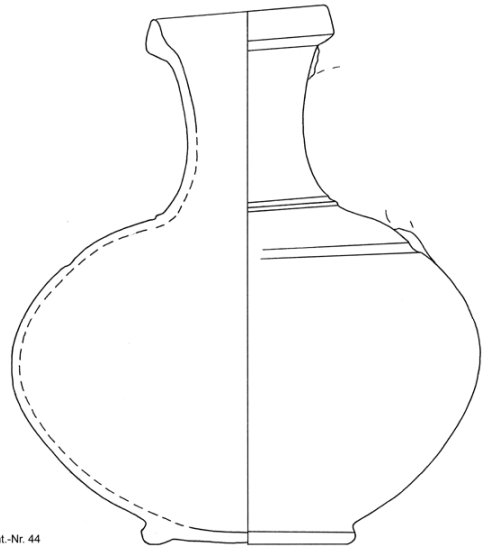

Kat.-Nr. 44

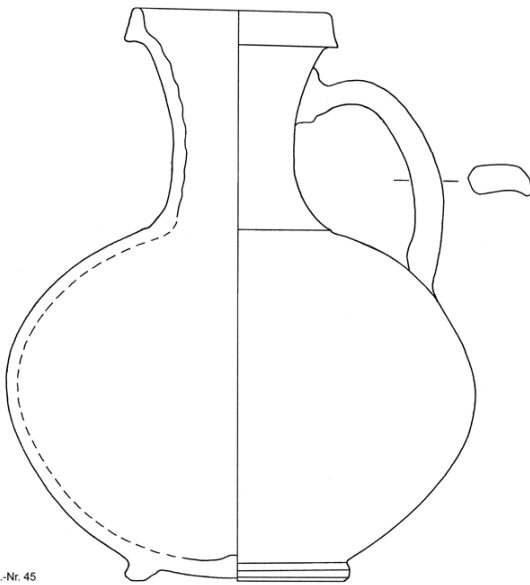

Kat.-Nr. 45

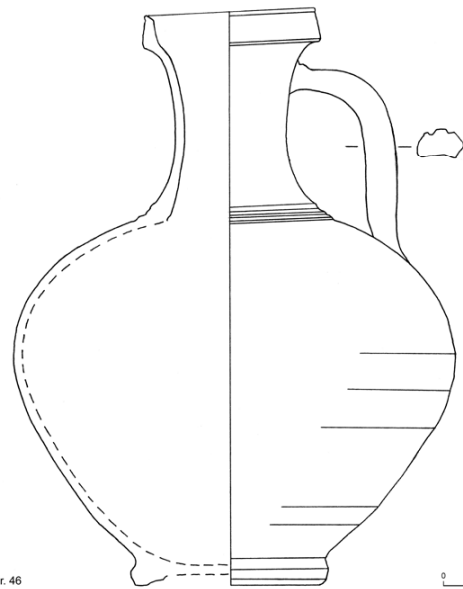

Kat.-Nr. 46

0 1 cm

Form K-3a (Teil 2)

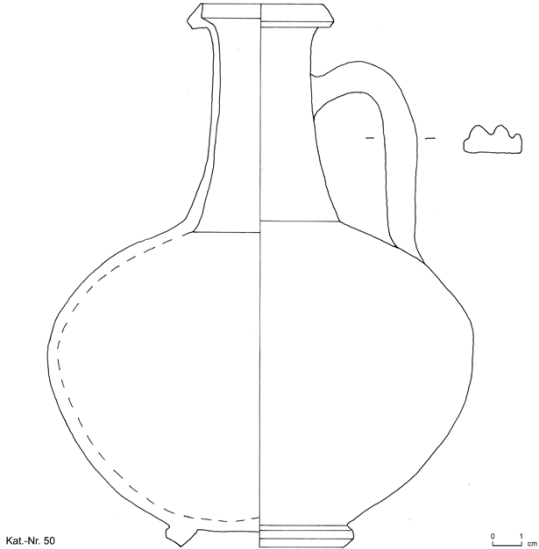
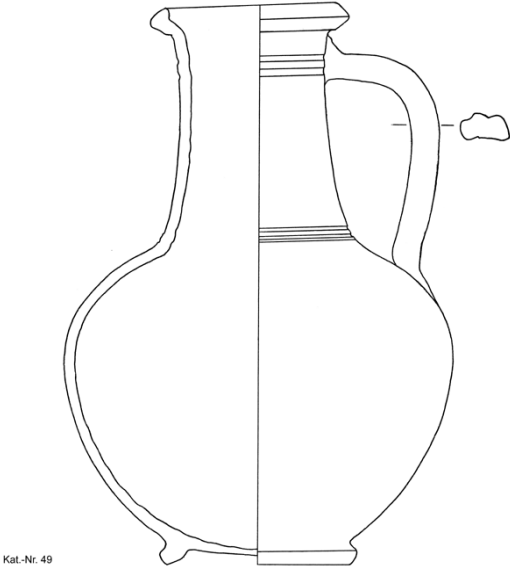
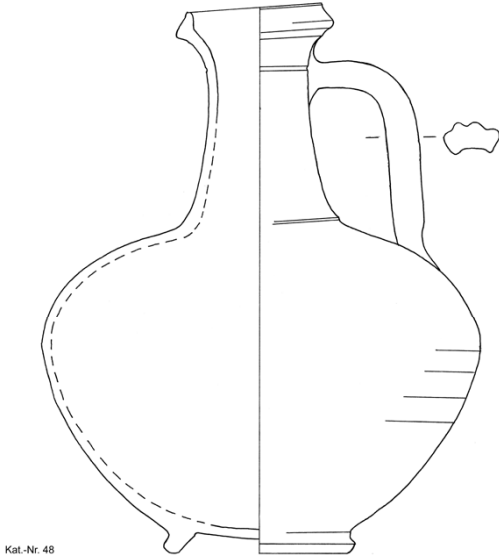
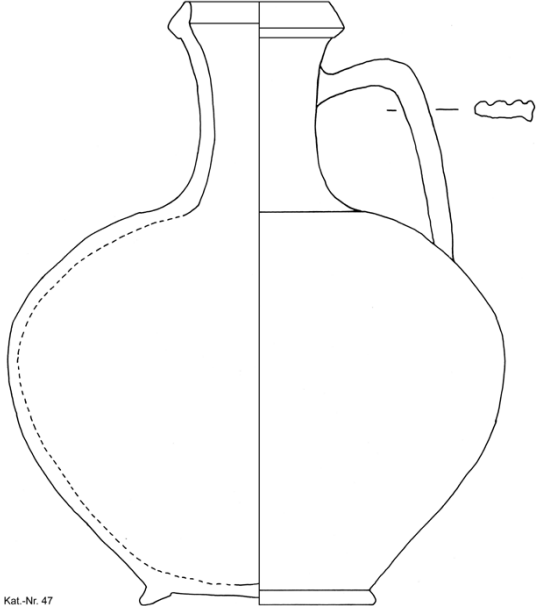

Form K-3a (Teil 3)



Kat-Nr. 51

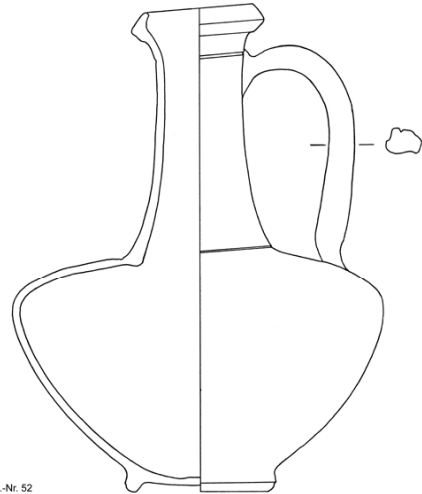

Kat-Nr. 52

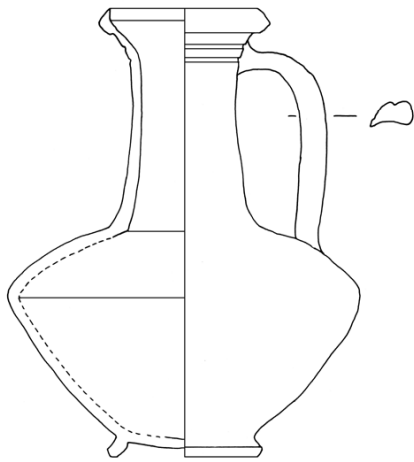

Kat-Nr. 53



Form K-3b (Teil 1)

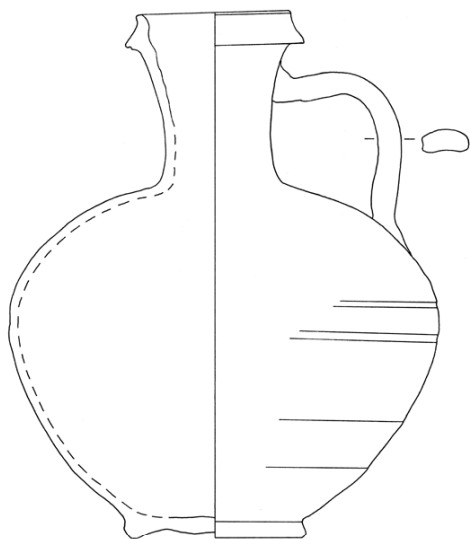

Kat. Nr. 54

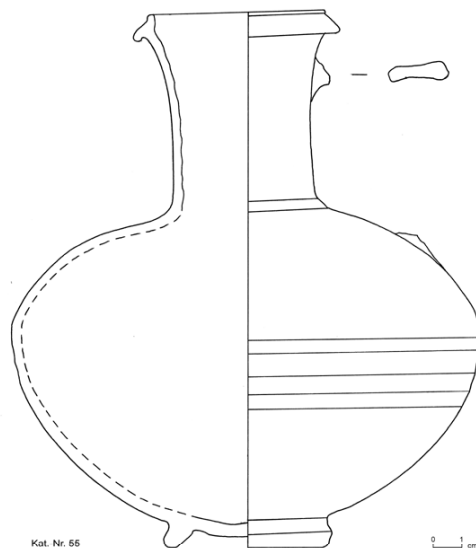

Kat. Nr. 55

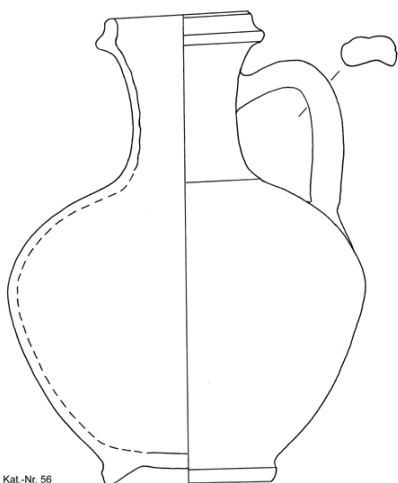

Kat.-Nr. 56

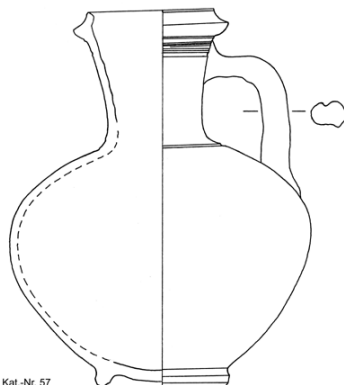

Kat.-Nr. 57

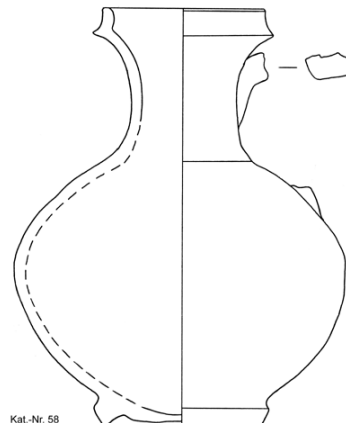

Kat.-Nr. 58

Form K-3b (Teil 2)

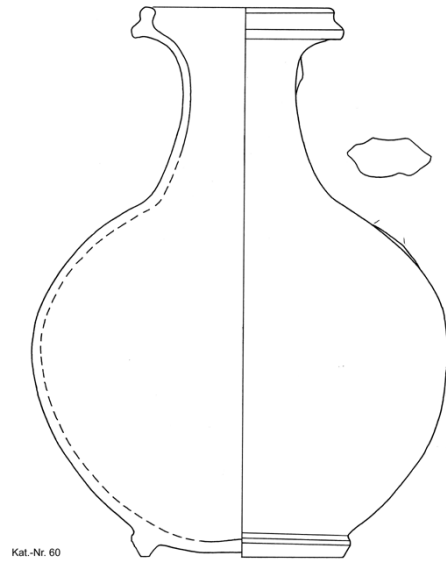
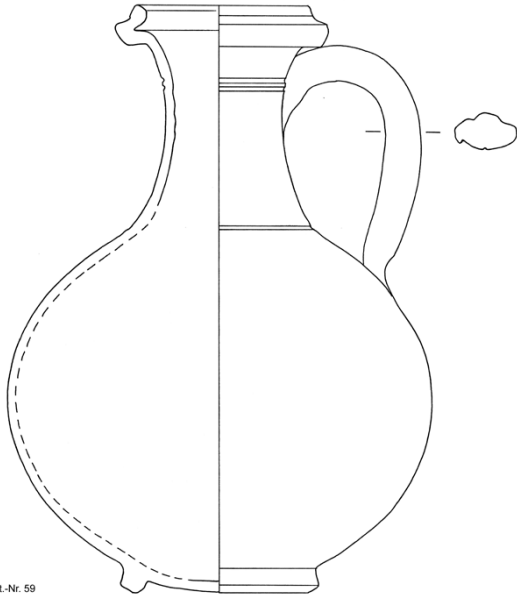

Kat.-Nr. 59

Kat.-Nr. 60

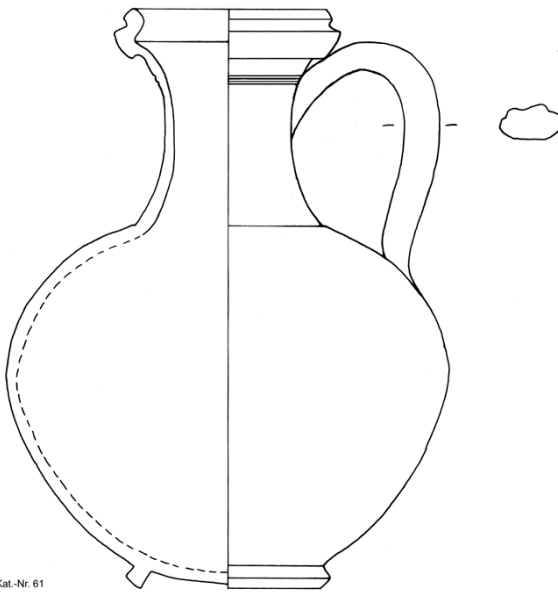

Kat.-Nr. 61

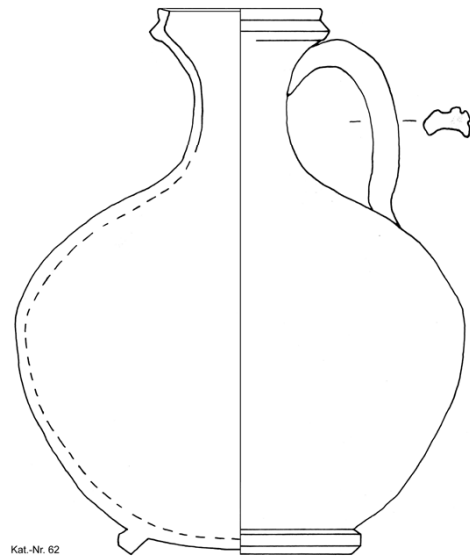

Kat.-Nr. 62

0 1 cm

Form K-4a (Teil 1)

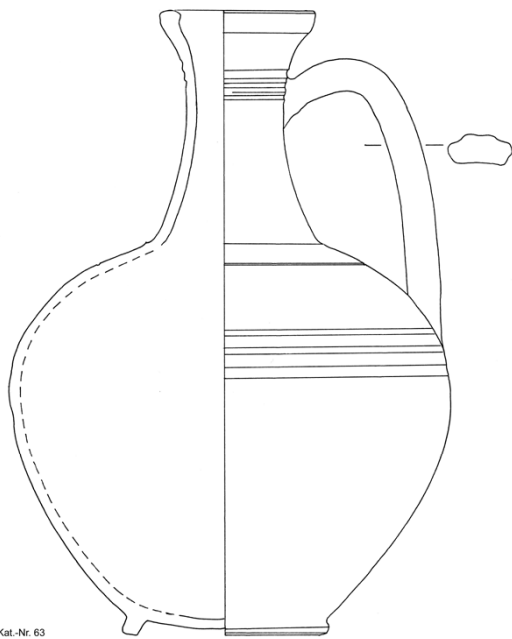

Kat.-Nr. 63

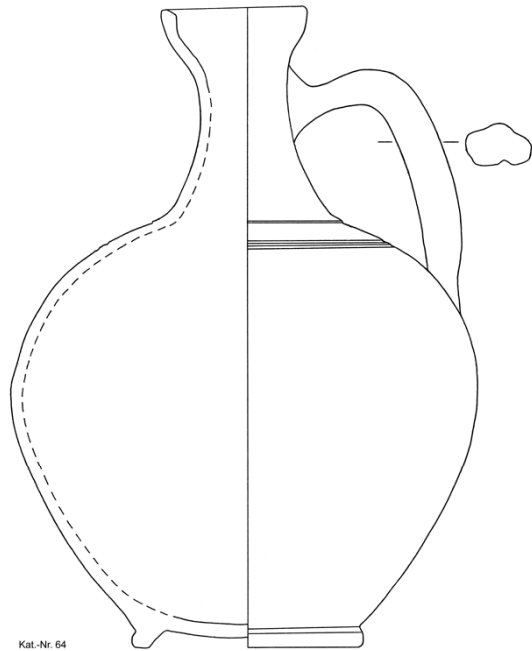

Kat.-Nr. 64

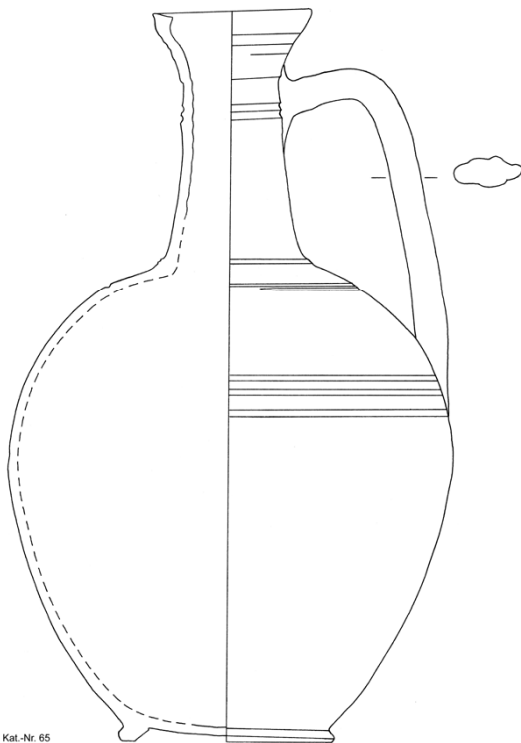

Kat.-Nr. 65

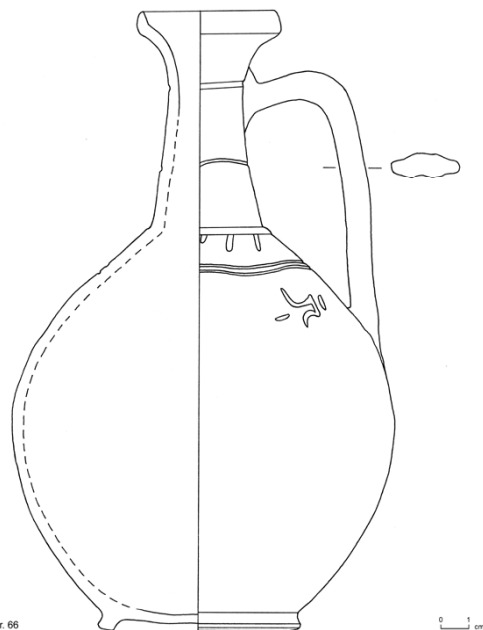

Kat.-Nr. 66

0 5 cm

Form K-4a (Teil 2)

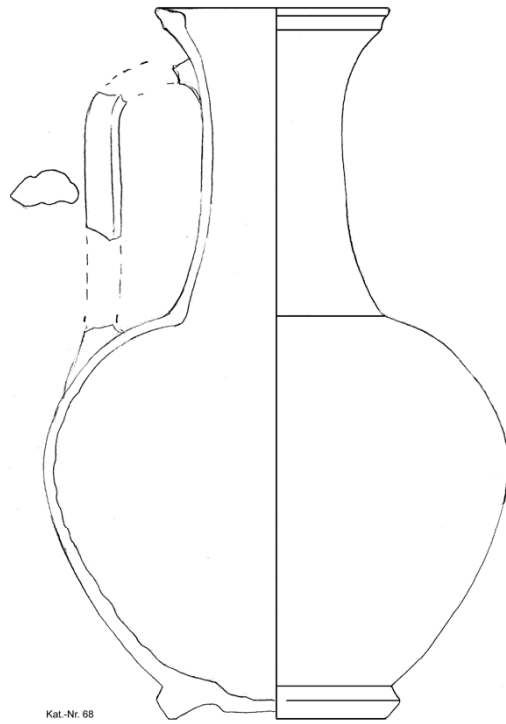
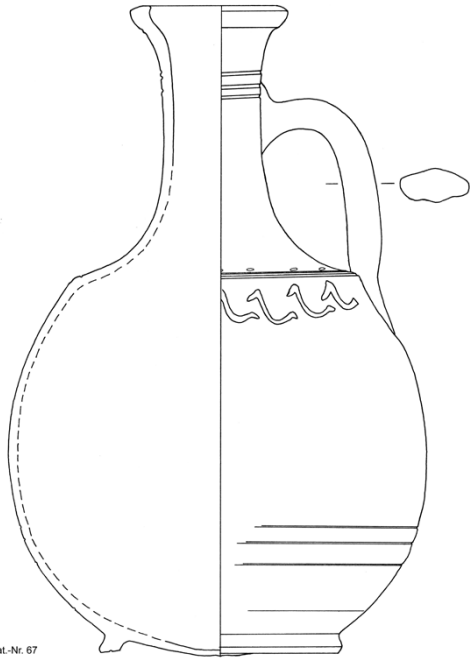

Form K-4b

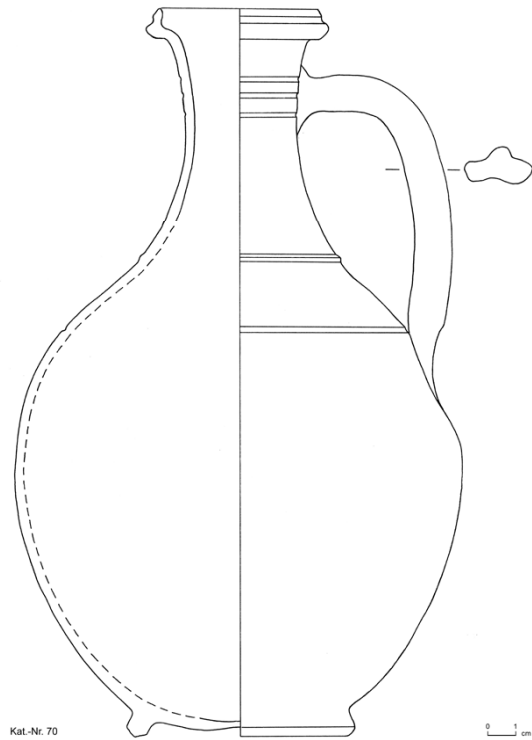
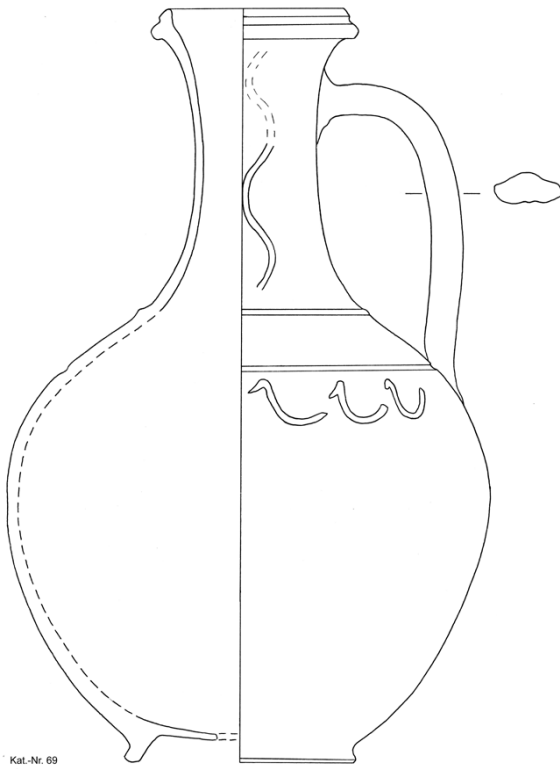

Form K-4c

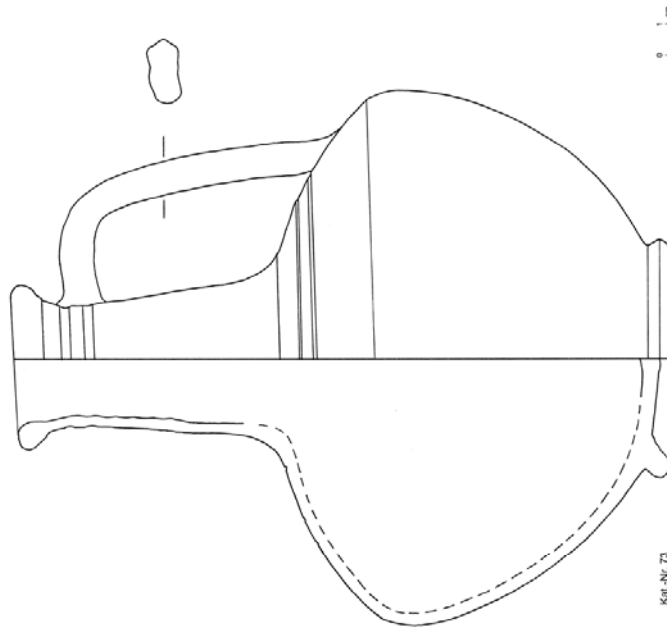

Kat.-Nr. 73

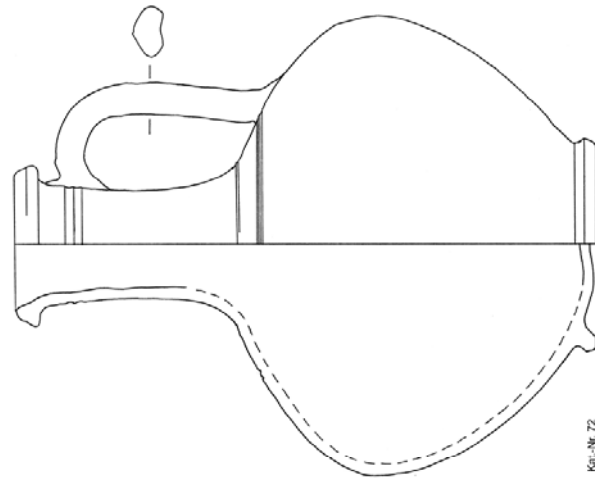

Kat.-Nr. 72

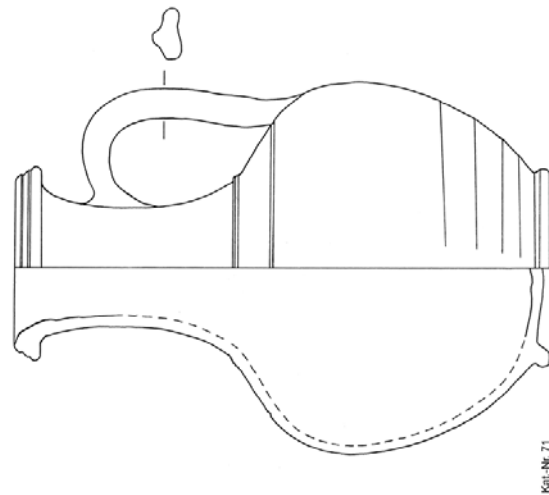

Kat.-Nr. 71

Form K-5a (Teil 1)

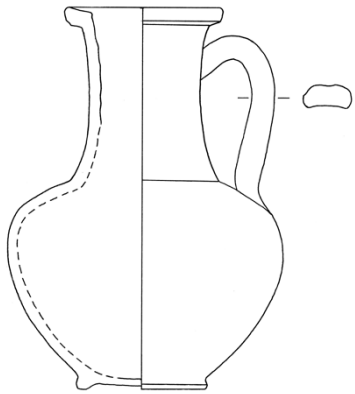

Kat.-Nr. 74

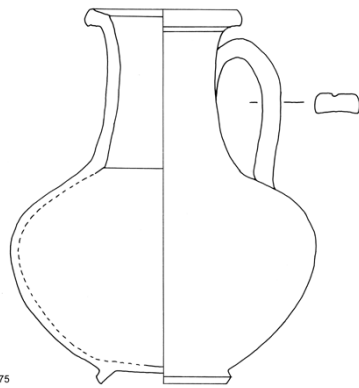

Kat.-Nr. 75

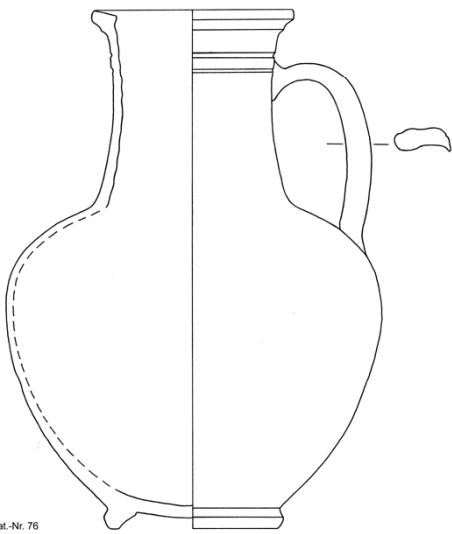

Kat.-Nr. 76

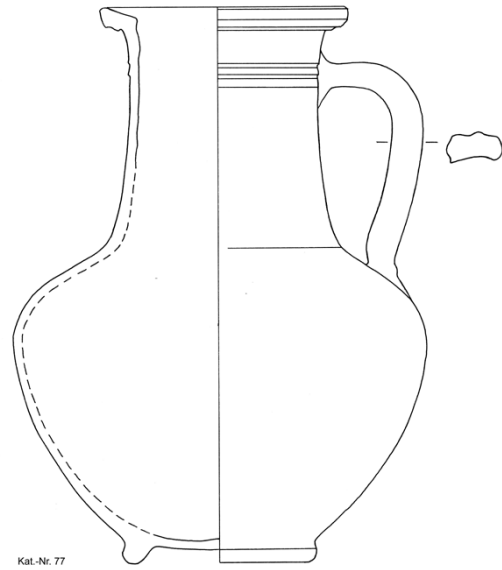

Kat.-Nr. 77

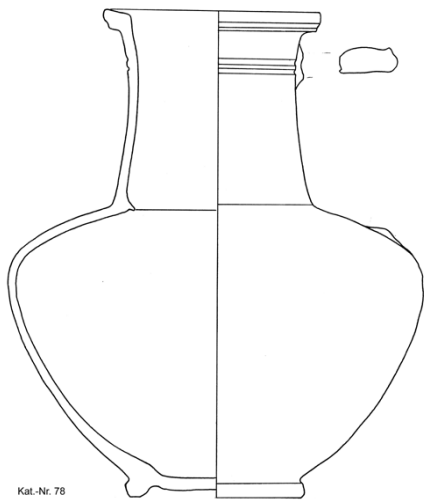

Kat.-Nr. 78

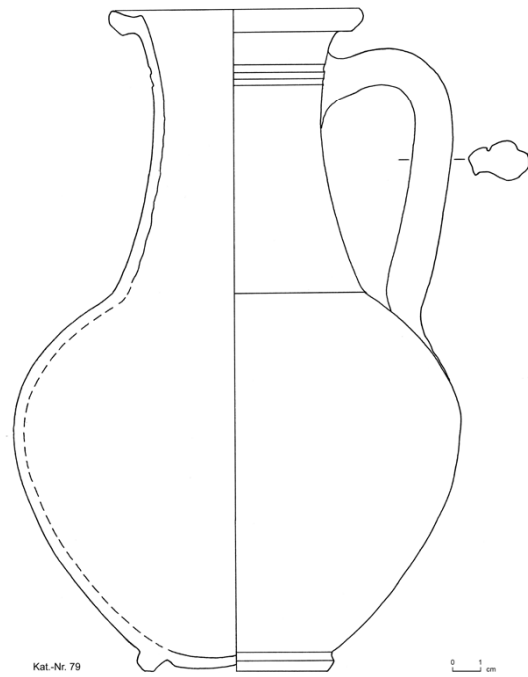

Kat.-Nr. 79

0 1 cm

Form K-5a (Teil 2)

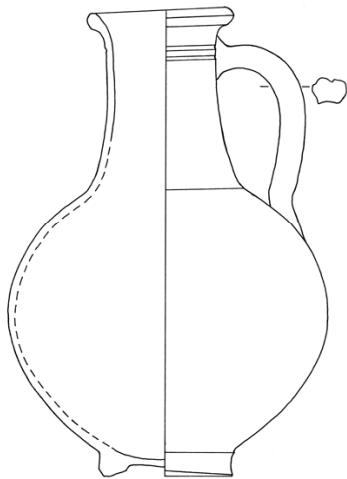

Kat.-Nr. 80

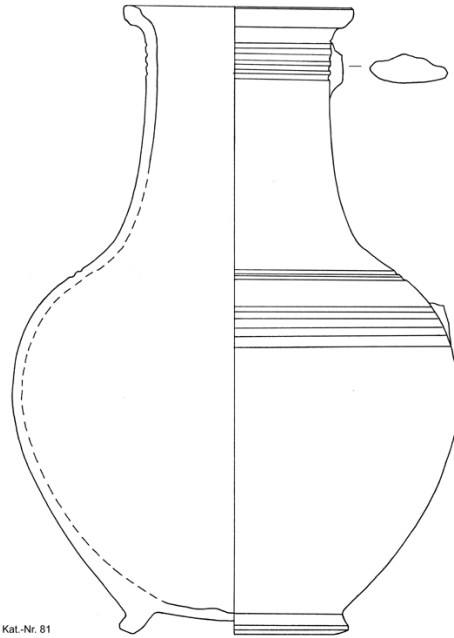

Kat.-Nr. 81

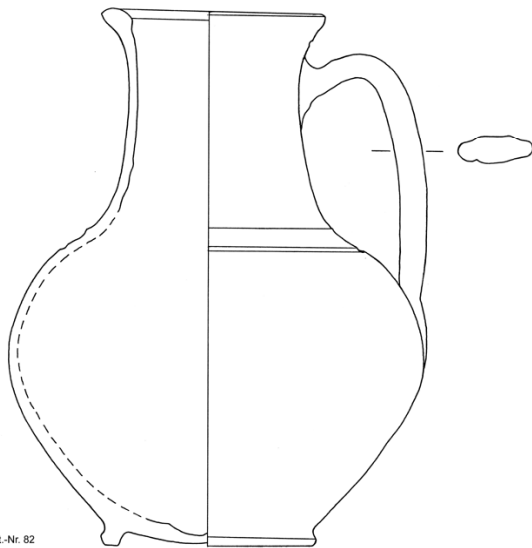

Kat.-Nr. 82

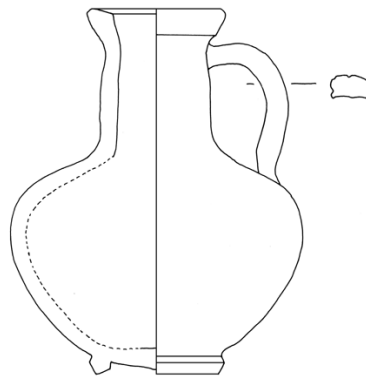

Kat.-Nr. 83

0 1 cm

Form K-5a (Teil 3)

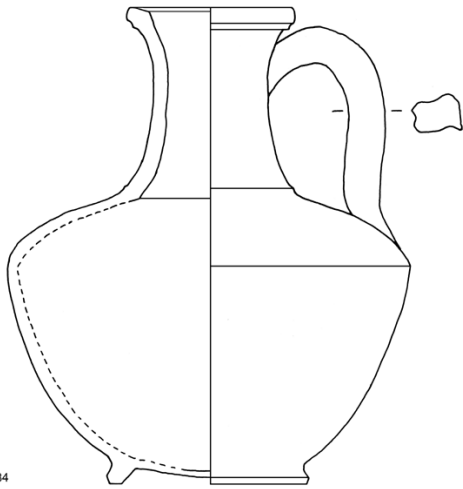

Kat.-Nr. 84

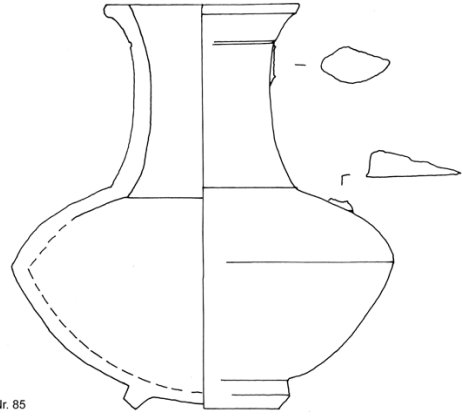

Kat.-Nr. 85

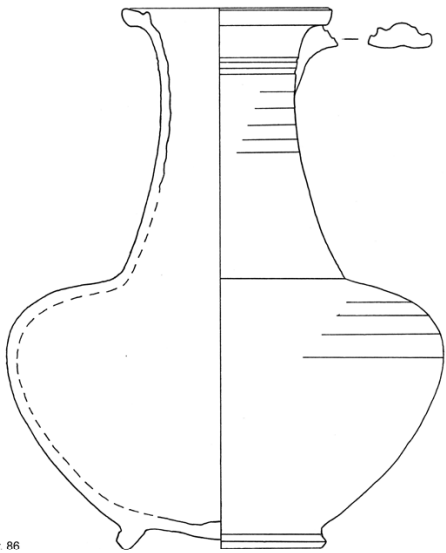

Kat.-Nr. 86

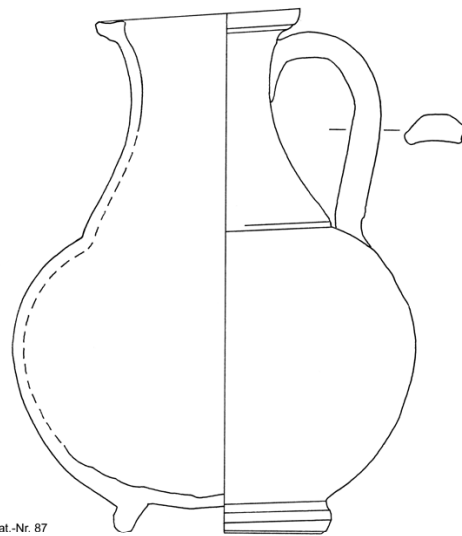

Kat.-Nr. 87

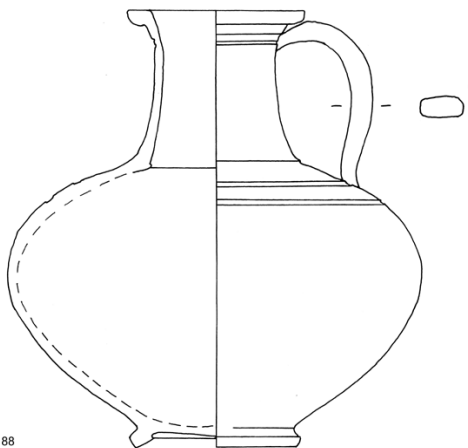

Kat.-Nr. 88

0 1 cm

Form K-5b

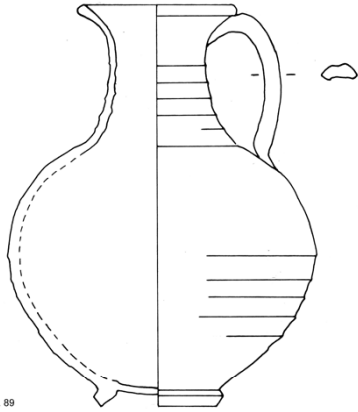

Kat.-Nr. 89

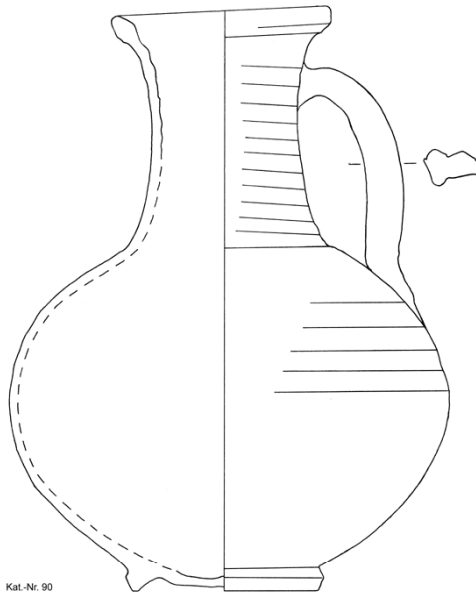

Kat.-Nr. 90

Form K-5c

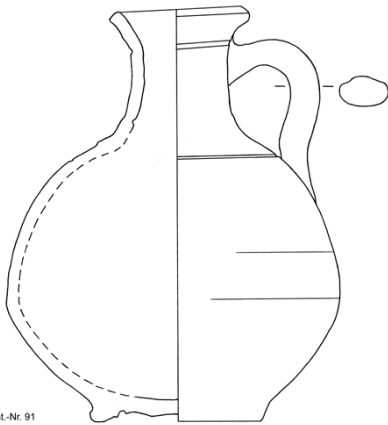

Kat.-Nr. 91

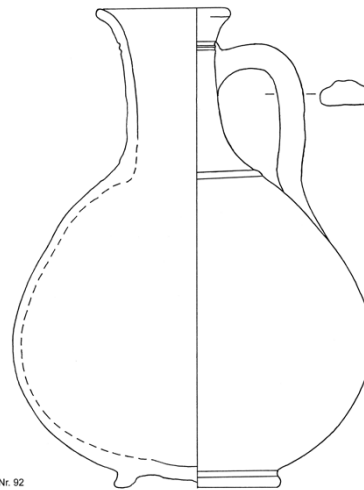

Kat.-Nr. 92

Form K-5d

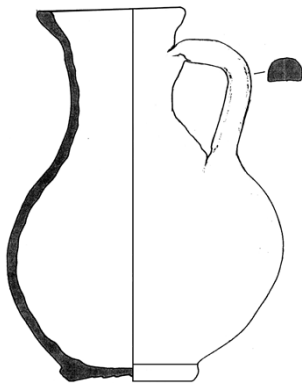

Kat.-Nr. 93

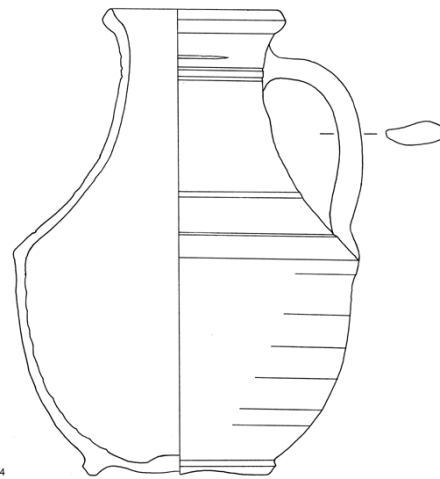

Kat.-Nr. 94



Form K-6

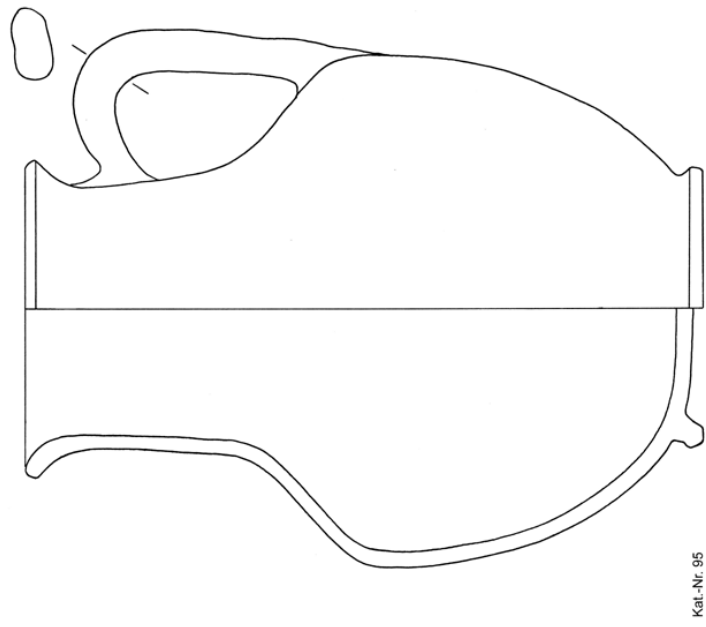
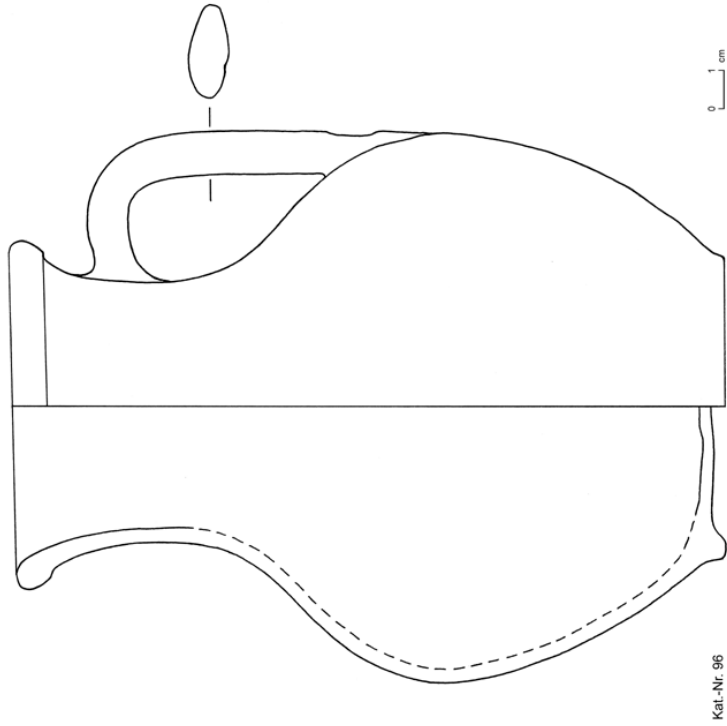

Form K-7 (Teil 1)

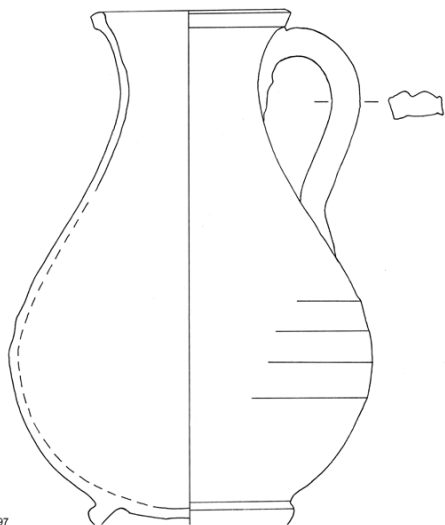

Kat.-Nr. 97

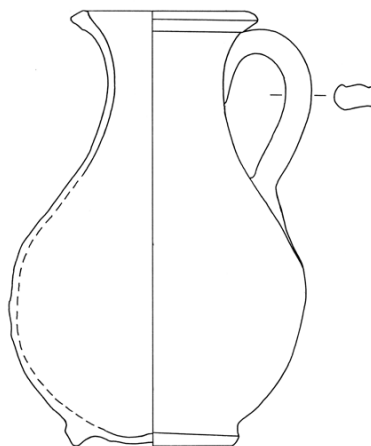

Kat.-Nr. 98

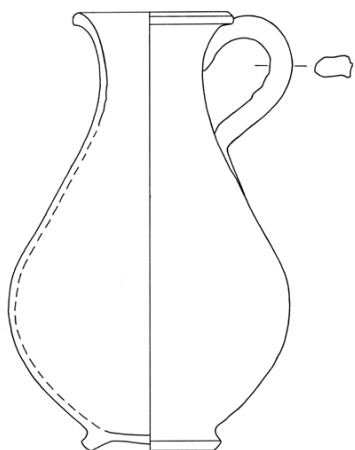

Kat.-Nr. 99

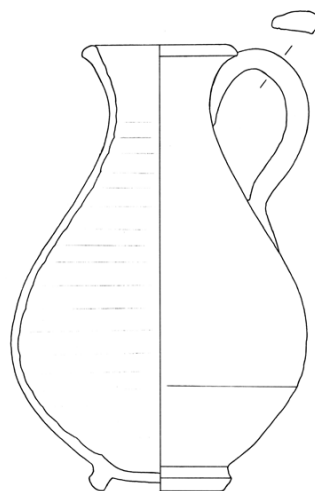

Kat.-Nr. 100

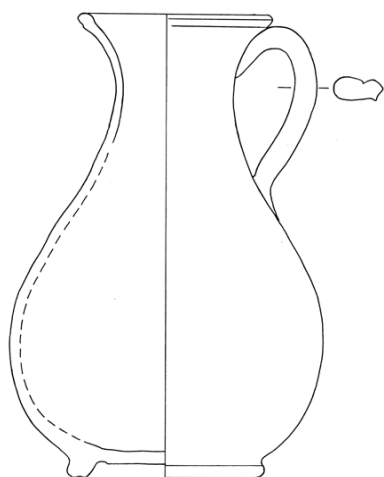

Kat.-Nr. 101

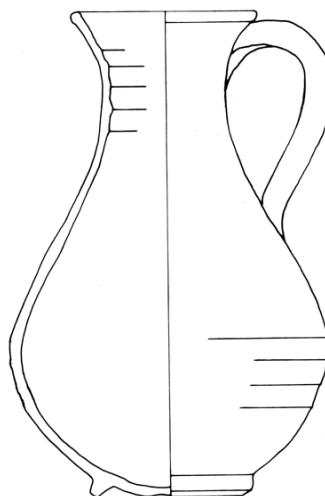

Kat.-Nr. 102

0 1 cm

Form K-7
(Teil 2)

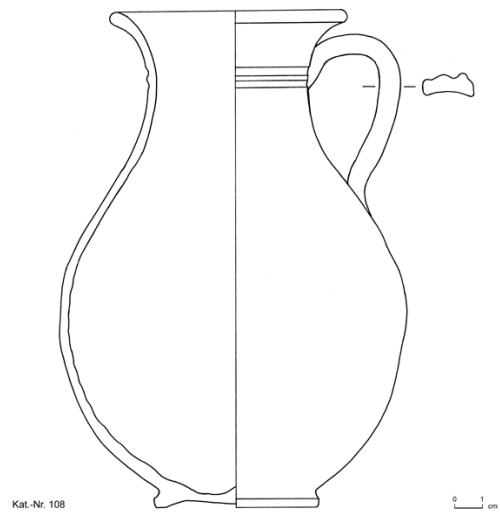
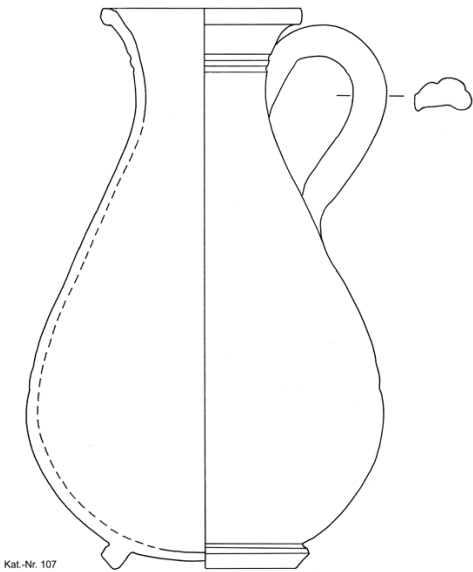
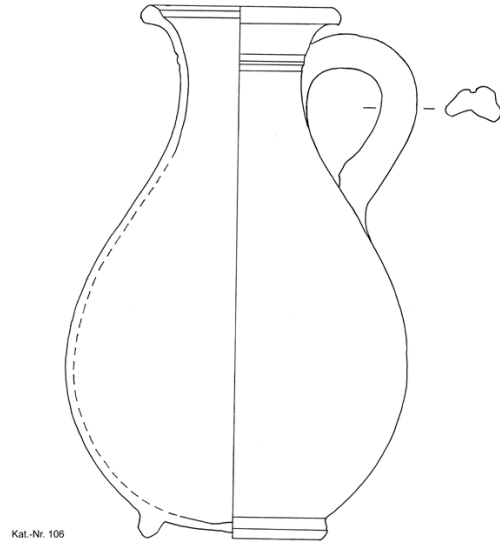
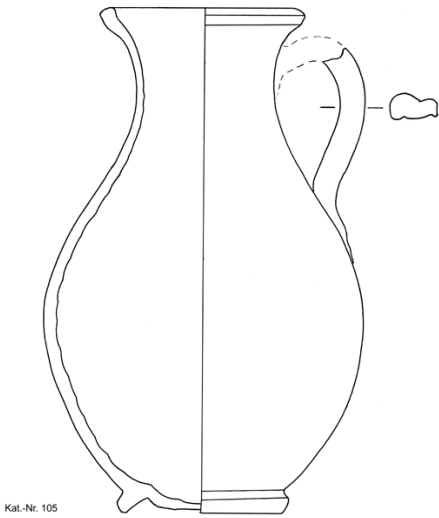
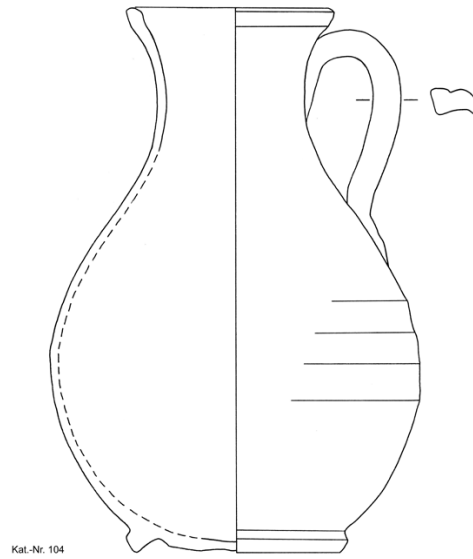
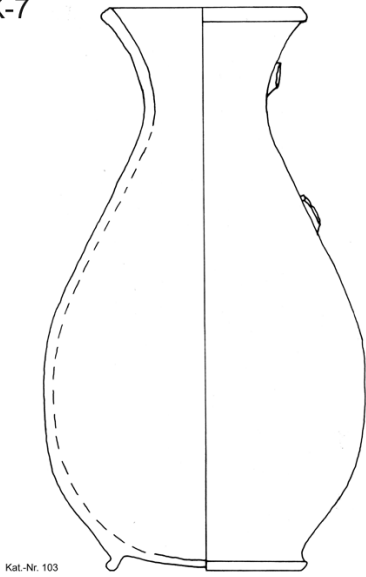

0 1 cm

Form K-7 (Teil 3)

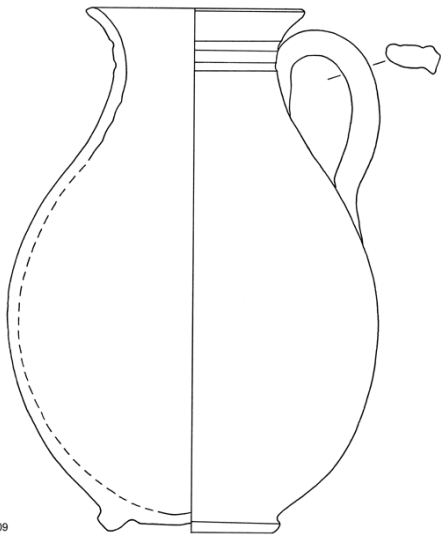

Kat.-Nr. 109

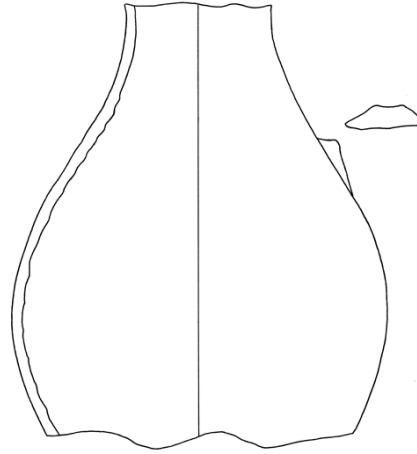

Kat.-Nr. 110



Form K-7 (2005)

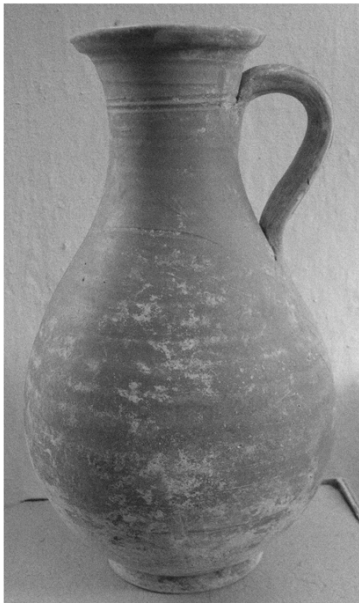

Kat.-Nr. 355

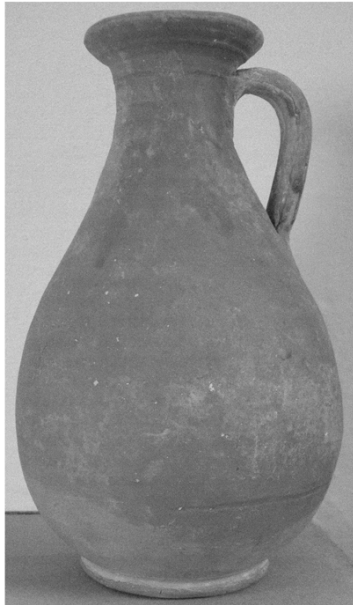

Kat.-Nr. 356

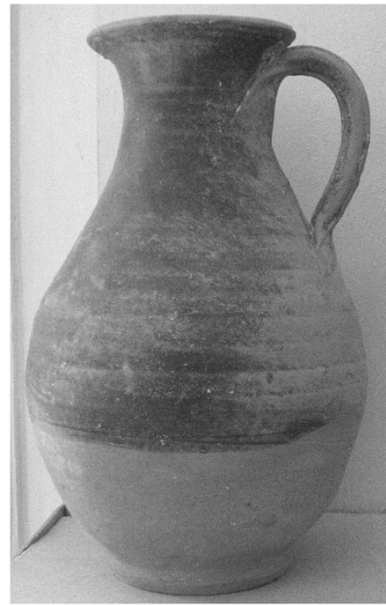

Kat.-Nr. 357

Form K-8a

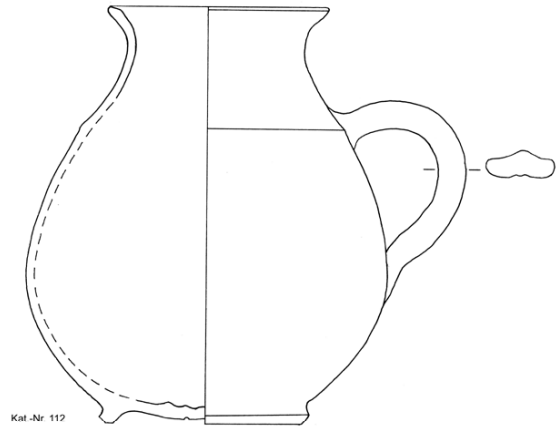
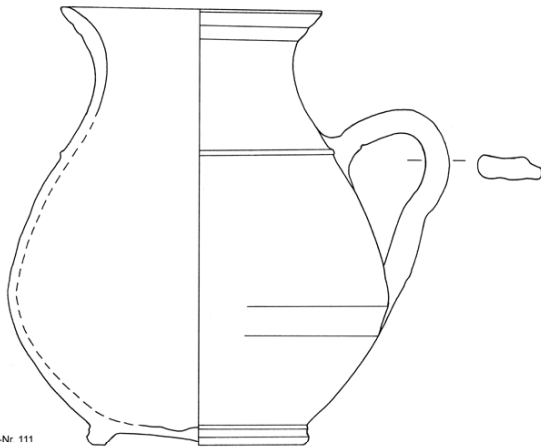

Form K-8b

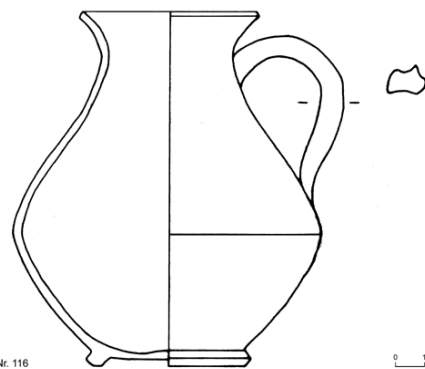
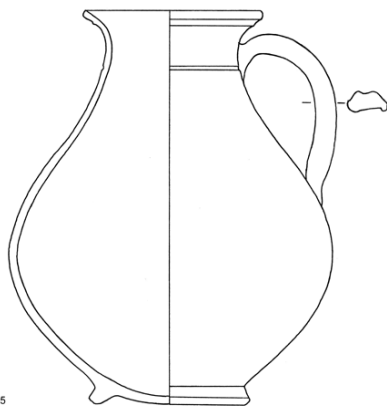
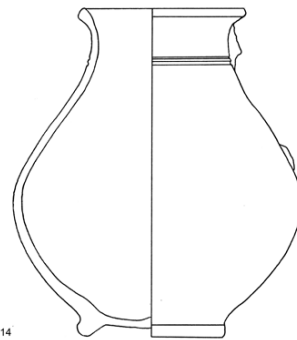
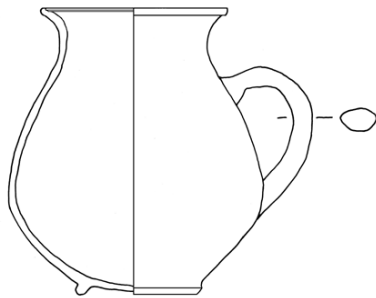

Form K-8c

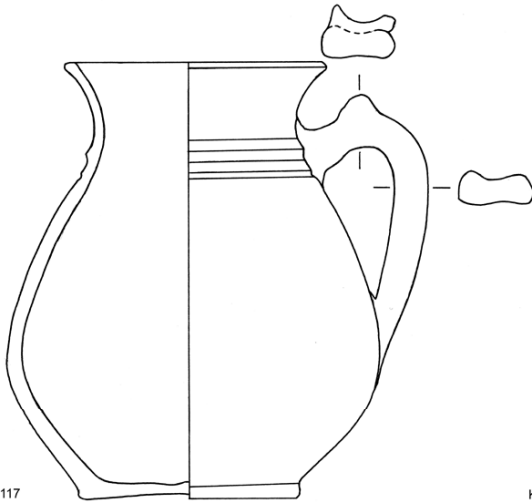

Kat.-Nr. 117

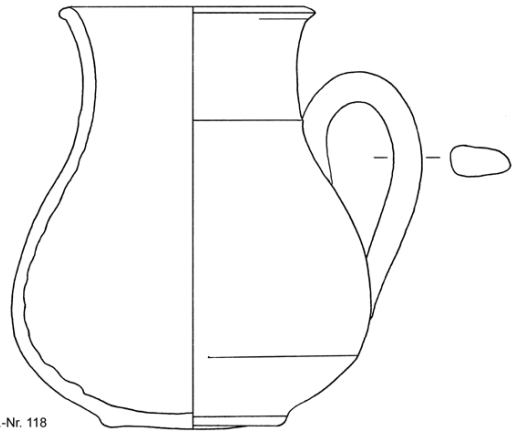

Kat.-Nr. 118

Form K-8d

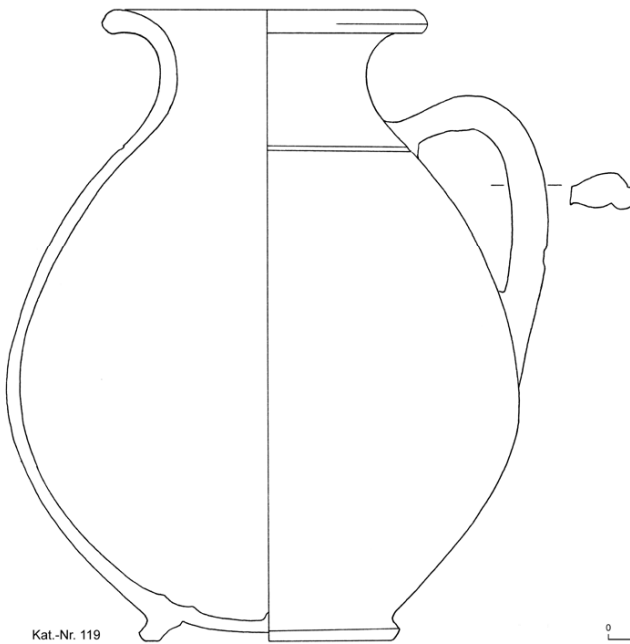

Kat.-Nr. 119

0 1 cm

Form K-9

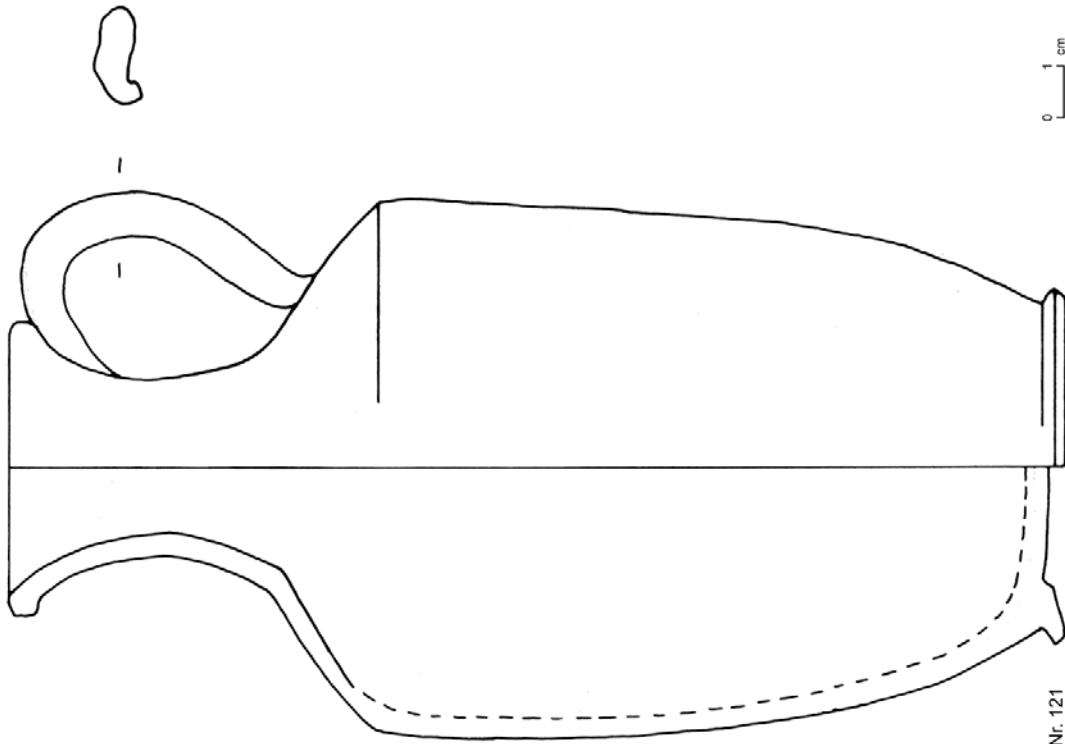

Kat.-Nr. 121

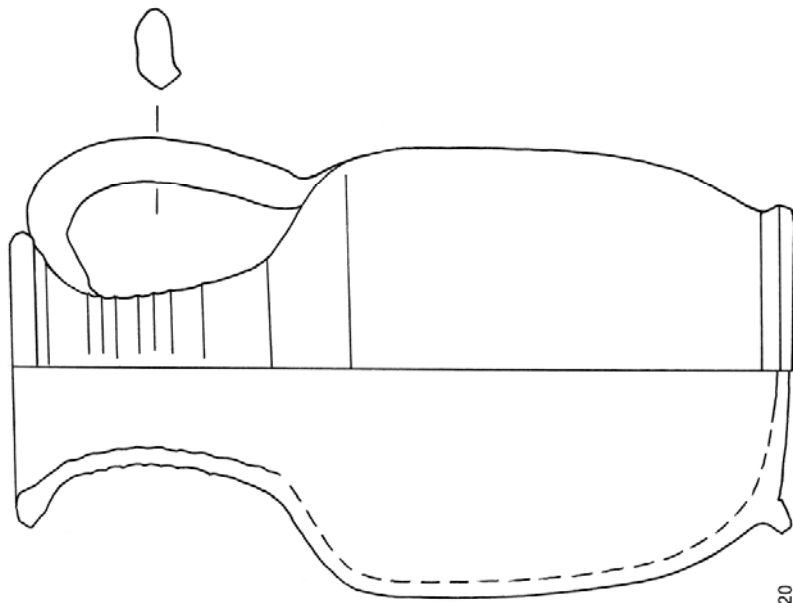

Kat.-Nr. 120

Form K-10a (Teil 1)

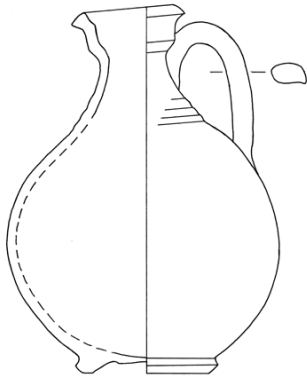

Kat.-Nr. 122

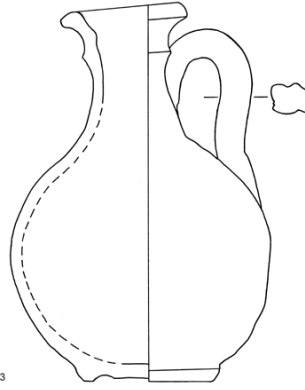

Kat.-Nr. 123

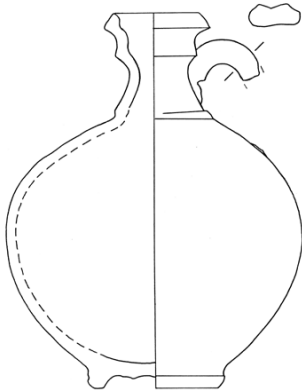

Kat.-Nr. 124

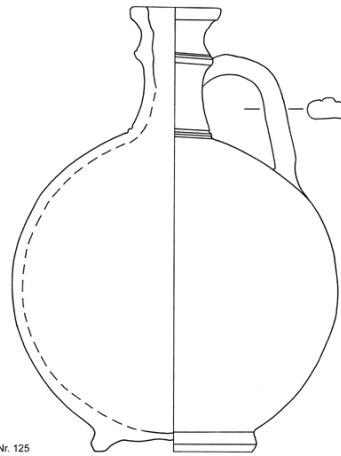

Kat.-Nr. 125

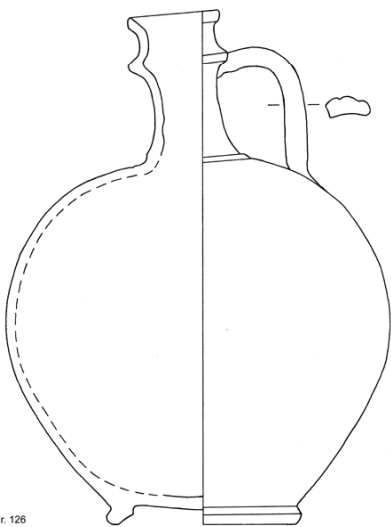

Kat.-Nr. 126

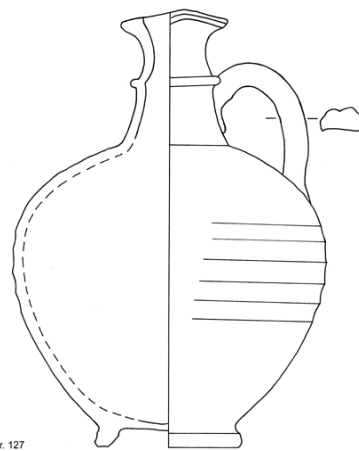

Kat.-Nr. 127

0 1 cm

Form K-10a (Teil 2)

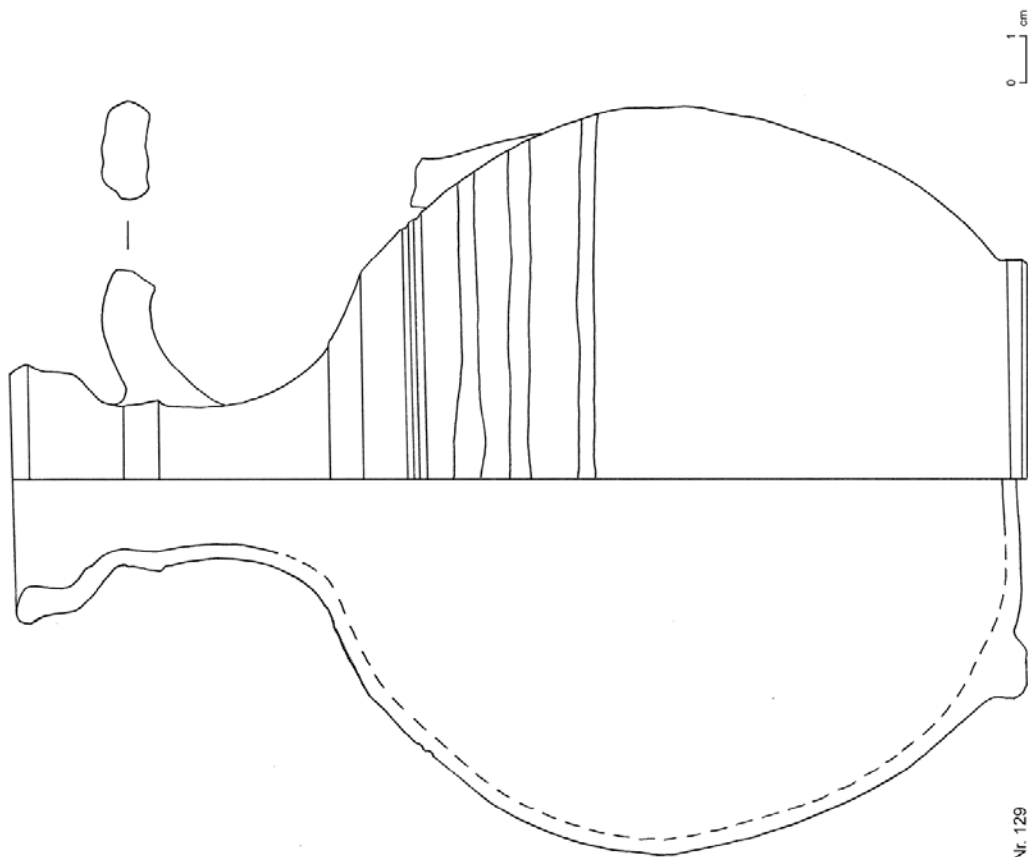

0 1 cm

Kat.-Nr. 129

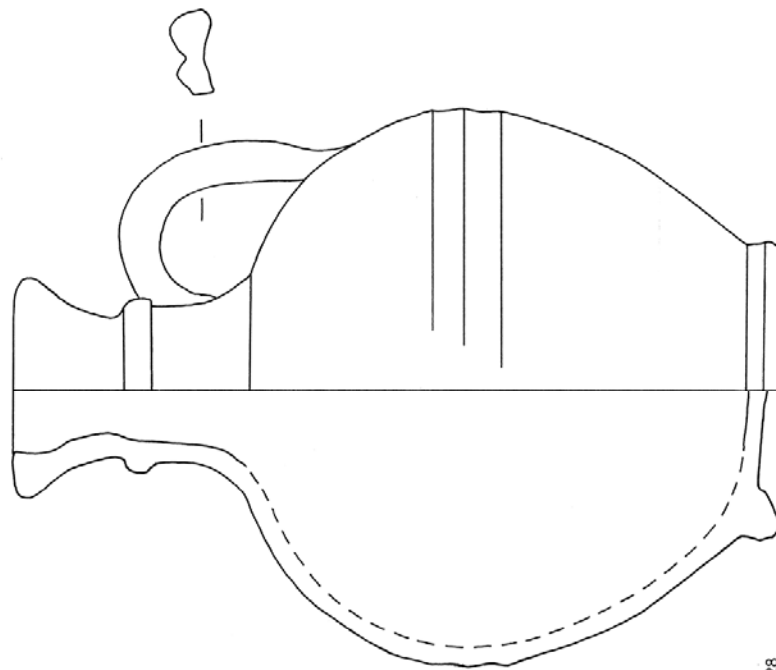

Kat.-Nr. 128

Form K-10b

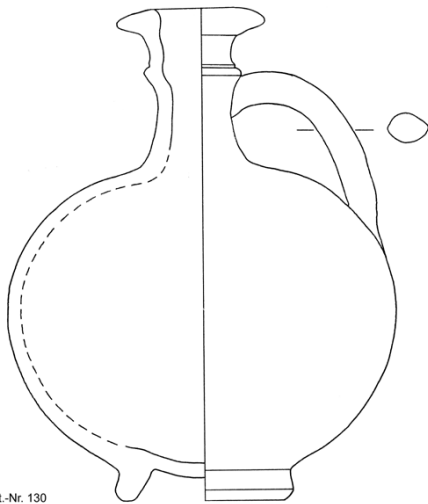

Kat.-Nr. 130

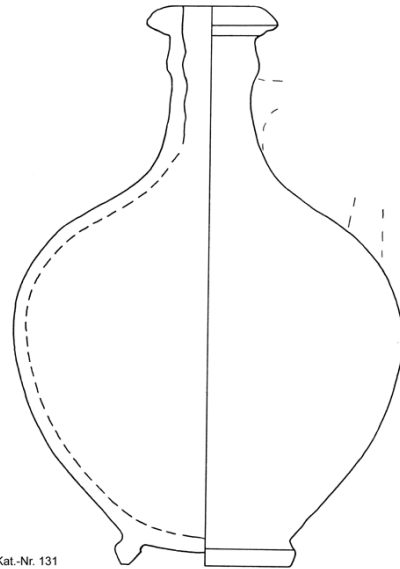

Kat.-Nr. 131

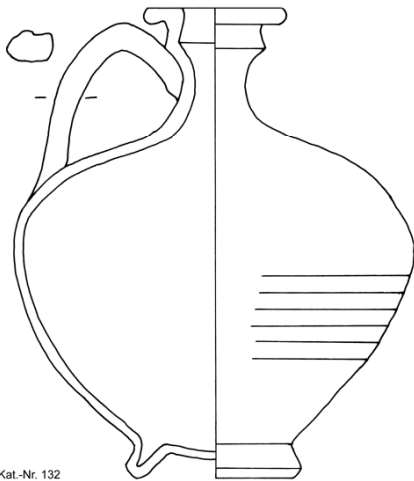

Kat.-Nr. 132

0 1 cm

Form K-10d

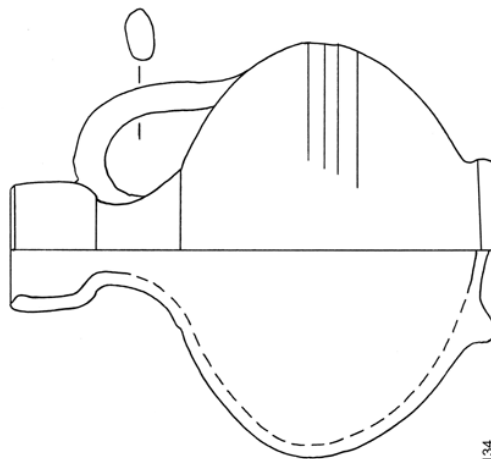

Kat.-Nr. 134



Form K-10c

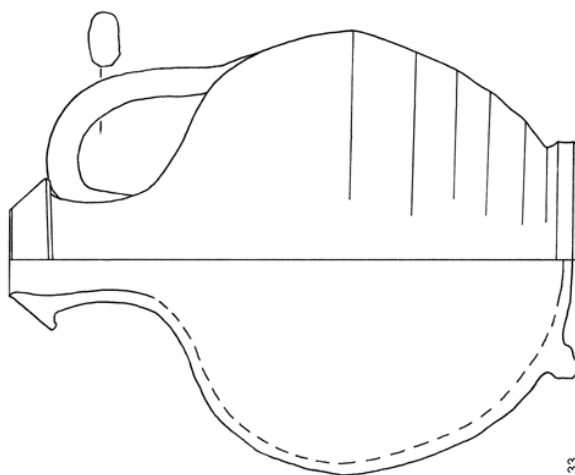

Kat.-Nr. 133

Form K-11

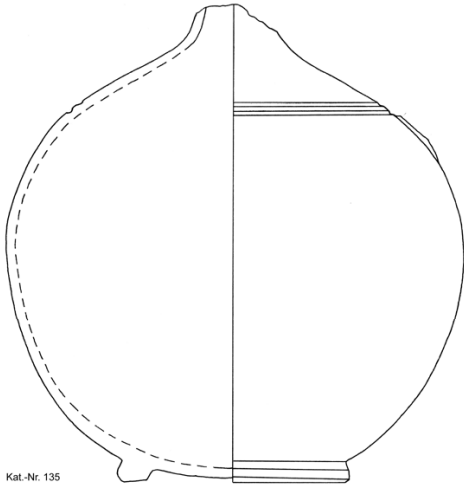

Kat.-Nr. 135

Form K-12

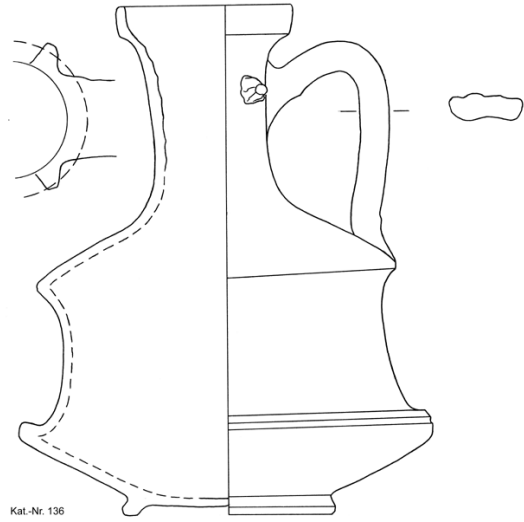

Kat.-Nr. 136

Form K-13

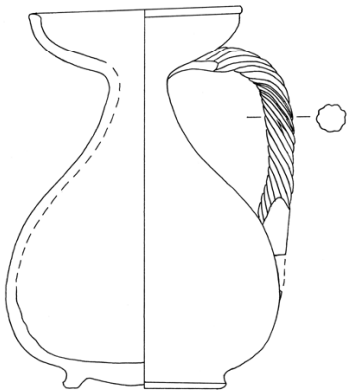

Kat.-Nr. 137

Form K-14

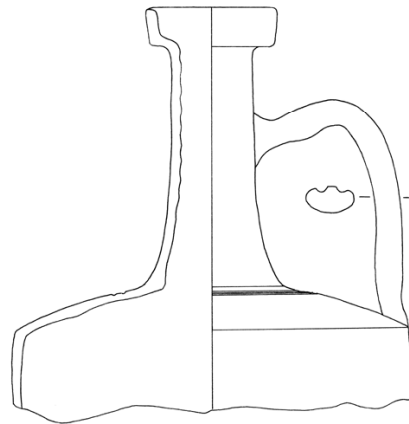

Kat.-Nr. 138

0 1 cm

Form O-1

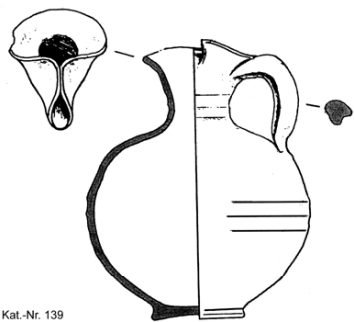

Kat.-Nr. 139

Form O-2

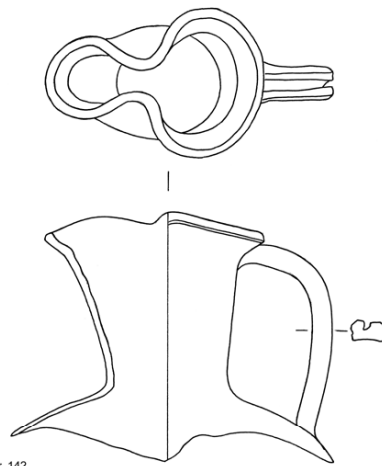

Kat.-Nr. 142

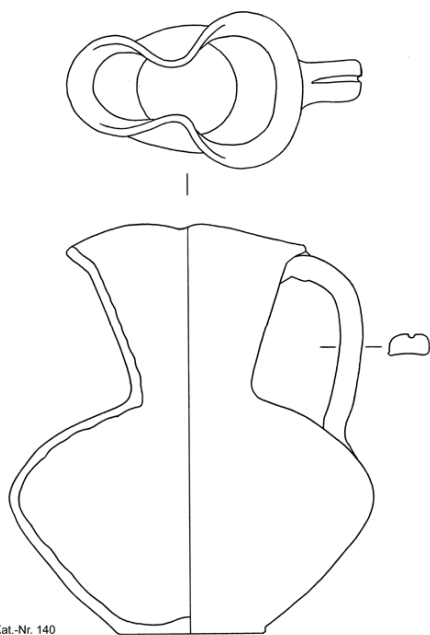

Kat.-Nr. 140

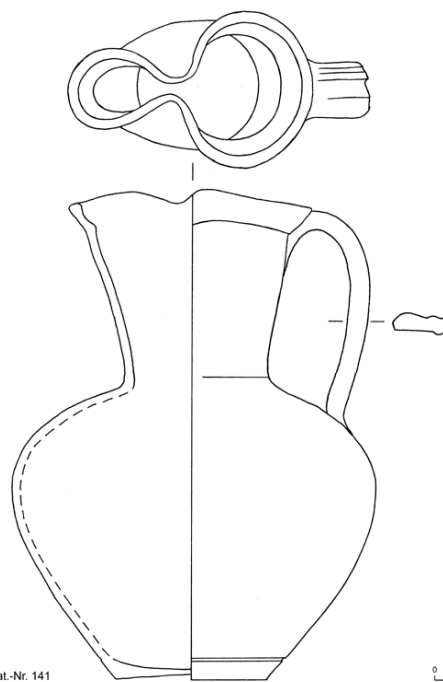

Kat.-Nr. 141

0 1
cm

Form O-3

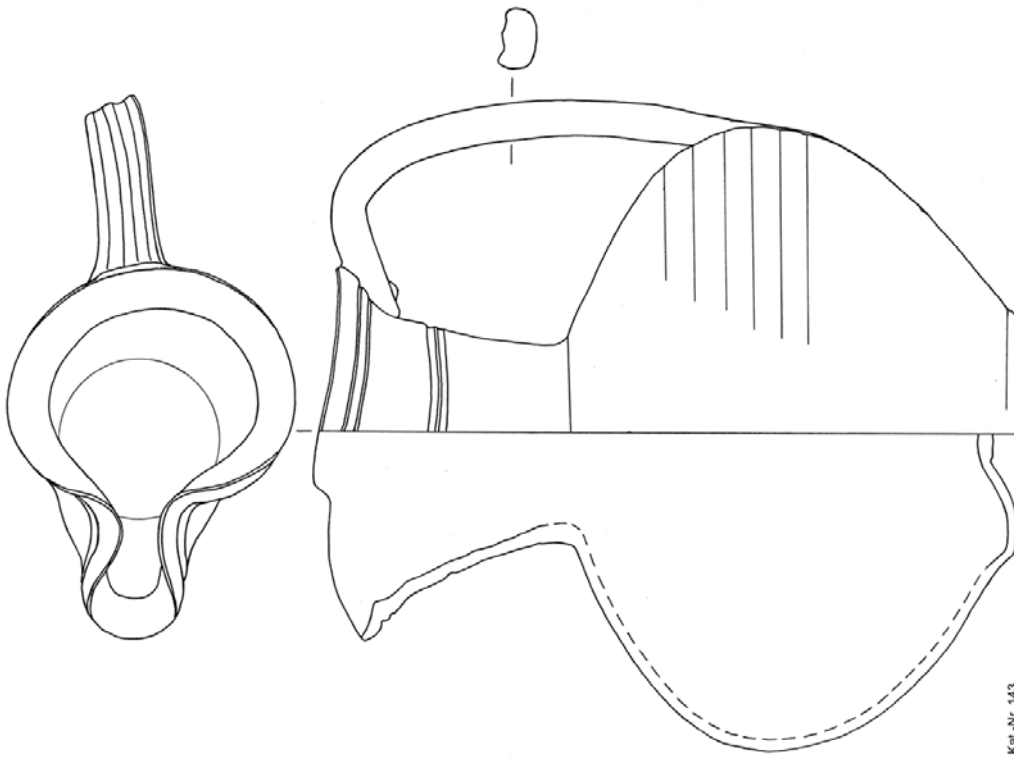

Kat.-Nr. 143

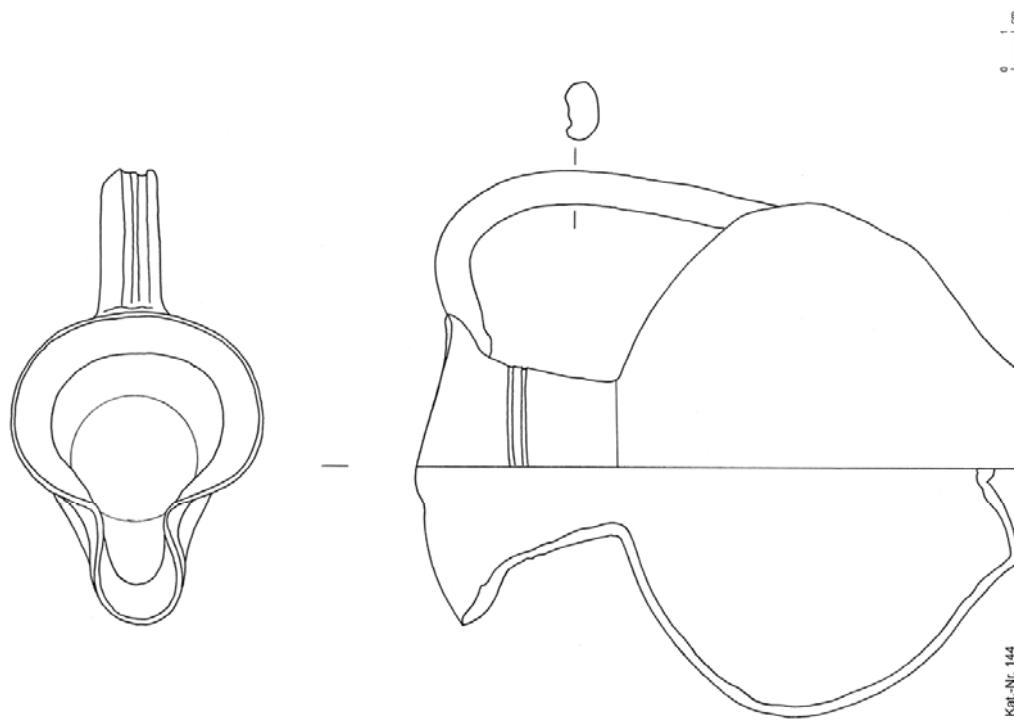

Kat.-Nr. 144

0 1 cm

Form G-1

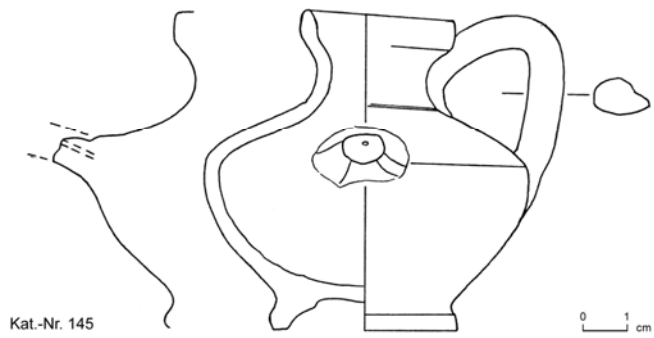

Form F-1

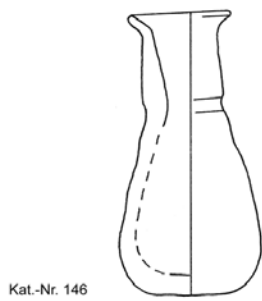

Form F-2

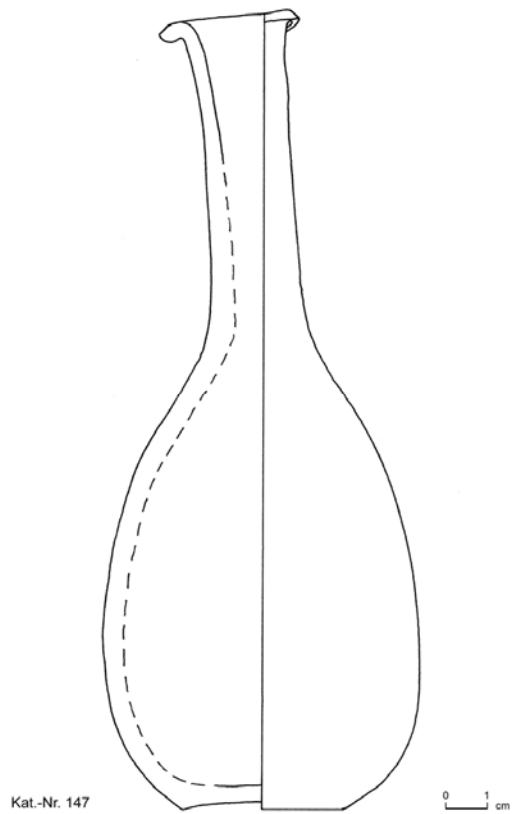

Form B-1 (Teil 1)

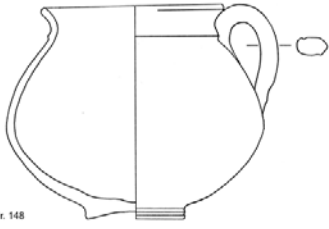

Kat.-Nr. 148

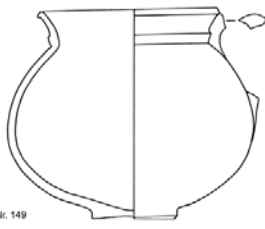

Kat.-Nr. 149

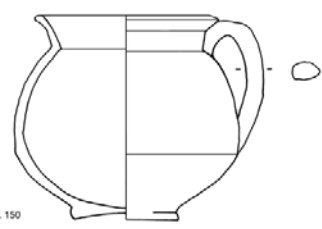

Kat.-Nr. 150

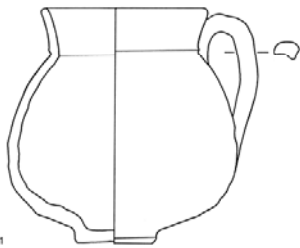

Kat.-Nr. 151

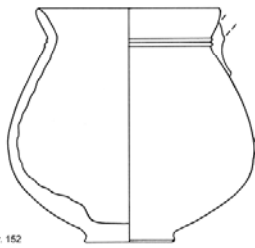

Kat.-Nr. 152



Kat.-Nr. 153

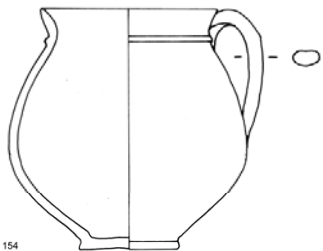

Kat.-Nr. 154



Kat.-Nr. 155



Kat.-Nr. 156

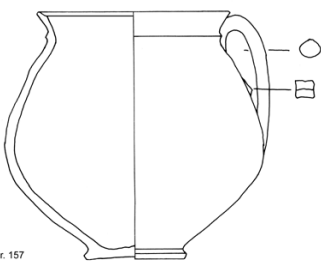

Kat.-Nr. 157

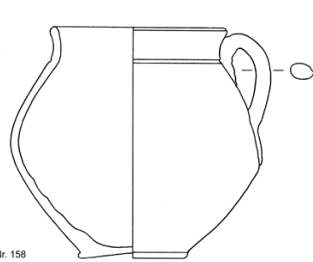

Kat.-Nr. 158

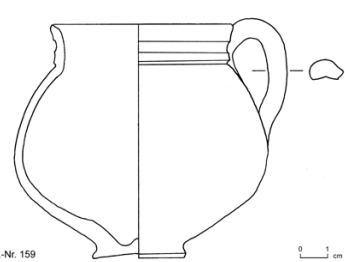

Kat.-Nr. 159

0 1 cm

Form B-1 (Teil 2)

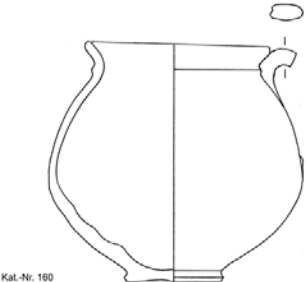

Kat.-Nr. 160

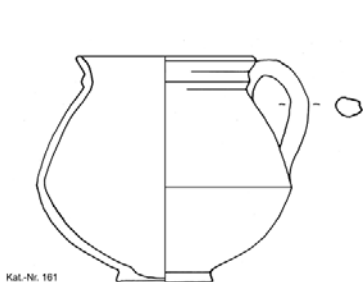

Kat.-Nr. 161



Kat.-Nr. 162

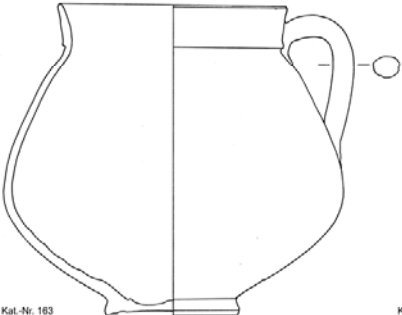

Kat.-Nr. 163



Kat.-Nr. 164



Kat.-Nr. 165



Kat.-Nr. 166



Kat.-Nr. 167



Kat.-Nr. 168

(2005)



Kat.-Nr. 358



Form B-2a

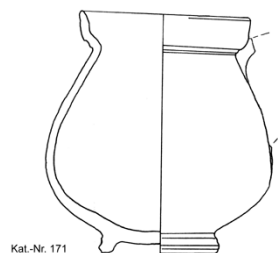
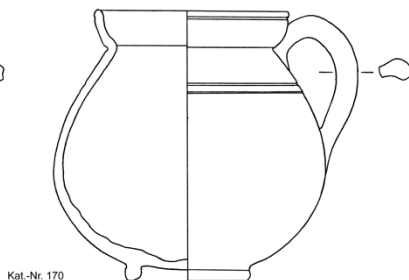
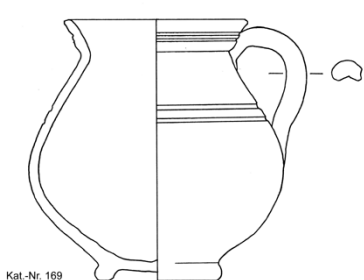

Form B-2b

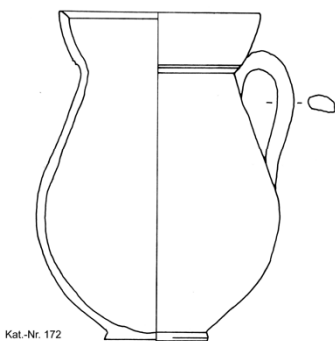

Form B-2c

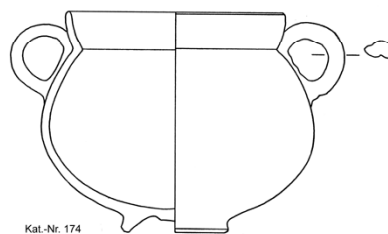
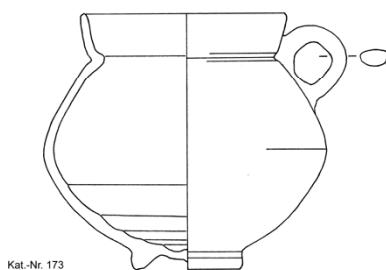

Form B-2d

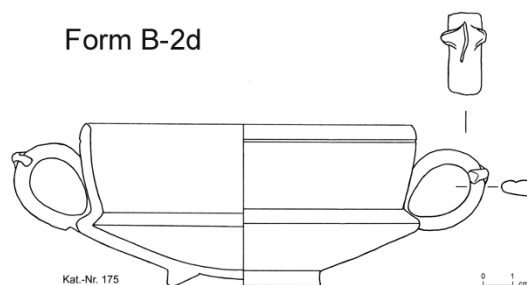

Form B-3a

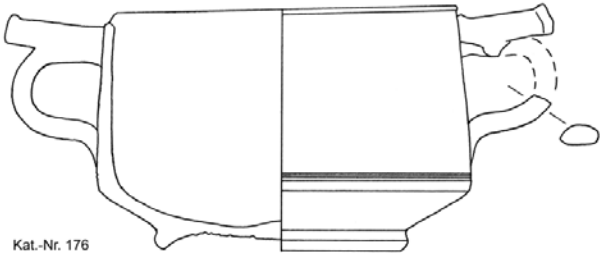

Kat.-Nr. 176



Form B-3b

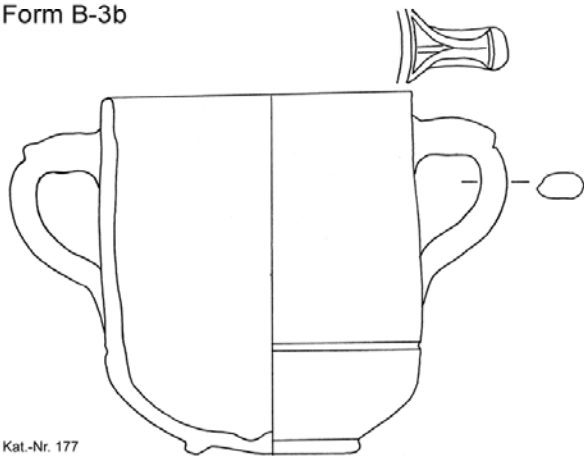

Kat.-Nr. 177

(2005)



Kat.-Nr. 359

Form B-4a

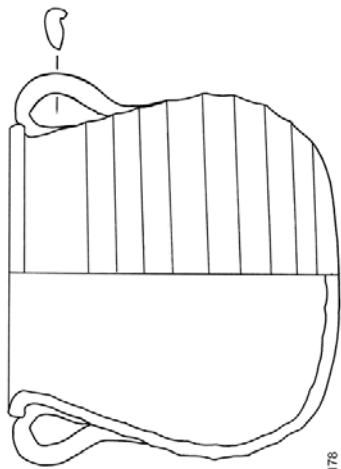

Kat.-Nr. 178

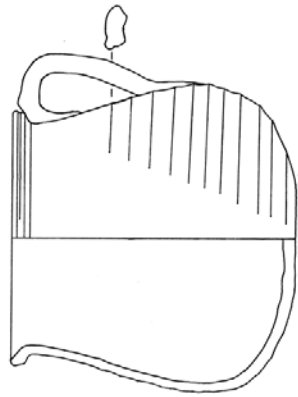

Kat.-Nr. 179

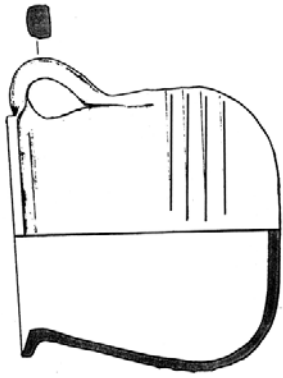

Kat.-Nr. 180

Form B-4b

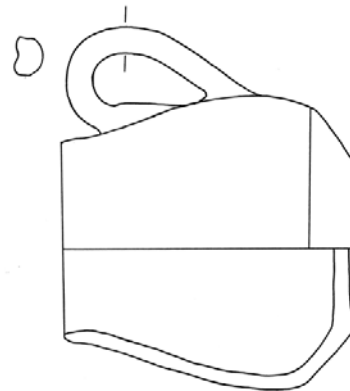

Kat.-Nr. 181

Form B-5a

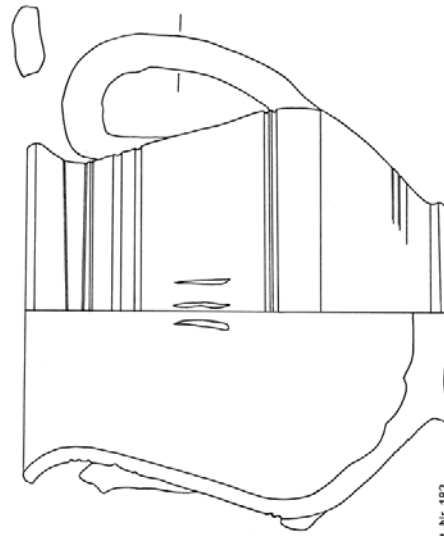

Kat.-Nr. 182

Form B-5b

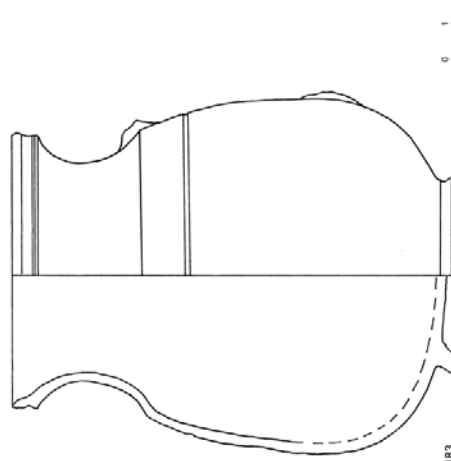

Kat.-Nr. 183

0 1 cm

Fragmente geschlossener Gefäße

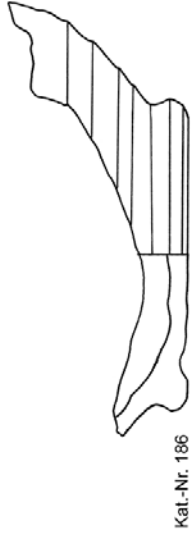
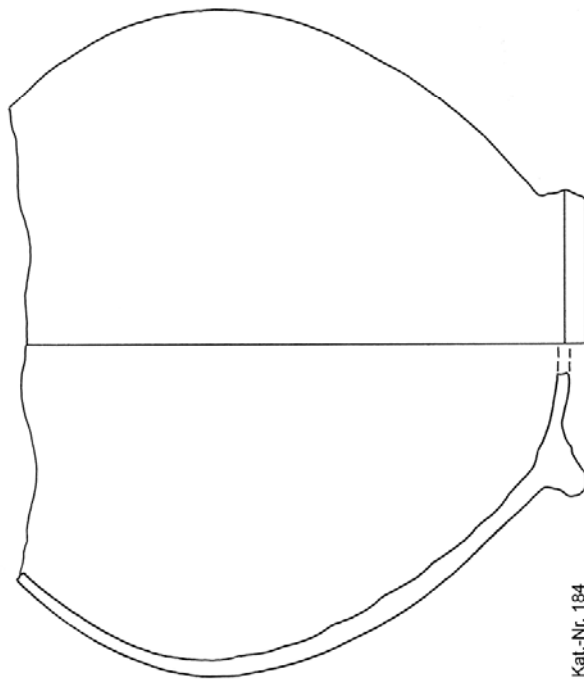

0 1 cm

Form N-1a

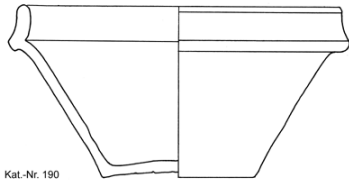

Kat.-Nr. 190

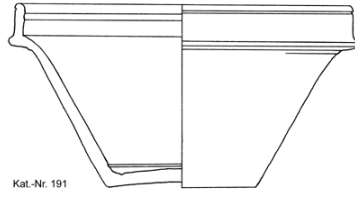

Kat.-Nr. 191

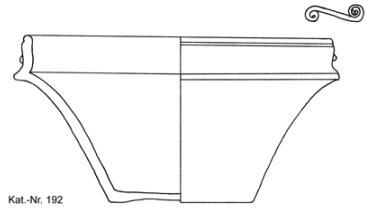

Kat.-Nr. 192

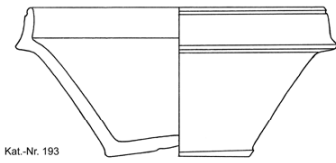

Kat.-Nr. 193

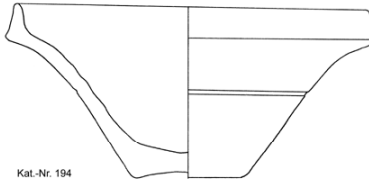

Kat.-Nr. 194

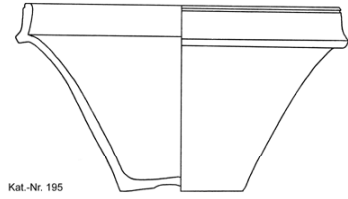

Kat.-Nr. 195

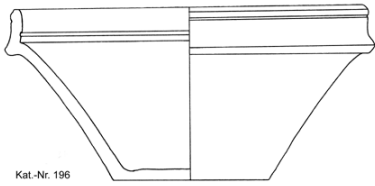

Kat.-Nr. 196

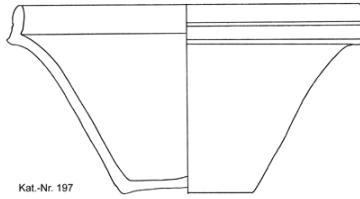

Kat.-Nr. 197

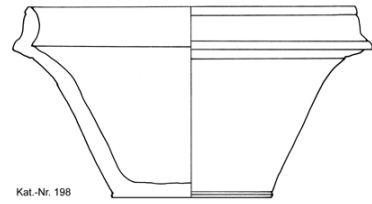

Kat.-Nr. 198

Form N-1b

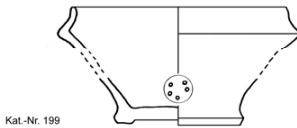

Kat.-Nr. 199

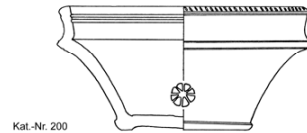

Kat.-Nr. 200

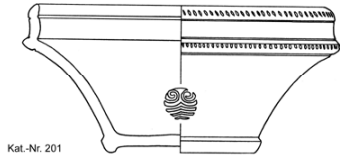

Kat.-Nr. 201

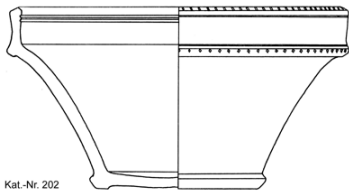

Kat.-Nr. 202

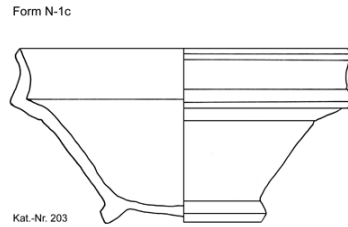

Form N-1c

Kat.-Nr. 203



EYA
7/7i

Form N-2a

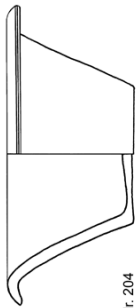

Kat.-Nr. 204

Form N-2b

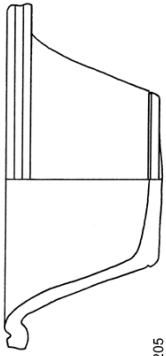

Kat.-Nr. 205



Form N-3a

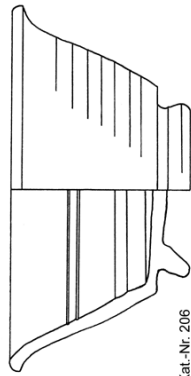

Kat.-Nr. 206

Form N-3b

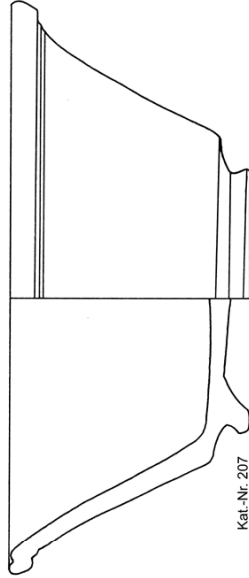

Kat.-Nr. 207

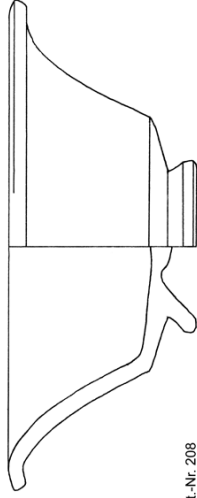

Kat.-Nr. 208

Form N-3c



Kat.-Nr. 209

Form N-4

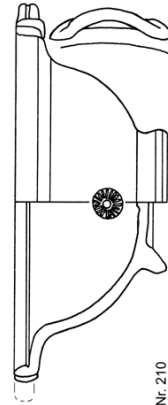

Kat.-Nr. 210

Form N-5

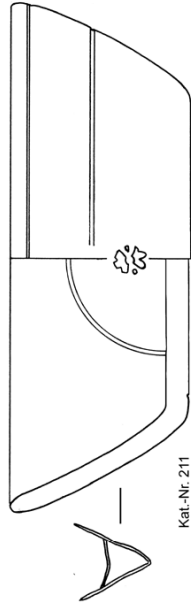

Kat.-Nr. 211

Form S-1a

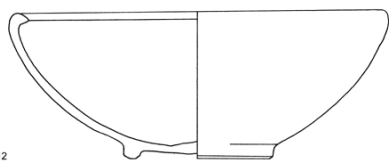

Kat.-Nr. 212

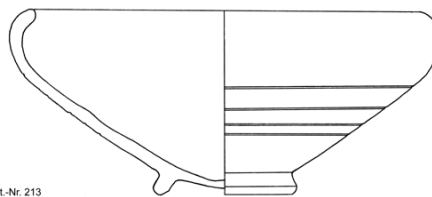

Kat.-Nr. 213

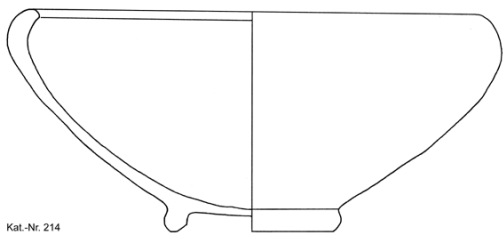

Kat.-Nr. 214

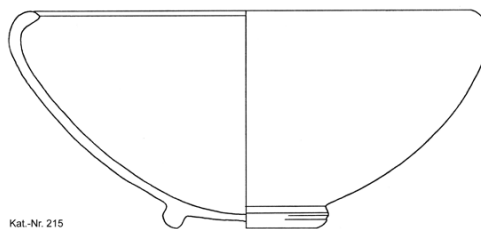

Kat.-Nr. 215

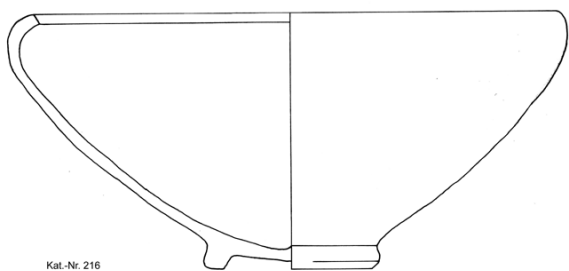

Kat.-Nr. 216

Form S-1b

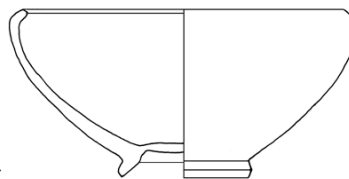

Kat.-Nr. 217

Form S-1c

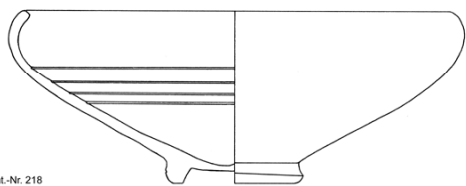

Kat.-Nr. 218

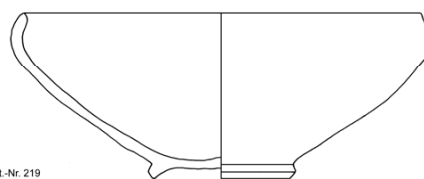

Kat.-Nr. 219

(2005)



Kat.-Nr. 360

0 1 cm

Form S-1d

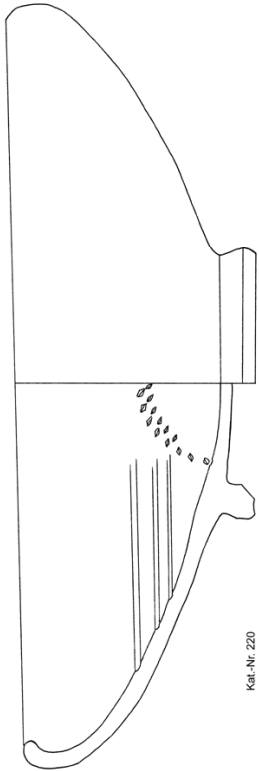

Kalt-Nr. 220

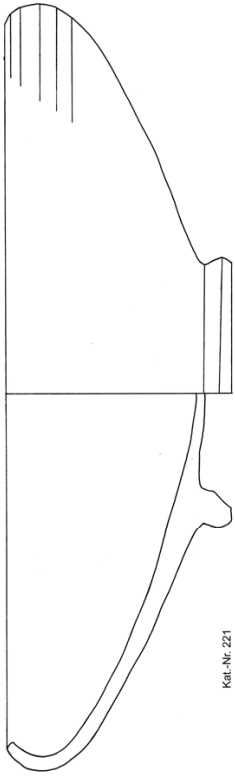

Kalt-Nr. 221

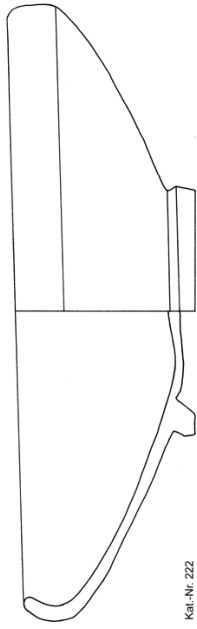

Kalt-Nr. 222

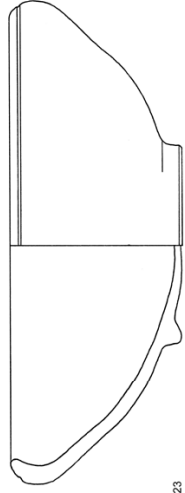

Kalt-Nr. 223

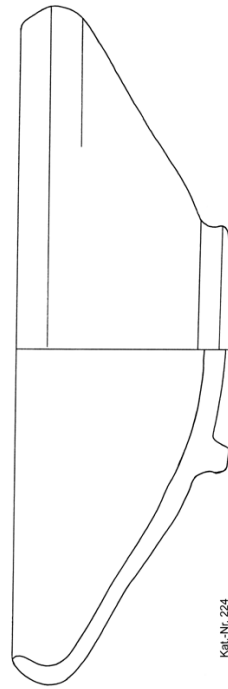

Kalt-Nr. 224



Form S-1e

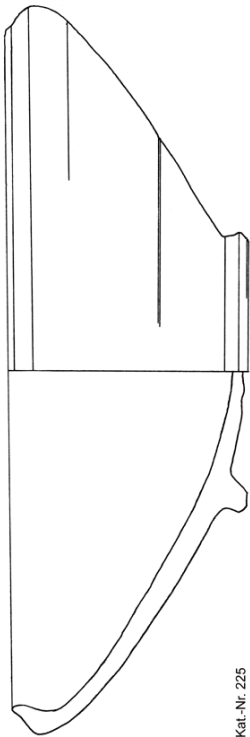

Kat.-Nr. 225

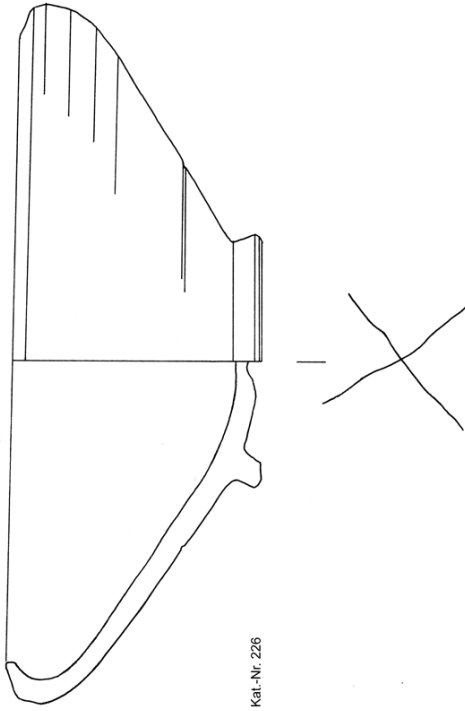

Kat.-Nr. 226

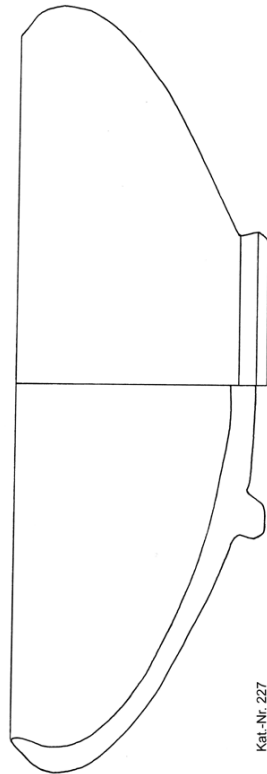

Kat.-Nr. 227

(2005)



Kat.-Nr. 361

Form S-2

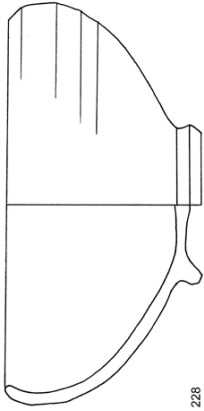

Kat.-Nr. 228

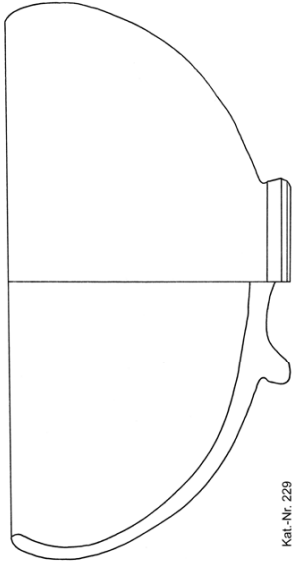

Kat.-Nr. 229

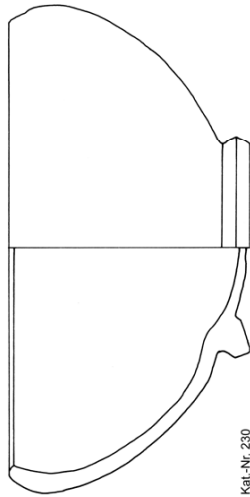

Kat.-Nr. 230

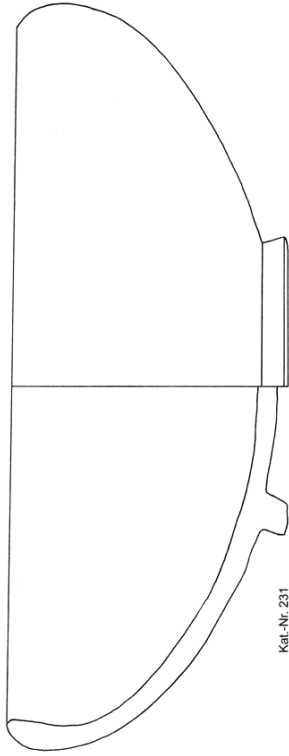

Kat.-Nr. 231

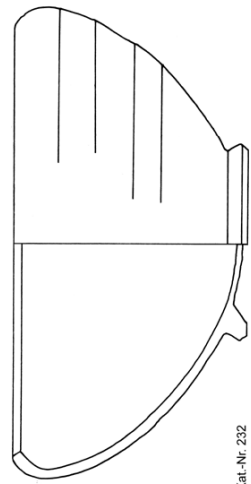

Kat.-Nr. 232

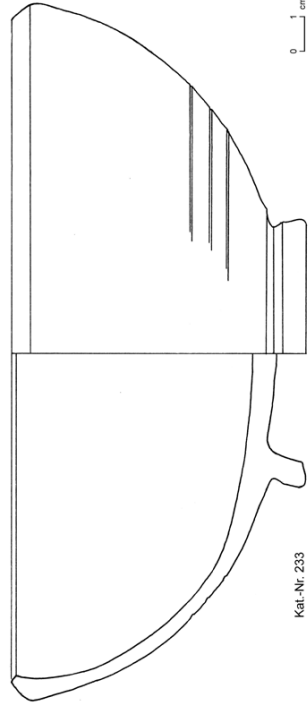

Kat.-Nr. 233

0 1 cm

Form S-3a

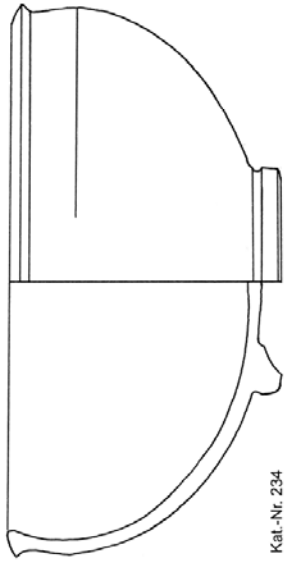

Kat.-Nr. 234

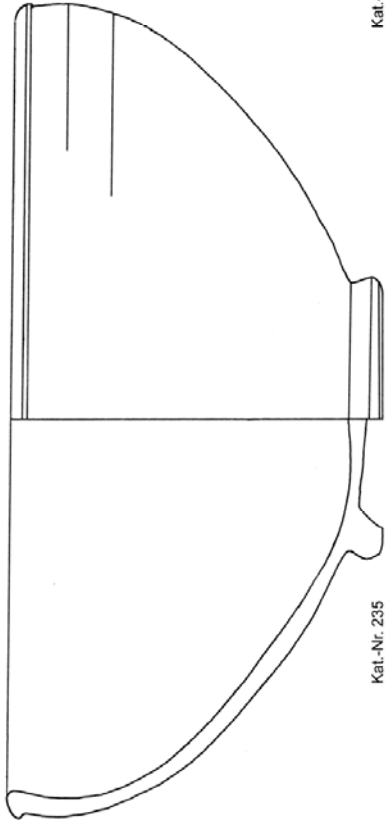

Kat.-Nr. 235

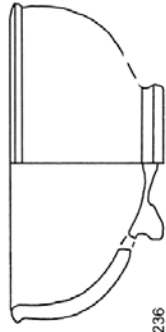

Kat.-Nr. 236

Form S-3b

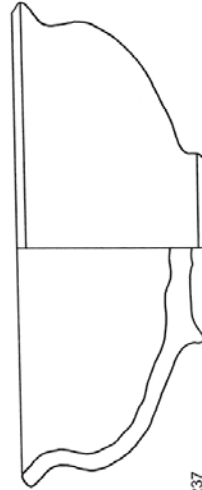

Kat.-Nr. 237

Form S-3c

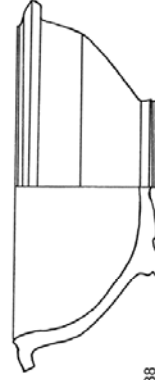

Kat.-Nr. 238



Form S-4a

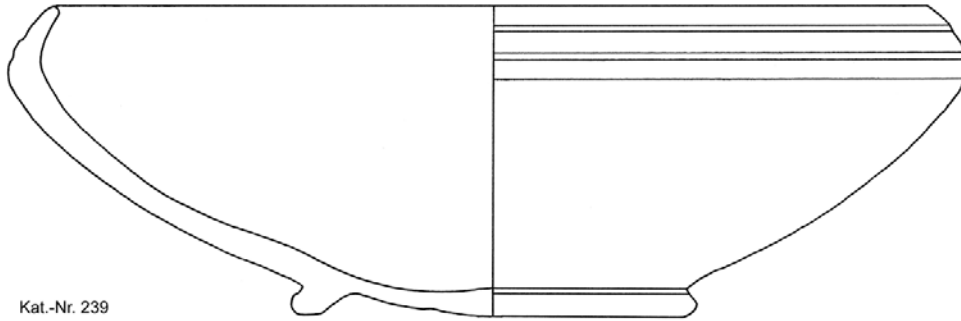

Kat.-Nr. 239

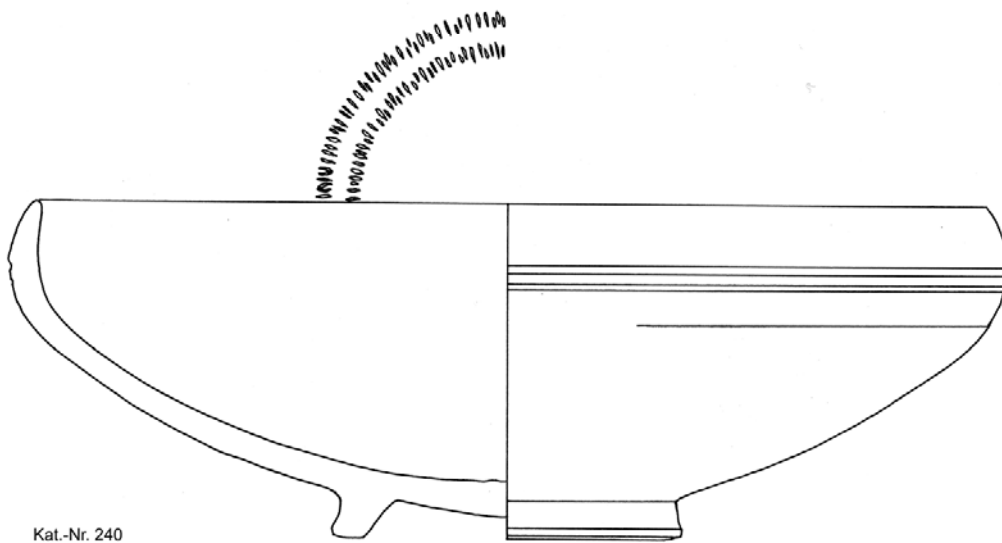

Kat.-Nr. 240

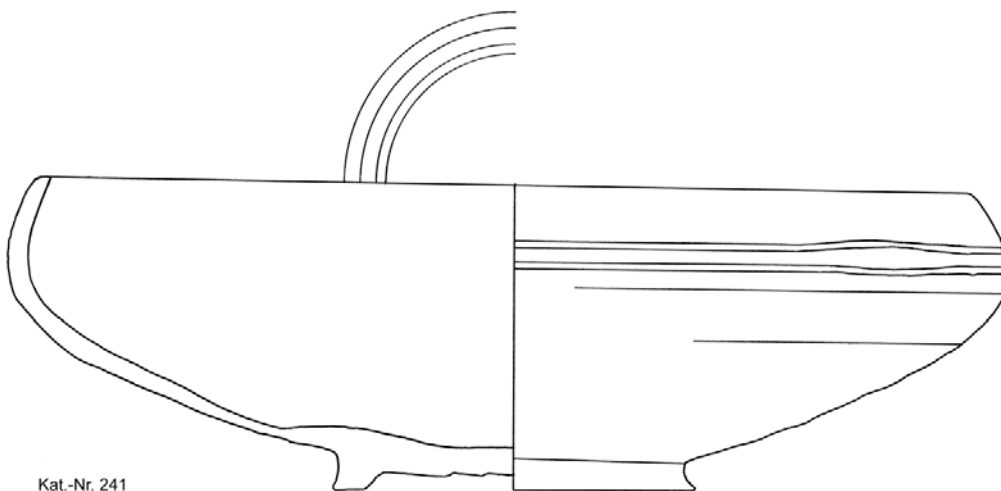

Kat.-Nr. 241

0 1 cm

Form S-4b

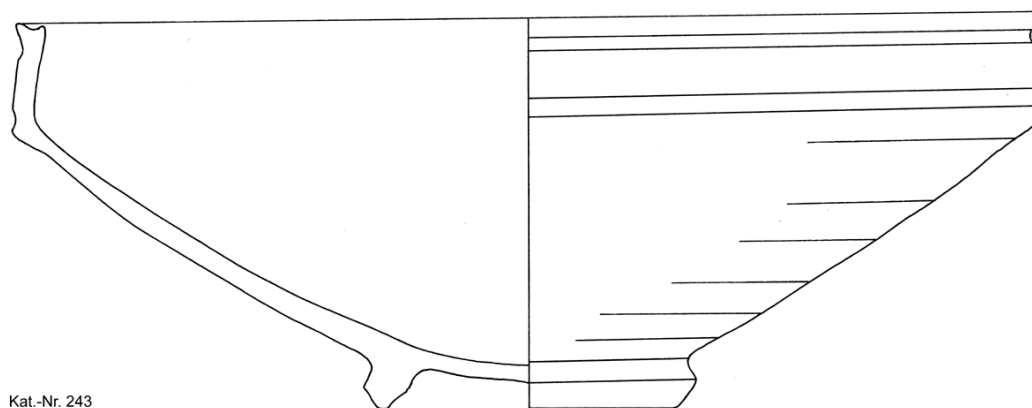
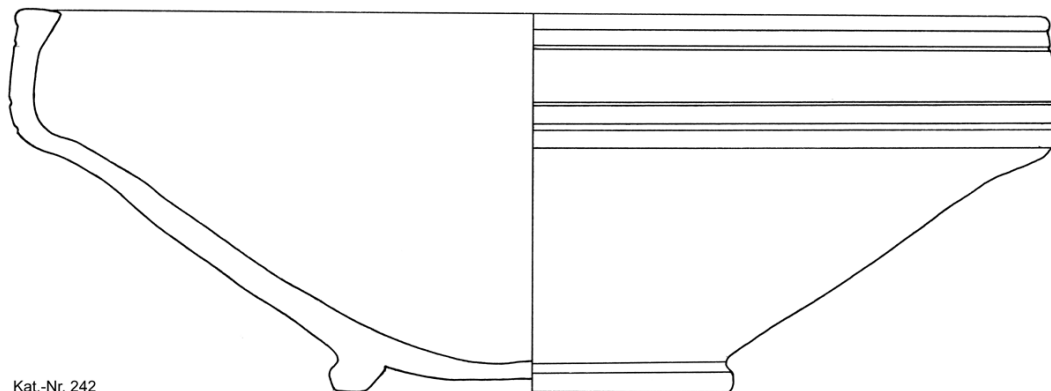

Form S-4c

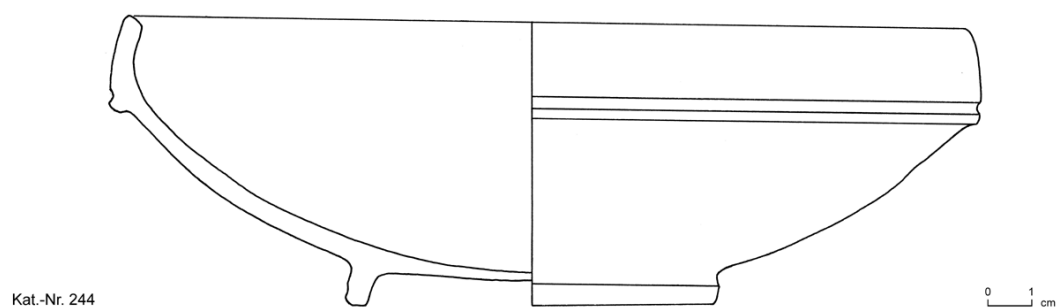

Form S-5a

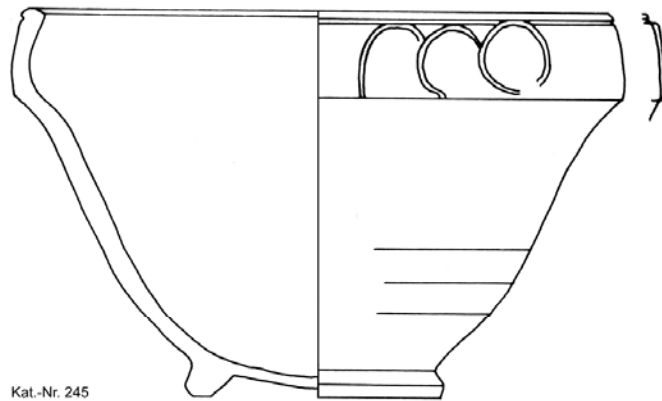

Kat.-Nr. 245

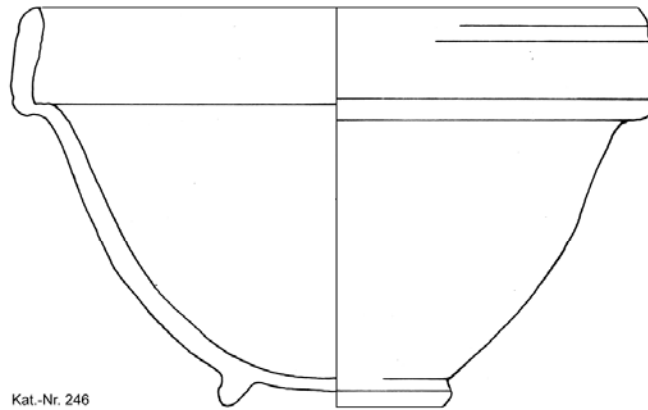

Kat.-Nr. 246

Form S-5b

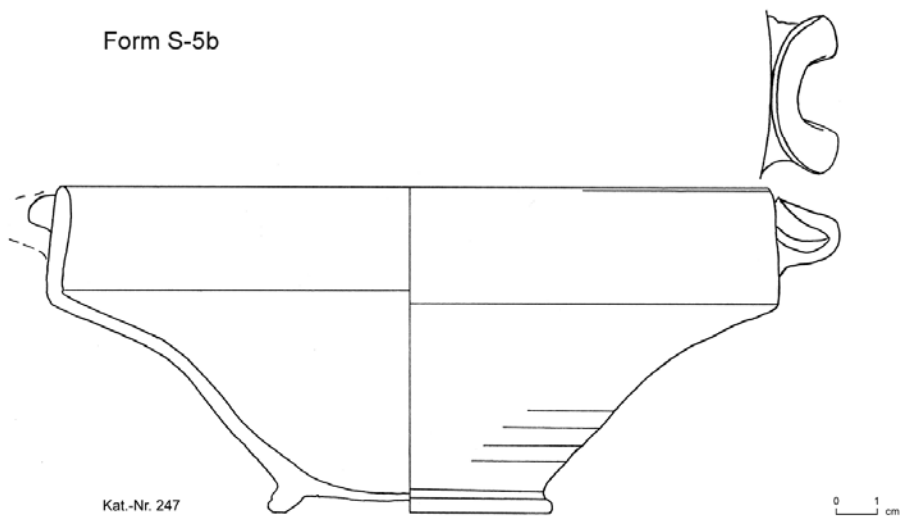

Kat.-Nr. 247

0 1 cm

Form S-7

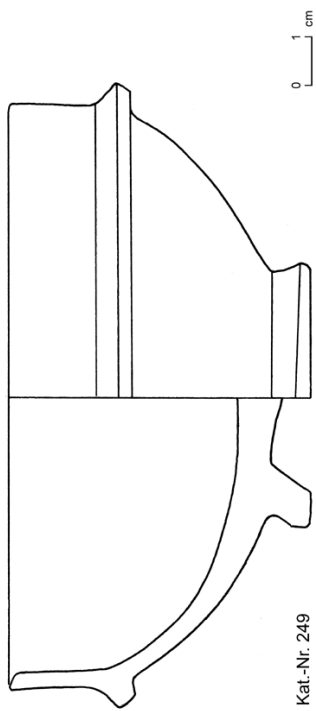

Kat.-Nr. 249

Form S-6

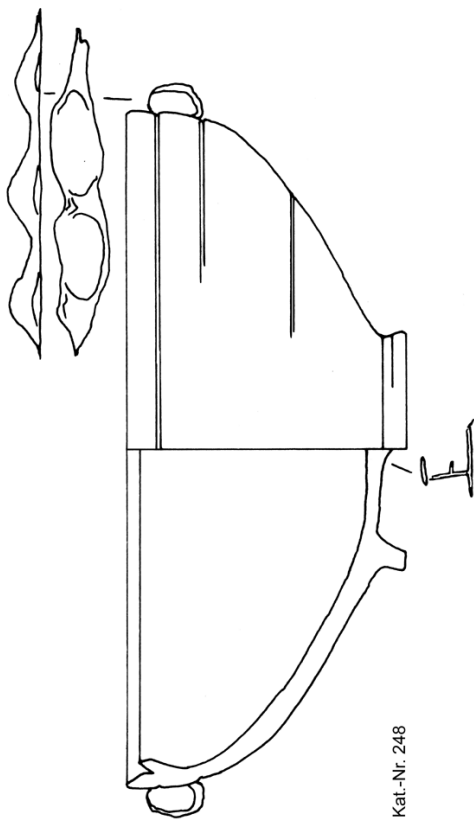

Kat.-Nr. 248

Form T-1a-l

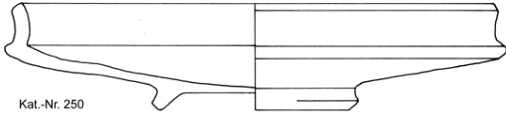

Kat.-Nr. 250

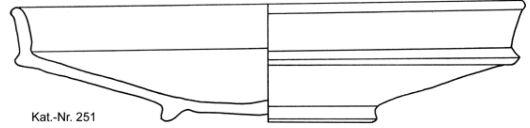

Kat.-Nr. 251

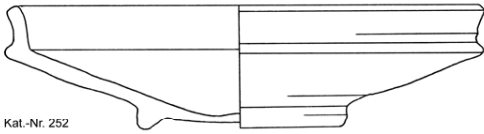

Kat.-Nr. 252

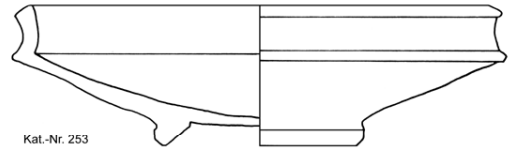

Kat.-Nr. 253

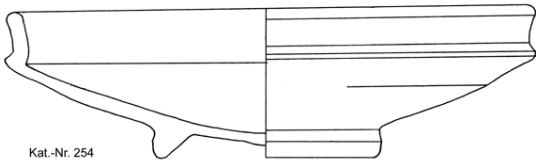

Kat.-Nr. 254

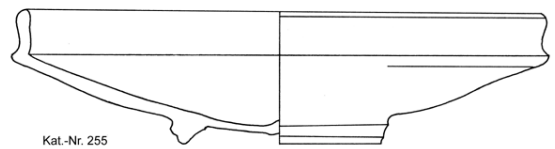

Kat.-Nr. 255

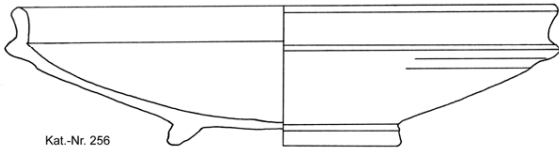

Kat.-Nr. 256

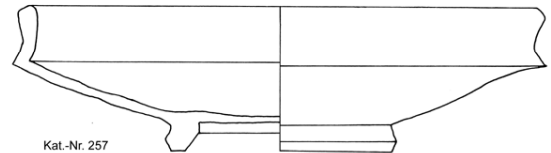

Kat.-Nr. 257

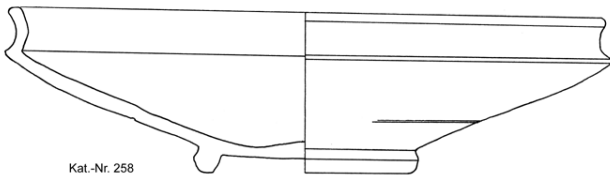

Kat.-Nr. 258

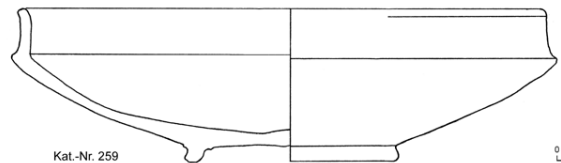

Kat.-Nr. 259

0 1 cm

Form T-1a-II

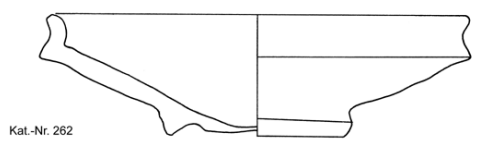
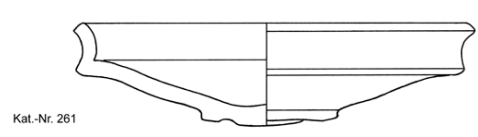
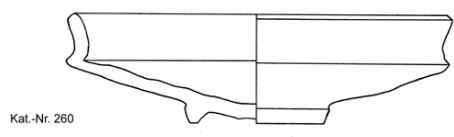

Form T-1a-III

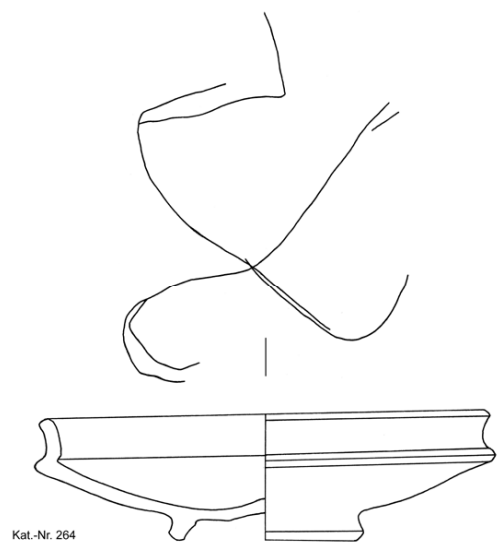
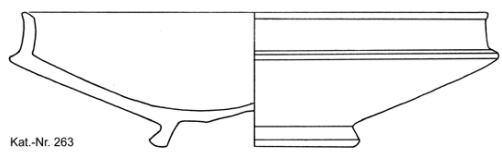

Form T-1a-IV

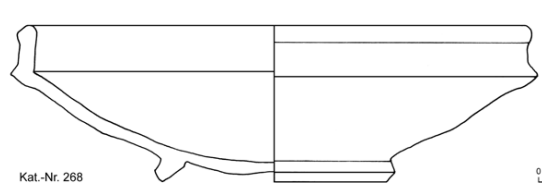
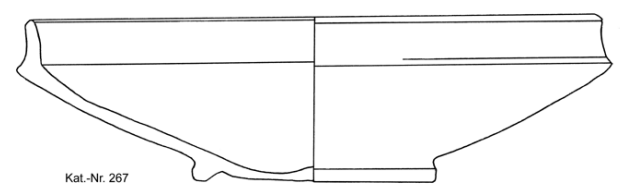
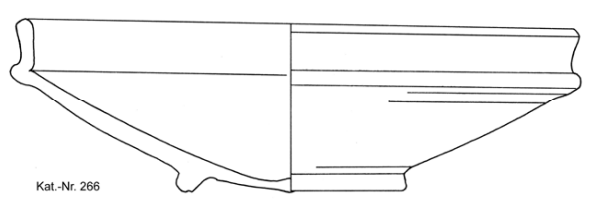
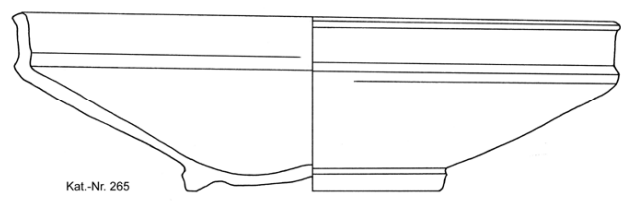

0 1 cm

Form T-1a-V

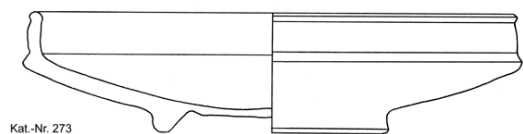
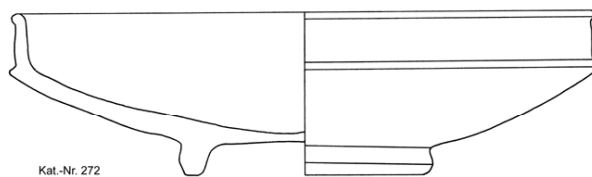
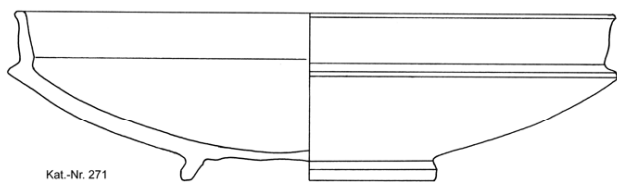
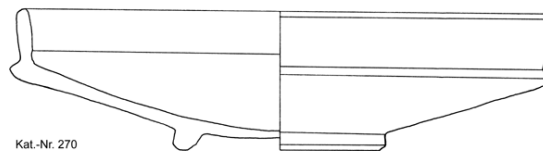

Form T-1a-VI



T-1a-VII

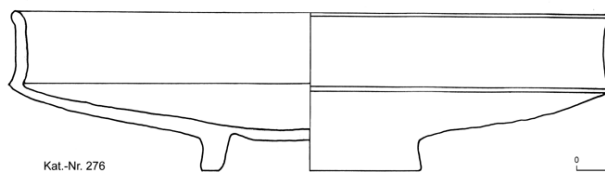

0 1 cm

Form T-1b-I

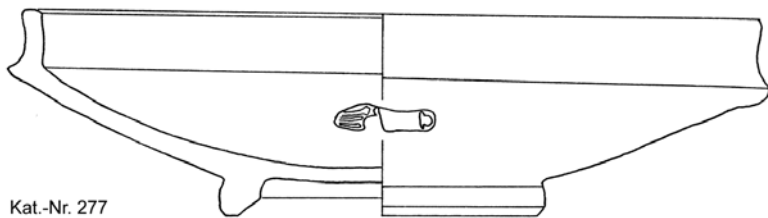

Kat.-Nr. 277

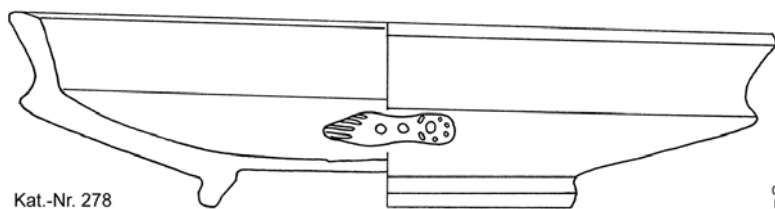

Kat.-Nr. 278

0 1 cm

Form T-1b-II (Teil 1)

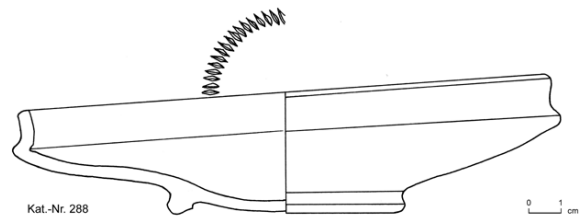
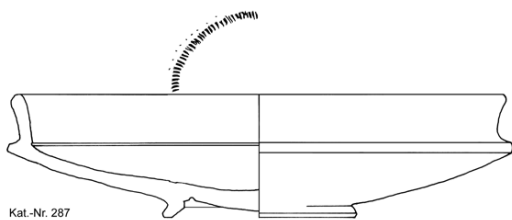
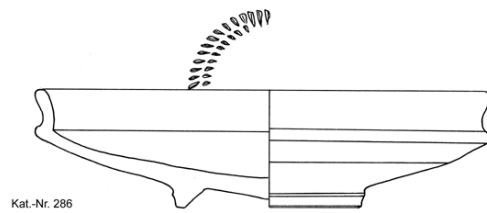
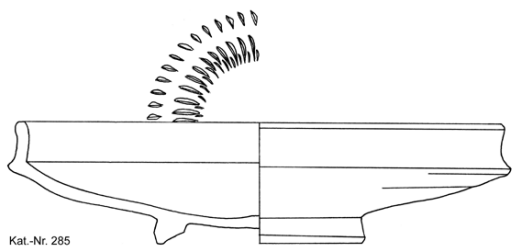
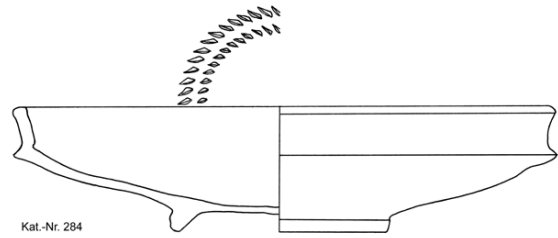
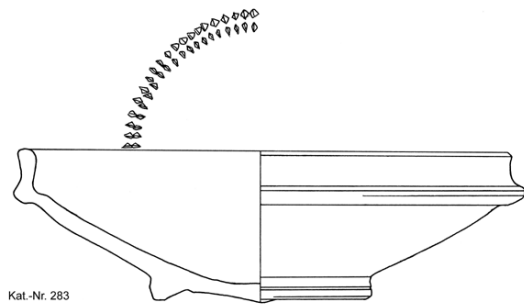
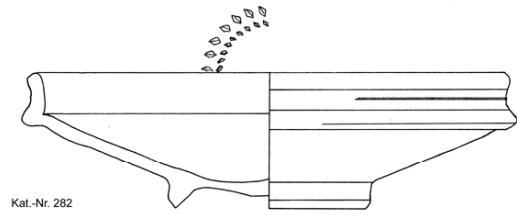
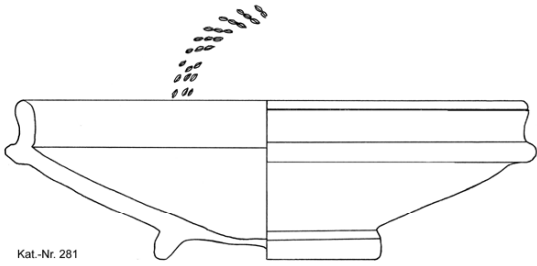
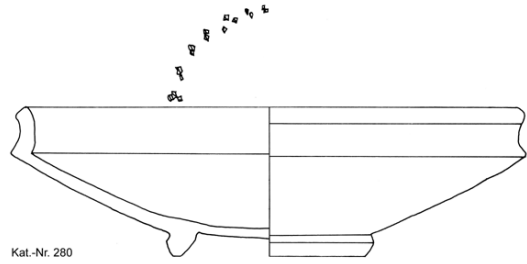
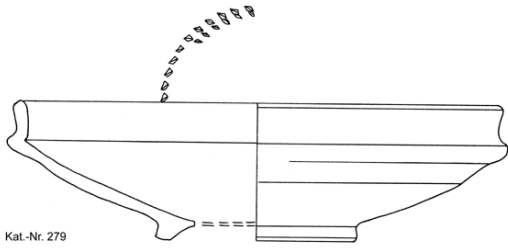

Form T-1b-II (Teil 2)

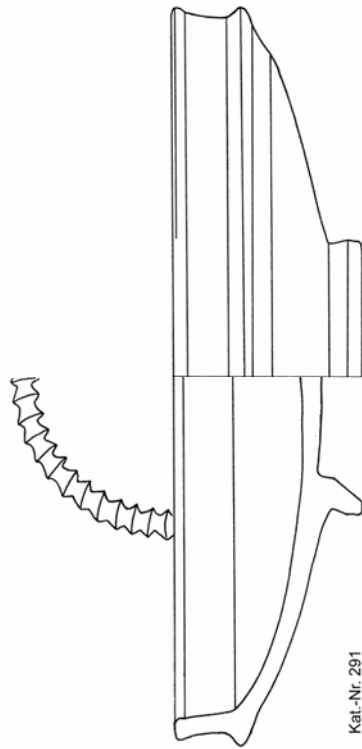
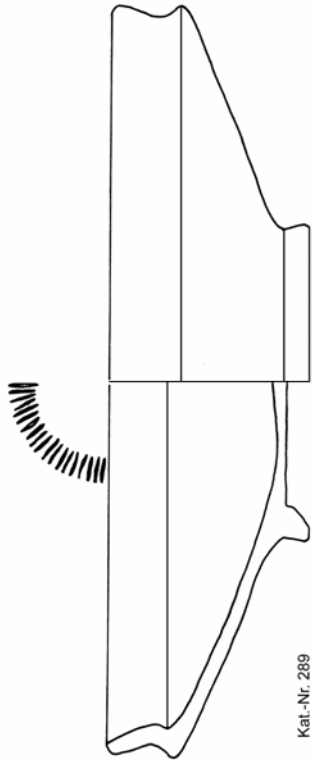
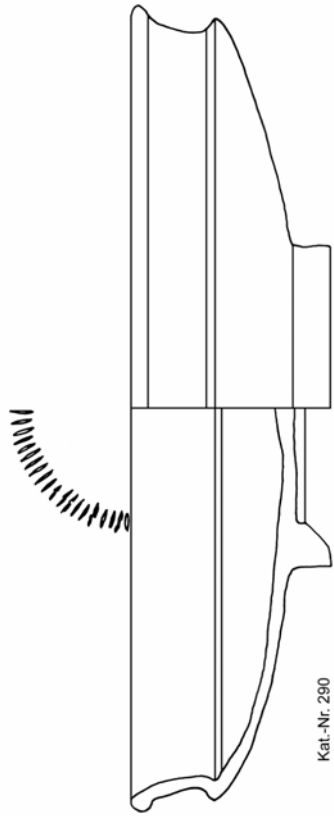

0 1 cm

T-1b-III (Teil 1)

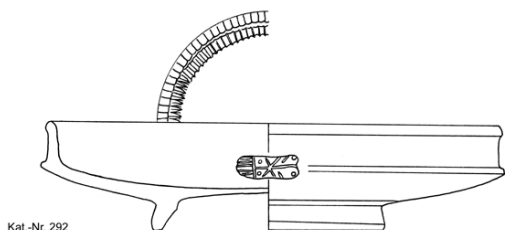

Kat.-Nr. 292

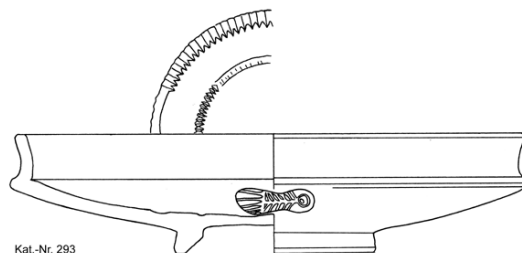

Kat.-Nr. 293

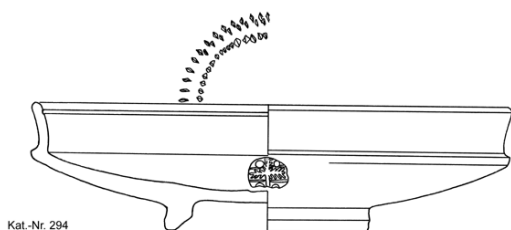

Kat.-Nr. 294

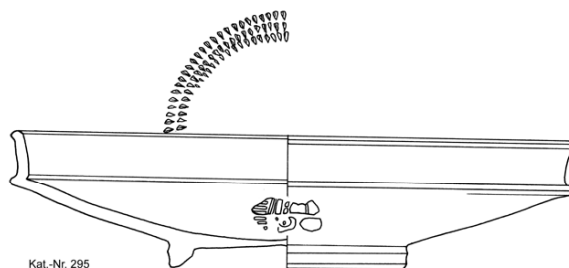

Kat.-Nr. 295

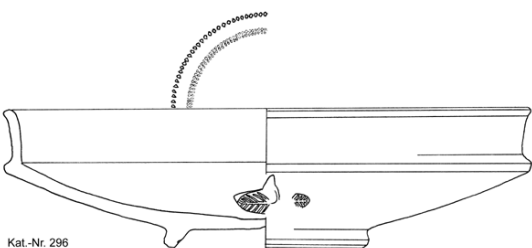

Kat.-Nr. 296

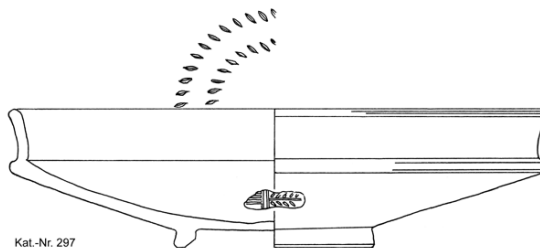

Kat.-Nr. 297

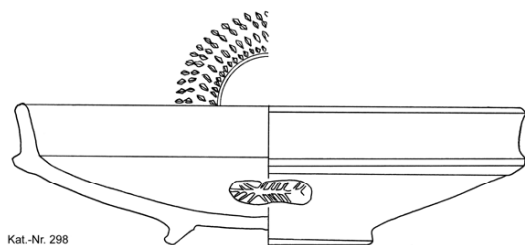

Kat.-Nr. 298

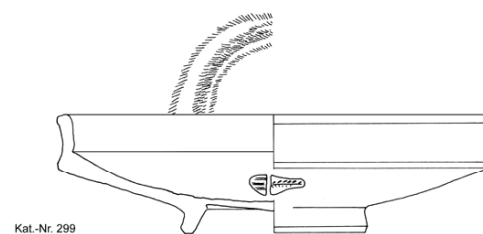

Kat.-Nr. 299

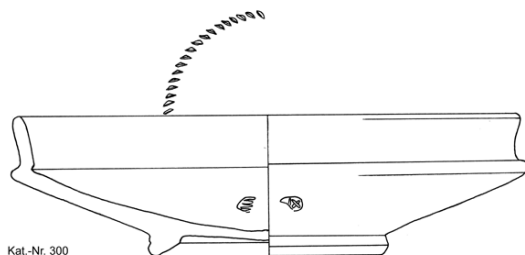

Kat.-Nr. 300

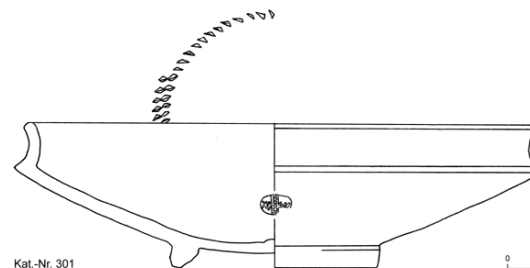

Kat.-Nr. 301

0 1 cm

Form T-1b-III (Teil 2)

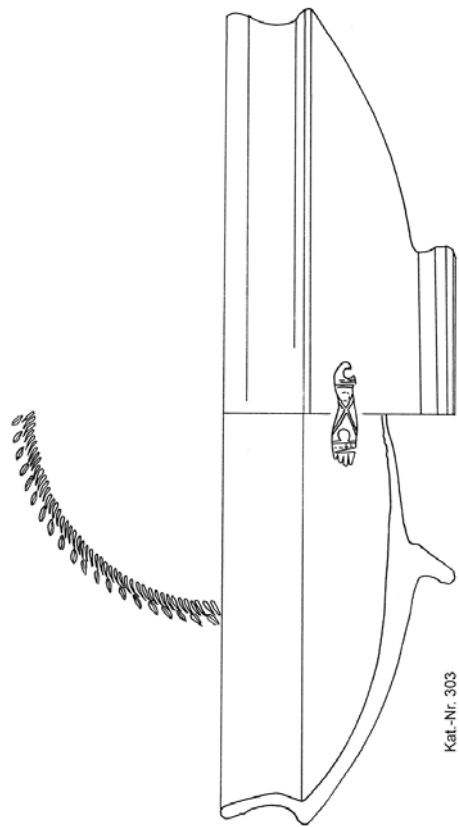

Kat.-Nr. 303

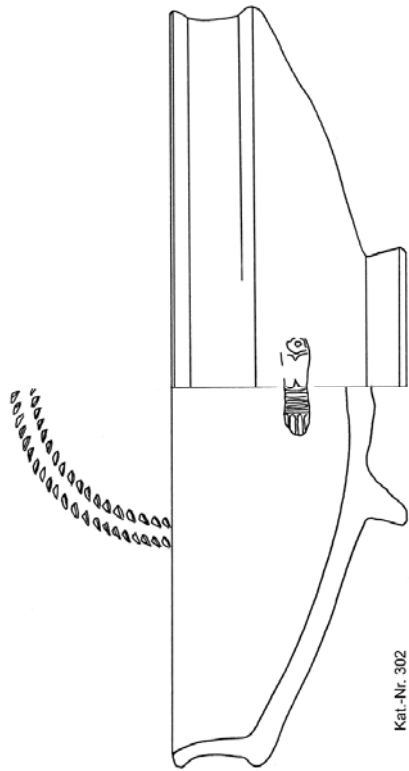

Kat.-Nr. 302

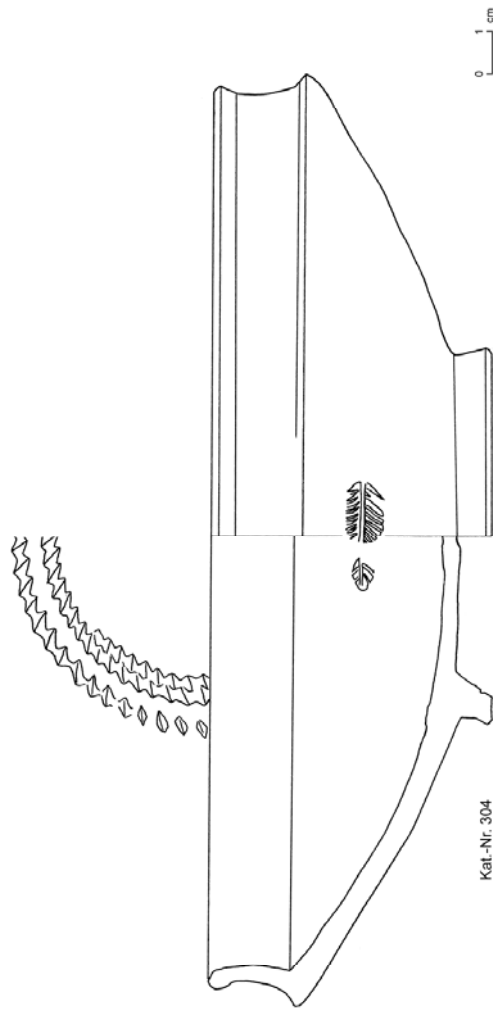

Kat.-Nr. 304

0 1 cm

Form T-1b-IV

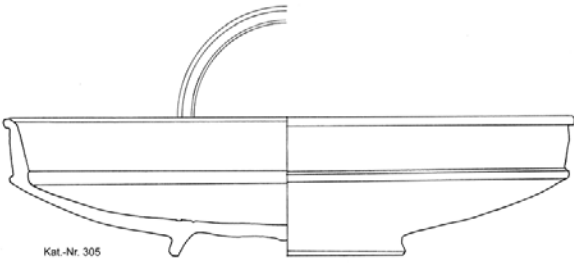

Kat.-Nr. 305

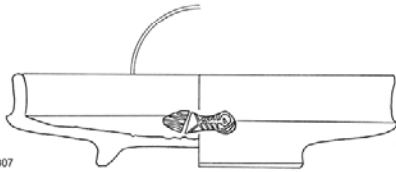

Kat.-Nr. 307

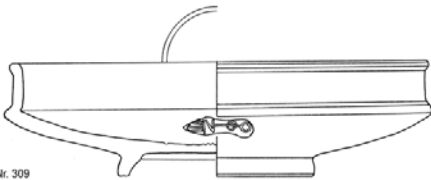

Kat.-Nr. 309

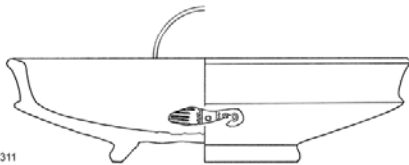

Kat.-Nr. 311

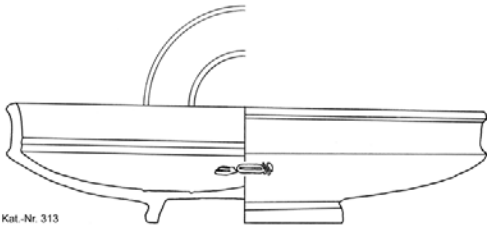

Kat.-Nr. 313

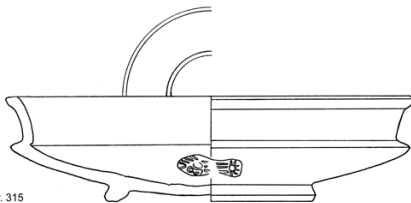

Kat.-Nr. 315

Form T-1b-V

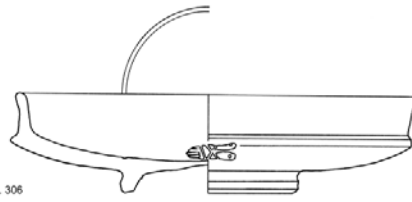

Kat.-Nr. 306

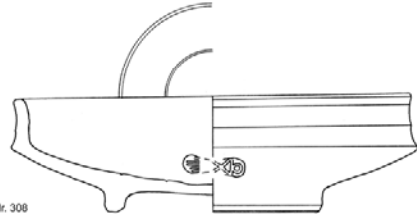

Kat.-Nr. 308

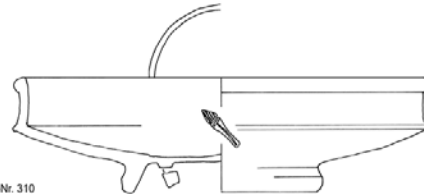

Kat.-Nr. 310

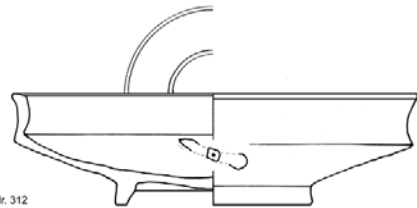

Kat.-Nr. 312

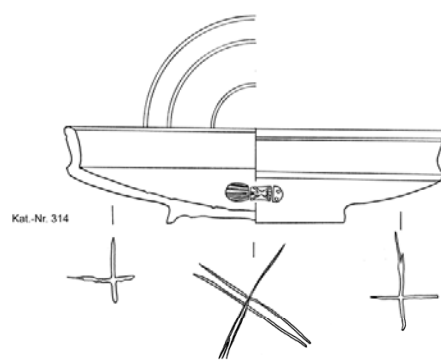

Kat.-Nr. 314

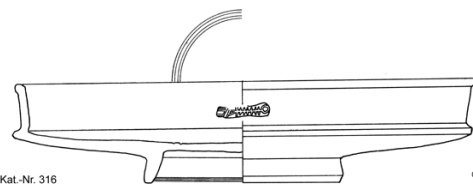

Kat.-Nr. 316

0 1 cm

Form T-2a

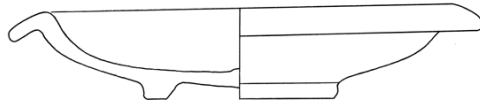

Kat.-Nr. 317

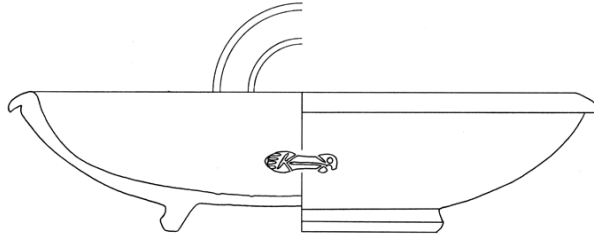

Kat.-Nr. 318

Form T-2b

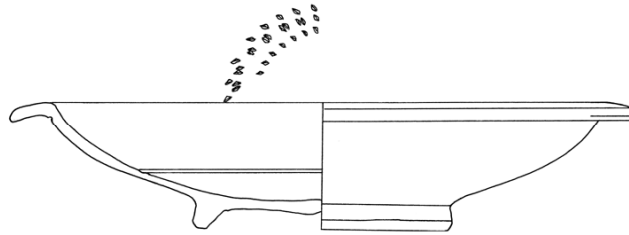

Kat.-Nr. 319

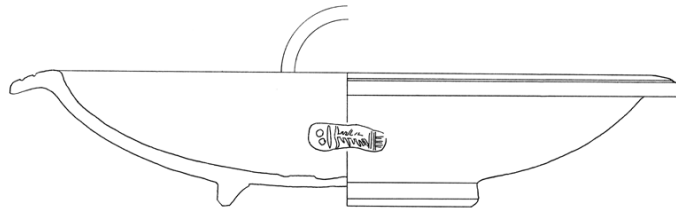

Kat.-Nr. 320

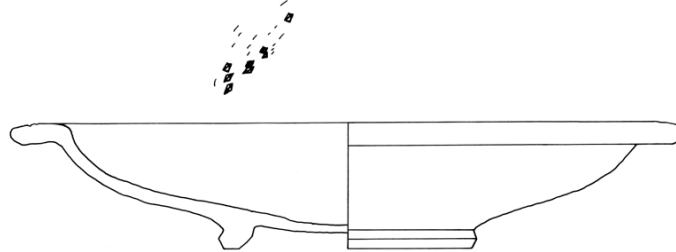

Kat.-Nr. 321

Form T-2c

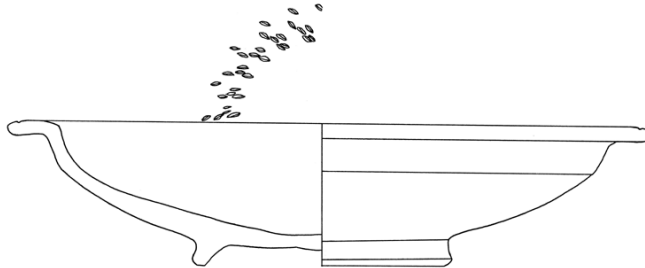

Kat.-Nr. 322

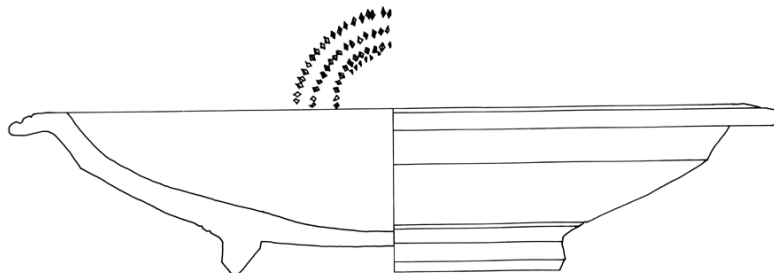

Kat.-Nr. 323

0 1 cm

Form T-3

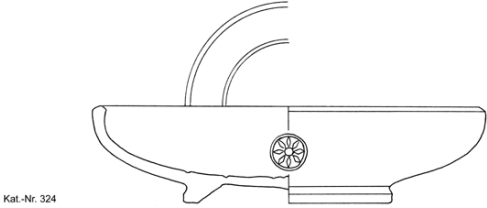

Kat.-Nr. 324

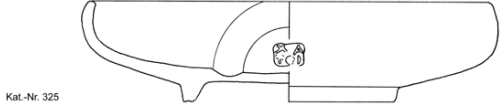

Kat.-Nr. 325

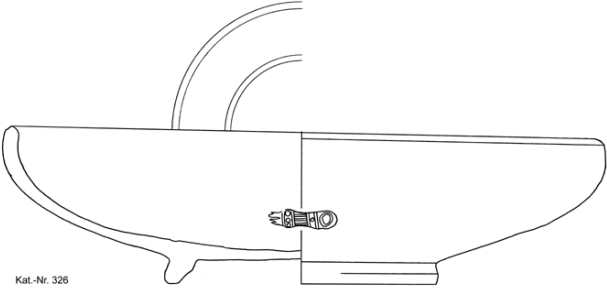

Kat.-Nr. 326

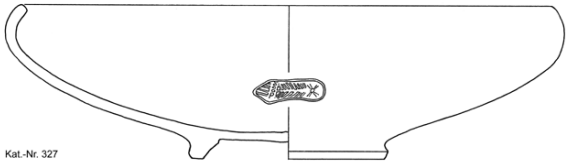

Kat.-Nr. 327

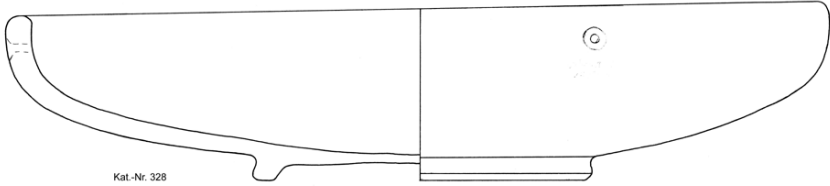

Kat.-Nr. 328

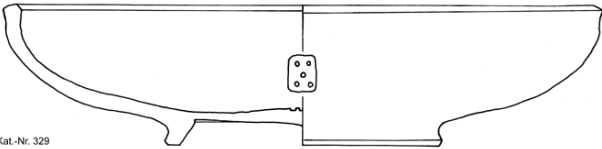

Kat.-Nr. 329

0 1 cm

Form T-4a



Kat.-Nr. 330

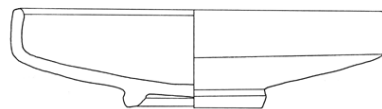

Kat.-Nr. 331

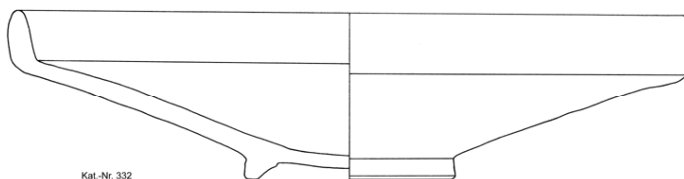

Kat.-Nr. 332

Form T-4b

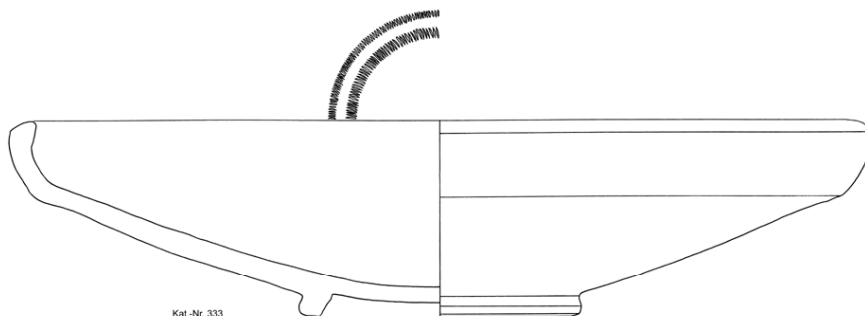

Kat.-Nr. 333

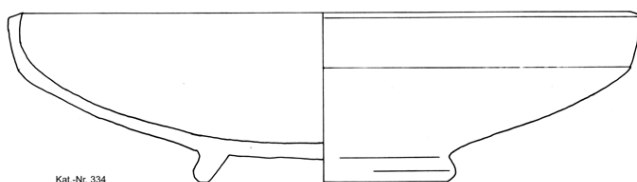

Kat.-Nr. 334

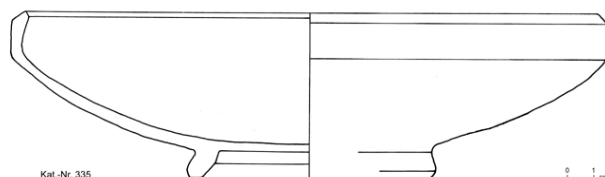

Kat.-Nr. 335

0 1 cm

Form T-5

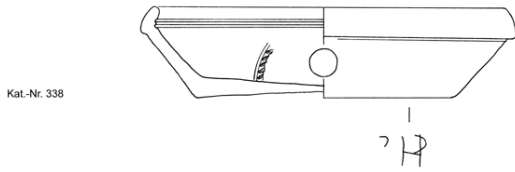
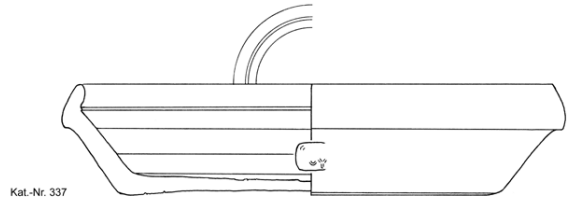
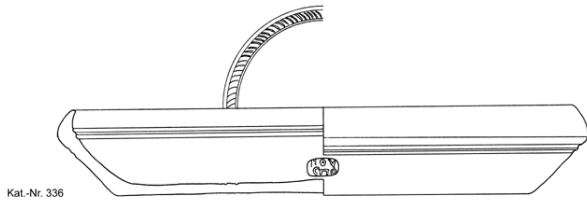

Form T-6

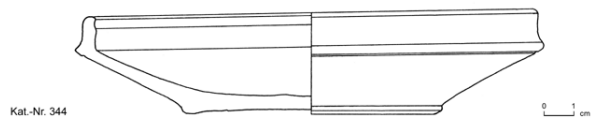
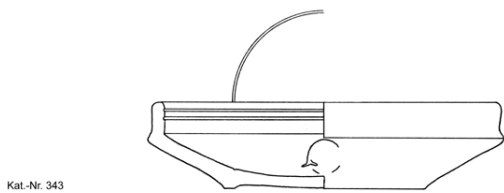
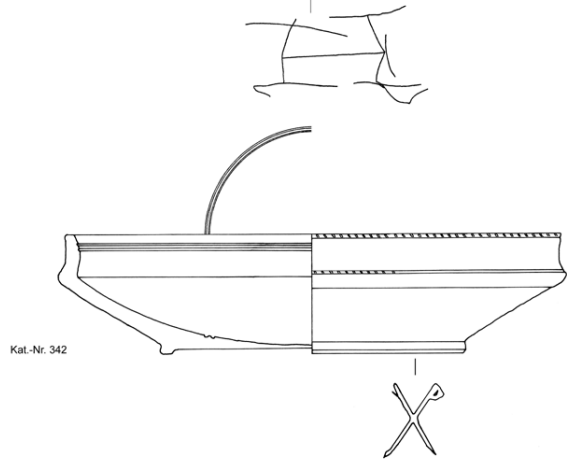
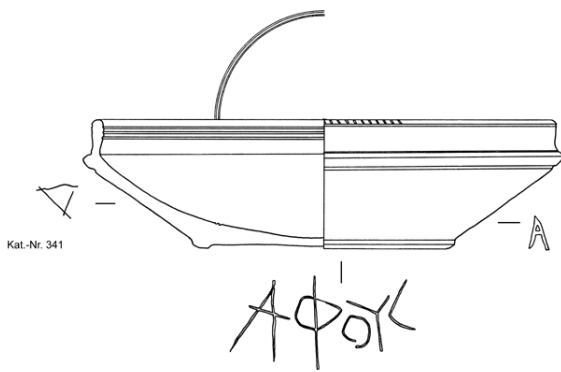
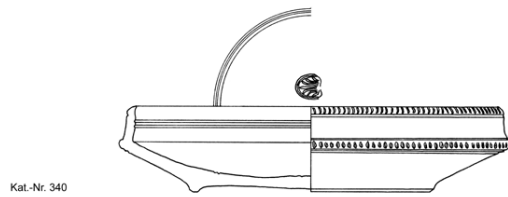
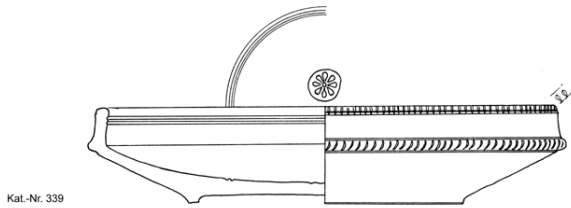

Form T-7

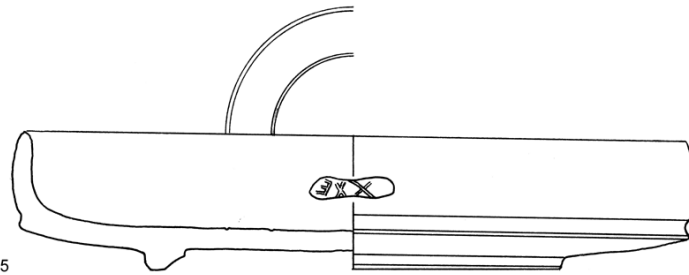

Kat.-Nr. 345

Form T-8

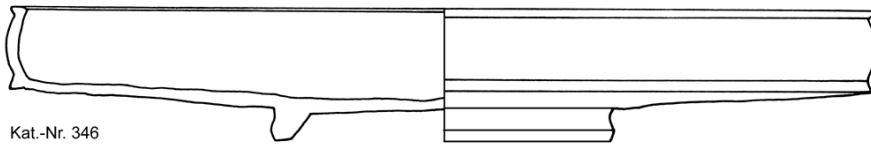

Kat.-Nr. 346

Form T-9

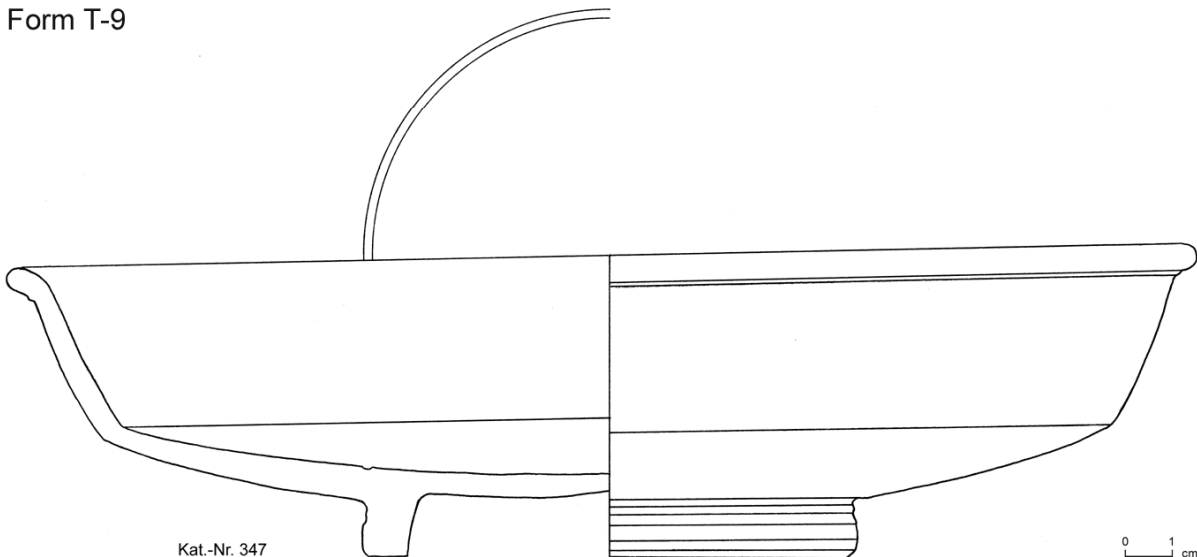

Kat.-Nr. 347

0 1 cm

Platten

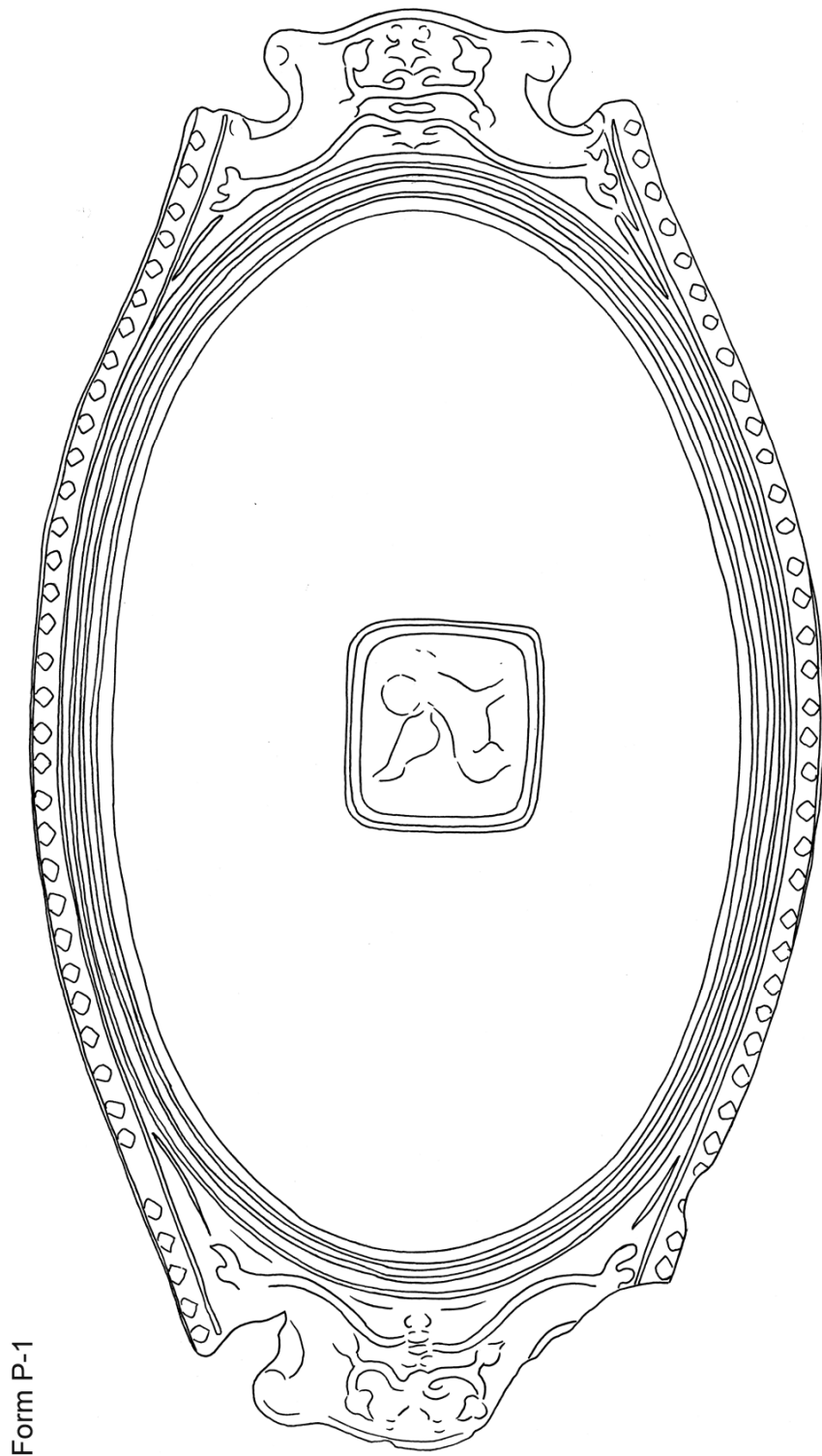

Form P-1

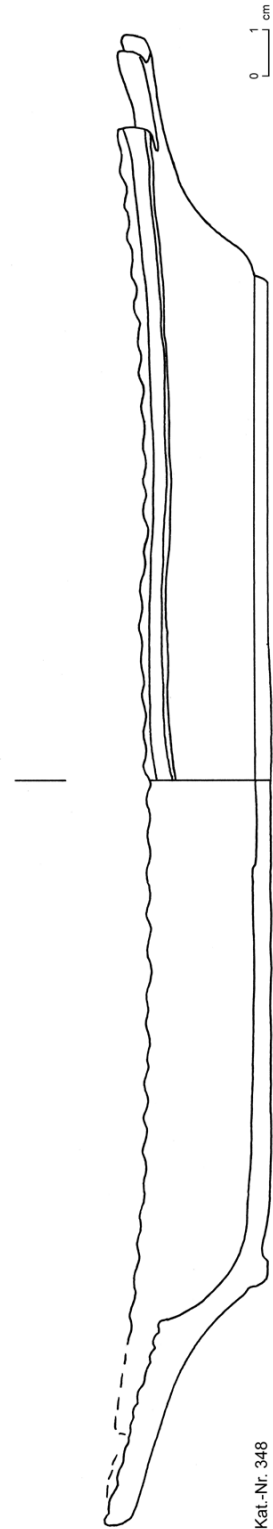

Kat.-Nr. 348

Fragmente offener Gefäße

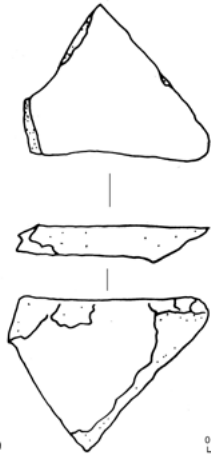

Kat.-Nr. 349

0 1 cm

Nekropole:

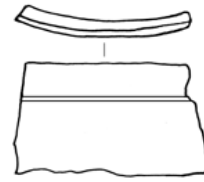

Kat.-Nr. 362

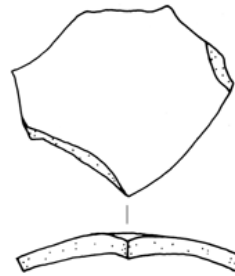

Kat.-Nr. 363

0 1 cm

Siedlung:

Varia – non TS

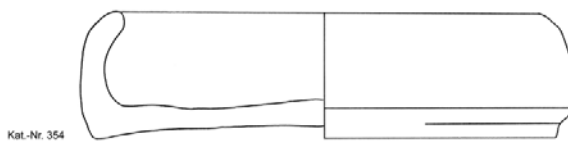
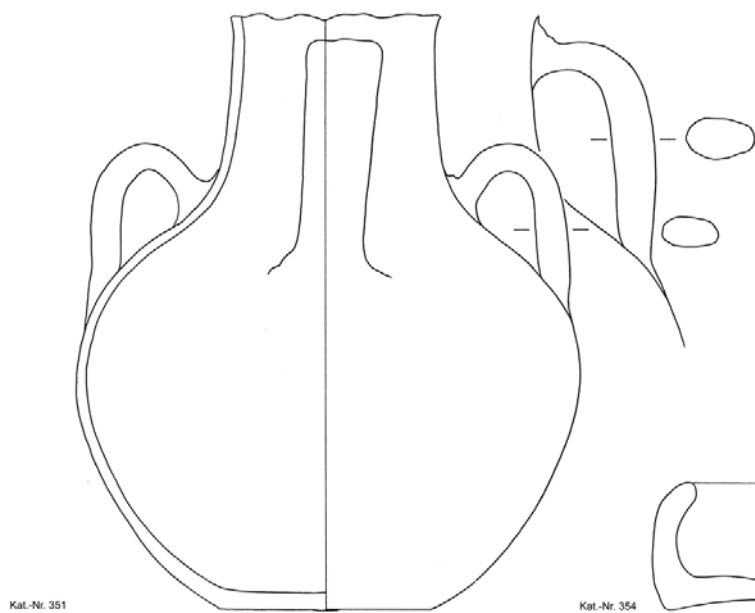
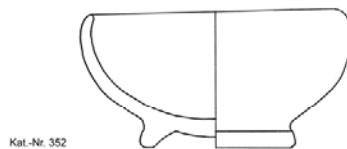
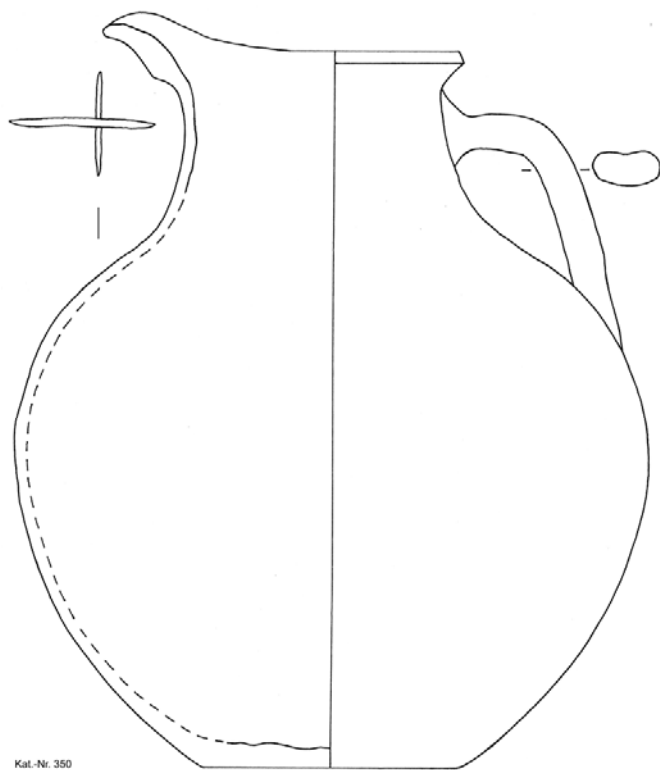

Farbtafeln

PS I



5



9



15



29



31



32



44



83



92



119



158



165



174



210



229



230



247



252



279

Taf. 1

PS I



255



286



287



294



295



301



304



316



319



321



322



363

Taf. 2

PS II



23



86



177



195



222



245



258



263



264



258



263



264



271



273



364



271



273



348



365

Taf. 3

PS III



203



234



235



236



278



311



318



335



345

Taf. 4

PS IV



Taf. 5

PS IV



120



124



145



149



155



160



167



170



171



175



179



184



185



208



215



218



219



233



224



225



242



251



269



349



270



305



333

Taf. 6

Eastern Sigillata A



325



142

Eastern Sigillata C



347



206

C1



5



8



9



34



140

Taf. 7

C2



117



187



328

C3



137



192

C4



148



204

C5



144

C6



153

Varia



132



176

Taf. 8