

5. Results

This chapter presents the results of the present study. Findings are divided into three parts. The first part describes all the major variables of interest. Major descriptive moments along with hypothesized correlates, developments over time as well as subcomponents of variables are presented. Early in this part, major outcome variables are examined. Some of these more descriptive results will answer the first set of hypotheses concerning the distribution and change of the repeatedly-measured affect variables, as well as interrelations of the so-conceptualized situation-specific, or acute, *versus* longer-term, or distal, outcomes. Following this, the major predictors of the study and their correlates are closely looked at.

The second part then tests hypotheses concerned with interrelations among predictors and outcomes. Initially, associations between and the interplay of higher-order personality traits, situation-specific coping responses, and situation-specific outcomes, i.e., affect and coping satisfaction, are examined. Then, similar relations are tested among more long-term and dispositional measures to find out about expected differences of both *proximal* versus *distal* approaches.

The third part of the findings relates to the two content-free approaches to coping, which are of interest to the present study, namely selective coping versus total range of coping. Following the above-established pattern, first situation-specific measures and their interrelations are looked at. Secondly, hypotheses concerning more distal and dispositional measures are tested.

5.1. Descriptive Results: Situation-Specific Outcomes

5.1.1. Distribution of State Affect Measures

Generally, participants tended to report more Positive than Negative Affect. As indicated in Section 4.2.9., Positive and Negative Affect were mostly independent of one another and were also mostly analyzed independently. One exception was a composite measure, 'Affect Balance,' introduced by Bradburn (1969). Affect Balance

relates to the difference between Positive and Negative Affect. Given that in most cases Positive exceeds Negative Affect, Affect Balance might also be described as "Surplus Positive Affect". As might be expected, Affect Balance was extremely highly correlated with Positive Affect at all times, coefficients ranged between $r_{t1} = .90$ and $r_{t3} = .98$. To avoid almost perfect redundancy, Affect Balance was largely neglected, except in one instance (Section 5.8.1.) where it was tested as an alternative outcome in order to compare more directly already established findings (Staudinger & Fleeson, 1996) to those of the present study.

Regarding state Negative Affect, with a few exceptions, patients mostly reported relatively low levels, leading to both high skewness and kurtosis at all measurement points (see Appendix B, Table B1; means presented in Figure 2). With Positive Affect no distribution problems occurred; values for both skewness and kurtosis were within the range of normality for all measurement occasions (means are presented in Figure 4). The same was true for Affect Balance (Appendix B, Table B1).

5.1.2. Changes in State Affect Around Surgery

The following paragraphs deal with the development of the major situation-specific outcome variables Negative and Positive Affect over four repeated measurement points pre- and post-surgery and their correlates. Looking at all four assessments, zero-order correlations and results from repeated measurements ANOVAs² are examined to determine whether change took place in the outcome measures and their subfacets as well as whether part of the states and changes of NA and PA are related to chronological age, gender, and selected medical variables like multimorbidity, prior experience with cataract surgery (1st/2nd Eye), form of anesthesia, minor complications following surgery, or information about visual acuity.

² Evaluating the results from the repeated measurement ANOVAs, possible departure from equality of covariance matrices across groups (as indicated by Box's M tests) as well as departure from sphericity (Mauchly's test for sphericity) were tested. Only in two instances did the Box test for equality of covariances yield significant results: testing differences in Positive Affect between age-groups as well as between patients with and without experience with cataract surgery. In both instances, results of the Box test could be ignored due to largely equal sample sizes across groups. Due to the unequal spacing of measurement points of Positive and Negative Affect, sphericity was violated moderately in all instances. Hence, the conservative Greenhouse-Geisser correction was applied to adjust degrees of freedom for the analyses in question. Unless otherwise indicated in the text, none of the corrections altered the reported results.

5.1.3. Unique Time Effects: State Negative Affect

The first hypothesis concerned the question whether Negative Affect was at a higher level pre- than post-surgery, and whether an increase in Negative Affect can be shown between the two pre-surgery time points. To test broad mean changes in Negative Affect over this time period, a one-way repeated measures ANOVA was carried out, with the four distinct measurement points serving as the time factor. Although Negative Affect remained at fairly low levels, results suggest that significant change took place over the repeated assessments ($F(3, 255) = 19.99, p < .001, \eta^2 = .19$)³. Inspection of the contrasts yielded significant changes between the day of surgery (t2) and discharge (t3; $F(1, 85) = 41.86, p < .001, \eta^2 = .33$) as well as between discharge (t3) and the 6-week post-surgery follow-up (t4; $F(1, 85) = 4.46, p < .05, \eta^2 = .05$). Means and standard errors are depicted in Figure 2. As expected, the mean Negative Affect was at a higher level pre-surgery and dropped post-surgery. No significant increase in Negative Affect was observed for the two pre-surgery measurements; however, there was a significant increment of NA from discharge to six weeks post-surgery.

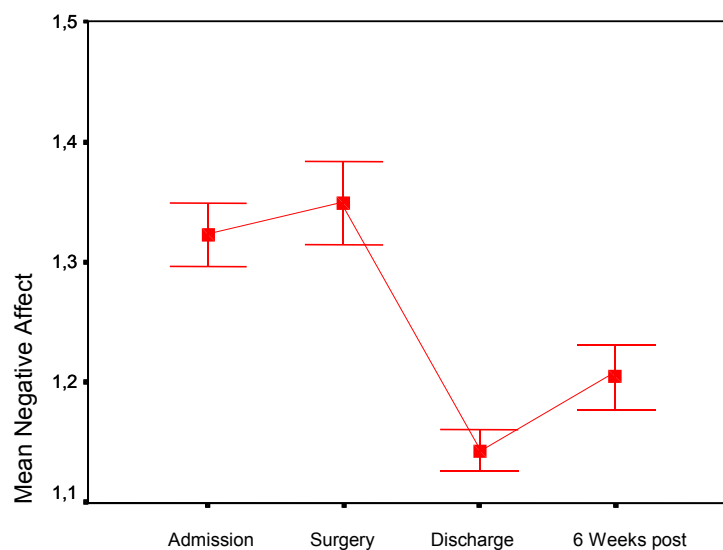

Figure 2 Mean Negative Affect (+/- one standard error, range 1 to 4) at all measurement points in time.

³ Greenhouse Geisser correction after significant departure from sphericity, critical value for an alpha level of .05 $F(2.20, 187.02)=2.95$.

Further analyses of the PANAS-NA subfacets suggested that the predominant emotion, especially prior to and immediately following surgery, was anxiety, followed by anger, sadness, and guilt (see Appendix C, Table C6).

Guilt showed very little variation over the course of the assessments, ranging closely around the minimum end of endorsement possibilities. Figure 3 shows means for the NA subfacets at all measurement points. Anxiety ($F(3,255) = 21.05, p < .001, \eta^2 = .20$), sadness ($F(3,255) = 3.36, p = .019, \eta^2 = .04$), and anger ($F(3,255) = 13.33, p < .001, \eta^2 = .14$) changed over time.⁴ Anxiety increased to a marginally significant extent between the two pre-surgery measurement points ($F(1, 85) = 3.19, p = .078, \eta^2 = .04$), dropped markedly post-surgery ($F(1,85) = 48.57, p < .001, \eta^2 = .36$), and was reported again at a higher level at six weeks post-surgery ($F(1,85) = 8.01, p = .006, \eta^2 = .09$). For sadness and anger, no changes were observed pre-surgery; however, post-surgery reported anger ($F(1,85) = 16.51, p < .001, \eta^2 = .16$) and sadness ($F(1, 85) = 4.29, p = .04, \eta^2 = .05$) immediately decreased. Sadness was found at a higher level again six weeks post-surgery ($F(1, 85) = 6.68, p = .01, \eta^2 = .07$).

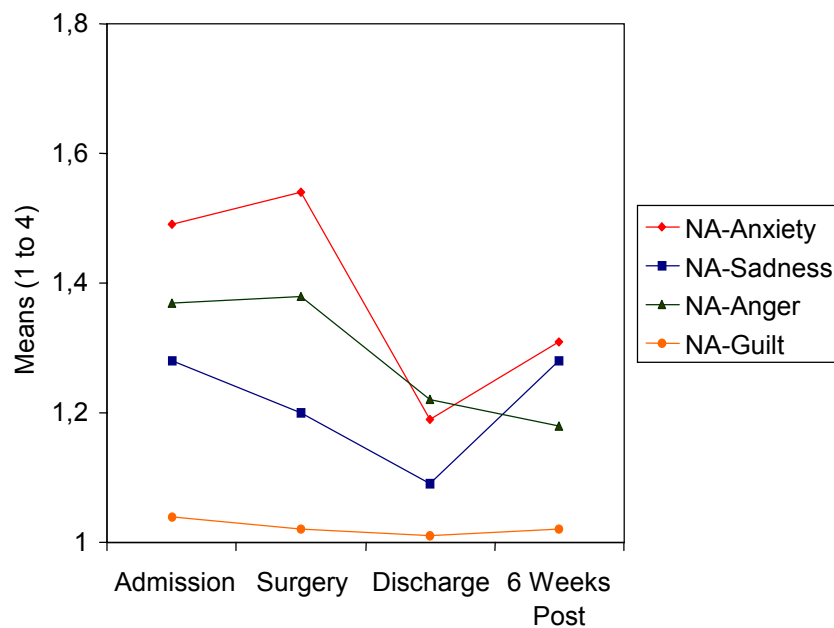

Figure 3 Means of Negative Affect subfacets at all measurement points in time.

⁴ Greenhouse Geisser corrections, critical values for an alpha level of .05: NA-Anxiety $F(2.35, 200.01)=2.87$; NA-Sadness $F(2.54, 216.01)=2.80$; NA-Anger $F(2.49, 211.46)=2.82$.

5.1.4. Unique Time Effects: State Positive Affect

Positive Affect was reported at higher levels than Negative Affect at all points in time. Participants also showed considerable change over time in reports of PA ($F(3, 255) = 18.28, p < .001, \eta^2 = .17$)⁵. As expected, Figure 4 indicates low Positive Affect at both pre-surgery measurement points, and a significant increase of PA from pre- to post-surgery ($F(1, 85) = 39.7, p < .001, \eta^2 = .32$). PA remained on this high level at the six-week follow-up.

Looking at subfacets of PA (Figure 5) as expected, attentiveness was the predominant positive emotion prior to surgery (see Appendix C, Table C5). Joviality ($F(3, 255) = 44.85, p < .001, \eta^2 = .35$) and low fatigue ($F(3, 255) = 18.19, p < .001, \eta^2 = .18$) changed over time⁶, whereas attentiveness remained at high levels and self-assurance at the lower end of the continuum over assessments. With respect to joviality, participants indicated lowest levels pre-surgery and an increment pre- to post-surgery

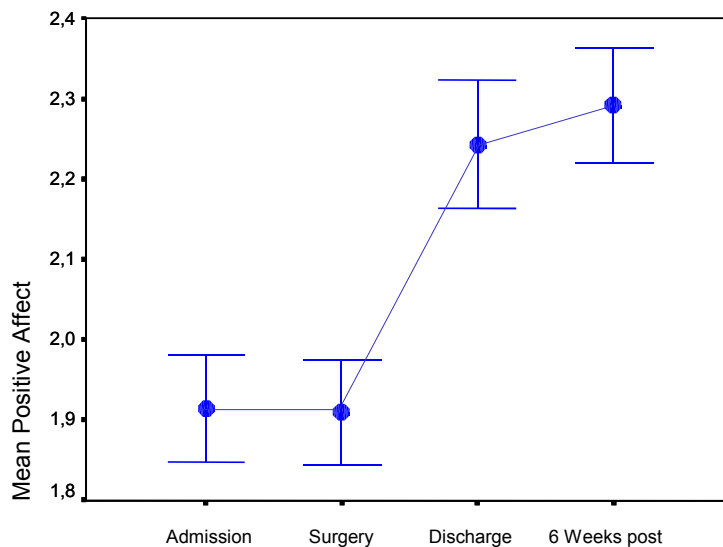

Figure 4 Mean Positive Affect (+/- one standard error, range 1 to 4) at all measurement points in time.

⁵Greenhouse Geisser correction, critical value for an alpha level of .05: $F(2.43, 206.92)=2.84$.

⁶Greenhouse Geisser correction, critical value for an alpha level of .05: PA-joviality $F(2.35, 200.05)=2.82$; PA-low fatigue $F(2.23, 187.10)=2.93$.

($F(1, 85) = 102.29, p < .001, \eta^2 = .55$). There were not any significant changes from discharge to the six-week follow-up. Concerning low fatigue, respondents claimed higher activity levels after surgery than they did before surgery, with a significant increment between the day of surgery and discharge from the hospital ($F(1, 85) = 28.71, p < .001, \eta^2 = .25$).

In sum, reported Positive Affect prevailed over Negative Affect at all measurement points in time. However, most of the expected changes in both Positive and Negative Affect were found in the present data. Changes indicated more distress pre-surgery with initially higher levels of Negative Affect which decreased post-surgery, as well as low levels of Positive Affect before the operation and a considerable increase of the same after the event.

The observed time effects for affect remained stable when independently controlling for a number of variables, including chronological age, sex, number of medical diagnoses, previous experience with cataract surgery, type of anesthesia, post-surgery complications, or visual acuity.

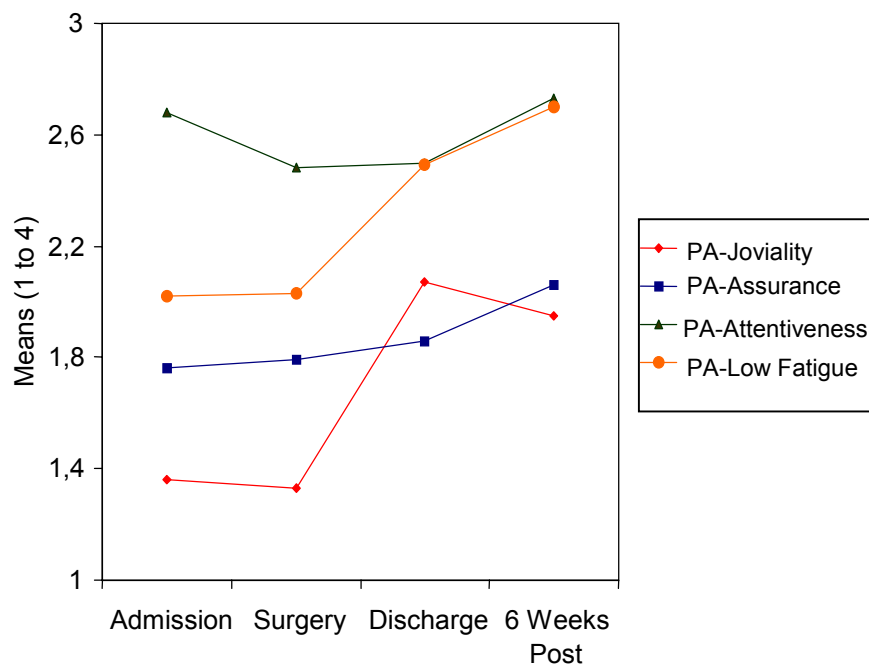

Figure 5 Means of Positive Affect subfacets over all measurement points in time.

5.1.5. Covariates of State Positive and Negative Affect

Chronological Age and Sex. No directed predictions about age as a covariate of affect were made. Pearson correlations suggested a mildly negative association between age and positive affect prior to surgery ($r = -.20, p = .04$), indicating that older participants reported less Positive Affect in anticipation of the surgery. However, age was neither associated with post-surgery Positive Affect nor with Negative Affect at any point in time. Quadratic functions of age were routinely tested, using Curve Estimation of the Regression subprogram issued by SPSS, but did not yield any significant effects for either Positive or Negative Affect at any point in time. Also, chronological age did not account for any change variance between measurement points of any of the affect variables as tested by means of repeated measures ANOVAs with trichotomized chronological age (age-groups: 43 to 64 years, 65 to 75 years, and 76 to 89 years) serving as a between-subjects factor.

With respect to gender, it was expected that women would report more Negative Affect than men, especially in anticipation of the stressor. Results from a repeated measures ANOVA with sex serving as an independent variable and four assessments of Negative Affect as the dependent variable showed a main effect on sex ($F(1,84) = 4.95, p = .03, \eta^2 = .06$) and a marginally significant time by sex interaction ($F(3, 252) = 2.25, p = .08, \eta^2 = .03$). However, correction for violation of sphericity by means of the Greenhouse-Geisser Epsilon, rendered the interaction completely insignificant, with a critical value for an alpha level of .10 ($F[2.23, 187.10] = 2.27$).

Sex was not related to any of the post-surgery Negative Affect measures. Looking at Positive Affect, women reported less pleasurable mood ($M = 1.98, SD = .51$) across all measurement points when compared to men ($M = 2.24, SD = .53; F(1, 84) = 5.51, p = .02, \eta^2 = .06$). Gender was not related to change in Positive Affect.

Medical Information: Morbidity. Information about patients' morbidity was represented by a sum score of self-reported unweighted medical diagnoses. Zero-order correlations did not reveal any significant associations between morbidity and any of the affect measures. There was one marginally significant relationship between number of diagnoses and Negative Affect at six weeks post-surgery ($r = .18, p = .08, n = 94$).

To introduce morbidity to a repeated measures ANOVA as an independent variable it was necessary to dichotomize it first, using a mediansplit procedure. Two groups, low ($M_{\text{diagnoses}} = .96$, $SD = .82$, $n_{\text{continuing}} = 46$) and high ($M_{\text{diagnoses}} = 4.6$, $SD = 1.71$, $n_{\text{continuing}} = 40$) morbidity, were retained.

Looking at Negative Affect, high versus low morbidity groups did not differ with respect to change nor overall Negative Affect across assessments. There was a marginally significant main effect of morbidity concerning Positive Affect, indicating that the low morbidity group reported more Positive Affect ($M = 2.18$, $SD = .57$) than the high morbidity group ($M = 1.98$, $SD = .46$) across all measurement points ($F(1,84) = 3.30$, $p = .07$, $\eta^2 = .03$).

Visual Acuity Pre-Surgery. Correlating pre-surgery best corrected distance visual acuity in the eye operated on with all affect measures yielded negative associations with PA upon admission to the hospital ($r = -.27$, $p = .004$, $N = 110$) pointing to lower Positive Affect in patients with higher visual acuity in the eye operated on. Visual acuity in the eye operated on was not related to Negative Affect.

Neither was visual acuity in the fellow eye (the one not operated on) significantly associated with any of the affect measures (states and changes).

Visual Acuity Post-Surgery. Post-surgical visual acuity in the eye operated on was marginally associated ($r = .19$, $p = .08$, $n = 94$) with Positive Affect at six weeks post-surgery, indicating higher Positive Affect in persons with better visual acuity in the eye operated on. Likewise, change in visual acuity in the eye operated on was associated with PA at t4 ($r = .27$, $p = .008$, $n = 94$), with more positive change in visual acuity after surgery relating to higher values in PA at the six-week follow-up. High and low groups of post-surgery visual acuity and change in visual acuity did not differ with respect to change in Positive nor Negative Affect post-surgery.

Previous Experience with Cataract Surgery (1st/2nd Eye). Prior experience with cataract surgery was tested as another covariate of affect. T tests indicated lower NA prior to surgery and higher PA for the time points before and immediately after surgery for patients with prior experience. A repeated measures ANOVA with four assessments of

Negative Affect as the time factor yielded a main effect for prior experience (1st/2nd Eye) across time points ($F(1, 84) = 5.23, p = .03, \eta^2 = .06$), as well as a significant time by experience interaction ($F(3, 252) = 4.27, p = .01, \eta^2 = .05$; Greenhouse Geisser critical value for an α level of .05: $F(2.25, 189.313) = 2.92$). Contrasts indicated the interaction to be marginally significant between the time points admission to the hospital and day of surgery ($F(1, 84) = 3.87, p = .05, \eta^2 = .04$) and between the day of surgery and discharge ($F(1,84) = 7.73, p = .01, \eta^2 = .08$). Means (Figure 7) show higher levels of Negative Affect for 1st Eye patients prior to surgery, with a steeper increase of NA pre-surgery as well as a steeper decrease of NA immediately following surgery.

Concerning Positive Affect, a repeated measures ANOVA revealed a main effect on the experience factor ($F(1, 84) = 5.37, p = .02, \eta^2 = .06$). Means (Figure 6) suggested higher levels of Positive Affect for patients with prior experience with cataract surgery on the day of admission, surgery, and discharge.

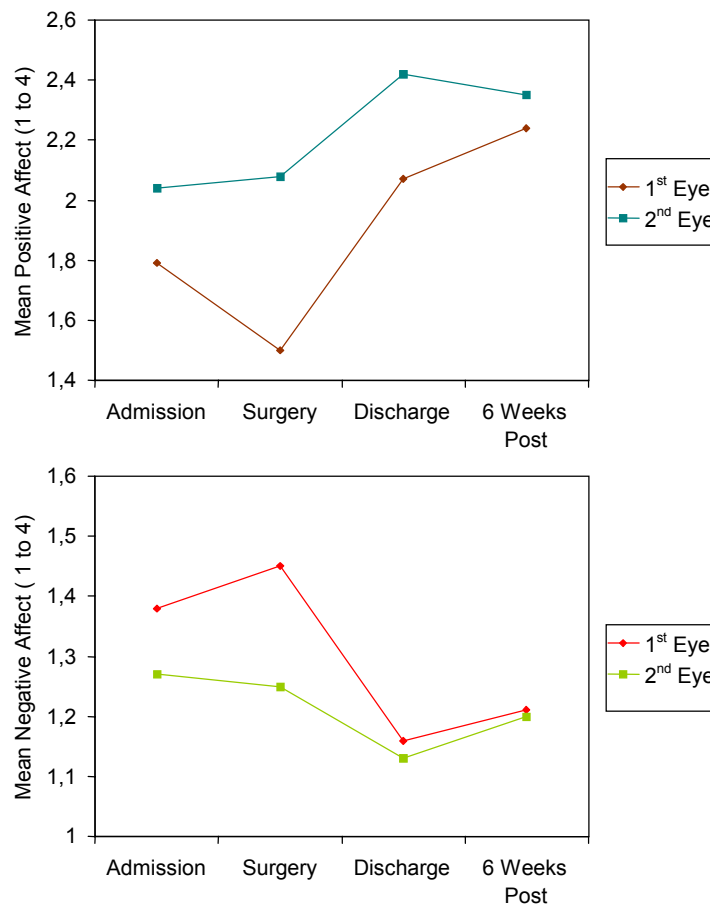

Figures 6 and 7 Separate affect means for 1st Eye versus 2nd Eye patients over all assessments.

Form of Anesthesia. The type of anesthesia was also tested as a correlate of affect and affect change by means of repeated measures ANOVA. There were two forms of local anesthesia used by surgeons, one invasive and one non-invasive (see Section 4.2.3.). Type of anesthesia formed a main effect on Positive Affect ($F(1, 84) = 4.92, p = .03, \eta^2 = .06$) along with a significant time by anesthesia interaction ($F(3, 252) = 3.69, p = .01, \eta^2 = .04$; Greenhouse Geisser critical value for an α level of .05: $F(2.42, 203.26) = 2.85$).

Contrasts specify this interaction by indicating a marginally significant interaction term (time by anesthesia) between time points t1 and t2 ($F(1, 84) = 3.01, p = .09, \eta^2 = .04$). Means suggest higher Positive Affect for the invasive group pre-surgery (Table 16). This effect is likely due to a sense of heightened responsibility felt by patients with non-invasive forms of anesthesia. Patients receiving non-invasive anesthesia are still able to move the anesthetized eye. However, they are explicitly instructed not to do so during the operation. With invasive forms of local anesthesia, eye movement is not possible. Negative Affect was not associated with type of anesthesia.

Table 16
Means and Standard Deviations of Positive Affect at t1 and t2

| Positive Affect M (SD) | Admission | Surgery |
|------------------------|-------------------------|------------|
| Non-Invasive | 1.66 _a (.48) | 1.73 (.52) |
| Invasive | 2.04 _b (.63) | 1.93 (.65) |

Note. Means with different subscripts are significantly different at a .001 level.

Minor Complications. A total of 16 patients suffered from slight post-surgical complications associated with a heightened tension in the eye operated on and treated with medication. This led to a later discharge from the hospital for some patients. Complications were followed up as a possible covariate to affect. However, post-surgical complications were not related to any of the affect measures of the present study.

In sum, expected covariates of Positive and Negative Affect before and after surgery showed rather small associations with the outcome. Unless indicated otherwise, chronological age, sex, and prior experience that share some of the affect variance are

introduced as covariates in all following analyses looking at predictors of affect and affect change around cataract surgery. Findings of additional control analyses are mentioned when appropriate.

5.1.6. Satisfaction with Coping Efforts

As an alternative situation-specific outcome variable to the present study, satisfaction with coping pre-surgery was looked at next. Satisfaction with coping was assessed retrospectively by means of a two-item scale six weeks post-surgery.

Looking at the overall distribution of reported satisfaction with coping⁷, most participants reported to be very satisfied with their coping efforts ($M = 3.63$, $SD = .57$, $n = 93$), resulting in high skewness (-1.36), but acceptable kurtosis (.73) of the scale.

Possible demographic and medical covariates of coping satisfaction were tested in a next step. Zero-order correlations and independent samples t tests did not suggest associations with gender. Also, medical control variables including morbidity, indicators of visual impairment, previous experience with cataract surgery, means of anesthesia, or post-surgical complications were not related to coping satisfaction. There was, however, a significant association with chronological age, pointing to higher satisfaction with pre-surgery coping efforts in older participants ($r = .21$, $p < .05$, $n = 93$).

Coping Satisfaction and Affect. To tap issues of content validity of the thus-assessed coping satisfaction construct, it was examined in the context of affect measures. If indeed participants reported their satisfaction with their own coping efforts prior to surgery, one would expect an association not only with reported coping efforts (see Section 5.5.14.), but also with indicators of emotional adaptation to the situation. Thus, reported coping satisfaction was also examined as a possible covariate of both types of affect, especially prior to surgery. Table 17 gives an overview of gross bivariate

⁷ With the use of a $p < .001$ criterion for Mahalanobis distance one outlier was found among cases. All variables included in a final hypothesized mediator model (Section, 5.5.15.; age, sex, previous experience with cataract surgery, Neuroticism, and coping) were entered as independent variables in a regression procedure designed to uncover multivariate outliers. Case 137 was an 80-year-old man reporting particularly low coping satisfaction and Active Coping. It was decided to drop case 137 from all further analyses including coping satisfaction as an outcome.

associations between satisfaction with coping efforts pre-surgery and affect as well as net of age, sex, and previous experience with cataract surgery. Correlations do not indicate any relations between Positive Affect and Coping satisfaction, while patients reporting more coping satisfaction for the time prior to surgery also reported less Negative Affect on the day of admission (t1) as well as on the day of surgery (t2). Associations also held when age, sex, and previous experience with cataract surgery were partialled out.

Table 17
Pearson Correlations Between General Coping Satisfaction and Positive and Negative Affect

| | Coping Satisfaction (r) | Coping Satisfaction (r ^{control}) ^a |
|----------------|-------------------------|--|
| PA t1 (n = 93) | .03 | -.00 |
| PA t2 (n = 86) | .11 | .01 |
| PA t3 (n = 85) | .13 | .01 |
| PA t4 (n = 93) | .08 | .05 |
| NA t1 (n = 93) | -.35*** | -.30** |
| NA t2 (n = 86) | -.34*** | -.30** |
| NA t3 (n = 85) | -.19 [†] | -.17 |
| NA t4 (n = 94) | -.16 | -.15 |

Note. PA = Positive Affect; NA = Negative Affect. [†] $p < .10$, * $p < .05$, ** $p < .01$, *** $p < .001$. a: Partial correlation controlling for age, sex, and previous experience with cataract surgery.

5.2. Descriptive Results: Longer-Term Well-Being Outcomes

To contrast surgery-specific outcome measures of state affect and coping satisfaction with more global and somewhat longer-term measures of subjective well-being, depressive symptoms and general life satisfaction were assessed six weeks after surgery.

One aim was to underscore the distinction between two forms of stress associated with the cataract and its treatment: one acute aspect of stress directly associated with the surgical intervention and stay at the hospital and one aspect of stress associated with long-term consequences of the illness. The following sections explore correlates of the proposed indicators of the more chronic stress aspect.

5.2.1. Depressive Symptoms: Distribution and Correlates

Depressive symptoms as assessed by the CES-D ranged within limits of a normal distribution (*skewness* = .84; *kurtosis* = .73). Participants' sumscores varied between 0 and 36, with a mean of 11.81 (*SD* = 7.31). Roughly 24.5% of respondents (*n* = 24) presented with a sumscore above 16 points, which represents the generally reported cut-off for clinically relevant depression.

Depressive symptoms were not correlated with chronological age in this sample. As expected, however, women reported higher depressive symptoms scores than men ($t(92) = -2.21, p = .03$; see Figure 8).

In terms of medical correlates, especially number of self-reported medical diagnoses exhibited a strong positive association with depressive symptoms ($r = .56, p < .001$). Moreover, depressive symptoms were correlated with post-surgical visual acuity in the eye operated on ($r = -.21, p = .04$) as well as with change in visual acuity in the eye

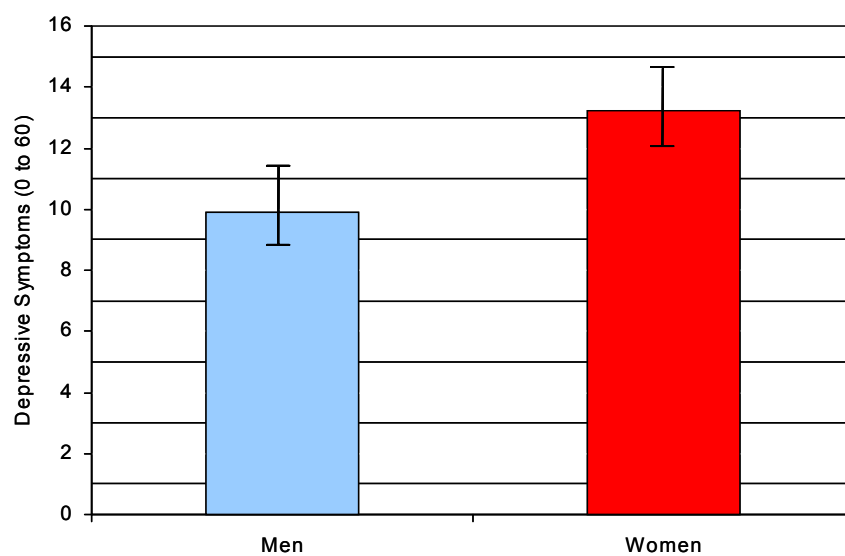

Figure 8 Mean depressive symptom sumscores for men and women.

operated on ($r = -.31, p < .01$). As expected, both measures were strongly interrelated ($r = .47^{***}$). Entering both as predictors of depressive symptoms into a hierarchical regression model, visual acuity in the eye operated on did not explain significant amounts of variance ($R^2\Delta = .01$) above and beyond change in visual acuity ($R^2\Delta = .10^{**}$). Entering all three medical covariates into the model resulted in multimorbidity taking on the most important predictor-status, vision-related data however were no longer significant predictors.

In other words, patients whose vision did not improve much as a consequence of the surgery also reported more depressive symptoms six weeks after the operation. While this result hints at a certain amount of situation-specificity in terms of distal consequences of cataract surgery, it was overpowered by a more general health indicator, i.e., number of unweighted medical diagnosis. To explore the relation between depressive symptoms and affect measures around surgery, Table 18 presents bivariate associations.

Table 18
Pearson Correlations of Depressive Symptoms and Life Satisfaction with the Affects

| | Depressive Symptoms | Life Satisfaction t1 | Life Satisfaction t4 |
|---------------------|---------------------|----------------------|----------------------|
| PA t1 | -.17 | .00 | .10 |
| PA t2 | -.13 | .04 | .13 |
| PA t3 | -.23* | -.03 | .10 |
| PA t4 | -.35*** | .19 [†] | .35*** |
| NA t1 | .27** | -.18 [†] | -.06 |
| NA t2 | .16 | -.10 | -.08 |
| NA t3 | .13 | -.20* | -.03 |
| NA t4 | .31** | -.29** | -.16 |
| Coping Satisfaction | -.29** | .38** | .28** |

Note. 110 > N > 86. PA/NA = Positive Affect/ Negative Affect. [†] $p < .10$, * $p < .05$, ** $p < .01$, *** $p < .001$.

Coefficients show low to moderate relations of depressive symptoms and affect assessed at the hospital. Higher relations were found between depressive symptoms and state affect at the measurement point six weeks post-surgery. Looking at the association

between depressive symptoms and the other more situation-specific outcome measure, coping satisfaction, a moderate negative correlation was also found ($r = -.29, p = .005$) pointing to more depressive symptoms in patients who were not highly satisfied with their coping efforts prior to surgery.

5.2.2. Life Satisfaction

At both measurement points in time (pre- as well as post-surgery), most cataract patients reported to be rather happy with their lives in general. Mean life satisfaction prior to the operation ranged around 2.90 ($M; SD = .81$) and post-surgery 3.15 ($M; SD = .73$); the minimum values reported at both occasions were 1 (*not at all satisfied*), the maximum value 4 (*very satisfied*). Both means were located markedly beyond the midpoint (2) of the scale. The overall distributions at both occasions were within an acceptable range of normality (t1 *skewness* = $-.54$, *kurtosis* = $.07$; t2 *skewness* = $-.41$, *kurtosis* = $-.47$). Life satisfaction at t1 correlated only moderately with life satisfaction at t4 at $r = .33, p = .001$.

Life satisfaction was not related to chronological age or sex. Looking at possible medical correlates, life satisfaction at both measurement points was moderately negatively associated with number of self-reported medical diagnoses (t1 $r = -.24, p = .01$; t4 $r = -.27, p = .008$). Vision-related data produced a significant correlation between life satisfaction at t1 and best corrected visual acuity in the eye operated on pre-surgery ($r = .19, p = .048$), and a marginal association between life satisfaction at t4 and change in visual acuity in the eye operated on ($r = .19, p = .08$). The latter finding did not withstand the control for multimorbidity, however. On the other side, change in visual acuity predicted positive change ($\beta = .25, p < .05, R^2\Delta = .06^*$) in life satisfaction from t1 to t4 (while t1 was controlled for). In this case, multimorbidity as a rival predictor for change in life satisfaction again revealed some overlap with change in visual acuity, however, multimorbidity did not reach significance ($\beta = -.13, n.s., R^2\Delta = .01, n.s.$). In sum, findings pointed to more life satisfaction in patients with better vision (at t1). Regarding post-surgical life-satisfaction and change thereof from pre- to post-surgery, more change in visual acuity in the treated eye (at t4) shared predicted outcome variance with multimorbidity.

Life satisfaction at t1 was not associated with Positive Affect in the hospital situation. There was one low and marginally significant positive correlation with Positive Affect at t4 (see Table 18). Concerning Negative Affect, negative associations were found upon admission to the hospital (t1 concurrent to the measurement of life satisfaction at t1), at discharge from the hospital (t3) and at six weeks post-surgery (t4). Notably, relations with Negative Affect were stronger when looking at more temporally distal measurement points in time (see Table 18). This finding might hint at the exceptionality of the pre-surgical hospital situation for most patients: a more dispositional measure being more closely related to random day affect (as measured at t4) than to accounts of state affect during a somewhat unusual and threatening situation. Relating life satisfaction assessed six weeks post-surgery to affect directly around surgery, no significant associations were found (see Table 18). State Positive Affect six weeks post-surgery, however, was moderately correlated with life satisfaction reported at the same measurement point (t4; $r = .35, p < .001$).

With respect to satisfaction with coping efforts prior to surgery (coping satisfaction), moderate positive relations with life satisfaction at both measurement occasions were also found (t1: $r = .38, p < .01$; t2: $r = .28, p < .01$), somewhat contrary to expectations about situation-specificity of coping satisfaction as an outcome. Nevertheless, taking into account differential relations between different assessments of affect directly before surgery and coping satisfaction (Section 5.1.6.), findings seem to point to both situation-specific and dispositional aspects captured by the coping satisfaction scale.

5.3. Descriptive Results: Longer-Term Vision-Related Functional Outcomes

As a second group of more distal outcomes that deal with a functional aspect of the consequences of cataract surgery, vision-related functional status was assessed. Patients were asked to rate (a) whether or not they were pursuing a total of eleven heavily vision-dependent activities (see Section 4.2.13.) while wearing glasses (number of activities), and (b) the degree of difficulty encountered while said activities were performed (intensity of limitation). Vision-related functional status was assessed at two points in time: on the day of admission to the hospital (t1) and six weeks post-surgery (t4).

After the exclusion of one case (no. 141), a 76-year-old man who claimed to pursue all listed activities, but never wore glasses, distributions of number of activities were still within acceptable range with *skewness* (t_1) = -.49 and *kurtosis* (t_1) = -.13 at the first assessment as well as *skewness* (t_4) = -.49 and *kurtosis* (t_4) = -.43 at the second. Concerning intensity of limitation, at t_1 the distribution was normal with values of -.03 for *skewness* and -.52 for *kurtosis*. Six weeks post-surgery, the distribution of intensity of limitation shifted to the left somewhat with values for *skewness* = 1.33 and *kurtosis* = 2.89.

Looking at means revealed stability in number of pursued activities, roughly 8 of 11 (driving items excluded 7.5 of 9) with standard deviations ranging around two (driving included: $M_{t1} = 8.49$, $SD_{t1} = 2.04$, $M_{t2} = 8.37$, $SD_{t2} = 2.00$; driving excluded: $M_{t1} = 7.59$, $SD_{t1} = 1.51$, $M_{t2} = 7.62$, $SD_{t2} = 1.43$), but an expected decrease of intensity of limitation following surgery ($t(92) = 5.61$, $p < .001$; see Figure 9). Correlations between repeated measurements were expectedly high ($r_{tt \text{ activities}} = .62$, $p < .001$; $r_{tt \text{ limitation}} = .44$, $p < .001$), associations between activities and limitations however were low and non-significant ($t_1 r = -.14$, n.s.; $t_2 r = -.16$, n.s.).

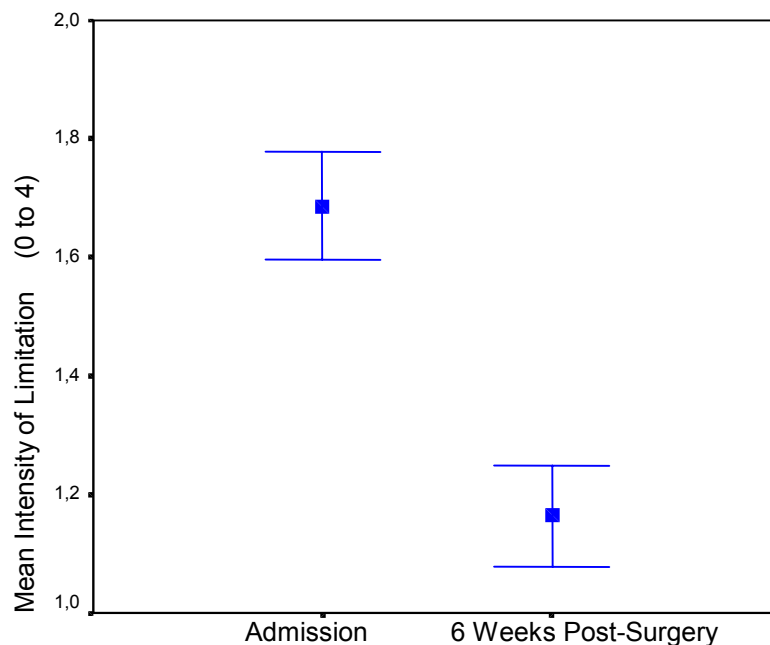

Figure 9 Overall means (\pm one standard error) of intensity of limitations upon admission and six weeks post-surgery.

While, on average, participants failed to take up more activities post-surgery, those activities pursued post-surgery seemed to be easier to handle. Looking for possible associated factors next, again correlations and t tests were computed. Concerning change between the two measurements, hierarchical regression analyses predicting the respective second assessment were performed, entering the pre-surgery measure to the first and the proposed correlate to the second block.

Correlates Age and Sex. At both assessment occasions number of activities correlated negatively with chronological age ($r_{t1} = -.31, p < .001$; $r_{t4} = -.41, p < .001$). Moreover, when change was looked at, at first a negative association (*last step* $\beta = -.18, p = .03$) between age and number of activities six weeks post-surgery arose, while t1 was controlled for. Nevertheless, after controlling for sex, age did not predict independent change variance in number of activities any longer.

As for sex, number of activities were higher in men ($M_{t1} = 9.20, SD_{t1} = 1.85$; $M_{t2} = 9.59, SD_{t2} = 1.58$) than they were in women ($M_{t1} = 7.94, SD_{t1} = 2.02$; $M_{t2} = 7.48, SD_{t2} = 1.81$) for both measurement points (t1: $t(107) = 3.35, p < .001$; t2: $t(91) = 5.84, p < .001$). The same was true, though not as strongly, when items concerning driving during the day or at night were excluded from the list of activities (t1: $t(107) = 2.14, p = .03$; t2: $t(97) = 3.63, p < .001$).

Concerning change between measurements, men also reported more activities six weeks post operation when t1 was held constant (dummy coding: men = 1, women = 2; *last step* $\beta = -.33, p < .001, R^2\Delta = .10^{***}$; driving items not included: *last step* $\beta = -.22, p < .01, R^2\Delta = .05^{**}$).

Except for women tending to indicate more limitations at t1 ($r = .17, p = .08$), neither age nor sex were related significantly to reported intensity of limitation at any point in time, nor to change in intensity of limitation between measurement points.

Correlates: Multimorbidity and Ophthalmic Data. Zero-order correlations at both measurement points indicated persons who pursued fewer activities also suffered from more illnesses ($r_{t1} = -.19, p = .05$; $r_{t2} = -.23, p = .03$) and (for t4 only) presented with less visual acuity post-surgery in the eye operated on ($r_{t2} = .19, p = .07$). Also, at the last assessment, number of activities was positively associated with change in visual acuity

in the eye operated on ($r = .23, p = .02$). As another previously unimportant control factor concerning functional status, acquisition of new prescription glasses after surgery was taken into account. At t4, persons who had already acquired new glasses ($M_{t4} = 9.21, SD = 1.84$) reported to engage in roughly one more activity than their counterparts ($M_{t4} = 8.31, SD = 2.15; t(91) = -2.23, p = .03$). Considering change in number of activities, both having new glasses (*last step* $\beta = .13, p = .09; R^2\Delta = .02, p = .09$) and more change in visual acuity in the eye operated on (*last step* $\beta = .15, p = .05; R^2\Delta = .02, p = .05$) were positively associated with t4 number of activities, while t1 was held constant, although only marginally so. Interestingly, none of the ophthalmic effects withstood the control for sex.

With respect to intensity of limitations at t1, only best corrected distance visual acuity in the eye operated on (t1) correlated negatively with it ($r = -.19, p = .04$). At six weeks post-surgery, persons who reported more limitations also tended to have more medical diagnoses ($r = .30, p < .01$) and worse visual acuity in both eyes post-surgery ($r_{eye\ operated} = -.35, p < .001, r_{other\ eye} = -.22, p = .03$). Moreover, participants with more limitations six weeks post-surgery tended not to have new glasses yet ($M_{no\ new\ glasses} = 1.27, SD = .87; M_{new\ glasses} = .81, SD = .47; t(91) = 2.30, p = .02$). Looking at change in reported limitations, visual acuity in the eye operated on (post-surgery) remained a significant predictor (*last step* $\beta = -.27, p < .01; R^2\Delta = .07, p < .01$), as did (marginally) number of unweighted medical diagnoses (*last step* $\beta = .16, p = .09; R^2\Delta = .02, p = .09$) and acquisition of new glasses (*last step* $\beta = -.16, p = .08; R^2\Delta = .03, p = .08$).

5.4. Descriptive Results: Major Predictors

5.4.1. NEO-Personality Traits: Distribution and Correlates

Assessed personality traits included Neuroticism, Extraversion, and Openness to Experience. Distributions of the traits roughly followed a normal distribution with acceptable ranges of skewness and kurtoses for Neuroticism (*skewness* = .26, *kurtosis* = .74), Extraversion (*skewness* = .29, *kurtosis* = .05), and Openness (*skewness* = .07, *kurtosis* = .34). On a scale ranging from 0 (*not at all true*) to 4 (*exactly*), the average value was highest for Openness to Experience ($M = 2.46; SD = .58$), followed by Extraversion ($M = 2.15; SD = .56$) and Neuroticism ($M = 1.50; SD = .56$).

Correlates: Age and Sex. Zero-order correlations showed a positive association between Neuroticism and chronological age ($r = .21, p = .03, N = 110$), as well as a marginally significant negative relation of age with Extraversion ($r = -.17, p = .08, N = 110$), pointing to higher Neuroticism and lower Extraversion scores in older participants. Openness to Experience was not related to age.

Furthermore, *t* tests for independent samples revealed a higher mean score of Neuroticism ($t(108) = -2.83, p < .01, N = 110$) for women ($M = 1.63, SD = .55, n = 62$) when compared to men ($M = 1.34, SD = .53, n = 48$).

Correlates: Medical Information. Short of the number of unweighted self-reported medical diagnoses, none of the medical information assessed in the study was associated with personality traits. Morbidity, however, was positively correlated with Neuroticism ($r = .27, p = .004, N = 110$) and negatively correlated with Extraversion ($r = -.22, p = .021, N = 110$). However, the association between Extraversion and Morbidity was not significant any longer once Neuroticism was partialled ($r_{\text{Morbidity-Extraversion-Neuroticism}} = -.15, n.s.$). Openness was not related to any of the available medical information.

5.4.2. Coping: Distribution and Correlates

Looking at both the situation-specific (t1) and dispositional (t4) versions of the newly built four coping scales, Focus on Positive, Seeking Support, and Active Coping stay within an acceptable range of normal distribution. Both versions of Evasive Coping scales however are rarely reported (Appendix B, Table B1). As indicated in Figure 10, strategies that focus on the positive aspect of the situation show the highest mean levels among coping strategies in both assessments followed by Support Seeking, and Active Coping (situation-specific, reverse order with the dispositional measures), and lastly, by Evasive Coping.

Interestingly, participants reported higher levels of the dispositional as compared to the situation-specific versions of Active Coping ($t(93) = -4.18, p < .001, n = 94$) and Evasive Coping ($t(93) = -2.32, p = .023, n = 94$).

Correlates: Age. Zero-order correlations of age with different types of situation-specific as well as dispositional coping did not render any significant associations. Also, quadratic effects of age on both dispositional and situation-specific coping were tested. However, none of the models turned out significant. This came as a surprise, since not so much for situation-specific, but mostly for dispositional coping linear associations between Active Coping/D (negative) and Focus on Positive/D (positive) were expected (see Section 3.3.). This might be attributed in part to a problem of statistical power due to the small sample size. For instance, the negative relation of Active Coping/D (dispositional) with age only barely missed an acceptable significance level, with $r = -.16$ ($p = .12$).

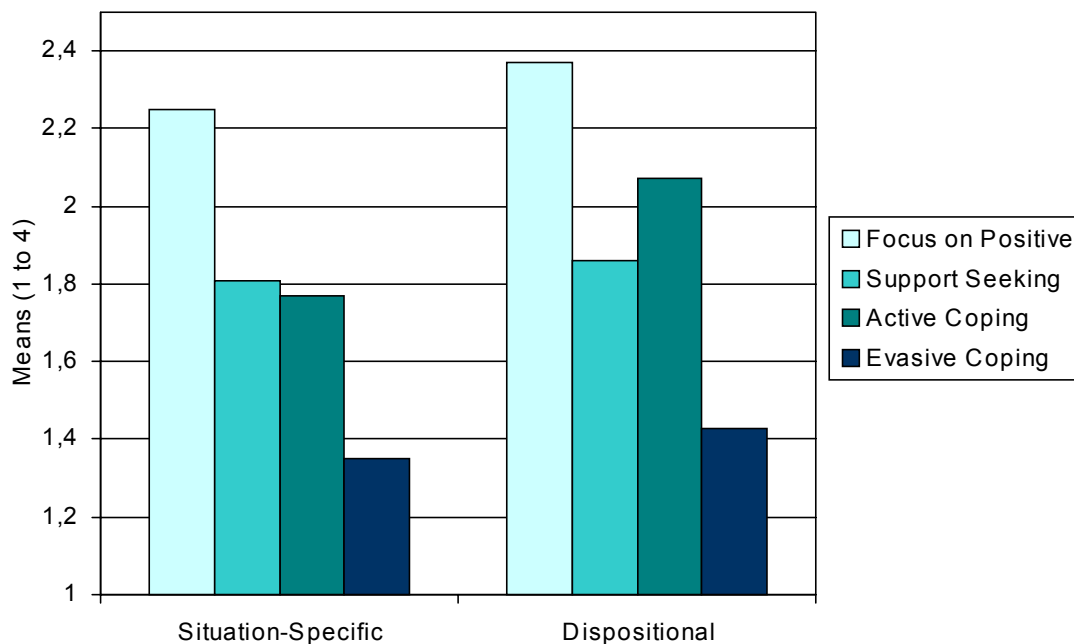

Figure 10 Means of situation-specific and dispositional coping subscales.

Nevertheless, none of the other forms of coping (be it situation-specific or dispositional) showed any appreciable linear or quadratic relations with chronological age.

Correlates: Sex. Looking at gender differences in both situation-specific and dispositional coping measures, women reported slightly more use of the support strategies (situation-specific: $t(108) = -1.89$, $p = .06$, $N = 110$; dispositional: $t(92) = -$

1.75, $p = .08$, $n = 94$). Also, with situation-specific coping only, women tended to use less Active Coping ($t(108) = 1.78$, $p = .08$, $N = 110$) when compared to men.

Medical Correlates: Coping Situation-Specific. Correlations and independent samples t tests indicate few relations of situation-specific coping with medical information. Seeking Support was positively associated with number of unweighted medical diagnoses ($r = .24$, $p = .01$, $N = 110$). More active copers tended to have less pre-surgical visual acuity in the eye operated on ($r = -.20$, $p = .04$, $N = 110$) and were more likely to receive invasive types of local anesthesia ($t(107,49) = -2.74$, $p = .007$; see Figure 11).

There was also a marginally significant difference between 1st and 2nd Eye patients in terms of focusing on the positive aspects of the situation ($t(108) = -1.90$, $p = .06$, $N = 110$), 2nd Eye patients reported slightly more focusing on the positive ($M = 2.37$, $SD = .59$) than 1st Eye patients ($M = 2.15$, $SD = .59$).

Medical Correlates: Coping-Dispositional. Concerning dispositional coping, only one association with medical indicators was found. Again, patients who had undergone their second cataract surgery ($M = 2.52$, $SD = .63$) before, indicated more use of Focus on Positive coping than their 1st Eye ($M = 2.25$, $SD = .63$) counterparts ($t(92) = -2.02$, $p = .05$, $n = 94$).

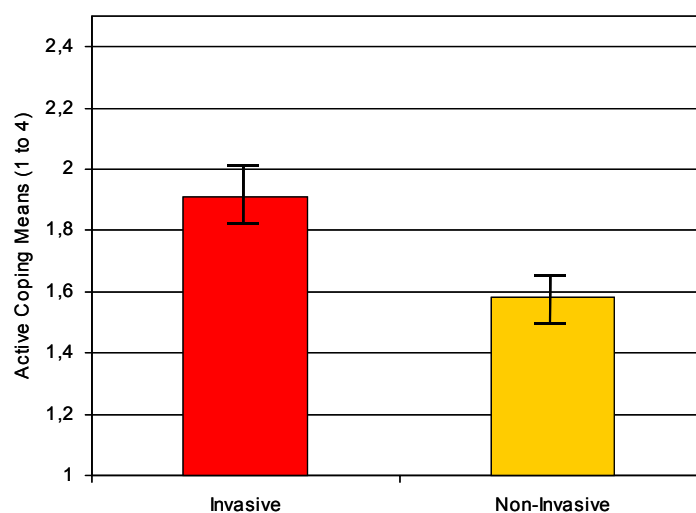

Figure 11 Means for situation-specific active coping in patients receiving invasive versus non-invasive forms of local anesthesia.

5.4.3. Two Content-Free Aspects of Coping: Selective Coping versus Total Range of Coping

Selective Coping. Looking at the intraindividual variance of the situation-specific and dispositional coping scales, fairly skewed distributions emerged (situation-specific: $skewness = 2.03$, $kurtosis = 5.07$; dispositional: $skewness = 1.51$, $kurtosis = 2.58$). The mean value of the distribution was low, with $M_{situation-specific} = .38$ ($SD_{situation-specific} = .35$) and $M_{dispositional} = .46$ ($SD_{dispositional} = .39$). Taking into account the fairly high intercorrelations among coping responses, this finding did not come as a surprise. To illustrate what is referred here to as *selective coping* or likewise a *pronounced coping pattern*, Figure 12 contrasts situation-specific coping profiles of cataract patients high versus low in situation-specific selective coping. Note that subgroups were identified by means of a median-split procedure and were employed for illustration purposes only. Neither chronological age, sex, nor any of the tested medical variables were related to selective coping in its situation-specific or dispositional form, with one exception: Six weeks post-surgery, participants with more change in visual acuity in the eye operated on tended to report a more pronounced habitual coping pattern ($r = .34$, $p < .001$, $n = 94$).

Total Range of Coping. With regard to total range of coping responses, a slightly different picture emerged. Both situation-specific and dispositional accounts of range of coping approximated normal distribution ($skewness_{situation-specific} = -.46$, $kurtosis_{situation-specific} = -.46$; $skewness_{dispositional} = -.80$, $kurtosis_{dispositional} = -.11$). Referring to how they coped with the upcoming surgery in particular, participants reported using an average $M = 2.57$ ($SD = 1.08$) coping strategies. When asked how they coped with difficult situations in general (dispositional instruction, six weeks post-surgery), a mean of 2.83 ($SD = 1.16$) of the four possible coping variables were indicated.

In terms of correlates, only tendencies emerged. Range of situation-specific coping responses was marginally related with visual acuity in both eyes prior to surgery. The better patients saw with the eye operated on ($r = -.17$, $p = .07$) as well as with the other eye ($r = -.16$, $p = .09$), the fewer coping strategies they reported to use in anticipation of the surgery.

Both of the content-free aspects of coping were completely independent of one another (situation-specific: $r_{selective\ coping-total\ range} = -.04, n.s.$; dispositional: $r_{selective\ coping-total\ range} = -.03, n.s.$). Situation-specific-dispositional associations again ranged around $r = .50$ (selective coping $r_{situation-specific-dispositional} = .49, p < .001$; total range of coping $r_{situation-specific-dispositional} = .44, p < .001$).

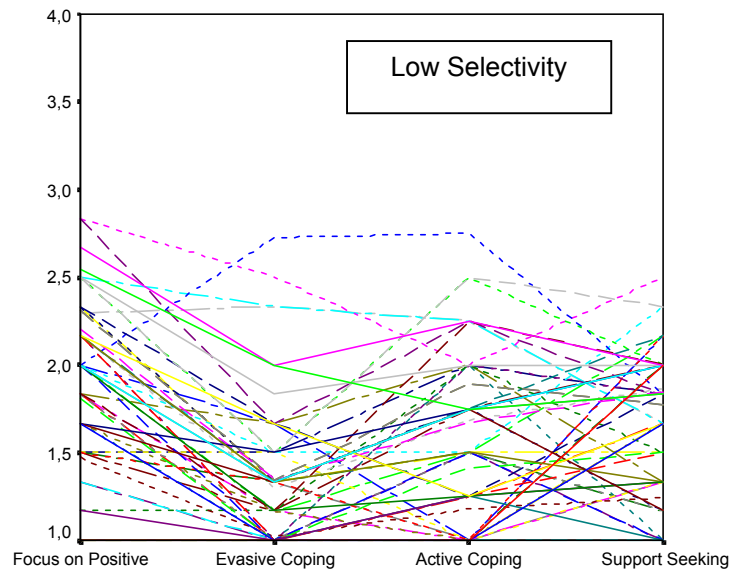

(a)

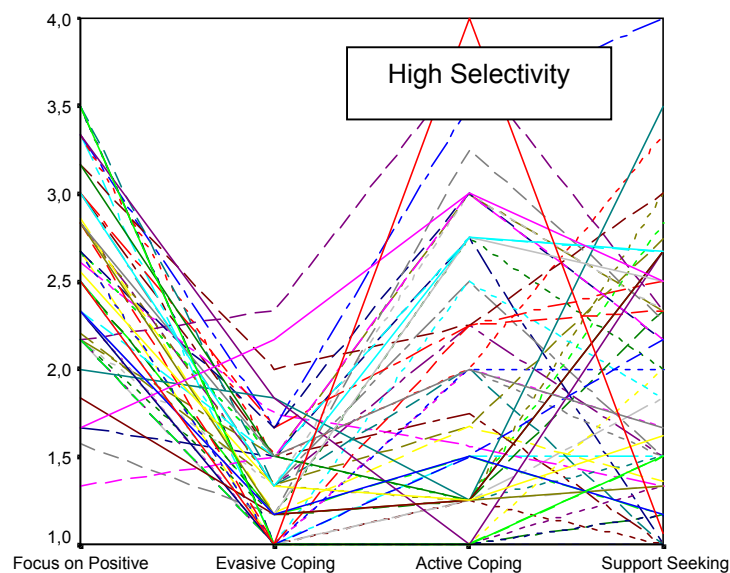

(b)

Figure 12 Patients low (a) and high (b) in selective coping, situation-specific coping profiles are presented.

5.5. Testing Mediation with Situation-Specific Measures

5.5.1. Personality Variables Predict State Affect

In a first step toward testing the proposed mediator hypotheses, it was necessary to ascertain a relationship between predictors (Neuroticism, Extraversion, Openness) and the proposed outcome variables Positive and Negative Affect. Initially, there was an inspection of Pearson correlations. Subsequently, relations between predictors and outcomes were tested at all measurement points while controlling for a number of covariates (i.e., sex, age, 1st/2nd Eye) by means of hierarchical regression analyses. Also, longitudinal prediction was tested by additionally controlling for previous measurements of affect while predicting later affect measures.

Looking at correlations, revealed largely anticipated bivariate relationships between higher-order personality traits and affective outcome. Neuroticism was significantly correlated with Negative Affect at all measurement points pre- to immediately post-surgery; there was no relationship with state Negative Affect six weeks post-surgery. Extraversion was related to Positive Affect also pre- to immediately post-surgery, failing to show an association with six weeks post-surgery state Positive Affect also. Lastly, Openness to Experience was associated with Positive Affect at assessments t1 (admission to the hospital) and marginally with t2 (day of surgery). Notably, Neuroticism also revealed fairly strong inverse relationships with Positive Affect at all measurement points (t1 through t4), whereas Extraversion was only related to Positive Affect, as expected. The same was true when the short version Neuroticism/S (net of Negative Affectivity items; see Method Section 4.2.5.) was tested. Correlations with Positive Affect dropped only slightly and remained marginally to highly significant with measurement points PA t2 (day of surgery) and PA t3 (discharge; see Appendix D).

In a next step, relations were tested while controlling for a number of covariates of Positive and Negative Affect as reported in Section 5.1.5, above. For all planned analyses, age, sex, and previous experience with cataract surgery (1st/2nd Eye) were controlled for. For testing change among affect variables, measures preceding the respective outcome were also held constant. Using hierarchical regression analyses, control variables were introduced in a first step, and personality variables in a second. Separate analyses were performed for Positive and Negative Affect as well as predictors

Neuroticism, Extraversion, and Openness. Furthermore, because of shared variance between predictors Neuroticism and Extraversion, analyses were repeated, entering all personality traits at once.

Table 19
Product-Moment Correlations Between Personality Traits and Outcome Variables Positive and Negative Affect

| | Neuroticism | Extraversion | Openness |
|--------------------|-------------------|--------------|------------------|
| PA t1 (N = 110) | -.20* | .20* | .28** |
| PA t2 (n = 102) | -.18 [†] | .32** | .17 [†] |
| PA t3 (n = 101) | -.30** | .21* | .07 |
| PA t4 (n = 94) | -.20 [†] | .09 | .00 |
| NA t1 (N = 110) | .36*** | -.06 | .09 |
| NA t2 (n = 102) | .32** | -.05 | -.14 |
| NA t3 (n = 101) | .30** | -.15 | .03 |
| NA t4 (n = 94) | .13 | -.05 | .14 |

Note. PA = Positive Affect; NA = Negative Affect. [†] $p < .10$, * $p < .05$, ** $p < .01$, *** $p < .001$.

5.5.2. Neuroticism, Extraversion, and Openness Predict State Positive Affect

Neuroticism. Controlling for chronological age, sex, and previous experience with cataract surgery, Neuroticism independently predicted Positive Affect on the day of discharge from the hospital (t3; $\beta = -.24^*$, $\Delta R^2 = .05^*$) and marginally six weeks post-surgery (t4; $\beta = -.19^{\dagger}$, $\Delta R^2 = .03^{\dagger}$). Moreover, while controlling for Positive Affect at t2, Neuroticism still predicted Positive Affect at discharge ($\beta = -.17^*$; see Table 20), however, explaining only 3% of its variance. All associations reported were negative. That is, more emotionally labile persons tended to report less Positive Affect at discharge and six weeks post-surgery. Moreover, more emotionally stable patients exhibited a steeper increment in Positive Affect following the operation. Except for the prediction of PA at t4 which fell below a 10% significance level, all reported associations remained virtually unchanged when Extraversion, Openness to Experience, and other covariates of Positive Affect were controlled for (see Table 20), and when the

net of negative affectivity version, Neuroticism/S, was tested (see Tables D1 through D6, Appendix D).

Extraversion. While controlling for age, sex, and previous experience with cataract surgery, Extraversion solely predicted Positive Affect at the day of surgery (prior to surgery; $\beta = .24^*$, $\Delta R^2 = .06^*$). This was also true (albeit only marginally significant) while additionally controlling for t1 PA ($\beta = .14^\dagger$, $\Delta R^2 = .02^\dagger$), using the net of positive affectivity version, Extraversion/S (see Appendix D, Table D5), and accounting for Neuroticism and Openness to Experience (see Table 20), as well as other covariates of Positive Affect (Appendix C, see Table C7). Positive associations suggested that extraverts reported more Positive Affect immediately prior to surgery. Also, introverts showed a steeper decline in Positive Affect from admission to the hospital to day of surgery.

Table 20
Summary of Hierarchical Regression Analyses Predicting Positive Affect at Different Points in Time

| Outcome | R | R ² | ΔR^2 |
|-------------------------------|-----|----------------|------------------|
| Positive Affect t1 (N = 110) | | | |
| Rival Predictors | .30 | .09* | |
| NEO added | .41 | .17 | .08** |
| Positive Affect t2 (n = 102) | | | |
| Rival Predictors | .33 | .11** | |
| NEO added | .42 | .18 | .07* |
| Positive Affect t3 (n = 101) | | | |
| Rival Predictors | .30 | .09* | |
| NEO added | .39 | .15 | .06 [†] |
| Change PA t2 (n = 102) | | | |
| PA t1 and Rival Predictors | .72 | .52*** | |
| NEO added | .74 | .54 | .02 |
| Change PA t3 (n = 101) | | | |
| PA t2 and Rival Predictors | .74 | .55*** | |
| NEO added | .77 | .59 | .04 [†] |

Note. Rival predictors: Age, sex, 1st/2nd Eye. PA: Positive Affect. NEO: Neuroticism, Extraversion, Openness to Experience. [†] $p < .10$, * $p < .05$, ** $p < .01$, *** $p < .001$.

Openness to Experience. Openness accounted for 5% of the Positive Affect variance on the day of admission only ($\beta = .24^*$). As already suggested by correlations presented above, open persons reported more Positive Affect upon admission than their counterparts.

5.5.3. Neuroticism and Openness Predict State Negative Affect

Neuroticism. As hypothesized, among tested personality traits, Neuroticism was the one associated with most of the Negative Affect outcome variance. Neuroticism shared independent variance with Negative Affect at admission (t1, $\beta = .37^{***}$, see Table 21), day of surgery (t2, $\beta = .28^{**}$), and discharge (t3, $\beta = .29^{**}$). The same was also true for the net of negative affectivity version, Neuroticism/S (Appendix D, Tables D7 to D9). There was no association between Neuroticism and state Negative Affect at six weeks post-surgery.

Table 21
Summary of Hierarchical Regression Analyses Predicting Positive Affect at Different Points in Time

| Outcome | R | R ² | ΔR^2 |
|--------------------|-----|------------------|------------------|
| <hr/> | | | |
| Negative Affect t1 | | | |
| Rival Predictors | .25 | .06 [†] | |
| Neuroticism added | .42 | .18 | .12** |
| <hr/> | | | |
| Negative Affect t2 | | | |
| Rival Predictors | .36 | .13** | |
| Neuroticism added | .45 | .20 | .07** |
| <hr/> | | | |
| Negative Affect t3 | | | |
| Rival Predictors | .17 | .03 | |
| Neuroticism added | .32 | .10 | .07** |
| <hr/> | | | |
| Change NA t2 | | | |
| NA t1 and | | | |
| Rival Predictors | .70 | .49*** | |
| Openness added | .71 | .51 | .02 [†] |

Note. Rival predictors: Age, sex, 1st/2nd Eye. NA: Negative Affect. [†] $p < .10$, * $p < .05$, ** $p < .01$, *** $p < .001$.

Unexpectedly, Neuroticism did not explain significant change variance between the two pre-surgical measurement points, nor pre- to post-surgery. Chronological age, sex, and previous experience with cataract surgery held constant, emotionally labile persons reported more Negative Affect at all pre-surgical and immediately post-surgical measurement points. However, labile persons did not exhibit steeper increases in Negative Affect pre-surgery.

Openness. Openness to Experience which was not significantly correlated with any of the Negative Affect *states* around surgery, did however explain independent parts of change variance between Negative Affect at admission and day of surgery. Again, the effect was very small and only marginally significant ($\beta = -.14^\dagger$). Means in Figure 13 of both measurement points for open individuals and their counterparts illustrate the negative relationship.

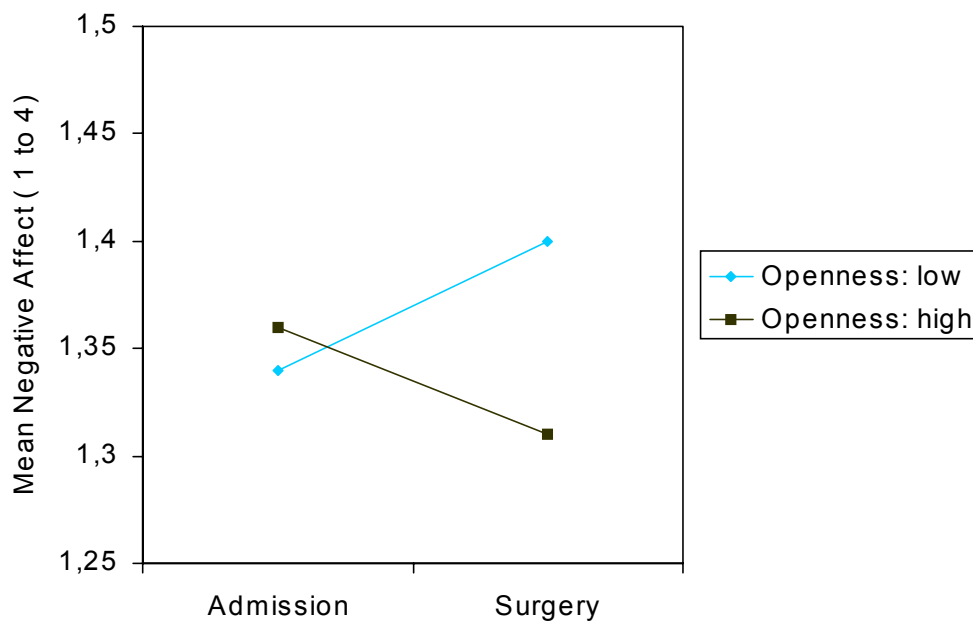

Figure 13 Mean Negative Affect pre-surgery for patients high versus low in Openness to Experience.

In summary, many of the expected personality - affect relationships were found with the present data. Above all, emotionally labile persons indeed reported more Negative Affect not only before, but also immediately after surgery, which is conceived of as the

main stressor in the present study. Nevertheless, persons scoring higher on Neuroticism did not, as was expected, exhibit a steeper increase in Negative Affect between the two pre-surgery measurement points. Patients scoring high on Openness, however, were found to express less Negative Affect just before the operation if prior NA was accounted for. Results also indicated both Extraversion and Openness to Experience being related to Positive Affect prior to surgery, whereas Neuroticism was associated with less positive mood on day of discharge.

5.5.4. Situation-Specific Coping Predicts State Affect

Did pre-surgery coping efforts help deal with the situation? The next section describes the effects of various means of situation-specific coping on affect and affect change pre- to post-surgery. Again, initially, zero-order correlations were examined. Then the different means of situation-specific coping were tested as predictors of affect, controlling for a number of covariates, such as age, sex, and previous experience with cataract surgery by means of hierarchical regression analyses as outlined above. Because of intercorrelations between the four coping scales, regression analyses were performed, entering all coping strategies at once to assess the extent to which coping reactions were uniquely related to affect and affect change around surgery.

Table 22
Pearson Correlations between Situation-Specific Coping and Variables State Positive and Negative Affect

| | Focus on Positive | Support Seeking | Active Coping | Evasive Coping |
|--------------------|-------------------|-----------------|---------------|----------------|
| PA t1 (N = 110) | .40*** | .15 | .31** | .19* |
| PA t2 (n = 102) | .40*** | .08 | .25* | .09 |
| PA t3 (n = 101) | .42*** | .05 | .12 | .06 |
| PA t4 (n = 94) | .18 [†] | -.04 | .22* | .13 |
| NA t1 (N = 110) | -.16 [†] | .39*** | .26** | .20* |
| NA t2 (n = 102) | -.13 | .24* | .08 | .27** |
| NA t3 (n = 101) | .03 | .21* | .20* | .20* |
| NA t4 (n = 94) | -.05 | .34*** | .05 | .11 |

Note. PA= Positive Affect; NA= Negative Affect. [†] $p < .10$, * $p < .05$, ** $p < .01$, *** $p < .001$.

How did situation-specific coping reactions relate to affect? A look at zero-order correlations (Table 22) reveals several associations. Focus on the Positive was related to Positive Affect pre- to post-surgery, but negatively to not at all to Negative Affect. Support Seeking was associated primarily with Negative Affect. Active Coping was positively correlated with Positive Affect as well as Negative Affect at t1 (admission to the hospital). On the day of surgery (t2), Active Coping was connected to higher PA, and six weeks later, as well. Evasive Coping was primarily positively associated with Negative Affect during the hospital assessments, yielding only a rather small correlation with Positive Affect at t1.

Results of hierarchical regression analyses with affect measures as outcome variables, age, sex, and previous experience as control variables (1st Step)⁸, and all situation-specific coping reactions (2nd Step) are presented next. Affect at the respective previous assessment was added as another predictor to the first block of the regression analyses when change was looked at.

5.5.5. Situation-Specific Coping Predicts State Positive Affect

In terms of Positive Affect, focusing on positive aspects of the situation turned out to be the only major predictor, sharing independent variance with positive mood at admission (t1; $\beta = .34^{***}$), day of surgery (t2; $\beta = .37^{***}$), and discharge (t3; $\beta = .40^{***}$), as well as with change in positive mood before surgery (t1 to t2; $\beta = .17^*$), and marginally peri-surgery (day of surgery to discharge; $\beta = .14^\dagger$; see Tables 23). At all measurement points directly surrounding surgery, patients who focused on positive aspects of the situation reported more positive emotions. Furthermore, patients who used this coping strategy exhibited increases in Positive Affect between the two pre-surgical measurement points and from surgery to discharge. The only other coping strategy that mostly provided marginal contributions to Positive Affect was Active Coping (t1: $\beta = .21^*$; t2: $\beta = .20^\dagger$). Table 23 indicates summaries of regression analyses predicting Positive Affect and amounts of variance explained by predictors.

⁸ To reduce the number of predictors in regression analyses, not all rival predictors of Positive Affect were controlled for at once. Rather, control analyses were split. If not indicated otherwise, additional controls bore little or no impact on results reported in this chapter. Documentation of further control analyses can be found in the Appendix C, Section 8.3.4.

Table 23
Summary of Hierarchical Regression Analyses Predicting State Positive Affect at Different Points in Time

| Outcome | R | R ² | ΔR ² |
|------------------------------|-----|----------------|------------------|
| Positive Affect t1 (N = 110) | | | |
| Rival Predictors | .30 | .09* | |
| Sit.-Spec. Coping added | .53 | .28 | .19** |
| Positive Affect t2 (n = 102) | | | |
| Rival Predictors | .34 | .11** | |
| Sit.-Spec. Coping added | .53 | .28 | .17*** |
| Positive Affect t3 (n = 101) | | | |
| Rival Predictors | .28 | .08* | |
| Sit.-Spec. Coping added | .48 | .23 | .15** |
| Positive Affect t4 (n = 94) | | | |
| Rival Predictors | .10 | .01 | |
| Sit.-Spec. Coping added | .30 | .09 | .08 |
| Change PA t2 (n = 102) | | | |
| PA t1 and | | | |
| Rival Predictors | .72 | .52*** | |
| Sit.-Spec. Coping added | .74 | .55 | .03 [†] |
| Change PA t3 (n = 101) | | | |
| PA t2 and | | | |
| Rival Predictors | .74 | .55*** | |
| Sit.-Spec. Coping added | .76 | .58 | .02 |

Note. Rival predictors: Age, sex, 1st/2nd Eye. PA: Positive Affect. Sit.-Spec.: Situation-specific. [†] $p < .10$, * $p < .05$, ** $p < .01$, *** $p < .001$.

5.5.6. Situation-Specific Coping Predicts State Negative Affect

With regard to Negative Affect on the day of admission (t1), Support Seeking ($\beta = .34***$), Focus on Positive ($\beta = -.23*$), and (marginally) Active Coping ($\beta = .18^*$) predicted unique parts of the variance (Table 24). On the day of surgery, only Evasive Coping made a significant contribution ($\beta = .27*$). None of the coping strategies predicted negative mood at discharge; however, six weeks post-surgery, negative emotions were predicted by Support Seeking ($\beta = .40***$). In terms of longitudinal analyses, changes in Negative Affect pre-surgery were associated with Evasive Coping

($\beta = .22^{**}$), indicating a steeper rise in Negative Affect pre-surgery in patients who made use of these coping strategies. Also, when t3 Negative Affect (NA at discharge) was controlled for, Seeking Support was still associated with negative mood six weeks post-surgery ($\beta = .39^{***}$).

Table 24
Summary of Hierarchical Regression Analyses Predicting State Negative Affect

| Outcome | R | R ² | ΔR^2 |
|------------------------------|-----|--------------------|--------------------|
| Negative Affect t1 (N = 110) | | | |
| Rival Predictors | .24 | .06 [†] | |
| Sit.-Spec. Coping added | .52 | .27 | .22 ^{***} |
| Negative Affect t2 (n = 102) | | | |
| Rival Predictors | .36 | .13 ^{**} | |
| Sit.-Spec. Coping added | .49 | .24 | .12 ^{**} |
| Negative Affect t4 (n = 94) | | | |
| Rival Predictors | .17 | .03 | |
| Sit.-Spec. Coping added | .39 | .16 | .13 [*] |
| Change NA t2 (n = 102) | | | |
| NA t1 and | | | |
| Rival Predictors | .70 | .49 ^{***} | |
| Sit.-Spec. Coping added | .73 | .53 | .04 |
| Change NA t4 (n = 86) | | | |
| NA t3 and | | | |
| Rival Predictors | .19 | .04 | |
| Sit.-Spec. Coping added | .41 | .16 | .13 [*] |

Note. Rival predictors: Age, sex, 1st/2nd Eye. NA: Negative Affect. Sit.-Spec.: Situation-Specific. [†] $p < .10$, * $p < .05$, ** $p < .01$, *** $p < .001$.

The different situation-specific coping responses were related with affect states at different points in time predominantly in the hypothesized way. Focusing on the positive side of the situation seemed to have beneficial effects for most patients and was also the most reported coping response comprising strategies, such as Positive Reframing, Humor, and Acceptance. It was most strongly related to Positive Affect at different time points directly surrounding surgery as well as with change in Positive Affect before and after the event. Focus on Positive coping was also inversely

associated with Negative Affect. Active Coping seemed to have twofold effects at least before surgery, being positively correlated with both Negative and Positive Affect at these points in time. Evasive Coping responses exhibited before surgery, being a conglomerate of strategies which are often termed immature or even neurotic coping in the literature, expectedly seemed to contribute to a rise in bad mood just before the operation.

Somewhat surprisingly, Seeking Support strategies were apparently not so much of a consolatory nature as suggested by many other studies (e.g., Schröder & Schwarzer, 2001). Not only was Support Seeking unrelated to Positive Affect, it was even associated with more Negative Affect, which might have to do with the "having to ask for help"-aspect involved. To shed further light on the findings involving Support Seeking especially, the possibility of differing correlations with the outcomes in natural subgroups of the sample was taken into consideration. Would there be differences in the associations between Support Seeking and Positive or Negative Affect among patients of different ages or gender? To answer this question, interaction terms with chronological age and sex were built, and their effects on mood surrounding the central stressor were examined. According to Aiken and West (1991), to avoid problems with heightened collinearity in regression analyses with interaction terms, both components of each interaction term were first centered around their sample mean and then multiplied. Subsequently, hierarchical regression analyses were computed, entering respective control variables into a first step, both centered single predictors in a next step, and finally, the interaction term into the last step.

Support Seeking and Positive Affect Moderated by Age. While most of the coping-affect relationships encountered were in line with expectations and with the literature, the lack of a positive association of Support Seeking with Positive Affect and, instead, the positive relation with Negative Affect prior to surgery, though reported by some (see Section 3.4.1.), was still somewhat surprising and thus warrants further examination. Two interaction effects indicated a moderating role of chronological age when it came to the association of Seeking Support pre-surgery with Positive Affect on the day of surgery (t_2 ; $B = -.03^{**}$, $\Delta R^2 = .06^{**}$) as well as change of Positive Affect from admission to surgery ($B = -.02^{***}$, $\Delta R^2 = .05^{***}$). Figure 14 presents simple PA means

across the two pre-surgical time points for different age-groups with different levels of Support Seeking.⁹

Two features of Figure 14 stand out: (a) The youngest age-group (younger than 65 years; solid boxes) reported more Positive Affect in connection with high levels of Support Seeking; (b) the oldest age group (older than 75 years; circles) endorsing much

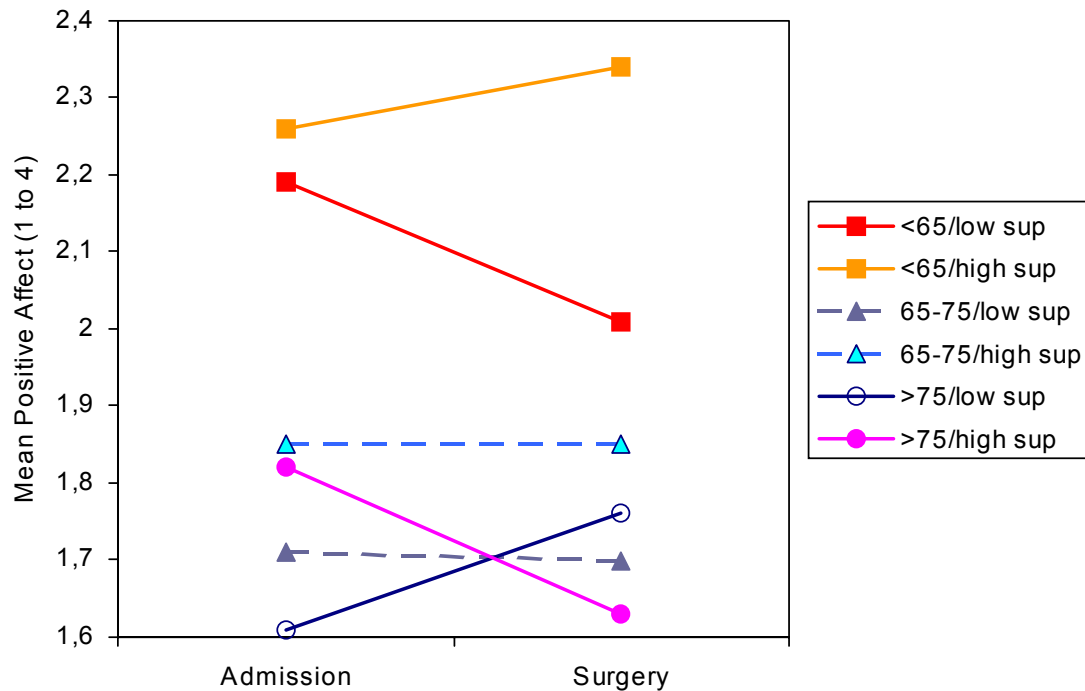

Figure 14 Simple Positive Affect means across the two pre-surgical time points for different age groups with different levels of Support Seeking (situation-specific). (sup = Support Seeking)

Support Seeking reported lower and decreasing levels of Positive Affect pre-surgery. While means in Figure 14 were not corrected for covariates, follow-up analyses for the oldest age-group confirmed the trend suggested by the depicted means. Looking at participants older than 75 years of age, and at the same time controlling for medical and demographic covariates of Positive Affect,¹⁰ there was a relatively strong negative relationship ($\beta = -.34^*$, $\Delta R^2 = .11^*$; $n = 34$) of Support Seeking on the change of Positive Affect from admission (t1) to surgery (t2). As for patients younger than 65 years of age, the positive relationship between Support Seeking and change in Positive

⁹ The three age groups (younger than 65, between 65 and 75, older than 75) were formed for convenience of presenting the means and follow-up analyses. Nevertheless, interaction terms were tested, using regression analyses leaving all components in their continuous form.

Affect pre-surgery (as suggested by Figure 14) could not be confirmed by follow-up regression analysis.¹¹ Regarding the positive relationship between Support Seeking and Negative Affect, there was no indication of it being further qualified by age; however, slight differences between men and women were found here.

Support Seeking and Negative Affect Moderated by Sex. Turning to the prediction of Negative Affect, for NA at t1 a marginally significant interaction involving Support Seeking and sex was found ($B = -.17^\dagger$, $\Delta R^2 = .03^\dagger$) established covariates of Negative Affect (age, 1st/2nd Eye) were controlled for at all times. Following up this interaction then involved testing men and women separately to further explore the nature of the interaction. Doing so revealed that the association between Support Seeking and Negative Affect was the same direction for both men and women. However, it was much stronger and highly significant for men ($\beta = .52^{***}$, $\Delta R^2 = .27^{***}$; $n = 48$), whereas for women, the association did not reach a 10% significance level ($\beta = .19$, $\Delta R^2 = .03$; $n = 62$). Figure 15 presents simple means of Negative Affect at admission exhibited by men and women with different levels of Seeking Support.

Means in Figure 15 show a relatively large difference in Negative Affect for men with low levels of Support Seeking versus those with high levels. Although the difference was not as pronounced with women and barely failed to reach significance, it headed into the same direction nevertheless.¹²

In summary, a closer examination of the Support Seeking-Affect relationships yielded further qualification by both chronological age and sex. For primarily older patients in the sample, Seeking Support was associated with a drop in Positive Affect prior to surgery. On the other hand, Negative Affect on the day of admission was considerably

¹⁰ Rival predictors of PAT2: Sex, 1st/2nd Eye, multimorbidity, and type of anesthesia.

¹¹ Almost identical results were found using simple slope analyses, as recommended by Aiken and West (1991). With this method, first a new variable, Age_{cv} , is created, which is the original (centered) variable C-Age minus a conditional value of interest, e.g., + 1 SD of C-Age, for one SD above the mean of C-Age. Secondly, the cross product of the new variable with the other predictor of interest, e.g., C-Support Seeking is formed. Finally, the criterion is regressed on the predictors C-Support Seeking, Age_{cv} , and their cross product. The resulting regression coefficient for C-Support Seeking is then the desired simple coefficient.

¹² For this reason, in further analyses involving Support Seeking predicting NA at t1, men and women were not examined separately, but left as one sample.

higher in men who sought support prior to surgery when compared to those who did not, with a similar though much weaker tendency found among women.

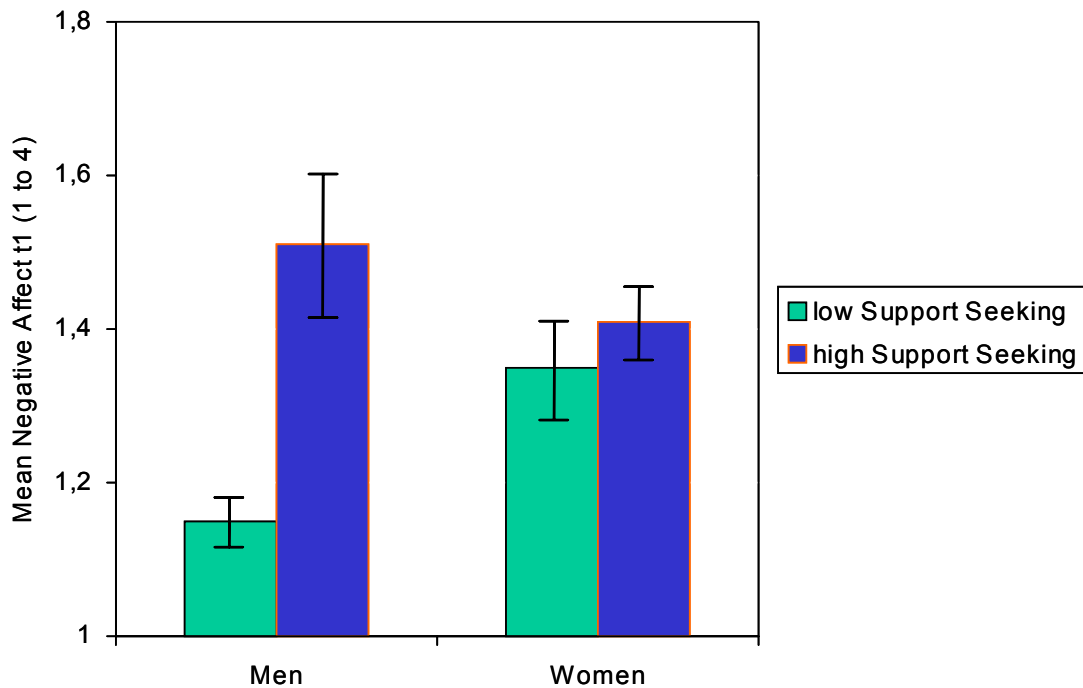

Figure 15 Mean Negative Affect upon admission for men and women high and low in levels of Support Seeking (situation-specific).

5.5.7. Personality Predicts Situation-Specific Coping

The next section reports findings on the association between personality traits and situation-specific coping variables. First, simple correlations were inspected. Secondly, hierarchical regression analyses were performed to find out about unique relations between personality traits and coping net of a number of control variables. Since these analyses comprise part of the path analytic procedures to determine a possible mediator status of coping, control variables employed here are the same as those used for the entire model (i.e., age, sex, previous experience with cataract surgery). Generally, the covariates tested bore little impact on the results, exceptions are highlighted at the end of respective sections. For documentation on additional control analyses, see Appendix C, Section 8.3.5.

Once more, zero-order correlations between personality traits and situation-specific coping strategies were looked at (see Table 25). Confirming expectations and earlier findings from the literature, emotionally labile persons tended to report more Evasive

Coping. Also, Extraversion seemed connected with focusing on the positive aspects of the situation, and Openness to Experience was related with Active Coping. Notably, Support Seeking was not associated with Extraversion, but with Neuroticism in this sample. For Neuroticism/S and Extraversion/S, net of affectivity items, nearly identical relations with situation-specific coping emerged (Appendix D, Table D11).

Table 25
Pearson Correlations between Personality Traits and Situation-Specific Coping

| Coping Situation-Specific | Neuroticism | Extraversion | Openness |
|---------------------------|-------------|--------------|----------|
| Focus on Positive | -.12 | .26** | .15 |
| Active Coping | .07 | .06 | .23* |
| Support Seeking | .27** | .10 | .08 |
| Evasive Coping | .25* | .03 | -.09 |

Note. N = 110. † $p < .10$, * $p < .05$, ** $p < .01$, *** $p < .001$.

Next, each situation-specific coping strategy was predicted using hierarchical regression analyses (see Table 26). To capture unique relations of personality traits with coping strategies and additionally control for a number of related factors, each analysis contained two blocks. Coping Strategy A was predicted by introducing Strategies B, C, and D, followed by age, sex, and previous experience with cataract surgery¹³ to the first step of the equation. The second step then contained one of the three personality variables, Neuroticism, Extraversion, or Openness to Experience.

Neuroticism Predicts Coping. Using hierarchical regression analysis to regress single coping strategies on rival predictors and Neuroticism revealed largely the same picture as correlations did previously. Neuroticism was still related to Seeking Support ($\beta = .17^\dagger$) and Evasive Coping ($\beta = .20^*$), although both associations were weakened considerably by partialling the other related coping strategies. Doing the latter, however, revealed a significant negative relationship with Focus on Positive ($\beta = -.20^*$),

¹³ In additional control analyses, depending on the situation-specific coping strategy predicted, different medical variables served as further controls. With Focus on Positive as the dependent variable, previous experience with cataract surgery was entered. Predicting Support Seeking, multimorbidity was controlled for, and in the case of Active Coping as the dependent variable, pre-surgical visual acuity in the eye operated on and type of anesthesia were accounted for (see Appendix C, Section 8.3.5.).

indicating that emotionally labile patients used less strategies which focus the attention on the positive aspects of the situation. This association did not hold when the net of negative affectivity version, Neuroticism/S, was entered into the equation ($\beta = -.17$, n.s.). Neuroticism/S still predicted Seeking Support ($\beta = .16^\dagger$) and Evasive Coping ($\beta = .21^*$), however.

Extraversion Predicts Situation-Specific Coping. Extraversion singularly predicted situation-specific Focus on Positive coping ($\beta = .23^*$), which appeared to be unrelated to the other strategies, leaving the amount of prediction by Extraversion largely untouched. The same was true when the abbreviated net of positive affectivity form, Extraversion/S, was entered into the equation ($\beta = .22^*$).

Table 26
Summary of Hierarchical Regression Analyses Predicting Situation-Specific Coping Responses

| Coping Situation-specific (N = 110) | Focus on Positive | | Active Coping | | Seeking Support | | Evasive Coping | |
|-------------------------------------|-------------------|--------------|---------------|--------------|------------------|------------------|----------------|--------------|
| | β | ΔR^2 | β | ΔR^2 | β | ΔR^2 | β | ΔR^2 |
| Rival Predictors | | .12* | | .23*** | | .27*** | | .25*** |
| Neuroticism | -.20* | .03* | -.01 | .00 | .17 [†] | .02 [†] | .20* | .03* |
| Rival Predictors | | .12* | | .23*** | | .27*** | | .25*** |
| Extraversion | .23* | .05* | -.01 | .00 | .08 | .01 | -.04 | .00 |
| Rival Predictors | | .12* | | .23*** | | .27*** | | .25*** |
| Openness | .14 | .02 | .25** | .06** | .05 | .00 | -.21* | .04* |

Note. [†] $p < .10$, * $p < .05$, ** $p < .01$, *** $p < .001$. Rival predictors: Age, sex, 1st/2nd Eye, all coping scales except for the one serving as dependent variable. Betas are last step.

Openness Predicts Situation-Specific Coping. Controlling for variables, including age, sex, previous experience with cataract surgery, and all coping strategies but the one predicted, Openness to Experience was still related to Active Coping ($\beta = .25^{**}$) and negatively to Evasive Coping ($\beta = -.21^*$). The latter association had not been visible considering bivariate correlations and has likely been suppressed by Active Coping as

follow-up partial correlations showed. Controlling for Active Coping, the correlation of Openness with Evasive Coping was $r_{Active Coping} = -.20$ ($p = .034$).

Having established most of the expected associations between higher-order personality traits and coping responses, the following sections further explore the role of coping in the adaptational process once personality is taken into consideration.

5.5.8. Coping as a 'Personality Process'?

Having met the necessary criteria to test a mediator hypothesis as outlined by Baron and Kenny (1986), i.e., ascertaining relationships between independent variables (higher-order personality traits) and outcome (affect), mediator (coping) and outcome, as well as independent variables and mediators, now the interplay between independent variable and mediator is tested. To prove mediation, it is important to show that the direct effect of the independent variable on the outcome criteria vanishes or is at least substantially reduced when the proposed mediator is controlled for. All of the preceding analyses have to be taken into account while judging whether mediation takes place.

To proceed, once more a set of hierarchical regression analyses were computed, using the already established control-criteria as predictors in a first block. Personality-coping relationships were also tested again, using different subsets of the continuing sample ($N = 110$ for t1; $n = 102$ for t2; $n = 101$ for t3). Subsequently, one full regression analysis was computed entering control criteria (Step 1), one of the three personality traits (Step 2), and, in the final block, all four coping strategies. Because the equations tested resulted in a large number of predictors, it was refrained from entering all personality variables at once. Instead, analyses were carried out, testing each personality predictor by itself. However, to establish unique contributions of the coping strategies as proposed mediators, and because of considerable intercorrelation of the same, all of them were entered as one block.

The following sections will deal with the established independent variables and proposed mediators for Negative Affect prior to surgery (admission and day of surgery), i.e., Neuroticism, Openness to Experience, and coping. Since Neuroticism was only related to NA-states at measurement points t1, t2, and t3, but not at t4, no model involving the fourth measurement point of NA is presented. Also, Neuroticism did not

account for changes in Negative Affect. Hence, only one longitudinal model involving Openness as an independent variable was computed. While Neuroticism was associated with independent variance of Negative Affect at discharge (t3), coping strategies were not. Thus, for a prediction of Negative Affect at t3, the necessary requirements for mediation were not met, and a model was not tested. Following Negative Affect, models for states and changes of Positive Affect are presented. In the case of Positive Affect, models were computed entering only those personality variables that, controlling for the other two, predicted an independent and significant part of the variance of the outcome (see Section 5.5.2.). Thus, when Positive Affect at t1 (admission) served as an outcome variable, Openness to Experience was entered as the independent variable (to the 2nd step of hierarchical regression, as outlined above), predicting t2 Positive Affect, Extraversion was entered, and predicting PA at discharge (t3), Neuroticism was entered into the regression equation. Accounting for the change in PA pre-surgery, Extraversion was entered into the equation, and examining change from immediately pre- to post-surgery, Neuroticism was used as an independent variable.

5.5.9. Coping Mediates the Relationship Between Personality Traits and Negative Affect?

Figures 16 and 17 present the results of path analyses showing how Neuroticism relates to Negative Affect at admission to the hospital as well as on the day of surgery (prior to surgery). Using a series of multiple regression analyses as described earlier, the Neuroticism- NA relationships can be divided into two parts, a part mediated through coping (the indirect effect of Neuroticism on NA) and a part unrelated to coping (the direct effect of Neuroticism on Negative Affect). To demonstrate mediation, the indirect effect should be relatively large.

Relating Neuroticism to NA at t1 while controlling for age, sex, previous experience with cataract surgery and all four coping strategies, its standardized regression coefficient drops from $\beta_{(without\ coping\ controlled)} = .37^{***}$ to $\beta_{(with\ coping\ controlled)} = .25^{**}$. The latter coefficient is the direct effect of Neuroticism on NA at admission. While this direct effect is still significant, the indirect effect of Neuroticism through coping variables took over just about one third of the Neuroticism - Negative Affect relationship (32.4%).

How much did each coping scale contribute to this joint indirect effect? To determine unique contributions, a product term was built of (a) the partial relationship between Neuroticism and the respective coping scale, and (b) the partial relationship between this coping scale and Negative Affect at t1 (indicated as numbers in parentheses beneath the titles of each coping scale in Figure 16).

Two coping variables contributed to the partial mediation presented in the model, i.e., Focus on Positive (.04 units of the total indirect effect; $\beta = -.18^*$) and Seeking Support (.05 units; $\beta = .30^*$). Thus, the higher negative mood on admission day reported by emotionally labile persons may be explained in part by their more restricted use of Focus on Positive coping and enhanced Support Seeking. Another coping response exhibiting unique relations with NA at t1 was Active Coping ($\beta = .18^*$). The more patients engaged in active forms of coping, the higher their Negative Affect on admission day.

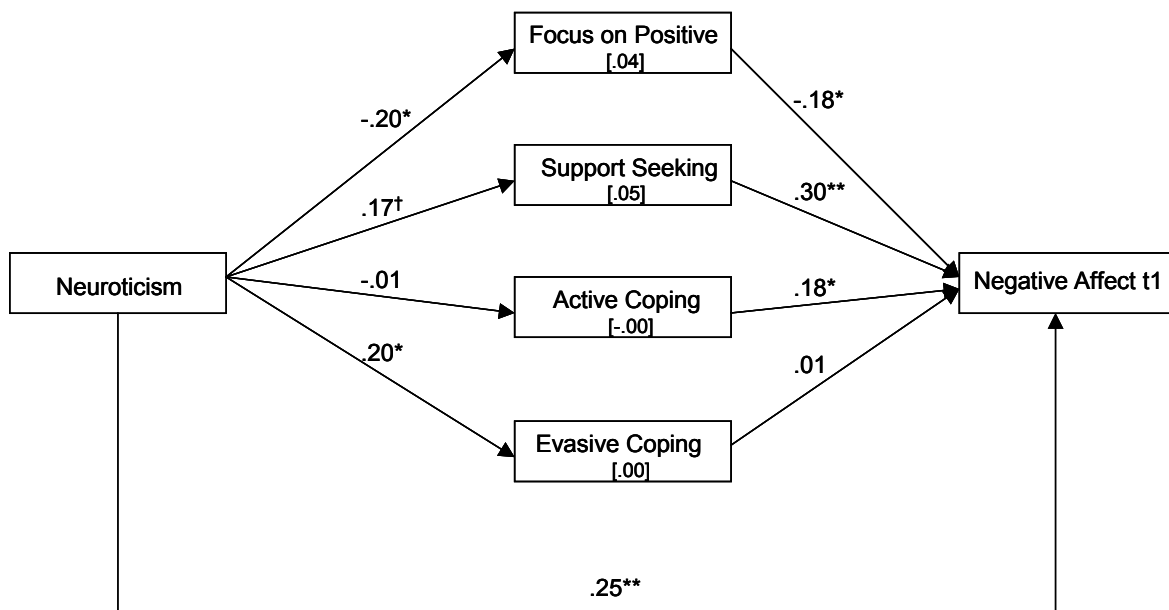

Figure 16 Relationship among Neuroticism, situation-specific coping, and Negative Affect at t1: Standardized regression coefficients ($N = 110$). Arrows from Neuroticism to each coping scale indicate standardized partial regression coefficients, net of age, sex, and 1st/2nd Eye. Numbers in parentheses are mediational effects of each coping scale.

Predicting Negative Affect on the day of surgery (t2), the standardized regression coefficient for the direct effect of Neuroticism drops to $\beta = .17^\dagger$ when coping is controlled for, as opposed to a unique effect of $\beta = .28^{**}$ without taking coping into account (39.29% drop). Most of this partial mediation goes back to Evasive Coping (.05

units of the joint indirect effect), and some to Focus on Positive (.03 units) and Support Seeking (.02 units; Figure 17). However, it is only Evasive Coping that predicts a significant share of unique variance of Negative Affect on the day of surgery ($\beta = .22^*$), suggesting that use of these coping responses was connected to higher negative mood immediately prior to surgery.

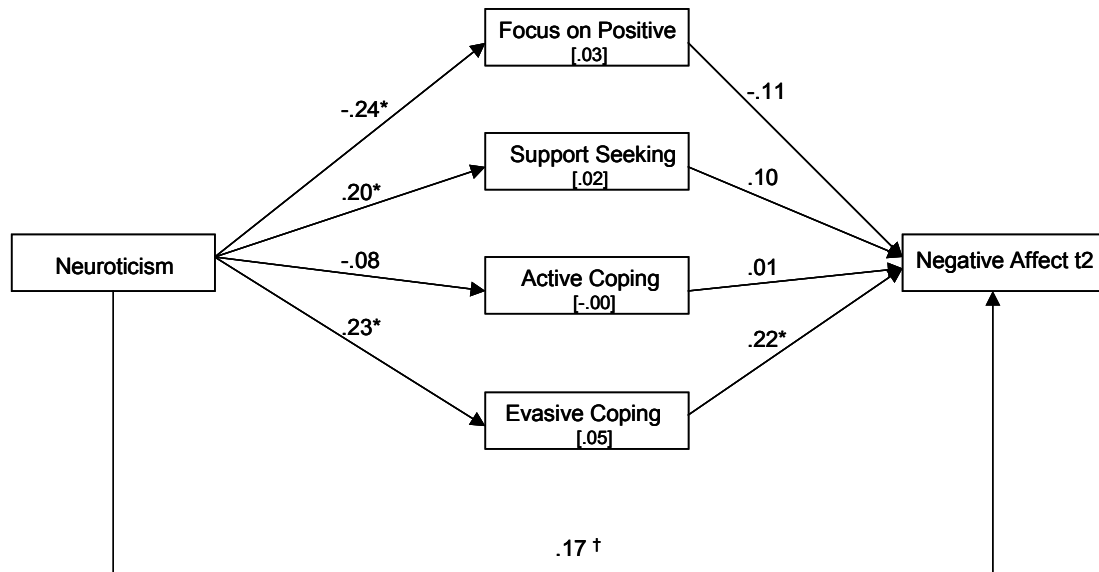

Figure 17 Relationship among Neuroticism, situation-specific coping, and Negative Affect at t2: Standardized regression coefficients ($n = 102$). Arrows from Neuroticism to each coping scale indicate standardized partial regression coefficients, net of age, sex, and 1st/2nd Eye. Numbers in parentheses are mediational effects of each coping scale.

Predicting change variance in Negative Affect from admission to hospital to day of surgery, a third model was computed with Openness to Experience as the independent variable, coping as the proposed mediator, and, while controlling for t1 Negative Affect, NA at t2 as the outcome. Again, established control variables age, sex, and previous experience with cataract surgery - along with Negative Affect upon admission day were entered first.

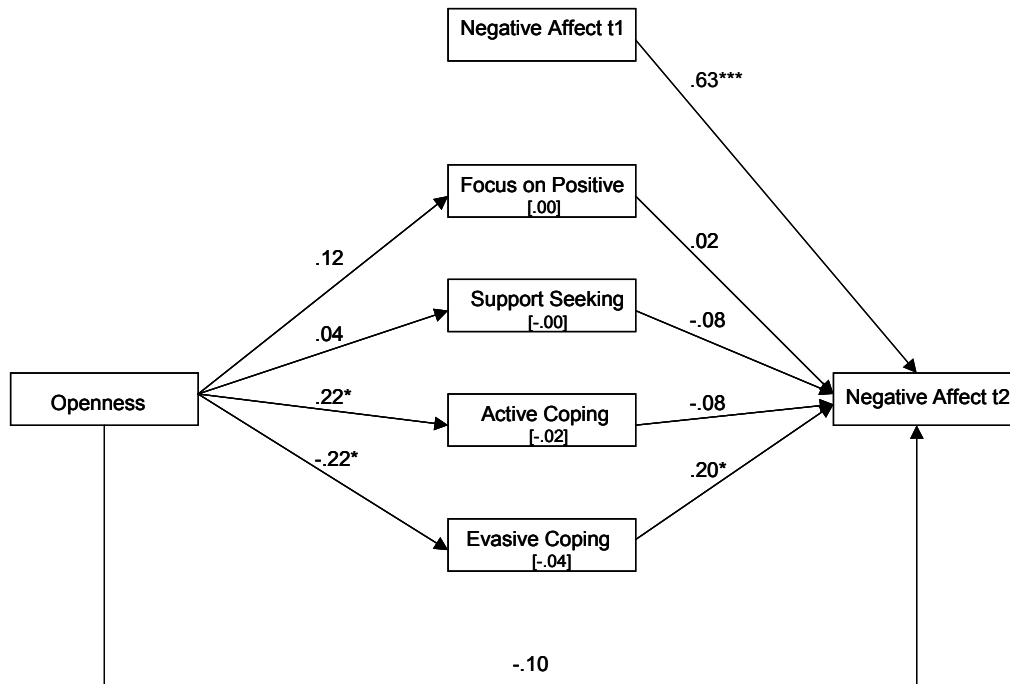

Figure 18 Relationship among Openness, situation-specific coping, and change from Negative Affect at t1 to Negative Affect at t2: Standardized regression coefficients ($n = 102$). Arrows from Openness to each coping scale indicate standardized partial regression coefficients, net of Negative Affect at t1, age, sex, and 1st/2nd Eye. Numbers in parentheses are mediational effects of each coping scale.

Figure 18 shows the model, standardized regression coefficients are displayed net of control variables. Taking coping into account in path analysis reduced the direct effect of Openness on change in Negative Affect from t1 to t2 from a pre-coping $\beta = -.14^\dagger$ to a post-coping $\beta = -.10$ n.s.. The majority of this rather small indirect effect was channeled through Evasive Coping, accounting for .04 units. Other unique contributions to the joint indirect effect through coping ranged closely around zero. Most likely due to the tightly spaced measurement occasions, the effect of t1 Negative Affect on t2 NA is quite large ($\beta = .63^{***}$).

5.5.10. Coping Mediates the Relationship Between Higher-Order Personality Traits and Positive Affect?

Since Openness to Experience was the only personality variable independently connected with Positive Affect at t1 (admission), a path analysis was conducted containing Openness as an independent variable, coping responses as proposed

mediators, and positive mood as the outcome (see Figure 19, effects are again net of age, sex, and previous experience with cataract surgery). While the direct effect of Openness on PA at t1 dropped by about one third from $\beta_{\text{pre-coping}} = .24^*$ to $\beta_{\text{post-coping}} = .16^\dagger$, Focus on Positive ($\beta = .32^{***}$) and Active Coping ($\beta = .16^\dagger$) still predicted

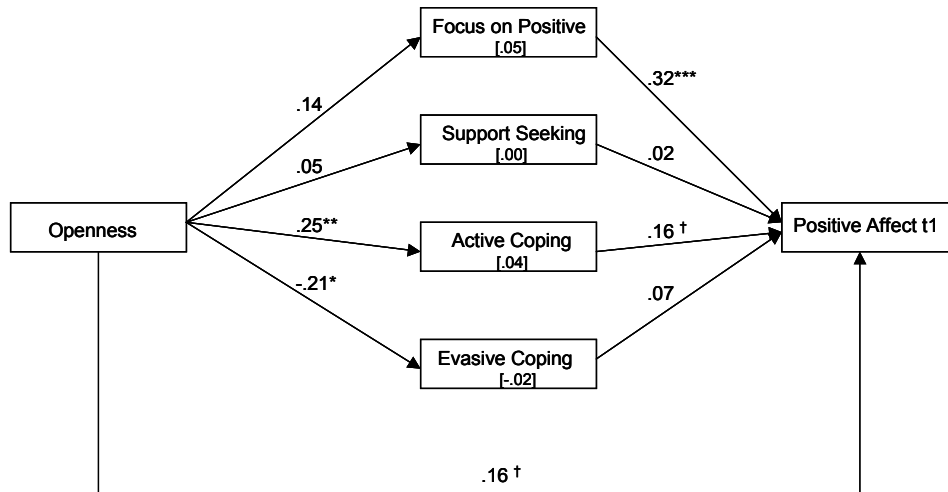

Figure 19 Relationship among Openness, situation-specific coping, and Positive Affect at t1: Standardized regression coefficients ($N = 110$). Arrows from Openness to each coping scale indicate standardized partial regression coefficients, net of age, sex, and 1st/2nd Eye. Numbers in parentheses are mediational effects of each coping scale.

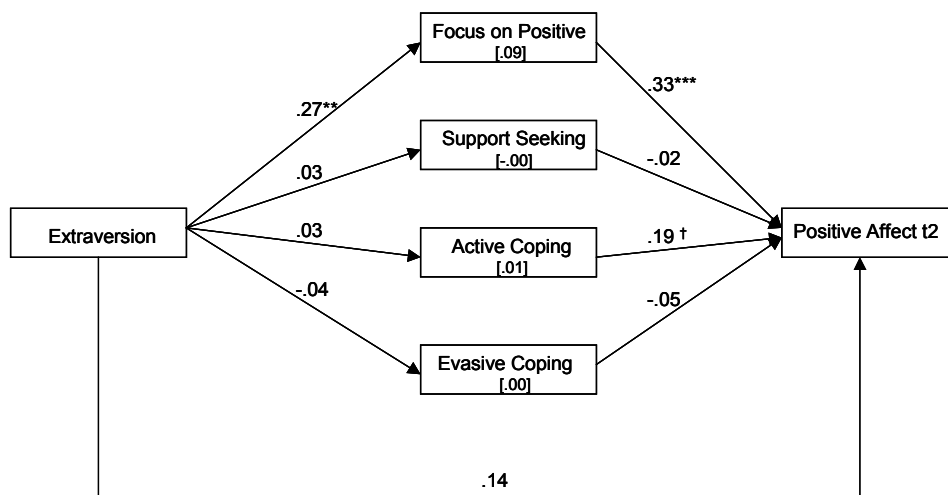

Figure 20 Relationship among Extraversion, situation-specific coping, and Positive Affect at t2: Standardized regression coefficients ($n = 102$). Arrows from Extraversion to each coping scale indicate standardized partial regression coefficients, net of age, sex, and 1st/2nd Eye. Numbers in parentheses are mediational effects of each coping scale.

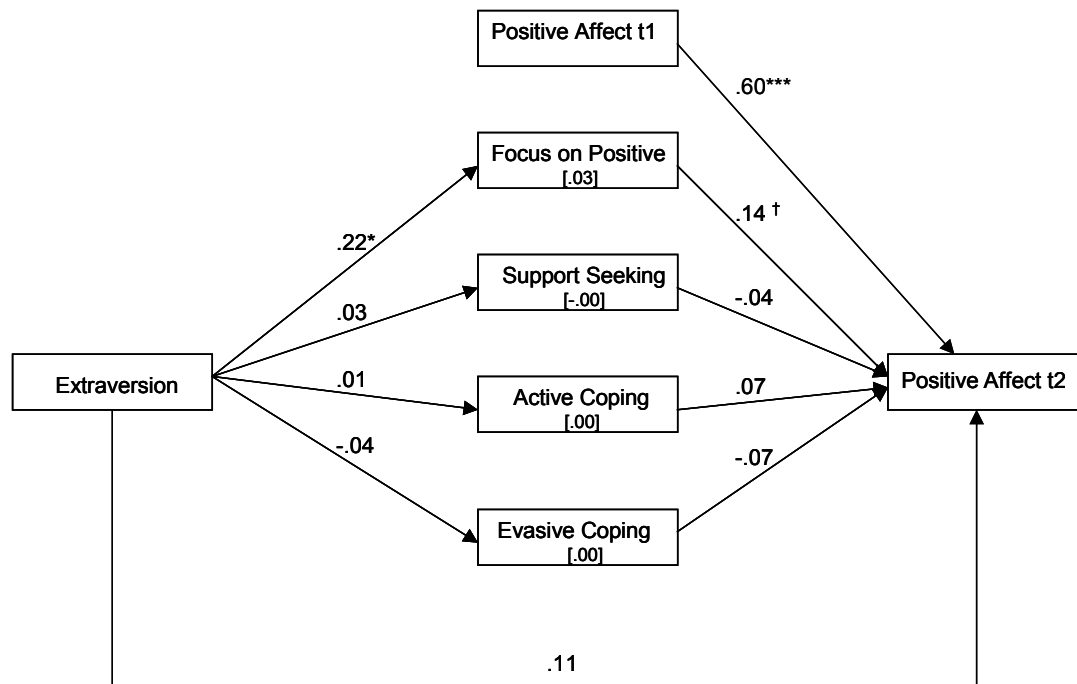

Figure 21 Relationship among Extraversion, situation-specific coping, and change of Positive Affect at t1 to Positive Affect at t2: Standardized regression coefficients ($n = 102$). Arrows from Extraversion to each coping scale indicate standardized partial regression coefficients, net of Positive Affect at t1, age, sex, and 1st/2nd Eye. Numbers in parentheses are mediational effects of each coping scale.

Positive Affect on admission day. Both of these coping responses carried the major weight of the joint indirect effect (.05 units for Focus on Positive, and .04 units for Active Coping), while unique indirect effects of Support Seeking and Evasive Coping ranged around zero.

Concerning Positive Affect at t2 (day of surgery), in a first set of analyses, Extraversion coping relationships were re-analysed, with t2 continuing subsample of $n = 102$. Subsequently, Extraversion was entered as the independent variable and coping variables as proposed mediators (while controlling for age, sex, and previous experience with cataract surgery). Figure 20 presents the model. Predicting PA at t2, coping variables and especially Focus on Positive (.09 units) partially mediated the relationship between Extraversion and the outcome by taking over approximately 42% of the direct effect. The direct relationship between Extraversion and positive mood on the day of surgery dropped from $\beta_{pre-coping} = .24^*$ to $\beta_{post-coping} = .14$, n.s.

Looking at change in PA from admission to surgery, effects of both Extraversion and coping became very small, reaching only marginal significance due to the large share of residual variance accounted for by the first measurement point (PA t1), which was

entered in the first step of the regression equation. This phenomenon is commonly reported (e.g., Carver et al., 1993) with the residualized-change method of analyzing longitudinal data, especially when repeated assessments are spaced at short intervals. It also represents one reason why this method is often criticized (e.g., Bandura, 1997). However, this method was chosen, because it is a very conservative approach to longitudinal analysis.

As established in Section 5.5.2., the direct effect of Extraversion on change in PA from admission to surgery without taking coping into account was marginally significant, with a $\beta_{pre-coping} = .14^\dagger$. Entering coping into the last step of the hierarchical regression analysis reduced this direct effect only by .03 units to a non-significant $\beta_{post-coping} = .11$. The only coping variable accounting for a small indirect effect of Extraversion on change in PA was again Focus on Positive (.03 units, $\beta = .14^\dagger$). Figure 21 gives an overview.

Regarding Positive Affect at discharge, Neuroticism was considered as the independent variable as only Neuroticism explained a significant amount of independent variance in PA t3 when age, sex, previous experience, as well as Extraversion, and Openness were controlled for (see Section 5.5.2). When coping was controlled for, the direct effect of Neuroticism on Positive Affect at t3 changed by only .03 units from $\beta_{pre-coping} = -.24^*$ to $\beta_{post-coping} = -.21^*$. Among coping variables, only Focus on Positive remained a significant predictor of PA t3 ($\beta = .35^{**}$), accounting for the greater part of the joint indirect effect of coping (Figure 22). This result suggests that emotionally labile patients experienced less Positive Affect on the day of discharge from the hospital. Furthermore, only a small amount of this association was explained by the fact that emotionally labile persons prior to surgery also used fewer coping strategies that shift the attentional focus on positive aspects of the situation, while more focusing on the positive was generally associated with better mood at t3.

Considering change in Positive Affect from day of surgery to discharge, no evidence of mediation was found. Neuroticism's direct effect on the outcome variable remained virtually unchanged by the addition of coping to the equation. Additionally, what was a marginally positive effect of Focus on Positive coping on change between PA t2 and t3 (Section 5.5.5.) was no longer even marginally significant when Neuroticism was entered in the equation ($\beta_{pre-N} = -.14^\dagger$ to $\beta_{post-N} = .11, n.s.$). In fact, when Neuroticism

was accounted for, none of the coping variables were significantly associated with change variance between t2 and t3 (see Figure 23).

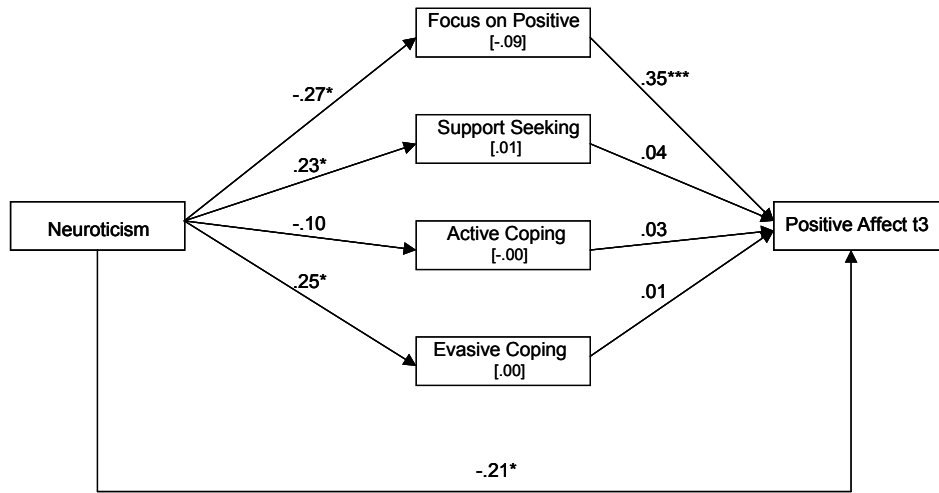

Figure 22 Relationship among Neuroticism, situation-specific coping, and Positive Affect at t3: Standardized regression coefficients (n = 101). Arrows from Neuroticism to each coping scale indicate standardized partial regression coefficients, net of age, sex, and 1st/2nd Eye. Numbers in parentheses are mediational effects of each coping scale.

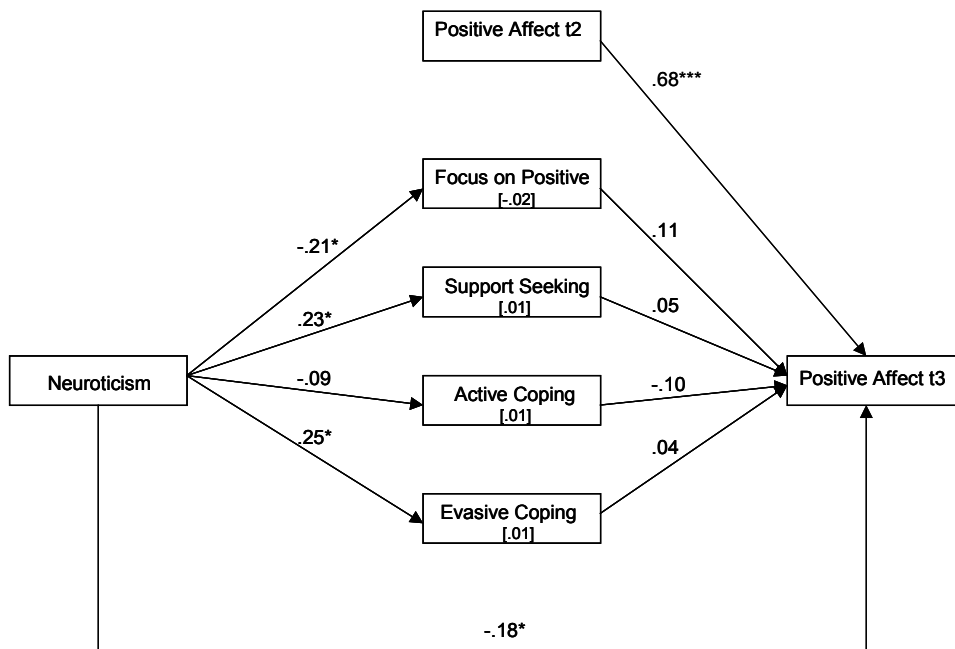

Figure 23 Relationship among Neuroticism, situation-specific coping, and change of Positive Affect at t2 to Positive Affect at t3: Standardized regression coefficients (n = 101). Arrows from Neuroticism to each coping scale indicate standardized partial regression coefficients, net of Positive Affect at t2, age, sex, and 1st/2nd Eye. Numbers in parentheses are mediational effects of each coping scale.

5.5.11. Summary Thus Far: Coping as a Personality Process?

In sum, especially concerning assessments before surgery (t1 and t2), many of the direct effects of personality variables on affect and affect change were at least partially mediated through respective coping strategies. Indirect effects were considerably larger predicting pre-surgery than post-surgery affect. However, in all cases only partial mediation through coping was found. Control analyses with shortened Neuroticism/S and Extraversion/S scales revealed nearly identical results (Appendix D, Tables D16 to D19).

Expectedly, Neuroticism turned out to be the best predictor for both coping and Positive as well as Negative Affect and affect change in the situation. Emotionally labile persons were worse off before as well as after surgery. They experienced more negative mood anticipating the operation and less positive mood afterwards. Moreover, an overall relief expressed in part by the change in Positive Affect from pre- to post-surgery was not as marked for emotionally labile persons when compared to their counterparts. Likewise, more open patients reported more positive mood on the day they checked into the hospital, while dropping in Negative Affect from the first to the second measurement point. Extraverted individuals seemed better off just before they went into surgery. Sometimes considerable parts of these effects seemed due to the way patients *coped with the situation* rather than to higher-order personality traits per se.

5.5.12. Testing an Alternative Model: "Differential Effectiveness"

To establish whether mediation was the only form of interplay between personality variables and coping, interactions between the two in reference to affect and affect change were tested next. Here, only interactions between "significant" mediators (i.e., coping variables that accounted for considerable proportions of the indirect effects) and respective personality traits were tested. So far, results speak for general effects of coping on affect, e.g., regardless of levels of personality traits, focusing on positive aspects of the situation generally was connected with better mood in the situation. But was this in fact the case? To differentiate further, interaction terms were built as products of single personality traits and coping variables. Again, to avoid problems with

heightened collinearity in regression analyses with interaction terms, both components of each interaction term were first centered around their sample mean and then multiplied. Subsequently, hierarchical regression analyses were computed, entering age, sex, and previous experience (plus affect at the previous measurement in longitudinal analyses) into a first step, both centered single predictors in a next step, and finally, the interaction term into the last step. To avoid entering too many variables, interactions of interest were tested one by one.

Only one of the tested interaction terms approached significance. There did not seem to be any "differential effectiveness" (Bolger & Zuckerman, 1995) for emotionally labile persons using support, Evasive Coping, or not using Focus on Positive coping. Likewise, open individuals did not feel better using active coping strategies than did less open individuals. Also, an interaction between Openness and Evasive Coping did not explain variance in the change of NA between assessments at t1 and t2. However, evidence was found pointing to an interaction between Extraversion and Focus on Positive coping ($B = -.15^*$, $\Delta R^2 = .02^*$) when change between Positive Affect at admission and day of surgery was predicted. On the other hand, simply predicting state Positive Affect on the day of surgery did not yield a significant interaction term. Coming back to the change prediction, Figure 24 illustrates simple means in pre-surgical PA for groups of high and low Extraversion and Focus on Positive coping. Follow-up analyses with high and low groups of Extraversion (as established through a median-split procedure) reveal a main effect of Focus on Positive coping on change of PA pre-surgery for introverts only ($\beta = .36^{***}$, $\Delta R^2 = .11^{***}$). For extraverts, on the other hand, no main effect of Focus on Positive on change of PA was found¹⁴. Means for the four groups on two assessments of PA indicate that extraverts reporting much Focus on Positive have the highest values of Positive Affect on both measurement occasions, however, not much change occurs in this group. The same is true for introverts practicing much Focus on Positive coping, although they reported relatively high amounts of positive mood on both measurement points in time, not much change took place. A fairly substantial drop in PA was observed for introverts who did not report using Focus on Positive strategies. They were also the group reporting the lowest PA over measurements.

¹⁴ Again, simple slope analysis as described by Aiken and West (1991) yielded highly comparable results.

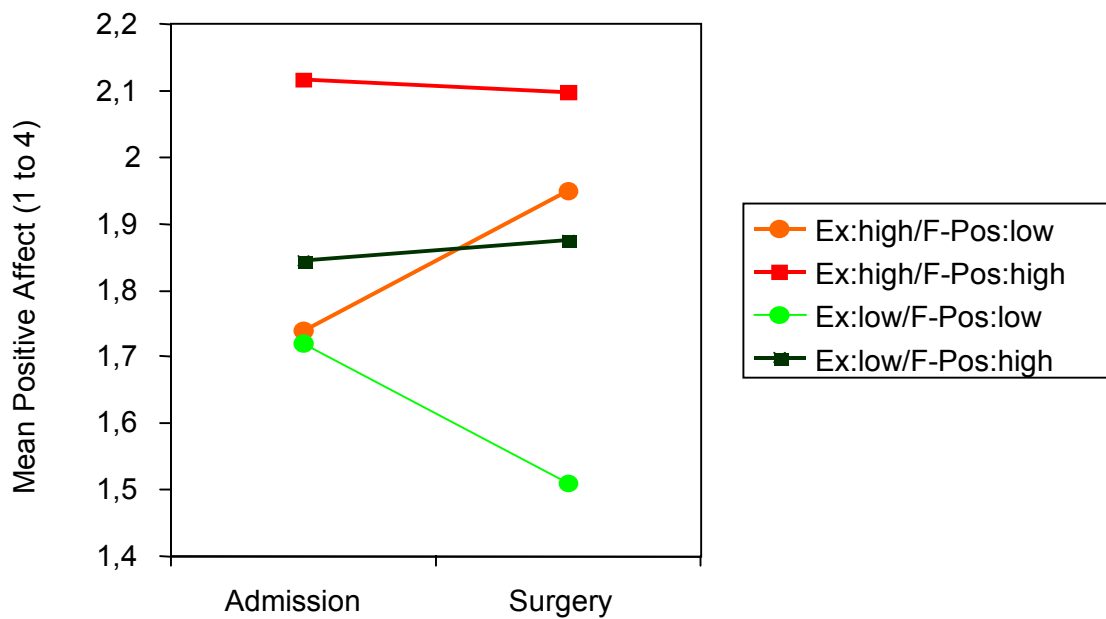

Figure 24 Mean Positive Affect pre-surgery for groups high versus low in Extraversion and Focus on Positive coping (situation-specific). (F-POS: Focus on Positive, situation-specific)

At least concerning pre-surgical change in Positive Affect there was some evidence of differential effectiveness of Focus on Positive coping for more extraverted versus introverted individuals. In terms of change controlled for prior level of PA, introverts seemed to "profit" more from Focus on Positive coping. In addition to already reporting lower positive mood, introverts who did not make much use of this coping strategy prior to surgery also showed a considerable drop in PA while anticipating the intervention. Moreover, simple means as well as prior level analyses (Sections 5.5.2. and 5.5.5.) suggest that scoring high on both measures was associated with highest and most stable positive mood while anticipating surgery.

5.5.13. Another Situation-Specific Outcome: Satisfaction with Coping Predicted by Personality?

Coping satisfaction¹⁵ was examined as an alternative situation-specific outcome variable. One hypothesis pertained to the question of whether or not emotionally labile persons reported less coping satisfaction than stable persons. A preliminary look at zero-order correlations seemed to support this hypothesis for Neuroticism was

negatively related to coping satisfaction. For Extraversion and Openness to Experience, no significant associations were found. Looking at the abbreviated, net of affectivity components, Neuroticism/S and Extraversion/S scales yielded a surprising result: Neuroticism/S net of negative affectivity was no longer associated with coping satisfaction and also, the (formerly non-significant) association between Extraversion (full scale) and Coping satisfaction of $r = .15$, was considerably reduced when the abbreviated Extraversion/S scale was taken into account (see Table 27).

Table 27
Pearson Correlations between NEO-Personality Traits and Coping Satisfaction

| | Neuroticism | Extraversion | Openness |
|---------------------|---------------|----------------|----------|
| Coping-Satisfaction | -.24* | .15 | .07 |
| | Neuroticism/S | Extraversion/S | - |
| | -.12 | .09 | - |

Note. $n = 93$. [†] $p < .10$, * $p < .05$, ** $p < .01$, *** $p < .001$.

It appears that the relation between Neuroticism and coping satisfaction pre-surgery was based largely on the trait Negative Affectivity component.

Next, hierarchical regression analyses were performed. The negative relationship between the full scale Neuroticism and coping satisfaction still held when age, sex, and previous experience with cataract surgery were accounted for as control variables in hierarchical regression analysis (Appendix C, Table C11). Neuroticism ($\beta = -.28^{**}$, $\Delta R^2 = .07^{**}$) accounted for about 7% of the outcome variance. None of the other personality variables accounted for significant parts of variance of coping satisfaction.

5.5.14. Situation-Specific Coping Predicts Satisfaction with Coping Efforts?

Next, hypothesized relations between situation-specific coping responses and coping satisfaction were tested. Zero-order correlations revealed associations in expected directions (see Table 28). Resembling the results by McCrae and Costa (1986), a marginal negative association was found between Evasive Coping and coping

¹⁵ As discussed in Section 5.1.6., one multivariate outlier (Case 137) was excluded from all further analyses concerning coping satisfaction, reducing the sample size to $n=93$.

satisfaction. Also, as hypothesized, Active Coping was negatively related with coping satisfaction, whereas Focus on Positive coping was positively associated with it.

Table 28
Pearson Correlations between Situation-Specific Coping and Coping Satisfaction

| | Focus on Positive | Active Coping | Support Seeking | Evasive Coping |
|---------------------|-------------------|---------------|-----------------|-------------------|
| Coping Satisfaction | .27* | -.27* | -.06 | -.20 [†] |

Note. $n = 93$. [†] $p < .10$, * $p < .05$, ** $p < .01$, *** $p < .001$.

Looking at multivariate prediction, again, hierarchical regression analysis was conducted. In a first step, age, sex and previous experience with cataract surgery were included. The next step accounted for all four coping scales at once to tackle unique relationships with coping satisfaction. As with zero-order correlations, Focus on Positive, Active Coping, and Evasive Coping shared independent variance with Coping satisfaction. Focusing on the pleasant aspects of the situation ($\beta = .29^{**}$) was associated with more self-rated coping satisfaction prior to surgery. Coping actively ($\beta = -.27^*$) as well as practicing Evasive Coping ($\beta = -.20^{\dagger}$) on the other hand were connected with less satisfaction with one's coping efforts. Taken together, coping accounted for 17% ($p < .01$) of the outcome variance (Appendix C, Table C12).

5.5.15. Does Coping Mediate between Personality and Coping Satisfaction?

To test the full mediator model for coping satisfaction, again a path analytic approach was taken. First, a set of hierarchical regression analyses (outcome: one coping scale; 1st step: control criteria and three coping scales, 2nd step: Neuroticism), were conducted to re-estimate Neuroticism-coping relationships using the continuing subsample $n = 93$ ¹⁶. With this portion of the full sample, associations between Neuroticism and coping remained fairly stable; with one exception, the relation with Evasive Coping was no longer significant ($\beta = .16, p = .14$).

¹⁶ Ninety-four patients responded at t1 and t4. One case (no. 137) was a multivariate outlier and excluded from analyses (see Section 5.1.6.).

In a next step, another hierarchical regression analysis was computed, with coping satisfaction serving as an outcome variable that was predicted by control criteria age, sex, and previous experience with cataract surgery (1st block), Neuroticism (2nd block), and coping responses (3rd block). Figure 25 presents the model. To reduce complexity, covariates were not included in the figure; however, all effects are net of age, sex, and 1st/2nd Eye.

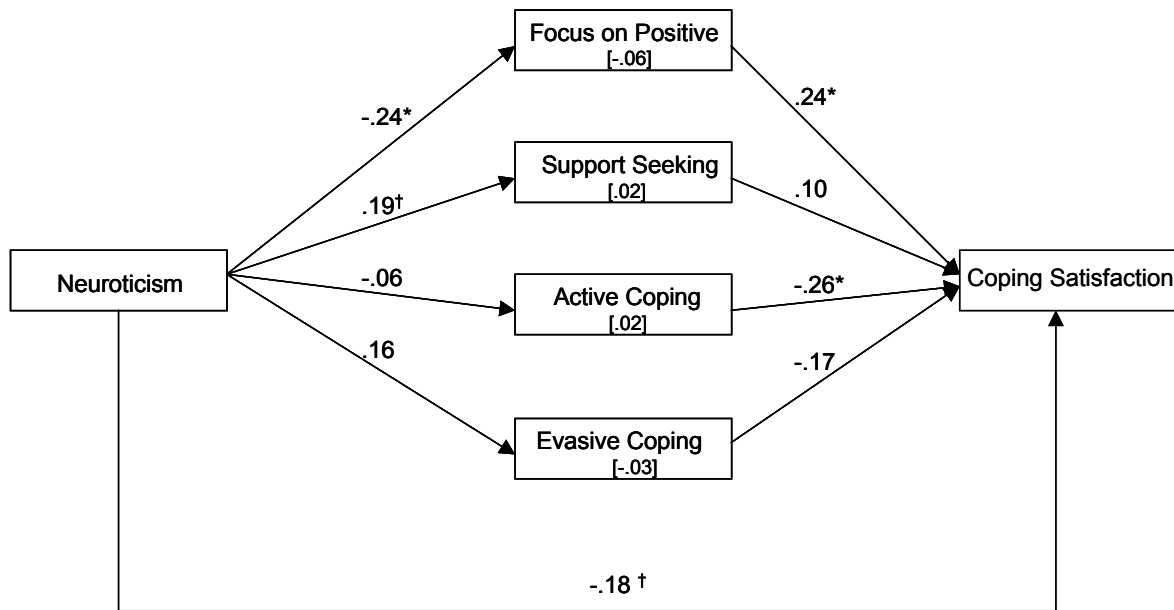

Figure 25 Relationship among Neuroticism, situation-specific coping, and coping satisfaction: Standardized regression coefficients ($n = 93$). Arrows from Neuroticism to each coping scale indicate standardized partial regression coefficients, net of age, sex, and 1st/2nd Eye. Numbers in parentheses are mediational effects of each coping scale.

The direct effect of Neuroticism on coping satisfaction was reduced from $\beta_{pre-coping} = -.28^{**}$ to a marginally significant $\beta_{post-coping} = -.18^{\dagger}$ after coping was controlled. The largest share of the joint indirect effect was carried by Focus on Positive coping (.06 units) that had a positive effect on coping satisfaction. Active Coping remained significantly negatively related with coping satisfaction, while Evasive Coping no longer explained a significant part of the outcome variance.

5.5.16. Testing Coping as a Moderator between Personality and Coping Satisfaction

Besides testing the mediator hypothesis directly, it was again necessary to examine a possible moderating function of coping when it comes to the association between

Neuroticism and coping satisfaction. Once again, centered first-order and interaction terms were introduced to the last two blocks of hierarchical regression analyses. In a first step, age, sex and previous cataract operation were controlled for. Coping first-order terms and interactions with neuroticism were like before, tested individually. None of the entered interaction terms proved significant, predicting satisfaction with coping efforts prior to surgery, so that a moderating role of coping was ruled out.

5.6. Testing the Mediator Hypothesis with Long-Term Measures

As an attempt to further the understanding about the contradictory results by McCrae and Costa (1986) and Bolger (1990), the "coping as a personality process" hypothesis was tested again, employing longer-term measures, i.e., measures that were not directly associated with the hospital situation and surgery. Those included the one-time assessment of personality traits Neuroticism, Extraversion, and Openness to Experience on the side of the independent variables, accounts of dispositional coping assessed six weeks after the operation as proposed mediators, as well as depressive symptoms and general life satisfaction, also measured six weeks post, as outcome variables.

As before, the general procedure was as follows: First, bivariate associations between independent variables (N, E, and O) and outcome measures were examined. Following this, hierarchical regression analyses were computed. In a first step, control variables were entered. Control variables for the more distal outcomes included age, sex, multimorbidity, and change in visual acuity, the latter two being related to both depressive symptoms and general life satisfaction. In a second step, personality variables were entered. Analyses were repeated entering Neuroticism and Extraversion as abbreviated versions net of affectivity components (Neuroticism/S, Extraversion/S). Although there was a high intercorrelation between the respective outcome measures ($r = -.46, p < .001$), the approximately 21% of overlapping variance were tolerated, and respective outcomes were examined separately, since the share of unique variance was still great.

Next, basically the same procedures were employed, testing coping responses as predictors of the outcome. Following this, associations between higher-order personality traits and dispositional coping were tested, again by predicting one of the four coping

styles by means of hierarchical regression analyses. Here, the first block entered included control variables outlined above, as well as the remaining three coping styles. The second block then included higher-order personality traits. The final model comprised control variables, second, those personality traits which predicted both coping and outcome variables, and third, all coping styles. Again, because of the intercorrelations of the coping scales, all four were entered into all models at once to tell apart unique from common contributions to the explanation of outcome variance.

5.6.1. Personality Predicts Depression and Life Satisfaction

Bivariate associations showed a strong relatedness of Neuroticism with depressive symptoms (Table 29). In accordance with a number of findings (e.g., Vollrath, 2001), emotionally labile persons tended to report higher depressive symptoms. Extraverts, on the other hand, reported less depressive symptoms, although the correlation was only moderate in size. In terms of life satisfaction upon admission to the hospital (t1), no significant bivariate associations with personality traits were found. At t4, however, associations in hypothesized directions were observed. Emotionally labile cataract patients were less satisfied with their lives when compared to their counterparts, whereas extraverts scored higher on life satisfaction than introverts.

Table 29
Pearson Correlations of Depressive Symptoms and Life Satisfaction with NEO-Personality Traits

| | Depressive Symptoms | Life Satisfaction t1 | Life Satisfaction t4 |
|------------------------|---------------------|----------------------|----------------------|
| Neuroticism | .54*** | -.12 | -.22* |
| Extraversion | -.29** | .07 | .30** |
| Openness to Experience | -.02 | -.02 | -.11 |
| Neuroticism/S | .51*** | -.10 | -.12 |
| Extraversion/S | -.15 | -.07 | .21* |

Note. 110 >= N >= 94. Neuroticism/S = net of negative affectivity items; Extraversion/S = net of positive affectivity items. † $p < .10$, * $p < .05$, ** $p < .01$, *** $p < .001$.

Openness to Experience was not related to any of the longer-term measures of well-being. Looking at the abbreviated, net of affectivity versions of Neuroticism/S and

Extraversion/S, associations with indicators of well-being weakened in some cases considerably, which could be expected, since both depressive symptoms and life satisfaction should to some degree include the dispositional aspects of emotional well-being. Net of affectivity components, Neuroticism/S was no longer significantly related with life satisfaction, and Extraversion/S did not correlate significantly with depressive symptoms.

As explained above, to account for rival predictors of both outcomes, hierarchical regression analyses were computed next. Results indicated that, after controlling for rival predictors, such as multimorbidity, change in visual acuity in the eye operated on, as well as age, sex, Neuroticism still explained significant amounts of variance in depressive symptoms (see Table 30). The same was true when the abbreviated version of Neuroticism was tested (Appendix D, Table D10). When entered together with Neuroticism, Extraversion did not contribute to the explanation of outcome variance in depressive symptoms any longer (see Table 31).

Table 30
Results of Hierarchical Regression Analyses Predicting Depressive Symptoms and Life Satisfaction

| Outcome | β (last step) | R ² | ΔR^2 |
|---|---------------------|------------------|--------------|
| Depressive symptoms | | | |
| Rival Predictors | | .34*** | |
| Neuroticism | .40*** | .50 | .16*** |
| Extraversion added | -.10 | | |
| Life Satisfaction t4 | | | |
| Rival Predictors | | .08 [†] | |
| Neuroticism | -.10 | .14 | .06* |
| Extraversion added | .23* | | |
| Change in Life Satisfaction t1 to t4 | | | |
| Rival Predictors (t1 added) | | .18** | |
| Neuroticism | -.06 | .24 | .07* |
| Extraversion added | .25* | | |

Note. n = 94. a: Age, sex, change in visual acuity, multimorbidity. b: Age, sex, change in visual acuity, multimorbidity. [†] $p < .10$, * $p < .05$, ** $p < .01$, *** $p < .001$.

Regarding life satisfaction at t4 and change from t1 to t4, only Extraversion was still related when rival predictors were accounted for (see Table 30). When the net of

affectivity version Extraversion/S was entered, prediction of life satisfaction at t4 was no longer significant, but the change prediction remained stable (Appendix D, Table, D10). Life satisfaction at t1 and a number of control variables being equal, extraverts reported more life satisfaction at six weeks post-surgery than did introverts.

5.6.2. Dispositional Coping Predicts Depressive Symptoms and Life Satisfaction

The next set of analyses dealt with associations of outcome variables depressive symptoms and life satisfaction with dispositional coping styles. Initially, zero-order correlations suggested significant positive relationships between depressive symptoms and Active Coping/D as well as Evasive Coping/D, pointing to higher scores of depressive symptoms in persons using these coping styles intensely (see Table 31). A mirrored picture was found for life satisfaction both at t1 and t4. Here, more Active Coping/D and more Evasive Coping/D were associated with less life satisfaction. Upon admission to the hospital, more life satisfaction was also associated with less dispositional Support Seeking/D.

Table 31
Pearson Correlations of Depressive Symptoms and Life Satisfaction with Dispositional Coping

| | Depressive Symptoms | Life Satisfaction t1 | Life Satisfaction t4 |
|---------------------|---------------------|----------------------|----------------------|
| Focus on Positive/D | -.14 | .09 | .13 |
| Support Seeking/D | .14 | -.22* | -.09 |
| Active Coping/D | .22* | -.37** | -.25* |
| Evasive Coping/D | .22* | -.32** | -.18 [†] |

Note. n = 94. Coping/D = Dispositional Coping. [†] $p < .10$, * $p < .05$, ** $p < .01$, *** $p < .001$.

Using hierarchical regression next, the first block once again included age, sex, multimorbidity, and change in visual acuity (when life satisfaction served as a dependent variable, pre-surgical visual acuity in the eye operated on was controlled for instead). All dispositional coping styles were entered in a second block. Table 32 gives an overview of the results. When depressive symptoms served as a dependent variable, dispositional Focus on Positive/D and Evasive Coping/D shared significant amounts of outcome variance. While more Evasive Coping/D was associated with more depressive symptoms, the opposite was true for Focus on Positive/D coping.

Regarding life satisfaction upon admission to the hospital (t1), dispositional Evasive Coping/D remained the only significant negative predictor. While variance common to all dispositional coping scales predicted a fairly large part of the outcome variance, Evasive Coping/D added the biggest unique part to the prediction (roughly 4%).

Table 32
Regression Analyses: Dispositional Coping Predicting Depressive Symptoms and Life Satisfaction

| Outcome | β (last step) | R ² | ΔR^2 |
|---|---------------------|------------------|--------------|
| Depressive symptoms | | | |
| Rival Predictors | - | .34*** | |
| Focus on Positive/D | -.20* | .45 | .11** |
| Support Seeking/D | -.12 | | |
| Active Coping/D | .15 | | |
| Evasive Coping/D | .24* | | |
| added | | | |
| Life Satisfaction t1 | | | |
| Rival Predictors | - | .11* | |
| Focus on Positive/D | .16 | .26 | .15** |
| Support Seeking/D | -.03 | | |
| Active Coping/D | -.19 | | |
| Evasive Coping/D | -.25* | | |
| added | | | |
| Life Satisfaction t4 | | | |
| Rival Predictors | - | .08 [†] | |
| Focus on Positive/D | .18 [†] | .19 | .11* |
| Support Seeking/D | .11 | | |
| Active Coping/D | -.27 [†] | | |
| Evasive Coping/D | -.14 | | |
| added | | | |
| Change in Life Satisfaction t1 to t4 | | | |
| Rival Predictors (t1 added) | - | .18** | |
| Focus on Positive/D | .14 | .24 | .06 |
| Support Seeking/D | .13 | | |
| Active Coping/D | -.23 [†] | | |
| Evasive Coping/D | -.08 | | |
| added | | | |

Note. n = 94. Coping/D = Dispositional coping. a: Age, sex, change in visual acuity, multimorbidity. b: Age, sex, change in visual acuity, multimorbidity. [†]p < .10, * p < .05, ** p < .01, *** p < .001.

Six weeks post-surgery as well as regarding change in life-satisfaction from t1 to t4, dispositional Active Coping/D contributed the greatest share of unique variance to the

prediction. Rival factors being equal, more dispositional Active Coping/D was associated with less life-satisfaction six weeks after the operation.

5.6.3. Personality Predicts Dispositional Coping?

Before directly testing mediation, associations between independent variables and proposed mediators had to be examined. Zero-order correlations are depicted in Table 33. Compared to situation-specific coping results (Section 5.5.7.), many of the same bivariate relationships arose. As with situation-specific coping, Support Seeking/D and Evasive Coping/D were positively associated with Neuroticism, suggesting more dispositional use of these strategies in emotionally labile respondents. Moreover, Openness to Experience was once again positively related with Active Coping/D. Extraversion, however, was not associated with dispositional Focus on Positive/D coping.

Table 33
Pearson Correlations between NEO-Personality Traits and Coping/D

| Coping/D | Neuroticism | Extraversion | Openness |
|---------------------|-------------|--------------|----------|
| Focus on Positive/D | .09 | .09 | .10 |
| Active Coping/D | .13 | -.05 | .24* |
| Support Seeking/D | .25* | .01 | .04 |
| Evasive Coping/D | .35** | .01 | -.09 |

Note. n = 94. Coping/D = Dispositional coping. † $p < .10$, * $p < .05$, ** $p < .01$, *** $p < .001$.

As part of the path-analysis procedure and to capture unique relations of higher-order personality traits with dispositional coping styles, while controlling for factors related to the outcome of the model, each subsequent hierarchical regression analysis contained two blocks. As with situation-specific coping, dispositional coping style A was predicted by introducing styles B, C, and D, followed by the above-established covariates to the first step of the equation. The second step then contained one of the personality variables, Neuroticism, Extraversion, or Openness to Experience. As usual, analyses were repeated, entering the net of affectivity versions Neuroticism/S and Extraversion/S.

As can be seen in Table 34, apart from two exceptions, regression analyses revealed similar findings as correlations did before. Everything else being equal, Neuroticism still predicted outcome variance of dispositional Evasive Coping/D, and Openness to Experience was again related to dispositional Active Coping/D. Moreover, Openness emerged as a predictor of Evasive Coping/D when Active Coping/D was controlled for, indicating the same suppressor effect that had been found with respect to the situation-specific coping version of this association (see Section 5.5.7.). Open individuals reported using less Evasive Coping/D than their counterparts.

Table 34
Results of Hierarchical Regression Analyses Predicting Dispositional Coping

| Coping/D | Focus on Positive/D | | Active Coping/D | | Seeking Support/D | | Evasive Coping/D | |
|------------------|---------------------|--------------|-----------------|--------------|-------------------|--------------|------------------|--------------|
| | β | ΔR^2 | β | ΔR^2 | β | ΔR^2 | β | ΔR^2 |
| Rival Predictors | | .06 | | .38*** | | .35*** | | .31*** |
| Neuroticism | -.02 | .00 | -.02 | .00 | .05 | .00 | .29** | .07** |
| Rival Predictors | | .06 | | .38*** | | .35*** | | .31*** |
| Extraversion | .11 | .01 | -.07 | .00 | .03 | .00 | .03 | .00 |
| Rival Predictors | | .06 | | .38*** | | .35*** | | .31*** |
| Openness | .16 | .02 | .27** | .07** | -.09 | .01 | -.19* | .03* |

Note. n = 94. Rival predictors: Age, sex, change in visual acuity, multimorbidity, and all coping scales but the one serving as outcome. Coping/D = Dispositional coping. [†] $p < .10$, * $p < .05$, ** $p < .01$, *** $p < .001$. Betas are last step.

The second exception pertained to the Neuroticism - Seeking Support/D relationship, which was no longer significant when the other variables were controlled for. Coefficients remained stable when abbreviated versions of Neuroticism/S and Extraversion/S were entered as predictors (Appendix D, Table D13).

5.6.4. Evidence for Mediation between Neuroticism and Depressive Symptoms?

Since there was only one set of predictors which fulfilled requirements for possible mediation, only one model was tested. Again using hierarchical regression, depressive symptoms were predicted by a set of rival predictors, including age, sex, multimorbidity, and change in visual acuity. Neuroticism was entered to the second block, and dispositional coping styles to the third. Analyses from Section 5.6.3. present

in detail the procedures used to determine Neuroticism-coping relationships. Results are summed in Figure 26.

There was no indication for dispositional coping styles taking on a mediator status between Neuroticism and depressive symptoms as one of the longer-term measures of well-being. Moreover, Evasive Coping/D, accounted for outcome variance before Neuroticism was added to the equation, but not afterwards. Only dispositional Focus on Positive/D coping predicted a significant but small part of depressive symptoms six weeks post-surgery. The results remained virtually unchanged when the net of affectivity version, Neuroticism/S, was entered as the independent variable (Appendix D, Table D20).

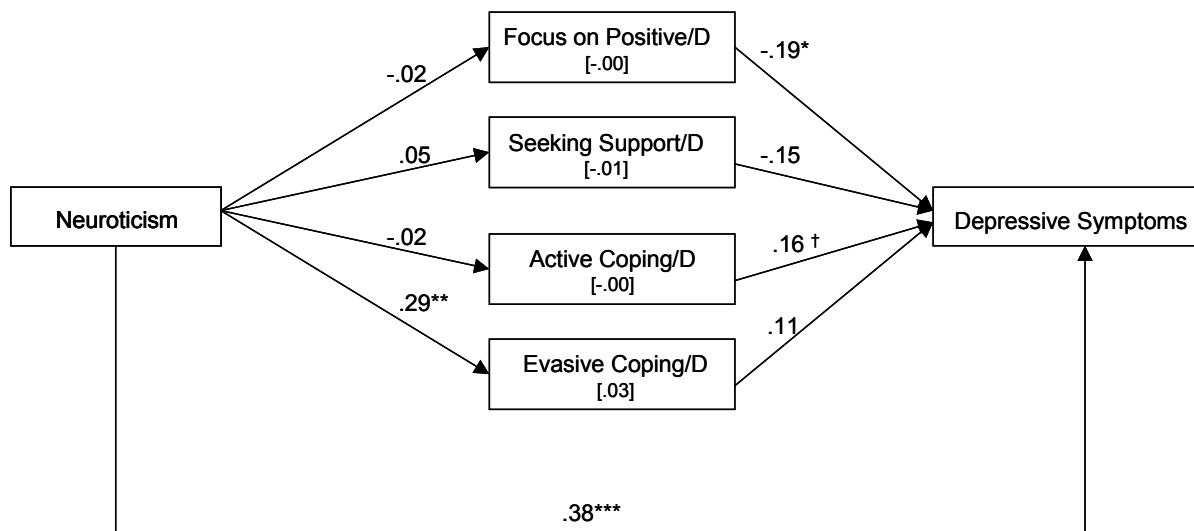

Figure 26 Relationship among Neuroticism, dispositional coping, and depressive symptoms six weeks post-surgery: Standardized regression coefficients ($n = 94$). Arrows from Neuroticism to each coping scale indicate standardized partial regression coefficients, net of age, sex, multimorbidity, and change in visual acuity. Numbers in parentheses are mediational effects of each coping scale.

5.6.5. Differential Effectiveness: Testing Possible Moderation

As with situation-specific coping, interactions between Neuroticism and dispositional coping responses were tested next in order to examine possible interaction effects that might suggest differential effectiveness of coping strategies as a function of different levels of Neuroticism. The analytical procedure used resembles the one already described in Section 5.5.12. Hierarchical regression analyses were computed with

depressive symptoms as an outcome variable, already established control variables (see section above) entered in a first block, centered Neuroticism and coping scales in a second block, and the respective interaction term entered last.

None of the tested Neuroticism by coping interactions predicted any significant amount of outcome variance. There was no indication of differential effectiveness of dispositional coping strategies for persons of different levels of Neuroticism when it comes to depressive symptoms six weeks post-surgery.

In summary, predicting longer-term indicators of well-being, dispositional coping failed to mediate (or moderate) the relationship between Neuroticism and depressive symptoms six weeks post-surgery. In fact, aside from Focus on Positive/D coping, none of the other (dispositional) coping – outcome relationships withstood the control of Neuroticism, a finding that closely resembles results reported by McCrae and Costa (1986).

Partly in order to validate above-reported results and to find out more about possible confounding interactions between major predictors and indicators of visual acuity, the next section takes a more detailed look at the prediction of different outcomes taking into consideration the amount of change in visual acuity in the eye operated on.

5.6.6. Visual Acuity Post-Surgery and Long-Term Well-Being: Personality and Coping as Moderators?

Despite the fact that most operations went well and positive changes in visual acuity could be reported for over 99% of patients, there was a wide range in the quantity of change as well as plain surgical outcome of best corrected distance visual acuity measured in Snellen decimals. As reported earlier, post-surgical visual outcome criteria bore bivariate relations to indicators of long-term well-being (i.e., depressive symptoms and life satisfaction). To reiterate, mostly change in visual acuity from pre- to post-surgery was significantly associated with both depressive symptoms ($r = -.31^{**}$)¹⁷, and marginally so with life satisfaction ($r = .19^{\dagger}$)¹⁰ six weeks after the operation. The

¹⁷ Both associations nearly disappeared, however, once multimorbidity was partialled (depressive symptoms with change in visual acuity: $r_{\text{multimorbidity}}=.12$, $p=.25$; life satisfaction with change in visual acuity: $r_{\text{multimorbidity}}=.09$, $p=.39$).

question examined in this section exploratively considered possible moderating effects of vision status concerning the "personality/dispositional coping-with-distal well-being-relation". Hence, interaction terms were built with centered major predictors multiplied by both state and change in visual acuity six weeks post-surgery (also centered around their means). Interaction terms were again entered into the equation following established rival predictors, age, sex, and multimorbidity, and centered first-order terms.

Table 35

Results of Hierarchical Regression Analyses Predicting Depressive Symptoms (t4) by Introducing Two-Way Interaction Terms.

| Depressive Symptoms (n = 94) | B (last step) | R | ΔR^2 |
|---|---------------|-----|--------------|
| 1. Step: Control Variables ^a | - | .59 | .34*** |
| 2. Step: C ^b -Post Visual Acuity S (A) | .02 | | |
| C-Neuroticism (B) | 6.12*** | .70 | .15*** |
| 3. Step: (A) x (B) | -.14* | .72 | .03* |
| 2. Step: C-Post Visual Acuity S (A) | .01 | | |
| C-Neuroticism/S (B) | 3.93*** | .68 | .12*** |
| 3. Step: (A) x (B) | -.09* | .70 | .03* |
| 2. Step: C-Post Visual Acuity S (A) | .01 | | |
| C-Support Seeking/D (B) | -.28 | .59 | .00 |
| 3. Step: (A) x (B) | .11* | .61 | .03* |

Note. [†] $p < .10$, * $p < .05$, ** $p < .01$, *** $p < .001$. a: Age, sex, multimorbidity, change in visual acuity in the eye operated on. b: C- Variables are centered around their means.

Only two significant interaction terms emerged, both involving post-surgical best corrected visual acuity in the eye operated on (not change) as one factor of the term.

The first model included Neuroticism by visual acuity (t4) predicting depressive symptoms (t4). The interaction was followed up by dividing the continuous visual acuity component into two groups using a median split procedure. The high post-surgical visual acuity group had a mean of $M = .89$ (Snellen decimals; $SD = .09$, $min = .80$, $max = 1.00$, $n_{tl} = 62$), the low visual acuity group averaged $M = .57$ (Snellen Decimals, $SD = .17$, $min = .03$, $max = .75$, $n_{tl} = 47$). Follow-up regression analyses in both groups revealed considerable positive associations between Neuroticism and depressive symptoms (already net of established controls; see Table 36), varying only in size.

Table 36
Results of Follow-Up Analyses Predicting Depressive Symptoms in Lower and Higher Visual Acuity Groups

| Lower Post Visual Acuity S ^a (n = 36): | β (last step) | R | ΔR^2 |
|--|---------------------|-----|--------------|
| Outcome: Depressive Symptoms | | | |
| 1. Step: Control Variables ^b | - | .54 | .29* |
| 2. Step: Neuroticism | .54*** | .73 | .24*** |
| 2. Step: Neuroticism/S | .48** | .69 | .18** |
| Higher Post Visual Acuity S ^a (n = 57): | | | |
| Outcome: Depressive Symptoms | | | |
| 1. Step: Control Variables ^b | - | .64 | .41*** |
| 2. Step: Neuroticism | .38*** | .72 | .12*** |
| 2. Step: Neuroticism/S | .34** | .70 | .09** |

Note. [†] $p < .10$, * $p < .05$, ** $p < .01$, *** $p < .001$. a: Post-surgical best corrected distance visual acuity in the eye operated on. b: Age, sex, multimorbidity, change in visual acuity in the eye operated on.

Figure 27 shows simple means for illustration. In the low visual acuity group, Neuroticism, above and beyond multimorbidity, explained another 22.4% ($p < .001$) of the variance in depressive symptoms. In the high visual acuity group, also controlling for multimorbidity, Neuroticism explained still 12% ($p < .001$) of outcome variance.

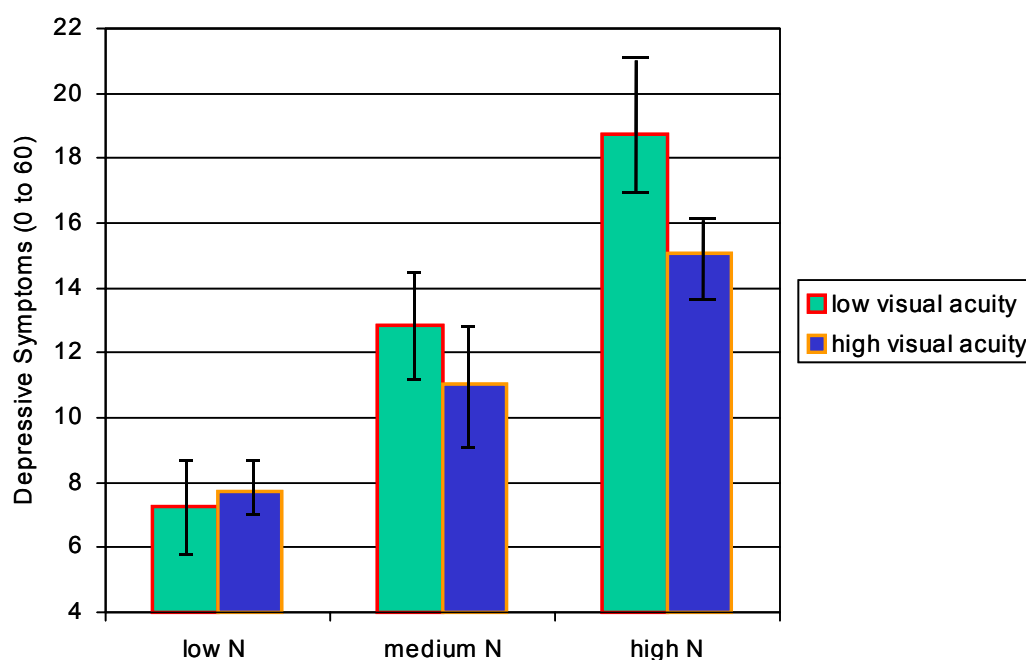

Figure 27 Mean sumscores of depressive symptoms six weeks post-surgery by levels of Neuroticism and post-surgery visual acuity in the eye operated on. (N = Neuroticism).

Essentially, emotionally labile respondents generally reported more depressed mood six weeks post-surgery. However, in the worse visual acuity outcome group the association between Neuroticism and depressive symptoms was even higher.¹⁸ The same was true when the net of negative affectivity version of Neuroticism (Neuroticism/S) was tested (see Table 36).

A second moderating effect involved different levels of Support Seeking/D as a habitual coping style. Again predicting depressive symptoms 6 weeks post-surgery, a significant interaction of post-surgery visual acuity and Support Seeking/D occurred (Table 35). Follow-up analyses, once again testing associations between Support Seeking/D and depressive symptoms in both high and low groups of visual acuity (t4) while controlling for multimorbidity among others, revealed a fair positive association only among participants with *high* visual acuity (Table 37). Among patients with lower visual acuity, no significant association was found (Table 37). However, while the association in the high visual acuity group was positive, the one in the low vision group was negative (but not approaching significance). Hence, while visually less privileged participants (post-surgery) with higher levels of Support Seeking/D did not exhibit more depressive symptoms, persons with post-surgery high visual acuity did.¹⁸

Table 37
Results of Follow-Up Analyses Predicting Depressive Symptoms in Lower and Higher Visual Acuity Groups

| Lower Post Visual Acuity S ^a (n = 36): | β (last step) | R | ΔR^2 |
|--|---------------------|-----|--------------|
| Depressive Symptoms | | | |
| 1. Step: Control Variables ^b | - | .54 | .29*** |
| 2. Step: Support Seeking/D | -.14 | .56 | .02 |
| Higher Post Visual Acuity S ^a (n = 57): | | | |
| Depressive Symptoms | | | |
| 1. Step: Control Variables ^b | - | .64 | .41*** |
| 2. Step: Support Seeking/D | .25* | .68 | .06* |

Note. [†] $p < .10$, * $p < .05$, ** $p < .01$, *** $p < .001$. a: Post-surgery best corrected distance visual acuity in the eye operated on. b: Age, sex, multimorbidity, change in visual acuity in the eye operated on.

¹⁸ As before, follow-up analyses to both interaction terms using "simple slope analyses" (Aiken & West, 1991) yielded highly comparable results.

As an aside, within the better-vision group, both Neuroticism and Support Seeking/D predicted depressive symptoms. Also, within this subsample, Neuroticism and Support Seeking/D were highly interrelated ($r = .33, p = .01$), even when multimorbidity was partialled ($r_{\text{multimorbidity}} = .34, p = .01$). Therefore, within the better-vision group, analyses were repeated, this time entering both Neuroticism and Support Seeking/D. While net of age, sex, multimorbidity, and change in visual acuity, Neuroticism remained a significant predictor ($\beta = .33^{**}, \Delta R^2 = .12^{**}$), Support Seeking did not ($\beta = .15, \Delta R^2 = .02$). As before, habitual coping did not mediate between Neuroticism and depressive symptoms as a longer-term indicator of well-being. Although moderation was tested alternatively the interaction term between Neuroticism and Support Seeking/D did not contribute to the prediction of depressive symptoms 6 weeks post-surgery.

5.7. Better Vision - More Action for Some?

After looking at some more distal well-being outcomes of cataract surgery, it was of interest to see whether higher-order personality traits and coping would exhibit associations with indicators of vision-related functional status six weeks post-surgery, or might even predict some of the adjustment (change) variance pre- to post-surgery. As described earlier, two aspects of functional status were examined: total number of activities pursued and intensity of limitations experienced.

5.7.1. Neuroticism and Openness Predict Aspects of Functional Status Six Weeks Post-Surgery

A first look at zero-order correlations of indicators of functional status with Neuroticism, Extraversion, and Openness revealed only two significant associations.

As predicted, emotionally labile persons complained of higher vision-related *intensity of limitation* prior to surgery when compared to emotionally stable persons. This association was considerably reduced and no longer significant six weeks after the operation. Extraversion, on the other hand, was negatively correlated with perceived limitations at t4. However, controlling for rival predictors (i.e., multimorbidity, visual acuity, and acquisition of new prescription glasses), this association was no longer even

marginally significant. On a bivariate level and contrary to expectations, Openness did not exhibit positive associations with number of activities pursued neither pre- nor post-surgery (see Table 38).

Table 38
Correlations Between Higher-Order Personality Traits and Vision-Dependent Functional Status

| | Neuroticism | Extraversion | Openness |
|---|-------------|-------------------|----------|
| Number of Activities t1 (n = 109) | -.05 | .01 | .00 |
| Number of Activities t4 (n = 93) | -.14 | .08 | .13 |
| Intensity of Limitation t1 (n = 109) | .26** | -.13 | .01 |
| Intensity of Limitation t4 (n = 93) | .16 | -.18 [†] | -.05 |

Note. [†] $p < .10$, * $p < .05$, ** $p < .01$, *** $p < .001$.

A follow-up of bivariate associations with hierarchical regression procedures while controlling for rival predictors (see Table 39) as well as considering change in functional status as an outcome, produced a similar picture.

Table 39
Summary of Hierarchical Regression Analyses Predicting Number of Vision-Dependent Activities and Intensity of Limitation

| Outcome | β (last step) | R | ΔR^2 |
|---|---------------------|-----|--------------|
| Change in Number of Activities t1 to t4 | | | |
| Rival Predictors ^a (t1 Number of Activities added) | - | .77 | .59*** |
| Neuroticism | .03 | .79 | .03 |
| Extraversion | .03 | | |
| Openness | .16* | | |
| added | | | |
| Intensity of Limitation t1 | | | |
| Rival Predictors ^b | - | .29 | .08* |
| Neuroticism | .26* | .39 | .07* |
| Extraversion | -.06 | | |
| Openness | .04 | | |
| added | | | |

Note. [†] $p < .10$, * $p < .05$, ** $p < .01$, *** $p < .001$. a: Age, sex, multimorbidity, new glasses, change in visual acuity. b: Age, sex, multimorbidity.

The positive association between Neuroticism and *intensity of limitation* before the operation remained stable even after accounting for age, sex, and multimorbidity. In other words, factors also associated with intensity of limitation experienced being equal, Neuroticism was still connected with more complaints pre-surgery. Post-surgery, however, the predictive value of Neuroticism was no longer significantly different from zero. In accordance with expectations, the personality trait Openness to Experience turned out to be a significant predictor of change in *number of activities* from pre- to post-surgery, even while rival predictors were controlled (see Table 39). Status at t1, change in visual acuity, acquisition of new glasses, and number of chronic illnesses, among other factors controlled, open persons reported more activities at six weeks post-surgery than their counterparts.

5.7.2. Openness: See Better, Complain Less?

Additionally, while predicting aspects of vision-related functional status six weeks post operation, possible interactions with both *t4 state* and *change in visual acuity* (from pre- to post-surgery) and personality traits were explored. Would there be interindividual differences in terms of how participants adjusted their functional status depending on how much better they could see following the operation? Predicting change in vision-related limitations, one interaction term involving Openness to Experience and change in visual acuity emerged (Table 40).

Table 40
Results of Hierarchical Regression Analysis Predicting Change in Vision-Related Intensity of Limitation

| Limitation t4 (n = 93) | B (last step) | R | ΔR^2 |
|---|---------------|-----|--------------|
| 1. Step: Control Variables ^a (t1 Limitation added) | - | .55 | .30*** |
| 2. Step: C ^b -Change Visual Acuity S (A) C-Openness (B) | | .55 | .01 |
| 3. Step: (A) x (B) | -.02* | .59 | .05* |

Note. a: Age, sex, best corrected distance visual acuity eye operated on (t4), best corrected distance visual acuity other eye, multimorbidity, acquisition of new glasses. b: C- Variables are centered around their means. † $p < .10$, * $p < .05$, ** $p < .01$, *** $p < .001$.

Following this, analyses were performed, separately testing high and low groups of change in visual acuity. A median-split procedure was employed to dichotomize change in visual acuity into high ($M_{change} = .56, SD = .16, min = .35, max = .90, n_{t4} = 39$) and low ($M_{change} = .16, SD = .12, min = -.05, max = .30, n_{t4} = 55$) groups.

Follow-up analyses indicated that, in addition to pursuing more activities at t4 (when number of activities at t1 was held constant), more open individuals also exhibited a considerably steeper drop in complaints about limitations following surgery ($\Delta R^2 = .08^\dagger, \beta = -.32^\dagger, n = 39$), but only if they belonged to the group with most change in visual acuity pre-to post-surgery.¹⁹ Figure 28 provides simple means for participants high in change in visual acuity, comparing open individuals and their counterparts.

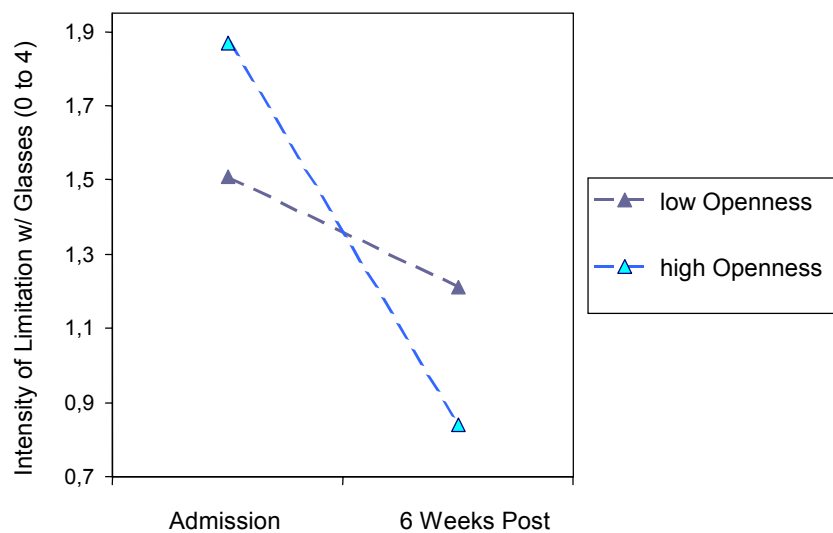

Figure 28 Simple means for participants high in change in visual acuity, comparing open individuals and their counterparts.

5.7.3. Habitual Coping Predicts Vision-Related Functional Status Post-Surgery

The way people handle stressful situations is known to be related to a number of adaptational criteria. So far, coping and its effects were primarily examined in connection with a host of short- and long-term emotional outcomes. The following section will investigate more thoroughly proposed interrelations between habitual coping styles and indicators of functional status before and after the operation.

Looking at bivariate associations first, two sets of habitual coping strategies, i.e., Support Seeking/D and Active Coping/D, were correlated with both number of activities pursued and intensity of limitation experienced at different points in time. A habitual tendency to Seek Support when stressed was marginally connected to pursuing fewer activities six weeks after implantation of the new lens (see Table 41). The tendency to cope actively, on the other hand, was connected with pursuing more activities after the operation, but not before. Also, Active Coping/D was positively correlated with intensity of limitations experienced prior to surgery, and marginally so 6 weeks after surgery. Dispositionally focusing on positive aspects of difficult situations showed a marginally negative association with number of activities before the operation on a bivariate level. However, this association did not withstand the control of rival predictors in hierarchical regression analyses that were performed next.

Table 41
Pearson Correlations between Dispositional Coping and Outcome Variables Number of Activities and Intensity of Limitation at Different Points in Time

| | Focus on Positive/D | Support Seeking/D | Active Coping/D | Evasive Coping/D |
|----------------------------|---------------------|-------------------|------------------|------------------|
| Number of Activities t1 | -.18 [†] | -.14 | .09 | -.07 |
| Number of Activities t4 | -.13 | -.19 [†] | .20 [†] | -.03 |
| Intensity of Limitation t1 | -.05 | .22* | .25* | .12 |
| Intensity of Limitation t4 | -.06 | .24* | .18 [†] | .11 |

Note. n = 93. [†] $p < .10$, * $p < .05$, ** $p < .01$, *** $p < .001$.

As for multiple prediction of *number of activities pursued*, associations remained basically unchanged, even after controlling for numerous factors, such as age, sex, multimorbidity, change in visual acuity, and acquisition of new prescription glasses (see Table 42). At six weeks after the operation, and while entering all dispositional coping styles at once, more Support Seeking/D went along with less activities pursued, while Active Coping/D was related to the pursuit of more activities. In addition, a marginally

¹⁹ The same picture emerged using "simple slope analysis," as recommended by Aiken and West (1991).

significant effect of Active Coping/D on change in pursuit of activities emerged: Controlling for number of activities at t1 Active Coping/D still predicted pursuit of more activities at t4.

Concerning *vision-related limitations* experienced, most of the reported bivariate associations were explained by the number of chronic illnesses patients reported. That is, after controlling for this factor (among others), most of the relationships between dispositional coping styles (e.g., Seeking Support/D) and intensity of limitations were no longer significant. Only before the operation (t1) was Active Coping/D still positively related with complaints about limitations.

Table 42
Results of Hierarchical Regression Analyses Predicting Number of Vision-Dependent Activities Pursued at Different Points in Time and Vision-Related Intensity of Limitations Experienced

| Outcome | β (last step) | R | ΔR^2 |
|--|---------------------|-----|------------------|
| <hr/> | | | |
| Number of Activities t4 | | | |
| Rival Predictors ^a | - | .62 | .38*** |
| Focus on Positive/D | -.07 | .66 | .05 |
| Support Seeking/D | -.18 [†] | | |
| Active Coping/D | .24* | | |
| Evasive Coping/D | -.05 | | |
| added | | | |
| <hr/> | | | |
| Change in Number of Activities t1 to t4 | | | |
| Rival Predictors (t1 Number of Activities added) ^a | | .77 | .59*** |
| Focus on Positive/D | .01 | .78 | .02 |
| Support Seeking/D | -.13 | | |
| Active Coping/D | .16 [†] | | |
| Evasive Coping/D | -.01 | | |
| added | | | |
| <hr/> | | | |
| Intensity of Limitation t1 | | | |
| Rival Predictors ^b | - | .28 | .08 [†] |
| Focus on Positive/D | -.10 | .40 | .08 |
| Support Seeking/D | .08 | | |
| Active Coping/D | .21 [†] | | |
| Evasive Coping/D | .06 | | |
| added | | | |

Note. Coping/D: Dispositional coping styles. a: (Aside from Number of Activities Pursued at t1) Age, sex, multimorbidity, change in visual acuity, acquisition of new prescription glasses. b: Age, sex, best corrected distance visual acuity in the eye operated on (t1). [†] $p < .10$, * $p < .05$, ** $p < .01$, *** $p < .001$.

As presented in the sections above, both Openness to Experience and Active Coping/D predicted parts of the variance surrounding change in number of activities pursued from before until after the operation, i.e., part of the functional adaptation to the new situation with a newly implanted clear lens and improved vision. Moreover, Openness predicted Active Coping/D (see Section 5.6.3.), thus fulfilling the set of demands necessary to test possible mediation, which is presented in the following section.

5.7.4. Adjusting to Better Vision on a Functional Level: Partly a Matter of Openness, Dispositional Coping, or Both?

Would dispositional Active Coping/D still predict independently change in number of heavily vision-dependent activities some time after the operation when Openness was a rival predictor? Or would all of the predictive dispositional coping variance be taken up by the antecedent higher-order personality trait as was the case with Neuroticism and Evasive Coping/D while distal well-being was predicted, and as Bolger (1990) suggested?

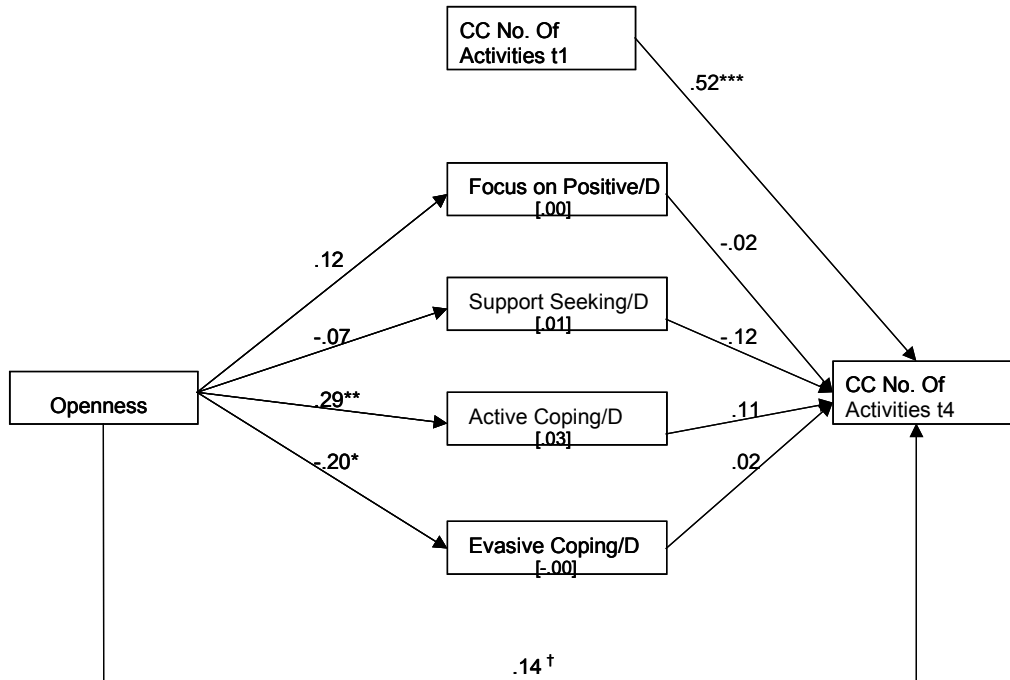

Figure 29 Relationship among Openness, dispositional coping, and change in number of activities from t1 to t4: Standardized regression coefficients ($n = 93$). Arrows from Openness to each coping scale indicate standardized partial regression coefficients, net of number of activities at t1, age, sex, multimorbidity, change in visual acuity, and new glasses. Numbers in parentheses are mediational effects of each coping scale. C.C. = with best correction, i.e., wearing glasses.

Mediation was tested by conducting another series of regression analyses, as described in both the Method and Results chapters. Figure 29 presents the model. Once again, coefficients are betas already net of rival predictors age, sex, multimorbidity, change in visual acuity, and acquisition of new prescription glasses.

There was no evidence of mediation. The once marginally significant prediction of change variance in number of activities from pre- to post-surgery by dispositional Active Coping/D was instead somewhat reduced when Openness was added to the final regression model. Openness, on the other hand, remained a marginally significant predictor of increase in pursued activities.

Testing an alternative moderation model predicting change in number of activities from before until after the operation came up with a significant interaction term between Openness to Experience and habitual Active Coping/D (see Table 43).

Table 43

Testing Moderation: Results of Hierarchical Regression Analysis Predicting Change in Number of Activities from t1 to t4

| Outcome | B (last step) | R | ΔR^2 |
|---|---------------|-----|------------------|
| Change in Number of Activities t1 to t4 (n = 93) | | | |
| Rival Predictors ^a (t1 added) | - | .77 | .59*** |
| C ^b -Openness (A) | .59* | | |
| C-Active Coping/D (B) | .16 | .79 | .03 [†] |
| A x B | -.66* | .80 | .02* |

Note. a: Age, sex, multimorbidity, change in visual acuity, acquisition of new prescription glasses. b: Factors of the interaction term as well as first-order terms are centered around their means. [†] $p < .10$, * $p < .05$, ** $p < .01$, *** $p < .001$.

Follow-up regression analyses were conducted with high and low groups of dispositional active copers. Groups were determined by employing a median-split procedure. For the low active group ($n = 49$), a marginally significant positive main effect of Openness on change of number of activities from t1 to t4 emerged (β (last step) = .20[†], $\Delta R^2 = .04$ [†]). To avoid too many predictors with the now drastically reduced group sizes, only age, sex, and change in visual acuity were controlled for in the follow-up analyses. Multimorbidity and acquisition of new prescription glasses were dropped

as rival predictors in this instance since they did not contribute to the explanation of outcome variance.²⁰

Number of activities at t1 and selected rival predictors being equal, persons low in Active Coping/D but high in Openness to Experience reported more activities six weeks post-surgery than their low on Openness counterparts. Simple means for low dispositional active copers with high and low levels of Openness are presented in Figure 30.

Uncorrected group means indicate that low Active Coping/D (dispositional) but highly open individuals actually stayed on their pre-surgery level of number of activities over time whereas their low open counterparts narrowed their field of action somewhat after the operation. It should be pointed out that control for vision-related variables and multimorbidity did not in any way lower or account for the amount of outcome variance explained by Openness to Experience within the group of dispositional low active copers.

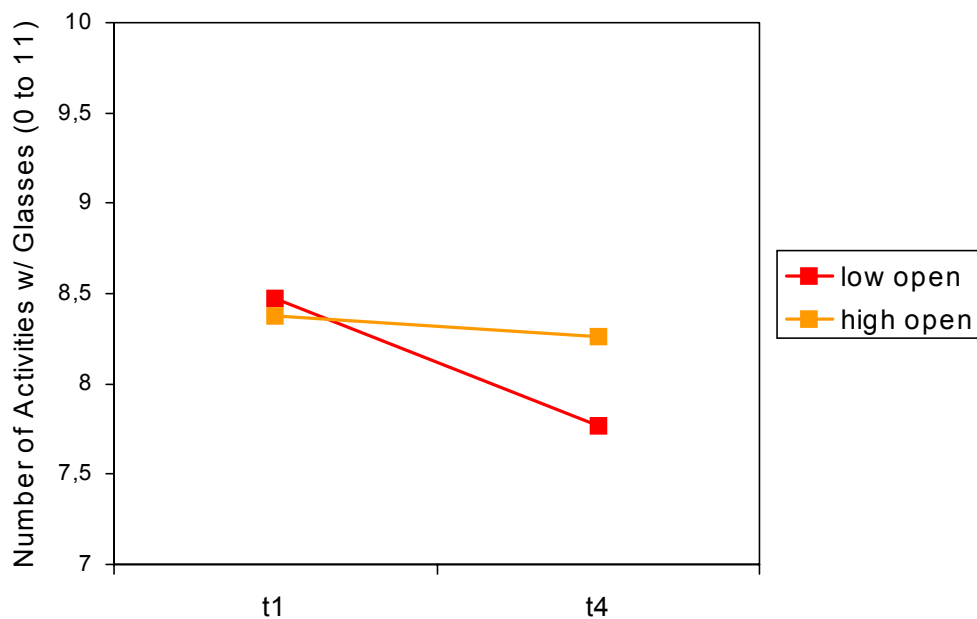

Figure 30 *Simple means of number of activities (with glasses on) for low dispositional active copers with high and low levels of Openness over time.*

²⁰ Once again, and while entering all rival predictors into the equation (see Table 44, *Note*), simple slope follow-up analyses (Aiken & West, 1991) yielded comparable results.

5.7.5. Would Dispositional Coping Moderate the Relationship Between Visual Acuity and Functional Status?

Did associations between dispositional coping styles and indicators of functional status vary with different levels of visual acuity or change thereof? To examine this question exploratively, a number of additional regression analyses were conducted, focusing on possible interactions between visual acuity and dispositional coping styles when functional status was predicted. Apparently, there was no indication for further qualification of the dispositional coping functional status relationships by objective vision data. None of the interactions tested (incorporating both level and change of visual acuity as factors in the terms) turned out significant.

5.7.6. Better Vision, More Action for Some: Summary So Far

Number of Activities. To sum up the central findings for level and change of vision-related functional status thus far, while there did not seem to be much change in actual numbers of activities pursued on average, some variation was still found. A small part of this variation at first glance related to the degree that individuals were open to new experiences and chose to cope actively with difficult situations in general. Pre-surgery status being equal, both tendencies were related to more activities pursued six weeks post-surgery. As before, there was no indication of *habitual* coping taking on a mediator status between Openness and change in number of activities. However, testing an alternative moderation model revealed that especially low (dispositional) active copers profited somewhat from being open to experiences in that they kept up the total number of activities pursued prior to the operation, while less open individuals exhibited a decline. Another habitual coping style marginally associated with the pursuit of activities six weeks after the implantation of the new lens was dispositional Support Seeking/D. Above and beyond the control of data on both visual acuity and multimorbidity, individuals with a habitual tendency to seek support when in difficult situations reported fewer pursued activities six weeks after the surgery. The same was not true, however, when change in pursuit of activities was regarded.

Intensity of Limitation. Emotionally labile persons, while complaining about especially high levels of vision-related intensity of limitation, did not actually report pursuing fewer activities prior to surgery. Six weeks following surgery, the positive association between Neuroticism and limitations was no longer significantly different from zero. On the other hand, open persons whose surgery outcomes were especially positive (much positive change in visual acuity-group) indicated the steepest decline in difficulties associated with the pursuit of activities (level of reported difficulties at t1 being equal). Extraversion was not reliably related to any of the indicators of vision-related functional status.

As for habitual coping, only one association with intensity of limitations was found: The more individuals indicated to cope actively with difficult situations in general, the more vision-related limitations they reported prior to surgery. All of the first glance bivariate associations between dispositional Support Seeking and limitations experienced were mostly explained by participants' general health status.

Considering both groups of long-term outcomes, i.e., emotional well-being and functional status, a further interesting question might address which came first, well-being having an influence on functional status or vice versa. To test these relationships, however, multiple post-operative measurements of both sets of outcomes would have been necessary. Since this was not the focus of the present study, no further models investigating different possible constellations of both sets of outcomes were examined.

The following section is concerned with a somewhat different look at coping, i.e., two more content-free aspects of coping, selective coping versus total range of coping. It is examined how or with which kind of pattern individuals engage in coping efforts rather than which sorts of content strategies lead to which sort of outcome. The organization of this third and last part of the Results chapter is different from that of the second part: At first, associations between situation-specific and dispositional indicators of more content-free aspects of coping and outcome measures (situation-specific as well as distal well being, and indicators of longer term functional status) are reported. Secondly, relations between higher-order personality traits N, E, O and selective coping versus total range of coping are tested. And last, the interplay of personality traits, more

content-free coping and different outcome measures are examined for possible mediation.

5.8. Selective Coping Versus Total Range of Coping

The next section of findings deals with two more content-free features of coping: selective coping versus total range of coping. *Selective coping*, in accordance with the work by Staudinger and Fleeson (1996), was operationalized as the intraindividual variance exhibited in the reports of the four coping responses. *Total range* of coping, on the other hand, was operationalized as the sum of strategies that were endorsed in the positive range (for details, see Section 4.2.7.).

5.8.1. More Content-Free Aspects of Coping Predict Situation-Specific Outcomes

The following paragraphs describe findings concerning hypotheses about the adaptiveness of pronounced endorsement patterns (highly selective coping) versus availability and use of many coping strategies at once (high total range of coping)

Table 44

Pearson Correlations of Situation-Specific Total Range of Coping and Selective Coping with Positive and Negative Affect, and Coping Satisfaction

| | Situation-Specific Total Range of Coping | Situation-Specific Selective Coping |
|------------------------------|---|--|
| PA t1 (N = 110) | .32** | .34** |
| PA t2 (n = 102) | .30** | .27** |
| PA t3 (n = 101) | .18* | .33** |
| PA t4 (n = 94) | .29** | .01 |
| NA t1 (N = 110) | .30** | -.09 |
| NA t2 (n = 102) | .29** | -.17 [†] |
| NA t3 (n = 101) | .35** | -.09 |
| NA t4 (n = 94) | .20 [†] | -.01 |
| Coping Satisfaction (n = 93) | -.21* | .15 |

Note. PA = Positive Affect; NA = Negative Affect. [†] $p < .10$, * $p < .05$, ** $p < .01$, *** $p < .001$.

looking at situation-specific coping responses immediately before surgery and all situation-specific outcome measures (i.e., affect and coping satisfaction). Table 44 shows the correlations of both situation-specific more content-free coping measures with Positive and Negative Affect pre- and post-surgery, as well as coping satisfaction. Contrary to expectations, total range in availability and use of situation-specific coping was significantly and positively associated with almost all Positive and Negative Affect measures around surgery and, moreover, those assessed six weeks post-surgery.

Utilizing a whole number of coping strategies prior to the operation (high total range) was thus connected with both more negative and more positive emotions at all assessed time points. In accordance with expectations, however, selective coping, i.e., intraindividual variation in coping responses, was associated primarily with Positive Affect immediately around surgery.

There was only one marginally significant negative correlation involving Negative Affect on the day of surgery. For the most part, reporting highly selective situation-specific coping, i.e., using some coping strategies intensely and others almost not at all, was connected with more positive mood in anticipation and immediately following surgery. In accordance with expectations, total range of coping was negatively associated with coping satisfaction. The association was rather weak, however.

Hierarchical regression analyses that essentially tested the same hypotheses while at the same time controlling for a number of covariates of the affect measures²¹ yielded almost identical results (see Table 45). Entering both more content-free coping measures at once, both shared positive associations with almost all assessments of Positive Affect. Situation-specific selective coping was not associated with Positive Affect at t4. In terms of longitudinal prediction, exhibiting a pronounced endorsement pattern of situation-specific coping seemed beneficial in that it was marginally associated with more Positive Affect at discharge when day of surgery Positive Affect was held constant. Looking at the time frame from discharge to six weeks post-surgery, however, having a number of coping strategies available or a high total range of coping was connected with more positive mood at t4 while PA at t3 was controlled.

²¹ Here, all established covariates of Positive Affect were controlled for at once: . t1: age, sex, 1st/2nd Eye, multimorbidity, type of anesthesia, pre-visual acuity in the eye operated on. t2: age, sex, 1st/2nd Eye, multimorbidity, anesthesia. t3: age, sex, 1st/2nd Eye, multimorbidity. t4: age, sex, 1st/2nd Eye, change in visual acuity in the eye operated on. With analyses involving NA as the outcome only age, sex, and previous experience with cataract surgery (1st/2nd Eye) were controlled for.

Table 45

Summary of Hierarchical Regression Analyses: Situation-Specific Selective Coping and Total Range of Coping Predicting Positive Affect at Different Points in Time

| Outcome | β (last step) | R | ΔR^2 |
|---|---------------------|-----|------------------|
| Positive Affect t1 (N = 110) | | | |
| Rival Predictors ^a | - | .48 | .23*** |
| add Total Range | .30*** | .55 | .08*** |
| add Selective Coping | .29*** | .62 | .08** |
| Positive Affect t2 (n = 102) | | | |
| Rival Predictors ^b | - | .37 | .14* |
| add Total Range | .33*** | .48 | .10*** |
| add Selective Coping | .22* | .53 | .05* |
| Positive Affect t3 (n = 101) | | | |
| Rival Predictors ^c | - | .30 | .09 [†] |
| add Total Range | .20* | .36 | .04* |
| add Selective Coping | .30** | .46 | .08** |
| Positive Affect t4 (n = 94) | | | |
| Rival Predictors ^d | - | .30 | .09 [†] |
| add Total Range | .27** | .40 | .07** |
| add Selective Coping | -.00 | .40 | .00 |
| Change in Positive Affect t2 to t3 (n = 101) | | | |
| Rival Predictors (PA t2 added) ^c | - | .75 | .56 |
| add Total Range | -.03 | .75 | .00 |
| add Selective Coping | .14 [†] | .76 | .02 [†] |
| Change in Positive Affect t3 to t4 (n = 86) | | | |
| Rival Predictors (PA t3 added) ^d | - | .44 | .19** |
| add Total Range | .26* | .52 | .07** |
| add Selective Coping | -.11 | .53 | .01 |

Note. PA = Positive Affect. [†] $p < .10$, * $p < .05$, ** $p < .01$, *** $p < .001$. a: Age, sex, 1st/2nd Eye, multimorbidity, type of anesthesia, pre-visual acuity in the eye operated on. b: Age, sex, 1st/2nd Eye, multimorbidity, anesthesia. c: Age, sex, 1st/2nd Eye, multimorbidity. d: Age, sex, 1st/2nd Eye, change in visual acuity in the eye operated on.

Concerning Negative Affect, hierarchical regression analyses also confirmed bivariate results. Total range of coping strategies endorsed by the patient pre-surgery was positively related with Negative Affect at all measurement occasions (see Table 46), but to varying degrees. While there were rather strong associations indicating much explanation of variance in the outcome (varying between 9% and 12%) at assessments immediately surrounding surgery (t1 to t3), six weeks post-surgery, the relation weakened considerably. Taking residualized change into consideration yielded more Negative Affect immediately following the operation (while NA at t2 was controlled)

for individuals who had reported using many coping strategies prior to surgery, compared to those who indicated fewer coping responses ($\Delta R^2 = .05$). A weaker and only marginally significant effect pointing in the same direction was found for the change in Negative Affect from discharge to six weeks post-surgery. Negative mood at discharge being equal, higher total range of situation-specific coping pre-surgery was still associated with more negative emotions six weeks post-surgery.

Table 46

Summary of Hierarchical Regression Analyses: Situation-Specific Selective Coping and Total Range of Coping Predicting Negative Affect at Different Points in Time

| Outcome | β (last step) | R | ΔR^2 |
|------------------------------------|---------------------|-----|------------------|
| Negative Affect t1 (N = 110) | | | |
| Rival Predictors | - | .24 | .06 [†] |
| add Total Range | .33*** | .40 | .11*** |
| add Selective Coping | -.06 | .41 | .00 |
| Negative Affect t2 (n = 102) | | | |
| Rival Predictors | - | .36 | .13** |
| add Total Range | .30** | .47 | .09** |
| add Selective Coping | -.11 | .48 | .01 |
| Negative Affect t3 (n = 101) | | | |
| Rival Predictors | - | .16 | .03 |
| add Total Range | .35*** | .39 | .12*** |
| add Selective Coping | -.05 | .39 | .00 |
| Negative Affect t4 (n = 94) | | | |
| Rival Predictors | - | .17 | .03 |
| add Total Range | .21* | .27 | .04* |
| add Selective Coping | .01 | .27 | .00 |
| Change in Negative Affect t2 to t3 | | | |
| Rival Predictors (NA t2 added) | - | .48 | .23*** |
| add Total Range | .24* | .53 | .05* |
| add Selective Coping | -.01 | .53 | .00 |
| Change in Negative Affect t3 to t4 | | | |
| Rival Predictors (NA t3 added) | - | .19 | .04 |
| add Total Range | .20 [†] | .27 | .04 [†] |
| add Selective Coping | -.01 | .27 | .00 |

Note. NA = Negative Affect. [†] $p < .10$, * $p < .05$, ** $p < .01$, *** $p < .001$. Rival predictors: Age, sex, 1st/2nd Eye.

Affect Balance. Staudinger and Fleeson (1996) examined specifically what was termed "Affect Balance" by Bradburn (1969) as a main outcome variable indicating psychological well-being. Affect Balance represents the difference between Positive and

Negative Affect at one point in time, amounting to the quantity of surplus Positive Affect an individual reports. Analyses reported above were thus repeated using the "Affect Balance" measure as an outcome (Appendix C, Table C13). Resembling findings by Staudinger and Fleeson, *selective* situation-specific coping prior to surgery proved to be the superior predictor with regard to Affect Balance. It was independently related to surplus PA (Affect Balance) at admission ($\beta = .28^{**}$, $\Delta R^2 = .08^{**}$), day of surgery ($\beta = .23^*$, $\Delta R^2 = .05^*$), and discharge ($\beta = .30^{**}$, $\Delta R^2 = .09^{**}$). The latter relation remained marginally significant when Affect Balance at t2 was controlled for ($\beta = .15^\dagger$, $\Delta R^2 = .02^\dagger$). Total range of situation-specific coping, on the other side, was only marginally related to Affect Balance six weeks post-surgery, without ($\beta = .18^\dagger$, $\Delta R^2 = .03^\dagger$) and with control of the previous measurement point ($\beta = .19^\dagger$, $\Delta R^2 = .04^\dagger$).

Coping Satisfaction. Despite only a shallow bivariate association, coping satisfaction as an alternative situation-specific outcome was still predicted by total range of coping strategies (situation-specific) after controlling for a number of covariates, such as age, sex, and previous experience with cataract surgery ($\beta = -.22^*$, $\Delta R^2 = .06^*$), thus indicating that patients using more coping strategies pre-surgery were less satisfied with their coping efforts. Selective coping was not related to ratings of coping satisfaction.

To sum up the previous sections, further evidence for Staudinger and Fleeson's (1996) results seemed to emerge. Findings on selective coping versus total range of situation-specific coping responses prior to the operation suggested some adaptive value of especially high selectivity in coping prior to surgery. Selective coping was related to positive mood at all points prior to the operation and at discharge from the hospital. Furthermore, there was some indication of more positive mood at discharge, the prior assessment being controlled in individuals with a pronounced endorsement pattern of coping. Also, selective coping was found related with surplus Positive Affect at all hospital measurement points. Contrary to expectations, total range of situation-specific coping strategies was highly related to both Positive and Negative Affect at the majority of measurement occasions. As for coping satisfaction, results indicated an expected lower level of satisfaction with coping efforts when many coping strategies were

positively endorsed (high total range of coping). The results reported are net of effects of the established control criteria.

5.8.2. More Content-Free Measures Predict Affect Above and Beyond Content of Coping Efforts?

Next, it was of interest to see whether the content-free aspects of coping, would predict affect outcome variance when all of the four coping responses were controlled for²². For instance, would selective coping still predict positive mood before and after surgery, when all of the content scales served as rival predictors? Looking at findings so far, affect at many times seemed to be predicted by both content and content-free aspects of coping. Findings by Staudinger and Fleeson (1996) suggest that e.g., selective coping accounted for a still significant 1% of the well-being outcome variance, when content of coping patterns was accounted for.

Employing hierarchical regression, situation-specific coping scales were entered into the first block of the analyses. In two further steps, situation-specific total range and selective coping were entered. In this instance, no further covariates of affect were considered as control variables²³.

Situation-specific selective coping did not remain a significant predictor of Positive Affect after respective content scales were controlled for (Appendix C, Table C15). Total range of situation-specific coping, however, still contributed significant amounts of variance to the prediction. Above and beyond content coping, situation-specific total range still predicted positive mood on the day of surgery, six weeks post-surgery, and change in positive mood between discharge and six weeks post. As for Negative Affect, while controlling for content scales, total range of coping was still associated with NA on the days of surgery and discharge. Also, range of coping still contributed to the

²² Moderate to high intercorrelations between content coping scales and "content-free" measures were evident (ranging from $r=-.13$ to $r=.68$) causing great concern about collinearity problems among predictors of the respective analyses. Indices of collinearity were thus taken into consideration and evaluated using criteria established by Belsey, Kuh, and Welsh (1980). Authors suggest intolerable collinearity when condition indices greater than 3 combined with at least two variance proportions for an individual variable greater than .50 are found. These criteria were not met by any of the reported analyses.

²³ With the use of a $p<.001$ criterion for Mahalanobis distance, one multivariate outlier was found among cases. Case 2 was a 62-year-old man reporting particularly high Active Coping (thus high selective coping) and affect pre-surgery. It was decided to drop this case from all further analyses including both content and "content-free" measures as predictors.

explanation of outcome variance in Affect Balance or surplus Positive Affect six weeks post-surgery (Appendix C, Table C16).

5.8.3. Distal Well-Being Predicted by Dispositional Content-Free Coping Measures?

Turning to longer-term measures of well-being, such as depressive symptoms (t4) and life satisfaction (t1 and t4), bivariate associations with both dispositional more content-free coping measures were rather weak (Table 47).

Total range of coping in its dispositional form was significantly and negatively related to life satisfaction at t1, pointing to lower pre-surgery life satisfaction in individuals habitually using a wider range of coping modes. This association remained stable after controlling for age, sex, multimorbidity, and pre-surgery visual acuity in the eye operated on ($\beta = -.27^{**}$, $\Delta R^2 = .07^{**}$). Controlling for the dispositional coping content scales, however, led to the disappearance of the effect (Appendix C, Table C17). Neither selective coping nor total range of coping (dispositional) were associated with change in life satisfaction from pre- to six weeks post-surgery.

Table 47
Pearson Correlations of Dispositional Total Range of Coping and Selective Coping with Life Satisfaction and Depressive Symptoms

| | Life Satisfaction t1 | Life Satisfaction t4 | Depressive Symptoms t4 |
|-------------------------|----------------------|----------------------|------------------------|
| Total Range of Coping/D | -.29** | -.15 | .14 |
| Selective Coping/D | -.15 | .07 | -.22* |

Note. [†] $p < .10$, * $p < .05$, ** $p < .01$, *** $p < .001$.

Regarding depressive symptoms at t4, only dispositional selective coping was weakly and negatively associated with it, suggesting less depressive symptoms in individuals reporting a highly pronounced coping pattern. This rather weak association, however, did not withstand the control for other covariates of depressive symptoms.

Next, possible associations of dispositional more content-free coping measures with a second set of more distal outcome measures are explored, i.e., level and change of vision-related functional status.

5.8.4. More Content-Free Aspects of Dispositional Coping Predict Functional Status?

The question of whether content-free dispositional measures of coping would be associated with any of the more functional aspects of adaptation was examined exploratively. Table 48 presents bivariate associations.

Table 48
Correlations between Dispositional "Content-Free" Coping and Vision-Related Functional Status

| | Total Range of Coping/D | Selective Coping/D |
|----------------------------|-------------------------|--------------------|
| Number of Activities t1 | -.17 | .07 |
| Number of Activities t4 | -.06 | .10 |
| Intensity of Limitation t1 | .25* | -.04 |
| Intensity of Limitation t4 | .15 | -.09 |

Note. n = 93. † $p < .10$, * $p < .05$, ** $p < .01$, *** $p < .001$.

As can be seen, even on a bivariate level, there was only one significant correlation of dispositional total range of coping with intensity of limitations experienced at t1, i.e., upon admission to the hospital.

Table 49
Total Range of Coping/D Predicts Vision-related Intensity of Limitation at t1 Without and With Control for Dispositional Coping Scales (Content): Results of Hierarchical Regression Analyses

| Outcome | β (last step) | R | ΔR^2 |
|--|---------------------|-----|--------------|
| Intensity of Limitation t1 | | | |
| Rival Predictors | - | .28 | .08† |
| Total Range of Coping/D ^a added | .23* | .36 | .05* |
| Intensity of Limitation t1 | | | |
| Rival Predictors | - | .28 | .08† |
| Dispositional Coping Content Scales added | - | .38 | .07* |
| Total Range of Coping/D ^a added | .10 | .39 | .01 |

Note. a: Dispositional version. n = 93. † $p < .10$, * $p < .05$, ** $p < .01$, *** $p < .001$. Rival predictors: Age, sex, pre-surgery visual acuity in the eye operated on.

Following up this association while controlling for a number of rival predictors to intensity of limitation at t1, dispositional total range of coping was still positively related with reported difficulties ($\beta = .23^*$, $\Delta R^2 = .05^*$, $n = 93$). This suggested that persons who habitually engaged in a greater number of coping strategies also reported having more difficulties pursuing vision-related activities. However, this was true only before surgery, not afterwards. Additionally, when content-scales were controlled for, dispositional range of coping did not account for outcome variance any longer (see Table 49).

Aside from the above-reported prediction, neither of the more content-free coping measures predicted level or change in functional status variables at any point in time.

5.8.5. Associations Between Higher-Order Personality Traits and More Content-Free Coping Measures

The next paragraphs explore relationships between personality traits and more content-free measures of coping. On the basis of findings so far, it might be expected that wider ranges of coping strategies would be exhibited more often by emotionally labile persons and that emotionally labile persons would not present with pronounced coping patterns (or highly selective coping), i.e., they would endorse many coping strategies more or less strongly, thus showing low intraindividual variance in coping. Table 50 presents zero-order correlations of personality traits with selective coping and total range of situation-specific and dispositional coping.

Table 50
Pearson Correlations of Situation-Specific and Dispositional Total Range of Coping and Selective Coping with Neuroticism, Extraversion, and Openness to Experience

| | Neuroticism | Extraversion | Openness |
|---|------------------|--------------|----------|
| Sit.-Spec. Total Range of Coping ^a | .15 | .13 | .10 |
| Sit.-Spec. Selective Coping ^a | -.23* | .10 | .29** |
| Dispositional Total Range of Coping ^b | .18 [†] | -.03 | .06 |
| Dispositional Selective Coping ^b | -.17 | .05 | .15 |

Note. [†] $p < .10$, * $p < .05$, ** $p < .01$, *** $p < .001$. a: N = 110. b: n = 94.

On a bivariate level, looking at situation-specific content-free coping measures, a first indication for the above-mentioned associations emerged. Emotionally labile persons seemed indeed more likely to exhibit lower intraindividual variance in the use of situation-specific coping responses prior to surgery, meaning, they were less selective. The second prediction of high Neuroticism scorers, also reporting a wider range of coping strategies pre-surgery, however, became significant only when the abbreviated, net of affectivity version of Neuroticism/S was tested. Here a very slight, but significant positive association was found ($r = .19$, $p = .049$, $N = 110$). Also, a positive association emerged between selective coping and Openness to Experience.

With dispositional content-free measures, associations were much weaker, none of them being fully significant. Only one marginally positive association was found in this instance, total range of coping/D was weakly related to Neuroticism. Again looking at the net of affectivity version of Neuroticism/S, this association was a bit stronger, with $r = .21$ ($p = .04$, $N = 110$). Since none of the demographic and medical variables assessed correlated with any of the more content-free aspects of coping which were in turn associated with personality traits, no further control analyses were conducted. However, in the following section the relationships between personality variables and content-free coping measures were again contemplated when full path analyses tested for possible mediation.

5.8.6. Evidence for Content-Free Aspects as Mediators?

To examine the related question of whether content-free aspects of coping would also take on a mediator status between higher-order personality traits and the various outcome measures, findings of all previous sections were again inspected. In fact, many of the possible model constellations could not be tested for mediation because one or more of the necessary presuppositions formulated by Baron and Kenny (1986) were not met to begin with. Two sets of models were tested concerning the prediction of situation-specific affect before and immediately after the operation. The first model dealt with possible indirect effects of the Openness - Positive Affect (t1) relationship via situation-specific selective coping. The second set of models shed light on the question of whether emotionally labile persons exhibited less Positive Affect at discharge (and

change of PA from t2 to t3) in part because they lacked a pronounced situation-specific coping pattern (i.e., were not selective enough).

A third and last model concerned the prediction of a more long-term functionally related outcome, i.e., experienced vision-related limitations in pursuing everyday activities before the operation. While controlling for best corrected visual acuity (t1), both Neuroticism and *habitual total range of coping* predicted more difficulties in the pursuit of activities prior to surgery when tested separately. In emotionally labile persons, could the experience of more difficulties with everyday activities *before surgery* be explained partly by their dispositional tendency to employ a wider set of coping strategies?

Prediction of Situation-Specific Affect. Turning to the first model, a possible indirect effect of situation-specific selective coping on the Openness - Positive Affect (t1) relationship was tested. Figure 31 depicts the model, with factors age, sex, previous experience with cataract surgery, visual acuity, anesthesia, and multimorbidity being equal. The direct effect of the independent variable on the outcome was indeed diminished from $\beta_{pre-selcope} = .22^*$ to a marginally significant $\beta_{post-selcope} = .16^\dagger$ after an additional control for selective coping. This established an indirect effect of .07 units and at least partial mediation.

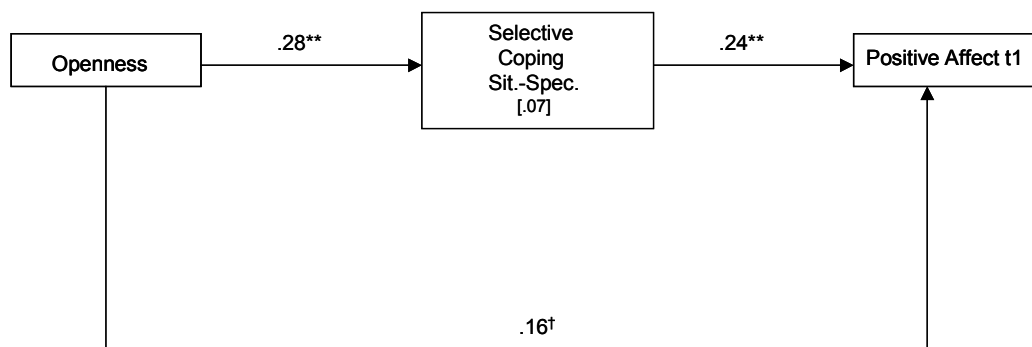

Figure 31 Relationship among Openness, selective coping (situation-specific), and Positive Affect at t1: Standardized regression coefficients ($N = 110$). The arrow from Openness to selective coping indicates a standardized partial regression coefficient, net of age, sex, and 1st/2nd Eye. Number in parentheses is the mediational effect of selective coping (situation-specific).

Figure 32 shows the second model. Effects are net of age, sex, experience with cataract surgery, and multimorbidity. The direct effect of Neuroticism on Positive Affect at t3

shrinks from a $\beta_{pre-selcope} = -.25^{**}$ to a marginally significant $\beta_{post-selcope} = -.19^{\dagger}$ when situation-specific selective coping is controlled for. There is evidence of partial mediation through an indirect effect via selective coping which amounts to .06 units. Looking at change in Positive Affect from t2 to t3 (after controlling for the aforementioned factors), mediation could not be observed any longer. Just as seen with the model including content coping scales (Section 5.5.10.), independent prediction of outcome variance by selective coping did not survive the control for Neuroticism (Figure 33).

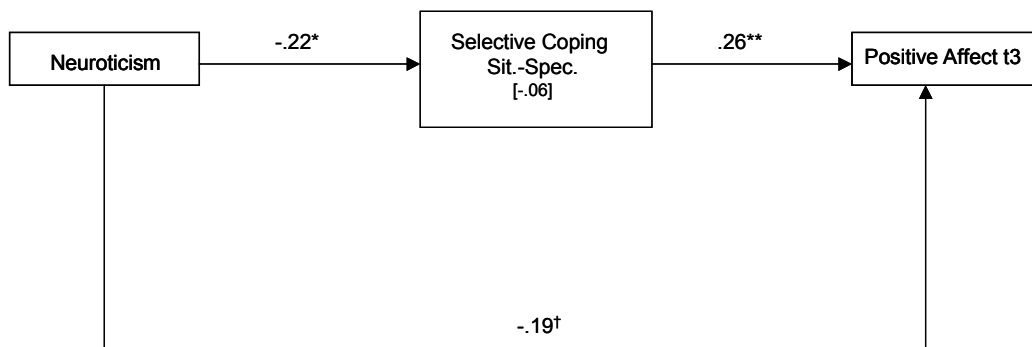

Figure 32. Relationship among Neuroticism, selective coping (situation-specific), and Positive Affect at t3: Standardized regression coefficients ($n = 101$). The arrow from Neuroticism to selective coping indicates a standardized partial regression coefficient, net of age, sex, and 1st/2nd Eye. Number in parentheses is the mediational effect of selective coping (situation-specific).

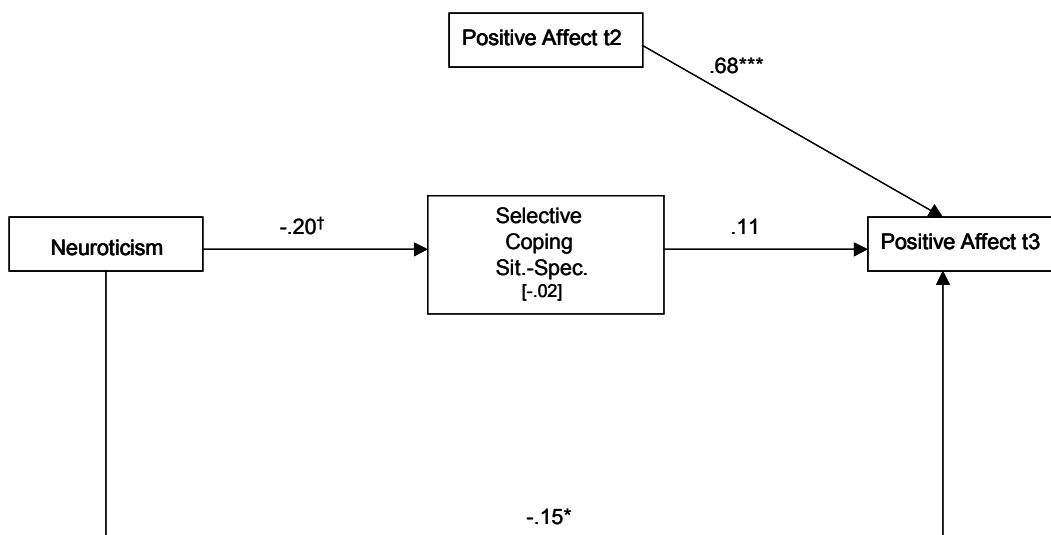

Figure 33 Relationship among Neuroticism, selective coping (situation-specific), and change in Positive Affect from t2 to t3: Standardized regression coefficients ($n = 101$). The arrow from Neuroticism to selective coping indicates a standardized partial regression coefficient, net of Positive Affect at t2, age, sex, and 1st/2nd Eye. Number in parentheses is the mediational effect of selective coping (situation-specific).

Both of the above-reported models remained virtually unchanged when the abbreviated net of negative affectivity version of Neuroticism/S was tested as an independent variable (Appendix D, Tables D21 and D22).

Possible moderation effects were tested next. There was no indication for differential effectiveness of selective coping for different levels of personality traits Neuroticism and Openness, none of the tested interaction terms were significant.

After partial mediation by selective coping could be established, the next question was whether it would contribute to an indirect effect above and beyond the content scales of situation-specific coping. As was to be expected from results of Section 5.8.2., however, selective coping did not contribute to explained outcome variance when content scales were controlled for (see Table 51).

Table 51
Summary of Hierarchical Regression Analyses Predicting Positive Affect at Admission, Discharge and Change in Positive Affect from Day of Surgery to Discharge

| Outcome | β (last step) | R | ΔR^2 |
|---|---------------------|-----|--------------|
| Positive Affect t1 ^b | | | |
| Situation-Specific Coping Scales | - | .45 | .21*** |
| Openness | .19* | .49 | .03* |
| Selective Coping Situation-Specific | .02 | .49 | .00 |
| Positive Affect t3 ^a | | | |
| Situation-specific Coping Scales | - | .42 | .18** |
| Neuroticism | -.26* | .48 | .06* |
| Selective Coping Situation-Specific | .03 | .49 | .00 |
| Change in Positive Affect t3 ^a | | | |
| Positive Affect t2 Situation-Specific Coping Scales | - | .75 | .57*** |
| Neuroticism | -.16* | .77 | .03* |
| Selective Coping Situation-Specific | .16 | .78 | .01 |

Note. [†] $p < .10$, * $p < .05$, ** $p < .01$, *** $p < .001$. a: $n = 100$. b: $n = 109$.

Moreover, when content scales of situation-specific coping were controlled for, Neuroticism failed to predict situation-specific selective coping significantly any longer ($\beta = -.10$, $\Delta R^2 = .01$), while Openness shared only marginally significant amounts of outcome variance of selective coping ($\beta = .14^\dagger$, $\Delta R^2 = .02^\dagger$).

Prediction of Intensity of Limitation Pre-Surgery. The third model unexpectedly yielded a similar picture to the one above. At first there was some indication of mediation, net of rival predictors, the direct effect of Neuroticism on intensity of limitations was reduced by roughly .04 units when total range of coping/D was added to the model. Surprisingly, total range of coping/D still added to the explanation of outcome variance while Neuroticism was accounted for. Looking at other models (e.g., Section 5.6.4.) with content aspects of habitual coping did not yield appreciable indirect effects on the outcome. However as before, adding dispositional coping content scales to the equation, the more content-free measure no longer accounted for additional variance in the model.

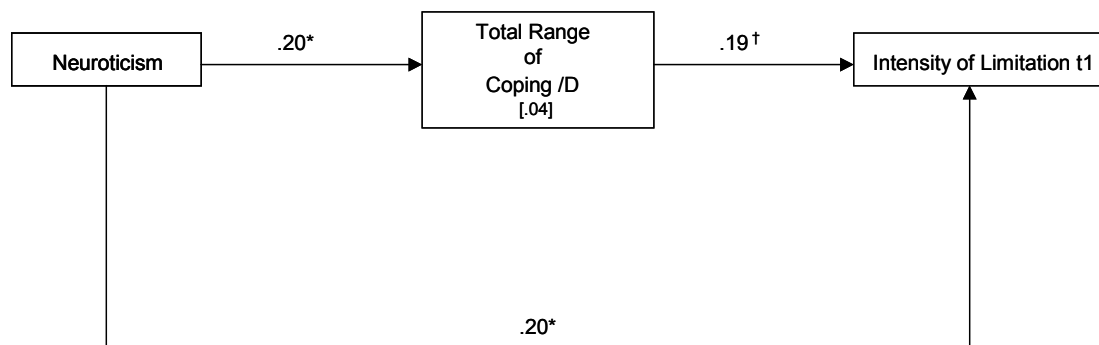

Figure 34 Relationship among Neuroticism, total range of coping/D (dispositional), and vision-related intensity of limitation at t1: Standardized regression coefficients ($n = 94$). The arrow from Neuroticism to total range of coping indicates a standardized partial regression coefficient, net of age, sex, and pre-surgery visual acuity in the eye operated on. Number in parentheses is the mediational effect of total range of coping (dispositional).

Possible moderation effects were also examined, but did not yield a significant interaction term of Neuroticism by total range of coping/D predicting intensity of limitations at t1.

In sum, predicting situation-specific affect as well as intensity of limitations at t1, while first there were some indications for mediating roles of the more content-free measures of coping between personality and outcomes, additional analyses taking into account the content measures did not support the initial findings. Instead, the content-free aspects of coping did not account for independent outcome variance when content scales were controlled for.

5.9. General Summary

The Results Chapter closes with an overview over the main research questions and hypotheses and corresponding results. All directed hypotheses and associated findings are briefly re-stated and evaluated. They and the other findings presented in the above chapter are resumed in the Discussion chapter following this overview. For clarity's sake, the general summary is presented in table form, outlining the main questions, directed predictions, whether or not hypotheses are supported by the data, and a brief commentary. The order presented in the summary table is slightly different from the organization of the Results chapter and follows the sequence in the chapter on research questions and hypotheses.

Table 52
Summary of Hypotheses and Results

| Research Question | Hypotheses | Supported by the Data? | Commentary/ Additional Results |
|--|--|------------------------|--|
| A Stressor Indeed? | | | |
| <i>Short-Term Outcomes</i> | | | |
| Negative Affect | State Negative Affect is expected to increase for all participants pre-surgery. | No | Means of state NA remained stable pre-surgery. |
| | On a subfacet level, NA-anxiety is expected to be the dominant emotion and show marked increase between the two pre-surgery measurement points. | Yes | |
| | State Negative Affect is predicted to decrease in all individuals immediately post-surgery. | Yes | |
| | This decrease should mainly be due to a drop in the NA-anxiety subfacet. | Yes | |
| | Random day state Negative Affect is predicted to be considerably lower than before surgery, however slightly higher than immediately following surgery. | Yes | |
| Positive Affect | Pre-surgery, attentiveness should be the highest ranking subfacet of Positive Affect when compared to self-assurance, low fatigue, or joviality. | Yes | |
| | Generally, an increase in state Positive Affect is expected after surgery. | Yes | |
| | On a subfacet level, joviality is expected to show the steepest increase. | Yes | |
| | Positive Affect on a random day is expected to be significantly higher than in anticipation of the surgery. | Yes | |
| <i>Levels and Change in Long-Term Outcomes</i> | | | |
| Life Satisfaction/ Depressive Symptoms | Mean life satisfaction is higher post-surgery than pre-surgery. | Yes | The effect of change in visual acuity on long-term well-being indicators lost its importance when multimorbidity was controlled. |
| | Change in visual acuity is expected to explain some of the change variance in life satisfaction from pre- to post-surgery as well as significant variance proportions of depressive symptoms post-surgery. | Partly | |
| Vision-dependent Functional Status | Functional limitations experienced while performing vision-dependent activities is expected to decrease following surgery. | Yes | Partly for number of activities. Change in limitations was predicted by t4 level of visual acuity. |
| | On average, the total number of heavily vision-dependent activities pursued is expected to increase post-surgery. | No | |
| | Both developments are expected to be explained partly by change in visual acuity from pre- to post-surgery. | No | |

(Table continued)

Table 53 (continued)

| Research Question | Hypotheses | Supported? | Commentary/ Additional Results |
|---|--|------------|--|
| Personality: Prediction of Outcomes During the Situation and Beyond? | | | |
| <i>Personality Traits and Situation-Specific Outcomes</i> | | | |
| The Affects | Neuroticism should be positively related to Negative Affect, especially in anticipation of the surgery. | Yes | Neuroticism was also negatively related to Positive Affect, especially upon discharge. Openness was positively associated with PA at t1 and change in NA from t1 to t2. |
| | Moreover, a steeper increase of Negative Affect immediately prior to surgery is expected for emotionally labile persons. | No | |
| | Extraversion is assumed to be associated with higher state Positive Affect in anticipation of the stressor. | Partly | Extraversion was significantly and independently related to PA at the day of surgery. |
| Coping Satisfaction | Neuroticism is expected to be negatively related with coping satisfaction. | Partly | Yes: Neuroticism No: Neuroticism/S |
| <i>Personality and Longer-Term Outcomes</i> | | | |
| Depressive Symptoms and Life Satisfaction | Neuroticism is expected to be positively associated with depressive symptoms but negatively with life satisfaction as long-term consequences of the operation. | Partly | Neuroticism accounted for independent variance in depressive symptoms only. Extraversion accounted for independent variance in life satisfaction (t4, change t1 to t4) only |
| | Extraversion is predicted to be negatively related with depressive symptoms, but positively with life satisfaction. | Partly | |
| Vision-related Functional Status | Emotionally labile persons are expected to report greater vision-related limitation than emotionally stable persons, especially prior to the intervention. | Yes | Openness was not significantly related to <i>level</i> of number of activities at t4. It did account for change variance. |
| | Post-intervention, Openness is expected to be positively related with the number of vision-dependent activities. Moreover, this trait is expected to account for a significant part of change variance concerning number of activities from pre- to post-intervention. | Partly | |
| Coping and Age | | | |
| Is Coping Associated with Age? | Situation-specific coping is not expected to exhibit relations with chronological age. | Yes | |

(Table continued)

Table 53 (continued)

| Research Question | Hypotheses | Supported? | Commentary/ Additional Results |
|--|--|------------|---|
| | Dispositional-coping, especially Active - and Focus on Positive coping, are expected to yield correlations with chronological age. | No | Dispositional Active Coping only narrowly missed an acceptable significance level, the association's direction was negative. |
| Coping: Prediction of Outcomes During the Situation and Beyond? | | | |
| Sit.-Spec. Coping Predicts Positive Affect | Focusing on the positive should be related with more Positive Affect pre- and immediately post-surgery. | Yes | Focus on Positive coping was also negatively related to Negative Affect (t1). |
| Sit.-Spec. Coping Predicts Negative Affect | Employing Evasive Coping (i.e., Venting, Denial, Self-Blame) should be associated with higher Negative Affect prior to surgery. | Partly | There was a positive association between Evasive Coping and Negative Affect only at t2. |
| | Using Active Coping (i.e., Planning, Active Coping) in a low control situation is expected to predict higher Negative Affect prior to surgery. | Partly | There was a positive association only at t1. Active Coping was also associated with Positive Affect. |
| Sit.-Spec. Coping Predicts Coping Satisfaction | Focusing on the positive should lead to high coping satisfaction. | Yes | |
| | Evasive Coping should predict less satisfaction with coping employed prior to surgery. | Yes | |
| | Using Active Coping before surgery should lead to lower satisfaction with coping. | Yes | |
| Dispositional Coping Predicts Longer-Term Well-Being | Dispositional Evasive Coping/D (Denial/D, Self-Blame/D, Venting/D) is expected to be associated with higher depressive symptoms six weeks post-surgery. | Yes | |
| | Dispositional Evasive Coping/D (Denial/D, Self-Blame/D, Venting/D) should be associated with less life satisfaction at all times. | Partly | Unique association was significant while life satisfaction at t1 was predicted. |
| | Habitual Focus on Positive/D coping (i.e., Humor/D, Acceptance/D, Positive Reframing/D) should lead to better long-term well being (more life satisfaction, less depressive symptoms) pre- and post-surgery. | Partly | Focus on Positive/D predicted depressive symptoms and life satisfaction (t4) only. Active Coping/D was associated with less life satisfaction (t4: level, change). |

(Table continued)

Table 53 (continued)

| Research Question | Hypotheses | Supported? | Commentary/ Additional Results |
|---|--|---|--|
| Dispositional Coping Predicts Long-Term Functional Status | Habitual forms of Active Coping/D are expected to predict the pursuit of more vision-dependent activities pre- as well as post-surgery. | Partly | Only post-surgery (and change from pre to post) did Active Coping/D predict pursuit of more activities. Also, dispositional Support Seeking/D was associated with fewer activities post-surgery. |
| | Active Coping/D should be associated with higher vision-related intensity of limitation pre-surgery. | Yes | |
| <i>Personality Predicts Coping</i> | | | |
| | Neuroticism should be positively associated with coping modes (dispositional and situation-specific), defined here as Evasive Coping, including Venting, Self-Blame, and Denial it is also expected to be related negatively to positive forms of coping, such as Positive Reframing, Acceptance, and Humor. | Partly | Neuroticism was not negatively associated with dispositional Focus on Positive/D coping. Neuroticism also predicted more situation-specific Support Seeking. |
| | Extraversion should positively predict (situation-specific and dispositional) Support Seeking and Focus on Positive coping, including Positive Reframing, Humor, and Acceptance. | Partly | Extraversion did not predict Support Seeking at all. It was positively associated with situation-specific Focus on Positive coping only. |
| | Openness to Experience should most likely be positively associated with both situation-specific and dispositional forms of Active Coping, which includes Planning as a substrategy. | Yes | |
| <i>Coping as a Personality Process?</i> | | | |
| | Situation-specific coping is expected to mediate partly the direct effects of personality traits on situation-specific outcome measures during the stressful situation. | <i>Pre-Surgery:</i> Mostly yes. <i>Post-Surgery:</i> Partly. | In one case, evidence of moderation was found. |
| | Dispositional coping is not expected to take on a mediator status between higher-order personality traits and long-term functional as well as emotional outcomes. Furthermore, dispositional coping is predicted to lose its independent predictor-status once personality variables are controlled. | Mostly yes. | In one case, evidence of moderation was found. |

(Table continued)

Table 53 (continued)

| Research Question | Hypotheses | Supported? | Commentary/ Additional Results |
|---|--|------------|---|
| More Content-Free Aspects of Coping Predict Outcome Variables | | | |
| Content-Free Aspects: Situation-specific | Selective coping should be associated with more Positive Affect surrounding the stressful event. | Yes | |
| | Total range of coping is expected to be associated with higher Negative Affect surrounding surgery. | Yes | Total range of coping also predicted more Positive Affect surrounding surgery. |
| | Selective coping should also be positively related to more coping satisfaction. | No | |
| | Total range of coping is predicted to be negatively related with coping satisfaction. | Yes | |
| Content-Free Aspects: Dispositional | Selective coping/D should be associated with higher well-being pre- and post-event. | No | |
| | Total range of coping/D is expected to be associated with less well-being. | Partly | Total range of coping/D significantly predicted less life satisfaction only at t1. |
| Are Content-Free Coping Measures Associated with Longer-Term Functional Status? | No hypotheses. | Partly | Total range of coping/D predicted higher intensity of limitation prior to surgery. |
| Are Content-Free Coping Measures Predicted by Higher-Order Personality Traits? | No hypotheses. | Yes | <i>Situation-Specific:</i> Neuroticism was negatively related with selective coping, whereas Openness was positively related with it. <i>Dispositional:</i> Neuroticism was positively related with total range of coping/D. |
| Content-Free Coping Measures as Mediators? | No hypotheses. | Yes | There was evidence of situation-specific as well as dispositional <i>total range of coping</i> serving as partial mediators between Neuroticism/ Openness and various outcomes. |
| Prediction by Content-Free Measures Above and Beyond Content Scales? | Both selective coping and total range of coping (situation-specific and dispositional) are expected to predict outcome variance above and beyond content-coping. | Partly | Above and beyond content coping, only situation-specific range of coping explained independent outcome variance in the affects. |