



Inauguraldissertation  
zur Erlangung des Grades eines  
Doktors der Naturwissenschaften  
am Fachbereich Mathematik und Informatik  
der Freien Universität Berlin

# Conley Index at Infinity

vorgelegt von  
Juliette Hell

Berlin, 2010

Betreuer und Erstgutachter: Prof. Dr. B. Fiedler  
Zweitgutachter: Prof. K. Mischaikow

Tag der Disputation: 9. November 2009

Le silence éternel de ces espaces infinis m'effraye.

Blaise Pascal

Le vacarme intermittent de ces petits coins me rassure.

Paul Valéry



# Contents

<b>Introduction</b>	<b>iii</b>
<b>1 The Bendixson compactification</b>	<b>1</b>
1.1 Description of the transformation . . . . .	1
1.2 Normalization . . . . .	4
1.3 Some examples . . . . .	8
1.4 Some bad news . . . . .	10
<b>2 The Poincaré compactification</b>	<b>13</b>
2.1 Description of the transformation . . . . .	13
2.2 Normalization and time rescaling . . . . .	16
2.3 Some examples . . . . .	19
2.4 Poincaré versus Bendixson . . . . .	21
<b>3 Conley index: classical and at infinity</b>	<b>23</b>
3.1 Classical Conley index methods . . . . .	24
3.1.1 Basic definitions and properties of the Conley index . . . . .	24
3.1.2 Conley Index on a Manifold with Boundary . . . . .	34
3.1.3 Attractor–repeller decompositions . . . . .	39
3.1.4 Morse decompositions and connection matrices . . . . .	44
3.2 Conley index and heteroclines to infinity . . . . .	55
3.3 Some examples . . . . .	60
3.4 Conley index and duality . . . . .	61
3.5 The Conley index at infinity . . . . .	63
3.5.1 Under Bendixson compactification . . . . .	63
3.5.2 Under Poincaré compactification . . . . .	83
3.6 Limitations and properties . . . . .	101
<b>4 Ordinary differential equations</b>	<b>103</b>
4.1 Generalities on polynomial vector fields . . . . .	103
4.1.1 Classification results . . . . .	103
4.1.2 Critical points at infinity . . . . .	104
4.2 Gradient vector fields . . . . .	115

4.3	Hamiltonian vector fields . . . . .	117
4.3.1	Generalities on Hamiltonian vector fields . . . . .	117
4.3.2	Planar quadratic Hamiltonian vector fields . . . . .	118
4.4	A cube at infinity . . . . .	124
4.4.1	A cubic structure in the sphere at infinity . . . . .	124
4.4.2	Finite dynamic without lower order terms . . . . .	126
4.4.3	Finite dynamic with discrete Laplacian operator . . . . .	128
4.5	The Lorenz equations . . . . .	130
<b>5</b>	<b>Partial differential equations</b>	<b>133</b>
5.1	Chafee–Infante structure at infinity . . . . .	133
5.2	Case of a sublinear non–linearity . . . . .	137
5.3	Example of a bounded non–linearity . . . . .	138
5.4	Abstract polynomial PDE . . . . .	140
5.5	Blow–up and Similarity variables . . . . .	142
5.5.1	Philosophy of the Similarity Variables . . . . .	143
5.5.2	Power Nonlinearity . . . . .	147
5.5.3	Parabolic Scalar Curvature Equation . . . . .	150
	<b>Conclusions</b>	<b>155</b>
	<b>Appendix</b>	<b>157</b>

# Introduction

In this thesis we consider grow up and blow up phenomena (in forward or in backward time direction) and interpret them as heteroclinic connections between finite invariant sets and infinity. Under this point of view we formulate the following question: Which bounded invariant sets admit heteroclinic connections to infinity? There already exists methods which were developed for the analysis of bounded global attractors. Those arise in dissipative systems, which is in fact the assumption that we want to get rid of.

To adapt those methods for the analysis of heteroclinics to infinity and describe a non bounded attractor, we propose to make use of so called “compactifications”. A compactification is the projection of a Hilbert space  $X$  onto a bounded Hilbert manifold. If the space  $X$  is eventually infinite dimensional, the resulting Hilbert manifold is bounded but not compact because of its being infinite dimensional. Therefore the word “compactification” is not exact in this context, but we keep it for historical reasons. Compactifications were introduced already at the beginning of the theory of dynamical systems on the one hand under the name of Bendixson compactification, on the other hand by Poincaré in [31]. Those compactifications were first introduced to compactify dynamics on the plane, but we show in the first two chapters that they may be formulated for arbitrary Hilbert spaces. The Bendixson compactification is nothing more than a one point compactification where infinity is projected on the north pole of the Bendixson sphere by a stereographic projection. The north pole or “point at infinity” is, in many cases, so degenerated that one has to circumvent this degeneracy. This may be achieved through the Poincaré compactification. This compactification is based on a central projection and maps infinity onto a whole “sphere at infinity”. However in some cases the degeneracy at infinity resists this procedure.

Poincaré and Bendixson gave also their names to the famous theorem describing the longtime dynamic of planar vector fields. A globally bounded trajectory accumulates on its  $\omega$ -limit set which is a connected compact invariant set. In the case of planar vector fields, the Poincaré-Bendixson theorem guarantees that  $\omega$ -limit sets are one of the three following types:

1. an equilibrium,
2. a periodic orbit,

### 3. or a heteroclinic cycle

When the dimension of the phase space grows bigger, it is not possible to classify those invariant sets which are crucial for the long time dynamic. Already in dimension three, strange attractors may arise such as in the famous Lorenz system. An attempt to analyse sophisticated invariant sets and their interconnections may be done with the help of the Conley index theory.

This theory was invented by Conley in the 60's, and further developed until today for example by Franzosa, Mischaikow or Mrozek. . The Conley index does not deal directly with the invariant sets but with a neighbourhood isolating them. This index somehow draws a balance between the trajectories beginning in this neighbourhood and the trajectories leaving it. If those are in balance, i. e. everything which starts in the neighbourhood also leaves it, then the Conley index is "trivial" in the sense that it coincides with the Conley index of the empty invariant set. On the contrary, a neighbourhood giving rise to a non trivial Conley index admits a non trivial invariant set in its interior. This caricature of the Conley index shows that this tool is able to detect significant invariant sets. Furthermore the Conley index theory utilizes algebraic topology in structures called connection matrices, which are able to detect heteroclinic connections between isolated invariant sets.

In this thesis we will combine both compactifications of the phase space and Conley index theory. The compactifications allow us to materialize invariant sets at infinity, which are out of reach in an unbounded phase space. On these invariant sets at infinity we apply the Conley index methods so that heteroclinic connections between these sets and bounded invariant sets are put into light.

Although the global idea of this strategy seems clear, one encounters many obstacles on the way to its completion. The main obstacle was the motivation for the most demanding part of this thesis and concerns the degeneracy of the dynamical behaviour at infinity. Even for planar quadratic vector fields, the invariant sets at infinity are likely to be degenerate in the sense that they are not isolated invariant - hence out of reach for Conley index methods.

Our contribution is the development of a Conley index for a class of degenerate invariant sets at infinity that we denote by "invariant sets at infinity of isolated invariant complements". An invariant set  $S$  at infinity belong to this class if, roughly speaking, there exists an isolated invariant set  $R$  bounded away from  $S$  whose isolating neighbourhood may be chosen arbitrarily close to  $S$ . The precise definition is given in 3.5.1 and 3.5.30. An equilibrium in the compactification of the plane  $\mathbb{R}^2$  exhibiting only elliptic sectors is an example of an invariant sets with isolated invariant complement.

Our main result consists on showing that the algebraic machinery of the connection matrices extends to invariant sets at infinity with isolated invariant complements. Hence heteroclinic connections to this type of degenerate invariant sets at infinity can be detected by this generalized Conley index theory. This enlarges



significantly the horizon of the study of the behaviour at infinity via Conley index theory.

To define the Conley index of an invariant set of isolated invariant complement, we use duality concepts for the homological and cohomological Conley indices such as the Poincaré–Lefschetz duality or the time duality by Mrozek and Szrednicki [29]. We proceed to a topological construction on the compactified phase space, where the detection of heteroclinic orbits by connection matrices machinery is possible. Then we show how these connections translate to “true” connections between finite isolated invariant sets and the original degenerate invariant set at infinity.

More precisely, the main theorem is the following. Consider an invariant set  $S$  at infinity of isolated invariant complement  $S_{comp}$  (see Definitions 3.5.30 and 3.5.32). For an isolating block  $B$  of the “dynamical complement”  $S_{comp}$  of  $S$ , we defined an extended phase space  $Ext(B)$  (see Definition 3.5.43) and an extended flow  $\hat{\varphi}$  on  $Ext(B)$  (see Proposition 3.5.46). In this extension arise an attractor  $b^-$  and a repeller  $b^+$  which play the role of an “ersatz infinity”. Our main Theorems 3.5.50 and 3.5.22 may be summarized in the following way.

**Theorem.** *Assume that a set  $P \subset Ext(B)$  is isolated invariant under the flow  $\hat{\varphi}$ , admits an attractor–repeller decomposition  $(b^-, Q)$  where  $Q \subset S_{comp}$ , and it holds*

$$h(P) \neq h(b^-) \vee h(Q), \quad (1)$$

where  $h(\cdot)$  denotes the Conley index with respect to  $\hat{\varphi}$ . Then there is a heteroclinic orbit  $\sigma$  under the original compactified flow  $\varphi$  connecting  $Q$  to  $S$ , or more precisely

$$\alpha(\sigma) \subset Q,$$

$$\omega(\sigma) \cap S \neq \emptyset.$$

Assume that a set  $P \subset Ext(B)$  is isolated invariant under the flow  $\hat{\varphi}$ , admits an attractor–repeller decomposition  $(Q, b^+)$  where  $Q \subset S_{comp}$ , and it holds

$$h(P) \neq h(b^+) \vee h(Q), \quad (2)$$

where  $h(\cdot)$  denotes the Conley index with respect to  $\hat{\varphi}$ . Then there is a heteroclinic orbit  $\sigma$  under the original compactified flow  $\varphi$  connecting  $S$  to  $Q$ , or more precisely

$$\alpha(\sigma) \cap S \neq \emptyset,$$

$$\omega(\sigma) \subset Q.$$

Furthermore, Conditions 1 and 2 may be translated in terms of homology, so that the construction embeds in the machinery of the connection matrix.

We begin this thesis with the presentation of the Bendixson compactification in Chapter 1 and of the Poincaré compactification in Chapter 2. We show that

those are applicable for Hilbert spaces. This will reveal useful for application to partial differential equations. The third chapter presents the classical theory of Conley index and our extension to invariant sets with isolated invariant complement. After this rather theoretical part, we address some meaningful examples showing both the power and the limits of our methods. In Chapter 4 we concentrate on ordinary differential equations. There we show on concrete examples that the extension constructed in Chapter 3 allows to detect heteroclinic orbits and seem to be a good choice for the “ersatz infinity”. Furthermore, we try to exhibit some structure of the dynamics at infinity for some meaningful examples. Chapter 5 has its focus on partial differential equations. We show there how the concept of compactifications is useful in this context, but also which obstacles have to be surmounted to make this theory more powerful for infinite dimensional dynamics. We give a full description of the dynamic at infinity for linear partial differential equation. Furthermore we relate the compactifications to other methods used for studying blow-up such as similarity variables.

As a conclusion, we want to emphasize that the purpose of this thesis is rather to present new methods for the study of the behaviour at infinity and its relationships to the longtime bounded behaviour. We are aware that the examples illustrating those methods are somehow deceiving because low-dimensional mostly. We hope to be able in the near future to produce new results concerning partial differential equations by the application of these methods. This work should be seen as a first step on a long way leading in this direction.

The author thanks her dear colleagues for all the inspiration, encouragements, help, sweets, and strong coffee... I thank in particular my advisor for his helpful suggestions and his patience. And, last but not least, thank you Stephan and Emilie for making me so happy!

# Chapter 1

## The Bendixson compactification

The most spontaneous way of compactifying a vector space is to add a point to represent infinity. This one point compactification changes the vector space into a sphere of the same dimension called the Bendixson sphere.

### 1.1 Description of the transformation

To introduce the Bendixson compactification, we follow [1, 30] but without restricting us to the 2-dimensional case. We consider a Hilbert space  $X$ , possibly infinite dimensional, with a scalar product denoted by  $\langle \cdot, \cdot \rangle$ . This makes the term "compactification" somehow improper because the Bendixson transformation makes the phase space bounded but do not change the infinite dimensionality so that the space remains non-compact. Let us describe more concretely the Bendixson transformation. We add to  $X$  a, say, vertical direction and identify our original space  $X$  with the hyperplane  $X \times \{-1\}$  of  $X \times \mathbb{R}$ . Of course, the scalar product of  $X$  induces a scalar product on  $X \times \mathbb{R}$  as the addition of the scalar product  $\langle \cdot, \cdot \rangle$  on  $X$  with the standard scalar product on  $\mathbb{R}$  for the last component. The unit sphere  $\mathcal{S} := \{(x, z) \in X \times \mathbb{R} / \langle x, x \rangle + z^2 = 1\}$  and the hyperplane  $X \times \{-1\}$  are tangent at the point  $(0, -1)$ . This point is the south pole of the unit sphere and the origin of the hyperplane  $X \times \{-1\}$ . We now project the hyperplane  $X \times \{-1\}$  stereographically with respect to the north pole onto the unit sphere. Through this transformation, infinity gets mapped to the north pole. See figure 1.1 for illustration. There, a point  $M \in X \times \{-1\}$  gets mapped to the point  $P \in \mathcal{S}$ . The north pole and the points  $M$  and  $P$  are colinear. This fact together with the information  $P \in \mathcal{S}$  allows to compute explicitly the formulas for the projection.

We are interested in the behaviour near infinity alias the north pole of the unit sphere  $\mathcal{S}$ . It is more convenient to compute in the vector space  $X$  than on the sphere, so let us project on the hyperplane  $X \times \{+1\}$  tangent to the sphere at the north pole. For that we use again a stereographic projection, but

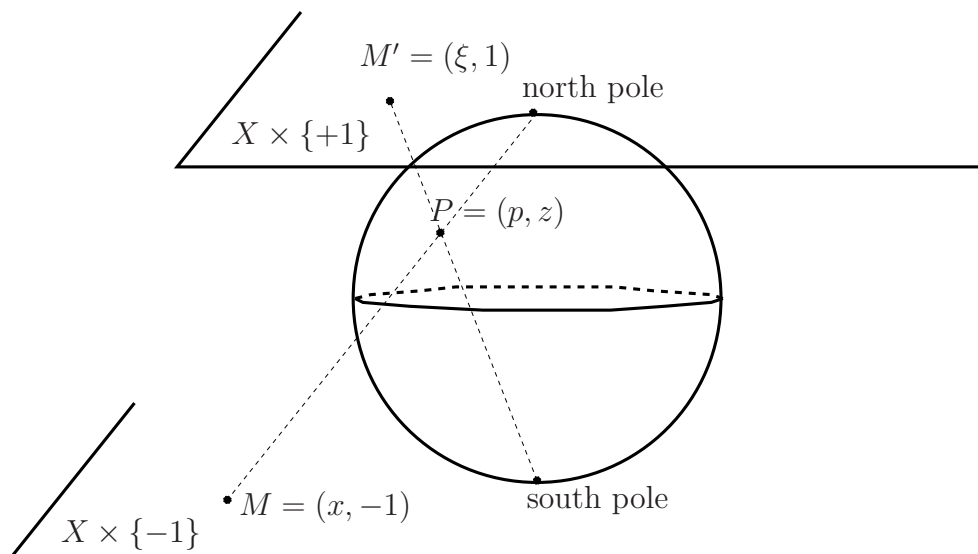

Figure 1.1: The Bendixson transformation.

this time with respect to the south pole. The whole sphere except the south pole is mapped diffeomorphically onto the hyperplane  $X \times \{+1\}$ . The north pole alias the point at infinity is now the origin  $(0, +1)$  of  $X \times \{+1\}$ . The projected dynamic around the origin  $(0, +1)$  of this hyperplane is the dynamic at infinity. See again the picture 1.1 for illustration. The point  $P \in \mathcal{S}$  gets mapped to the point  $M' \in X \times \{+1\}$ , so that the south pole and the points  $P$  and  $M'$  are colinear.

Now the time has come to establish the formulas transforming a dynamical system on  $X$  into a dynamical system in the neighbourhood of infinity alias  $(0, +1) \in X \times \{+1\}$ . For that let us consider the points

$$\begin{aligned} M &= (x, -1) \in X \times \{-1\}, \\ P &= (p, z) \in \mathcal{S} \text{ and} \\ M' &= (\xi, +1) \in X \times \{+1\}, \end{aligned}$$

as in picture 1.1. We assume the points  $M$  and  $M'$  different from the poles, so that  $x, p, \xi \neq 0$  and  $z \neq \pm 1$ . By construction the north pole,  $M$  and  $P$  are colinear; the south pole,  $P$  and  $M'$  are colinear too, so we have the existence of scalars  $\lambda$  and  $\mu$  in  $\mathbb{R}$  such that

$$(p - x, z + 1) = \lambda(p, z - 1) \quad (1.1)$$

$$(p - \xi, z - 1) = \mu(p, z + 1). \quad (1.2)$$

Furthermore, the point  $P$  lies on the Sphere  $\mathcal{S}$ , so

$$p^2 + z^2 = 1. \quad (1.3)$$

Let us define the Bendixson transformation as

$$\begin{aligned} \mathcal{B} : X \setminus \{0\} &\longrightarrow X \\ x &\longmapsto \xi. \end{aligned}$$

After simple computations involving the formulas 1.1, 1.2 and 1.3, one gets the following for all  $x \in X$ ,  $x \neq 0$ ,

$$\mathcal{B}(x) = \xi = \frac{4}{\langle x, x \rangle} x, \quad (1.4)$$

and for all  $\xi \in X$ ,  $\xi \neq 0$ ,

$$\mathcal{B}^{-1}(\xi) = x = \frac{4}{\langle \xi, \xi \rangle} \xi. \quad (1.5)$$

Here  $\|x\|$  going to infinity is equivalent to  $\|\xi\|$  going to 0. The coordinates  $x$  and  $\xi$  give two charts constituting an atlas for the unit sphere  $\mathcal{S}$  of  $X \times \mathbb{R}$ . Unless otherwise expressly specified the coordinates  $\xi$  will be used for the upper chart and the coordinates  $x$  for the lower. This enables us to omit the vertical coordinates  $-1$  for the lower chart and  $+1$  for the upper chart. Note that the transformation  $\mathcal{B}$  is nothing more than the reflexion on the unit circle which is an involution. We will not need the formula giving  $(p, z) \in \mathcal{S}$  as a function of  $x$  (or  $\xi$ ), so we skip its derivation here.

Now consider a dynamical system

$$x_t = f(x) \quad (1.6)$$

on the space  $X$ . Derivating the relation 1.4 with respect to time, we get formally for  $\xi \neq 0$  the differential equation

$$\xi_t = \frac{1}{4} \langle \xi, \xi \rangle f\left(\frac{4\xi}{\langle \xi, \xi \rangle}\right) - \frac{1}{2} \left\langle \xi, f\left(\frac{4\xi}{\langle \xi, \xi \rangle}\right) \right\rangle \xi. \quad (1.7)$$

We call this equation the Bendixson-transformed vector field. This expression has not necessarily a limit as  $\xi$  goes to 0, as we will see in the next section. But first let us look at an easy example where this causes no trouble.

**Example 1.1.1.** Let us consider the equation  $x_t = x^2$  on  $\mathbb{R}$ . Through the above formula 1.7, we get

$$\xi_t = -4,$$

for  $\xi \neq 0$ . Obviously this vector field has a limit as  $\xi$  goes to zero, which is  $-4$ . The flow on the Bendixson sphere - here just a circle, on the lower and on the upper chart are depicted in figure 1.2.

The point at infinity alias  $\xi = 0$  is isolated invariant in the sense of definition 3.1.3. Therefore its Conley index  $h(\infty)$  is well defined and it satisfies  $h(\infty) := h(\xi = 0) = \bar{0}$  (for the precise definition, see 3.1.1). Such an index, which is neither the index of an attractor nor the index of a repeller, proves the existence of an orbit tending to the point at infinity in forward and in backward time direction, which is not really surprising for this example.

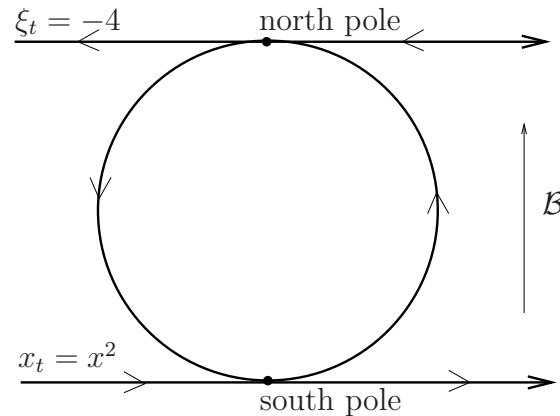

Figure 1.2: The Bendixson transformation applied to  $x_t = x^2$ .

## 1.2 Normalization

To apply the Conley index methods to the dynamic projected on the Bendixson sphere, we need that there is a nice flow or at least semi-flow on the whole sphere. The construction we presented is only a geometric one and, if it does project the trajectories of the original system on paths on the Bendixson sphere, it does not guarantee for the flow properties. The following problems arises.

As we mentioned previously, the right hand side of formula 1.7 describing the Bendixson-transformed vector field may have no limit as  $\xi$  goes to zero. If we consider the dynamics projected on the sphere or on the upper chart  $X \times \{+1\}$ , this means a discontinuity of the projected vector field at the north pole alias the origin of  $X \times \{+1\}$ . To avoid this, one may multiply the projected vector field with a strictly positive function tending to zero at the north pole. This would not change the direction field, hence the trajectories are preserved while continuity is provided. The north pole is then an equilibrium.

We can still encounter another annoying situation: In the case of a blow up in the original system, we have trajectories going to infinity in finite time. This will result after projection to trajectories reaching the north pole in finite time. In this case, the north pole cannot be an equilibrium without violating the flow properties. The velocity should slow down enough, so that trajectories do not crash into the north pole in finite time.

The aim of this section is to explain how to "slow down" the trajectories in order to get a flow on the hyperplane  $X \times \{+1\}$ , the upper chart of the Bendixson sphere. This procedure is called normalization; for the definition we follow [23]. After having defined the normalization in the upper chart, we will discuss how this provides naturally a nice flow on the Bendixson sphere itself.

Let us first work in the upper chart with coordinates  $\xi \in X$  obtained by stereographic projection with respect to the south pole of  $\mathcal{S} \setminus \{\text{south pole}\}$  as described

above.

**Definition 1.2.1. Normalizable vector field.**

Let  $f$  be a continuous vector field on  $X$ , and  $g : X \setminus \{0\} \rightarrow X$  be defined by the formula 1.7, i. e.

$$g(\xi) = \frac{1}{4} \langle \xi, \xi \rangle f\left(\frac{4\xi}{\langle \xi, \xi \rangle}\right) - \frac{1}{2} \left\langle \xi, f\left(\frac{4\xi}{\langle \xi, \xi \rangle}\right) \right\rangle \xi.$$

The vector field  $f$  is called normalizable if there is a continuous function  $\varrho : X \rightarrow \mathbb{R}$  such that

- (i)  $g$  and  $\varrho g$  define the same direction field on  $X \setminus \{0\}$ ,
- (ii)  $\lim_{\xi \rightarrow 0} \varrho(\xi)g(\xi)$  exists and is finite.

**Remark.** The vector fields  $g$  and  $\varrho g$  define the same direction field if and only if  $\varrho$  is positive and zero only where  $g$  is zero.

**Remark.** Not all vector fields are normalizable. However the class of normalizable vector fields on  $\mathbb{R}^n$  is wide enough to contain all polynomial vector fields, as we will see in a moment. That is the reason why a lot of our examples are chosen among them.

Each choice of a  $\varrho$  as in the definition 1.2.1 provides a "normalization around infinity" of the vector field  $f$ , such that the vector field  $\xi_t = \varrho(\xi)g(\xi)$  is defined and continuous on whole  $X$ , as we formulate in definition 1.2.2. This function  $\varrho$  also states how to slow down the projected vector field on the sphere around the north pole as we will see in 1.2.7.

**Definition 1.2.2. Normalization of  $f$  around  $\infty$ .**

Let  $f$  be a vector field on  $X$  and  $g : X \rightarrow X$  its Bendixson transform defined by the formula 1.7.

The vector field  $F : X \rightarrow X$  is called a normalization of  $f$  around infinity if  $F$  and  $g$  are related by a function  $\varrho : X \rightarrow \mathbb{R}$  as in definition 1.2.1, i.e.

there exists a function  $\varrho$  such that  $F = \varrho g$ , the function  $\varrho$  being continuous, positive, zero only where  $g$  is zero, and  $F(\xi)$  having a limit as  $\xi$  goes to zero.

**Remark 1.2.3. Normalization and rescaling of the time variable**

The following computation shows us that normalizing with  $\varrho$  is exactly the same as doing the change of time variable  $dt = \varrho(\xi)d\tau$ :

$$\begin{aligned} \xi_\tau &= \frac{d}{d\tau} \xi \\ &= \frac{dt}{d\tau} \frac{d}{dt} \xi \\ &= \varrho(\xi)g(\xi) \end{aligned}$$

However, we will keep the name  $t$  for the time variable for simplicity.

**Remark 1.2.4.** After normalization, there is no blow up any more: all trajectories are full and trajectories tending to the point at infinity reach it in infinite time in case it is an equilibrium. As a topological tool, the Conley index does not depend on the normalization but only on the direction field: independence of the Conley index on the choice of the normalization holds because the changes of variables for different  $\varrho$ 's produce topologically equivalent flows. Hence the indices of the isolated invariant sets under the one or the other flow coincide through proposition ??.

**Example 1.2.5. Normalization for polynomial vector fields**

Let us have a closer look at the normalization of polynomial vector fields on  $\mathbb{R}^n$ . We consider the vector field of degree  $d$

$$x_t = Q(x).$$

We split the vector field  $Q$  into two parts  $Q = P + p$ ,  $P$  collecting the terms of degree exactly  $d$ , and  $p$  all the terms of lower order. In multi-index notation, for all  $i = 1, \dots, n$ , we have the  $i$ -th component of  $Q$ :

$$\begin{aligned} Q_i(x) &= P_i(x) + p_i(x) \\ P_i(x) &= \sum_{|\alpha|=d} a_i^\alpha x^\alpha \\ p_i(x) &= \sum_{|\alpha|\leq d-1} a_i^\alpha x^\alpha, \end{aligned}$$

where the multi-index  $\alpha$  lies in  $\mathbb{N}^n$ , and the coefficients  $a_i^\alpha$  in  $\mathbb{R}$ . Now we apply the formula 1.7 and get the Bendixson-transformed vector field for  $\xi \neq 0$ ,

$$\begin{aligned} \xi_t &= \frac{1}{4} \langle \xi, \xi \rangle Q\left(\frac{4\xi}{\langle \xi, \xi \rangle}\right) - \frac{1}{2} \left\langle \xi, Q\left(\frac{4\xi}{\langle \xi, \xi \rangle}\right) \right\rangle \xi \\ &= \langle \xi, \xi \rangle^{-d} \left( 4^{d-1} \langle \xi, \xi \rangle P(\xi) - \frac{4^d}{2} \langle \xi, P(\xi) \rangle \xi \right) \\ &\quad + \frac{1}{4} \langle \xi, \xi \rangle p\left(\frac{4\xi}{\langle \xi, \xi \rangle}\right) - \frac{1}{2} \left\langle \xi, p\left(\frac{4\xi}{\langle \xi, \xi \rangle}\right) \right\rangle \xi. \end{aligned}$$

The Bendixson-transformed vector field may not have a limit as  $\xi$  goes to zero because of the negative powers of  $\langle \xi, \xi \rangle$  going to infinity as  $\xi$  is going to zero. A normalization is possible. One may choose how strong the trajectories have to slow down according to what one want to do with the normalized vector field:

- **Continuity:** In the definition of normalization, one does only require continuity of the vector field at the point at infinity. Taking  $\varrho(\xi) = \|\xi\|^{d-1}$  will suffice to make the the normalized vector field continuous at  $\xi = 0$



- **Continuous differentiability:** One may require local Lipschitz continuity of the vector field in order to get a flow on the upper chart, hence on the whole Bendixson sphere. For that, one can normalize in such a way that the vector field is continuously differentiable by taking  $\varrho(\xi) = \|\xi\|^d$ . The drawback of this normalization is the following: If you are interested in the behaviour around the point at infinity, you may look for the derivative with the lowest order which are non zero. With this economical normalization, the normalized vector field is very likely to admit just derivatives of first order, and they are likely to be zero. That is the reason why the third possibility is the one mostly given in the literature.
- **Smoothness:** to avoid the problems explained in the previous point, one can normalize with  $\varrho(\xi) = \langle \xi, \xi \rangle^d$ . This seems a quite brutal way to slow down the trajectories around infinity, but this provide a polynomial vector field again, hence smooth, so that one is able to compute as much derivatives as one needs. However, one has to expect a very degenerate behaviour at  $\xi = 0$ , meaning the first non zero derivative being of very high order. This makes it difficult to determine the local behaviour at  $\xi = 0$ . We want here to draw the readers attention to the paper [4] by Brunella and Miari. Their results allow in the planar polynomial case to reduce the study of the dynamic around the point at infinity, alias the origin  $\xi = 0$ , to a polynomial vector field called the principal part which shows less terms. This is defined through Newton polyhedra. However the study of this "simplified" vector field remains difficult. Schemes to analyse degenerate critical points are given in [30], section 2.11, [1], chapter VIII and IX, but they are not always powerfull enough for the type of degeneracy appearing at the point at infinity. This drawback makes the Bendixson compactification quite unpopular.
- Of course the normalization may be reached with a smaller power of  $\|\xi\|$  in case one is able to factorize the Bendixson-transformed vector field with a power of  $\langle \xi, \xi \rangle$  such that simplifications take place.

Hence we have the following proposition:

**Proposition 1.2.6.** *Polynomial vector fields on  $\mathbb{R}^n$  are normalizable. For a vector field of degree  $d$ , there exists an integer  $m \in \{0, \dots, 2d\}$  such that  $\varrho(\xi) = \|\xi\|^m$  provides a normalization.*

**Remark 1.2.7. Normalization of  $f$  on the Bendixson sphere.**

Our argument to analyze the dynamic will be based on the flow on the Bendixson sphere. Until now, we just have flows on two charts: The dynamics around infinity i.e., say, on the upper hemisphere, is described on the upper chart by a at least Lipschitz continuously normalized vector field  $\xi_t = \varrho(\xi)g(\xi)$ , while the dynamics on, say, the lower hemisphere, is described by the original system on the lower

chart. The aim of the following construction is to patch them smoothly, so that we get a vector field on the sphere  $\mathcal{S}$  which induces a nice flow or semi-flow. Once we will be convinced that it is possible, we will forget about this construction and speak about the compactified flow on the Bendixson sphere.

We consider a point  $P = (p, z)$  different from the north pole  $n$  on the unit sphere:  $P \in \mathcal{S} \setminus \{n\}$ ,  $\langle p, p \rangle + z^2 = 1$ ,  $z \neq 0$ . Choose a smooth and strictly increasing function

$$l : [-1, 1] \longrightarrow \mathbb{R}$$

$$z \longmapsto \begin{cases} 1 & \text{for } z \leq 1/3 \\ 0 & \text{for } z \geq 2/3. \end{cases}$$

Let us call  $P_l$  (resp.  $P_u$ ) the stereographic projection from  $X \times \{-1\}$  (resp.  $X \times \{+1\}$ ) to the sphere. If  $P_l^{-1}(P) = (x, -1)$  and  $P_u^{-1}(P) = (\xi, +1)$ , we have per construction equality of the projections of the vector fields  $f$  and  $g$  on the sphere, where both are defined

$$DP_u(\xi, +1)[g(\xi)] = DP_l(x, -1)[f(x)], \text{ for } \xi \neq 0$$

and we define on  $\mathcal{S} \setminus \{n\}$  the following vector field:

$$\Phi(P) = l(z)DP_l(x, -1)[f(x)] + (1 - l(z))\varrho(\xi)DP_u(\xi, +1)[g(\xi)].$$

The function  $\varrho$  has been designed for  $\Phi$  to be at least Lipschitz continuous as  $P$  is going to the north pole.

**Remark 1.2.8.** The compactification removes blow-up phenomena so that every trajectory is well-defined up to  $t \rightarrow \infty$ . However it does not help against multiplicity of prehistories if the original vector field only produces a semi flow.

## 1.3 Some examples

### Example 1.3.1. A linear saddle point

Let us consider the elementary example of a linear saddle point in  $\mathbb{R}^2$ :

$$\begin{cases} x_t = ax \\ y_t = by, \end{cases} \quad (1.8)$$

where  $a > 0$  and  $b < 0$ . The Bendixson compactification around the point at infinity is described in figure 1.3. Because of the four elliptic sectors, there are homoclinic trajectories in every neighborhood of the point at infinity  $\xi = 0$ , so that it is not isolated invariant in the sense of Conley index theory (see definition 3.1.3). This situation motivates the development of a new concept of invariant set with isolated invariant complement as introduced in section 3.5.1 Now for a

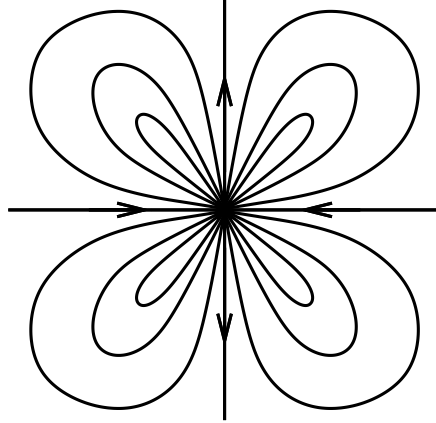

Figure 1.3: The point at infinity for a linear saddle.

linear saddle point in  $\mathbb{R}^n$ , consider the system

$$(x_i)_t = \mu_i x_i, i \in \{1, \dots, n\} \quad (1.9)$$

with, say,  $\mu_1 \geq \dots \geq \mu_m > 0 > \mu_{m+1} \geq \dots \geq \mu_n$ . In other words, the origin admits  $m$  unstable dimensions. The normalized equation around the point at infinity  $\xi = 0$  reads

$$(\xi_i)_t = \left( \sum_{k=1}^n (\mu_i - 2\mu_k) \xi_k^2 \right) \xi_i. \quad (1.10)$$

The first nonzero derivative is of third order. The separatrices are the  $\xi$ -axes  $\{\xi_k = 0, k \neq i\}$  which are invariant and driven by the equation

$$(\xi)_t = -\mu_i \xi_i^3.$$

Hence the  $\xi$ -axis is stable for  $i \in \{1, \dots, m\}$  and unstable for  $i \in \{m+1, \dots, n\}$ . The trajectories which do not lie on the separatrices are homoclinic to the point at infinity and approach it along separatrices.

### Example 1.3.2. A quadratic vector field

Now let us consider the following quadratic vector field.

$$\begin{cases} x_t = 2xy \\ y_t = 1 + y - x^2 + y^2 \end{cases} \quad (1.11)$$

This vector field admits two finite equilibria  $(\pm 1, 0)$ . The eigenvalues of the linearisations at those equilibria are  $\frac{1 \pm i\sqrt{7}}{2}$ . So those equilibria are unstable and trajectories are spiraling away from them. The  $y$ -axis is invariant. There are no

periodic trajectories. The Bendixson–transformed vector field, written in coordinates  $(\xi, \eta)$ , normalized with  $\varrho(\xi, \eta) = (\xi^2 + \eta^2)^2$ , reads

$$\begin{pmatrix} \xi_t \\ \eta_t \end{pmatrix} = -4(\xi^4 - \eta^4 + 2\xi^2\eta^2) \begin{pmatrix} 0 \\ 1 \end{pmatrix} + \begin{pmatrix} -2\eta^2\xi(\xi^2 + \eta^2) - \frac{1}{2}\xi\eta(\xi^2 + \eta^2)^2 \\ \eta(\xi^2 + \eta^2)^2 - 2\eta^3(\xi^2 + \eta^2) + \frac{1}{4}(\xi^2 + \eta^2)^3 - \frac{1}{2}\eta^2(\xi^2 + \eta^2)^2 \end{pmatrix}.$$

The first summand contains the leading order terms and shows a flow box in direction  $\begin{pmatrix} 0 \\ 1 \end{pmatrix}$  at the origin alias the point at infinity, corresponding to the invariant  $y$ -axis. The second summand contains only higher order terms. With this information we are able to draw the phase portrait on the Bendixson sphere. This is depicted in figure 1.4: the lower rectangle is the lower chart showing the phase portrait of the original system. The upper rectangle shows the dynamic at infinity in the upper chart determined by the Bendixson transformed vector field. This example shows that the Bendixson compactification allows in some cases to get a complete description of the dynamic including the dynamic at infinity.

## 1.4 Some bad news

As seen already in the linear example 1.3.1, the point at infinity  $\xi = 0$  may happen to be very degenerate, the derivatives of the normalized vector field being zero until a high order. This fact makes it quite fastidious to describe the local behaviour around this point. Of course the Conley index methods we propose to use do not require complete knowledge of the local behaviour, but you still need some information. Moreover we saw also in example 1.3.1 that the point at infinity may not be isolated invariant. At first glance the Bendixson compactification seems not to be the best way to investigate the dynamic at infinity and its relations with the finite dynamic. In fact many authors such as [30, 1] advise against using the Bendixson compactification, and propose to use the Poincaré compactification instead. We present this technique in the next chapter. This alternative though will not solve all problems of degeneracy or lack of isolation. This is the reason why we introduce in chapter 3 the concept of invariant set with isolated invariant complement which will help in some cases.

A point which could be more fatal is the following: Applying the Conley index methods to detect heteroclinic orbits requires a so called Morse decomposition. This concept implies that you can partially order the isolated invariant sets - for instance with the help of an energy functional decreasing along trajectories. Even if you dispose of such a structure in the the original vector field, the Bendixson compactification may destroy it mercilessly. Trying to introduce the point at infinity in the partial order may generate a contradiction to the order properties. Again look at the example 1.3.1: the quantity  $E(x, y) = \frac{1}{2}(ax^2 + by^2)$  is strictly

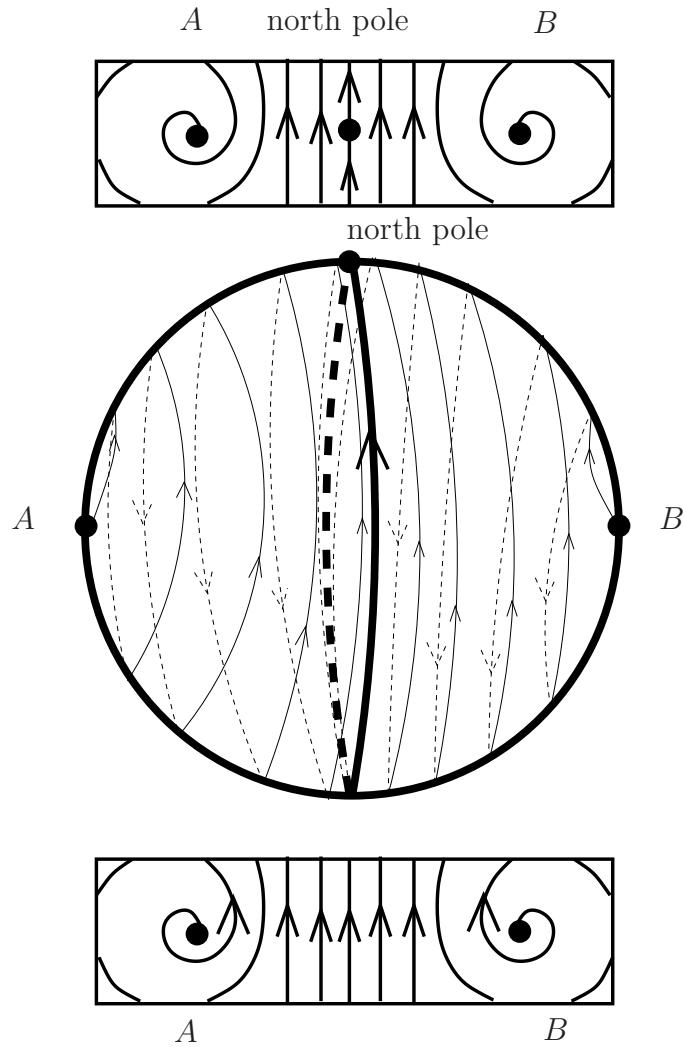

Figure 1.4: Bendixson compactification of 1.11.

decreasing along trajectories, except of course along the stationary trajectory at the origin. Nevertheless we have no Morse decomposition on the Bendixson sphere: the trajectory along the big circle image of the  $x$ -axis tells us the energy of the south pole should be bigger than the energy of the north pole, while the trajectory along the big circle image of the  $y$ -axis tells us the contrary. The lack of Morse structure makes the Conley index methods much less powerful: the whole machinery for predicting heteroclinic orbits is out of order. As we will see later, the Poincaré compactification will solve this problem.

At the end of the next chapter we should discuss why, in spite of all this reasons, we insist on not neglecting the Bendixson compactification.



# Chapter 2

## The Poincaré compactification

In this chapter we describe a construction introduced by Poincaré in [31]. The phase space  $X$  gets compactified in such a way that infinity is mapped on a whole sphere, the unit sphere of  $X$ . Most of the authors interested in dynamics at infinity such as in [1, 30, 33, 23, 36] use rather this construction than the Bendixson compactification. We will compare both compactifications at the end of this chapter.

### 2.1 Description of the transformation

We consider again a Hilbert space  $X$  with its scalar product  $\langle \cdot, \cdot \rangle$ . As for the Bendixson compactification, we also add a vertical direction and proceed in  $X \times \mathbb{R}$  to the following geometric construction. The original vector space  $X$  is identified with the hyperplane  $X \times \{+1\}$  tangent to the unit sphere at its north pole. This time, we project the hyperplane  $X \times \{+1\}$  centrally onto the upper hemisphere  $\mathcal{H} = \{(x, z) \in X \times \mathbb{R} / \langle x, x \rangle + z^2 = 1, z > 0\}$ . More precisely: given a point  $M$  on the hyperplane  $X \times \{+1\}$ , the straight line through  $M$  and the center of the unit sphere  $(0, 0)$  intersects the unit sphere in two antipodal points, one on the upper hemisphere and one on the lower. We define the projection  $\mathcal{P}(M)$  as the intersection point on the upper hemisphere, i. e. the one with positive last coordinate  $z > 0$ . This construction is illustrated on figure 2.1. As the point  $M$  goes to infinity, its image under the Poincaré transformation goes to the equator of the upper hemisphere  $\mathcal{E} := \{(x, 0) \in X \times \mathbb{R} / \langle x, x \rangle = 1\}$ , also called the sphere at infinity. This allows to distinguish between directions at infinity and makes this compactification more precise in its description of the dynamic of arbitrarily far points.

Using the fact that the center of the unit sphere  $(0, 0)$ , the point  $M \in X \times \{1\}$  and its image under the transformation  $\mathcal{P}(M) \in \mathcal{H}$  are colinear, the coordinates

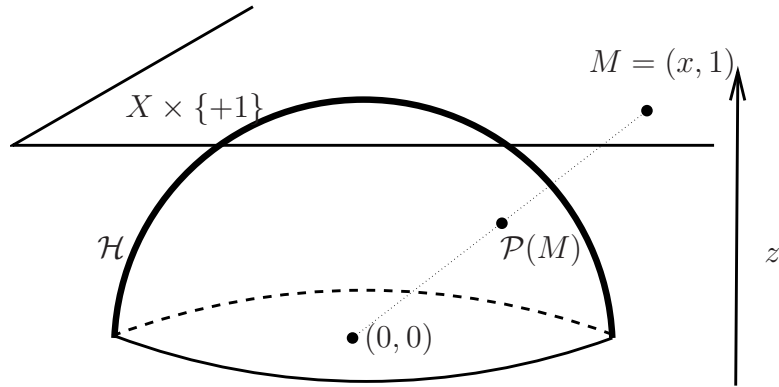

Figure 2.1: The Poincaré compactification.

$(\chi, z)$  of  $\mathcal{P}(M)$  can be computed:

$$\chi = \frac{x}{(1 + \langle x, x \rangle)^{\frac{1}{2}}} \quad (2.1)$$

$$z = \frac{1}{(1 + \langle x, x \rangle)^{\frac{1}{2}}} \quad (2.2)$$

Here again it is more comfortable to study invariant sets in a plane than on a sphere. This is the reason why we will project again on several tangent vertical hyperplanes of  $X \times \mathbb{R}$  and look there, for example, at the linearization at equilibria. The figure 2.2 describes the construction. More precisely, we fix a vector

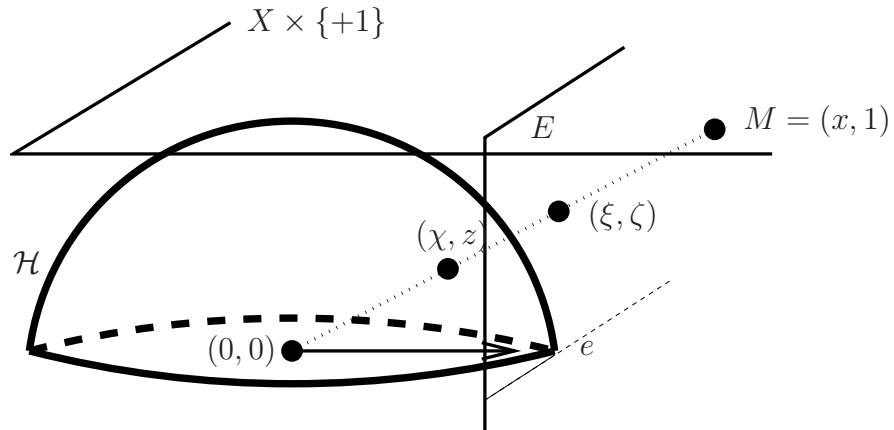

Figure 2.2: A chart of the sphere at infinity and surroundings.

$e$  in the unit sphere of  $X$ , such that  $(e, 0)$  lies on the equator of the unit sphere of  $X \times \mathbb{R}$ . Now we project gnomonically a point  $(\chi, z) = \mathcal{P}((x, 1))$  of the upper hemisphere  $\mathcal{H}$  on the vertical hyperplane  $E$  tangent to the equator at the point



$(e, 0)$ . Of course this works only if the straight line through the points  $(x, 1)$ ,  $(\chi, z)$  and the origin  $(0, 0)$  has an intersection with the vertical hyperplane  $E$  orthogonal to  $(e, 0)$ , i. e. if  $\langle \chi, e \rangle$  or equivalently  $\langle x, e \rangle$  is nonzero. Then using the colinearity of the origin,  $(\chi, z)$ ,  $(x, 1)$  and  $M' = (\xi, \zeta)$ , we compute for the projected point  $M' = (\xi, \zeta) \in E$  the following formulas:

$$(\xi, \zeta) = \frac{1}{\langle x, e \rangle} (x, 1) \quad (2.3)$$

$$= \frac{1}{\langle \chi, e \rangle} (\chi, z) \quad (2.4)$$

Now let us recall that our original vector space  $X$  is a Hilbert space. This means in particular that we dispose of a countable orthonormal basis of  $X$  in which the coordinates  $(x_n)_{n \in \mathbb{N}}$  of any vector  $x \in X$  are defined. Typically, we will choose for the vector  $e$  the basis vectors and their opposite, such that we can get equations on the coordinates. If  $e_i$  is the  $i$ -th basis vector or its opposite  $-e_i$  respectively, we project onto the affine hyperplanes  $\{\xi_i = \pm 1\}$  of  $X \times \mathbb{R}$  and the formula 2.3 translates to

$$\xi_n = \pm \frac{x_n}{x_i} \text{ for all } n \in \mathbb{N} \quad (2.5)$$

$$\zeta = \pm \frac{1}{x_i}, \quad (2.6)$$

which holds for all  $x \in X$  whose  $i$ -th coordinate is nonzero. The collection of these projections on the hyperplanes  $(\{\xi_i = \pm 1\})_{i \in \mathbb{N}}$  builds an atlas of  $\mathcal{H} \setminus \{(0, 1)\}$ . More precisely, each chart given by the formulas 2.5 and 2.6 is a bijection between  $\{(\chi, z) \in \mathcal{H} / \langle \chi, e_i \rangle > 0\}$  and the half-plane  $\{\xi_i = 1 \text{ and } z > 0\}$ , or between  $\{(\chi, z) \in \mathcal{H} / \langle \chi, e_i \rangle < 0\}$  and  $\{\xi_i = -1 \text{ and } z > 0\}$  respectively.

After having seen what the Poincaré compactification does geometrically, let us describe how the differential equations are transformed. As above, we consider a vector field  $x_t = f(x)$  on the Hilbert space  $X$ . Derivating the equation 2.1 with respect to time, we get for  $z \neq 0$  and  $f_z := zf(z^{-1})$  the following equation:

$$\begin{cases} \chi_t = \langle \chi, f_z(\chi) \rangle \chi f_z(\chi) - \langle \chi, f_z(\chi) \rangle \chi \\ z_t = -\langle f_z(\chi), \chi \rangle z \end{cases} \quad (2.7)$$

Derivating the equation 2.3 with respect to time, we get for  $\zeta \neq 0$  the following equation:

$$\begin{cases} \xi_t = -\langle f_\zeta(\xi), e \rangle \xi + f_\zeta(\xi) \\ \zeta_t = -\langle f_\zeta(\xi), e \rangle \zeta \end{cases} \quad (2.8)$$

As in the case of the Bendixson compactification, these expressions need not to have a limit as  $\zeta$  goes to zero, i.e. as we approach the sphere at infinity. But let us have a closer look at the function  $f_z$ : it is the function whose graph is homothetic with factor  $z$  to the graph of the function  $f$ . As we approach the

sphere at infinity,  $z$  (or  $\zeta$  respectively) is going to 0. The existence of a limit of  $f_z$  as  $z$  goes to zero (or  $f_\zeta$  respectively) will decide on the existence of the limit of the Poincaré transformed vector field as we approach the sphere at infinity. We do not want to go into details here because cases where those limits do exist are rather exceptions, but we will discuss more carefully in the section 2.2 a similar question for a normalized version of homotheties of  $f$ .

To be complete we give the equations in coordinates, i.e. we choose for  $e$  the basis vectors and their opposites  $\pm e_i$  and get for a fixed  $i$ :

$$\begin{cases} (\xi_n)_t &= \mp f_\zeta^i(\xi)\xi_n + f_\zeta^n(\xi) \text{ for all } n \in \mathbb{N} \\ \zeta_t &= \mp f_\zeta^i(\xi)\zeta, \end{cases} \quad (2.9)$$

where  $(\xi_n)_{n \in \mathbb{N}}$  are the coordinates of  $\xi$  in the basis  $(e_n)_{n \in \mathbb{N}}$  and  $f_\zeta^n(\xi) := \langle f_\zeta(\xi), e_n \rangle$  is the  $n$ -th component of  $f_\zeta(\xi)$  also with respect to the basis  $(e_n)_{n \in \mathbb{N}}$ .

**Example 2.1.1.** As a direct application of those computations, let us consider a simple example where the problem of the lack of limit of the homothety  $f_\zeta$  as  $\zeta$  goes to zero does not come up. As in the previous chapter, we now compactify a linear system in the plane where the origin is a saddle point (see example 1.3.1). The planar linear system 1.8 studied in the previous chapter gives rise to the following equations in the four charts  $\{\xi_i = \pm 1, \zeta > 0\}$ :

$$\begin{cases} (\xi_2)_t = (b - a)\xi_2 \\ \zeta_t = -a\zeta, \end{cases} \quad \begin{cases} (\xi_1)_t = (a - b)\xi_1 \\ \zeta_t = -b\zeta, \end{cases}$$

The first system describes the dynamic in the charts  $\{\xi_1 = 1, \zeta > 0\}$  and  $\{\xi_1 = -1, \zeta > 0\}$ : the origin is the only equilibrium and it is stable. The second system describes the dynamics in the charts  $\{\xi_2 = 1, \zeta > 0\}$  and  $\{\xi_2 = -1, \zeta > 0\}$ : the origin is the only equilibrium and it is unstable. The figure 2.3 shows the Poincaré hemisphere viewed from above, the equator being the boundary of the disk. All equilibria, finite and at infinity are isolated invariant in the sense of Conley index theory (see chapter 3 for details). This example shows that the Poincaré compactification better fits, at least in the linear context, than the Bendixson compactification.

## 2.2 Normalization and time rescaling

In this section we are concerned with the fact that the "compactified" evolution equations 2.7 for  $\xi$  and  $z$  on the hemisphere  $\mathcal{H}$  or equivalently their projected versions 2.8 may not admit a limit as  $z$  or  $\zeta$  is going to zero, approaching the sphere at infinity. As for the Bendixson compactification, we may multiply with a positive function which does not change the direction field, hence preserves the trajectories, but provides a limit as  $z$  goes to zero. Obviously, the only term

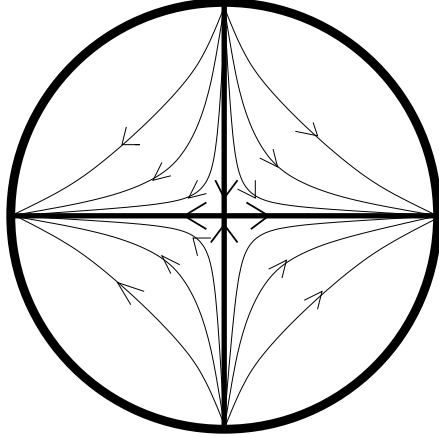

Figure 2.3: A saddle under the Poincaré transformation.

we have to care about is the limit of the homothety of the vector field  $f_z$  as  $z$  goes to zero. This observation leads us to the following definition:

**Definition 2.2.1. Normalization of the homothety  $f_z$**

The vector field  $f : X \rightarrow X$  is normalizable if and only if there exists a continuous function  $\varrho : [0, +\infty[ \rightarrow [0, +\infty[$  such that

1.  $\varrho(z) \neq 0$  if  $z \neq 0$ , and
2. the map  $(\chi, z) \mapsto \varrho(z)f_z(\chi)$  is Lipschitz continuous even in  $z = 0$ .

**Remark 2.2.2. Normalization and change of time variable**

If  $\varrho$  normalizes the homothety of  $f$ , the normalization of equation 2.7 and 2.8 are provided by the change of time variable  $dt = \varrho(z)d\tau$ :

$$\begin{aligned} \chi_\tau &= \frac{dt}{d\tau} \chi_t \\ &= \langle \chi, \varrho(z)f_z(\chi) \rangle \chi - \varrho(z)f_z(\chi) \\ z_\tau &= -\langle \varrho(z)f_z(\chi), \chi \rangle z \end{aligned}$$

$$\begin{aligned} \xi_\tau &= \frac{dt}{d\tau} \xi_t \\ &= -\langle \varrho(\zeta)f_\zeta(\xi), e \rangle \xi + \varrho(\zeta)f_\zeta(\xi) \\ \zeta_\tau &= -\langle \varrho(\zeta)f_\zeta(\xi), e \rangle \zeta \end{aligned}$$

Nevertheless we will keep the name  $t$  for the time variable of the normalized equations on the Poincaré hemisphere for the sake of simplicity.

**Example 2.2.3. Normalization for polynomial vector fields**

We consider again a polynomial vector field  $f$  of degree  $d$  in  $\mathbb{R}^n$ . We decompose  $f$  into two parts:  $f = P + p$ ,  $P$  being polynomial and homogenous of degree  $d$ , containing all the highest order terms; the polynomial  $p$  contains the lower order terms of degree less than  $d - 1$ . It holds

$$\begin{aligned} f_z(\chi) &= z^{1-d}P(\chi) + zp(z^{-1}\chi) \\ z^{d-1}f_z(\chi) &= P(\chi) + z^d p(z^{-1}\chi). \end{aligned}$$

As the polynomial  $p$  is of degree less than  $d - 1$ , the second terms disappears as  $z$  is going to zero. So it holds for  $\varrho(z) := z^{d-1}$

$$\lim_{z \rightarrow 0} \varrho(z)f_z = P.$$

It means in particular that the dynamic inside the sphere at infinity is governed by the highest order terms, which is not surprising. The dynamic on the sphere at infinity is governed by

$$\chi_t = P(\chi) - \langle P(\chi), \chi \rangle \chi. \quad (2.10)$$

**Remark 2.2.4.** The previous example teaches us also how to normalize an equation with nonlinearity of polynomial growth. Consider a map  $f : X \rightarrow X$  admitting a decomposition of the following type:

$$f = P + p,$$

where  $P$  is homogenous of degree  $d$ , i. e.

$$\forall x \in X, \forall \lambda \in \mathbb{R}, P(\lambda x) = \lambda^d P(x),$$

and  $p$  contains terms of order lower than  $d - 1$ , but not necessary polynomial, i. e.

$$\begin{aligned} p(x) &= o(\|x\|^{d-1}) \\ &= \varepsilon(x)\|x\|^{d-1}, \end{aligned}$$

where  $\varepsilon$  is a bounded function tending to zero as  $\|x\|$  tends to infinity. Again the normalization by  $\rho(z) = z^{d-1}$  provides

$$\lim_{z \rightarrow 0} f_z = P.$$

**Remark 2.2.5. Global flow or semi flow on the Poincaré hemisphere**

Let us discuss now the question if the normalized vector field leads to a global flow or semi flow on the Poincaré hemisphere. As we have seen the role of the compactification is to suppress blow up phenomena both in forward and backward

time. Hence the normalized vector field produces for sure only full trajectories. We do not have only a local semi flow, but a global one. This leads us to comment on the "no blow up condition" imposed by Rybakowski in [34]: We consider a continuous vector field on  $X$ , generating a local semi flow  $\phi$  on the original phase space  $X$ . Let  $N$  be a subset of  $X$ . The local semi flow  $\phi$  does not explode in  $N$  if for all  $x \in X$  with maximal existence time  $T$  the inclusion  $\phi([0, T[, x) \subset N$  implies infinite existence time  $T = \infty$ . After normalization we can guarantee that for all  $x \in \mathcal{H}$  the maximal existence time  $T$  is infinite. As a consequence every set  $N \subset \mathcal{H}$  satisfies the no blow up condition with respect to the normalized equation on the Poincaré hemisphere, even if  $N$  intersects the sphere at infinity. In backward time direction, we can state the following: if a prehistory exists, it is full - we cannot guarantee its uniqueness though. The original vector field is responsible for it. For a trajectory with initial condition in the interior of the Poincaré sphere, the uniqueness of its prehistory depends on the original vector field. If this vector field generates a local flow, we obtain a unique full trajectory on the Poincaré hemisphere. If the original vector field is not regular enough and only generates a local semi flow, we obtain at least a full trajectory on the Poincaré hemisphere but may have multiple prehistories. This is no obstacle to our considerations on Conley index theory though.

Finally we consider an initial condition on the equator of the Poincaré hemisphere, alias the sphere at infinity. According to our definition of the normalization, the map

$$\begin{aligned} g: \mathcal{E} &\rightarrow T\mathcal{E} \\ \chi &\mapsto \lim_{z \rightarrow 0} \rho(z) f_z(\chi) \end{aligned}$$

is regular enough to provide a flow on the equator of the Poincaré hemisphere which is a closed manifold with boundary.

## 2.3 Some examples

### Example 2.3.1. A quadratic vector field under Poincaré compactification

We consider the following polynomial system in the plane:

$$\begin{cases} (x_1)_t &= x_1^2 + x_2^2 - 1 \\ (x_2)_t &= 5(x_1 x_2 - 1) \end{cases} \quad (2.11)$$

This system does not show any finite equilibria, hence also no finite periodic orbit. The dynamic at infinity is given in the vertical charts: In the half plane  $\{\xi_1 = 1, \zeta \geq 0\}$  the normalized dynamic is governed by

$$\begin{cases} (\xi_2)_t &= \xi_2(\xi_2 - 2)(\xi_2 + 2) \\ \zeta_t &= -(1 + \xi_2^2)\zeta. \end{cases} \quad (2.12)$$

This system admits three equilibria  $(0,0)$  and  $(\pm 2,0)$ ; the derivatives at this equilibria are  $\begin{pmatrix} 4 & 0 \\ 0 & -1 \end{pmatrix}$  and  $\begin{pmatrix} -8 & 0 \\ 0 & -5 \end{pmatrix}$  respectively, showing that  $(0,0)$  is a stable node and  $(\pm 2,0)$  are saddle points.

In the half plane  $\{\xi_1 = -1, \zeta \geq 0\}$ , after a few changes of signs in the equations, we get a unstable node at the origin, while the fixpoint  $(\pm 2,0)$  are saddle points.

The two other charts  $\{\xi_2 = \pm 1, \zeta \geq 0\}$  do not reveal new fix points in the sphere at infinity, so we skip those.

The global phase portrait on the Poincaré hemisphere seen from above is shown in figure 2.3.1, using the Morse indices to decide which heteroclinics can exist, and the Poincaré–Bendixson theorem.

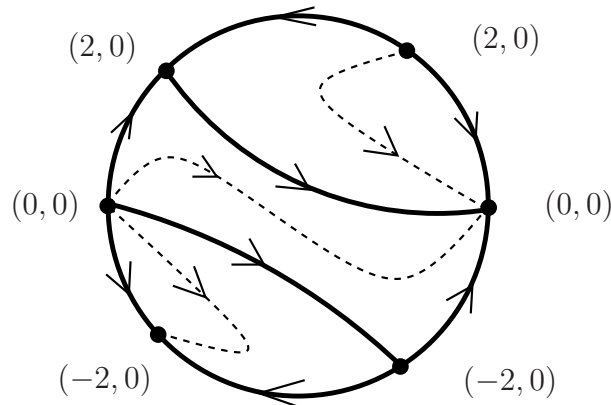

Figure 2.4: The Poincaré compactification of the vector field 2.12.

With the knowledge of this phase portrait under the Poincaré compactification, we can derive the configuration of the point at infinity under the Bendixson compactification: it would show four hyperbolic sectors, two elliptic sectors and two parabolic sectors. Therefore it would be either isolated invariant nor of isolated invariant complement so that its Conley index would not be defined. The Poincaré compactification allows to avoid this complexity and replace it with several hyperbolic fix points.

### Example. 1.3.2

To be complete we want to observe how the phase portrait of the example 1.3.2 looks like. We skip here the computations, for details see [1] P.443. The invariant  $y$ -axis in the original system gives rise to two fix points on the sphere at infinity. The figure 2.5 shows the global phase portrait on the Poincaré hemisphere.

For this example the Bendixson compactification seems to be more natural to describe the behaviour at infinity. The Poincaré compactification destroys somehow artificially the flow-box at infinity.

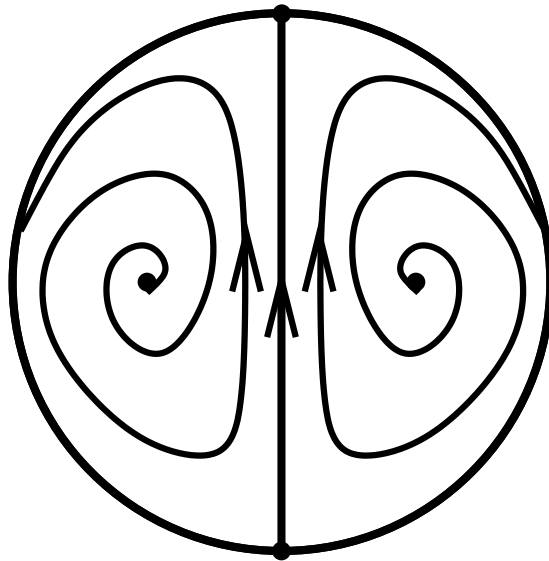

Figure 2.5: The Poincaré compactification for the example 1.3.2.

## 2.4 Poincaré versus Bendixson

Now let us briefly summarize the assets and drawbacks of the Poincaré compactification. Obviously the Poincaré compactification has the advantage that the dynamic at infinity is spread on the whole equator and therefore degenerate behaviours less accumulate than in the Bendixson compactification. Instead of looking at one very intricate fixpoint, one has in the Poincaré compactification several simpler fixpoints, or possibly other invariant sets in higher dimensions. At first sight it seems to be more work to find out what is the dynamic inside infinity, but in fact it is in most cases more doable than considering the one point compactification. This is also the whole philosophy of the so called blow-up techniques as introduced by [Dumortier] to unravel degenerate fixpoints.

Another asset of the Poincaré compactification is that it gives more detailed information: you do not only find out that some trajectory are heteroclinic to infinity, but also which direction at infinity they follow. In the context of partial differential equations, this provides precious information on the shape of the blow up profile.

Last but not least the Poincaré compactification helps us out to preserve the structure of Morse decomposition which will be essential in the Conley index theory. A Morse decomposition is a structure which orders the invariant sets in such a way that it is compatible with the flow, in the sense that trajectories only run downwards with respect to the order. Think for example of an order induced by an energy decreasing along trajectories. As one expects, different invariant sets on the sphere at infinity may exhibit different energy levels. The one point

compactification may shuffle those levels together and destroy the structure. This point will be more precisely stressed out in the context of gradient vector fields handled in section 4.2.

Even though the Poincaré compactification has many assets, we cannot just dismiss the Bendixson compactification as useless. There are some cases where it is just the natural thing to do whereas the Poincaré compactification would just add artificial annoying effects. Think about a dynamical system behaving asymptotically as  $x_t = x$  or  $x_t = -x$ . In the Poincaré compactification, the whole sphere at infinity consists of equilibria so that you have no isolation as required for Conley index theory. You are forced to consider infinity as a whole, and it is just the same as using the Bendixson compactification. Under this point of view, infinity is just an attractor or a repeller, respectively, and exhibits their typical Conley index. Another example is an asymptotically constant vector field. In the Bendixson compactification, the trajectories after projection on the sphere of the vector field  $x_t = c$  are great circles through the point at infinity. Therefore you are able to compute the Conley index at infinity of an asymptotically constant vector field and observe that this is the trivial Conley index (see Chapter 3). If you look at the same problem under Poincaré compactification, again the whole sphere at infinity consists of equilibria. Look also at example 1.3.2: the system under Bendixson compactification exhibits even a nice Morse structure (two equilibria on the higher energy level, one cycle on the lower), whereas the Poincaré compactification has a topologically more complicated one (two equilibria on the higher energy level, one "thin bretzel" on the lower). Compare figures 1.4 and 2.5.

Furthermore we will see in chapter 3 that the configuration of the Bendixson compactification makes it more intuitive to introduce our concept of Conley index at infinity: It does not require the technicality due to the fact that the equator is a boundary. That is the reason why we will present the properties of the Conley index at infinity first under the Bendixson compactification and will adapt them for the Poincaré compactification afterwards.



## Chapter 3

# Conley index: classical and at infinity

This chapter aims at presenting the classical Conley index methods and their applications to the analysis of isolated invariant sets at infinity on the one hand; on the other hand we want to show how restrictive is the study of isolated invariant sets at infinity and propose a way to use Conley index methods in spite of the lack of isolation, at least in some cases. We focus on invariant sets at infinity of "isolated invariant complement": the precise definition is given in 3.5.1 for the point at infinity in the Bendixson compactification, and in 3.5.30 for invariant subsets of the sphere at infinity in the Poincaré compactification, but let us give in this introduction the motivation of these concepts. The strength of the Conley index is based on the concept of isolating neighbourhood, which has the specificity to be robust whereas the set that it isolates may change under perturbation of the flow. For an invariant set  $S$  at infinity that is not isolated, the loss of robustness may be compensated by an isolating neighbourhood, not of  $S$  itself, but of everything but  $S$ . To be more precise, if an isolating neighbourhood can "grow bigger" so that its complement shrinks on  $S$ , and this without losing its isolation property, we say that this neighbourhood isolates the complement of  $S$ . We use time duality of the Conley index to define the Conley index of a set  $S$  of isolated invariant complement. This duality has been studied in details in [29, 26]. Further we propose a method to detect heteroclinics to/from a  $S$  of isolated invariant complement. The main idea is to substitute  $S$  by an object the Conley index can deal with. Then classical index theory is able to detect connections between finite isolated invariant sets and this "ersatz infinity". Those heteroclinics translate to trajectories accumulating on the corresponding invariant set at infinity of isolated complement in the - Bendixson or Poincaré - compactified phase space.

This chapter summarizes the general Conley index theory and some special features that we will be needing such as the Conley index on a manifold with boundary. Then we will show direct applications of these classical methods to the analysis of the dynamic at infinity. After this we expose the time duality of

the Conley index, before we develop the new concepts mentioned previously in the paragraph 3.5 and present our method to detect heteroclinic orbits between finite isolated invariant sets and invariant sets at infinity that are of isolated invariant complement.

## 3.1 Classical Conley index methods

### 3.1.1 Basic definitions and properties of the Conley index

The Conley index was introduced by Conley himself under the name "Morse index" in [10]. Generalization to infinite dimensional spaces is exposed in [34]. Some applications and a good introduction to Conley index theory is given in [38], whereas his definitions, for example for isolating blocks, are not quite standard. We also want to point out the nice overview article [21, 22].

The Conley index deals with invariant sets which can be isolated by a compact set in the sense of definition 3.1.3. Emptiness of the isolated invariant set implies triviality of the index: a consequence of this is the capacity of the Conley index to detect interesting dynamical behaviour. Furthermore it comes up with a topological algebraic machinery which allows to detect connections between isolated invariant sets. Those methods have been successfully applied to the analysis of the structure of global attractors. Under certain conditions, these consist exclusively of isolated invariant sets and heteroclinics between them, which is the typical situation to make use of this topological tool. Hence the Conley index theory provide information about the structure of the asymptotical dynamic of the system. Our aim is to extend Conley index methods to infinity via a compactification, in order to determine the structure of the "global attractor" of non-dissipative systems, including its dynamic at infinity.

But first of all let us introduce the basic definitions. We define them in the general settings of a semi flow  $\varphi$  in a phase space  $X$  which may be a vector space or a manifold. We present here the Conley index theory in the case of a locally compact phase space - hence finite dimensional - for clarity. We will comment on the infinite dimensional case in chapter 5 where we deal with partial differential equations.

If the original semi flow is a local flow, i. e. long time existence may fail, but we have uniqueness of the prehistory, which is normalizable (see definitions 1.2.1 or 2.2.1), then the compactified flow is the global flow: the normalization has been designed precisely to gain long time existence. On the other hand, if the original semi flow do not provide uniqueness of the prehistory, whether compactification nor normalization will help. Normalization transform blowing up trajectories in full trajectories. See remarks 1.2.4 2.2.5.

#### **Definition 3.1.1. Maximal invariant set**

Let  $N \subset X$  be a set. The maximal invariant set  $Inv(N)$  contained in  $N$  is defined

by the following:

$$Inv(N) := \{x \in N / \text{there exists a full trajectory through } x \text{ contained in } N.\}$$

**Definition 3.1.2. Compact neighbourhood**

A set  $N \subset X$  is called a compact neighbourhood if  $N$  is compact and is equal to the closure of its interior i. e.

$$N = cl(int(N)).$$

The empty set is a compact neighbourhood, but for instance the compact set  $[0, 1] \times \{0\} \subset \mathbb{R}^2$  is not, the closure of its interior being empty.

**Definition 3.1.3. Isolating neighbourhoods and isolated invariant sets**

Let  $N$  be a compact neighbourhood. The set  $N$  is called an isolating neighbourhood if and only if its maximal invariant set  $Inv(N)$  is contained in its interior  $int(N)$ , i. e.

$$Inv(N) \subset int(N).$$

A set  $S$  is called isolated invariant if it admits an isolating neighbourhood  $N$  with  $S := Inv(N)$ .

**Remark 3.1.4. Inflating and deflating isolating neighbourhoods** Once an invariant set  $S$  admits an isolating neighbourhood  $N$ , one can inflate and deflate this neighbourhood  $N$  to get other isolating neighbourhoods of  $S$ . More precisely hold:

1. Let  $K$  a compact neighbourhood of  $S$  contained in  $N$ . Then  $K$  is also an isolating neighbourhood of  $S$  for the following reasons. The inclusion  $K \subset N$  implies the inclusion  $Inv(K) \subset Inv(N) = S$ . The reversed inclusion  $Inv(N) \subset Inv(K)$  results of the maximality of  $Inv(K)$ , so that  $S = Inv(K) \subset int(K)$  as claimed.
2. On the other hand, a compact neighbourhood  $K$  containing  $N$  isolates  $K$  as long as  $Inv(K) \subset N$ , i. e.  $K$  does not contain more invariant dynamic than  $N$ . Then holds  $S \subset Inv(K) \subset Inv(N) = S \subset int(N) \subset int(K)$ , which proves the claim.

This easy fact will play an important role in paragraph 3.5.

**Proposition 3.1.5. Robustness of isolating neighbourhoods**

Let  $\varphi$  be a flow and  $N$  an isolating neighbourhood with respect to  $\varphi$ . For every small enough perturbation  $\tilde{\varphi}$  of  $\varphi$ , the compact  $N$  is an isolating neighbourhood with respect to  $\tilde{\varepsilon}$ .

This proposition is a consequence of the fact that the distance between the maximal invariant set  $Inv(N)$  and the boundary  $\partial N$  of  $N$  is strictly positive and remains so as one varies the flow. The maximal invariant set  $Inv(N)$  may change under perturbation of the flow, but the isolation property is robust.

An isolating neighbourhood where the trajectories do not show internal tangencies is called an isolating block. We will see in proposition 3.1.12 that it has interesting properties, but let us first set its precise definition.

**Definition 3.1.6. Isolating block**

Let  $N$  be a compact neighbourhood. Then  $N$  is called isolating block if and only if the trajectories through  $N$  admit no internal tangencies, i. e. for all  $x \in \partial N$ , every trajectory  $\sigma$  through  $x$ , and every  $\varepsilon > 0$ ,

$$\sigma([0, \varepsilon], x) \not\subseteq N \quad \text{or} \quad \sigma(] - \varepsilon, 0], x) \not\subseteq N.$$

As a nonempty intersection  $Inv(N) \cap \partial N \neq \emptyset$  would imply an internal tangency of a trajectory with the boundary  $\partial N$ , the following is straightforward.

**Proposition 3.1.7.** *If a compact neighbourhood  $N$  is an isolating block, then  $N$  is an isolating neighbourhood.*

Furthermore, by "shaving" and "squeezing" an isolated neighbourhood with help of the flow, one can prove the following (see for example [34, 38] for details):

**Proposition 3.1.8.** *Each isolating neighbourhood contains an isolating block.*

The construction of the Conley index relies on the concept of index pairs.

**Definition 3.1.9. Index pair**

Let  $S \subseteq X$  be an isolated invariant set. A pair of compact sets  $(N, L)$  with  $L \subseteq N \subseteq X$  is an index pair for  $S$  if and only if

1. **Isolation:** The set  $cl(N \setminus L)$  is an isolating neighbourhood for  $S$ .
2. **Positive invariance of  $L$  with respect to  $N$ :** A trajectory starting in  $L$  remains in  $L$  until it leaves  $N$ , i. e. for all  $x \in L$  and all  $t > 0$ ,  $\varphi([0, t], x) \subseteq N \implies \varphi([0, t], x) \subseteq L$ .
3. **The set  $L$  is an exit set for  $N$ :** The trajectories leave  $N$  through  $L$ , i. e. for all  $x \in N$  and  $t_1 > 0$  with  $\varphi(t_1, x) \notin N$ , there exists a time  $t_0 \in [0, t_1]$ , such that  $\varphi([0, t_0], x) \subseteq N$  and  $\varphi(t_0, x) \in L$ .

The following will guarantee the existence of index pairs.

**Definition 3.1.10. Exit set**

Let  $N$  be a compact neighbourhood. Its immediate exit set  $N^-$  is defined by

$$N^- := \{x \in N : \forall t > 0, \phi(\cdot, t, x) \not\subseteq N\} \subset \partial N.$$

Similarly its immediate entrance set  $N^+$  is defined by

$$N^+ := \{x \in N : \forall t > 0, \text{ there exists no trajectory } \sigma \text{ through } x \text{ with } \sigma(\cdot - t, 0, x) \subseteq N\} \subset \partial N.$$

From the definitions 3.1.6 and 3.1.10 follows immediately the proposition:

**Proposition 3.1.11.** *Let  $N$  be an isolating block. It holds*

$$\partial N = N \cup N^-.$$

*The intersection  $N^+ \cap N$  contains the points of external tangencies.*

**Proposition 3.1.12.** *If  $N$  is an isolating block, then  $(N, N^-)$  is an index pair.*

*Proof.* As  $N^- \subset \partial N$ , it holds  $cl(N \setminus N^-) = N$ , hence the condition (1) is clearly fulfilled.

Per definition of  $N^-$ , a trajectory beginning in  $N^-$  leaves  $N$  immediately, so  $N^-$  is positively invariant with respect to  $N$ .

Every trajectory leaving  $N$  has to intersect the boundary  $\partial N$ . This intersection will be transverse as  $N$  is an isolating block. Hence this intersection point lies in  $N^-$ .  $\square$

As a consequence of propositions 3.1.8 and 3.1.12 we have:

**Corollary 3.1.13.** *Each isolated invariant set admits an index pair.*

Now we have gathered all ingredients to be able to define the Conley index of an isolated invariant set.

**Definition 3.1.14. Conley index**

Let  $(N, L)$  be an index pair for the isolated invariant set  $S$  and  $* \notin X$  an universal point. The Conley index  $h(S)$  of  $S$  is a homotopy class of pointed space defined as

$$h(S) = \left[ \frac{N \cup \{*\}}{L \cup \{*\}} \right],$$

where  $\left[ \frac{N \cup \{*\}}{L \cup \{*\}} \right]$  denotes the homotopy class of the quotient space  $\frac{N \cup \{*\}}{L \cup \{*\}}$  obtained by collapsing  $L \cup \{*\}$  to a distinguished point denoted by  $[*]$ .

**Remark 3.1.15.** The addition of an universal point  $* \notin X$  suits the case where the exit set  $L$  is empty, and otherwise the resulting quotient space shows the same topology as the quotient  $\frac{N}{L}$ . Hence if an isolated invariant set  $S$  admits an index pair  $(N, L)$  where  $N$  is retractable to a point and  $L$  is empty, its Conley index is

$$h(S) = \left[ \frac{N \cup \{*\}}{\{*\}} \right] = \Sigma^0,$$

as the index  $h(S)$  consists of one point coming from  $N$  via homotopy on the one side, and the distinguished point  $[*]$  on the other side.

As another example we consider an isolated invariant set  $N'$  which admits an index pair  $(N', L')$  having the property that the set  $N'$  is homotopic to its exit set  $L'$ . Such a situation is shown in figure 3.1. Take for  $N'$  a disk around the equilibrium: this choice provides an isolating block. The exit set  $N'$  is the right half of the circle bounding  $N'$ . Then we have

$$h(S') = \left[ \frac{N' \cup \{*\}}{L' \cup \{*\}} \right] = \left[ \frac{L' \cup \{*\}}{L' \cup \{*\}} \right] = [*] =: \bar{0}.$$

This Conley index is called "trivial Conley index" because it is the Conley index of the empty set. Indeed the pair  $(\emptyset, \emptyset)$  is an index pair for the empty set and it holds

$$h(\emptyset) = \left[ \frac{\emptyset \cup \{*\}}{\emptyset \cup \{*\}} \right] = [*].$$

For further classical examples see 3.1.18.

The Conley index is well defined and does not depend on the choice of the index pair used for its computation. We refer to [10, 38, 34] for the proof of this fact. There a homotopy between the quotient spaces given by different index pairs is constructed with the help of the flow.

It will reveal useful to define the Conley index on the homology level to be able to use it in an algebraic way. Let us first recall a few basic facts about homology theory. We choose to use the singular homology theory, following a consensus in Conley index theory. Furthermore we make the choice of coefficients in the field  $\mathbb{Z}_2$  such that the homology groups are in fact homology vector spaces.

We do not want here to introduce the singular homology theory - for this we rather refer to [39, 12] - but we recall the ingredients and the general axioms satisfied by every homology theory.

The homology functor maps on one hand pairs  $(N, N_1)$  on graded vector spaces  $H_*(N, N_1) = \{H_n(N, N_1)\}_{n \in \mathbb{N}}$  called relative homology groups (or even vector spaces in our case); on the other hand the homology functor maps continuous maps  $f : (N, N_1) \rightarrow (N', N'_1)$  between pairs to linear maps  $f_* : H_*(N, N_1) \rightarrow H_*(N', N'_1)$  between their homology vector spaces. In particular if the map  $i : (N, N_1) \rightarrow (N', N'_1)$  is the inclusion  $N \subset N', N_1 \subset N'_1$ , then the map  $i_*$  is the

inclusion

$$\begin{array}{ccc} i_* : H_*(N, N_1) & \rightarrow & H_*(N', N'_1) \\ v & \mapsto & v. \end{array}$$

Furthermore there is a boundary map  $\partial$  which is a map of degree -1 between  $H_*(N, N_1)$  and  $H_*(N_1, \emptyset) = H_*(N_1)$ , in other words for each homology level  $q$ ,

$$\partial_q : H_q(N, N_1) \rightarrow H_{q-1}(N_1).$$

A homology theory satisfies the Eilenberg–Steenrod axioms:

1. **Homotopy axiom:** if two maps  $f_0, f_1 : (N, N_1) \rightarrow (N', N'_1)$  are homotopic, then  $f_{0*} = f_{1*} : H_*(N, N_1) \rightarrow H_*(N', N'_1)$ .
2. **Exactness axiom:** For any pair  $(N, N_1)$  the inclusion maps  $i : N_1 \rightarrow N$  and  $j : (N, \emptyset) \rightarrow (N, N_1)$  together with the boundary map  $\partial_*$  induce the following long exact sequence  $\dots \xrightarrow{\partial_*} H_n(N_1) \xrightarrow{i_*} H_n(N) \xrightarrow{j_*} H_n(N, N_1) \xrightarrow{\partial_*} H_{n-1}(N_1) \xrightarrow{i_*} \dots$
3. **Excision axiom:** For any pair  $(N, N_1)$ , if  $U$  is an open subset of  $N$  such that  $cl(U) \subset int(N)$ , then the excision map  $j : (N \setminus U, N_1 \setminus U) \rightarrow (N, N_1)$  induces an isomorphism

$$j_* : H_*(N \setminus U, N_1 \setminus U) \rightarrow H_*(N, N_1)$$

4. **Dimension axiom:** If  $P$  is a one point space  $P = \{x\}$  then

$$H_q(P) = \begin{cases} 0 & q \neq 0 \\ \mathbb{Z}_2 & q = 0 \end{cases}$$

### Definition 3.1.16. Homological Conley index

The homological Conley index of an isolated invariant set  $S$  is the homology group of its Conley index  $h(S)$  relative to its distinguished point noted  $\{*\}$  in the following formula.

$$H_*(S) := H_*(h(S), \{*\})$$

**Remark.** The relative homology group  $H_*(h(S), \{*\})$  is also called reduced homology of  $h(S)$  and noted  $\tilde{H}_*(h(S))$ . The reduced homology is defined in such a way that the homology of a single point is trivial and in dimensions other than zero does not differ from the usual homology (see [12, 39] for details).

**Remark 3.1.17.** Let  $S$  be an isolated invariant set and  $(N, N_1)$  an index pair for  $S$ . Its homological Conley index  $H_*(S)$  is equal to the relative homology  $H_*(N, N_1)$  as soon as  $S$  admits a "good" index pair - see [12] for technical details. This is for example the case if the flow is  $C^1$ . Then there exists for each isolated invariant set an isolating block which is a differentiable manifold with boundary, which is a sufficient condition. See [29] and references therein.

Of course some information may get lost as passing to the homology group, but this is the price to pay to make use of powerful algebraic structures.

**Example 3.1.18. Pointed spheres**

The Conley indices of hyperbolic fixpoints are pointed spheres whose dimension is the dimension of the unstable manifold. Hence a hyperbolic fixpoint  $p$  with a  $d$ -dimensional unstable manifold has Conley index  $h(p) = \Sigma^d$  and homological Conley index  $H_*(p)$ :

$$H_n(p) = \begin{cases} \{0\} & n \neq d \\ \mathbb{Z}_2 & n = d \end{cases}$$

This fact is proved in two steps. Without loss of generality a block  $K$  is given by a cube around  $p$ .

1. The flow provides a homotopy contracting the block along the stable directions.
2. Through this homotopy,  $K$  has been deformed in a  $d$ -dimensional cube, its exit set  $K^-$  in its boundary. Hence the quotient  $\frac{K}{K^-}$  has the homotop type of a pointed  $d$ -dimensional sphere.

**Proposition 3.1.19.** *Let  $S_1$  and  $S_2$  be two disjoint isolated invariant sets. Hence the disjoint union  $S := S_1 \dot{\cup} S_2$  is also isolated invariant and for the Conley indices holds:*

$$\begin{aligned} h(S) &= h(S_1) \vee h(S_2), \\ H_*(S) &= H_*(S_1) \oplus H_*(S_2). \end{aligned}$$

Here the wedge  $h(S_1) \vee h(S_2)$  of the two pointed spaces  $h(S_1)$  and  $h(S_2)$  has to be understood as the gluing of the two spaces at their distinguished points.

*Proof.* The equality  $h(S) = h(S_1) \vee h(S_2)$  is justified by the fact that  $S_1$  and  $S_2$  admit disjoint index pairs  $(N_1, P_1)$  and  $(N_2, P_2)$  respectively, whose disjoint union builds an index pair  $(N_1 \cup N_2, P_1 \cup P_2)$  for  $S$ . Hence it holds

$$\begin{aligned} h(S) &= \left[ \frac{N_1 \cup N_2}{P_1 \cup P_2} \right] \\ &= \left[ \frac{N_1}{P_1 \cup P_2} \cup \frac{N_2}{P_1 \cup P_2} \right] \\ &= \left[ \frac{N_1}{P_1} \vee \frac{N_2}{P_2} \right] \\ &= h(S_1) \vee h(S_2). \end{aligned}$$

The equality  $H_*(S) = H_*(S_1) \oplus H_*(S_2)$  is now just a consequence of the basic additivity property of homology  $H_*(h(S_1) \vee h(S_2)) = H_*(h(S_1)) \oplus H_*(h(S_2))$  proved for example in [12] III.7.8.  $\square$



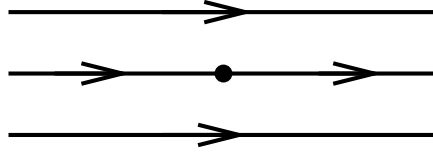

Figure 3.1: Non structurally stable equilibrium.

As we will see in the paragraph 3.4, we need also the cohomological Conley index for further algebraic constructions.

**Definition 3.1.20. Cohomological Conley index**

Let  $S$  be an isolated invariant set. The cohomological Conley index of  $S$  denoted by  $H^*(S)$  is defined as the cohomology of the Conley index of  $S$ , that is

$$H^*(S) := H^*(h(S)).$$

The first basic property of the Conley index is the detection of invariant sets.

**Proposition 3.1.21. Detection of invariant sets**

Let  $N$  be a isolating neighbourhood. If the Conley index  $h(\text{Inv}(N))$  is non trivial, then  $\text{Inv}(N)$  is nonempty.

*Proof.* The pair  $(\emptyset, \emptyset)$  is an index pair for the empty set. Therefore holds  $h(\emptyset) = \{*\} = \bar{0}$ . Hence  $h(\text{Inv}(N)) \neq \bar{0}$  implies  $\text{Inv}(N) \neq \emptyset$ .  $\square$

**Remark 3.1.22.** The converse is not true: For example structurally unstable invariant sets are not detected by the Conley index. In figure 3.1, the Conley index of the equilibrium is trivial, and small perturbations of the flow destroy the equilibrium.

The isolated invariant sets themselves are not robust, but the isolating neighbourhoods and the Conley index of their maximal invariant sets are robust. This fact is known under the name of continuation that we define in the following. We introduce a parameter space  $\Lambda$  which is supposed to be a compact, locally contractible connected metric space - for instance a compact interval of  $\mathbb{R}$ . A family of flows  $\{\varphi_\lambda\}_{\lambda \in \Lambda}$  is parametrized by  $\Lambda$  through

$$\begin{aligned} \Phi \quad \mathbb{R} \times X \times \Lambda &\rightarrow X \times \mathbb{R} \\ (t, x, \lambda) &\mapsto \Phi(t, x, \lambda) := (\varphi_\lambda(t, x), \lambda) \end{aligned}$$

Furthermore, if  $N$  is a subset of  $X \times \mathbb{R}$  we denote by  $N_\lambda$  the slice

$$N_\lambda := N \cap (X \times \{\lambda\}).$$

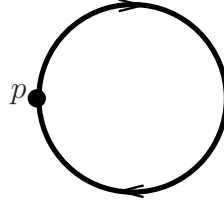

Figure 3.2: Equilibrium  $p$  is not an attractor although  $\forall y \in S^1, \omega(y) = \{p\}$ .

**Definition 3.1.23.** Let  $\lambda, \mu$  be fixed in  $\Lambda$ , and let the sets  $S_\lambda$  and  $S_\mu$  be isolated invariant with respect to the flows  $\varphi_\lambda$  and  $\varphi_\mu$  respectively. The isolated invariant sets  $S_\lambda$  and  $S_\mu$  are said to be related by continuation if there exists an isolating neighbourhood  $N \subset X \times \Lambda$  with respect to the parametrized flow  $\Phi$  as above, such that  $S_\lambda = \text{Inv}(N_\lambda)$  under the flow  $\varphi_\lambda$  and  $S_\mu = \text{Inv}(N_\mu)$  under the flow  $\varphi_\mu$ .

**Proposition 3.1.24. Continuation of the index**

*If two isolated invariant sets are related by continuation, then their Conley indices coincide.*

**Remark 3.1.25.** The equilibrium of figure 3.1 may be continued to the empty set, hence it has its index.

We want here to recall basic definitions of  $\omega$ - and  $\alpha$ -limit sets for sets to avoid confusion.

**Definition 3.1.26.** Let  $U$  be a subset of a phase space  $X$  equipped with a flow  $\varphi$ . The  $\omega$ -limit of  $U$  is defined as

$$\omega(U) = \{x \in X / \exists \{y_n\}_{n \in \mathbb{N}} \subset U \{t_n\}_{n \in \mathbb{N}} \rightarrow +\infty / \varphi(t_n, y_n) \rightarrow x\}.$$

The  $\alpha$ -limit of  $U$  is defined as

$$\alpha(U) = \{x \in X / \exists \{y_n\}_{n \in \mathbb{N}} \subset U, \{t_n\}_{n \in \mathbb{N}} \rightarrow -\infty / \varphi(t_n, y_n) \rightarrow x\}.$$

**Remark 3.1.27.** Even if  $U$  is an open set, the definition is not equivalent with the union of all  $\omega(y)$  ( $\alpha(y)$  respectively) for  $y \in U$ . See figure 3.2: if  $U$  is a neighbourhood around the equilibrium  $p$ , it holds:

$$\omega(U) = S^1,$$

although for every  $y \in U, \omega(y) = \{p\}$ . In particular,  $p$  is not an attractor.

**Proposition 3.1.28.** *Let  $S$  be an isolated invariant set. If  $h(S)$  admits one connected component containing only the distinguished point  $\{*\}$  and at least one further component, then  $S$  is an attractor up to an invariant subset of trivial Conley index. In other words, the isolated invariant set  $S$  may be written as the disjoint union  $S = S' \cup A$ , where  $A$  is an attractor i. e. there exists a neighbourhood  $U$  of  $A$  for which holds  $\omega(U) = A$ , and  $h(S') = \bar{0}$ .*

*Proof.* Let a compact set  $N$  be an isolating block for  $S$ . If the exit set  $N^-$  is empty, then  $S$  is an attractor because no trajectory leaves  $N$  in forward time so that for every  $x \in N$ , holds  $\omega(x) \subset S$ .

If  $N^- \neq \emptyset$ , write  $N$  as the disjoint union of its connected components

$$N = N_1 \cup N_2 \cup \cdots \cup N_k.$$

Not every connected component  $N_i$  intersects the exit set  $N^-$ , otherwise the Conley index  $h(S)$  would be connected which contradicts the assumption. Without loss of generality the components  $N_1, \dots, N_m$  have a nonempty intersection with  $N^-$  whereas the components  $N_{m+1}, \dots, N_k$  do not intersect  $N^-$ . Set

$$S' := \text{Inv}(N_1) \cup \cdots \cup \text{Inv}(N_m),$$

$$A := \text{Inv}(N_{m+1}) \cup \cdots \cup \text{Inv}(N_k).$$

Because  $S'$  and  $A$  are disjoint holds  $h(S) = h(S') \vee h(A)$ . The Conley index  $h(S')$  is connected and contains  $\{*\}$ , so by assumption must hold  $h(S') = \{*\} = \bar{0}$ . Furthermore no trajectory leaves  $N_{m+1} \cup \cdots \cup N_k$  in forward time, so  $A$  is an attractor.  $\square$

The following proposition is somehow the converse of the previous one.

**Proposition 3.1.29.** *Let  $A$  be an attractor. Then  $A$  is an isolated invariant set and its Conley index shows at least two connected components, one of them consisting only of the distinguished point  $\{*\}$ .*

*Proof.* According to the theorem 3.1.66, there exists a function  $V : X \rightarrow \mathbb{R}$  which is constant on  $A$  and strictly decreasing along trajectories in a neighbourhood  $U$  of  $A$  which is small enough not to intersect the recurrent set. As the set  $A$  is assumed to be an attractor, it builds a minimum of  $V$  in the neighbourhood  $U$ . Let denote by  $a$  the value of  $V$  on  $A$ . Then we claim that, for  $d > a$ , the sublevelset

$$K := \{x \in U / V(x) \leq d\} \supset S$$

is an isolating block for  $A$  as soon as  $d - a > 0$  is sufficiently small. Indeed the boundary  $\partial K = \{x \in U / V(x) = d\}$  does not intersect  $A$ . Furthermore every point of  $\partial K$  belongs to the immediate entrance set of  $K$  because of the monotony of  $V$ . Hence there is no point of external tangency. The compact  $K$  is an isolating block with empty exit set. Therefore the index of  $A$  reads

$$h(A) = \left[ \frac{K \cup \{*\}}{\{*\}} \right] = [K] \cup \{*\},$$

and the proposition follows.  $\square$

Similarly holds for repellers the following proposition.

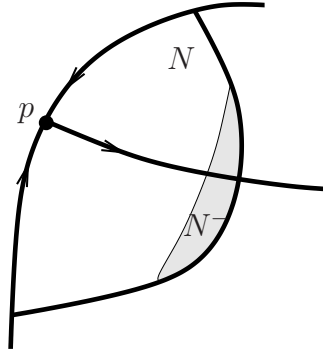

Figure 3.3: The Conley index  $h(p) = \left[ \frac{N}{N^-} \right]$  of the saddle  $p$  is trivial .

**Proposition 3.1.30.** *Let  $S$  be an isolated invariant set. The set  $S$  is a repeller if and only if there exists an isolating block  $B$  (nonempty) whose exit set consists of its whole boundary  $\partial B = B^-$ .*

*Proof.* If the set  $S$  is a repeller, then it is a maximum for the abstract Lyapunov function  $V$  of theorem 3.1.66. Hence an isolating block  $B$  can be found of the form  $B = \{V \geq d\}$ , for  $d$  smaller but near  $V(S)$ . By definition of  $V$ , the exit set reads  $B^- = \partial B$ .

If there exists an isolating block  $B$  whose exit set  $B^-$  is nothing less than  $\partial B$ , then it is clear that  $\alpha(\text{int}(B)) = S$ .  $\square$

**Definition 3.1.31.** Let  $S$  be an isolated invariant subset of a phase space  $X$  equipped with a flow  $\varphi$ . The set  $S$  is said to have the index of an attractor if its Conley index admits at least two connected components, one of those consisting only of the distinguished point  $\{*\}$ .

The set  $S$  is said to have the index of a repeller if it admit an isolating block  $B$  whose exit set is  $B^- = \partial B$ , its boundary.

### 3.1.2 Conley Index on a Manifold with Boundary

If the phase space is a manifold with boundary, the Conley index needs to be adapted to take this boundary into account. This is the case in particular when we apply the Poincaré compactification: the compactified phase space is a hemisphere (topologically a disk) whose boundary is the equator (a sphere of dimension lower by one than the dimension of the original phase space). We establish on the example of a hyperbolic saddle point at the boundary of a 2-dimensional manifold, as illustrated in Figure 3.3, that the Conley index as we have defined it until now, is trivial in a situation where we expect it to reveal the existence of a non trivial isolated invariant set. We explain in the following how the classical Conley index adapts to this situation.

Let us consider a manifold  $M$  with boundary  $\partial M$  on which a semi flow is defined. The boundary  $\partial M$  is invariant under the semi flow. If  $K$  is a subset of  $M$ , the boundary  $\partial K$  of  $K$  has to be understood as the boundary of  $K$  relatively to the manifold  $M$ , and may be denoted by  $\partial_M K$  to avoid confusion. The Conley index of an isolated invariant set  $S$  is defined via one of its index pair  $(N, N_1)$  satisfying Definition 3.1.9, as in the standard case, but has to split into several components to extract the dynamical information both in the boundary and in the inner part of the manifold. The definition of an isolated invariant set does not change either, but we want to stress out that the condition on a isolating neighbourhood  $K$  of  $S$  reads

$$S \cap \partial_M K = \emptyset$$

if the phase space is a manifold  $M$  with boundary. Therefore, the isolated invariant set  $S$  may intersect the absolute boundary of  $K$ , but only in the interior of  $K \cap \partial M$  relatively to  $\partial M$  which is disjoint from  $\partial_M K$ . For example,  $S$  may lie in the boundary of  $M$ . Similarly for an isolating block  $K$ : the boundary  $\partial_M K$  is not allowed to admit internal tangencies, whereas  $\partial M \cap K$  cannot avoid containing internal tangencies due to the invariance of  $\partial M$ . The definition of the Conley index on a manifold with boundary is given in the following Definition 3.1.32 and is illustrated in the basic example of hyperbolic fix points on the boundary in Example 3.1.36.

**Definition 3.1.32. Conley index on a manifold with boundary**

We consider an isolated invariant set  $S$  on a manifold  $M$  with boundary  $\partial M$ . The set  $S$  admits an index pair  $(N, N_1)$  in the sense of 3.1.9. Let  $* \notin X$  be a universal point. The Conley index of  $S$  is defined by three homotopy classes of pointed spaces as follows:

$$h(M; S) := \left[ \frac{N \cup \{*\}}{N_1 \cup \{*\}} \right], \text{ the Conley index with respect to } M;$$

$$h(M, \partial M; S) := \left[ \frac{N \cup \{*\}}{N_1 \cup (N \cap \partial M) \cup \{*\}} \right], \text{ the Conley index with respect to } M \text{ and } \partial M;$$

$$h(\partial M; S) := \left[ \frac{N \cap \partial M \cup \{*\}}{N_1 \cap \partial M \cup \{*\}} \right], \text{ the Conley index with respect to } \partial M.$$

**Remark 3.1.33.** As the empty pair  $(\emptyset, \emptyset)$  is an index pair for the isolated invariant empty set, we obviously have

$$h(M; \emptyset) = h(M, \partial M; \emptyset) = h(\partial M; \emptyset) = \bar{0}.$$

Hence if an isolated invariant set  $S$  has one of those three indices non trivial, then the set  $S$  is non empty. As for the standard index, the Conley index in a manifold with boundary is able to detect isolated invariant sets. However, one has to compute the three indices with respect to  $M$ , to  $M$  and  $\partial M$ , and to  $\partial M$  before concluding.

The other basic properties of the Conley index like for example robustness, continuation, additivity, are obviously true for the Conley indices on a manifold with boundary, as well.

**Remark 3.1.34.** If the isolated invariant set  $S$  does not intersect the boundary  $\partial M$ , there exists an index pair which does not intersect the boundary and it clearly holds

$$\begin{aligned} h(M; S) &= h(M, \partial M; S) \\ h(\partial M; S) &= \bar{0} \end{aligned}$$

**Remark 3.1.35.** The boundary  $\partial M$  of the manifold  $M$  is invariant under the flow and is a manifold without boundary where we can define the Conley index in the standard way described above. Therefore the Conley index with respect to the boundary of an isolated invariant set  $S$ , denoted by  $h(\partial M; S)$ , coincides with the standard Conley index  $h(S \cap \partial M)$  of  $S \cap \partial M$  as an isolated invariant set in the manifold without boundary  $\partial M$ .

To illustrate Definition 3.1.32 let us present the important example of hyperbolic fixpoints on the boundary of a ball. Those may be interpreted as hyperbolic fixpoints on the equator of the Poincaré hemisphere, alias infinity, as in Example 2.3.1.

**Example 3.1.36.** Let  $M$  be a  $n$ -dimensional disk. Hence its boundary  $\partial M$  is a  $(n - 1)$ -dimensional sphere. We compute the Conley indices - in the sense of Definition 3.1.32 - of a hyperbolic fix point  $p$  sitting on the boundary  $\partial M$ . The hyperbolicity of the fix point implies that the linearisation of the vector field at this point  $p$  admits  $n$  eigendirections whose corresponding eigenvalues are non zero. The position of the fix point splits these eigendirections into two parts:  $n - 1$  of them span the tangent space  $T_p \partial M$  to the boundary at the point  $p$ . The remaining eigendirection points to the inner part of the manifold. The stability of this last eigendirection will play an important role for the Conley indices and justifies our distinguishing the following cases:

**Case 1:** The eigendirection pointing to the interior of  $M$  is stable.

Let  $k \in \{0, \dots, n - 1\}$  be the number of unstable eigendirections - all of them lying in the tangent space  $T_p \partial M$  to  $\partial M$  at the fix point  $p$ . We claim that the Conley indices with respect to  $M$ , to  $M$  and  $\partial M$ , and to  $\partial M$ , behave as follows:

$$h(M; p) = \Sigma^k \tag{3.1}$$

$$h(M, \partial M; p) = \bar{0} \tag{3.2}$$

$$h(\partial M; p) = \Sigma^k \tag{3.3}$$

The index  $h(\partial M; p) = \Sigma^k$  with respect to the boundary is obvious by Remark 3.1.35. The equality  $h(M; p) = h(\partial M; p)$  holds because, the inner direction being stable, the flow provides homotopy that retracts an index pair for  $p$ , say  $(N, N_1)$ , on an index pair  $(N \cap \partial M, N_1 \cap \partial M)$  for the flow on the boundary. The very same homotopy provides the last equality left  $h(M, \partial M; p) = \bar{0}$ : the index with respect to  $M$  and  $\partial M$  is defined as the homotopy type of the quotient space

$\frac{N}{N_1 \cup (N \cap \partial M)}$ , and the flow provides a homotopy compressing  $N$  onto  $N \cap \partial M$ , such that  $h(M, \partial M; p)$  is trivial, as claimed.

**Case 2:** The eigendirection pointing to the interior of  $M$  is unstable.

Here again, we denote by  $k \in \{0, \dots, n-1\}$  the number of unstable directions - i. e. eigendirections for which the corresponding eigenvalue is positive - of the linearisation of the vector field at  $p$  in the tangent space  $T_p \partial M$  to the boundary. As the direction pointing to the interior of  $M$  is assumed to be unstable as well, the linearisation at  $p$  has altogether  $k+1$  unstable eigendirections. We claim that the Conley indices of  $p$  are as follows:

$$h(M; p) = \bar{0} \quad (3.4)$$

$$h(M, \partial M; p) = \Sigma^{k+1} \quad (3.5)$$

$$h(\partial M; p) = \Sigma^k \quad (3.6)$$

The equality  $h(\partial M; p) = \Sigma^k$  is clear from standard Conley index theory on the manifold without boundary  $\partial M$ .

The hyperbolic fixpoint  $p$  has a  $k+1$ -dimensional unstable manifold  $W^u(p)$  which enters the interior of the manifold  $M$ , as the inner eigendirection of the linearised vectorfield at  $p$  itself is unstable. If an index pair  $(N, N_1)$  for the isolated invariant set  $\{p\}$  is chosen small enough, the intersection  $N \cap W^u(p)$  is topologically a  $k+1$ -dimensional half disk. Its boundary relatively to  $M$  is  $\partial_M N \cap W^u(p)$ . Here  $\partial_M N$  denotes  $N$  without its interior relatively to  $M$ . Without loss of generality,  $N$  is connected and so is  $\partial_M N$ . Per definition of the exit set  $N_1$  in the index pair, we have  $\partial_M N \cap W^u(p) \subset N_1$ . Moreover the flow provides a homotopy  $\psi$  which both retracts  $N$  onto  $N \cap W^u(p)$  and the exit set  $N_1$  onto  $\partial_M N \cap W^u(p)$ . Therefore the following diagram commutes:

$$\begin{array}{ccc} (N, N_1) & \xrightarrow{\psi} & (N \cap W^u(p), \partial_M N \cap W^u(p)) \\ q \downarrow & & \downarrow q \\ N/N_1 & \xrightarrow{\tilde{\psi}} & N \cap W^u(p) / \partial_M N \cap W^u(p) \end{array}$$

where  $\tilde{\psi}$  is a homotopy induced by  $\psi$ , and  $q$  is the quotient map. It is easy to see that the homotopy type of  $(N \cap W^u(p)) / (\partial_M N \cap W^u(p))$  is trivial, hence  $h(M; p) = \bar{0}$ .

For the computation of the last index  $h(M, \partial M; p)$  we use the same flow defined homotopy  $\psi$ . This retracts  $N \cap \partial M$  onto  $N \cap \partial M \cap W^u(p)$ . Now the set  $(N \cap \partial M \cap W^u(p)) \cup (\partial_M N \cap W^u(p))$  builds the whole absolute boundary of the  $k+1$ -dimensional disk  $N \cap W^u(p)$ , such that the homotopy type of the quotient space  $(N \cap W^u(p)) / ((N \cap \partial M \cap W^u(p)) \cup (\partial_M N \cap W^u(p)))$  is the  $k+1$ -dimensional pointed sphere  $\Sigma^{k+1}$ . The following diagram commutes

$$\begin{array}{ccc} (N, N_1 \cup (N \cap \partial M)) & \xrightarrow{\psi} & (N \cap W^u(p), (N \cap \partial M \cap W^u(p)) \cup (\partial_M N \cap W^u(p))) \\ q \downarrow & & \downarrow q \\ N/N_1 & \xrightarrow{\tilde{\psi}} & (N \cap W^u(p)) / ((N \cap \partial M \cap W^u(p)) \cup (\partial_M N \cap W^u(p))) \end{array}$$

where  $\tilde{\psi}$  is a homotopy induced by  $\psi$ , and  $q$  is the quotient map. This proves the equality  $h(M, \partial M; p) = \Sigma^{k+1}$ .

Finally we give characterizations of attractors and repellers at the boundary. We place us in the context of the Poincaré hemisphere to fix the ideas.

**Proposition 3.1.37.** *We consider a flow on the Poincaré hemisphere  $\mathcal{H}$ . Let  $S$  be an isolated invariant set in the sphere at infinity,  $S \subset \mathcal{E} = \partial\mathcal{H}$ .*

*The set  $S$  is an attractor if and only if it admits an isolating block  $B$  with empty exit set  $B^- = \emptyset$ .*

*In this case the Conley indices of  $S$  read*

$$\begin{aligned} h(\mathcal{H}; S) &= h(\mathcal{E}; S) = [B] \cup \{*\} \\ h(\mathcal{H}, \mathcal{E}; S) &= \bar{0} \end{aligned}$$

*Proof.* As for the proof in the case of a phase space without boundary, the assumption of  $S$  being an attractor reveals that that  $S$  is a minimum of the abstract Lyapunov function  $V$  of theorem 3.1.66. Therefore an isolating block with empty exit set exists. Furthermore, the flow provides an homotopy between  $B$  and  $B \cap \mathcal{E}$  due to the fact that  $S \subset \mathcal{E}$  attracts trajectories through  $B$ . Therefore, the homotopy types  $[B]$  and  $[B \cap \mathcal{E}]$  coincide - and so do the indices  $h(\mathcal{H}; S)$  and  $h(\mathcal{E}; S)$ . Assuming the existence of an isolating block  $B$  with empty exit set leads to  $\omega(\text{int}(B)) = S$ , i. e. the set  $S$  is an attractor.

The formulas for the indices are straightforward.  $\square$

**Proposition 3.1.38.** *We consider a flow on the Poincaré hemisphere  $\mathcal{H}$ . Let  $S$  be an isolated invariant set in the sphere at infinity,  $S \subset \mathcal{E}$ .*

*The set  $S$  is a repeller if and only if it admits an isolating block  $B$  with exit set  $B^- = \partial B$ .*

*In this case the Conley index of  $S$  relative to  $\mathcal{H}$  is trivial, i. e.  $h(\mathcal{H}; S) = \bar{0}$ .*

We skip the proof to avoid repetitive of argumentation.

**Definition 3.1.39.** In the context of Poincaré compactification, we denote by "index of an attractor" an index coming from an index pair  $(B, \emptyset)$ . This index takes the form:

$$\begin{aligned} h(\mathcal{H}; S) &= [B] \cup \{*\} \\ h(\mathcal{H}, \mathcal{E}; S) &= \bar{0} \\ h(\mathcal{E}; S) &= [B \cap \mathcal{E}] \cup \{*\} \end{aligned}$$

In the context of Poincaré compactification, we denote by "index of a repeller" an index coming from an index pair  $(B, \partial B)$ . This index takes the form:

$$\begin{aligned} h(\mathcal{H}; S) &= \bar{0} \\ h(\mathcal{H}, \mathcal{E}; S) &= \left[ \frac{B}{\partial B} \right] \\ h(\mathcal{E}; S) &= \left[ \frac{B \cap \mathcal{E}}{\partial B \cap \mathcal{E}} \right] \end{aligned}$$



**Remark 3.1.40.** A set  $S \subset \mathcal{E}$  with the index of an attractor is an attractor according to 3.1.37.

A set  $S \subset \mathcal{E}$  with the index of a repeller is a repeller according to 3.1.38.

For completeness, we want to address the case where an isolated invariant set  $S$  is not fully contained in the sphere at infinity, but intersects it nontrivially and characterize for this case the indices of attractors and repellers. We do not dispose of the flow induced homotopy between  $[B]$  and  $[B \cap \mathcal{E}]$ . As a consequence, we have to be content with the following definition.

**Definition 3.1.41.** Consider an isolated invariant set  $S \subset \mathcal{H}$ .

- The Conley index  $h(S)$  is said to be of an attractor if  $S$  admits an isolating block  $B$  whose exit set  $B^-$  is empty.
- The Conley index  $h(S)$  is said to be of a repeller if  $S$  admits an isolating block  $B$  whose exit set  $B^-$  is its boundary  $\partial_{\mathcal{H}}B$ .

The following holds.

**Proposition 3.1.42.** Consider an isolated invariant set  $S \subset \mathcal{H}$ .

- The set  $S$  is an attractor if and only if its index  $h(S)$  is of an attractor.
- The set  $S$  is a repeller if and only if its index  $h(S)$  is of a repeller.

This proposition is being used in the proof of 3.5.38.

### 3.1.3 Attractor–repeller decompositions

Now that we have defined the Conley index of isolated invariant sets, we want to present the machinery which allows to detect heteroclinic connections between these. To this aim, we begin by presenting the tool called “connection map”. This tool appears in the case where an isolated invariant set  $S$  can be decomposed in an attractor–repeller pair  $(A, A^*)$ . It detects connections between the repeller  $A^*$  and the attractor  $A$  (for precise definitions, see below). This construction is not only the most elementary non-trivial decomposition, but also constitutes the building block of the connection matrix theory developed for more sophisticated decompositions, as we will see in the next paragraph. For more details see for example [28].

**Definition 3.1.43. Attractor–repeller decomposition**

Let  $S$  be an isolated invariant set, and let  $A \subset S$  be a subset. The set  $A$  is called an attractor in  $S$  if there exists a neighbourhood  $U$  of  $A$  with  $\omega(U \cap S) = A$ . The set  $A^* := \{x \in S / \omega(x) \notin A\}$  is its dual repeller. The pair of invariant sets  $(A, A^*)$  is called an attractor–repeller decomposition of  $S$ . Similarly, the invariant set  $B \subset S$  is called a repeller in  $S$  if and only if there exists a neighbourhood  $U$  of  $B$  with  $\alpha(U \cap S) = B$ . The set  $B^- := \{x \in S / \alpha(x) \notin B\}$  is its dual attractor.

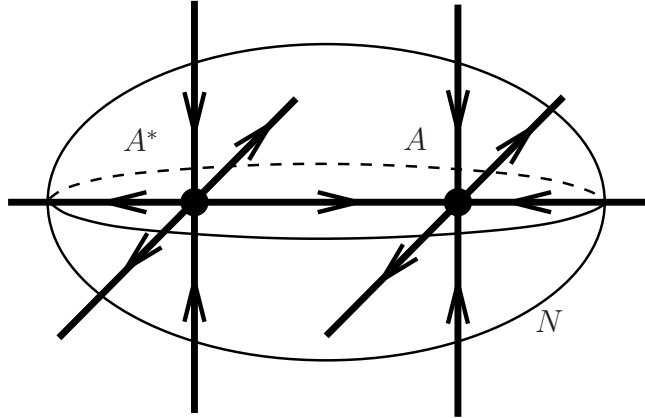

Figure 3.4: Decomposition of  $Inv(N) = S = A \cup A^* \cup C(A^*, A)$ .

If an isolated invariant set is decomposed in an attractor–repeller pair  $(A, A^*)$ , the behaviour of the points of  $S$  which belong neither to  $A$  nor to  $A^*$  is given by the following theorem whose proof is straightforward.

**Theorem 3.1.44.** *Let the set  $S$  be isolated invariant and suppose it admits an attractor–repeller decomposition  $(A, A^*)$ . If the set  $C(A^*, A) := \{x \in S/\alpha(x) \subset A^*, \omega(x) \subset A\}$  denotes the set of heteroclinic orbits from  $A^*$  to  $A$ , then it holds*

$$S = A \cup A^* \cup C(A^*, A).$$

**Example 3.1.45.** Let us consider all along this paragraph the following basic example of an attractor–repeller decomposition of an isolated invariant set  $S$  in  $\mathbb{R}^3$ . The isolated invariant set  $S$  is isolated by a compact neighbourhood  $N$  and admits the attractor–repeller decomposition  $S = A \cup A^* \cup C(A^*, A)$  where the attractor  $A$  contains a unique fixpoint, a hyperbolic saddle with two stable directions and one unstable one; its dual repeller  $A^*$  contains also a unique fixpoint which is a hyperbolic saddle with one stable direction and two unstable ones. Furthermore there is a connecting orbit from  $A^*$  to  $A$ . We seek for a confirmation of this fact by the Conley index method. This situation is described in Figure 3.4. Note that neither  $A$  is an attracting fixpoint, nor  $A^*$  is a repelling fixpoint.

The following properties of an attractor–repeller pair are straightforward.

**Proposition 3.1.46.** *Let the set  $S$  be isolated invariant and suppose it admits an attractor–repeller decomposition  $(A, A^*)$ .*

1. Both sets  $A$  and  $A^*$  are isolated invariant.
2. The sets  $A$  and  $A^*$  are disjoint.

3. If  $A' \subset A$  is an attractor in  $A$ , then  $A'$  is also an attractor in  $S$  and the set  $A'^*$ , its dual repeller in  $S$ , fulfills  $A'^* \supset A^*$ .
4. If the set  $A$  is an attractor in  $S$ , then the dual attractor of its dual repeller  $A^*$  is  $A$  itself.

The Conley index theory is able to determine whether the set  $C(A^*, A)$  of heteroclinics from  $A^*$  to  $A$  is empty or not. The following is an attempt to answer this question.

**Theorem 3.1.47.** *Let  $S$  be an isolated invariant set admitting an attractor–repeller decomposition  $(A, A^*)$ . It holds*

$$C(A^*, A) = \emptyset \Rightarrow h(S) = h(A) \vee h(A^*)$$

where  $h(S)$ ,  $h(A)$ , and  $h(A^*)$  denotes the corresponding Conley indices.

In other words,  $h(S) \neq h(A) \vee h(A^*)$  implies the existence of a heteroclinic orbit from  $A^*$  to  $A$ .

*Proof.* Assume there is no connection between the set  $A^*$  and  $A$ . Then the set  $S$  is the disjoint union of the sets  $A$  and  $A^*$  and by proposition 3.1.19,  $h(S) = h(A^*) \vee h(A)$ .  $\square$

**Example.** Let us illustrate this theorem on Example 3.1.45. There we have an attractor–repeller decomposition  $(A; A^*)$  of  $S$ . Index pairs for the calculation of the indices can be found in Figure 3.5, though they rather illustrate the Definition 3.1.48 below. The reader is invited to compute the indices with more natural blocks. It holds

$$\begin{aligned} h(A) &= \Sigma^1 \\ h(A^*) &= \Sigma^2 \\ h(S) &= \bar{0} \neq \Sigma^1 \vee \Sigma^2 = h(A) \vee h(A^*). \end{aligned}$$

So we can conclude that there exists a connection between  $A^*$  and  $A$ .

The notion of attractor–repeller decomposition invites to define the notion of index triples, which allows to explore the relationship of the index of the main isolated invariant set and the indices of the attractor and repeller constituting its decomposition.

**Definition 3.1.48. Index triple**

Let  $S$  be an isolated invariant set admitting an attractor–repeller decomposition  $(A, A^*)$ . An index triple for this decomposition is a collection of three compact sets  $N_0 \subset N_1 \subset N_2$  such that

1. the pair  $(N_2, N_0)$  is an index pair for  $S$ ;

2. the pair  $(N_2, N_1)$  is an index pair for  $A^*$ ;
3. the pair  $(N_1, N_0)$  is an index pair for  $A$ .

**Proposition 3.1.49. Existence of index triple**

Let  $S$  be an isolated invariant set admitting an attractor–repeller decomposition  $(A, A^*)$ . Then there exist three compact sets  $N_0 \subset N_1 \subset N_2$  forming an index triple for the decomposition  $(A, A^*)$  of  $S$ .

*Proof.* The isolated invariant set  $S$  admits an index pair  $(N_2, N_0)$  by Theorem 3.1.13. We claim that there exists a compact neighbourhood  $U$  of the attractor  $A$  from which trajectories stay away from the dual repeller  $A^*$  as long as they remain in  $N_2$ ; i. e. there exists a constant  $\varepsilon > 0$  such that

$$\left. \begin{array}{l} x \in U \\ \varphi([0, t], x) \subset N_2 \end{array} \right\} \Rightarrow d(\varphi([0, t], x), A^*) > \varepsilon$$

This neighbourhood  $U$  allow to define the set  $Z$  of points  $y \in N_2$  through which a trajectory runs whose prehistory began in  $U$  and remained in  $N_2$  until it reaches  $y$  itself, i. e.

$$Z := \{y \in N_2 / \exists t > 0, \exists x \in U / \phi([0, t], x) \subset N_2, \phi(x, t) = y\}.$$

It is straightforward to verify that the set  $Z$  together with the exit set  $N_0$  constitute the compact set  $N_1 := N_0 \cup Z$  of an index pair  $(N_1, N_0)$  for the  $S$ –repeller  $A^*$ , so that the triple  $(N_2, N_1, N_0)$  is an index triple for the decomposition  $(A, A^*)$  of  $S$ .  $\square$

**Remark 3.1.50.** Let us formulate more precisely what we proved here. Given an index pair  $(N_2, N_0)$  for the isolated invariant set  $S$ , there exists for each attractor–repeller decomposition of  $S$  a set  $N_1$  such that  $(N_2, N_1, N_0)$  is an index triple for this decomposition. This will be crucial in the proof of existence of index filtrations (see 3.1.58 below).

**Example.** The Figure 3.5 shows the parts of an index triple for Example 3.1.45 that we follow in this paragraph. Here we set

$$N_2 := N,$$

$$N_1 := N_0 \cup Z.$$

Then  $N_0 \subset N_1 \subset N_2$  is an index triple for the considered decomposition.

Now we translate the Theorem 3.1.47 in terms of homology . This additional point of view gives a sufficient condition for the existence of heteroclinics. To this aim, the ‘topological’ inequality  $h(S) \neq h(A^*) \vee h(A)$  between pointed spaces will be reformulated in an algebraic way and reduces to the question of the triviality

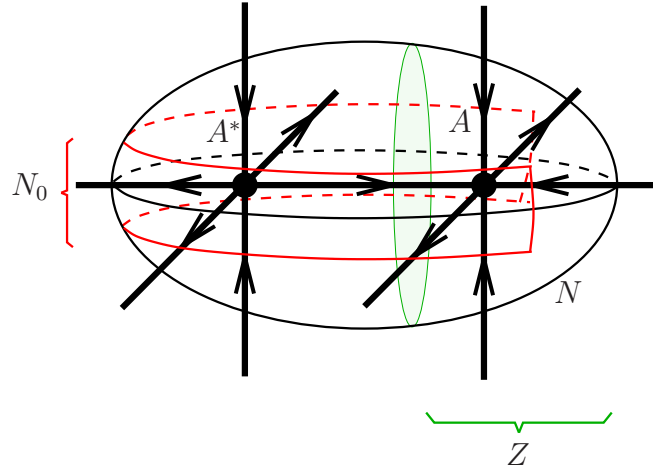

Figure 3.5: Construction of an index triple for Example 3.1.45.

of a linear map. It is important to be able to do this when the decomposition is more sophisticated than an attractor–repeller pair, in which case the topological algebraic structure keeps track of the inequalities between the Conley indices (see Theorem 3.1.63 in the next paragraph). Of course the price to pay is a loss of information in passing from the pointed spaces to their homology groups.

The existence of an index triple  $N_0 \subset N_1 \subset N_2$  for every attractor–repeller pair allows to construct the following long exact sequence (see for example [39] Theorem 4.8.5)

$$\begin{array}{ccccccc} \cdots & \longrightarrow & H_q(N_1, N_0) & \xrightarrow{i_*} & H_q(N_2, N_0) & \xrightarrow{j_*} & H_q(N_2, N_1) \xrightarrow{\delta(A^*, A)} H_{q-1}(N_1, N_0) \longrightarrow \cdots \\ & & = & & = & & = & & = \\ \cdots & \longrightarrow & H_q(A) & \xrightarrow{i_*} & H_q(S) & \xrightarrow{j_*} & H_q(A^*) \xrightarrow{\delta(A^*, A)} H_{q-1}(A) \longrightarrow \cdots \end{array}$$

The maps  $i_*$ ,  $j_*$  are induced by the inclusions  $i : (N_1, N_0) \hookrightarrow (N_2, N_0)$  and  $j : (N_2, N_0) \hookrightarrow (N_2, N_1)$  respectively. The linear map  $\delta(A^*, A) : H_*(A^*) \rightarrow H_*(A)$  is called the **connection map** and is in fact defined by the composition

$$H_q(N_2, N_1) \xrightarrow{\partial} H_{q-1}(N_1, \emptyset) \xrightarrow{j_{q-1}} H_{q-1}(N_1, N_0) \xrightarrow{\delta(A^*, A)}$$

where  $\partial$  is the boundary map furnished with the homology theory and the map  $j_*$  is induced by the inclusion  $j : (N_1, \emptyset) \hookrightarrow (N_1, N_0)$ . The connection map is of degree  $-1$  between the graded vector spaces  $H_*(A^*)$  and  $H_*(A)$ .

Note that, of course, the connection map does not depend on the choice of the index pairs used for the computation of the indices  $H_*(S)$ ,  $H_*(A^*)$  and  $H_*(A)$ , thanks to the homotopy invariance of homology theory. In particular,  $\delta(A^*, A)$  may be determined without an index triple but only with three index pairs for  $S$ ,  $A$  and  $A^*$ .

The introduction of the connection map allows to reformulate Theorem 3.1.47

in terms of homology.

**Theorem 3.1.51.** *Let  $S$  be an isolated invariant set admitting an attractor–repeller decomposition  $(A, A^*)$ . If the connection map  $\delta : H_*(A^*) \rightarrow H_*(A)$  defined by the long exact sequence of homology Conley indices*

$$\cdots \xrightarrow{\delta} H_q(A) \xrightarrow{i_*} H_q(S) \xrightarrow{j_*} H_q(A^*) \xrightarrow{\delta} H_{q-1}(A) \xrightarrow{i_*} \cdots$$

*is nontrivial, the set  $C(A^*, A)$  of heteroclinic connections from  $A^*$  to  $A$  is non empty.*

*Proof.* Assume that there exists no heteroclinics in  $S$  between the repeller  $A^*$  and the attractor  $A$ . Hence  $S$  is the disjoint union of  $A$  and  $A^*$ , and by Proposition 3.1.19 holds

$$H_*(S) = H_*(A) \oplus H_*(A^*).$$

Therefore the long exact sequence defining the connection map reads

$$\cdots \xrightarrow{\delta(A^*, A)} H_q(A) \xrightarrow{i_*} H_q(A) \oplus H_q(A^*) \xrightarrow{j_*} H_q(A^*) \xrightarrow{\delta(A^*, A)} H_{q-1}(A) \xrightarrow{i_*} \cdots$$

Obviously holds for the inclusion induced  $i_*$  and the projection  $j_*$  the following:

$$\begin{aligned} \ker(i_*) &= \{0\} & &= \operatorname{im}(\delta(A^*, A)) \\ \operatorname{im}(j_*) &= H_*(A^*) & &= \ker(\delta(A^*, A)) \end{aligned}$$

Thanks to the exactness of the sequence, the connection map  $\delta(A^*, A) : H_*(A^*) \rightarrow H_*(A)$  satisfies the right hand side of the previous equalities. In other words, the connection map is trivial.  $\square$

**Example.** For Example 3.1.45, the only non trivial part of the long exact sequence reads

$$\begin{array}{ccccccc} \cdots & \longrightarrow & H_2(S) & \xrightarrow{j_*} & H_2(A^*) & \xrightarrow{\delta} & H_1(A) \xrightarrow{i_*} H_1(S) & \cdots \\ & & = & & = & & = & = \\ & & \{0\} & & \mathbb{Z} & & \mathbb{Z} & \{0\} \end{array}$$

It holds  $\begin{cases} \{0\} = \operatorname{im}(j_*) = \ker(\delta) \\ \mathbb{Z} = \ker(i_*) = \operatorname{im}(\delta) \end{cases}$  such that  $\delta : \mathbb{Z} \rightarrow \mathbb{Z}$  is bijective.

The connection map is non trivial, hence a connection from  $A^*$  to  $A$  exists.

### 3.1.4 Morse decompositions and connection matrices

The connection matrix was introduced by Franzosa in [16]. Further important works on this subject are [28, 38, 17]. Let us sketch the main idea of this theory before we go into the details of the algebraic machinery. The connection matrix theory is used in situations where the isolated invariant set  $S$  is decomposed in several so called Morse sets (see precise definitions in the following). This Morse decomposition gives rise to an attractor filtration to which a collection

of connection maps is associated. In this paragraph we want to present a tool called connection matrix which collects only some of the connection maps arising. Afterwards, the interdependence of the connection maps may be exploited to reconstruct the missing information. The properties of the connection maps and the fact that they are not independent of each other imply for the connection matrices some quite restrictive rules on their structure. Those rules are reflected in the definition of the connection matrix by the axioms CM1–CM4 below. Using this concept, we are able to state the existence of heteroclinic orbits with few a priori information on the qualitative behaviour of the flow.

After this introduction, let us set the basic definitions.

**Definition 3.1.52. Morse decomposition**

Let the compact set  $S$  be an isolated invariant set. A finite collection  $\mathcal{M} = \{M(p), p \in P\}$  of disjoint compact invariant subsets of  $S$  is called a Morse decomposition of  $S$  if the set  $P$  is furnished with a partial order  $<$  in such a way that for every  $x \in S$  either

1.  $x \in M(p)$  for some  $p \in P$ , or
2. there exists two elements  $p < p^* \in P$  with  $\omega(x) \subset M(p)$  and  $\alpha(x) \subset M(p^*)$ .

The partial order  $<$  on  $P$  is called admissible. The sets  $M(p), p \in P$ , are called Morse sets.

In other words one has to be able to order the Morse sets such that trajectories only run downhill and do not build heteroclinic cycles.

For example a potential or an energy function decreasing along trajectories provides a Morse decomposition. The admissible ordering is given by the energy levels. There are also situations where a discrete Lyapunov function provides a Morse decomposition. Think for example of the map which associates to each solution of a partial differential equation its number of zeros. Under certain assumptions, Sturm theory guarantees that this zero number is dropping with time. When considering heteroclinic between two equilibria of such a PDE, there are only possible if the zero number of the outgoing equilibrium is higher than the zero number of the incoming equilibrium. In other cases, one makes use of the lap number instead of the zero number. For more details, we refer to [5, 6].

Given a Morse decomposition  $\mathcal{M}$ , the flow itself defines a natural partial order on  $P$ : one can define the relation  $\prec$  on  $P$  by the following. It holds  $p \prec p^*$  if and only if an orbit runs from  $M(p^*)$  to  $M(p)$ . This partial order is the smallest (i. e. with the least number of comparisons) admissible partial order on  $P$ . However this order is not known in general. More realistic is a situation where a stronger order is known, for example from a Lyapunov function, and the natural flow induced order is the one we are looking for. For that, one has to sort out the relations  $p < p^*$  where there is no actual orbit from  $p^*$  to  $p$  (i. e.  $p \not\prec p^*$ ).

An important example of Morse decomposition is the attractor–repeller decomposition: this is a Morse decomposition with only two Morse sets.

Let us collect some properties of the Morse sets.

**Proposition 3.1.53.** *Let the compact set  $S$  be an isolated invariant set admitting a Morse decomposition  $\mathcal{M} = \{M(p), p \in P\}$ . Then the following holds.*

1. *The Morse sets  $M(p)$  are isolated invariant.*
2. *The set  $S$  is the union of the sets  $M(p)$  together with the sets of heteroclinics  $C(p', p)$ ,  $p, p' \in P$  from  $M(p')$  to  $M(p)$ , i. e.*

$$S = \left( \bigcup_{p \in P} M(p) \right) \cup \left( \bigcup_{p' > p \in P} C(p', p) \right).$$

From a given Morse decomposition, cruder ones can be obtained by aggregating several Morse sets in a way that does not violate the no–cycle condition of the partial order. This is done in the following definition and proposition.

**Definition 3.1.54. Interval**

Let  $\mathcal{M} = \{M(p), p \in P, <\}$  be a Morse decomposition of an isolated invariant set  $S$ . A subset  $I$  of  $P$  is called an interval if and only if for all  $p, p^* \in I$  and all  $p' \in P$ , holds

$$p < p' < p^* \Rightarrow p' \in I.$$

An interval  $I$  is called attracting if for all  $p \in I$  and  $p' \in P$ , the relation  $p' < p$  implies  $p' \in I$

**Proposition 3.1.55.** *Let  $\mathcal{M} = \{M(p), p \in P, <\}$  be a Morse decomposition of an isolated invariant set  $S$  let and the subset  $I \subset P$  be an interval. We define  $M(I) := \left( \bigcup_{p \in I} M(p) \right) \cup \left( \bigcup_{p < p^* \in I} C(p^*, p) \right)$ , where  $C(p^*, p)$  denotes the set of connecting orbits from  $M(p^*)$  to  $M(p)$ . Then the collection  $\mathcal{M}_I := \{M(p), p \in P \setminus I, <\} \cup \{M(I)\}$  furnished with the partial order induced by  $<$  is a Morse decomposition of  $S$ .*

This proposition is not true if  $I$  is not an interval. The construction of several cruder Morse decompositions is crucial in the connection matrix theory: each of them is easier to understand, and the connection matrix puts all the information together.

As we saw before, the crudest Morse decomposition is an attractor–repeller decomposition. Given a Morse decomposition, one can in general aggregate the Morse sets in several ways to get an attractor–decomposition, i. e. a collection of two Morse sets. In fact for each attracting interval  $I$ , the set  $I^* := P \setminus I$  is also an interval and  $(M(I), M(I^*))$  is an attractor–repeller pair.

A last important notion in the context of Morse decomposition is the one of adjacent intervals:



**Definition 3.1.56. Adjacent intervals**

Let  $\mathcal{M} = \{M(p), p \in P, >\}$  be a Morse decomposition of an isolated invariant set  $S$ . Two intervals  $I, J \subset P$  are called adjacent if and only if their union  $I \cup J$  is an interval itself.

**Remark 3.1.57.** We will often abbreviate the union  $I \cup J$  with  $IJ$ . For example we may write  $M(IJ)$  for the amalgamated Morse set  $M(I \cup J)$ , or even  $\delta(IJ, K) : H_*(IJ) \rightarrow H_*(K)$  for the connection map between  $H_*(M(IJ))$  and  $H_*(M(K))$ , omitting  $M(\cdot)$  in the notation where this cannot generate confusion.

Now that we have defined the important concepts concerning Morse decompositions, we want to replace them in the context of Conley index and connection matrix theory. To compute the Conley index of a single Morse set, one needs an index pair (see Definition 3.1.9). To compute the indices and the connection map in an attractor–repeller decomposition, one needs an index triple (see Definition 3.1.48). In a more sophisticated Morse decomposition, each attracting interval gives rise to an attractor–repeller decomposition. Here again, one has to choose the index pairs appropriately to fit with this so called attractor filtration: this is the choice of an index filtration, defined below in 3.1.58.

**Definition 3.1.58. Index filtration**

An index filtration for a Morse decomposition  $\mathcal{M} = \{M(p), p \in P, >\}$  of an isolated invariant set  $S$  is a collection of compact sets  $\mathcal{N} = \{N(I), I \subset P \text{ attracting interval}\}$  satisfying

1. For each attracting interval  $I \subset P$ , the pair  $(N(I), N(\emptyset))$  is an index pair for  $M(I)$ .
2. For every adjacent pair of intervals  $I, J \subset P$ ,

$$N(I) \cap N(J) = N(I \cap J),$$

$$N(I) \cup N(J) = N(I \cup J).$$

The question to ask is about the existence of such an index filtration for each Morse decomposition. The answer is positive and goes back to Franzosa and Mischaikow [17]. We sketch a part of the proof in the following.

**Theorem 3.1.59.** *Given a Morse decomposition of an isolated invariant set, there exists an index filtration for this decomposition.*

*Proof.* Let  $S$  be an isolated invariant set admitting a Morse decomposition  $\mathcal{M} = \{M(p), p \in (P, >)\}$ . We want to construct an index filtration  $\{N(I), I \subset P \text{ attracting interval}\}$ . As  $S$  is isolated invariant, it admits an index pair  $(N_1, N_0)$  according to Theorem 3.1.13. Furthermore, for every attracting interval  $I \subset P$ , the pair  $(M(I), M(P \setminus I))$  is an attractor–repeller decomposition of  $S$ . By Proposition 3.1.49 there exists

an index triple for this decomposition. A closer look at the proof of Proposition 3.1.49 ( see Remark 3.1.50) shows that for each attracting interval  $I$  an index triple of the form  $(N_1, N_I, N_0)$  may be chosen, letting the biggest compact and the smallest compact of the triple independent on the choice of  $I$ . The compact sets  $N_I$  do not have to fulfill the requirements of the definition of an index filtration, but allow to construct sets  $N(I)$  which do so.

For all  $p \in P$  and a fixed attracting interval  $I$  we have

$$\begin{aligned} p \in I &\Rightarrow M(p) \subset \text{int}(N_I \setminus N_0) \text{ as } \text{cl}(N_I \setminus N_0) \text{ isolates } M(I) \supset M(p). \\ p \notin I &\Rightarrow M(p) \subset \text{int}(N_1 \setminus N_I) \text{ as } \text{cl}(N_1 \setminus N_I) \text{ isolates } M(P \setminus I) \supset M(p). \end{aligned}$$

Hence for each fixed  $p \in P$ , the set  $D_p$  defined by

$$D_p := \left( \bigcap_{I \text{ attracting, } p \in I} \text{int}(N_I \setminus N_0) \right) \cap \left( \bigcap_{I \text{ attracting, } p \notin I} \text{int}(N_1 \setminus N_I) \right),$$

is an open neighbourhood of the set  $M(p)$ . We define

$$E_p := \{x \in N_1 / \exists t > 0 / \phi(t, x) \in D_p \text{ and } \phi([0, t], x) \subset N_1\},$$

which is open and contains the neighbourhood  $D_p$  of  $M(p)$ . Now the compact sets  $N(I)$  of the index filtration are defined for every attracting interval  $I \subset P$ ,  $I \neq P, \emptyset$ , as

$$N(I) := N_1 \setminus \left( \bigcup_{p \in P \setminus I} E_p \right),$$

and further we rename  $N_1$  and  $N_0$  as

$$N(P) := N_1, N(\emptyset) := N_0.$$

It remains to prove that the pair of compact sets  $(N(I), N(\emptyset))$  is an index pair for  $M(I)$ . This is rather technical and can be read in [17]. Finally, the intersection and union properties are straightforward from the definition:

$$\begin{aligned} N(I) \cap N(J) &= N_1 \cap \left( \bigcup_{p \in P \setminus I} E_p \right)^c \cap \left( \bigcup_{p \in P \setminus J} E_p \right)^c \\ &= N_1 \cap \left( \bigcap_{p \in P \cap (I^c \cup J^c)} E_p^c \right) \\ &= N_1 \setminus \left( \bigcup_{p \in P \setminus (I \cap J)} E_p \right) \\ &= N(I \cap J) \end{aligned}$$

and similarly

$$\begin{aligned}
N(I) \cup N(J) &= N_1 \cap \left( \left( \bigcup_{p \in P \setminus I} E_p \right)^c \cup \left( \bigcup_{p \in P \setminus J} E_p \right)^c \right) \\
&= N_1 \cap \left( \bigcap_{p \in P \cap (I^c \cap J^c)} E_p^c \right) \\
&= N_1 \setminus \left( \bigcup_{p \in P \setminus (I \cup J)} E_p \right) \\
&= N(I \cup J)
\end{aligned}$$

□

The Definition 3.1.58 of an index filtration seems a priori to provide index pairs only for amalgamated Morse sets of attracting intervals  $M(IJ)$ . The following proposition shows that the index filtration in fact is designed to provide index pairs for all Morse sets - amalgamated or not.

**Proposition 3.1.60.** *Let  $\mathcal{N} = \{N(I), I \subset P \text{ attracting interval}\}$  be an index filtration. For every interval  $K \subset P$ , there exist attracting intervals  $I, J \subset P$  such that the pair of compacts  $(N(I), N(J))$  is an index pair for  $M(K)$ .*

*Proof.* The intervals  $I, J$  have to be chosen in such a way that their difference is  $K$ . In other words, choose  $I, J$  such that  $(M(J), M(K))$  is an attractor–repeller decomposition of  $M(I)$ . Then  $(N(I), N(J))$  is an index pair for  $M(K)$ :

1. The isolation of  $M(K)$  by  $cl(N(I) \setminus N(J))$  is given by the following: let us first recall the decomposition of  $M(I)$  into three parts  $M(I) = M(J) \cup M(K) \cup C(K, J)$  the set  $M(K)$  is the maximal invariant set  $Inv(cl(N(I) \setminus N(J)))$ , because the points of  $M(I)$  leaving  $M(K)$  go to  $M(J)$ . Furthermore the set  $M(K)$  lies in the interior of  $cl(N(I) \setminus N(J))$  because it is a subset of  $M(I) \subset int(cl(N(I) \setminus N(\emptyset)))$  and cannot have any common point with the boundary of  $N(J)$ .
2. Positive invariance of  $N(J)$  with respect to  $N(I)$ : if a trajectory begins in  $N(J)$  and stay for a positive amount of time in  $N(I)$ , it cannot leave  $N(J)$  without passing through its exit set  $N(\emptyset)$ , because of  $(N(J), N(\emptyset))$  being an index pair for  $M(J)$ . But, as this trajectory is supposed to stay in  $N(I)$ , it has to stay in  $N(\emptyset)$  because of the positive invariance of  $N(\emptyset)$  with respect to  $N(I)$ , as  $(N(I), N(\emptyset))$  is an index pair for  $M(I)$ . As  $N(\emptyset) \subset N(J)$ , the trajectory will not actually be able to leave  $N(J)$  without leaving  $N(I)$ .
3. Finally,  $N(J)$  is an exit set for  $N(I)$ , because  $N(\emptyset)$  is an exit set for  $N(I)$  and  $N(\emptyset) \subset N(J)$ .

□

Let us illustrate the interdependence of the various connection maps in a simple situation, following [28]. We consider a totally ordered Morse decomposition consisting of three Morse sets  $\{M(p), p = 1, 2, 3\}$  with  $1 < 2 < 3$ . This case is the easiest Morse decomposition after the attractor–repeller decomposition. As in the proof of Proposition 3.1.60, we consider triples  $(I, J, K)$  of intervals of  $\{1, 2, 3\}$  where  $(J, K)$  is an attractor–repeller decomposition of  $I$ . There are four of them:

- 123 decomposes in (1, 23)
- and in (12, 3)
- 12 decomposes in (1, 2)
- 23 decomposes in (2, 3)

The four long exact sequences defining the connection maps for those four attractor–repeller pairs are interacting in the following braid diagram:

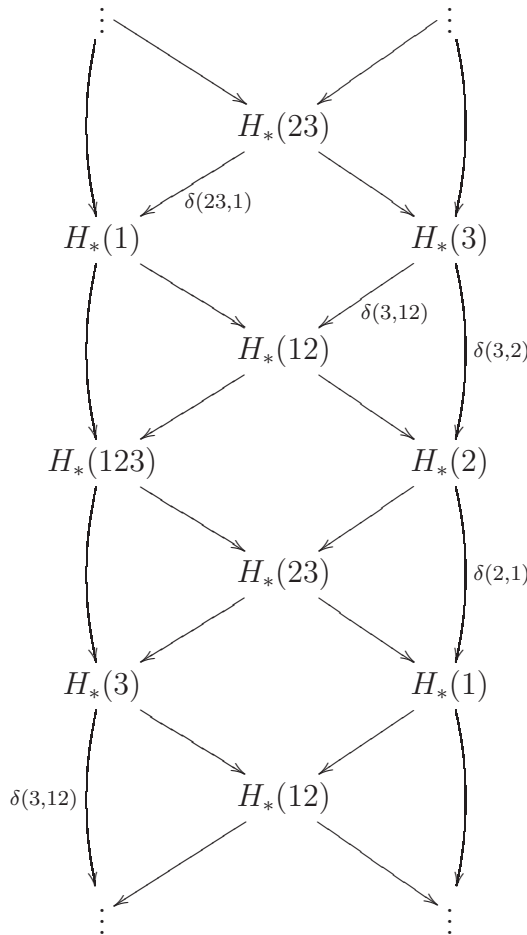

In fact this braid diagram contains all the information on the structure of connections in the Morse decomposition that one can extract with algebraic topology: six homology indices ( $H_*(1), H_*(2), H_*(3), H_*(12), H_*(23), H_*(123)$ ) and four connection maps ( $\delta(1,2), \delta(2,3), \delta(1,23), \delta(12,3)$ ). The connection matrix will condense this information in three homology indices and three "connection maps".

Before we define properly the connection matrix, let us discuss its entries in this example. A connection matrix is a map  $\Delta : V \rightarrow V$  where  $V$  is the graded vector space defined by the direct sum of the homological indices of the single Morse sets:  $V := H_*(1) \oplus H_*(2) \oplus H_*(3)$ . This map is of degree  $-1$ , i. e. the image of an element  $v = \alpha + \alpha' + \alpha'' \in V$ , with  $\alpha \in H_n(1), \alpha' \in H_n(2), \alpha'' \in H_n(3)$  is an element  $w = \beta + \beta' + \beta'' \in V$  with  $\beta \in H_{n-1}(1), \beta' \in H_{n-1}(2)$  and  $\beta'' \in H_{n-1}(3)$ .

This map  $\Delta$  can be interpreted as a matrix from the following point of view.

For each  $n \in \mathbb{N}$  the map

$$\Delta_n : H_n(1) \oplus H_n(2) \oplus H_n(3) \rightarrow H_{n-1}(1) \oplus H_{n-1}(2) \oplus H_{n-1}(3)$$

is a matrix as soon as bases are fixed for the homology vector spaces involved. In other words, the fact that the homology is a graded vector space gives the matrix  $\Delta$  some depth. Furthermore  $\Delta$  is an ordinary matrix in the case that the  $H_n(p)$ 's are one-dimensional in some degree and trivial in the others - as it happens if the Morse sets are all hyperbolic fixpoints.

Let us describe here the obvious entries of  $\Delta$  for our example with three Morse sets and how the map  $\Delta : V \rightarrow V$  condenses the information contained in the previous braid diagram.

- As we will see in its formal definition, the connection matrix is upper triangular with respect to the ordering of the Morse decomposition. This ordering allows only trajectories running downhill from a higher Morse set to a lower. The entries  $\Delta(p, q)$  with  $q > p$  are zero, reflecting those "forbidden" trajectories.
- Furthermore, the entries  $\Delta(2, 1)$  and  $\Delta(3, 2)$  are the connection maps  $\delta(2, 1)$  and  $\delta(3, 2)$  respectively, arising from two of the four long exact sequences appearing in the braid diagram.

Taking those remarks into account, the connection matrix takes the following form:

$$\Delta = \begin{bmatrix} 0 & \delta(2, 1) & ? \\ 0 & 0 & \delta(3, 2) \\ 0 & 0 & 0 \end{bmatrix}$$

We are now able to check the equality  $\Delta^2 = 0$ , essential for  $\Delta$  being a boundary map. The entry  $\Delta(3, 1)$ , i. e. the question mark in the above matrix, does not play a role in the calculation of  $\Delta^2$ . In this example, the only entry of  $\Delta^2$  which is not obviously zero is the one in the upper right corner  $\Delta^2(3, 1) = \delta(3, 2)\delta(2, 1)$ . The braid diagram which is commutative shows that this composition is equal to the composition of four maps, two of them being successive maps in a long exact sequence so that their composition is trivial. So at last the entry  $\Delta^2(3, 1)$  of  $\Delta$  is trivial.

The two known entries enable us to reconstruct some information which, a priori, does not appear in the matrix. The lower diagonal block

$$\Delta(23) := \Delta|_{H_*(2) \oplus H_*(3)} = \begin{bmatrix} 0 & \delta(3, 2) \\ 0 & 0 \end{bmatrix}$$

is of degree  $-1$  and has obviously the property that  $\Delta(23)^2 = 0$ . Hence it is a boundary map and induces itself a graded homology vector space  $H\Delta_*(23) := \frac{\ker \Delta(23)}{\text{im} \Delta(23)}$ . This "artificial" homology vector space is required by the definition of

the connection matrix (axiom CM3) to be isomorphic to the “real” one  $H_*(23)$ . In a similar way the diagonal bloc  $\Delta(12)$  enables to recover the homology index  $H_*(12)$ .

It remains to recover  $H_*(123)$  and the connection maps  $\delta(3, 12)$  and  $\delta(23, 1)$ . This requires to fill up the entry  $\Delta(1, 3)$  properly to make it possible. The Theorem 3.1.62 guarantees that there is a good choice for  $\Delta(1, 3)$ . Once this choice has been done and the entry  $\Delta(3, 1)$  is filled up, the homology space  $H_*(123)$  is recovered up to isomorphy through  $H\Delta_*(123) := \frac{\ker\Delta}{\text{im}\Delta}$  by Axiom CM3 of the definition of connection matrix 3.1.61. The two blocks

$$\left[ \begin{array}{cc} \delta(2, 1) & \Delta(3, 1) \end{array} \right] =: \Delta(23, 1) : H_*(2) \oplus H_*(3) \rightarrow H_*(1)$$

and

$$\left[ \begin{array}{c} \Delta(3, 1) \\ \delta(3, 2) \end{array} \right] =: \Delta(3, 12) : H_*(3) \rightarrow H_*(1) \oplus H_*(2)$$

induce the following maps on homology:

$$\begin{aligned} \bar{\Delta}(23, 1) : H\Delta_*(23) &\rightarrow H\Delta_*(1) = H_*(1) \\ [v] \in \frac{\ker\Delta(23)}{\text{im}\Delta(23)} &\mapsto [\Delta(23, 1)(v)] \in H\Delta_*(1) \\ \bar{\Delta}(3, 12) : H\Delta_*(3) = H_*(3) &\rightarrow H\Delta_*(12) \\ [v] \in H_*(3) &\mapsto [\Delta(3, 12)(v)] \in \frac{\ker\Delta(12)}{\text{im}\Delta(12)} \end{aligned}$$

Last we see that Axiom CM4 of the Definition 3.1.61 of a connection matrix was designed to enable the recovering of the connection maps  $\delta(23, 1) : H_*(23) \rightarrow H_*(1)$  and  $\delta(3, 12) : H_*(3) \rightarrow H_*(12)$  through the following commutative diagrams:  $H\Delta_*(23) \xrightarrow{\bar{\Delta}(23,1)} H\Delta_*(1)$  and  $H\Delta_*(3) \xrightarrow{\bar{\Delta}(3,12)} H\Delta_*(12)$  respectively.

$$\begin{array}{ccc} \begin{array}{ccc} \approx \downarrow & & \downarrow id \\ H_*(23) & \xrightarrow{\delta(23,1)} & H_*(1) \end{array} & & \begin{array}{ccc} id \downarrow & & \downarrow \approx \\ H_*(3) & \xrightarrow{\delta(3,12)} & H_*(12) \end{array} \end{array}$$

Now let us give the formal definition of a connection matrix and its existence theorem.

### Definition 3.1.61. Connection matrix

Let  $M = \{M(p), p \in P\}$  be a Morse decomposition of an isolated invariant set  $S$ , with partial ordering  $>$  of  $P$ . Let the graded vector space  $V := \bigoplus_{p \in P} H_*(M(p))$  be the direct sum of the homological Conley indices of the Morse sets. A map  $\Delta : V \rightarrow V$  is called a connection matrix if and only if it fulfills the following four axioms CM1–CM4:

- **CM1:** The map  $\Delta$  is a boundary map, i. e.  $\Delta$  is a linear map of degree  $-1$  with  $\Delta^2 = 0$ .
- **CM2:** The map  $\Delta$  is upper triangular with respect to the partial ordering; that is the entry  $\Delta(p, q)$  is trivial unless  $p > q$ .

- **CM3:** For each interval  $I$  there is an isomorphism  $\Phi(I) : H\Delta(I)_* \rightarrow H_*(I)$ , where  $\Delta(I)$  is the diagonal bloc  $\Delta(I) : \bigoplus_{p \in I} H_*(M(p)) \rightarrow \bigoplus_{p \in I} H_*(M(p))$ , and  $H\Delta_*(I)$  is the artificial homology group with respect to the boundary map  $\Delta(I)$ , i. e.  $H\Delta(I)_* := \frac{\ker \Delta(I)}{\text{im} \Delta(I)}$ . Moreover if  $I = \{p\}$  for some  $p \in P$ , then  $\Phi(I) = id$ .
- **CM4:** For each adjacent pair of intervals  $(I, J)$  the following diagram commutes

$$\begin{array}{ccccccc}
\cdots & \longrightarrow & H\Delta_n(J) & \longrightarrow & H\Delta_n(IJ) & \longrightarrow & H\Delta_n(I) \xrightarrow{\bar{\Delta}(I,J)} H\Delta_{n-1}(J) \longrightarrow \cdots \\
& & \downarrow \Phi(J) & & \downarrow \Phi(IJ) & & \downarrow \Phi(I) & & \downarrow \Phi(J) \\
\cdots & \longrightarrow & H_*(J) & \longrightarrow & H_*(IJ) & \longrightarrow & H_*(I) \xrightarrow{\delta(I,J)} H_*(J) \longrightarrow \cdots
\end{array}$$

where the following notation is used. The map  $\Delta(I, J)$  is the submatrix of  $\Delta$  consisting of the entries  $\Delta(p, q)$  for  $p \in I$  and  $q \in J$ , and the map  $\bar{\Delta}(I, J)$  is its induced map on homology (i. e. if  $v \in H_*(I)$  is a representant of a homology class  $[v] \in H\Delta(I)_* := \frac{\ker \Delta(I)}{\text{im} \Delta(I)}$ , then  $\bar{\Delta}(I, J)([v]) := [\Delta(I, J)(v)] \in H\Delta(J)_* := \frac{\ker \Delta(J)}{\text{im} \Delta(J)}$

Let us make a few explicative comments about this definition. First of all the general idea of this definition is to require that the connection matrix  $\Delta$  defined on the direct sum of the homological Conley indices of the single Morse sets condenses all the algebraic structures of all long exact sequences for all amalgamated Morse sets.

Let us have a closer look at each axiom: The Axiom CM1 reflects the fact that the connection maps  $\delta(p, q) : H_*(p) \rightarrow H_*(q)$  are boundary maps and generalizes this for  $\Delta$  - and hence for all diagonal blocks of  $\Delta$ . This will be crucial to be able to define the artificial homology groups showing up in axioms CM3 and CM4.

The Axiom CM2 translate the fact that trajectories run only downhill along the partial order on  $P$ .

The Axiom CM3 guarantees the isomorphy of the artificial homology groups  $H\Delta_*(I)$  arising from the boundary map  $\Delta(I)$  on  $\bigoplus_{p \in I} H_*(p)$  with the original homological Conley indices of amalgamated Morse sets  $H_*(I)$ .

Not only the indices of the amalgamated Morse sets are encrypted in  $\Delta$ , but also the whole algebraic connection structure given by all the connection maps arising in long exact sequences generated by the attractor–repeller decompositions. This property is the requirement of axiom CM4.

These complicated requirements on the map  $\Delta : V \rightarrow V$  make it hard to believe in its existence. However, Franzosa was able to prove the following theorem in [16].

**Theorem 3.1.62. Existence of a connection matrix**

*For each Morse decomposition  $\{M_p, p \in P, <\}$  of an isolated invariant set  $S$ , there exists a connection matrix  $\Delta : \bigoplus_{p \in P} H_*(p) \rightarrow \bigoplus_{p \in P} H_*(p)$  satisfying the four conditions (CM1)-(CM4).*

If the existence of the connection matrix is provided, it is not the case for its uniqueness, except for some special cases (for instance Morse decomposition with only hyperbolic equilibria as proved by Reineck in [32]).

Roughly speaking, nontrivial diagonal blocks in a connection matrix detect the existence of heteroclinics between the corresponding aggregated Morse sets. For example holds more precisely the following for adjacent Morse sets.

**Theorem 3.1.63. Existence of heteroclinics in a Morse decomposition**

*Consider a flow  $\varphi$  admitting a Morse decomposition  $\mathcal{M} = \{M(i), i \in P, >\}$ . If  $i > j \in P$  are adjacent and there exists a connection matrix  $\Delta : \bigoplus_{i \in P} H(i) \rightarrow \bigoplus_{i \in P} H_*(i)$  so that the entry  $\Delta(i, j)$  is non trivial, then there is an heteroclinic orbit connecting the Morse set  $M(i)$  to the Morse set  $M(j)$ .*

The foundation of the concept of Morse decomposition for a flow on a compact metric space is based on a result by Charles Conley himself [11] telling, roughly speaking, that a flow is gradient-like up to chain recurrence part. The precise definition of the chain recurrence set is given in 3.1.64 below. Conley proves the existence of a Lyapunov function which is strictly decreasing outside of the chain recurrence set and nonincreasing within it. Hence, if each connected component of the chain recurrent set is collapsed to a point, the resulting flow is gradient-like. Furthermore the Lyapunov functions provides a partial ordering for a Morse decomposition consisting of the several equilibria alias the collapsed connected components of the chain recurrence set. In this sense, the existence of a Morse decomposition is nothing extraordinary. However, the knowledge about the connected components of the chain recurrent set may be difficult to acquire.

The existence proof of the Lyapunov function is not constructive so that we do not know in general a Lyapunov function explicitly. This is the reason why we refer to it as ‘the abstract Lyapunov function’ as in the proofs of 3.1.29, 3.1.30 above. But let us introduce the precise settings. We consider a flow  $\varphi$  on a compact metric space  $X$ .

**Definition 3.1.64.** Given  $t > 0$  and  $\varepsilon > 0$ . A  $(\varepsilon, t)$ -chain from  $x \in X$  to  $y \in X$  is a finite collection of points  $(x_1 = x, \dots, x_{n+1} = y)$  and of times  $(t_1, \dots, t_n)$  with  $t_i \geq t$  such that for all  $1 \leq i \leq n$ , the distance from  $x_{i+1}$  to  $\varphi(t_i, x_i)$  satisfies

$$d(x_{i+1}, \varphi(t_i, x_i)) < \varepsilon.$$

The points  $x, y \in X$  are then said to be connected by an  $(\varepsilon, t)$ -chain.

The chain recurrent set  $R(\varphi)$  is the set of points  $x \in X$  which are connected to themselves by a recurrence chain.

$$R(\varphi) = \{x \in X / \exists \varepsilon, t > 0 \text{ and an } (\varepsilon, t)\text{-chain connecting } x \text{ to } x\}$$

**Remark 3.1.65.** The chain recurrent set contains the non wandering set, in particular it contains all equilibria and periodic orbits.



**Theorem 3.1.66.** *Consider a flow  $\varphi$  on a compact metric space  $X$ . There exists a function  $V : X \rightarrow \mathbb{R}$  with the following properties:*

1.  $V$  is nonincreasing along trajectories i. e.

$$\forall x \in X, t > 0, V(\varphi(t, x)) \leq V(x),$$

2.  $V$  is strictly decreasing outside of the chain recurrent set  $R(\varphi)$ , i. e.

$$\forall x \in X \setminus R(\varphi), t > 0, V(\varphi(t, x)) < V(x).$$

Collapsing each connected component of the chain recurrent set to one point allows to define the "gradient part" of the flow  $\varphi$ . Flows can be classified according to their gradient part, and Conley index theory cannot distinguish between flows having equivalent gradient part. For details see [11].

## 3.2 Conley index and heteroclines to infinity

We presented in the two first chapters of the present thesis two ways of compactifying a vector space and make infinity finite, hence accessible for the Conley index techniques. We want to present in this paragraph which kind of results can be expected in the cases where infinity is or contains an isolated invariant set. The two questions we want to ask and answer, are the following:

1. Are there trajectories running to (or coming from) infinity?
2. If the first question is answered by yes, from which (finite or infinite) part of the space are those trajectories coming from (or running to respectively)?

In other words we want both to clarify the existence of blow/grow up in forward or backward time, and to identify as precisely as possible the structure of heteroclines to infinity.

Before we address those questions in more details, let us make some elementary remarks about the compactified Conley index.

**Remark 3.2.1.** Consider a flow on the Bendixson sphere and assume that the north pole, alias the point at infinity, is isolated invariant. The Conley index of the point at infinity with respect to the flow on the Bendixson sphere is equal to the Conley index of the origin  $\xi = 0$  of the tangent space to the north pole with respect to the flow projected on this tangent space. In most of the cases we will compute the Conley index of infinity in the tangent space for simplicity.

Similarly for the Poincaré compactification, we will rather compute Conley indices of isolated invariant sets contained in the equator, alias the sphere at infinity, with help of the projected semi flows on tangent spaces to the equator - provided there exists a tangent space containing the whole isolated invariant set considered.

Under the assumption that infinity or parts of it are isolated invariant, we will always have the existence of orbits connecting to it - that is the point of theorem 3.6.1. We can formulate more precise statements as soon as the Conley index of infinity is known.

**Proposition 3.2.2.** *Consider a compactified flow on the  $n$ -dimensional Bendixson sphere for which the point at infinity is isolated invariant. There is no trajectory tending to the point at infinity in backward time direction if and only if*

$$h(\infty) = \Sigma^0,$$

*and in this case, there are trajectories tending to the point at infinity in forward time direction.*

*There are no trajectory tending to the point at infinity in backward time direction if and only if*

$$h(\infty) = \Sigma^n,$$

*and in this case there are trajectories tending to the point at infinity in backward time direction.*

*Finally if  $h(\infty) \neq \Sigma^0, \Sigma^n$ , then there are both trajectories tending to the point at infinity in forward time direction and trajectories tending to the point at infinity in backward time direction.*

*Proof.* The implication " $h(\infty) = \Sigma^0 \Rightarrow \infty$  attractor" is a consequence of 3.1.28. The converse uses the fact that we are able to construct an isolating block for the point at infinity which is retractable to a point. For this we make again use of the abstract Lyapunov function  $V$  of Theorem 3.1.66 which has a local minimum on the point at infinity. The sublevel set  $K := \{V \leq d\}$  for  $d - \min V > 0$  sufficiently small is an isolating block retractable to a point. The exit set  $K^-$  is empty, hence  $h(\infty) = \Sigma^0$ .

In the second case, an index equal to  $\Sigma^n$  implies that the point at infinity is a repeller by Proposition 3.1.30. The converse follows from the fact that the abstract Lyapunov function  $V$  admits a maximum at the point at infinity. The sublevel set  $K := \{V \geq d\}$  for  $\max V - d > 0$  sufficiently small is retractable to a point and its exit set is  $K^- = \partial K$ . Hence  $h(\infty) = \Sigma^n$ .

The third claim is a corollary of the previous. □

In the case of the Poincaré compactification, we can state the following theorem on the existence/non-existence of unbounded trajectories in forward or backward time direction.

**Theorem 3.2.3.** *Consider a compactified flow on the Poincaré hemisphere.*

- *If there exists an isolated invariant set  $A \subset \mathcal{E}$  in the sphere at infinity, whose Conley index is that of an attractor (see definition 3.1.39), then there are trajectories tending to  $A$  in forward time direction. Furthermore there are no trajectories tending to  $A$  in backward time direction.*

- *If there exists an isolating invariant set  $R \subset \mathcal{E}$  in the sphere at infinity, whose Conley index is that of a repeller, then there exist trajectories tending to  $R$  in backward time direction. Furthermore there are no trajectories tending to  $R$  in forward time direction.*
- *If there exists a nonempty isolated invariant set  $S \subset \mathcal{E}$  in the sphere at infinity, whose Conley index is whether that of an attractor nor that of a repeller, then there are trajectories tending to  $S$  in forward time direction, and trajectories tending to  $S$  in backward time direction.*

The proof is straightforward with 3.1.37 and 3.1.38. We differentiate in the original semi flow in the phase space  $X$  between trajectories having infinity as a limit in forward or backward finite or infinite time, and the full trajectories which remain bounded for all times. The union of those bounded trajectories is an invariant set. This leads to the following definition.

**Definition 3.2.4. Maximal bounded invariant set**

If the union of all full bounded trajectories is bounded, we denote it by

$$\mathcal{F} := \{x \in X / \exists \text{ full bounded trajectory through } x\}$$

and call it the maximal bounded invariant set.

Of course, this boundedness of the maximal invariant set is not always provided. The set  $\mathcal{F}$  is sometimes called "global attractor" in the literature. We avoid this name because it could lead to confusion in our context: the set  $\mathcal{F}$ , even when it exists, does not have to be an attractor in the sense that it attracts a neighbourhood of itself. Therefore we choose a longer but preciser name and denote it by the maximal bounded invariant set. This set, if it is isolated invariant, will play a very important role in section 3.5. But now let us first state some basic facts about heteroclinics to infinity.

**Remark 3.2.5.** We saw in definition 3.1.32 that the Conley index at the boundary  $\mathcal{E}$  of the Poincaré hemisphere  $\mathcal{H}$  has to take this boundary into account and splits into three components: the Conley indices with respect to  $\mathcal{H}$ , to  $\mathcal{H}$  and  $\mathcal{E}$ , and to  $\mathcal{E}$ . This fact has obviously consequences on the connection matrix theory: to describe the connections in a Morse decomposition of the whole Poincaré hemisphere, inclusively its boundary alias the sphere at infinity, we have to analyze three connection matrices, each of them collecting the information of one of the three indices quoted above. Those three matrices will be denoted by

$\Delta_{[\mathcal{H}]}$ , connection matrix with respect to  $\mathcal{H}$ ,

$\Delta_{[\mathcal{H}, \mathcal{E}]}$ , connection matrix with respect to  $\mathcal{H}$  and  $\mathcal{E}$ ,

$\Delta_{[\mathcal{E}]}$ , connection matrix with respect to  $\mathcal{E}$ . Let us have a closer look at which type of information may be provided by each of those three matrices.

The connection matrix  $\Delta_{[\mathcal{E}]}$  is defined on the direct sum of the homological Conley

indices of Morse sets with respect to the equator. Those are non trivial only for Morse sets intersecting the equator, and deals only with the dynamic along the equator  $\mathcal{E}$ , a sphere invariant under the flow. Hence the connection matrix  $\Delta_{[\mathcal{E}]}$  can only describe heteroclinic orbits running on the equator, alias infinity. At first sight, those orbits may seem artificial, because they do not exist as "real" orbits in the original phase space  $X$  before the compactification. However they are important in the description of asymptotic behaviours of "real" blowing/growing up/down orbits: in the flow projected on the Poincaré hemisphere those "real" exploding orbits follow the artificial ones in  $\mathcal{E}$  as they approach the equator  $\mathcal{E}$ , so that we know how the original "real" orbits approach infinity. This phenomenon is observed in the examples ... The information carried by the connection matrices  $\Delta_{[\mathcal{H}]}$  and  $\Delta_{[\mathcal{H},\mathcal{E}]}$  is less obvious to describe. For this let us consider again the example 3.1.36. There we consider hyperbolic equilibria sitting on the boundary of a manifold and computed their three Conley indices. We can summarize these results and interpret them for the Poincaré hemisphere in the following way: Consider a hyperbolic fix point  $p$  on the equator  $\mathcal{E}$  of the Poincaré hemisphere  $\mathcal{H}$ . The linearisation of the projected vector field at the point  $p$  admits  $n - 1$  directions spanning the tangent space  $T_p\mathcal{E}$  to the equator at  $p$ , and one eigendirection pointing to the interior of the Poincaré hemisphere. Furthermore let us assume that  $\{p\}$  is a Morse set in a Morse decomposition including finite isolated invariant sets and isolated invariant sets at infinity such as  $\{p\}$ . This Morse decomposition gives rise to the connection matrices  $\Delta_{\mathcal{H}}$ ,  $\Delta_{\mathcal{H},\mathcal{E}}$ ,  $\Delta_{\mathcal{E}}$ . We distinguish the following cases:

1. If the eigendirection pointing to the interior of the Poincaré hemisphere  $\mathcal{H}$  is stable, the Conley index with respect to  $\mathcal{H}$  and  $\mathcal{E}$  is trivial, and the Conley index with respect to  $\mathcal{H}$  carries all the information. This information shows up only in the connection matrix  $\Delta_{[\mathcal{H}]}$ .
2. On the contrary, if the eigendirection pointing to the interior of the Poincaré hemisphere is unstable, the Conley index with respect to  $\mathcal{H}$  is trivial and the Conley index with respect to  $\mathcal{H}$  and  $\mathcal{E}$  carries all the information. This information shows up only in the connection matrix  $\Delta_{[\mathcal{H},\mathcal{E}]}$ .
3. The Conley indices of the finite isolated invariant sets provide information both for the connection matrices  $\Delta_{[\mathcal{H}]}$  and  $\Delta_{[\mathcal{H},\mathcal{E}]}$ , but of course not for  $\Delta_{[\mathcal{E}]}$  as they do not intersect the equator  $\mathcal{E}$ .

These facts have the following consequences for the connection matrices:

The connection matrix  $\Delta_{\mathcal{H}}$  may be used to prove the existence of heteroclinic from a finite invariant set to the equilibrium at infinity  $p$ , but not the other way around. Similarly the connection matrix  $\Delta_{\mathcal{H},\mathcal{E}}$  may be used to detect heteroclinic connections from the equilibrium at infinity  $p$  to a finite isolated invariant set, but not the other way around. The reason for that is that a trivial Conley index

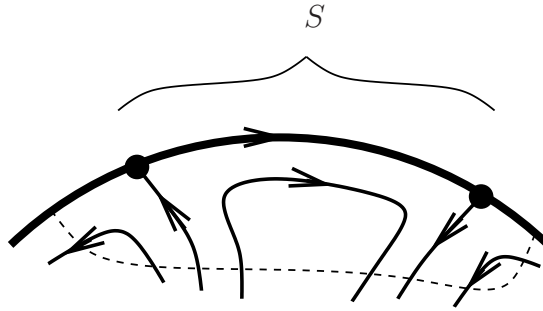

Figure 3.6: Isolated invariant set  $S$  at infinity with  $h(\mathcal{H}; S) \neq \bar{0}$  and  $h(\mathcal{H}, \mathcal{E}; S) \neq \bar{0}$ .

makes no contribution to the vector space we denoted by  $V$ , direct sum of the indices of the Morse sets, on which the connection matrices  $\Delta$  are defined - hence generates no information about heteroclinic connections.

For the same reason, an heteroclinic between two hyperbolic equilibria on the equator may be detected by  $\Delta[\mathcal{E}]$  if this heteroclinic lies on the equator. On the other hand, if this connection runs through the interior of the Poincaré hemisphere, whether  $\Delta_{\mathcal{H}}$  nor  $\Delta_{\mathcal{H}, \mathcal{E}}$  can detect it, because each of them contains only half the information.

Of course, as the isolated invariant set at infinity gets more complicated than a single hyperbolic equilibrium, the Conley indices with respect to  $\mathcal{H}$  and  $\mathcal{E}$  may both be non trivial, as we see on the figure 3.6, where an isolated invariant set  $S \subset \mathcal{E}$  is represented together with an isolating block  $N$  for  $S$ . The set  $S$  consists of two equilibria and a heteroclinic orbit between them on the sphere at infinity. Building the quotient spaces according to the definition 3.1.32 we get:

$$h(\mathcal{H}; S) = \Sigma^1,$$

$$h(\mathcal{H}, \mathcal{E}; S) = \Sigma^1,$$

$$h(\mathcal{E}; S) = \bar{0}.$$

However we conjecture that for a general isolated invariant set  $S \subset \mathcal{E}$  being a Morse set in a Morse decomposition,

1. the heteroclinics finite  $\rightarrow S$  may be detected by  $\Delta_{\mathcal{H}}$  but not by  $\Delta_{\mathcal{H}, \mathcal{E}}$ ,
2. the heteroclinics  $S \rightarrow$ finite may be detected by  $\Delta_{\mathcal{H}, \mathcal{E}}$  but not by  $\Delta_{\mathcal{H}}$ ,
3. the heteroclinics  $S' \rightarrow S$  for another isolated invariant Morse set  $S' \subset \mathcal{E}$ , may be detected by  $\Delta_{\mathcal{E}}$  if these heteroclinics run on the equator, but no heteroclinic  $S \rightarrow S'$  through the interior of the Poincaré hemisphere can be detected by connection matrices  $\Delta_{\mathcal{H}}$  or  $\Delta_{\mathcal{H}, \mathcal{E}}$ .

### 3.3 Some examples

Now let us consider the examples we saw before under the Conley index point of view. We shall compute the indices of the isolated invariant sets and give the connection matrices. [23]

**Example 3.3.1. The quadratic vector field 1.3.2 under Bendixson compactification.** The phase portrait is shown on figure 1.4. A Morse decomposition of the whole Bendixson sphere is given by

$M_2 = \{(1, 0)\}$ ,  $M_3 = \{(-1, 0)\}$  unstable equilibria,

$M_1 =$  homoclinic orbit to the point at infinity, stable,

where the partial order reads

$$1 < 2$$

$$1 < 3$$

The figure 3.7 shows an isolating bloc for the accumulated invariant set  $M_{13}$  whose exit set is empty. An isolating bloc for  $M_{12}$  is given by a similar bloc on the other side of the Bendixson sphere. Hence the homological Conley indices reads:

$$\begin{aligned} H_2(2) &= \mathbb{Z}_2, \\ H_2(3) &= \mathbb{Z}_2, \\ H_*(1) &: \begin{cases} H_1(1) = \mathbb{Z}_2 \\ H_0(1) = \mathbb{Z}_2 \end{cases}, \\ H_0(13) &= \mathbb{Z}_2, \end{aligned}$$

where the not mentioned homology groups  $H_k$  are trivial. The long exact sequence defining the connection map  $\delta(3, 1) : H_*(3) \rightarrow H_*(1)$  reads

$$\begin{array}{ccccccccccc} \cdots & \longrightarrow & H_2(1) & \longrightarrow & H_2(13) & \longrightarrow & H_2(3) & \xrightarrow{\delta} & H_1(1) & \longrightarrow & H_1(13) & \longrightarrow & \cdots \\ & & = & & = & & = & & = & & = & & \end{array}$$

$$\cdots \longrightarrow \{0\} \longrightarrow \{0\} \longrightarrow \mathbb{Z}_2 \xrightarrow{\delta} \mathbb{Z}_2 \longrightarrow \{0\} \longrightarrow \cdots$$

of the exactness of the sequence holds  $\ker \delta = \{0\}$  and  $\text{im} \delta = \mathbb{Z}_2$ , i. e. the connection map is non trivial.

Whereas the classical Conley index techniques worked out in the previous examples, there are a lot of examples where it will not be the case. To convince ourselves of this, we just have to take a look on figure 1.3: petals of homoclinic orbits appears at infinity and prevent isolation. Such examples are the motivation to create a new tool which is adapted to this frequent behaviour at infinity. This new tool will utilize the isolation of the complementary dynamic via the duality described in the next section.

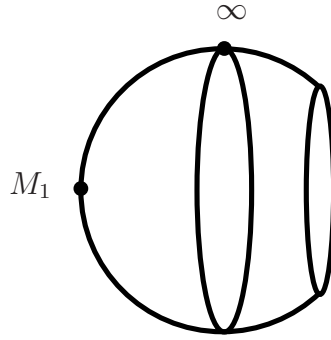
Figure 3.7: An isolating bloc for  $M_{13}$ .

### 3.4 Conley index and duality

In this section we will summarize the results of [29, 26] concerning time-duality for the Conley index. They consider a flow on a  $n$ -dimensional manifold with boundary  $M$ , and find out a duality between the indices with respect to the flow with original time and the indices with respect to the flow with reversed time direction (see theorem 3.4.2). This phenomenon can be seen very easily on the next example of a hyperbolic fix point. For the generalization to an arbitrary isolated invariant set, we have to pass to the homological/cohomological Conley index. Furthermore this duality is compatible with the structure of Morse decomposition and induces an isomorphism between the connection matrices. Our strategy, which we will develop in the next section, is to use this duality to define the Conley index of an invariant set of isolated invariant complement via the Conley index of its complement - for details see 3.5.

**Example 3.4.1.** We consider an hyperbolic fix point  $P \in \mathbb{R}^n$  with  $k$  unstable dimensions. Hence its Conley index with respect to the flow with original time direction is  $h_+(P) = \Sigma^k$ . With respect to the flow with reversed time direction, the fixpoint  $P$  has  $n - k$  unstable direction, hence its Conley index reads  $h_-(P) = \Sigma^{n-k}$ . Now it holds for the homological/cohomological Conley indices:

$$CH_-^m(P) = \begin{cases} \mathbb{Z}, & \text{for } m = k, \\ 0, & \text{for } m \neq k, \end{cases}$$

and

$$CH_m^+(P) = \begin{cases} \mathbb{Z}, & \text{for } m = n - k, \\ 0, & \text{for } m \neq n - k. \end{cases}$$

So the isomorphism  $CH_-^m(P) \cong CH_{n-m}^+(P)$  is clear in this case. We will see at next that it is also true in general.

**Theorem 3.4.2.** *If  $M$  is an orientable  $n$ -manifold with boundary,  $S \subseteq M$  an isolated invariant set for a  $C^1$  flow on  $M$ , then there exist duality isomorphisms*

$$\begin{aligned} D : CH_-^*(M, \partial M; S) &\rightarrow CH_*^+(M; S) \quad , \\ D : CH_-^*(M; S) &\rightarrow CH_*^+(M, \partial M; S) \quad . \end{aligned}$$

Further, if  $S \cap \partial M = \emptyset$ , both isomorphisms reduce to a single isomorphism

$$D : CH_-^*(M; S) \rightarrow CH_*^+(M; S).$$

The proof of this theorem is given in [26]. It uses the following Poincaré–Lefschetz duality theorem (see [12] VIII.7, or [39] 6.2).

**Theorem 3.4.3. Poincaré–Lefschetz duality**

*Let  $M$  be an orientable  $n$ -dimensional manifold, and  $L \subseteq K$  compact subsets of  $M$ . Furthermore we assume that the sets  $L$  and  $K$  are neighbourhood retracts. Then the following isomorphism holds:*

$$H^k(K, L) \cong H_{n-k}(M \setminus L, M \setminus K).$$

The proof of theorem 3.4.2 can be summarized into two steps involving algebraic topology:

- For a given index quadruple  $(N, N_0, N_1, N_2)$ , the Poincaré–Lefschetz duality provides isomorphisms coming from cap-products:  $\cap_{z_N} : H^k(N, N_0 \cup N_1) \rightarrow H_{n-k}(N, N_2)$  and  $\cap_{z_N} : H^k(N, N_1) \rightarrow H_{n-k}(N, N_0 \cup N_2)$ , where  $z_N \in H_n(N, \partial N)$  is the fundamental class of  $(N, \partial N)$ .
- The second step consists on proving the independence on the choice of the index quadruple. This is done by the following commutative diagram: there appear a second index quadruple  $(N', N'_0, N'_1, N'_2)$  with  $N' \subset N$  and homotopy equivalences  $\phi_-$  and  $\phi_+$  between the corresponding quotient spaces, which induce maps  $\phi_-^*$  and  $\phi_+^*$  between the homology/cohomology groups .

$$\begin{array}{ccccccc} H^k(N, N_0 \cup N_1) & \xleftarrow{\cong} & H^k(N/N_1, N_0/N_1) & \xleftarrow{\phi_-^*} & H^k(N'/N'_1, N'_0/N'_1) & \xrightarrow{\cong} & H^k(N', N'_0 \cup N'_1) \\ \downarrow \cap_{z_N} & & & & & & \downarrow \cap_{z_{N'}} \\ H_{n-k}(N, N_2) & \xrightarrow{\cong} & H_{n-k}(N/N_2) & \xrightarrow{\phi_+^*} & H_{n-k}(N'/N'_2) & \xleftarrow{\cong} & H_{n-k}(N', N'_2) \end{array}$$

**Theorem 3.4.4. The duality isomorphism commutes with attractor–repellers sequences.** *More precisely, if  $S$  is an isolated invariant set with attractor–repeller decomposition  $(A, A^*)$ , then the following diagrams commute:*



$$\begin{array}{ccccccc}
\cdots & \longrightarrow & CH_-^p(M, \partial M; A) & \longrightarrow & CH_-^p(M, \partial M; S) & \longrightarrow & CH_-^p(M, \partial M; A^*) \longrightarrow \cdots \\
& & \downarrow D & & \downarrow D & & \downarrow D \\
\cdots & \longrightarrow & CH_{n-p}^+(M; A) & \longrightarrow & CH_{n-p}^+(M; S) & \longrightarrow & CH_{n-p}^+(M; A^*) \longrightarrow \cdots
\end{array}$$

and

$$\begin{array}{ccccccc}
\cdots & \longrightarrow & CH_-^p(M; A) & \longrightarrow & CH_-^p(M; S) & \longrightarrow & CH_-^p(M; A^*) \longrightarrow \cdots \\
& & \downarrow D & & \downarrow D & & \downarrow D \\
\cdots & \longrightarrow & CH_{n-p}^+(M, \partial M; A) & \longrightarrow & CH_{n-p}^+(M, \partial M; S) & \longrightarrow & CH_{n-p}^+(M, \partial M; A^*) \longrightarrow \cdots
\end{array}$$

Furthermore the time duality isomorphism is compatible with connection matrices. As we will not make use of this property, we do not go into details here and refer to [29, 26].

### 3.5 The Conley index at infinity

The case of a linear differential equation where the origin is a hyperbolic fixpoint is easy and very well understood. However we saw in the first chapter that its behaviour at the point at infinity under Bendixson compactification is degenerate as soon as it is a saddle point, i. e. the linear operator  $A$  governing the equation  $u_t = Au$  admits eigenvalues of different signs. Indeed the trajectories which belong whether to the unstable eigenspace nor to the stable eigenspace are homoclinic to the point at infinity in the Bendixson compactification. Moreover each neighbourhood of the point at infinity contains some of those homoclinic trajectories. This fact prevents isolation of the point at infinity: The maximal invariant set contained in each compact neighbourhood  $N$  of the point at infinity contains at least one homoclinic with an internal tangency to the boundary. Our definition of the Conley index for the point at infinity should be able to apply to this basic case, and we will see that it does. Furthermore this simple case has provided the inspiration for a definition which includes more general invariant sets at infinity in the Poincaré compactification. Therefore we begin by the exposition of our new concept in the case of the Bendixson compactification. After showing the limitations of this choice of compactification, we introduce the concepts in the case of the Poincaré compactification which is the better choice in most of the applications.

#### 3.5.1 Under Bendixson compactification

In this paragraph we will consider the flow on the Bendixson sphere, unless otherwise expressly specified. We describe a construction allowing us to define

a Conley index of infinity in some cases where the classical requirements are not fulfilled. Our generalization is based on the concept of isolation of "the complement" which is defined as follows.

**Definition 3.5.1.** The north pole alias the point at infinity is called "of isolated complement" if there exists a compact subset  $K$  of the Bendixson sphere  $\mathcal{S}$  with the following properties:

1. The north pole is contained in the complement  $K^c$  of  $K$ ,
2. the compact set  $K$  is an isolating neighbourhood,
3. and every compact neighbourhood  $K'$  such that  $K \subset K'$  and  $\infty \notin K'$  is an isolating neighbourhood too.

If the point at infinity is of isolated invariant complement, then all the bounded dynamic is contained in a maximal bounded isolated invariant set, whose existence is set in the following proposition.

**Proposition 3.5.2.** *Let us consider a normalizable flow on a Hilbert space  $X$ . If the point at infinity in its Bendixson compactification is of isolated invariant complement, then the set  $\mathcal{F}$  defined as the union of all full globally bounded trajectories is compact, isolated invariant, and attracts all trajectories which are defined and globally bounded for all positive times.*

**Remark 3.5.3.** Some authors would call such a  $\mathcal{F}$  a global attractor. We do not because our point of view is that infinity attracts unbounded trajectory, hence  $\mathcal{F}$  does not contain the global dynamic that we want to describe. We choose to denote  $\mathcal{F}$  by "the maximal bounded invariant set" Furthermore we will use the notation  $\mathcal{F}$  for  $\mathcal{F} \subset X$  but also for its image under the Bendixson compactification, when no confusion is possible.

*Proof.* We assume that the point at infinity is of isolated invariant complement: there exists a compact neighbourhood  $K$  as in definition 3.5.1 with  $\infty \notin K$ . We claim that for every compact neighbourhood  $K'$  containing  $K$  such that  $\infty \notin K'$  holds  $Inv(K) = Inv(K')$ , i. e.  $K$  and  $K'$  isolate the same invariant set. Indeed if there is a compact neighbourhood  $K'$  containing  $K$  with  $\infty \notin K'$  but  $Inv(K) \subsetneq Inv(K')$  then it is possible to construct a compact set  $K''$  which contradicts the definition of the point at infinity being of isolated invariant complement. For this let us define

$$\begin{aligned} d_1 &:= \max_{x \in Inv(K')} d(x, K), \\ d_2 &:= d(Inv(K'), \infty), \\ K'' &:= K \cup \left( (Inv(K') \cup \bar{B}_{d_1}(K)) \cap \left( B_{\frac{d_2}{2}}(\infty) \right)^\infty \right), \end{aligned}$$

where  $d$  denotes the distance on the Bendixson sphere, the set  $\bar{B}_{d_1}(K)$  denotes a closed tubular neighbourhood around  $K$ , and the set  $B_{\frac{d_2}{2}}(\infty)$  an open ball around the point at infinity. Furthermore let  $x_1 \in \text{Inv}(K')$  be the point for which the distance  $d_1$  is reached. The set  $K''$  is a compact neighbourhood, contains  $K$  and does not contain the point at infinity. However, the point  $x_1 \in \text{Inv}(K')$  for which the maximal distance  $d_1$  to  $K$  is reached lies on the boundary of  $K''$ . It is easy to see that  $\text{Inv}(K') \subset K''$ , and therefore  $\text{Inv}(K') \subset \text{Inv}(K'')$ . Hence it holds  $x_1 \in \text{Inv}(K'') \cap \partial K''$ , which contradicts the fact that the point at infinity is of isolated invariant complement.

Now remains to prove that  $\mathcal{F} = \text{Inv}(K)$ , where  $\mathcal{F}$  is the union of all full globally bounded trajectories. The inclusion  $\mathcal{F} \supset \text{Inv}(K)$  is obvious. Suppose that  $\mathcal{F} \not\subset K$ . This means that there exists a  $x$  such that  $x \notin K$  and  $x$  admits a full bounded trajectory  $\sigma(x)$ . We repeat the previous construction with  $\text{Inv}(K')$  replaced by  $S := \sigma(x) \cup \text{Inv}(K)$  to produce a contradiction to the fact that the point at infinity is of isolated invariant complement. Hence we proved  $\mathcal{F} \subset K$ . As a consequence,  $\mathcal{F} = \text{Inv}(K)$  and  $\mathcal{F}$  is isolated invariant.

The  $\omega$ -limit set of every forward globally bounded trajectory is a full globally bounded trajectory which per definition is contained in  $\mathcal{F}$ . Therefore  $\mathcal{F}$  attracts all trajectories which are defined and globally bounded for all positive times.  $\square$

Now for practical use, the following equivalent definition may be easier to handle. This definition requires a continuous family of isolating neighbourhoods  $K_\lambda$  whose complement shrinks on the point at infinity.

**Proposition 3.5.4.** *The point at infinity is of isolated complement if and only if there exists a compact isolating neighbourhood  $K \subset \mathcal{S}$  and a continuous monotone retraction*

$$H : [0, 1] \times K^c \rightarrow K^c$$

from  $K^c$  to the point at infinity, i. e.

$$\begin{aligned} \forall x \in K^c & \quad , \quad H(0, x) = x, \\ \forall x \in K^c & \quad , \quad H(1, x) = \infty, \\ \forall \lambda \in [0, 1] & \quad , \quad H(\lambda, \infty) = \infty, \\ \forall \lambda < \mu \in [0, 1] & \quad , \quad H(\lambda, K^c) \supsetneq H(\mu, K^c), \end{aligned}$$

such that for all  $\lambda \in [0, 1[$ , the compact set  $K_\lambda := (H(\lambda, K^c))^c$  is an isolating neighbourhood.

*Proof.* First let us assume that the point at infinity is of isolated invariant complement. Then there exists a compact isolating neighbourhood  $K$  of the maximal bounded invariant set  $\mathcal{F}$ . Now set  $d := d(K, \infty)$  and define  $K' := \mathcal{S} \setminus B_{\frac{d}{2}}(\infty)$ , where  $B_{\frac{d}{2}}$  is the open ball of radius  $\frac{d}{2}$  around the point at infinity, the Bendixson sphere  $\mathcal{S}$  being equipped with the standard metric. By definition 3.5.1, the set  $K'$

is also an isolating neighbourhood for  $\mathcal{F}$ . We denote by  $P_{up} : \mathcal{S} \rightarrow X$  the upper chart of the Bendixson sphere, i. e. the projection on the tangent space to  $\mathcal{S}$  at the north pole alias the point at infinity, and define the following retraction of  $K'^c = B_{\frac{d}{2}}(\infty)$  on  $\{\infty\}$ :

$$\begin{aligned} H(\lambda, x) : [0, 1] \times B_{\frac{d}{2}} &\rightarrow B_{\frac{d}{2}} \\ x &\mapsto P_{up}^{-1}((1 - \lambda)P_{up}(x) + \lambda P_{up}(\infty)) \end{aligned}$$

The family  $K_\lambda := (H(\lambda, K'^c))^c = \mathcal{S} \setminus B_{\frac{(1-\lambda)d}{2}}$  satisfy the conditions of proposition 3.5.4.

Now assume that there exists a family of isolating neighbourhoods  $(K_\lambda)_{\lambda \in [0, 1[}$  as in 3.5.4. We show that the point at infinity is of isolated invariant complement. First of all, we note that all  $K_\lambda$ ,  $\lambda \in [0, 1[$  isolate the same invariant set. Otherwise we can find a  $\lambda_0$  for which  $Inv(K_{\lambda_0})$  intersects  $\partial K_{\lambda_0}$ , which prevents isolation: assume there exist  $\lambda < \mu$  such that  $Inv(K_\lambda) \subsetneq Inv(K_\mu)$ . Define  $\lambda_0 := \inf \{\nu > \mu / K_\nu \supset Inv(K_\mu)\}$ . Because of the minimality of  $\lambda_0$  holds  $Inv(K_\mu) \cap \partial K_{\lambda_0} \neq \emptyset$ . This is a contradiction to the assumptions on  $K_{lambda}$ , so it holds

$$\forall \lambda \in [0, 1[, \quad Inv(K_\lambda) = Inv(K_0).$$

For every compact neighbourhood  $K'$  containing  $K = K_0$  and not  $\infty$ , there exists a  $\lambda$  such that  $K' \subset K_\lambda$ . Then holds  $Inv(K_0) \subset Inv(K') \subset Inv(K_\lambda)$ , and as a consequence  $K'$  isolates the same invariant set as  $K$ , that we denote by  $\mathcal{F}$ , the maximal bounded invariant set.  $\square$

The remark 3.5.2 leads to the following third equivalent definition of the isolation of the complement of infinity which even does not require any compactification.

**Proposition 3.5.5.** *Consider a flow on a space  $X$ . Infinity is of isolated invariant complement if the maximal bounded set  $\mathcal{F}$  exists and is isolated invariant (in particular compact).*

This definition sounds less exotic than 3.5.1 or 3.5.4 because it does not require any compactification. But it requires knowledge of the global behaviour while the two others requires only knowledge about a neighbourhood of infinity - which is more usual for the Conley index theory.

Now let us generalize the definition of the Conley index in case it is of isolated invariant complement:

**Definition 3.5.6.** Let  $\phi$  be a flow on the Bendixson sphere  $\mathcal{S}$ . Assume that the point at infinity is of isolated invariant complement. Hence the maximal bounded invariant set  $\mathcal{F}$  exists, is isolated invariant, and its Conley index under the flow

$\phi$  with reversed time direction denoted by  $h^-(\mathcal{F})$  is we defined. We define the Conley index at infinity  $\hat{h}(\infty)$  by

$$\hat{h}(\infty) := h^-(\mathcal{F}).$$

Similarly the homological and cohomological Conley indices at infinity are defined by

$$\begin{aligned}\hat{H}_*(\infty) &:= H_*^-(\mathcal{F}), \\ \hat{H}^*(\infty) &:= H^{-*}(\mathcal{F})\end{aligned}$$

In fact, the Conley index at infinity may also be define without reversing time, as the following proposition shows. However definition 3.5.6 is closer to the intuition because we will later on replace infinity by an ersatz infinity having precisely Conley index  $\hat{h}(\infty)$ .

**Proposition 3.5.7.** *The following equalities hold:*

$$\begin{aligned}\hat{H}_*(\infty) &= H^*(\mathcal{F}), \\ \hat{H}^*(\infty) &= H_*(\mathcal{F}).\end{aligned}$$

*Proof.* By the time–duality theorem 3.4.2 holds

$$\begin{aligned}H_*^-(\mathcal{F}) &= H^{+*}(\mathcal{F}), \\ H^{-*}(\mathcal{F}) &= H_*^+(\mathcal{F}).\end{aligned}$$

□

**Corollary 3.5.8.** *The homological and cohomological Conley indices at infinity may be also defined for a semi flow  $\phi$  on the Bendixson sphere by*

$$\begin{aligned}\hat{H}_*(\infty) &:= H^*(\mathcal{F}), \\ \hat{H}^*(\infty) &:= H_*(\mathcal{F}).\end{aligned}$$

**Remark 3.5.9.** Here again we want to stress out that the definition of the Conley index at infinity in fact does not requires compactification, because the indices  $h^-(\mathcal{F})$ ,  $H^*(\mathcal{F})$ , and  $H_*(\mathcal{F})$  may be computed as well on the original phase space  $X$  as on the Bendixson sphere  $\mathcal{S}$ .

**Remark 3.5.10. Both definitions may not coincide**

In the case that the point at infinity is as well isolated invariant as of isolated invariant complement, both the classical index  $h(\infty)$  and the index at infinity  $\hat{h}(\infty)$  are defined. Those two indices may not be equal as we see if we consider the example 1.3.2 of a vector field on  $\mathbb{R}^2$  given by 1.11

$$\begin{cases} x_t = 2xy \\ y_t = 1 + y - x^2 + y^2 \end{cases} \quad (3.7)$$

whose Bendixson compactification is illustrated on figure 1.4. The point at infinity is isolated invariant and its classical Conley index is obviously trivial:

$$h(\infty) = \bar{0}.$$

The maximal bounded invariant set  $\mathcal{F}$  exists and consists of two unstable equilibria. The Conley index of  $\mathcal{F}$  reads  $h(\mathcal{F}) = \Sigma^2 \vee \Sigma^2$  and therefore

$$\hat{h}(\infty) = \Sigma^0 \vee \Sigma^0 \neq h(\infty).$$

**Example 3.5.11.** The Bendixson compactification of a linear vector field in  $\mathbb{R}^n$  is shown in example 1.3.1 and figure 1.3 for  $n = 2$ . If the origin is a hyperbolic equilibrium, the point at infinity is of isolated invariant complement and the maximal bounded invariant set  $\mathcal{F}$  contains only the origin:  $\mathcal{F} = \{0\}$ . We distinguish three cases:

1. If the origin is a saddle point, the point at infinity is not isolated invariant. Let  $k \in \mathbb{N}$ ,  $1 \leq k \leq n - 1$  be the number of unstable eigendirections of the origin. It holds

$$\begin{aligned} h(\mathcal{F}) &= \Sigma^k, \\ \hat{h}(\infty) &= \Sigma^{n-k}. \end{aligned}$$

2. If the origin is a sink, i. e. all eigendirections are stable, then the point at infinity is also isolated invariant and it holds

$$\begin{aligned} h(\mathcal{F}) &= \Sigma^0, \\ \hat{h}(\infty) = h(\infty) &= \Sigma^n. \end{aligned}$$

3. If the origin is a source, i. e. all eigendirections are unstable, then the point at infinity is also isolated invariant and it holds

$$\begin{aligned} h(\mathcal{F}) &= \Sigma^n, \\ \hat{h}(\infty) = h(\infty) &= \Sigma^0. \end{aligned}$$

The Conley index at infinity is able to detect the existence of unbounded trajectories. The following proposition states analog properties as for the classical Conley index (see Proposition 3.2.2).

**Proposition 3.5.12.** *Consider a compactified flow on the Bendixson sphere  $\mathcal{S}$  for which the point at infinity is of isolated invariant complement.*

- *If the Conley index at infinity  $\hat{h}(\infty)$  is the index of a repeller (see Definition 3.1.31), then there exists a trajectory accumulating on the point at infinity*

in backward time direction, and on a finite  $\omega$ -limit set in forward time direction. More precisely there exists a  $x \in \mathcal{S}$  such that

$$\begin{cases} \infty \in \alpha(x) \\ \mathcal{F} \cap \alpha(x) = \emptyset \\ \omega(x) \subset \mathcal{F} \end{cases}$$

- If the Conley index at infinity  $\hat{h}(\infty)$  is the index of an attractor (see Definition 3.1.31), then there exists a trajectory accumulating on the point at infinity in forward time direction, and on a finite  $\alpha$ -limit set in backward time direction. More precisely there exists a  $x \neq \infty \in \mathcal{S}$  such that

$$\begin{cases} \infty \in \omega(x) \\ \mathcal{F} \cap \omega(x) = \emptyset \\ \alpha(x) \subset \mathcal{F} \end{cases}$$

- If the Conley index at infinity  $\hat{h}(\infty)$  is neither that of an attractor nor that of a repeller then there exist trajectories accumulating on the point at infinity in backward time direction, and trajectories accumulating on the point at infinity in forward time direction. More precisely there exist  $x_1, x_2 \neq \infty \in \mathcal{S}$

$$\begin{cases} \infty \in \alpha(x_1) \\ \infty \in \omega(x_2) \end{cases}$$

*Proof.* We apply theorems 3.1.29 and 3.1.30 on the by assumption isolated invariant set  $\mathcal{F}$ . This leads to the existence of trajectories connecting to  $\mathcal{F}$  on the one end and accumulating on the point at infinity at the other end.

The fact that there exist an isolating block  $B$  for  $\mathcal{F}$  whose boundary is whole occupied by the exit set in the first case, and by the entrance set in the second case, guarantees that no trajectory can accumulate both on  $\infty$  and  $\mathcal{F}$ .  $\square$

**Remark 3.5.13.** Note that we did not exclude accumulation on a homoclinic orbit to the point at infinity. This is the reason why we cannot get equalities  $\{\infty\} = \alpha(x)$  or  $\{\infty\} = \omega(x)$  respectively.

Now we shall present a method to detect heteroclinic orbits between a finite isolated invariant set contained in  $\mathcal{F}$  and the point at infinity in case it is of isolated invariant complement.

### Detection of heteroclinics to infinity

Let  $\mathcal{F}$  be the maximal bounded invariant set of a flow and  $N$  an isolating neighbourhood for  $\mathcal{F}$ . Further let  $S \subset \mathcal{F}$  be a finite isolated invariant set. We are

interested in the detection of heteroclinic connections between  $S$  and the point at infinity. If the point at infinity is not isolated invariant, classical Conley index methods will not apply. However the existence of  $\mathcal{F}$  means that the point at infinity is of isolated invariant complement. The heteroclinics to infinity are trajectories which leave every neighbourhood of  $\mathcal{F}$  in one time direction, and accumulate on the finite isolated invariant set  $S \subset \mathcal{F}$  in the other time direction. To fix the ideas, let us consider a full trajectory  $\{\sigma(t), t \in \mathbb{R}\}$ , with  $\alpha(\sigma) \subset S$ , which leaves  $N$  at a positive time. Because of the maximality of  $\mathcal{F}$ , we can affirm that the trajectory  $\sigma$  does not only leaves  $N$ , but leaves every isolating neighbourhood of  $\mathcal{F}$ . Because these neighbourhoods can grow up to the point at infinity, the trajectory  $\sigma$  has to accumulate on the point at infinity, or more precisely  $\{\infty\} \subset \omega(\sigma)$ . This fact will be made more precise in Theorem 3.5.22, but we have to keep in mind for the moment that the crucial issue to detect heteroclinics to/from infinity is to detect orbits leaving/entering an isolating neighbourhood  $N$  of  $\mathcal{F}$ .

The detection of trajectories leaving a neighbourhood  $N$  of the maximal invariant set  $\mathcal{F}$  may be achieved by the following method. We propose to cut the Bendixson sphere along the boundary of  $N$ , and glue outside of  $N$  a neighbourhood isolating an “ersatz infinity”, with which we will be able to apply classical Conley index methods.

Now we will make this construction more precise and illustrate it on an elementary example. The same idea will be used for the Poincaré compactification, for which we will consider more sophisticated examples, in particular 3-dimensional ones.

**First step: cut and glue.**

For technical reasons, we will use an isolating block  $K$  for the maximal bounded isolated invariant set  $\mathcal{F}$  and not a simple isolating neighbourhood. We will see that it is useful to extend the flow properly outside of the neighbourhood  $K$  of  $\mathcal{F}$ .

The boundary  $\partial K$  of  $K$  is a closed subset of the Bendixson sphere  $\mathcal{S}$ . If the flow is smooth,  $K$  may be chosen in such a way that it is a manifold with boundary - this boundary  $\partial K$  being itself a manifold without boundary of one dimension lower. On the other side consider an oriented manifold  $M$  of dimension  $n = \dim(\mathcal{S})$  with boundary  $\partial M$ . Furthermore we require that  $\partial M$  contains a connected component  $d \subset \partial M$  which is homeomorphic to  $\partial K$ , and let us name  $g : d \rightarrow \partial K$  such a homeomorphism.

Let us define now the gluing map  $q$  as a quotient map

$$q : K \cup M \rightarrow \frac{K \cup M}{\sim}, \quad (3.8)$$

where the equivalence relation  $\sim$  on  $K \cup M$  identifies  $\partial K$  and  $d$ : let  $x, y$  be two



points of  $K \cup M$ ; we write  $x \sim y$  if and only if

$$\begin{aligned} & x = y \quad , \text{ or} \\ x \in d, y \in \partial K, \text{ and } & y = g(x) \quad , \text{ or} \\ y \in d, x \in \partial K, \text{ and } & x = g(y). \end{aligned}$$

**Remark 3.5.14.** The set  $\frac{K \cup M}{\sim}$  is a topological space which is in general only a continuous manifold and not a differentiable one. In Remark 3.5.24, we explain how this manifold (and the extension of the flow on it described below) may be made smooth for our specific choice of  $M$ .

Now we propose a choice for  $M$ , for which we will explain also the next steps and give examples. However, it is not the only possibility of extending  $K$ . The boundary  $\partial K$  splits into the entrance and exit set of the isolating block  $K$ . It holds  $\partial K = K^+ \cup K^-$ , the intersection  $K^+ \cap K^-$  is not empty, but contains the points of external tangency to  $K$ , i. e. points that leaves  $K$  immediately in both forward and backward time directions. We want to exploit the topology of  $K^+$  and  $K^-$  to detect orbits leaving  $K$ . Their topology is encoded by the “simplest” topological space that one can retract them on. Assume that we have two continuous retractions

$$r^\pm : K^\pm \times [0, 1] \rightarrow K^\pm,$$

of  $K^\pm$  on  $k^\pm \subset K^\pm$ , that is:

1. For all  $x \in K^\pm$  and  $s \in [0, 1]$ ,  $r^\pm(x, s) \in K^\pm$ ,
2. for all  $x \in k^\pm$  and  $s \in [0, 1]$ ,  $r^\pm(x, s) = x$ ,
3. for all  $x \in K^\pm$ ,  $r^\pm(x, 0) = x$ ,
4. for all  $x \in K^\pm$ ,  $r^\pm(x, 1) \in k^\pm$

Furthermore we require two extra conditions on the retraction. They will be needed to extend the flow. The first is not really a restriction to the generality, but guarantees that  $K^\pm$  do not retract on their common boundary. The second condition requires that the retractions do not squeeze  $K^\pm$  to fast.

- (C1)  $k^\pm \subset \text{int}_{\partial K}(K^\pm)$ .
- (C2)  $\forall s \in [0, 1[$ , the map  $r^\pm(\cdot, s) : K^\pm \rightarrow K^\pm$  is injective.

The condition (C1) guarantees that both of the retractions are strict. In fact, we only need that one of the two restriction is strict, so that  $k^- \times \{1\}$  and  $k^+ \times \{1\}$  do not intersect. This is no big constraint, because at least one of the two sets  $K^\pm$  admits a non-empty interior relatively to  $\partial K$ , so that there exist a strict retraction to a corresponding  $k^e \subset \text{int}_{\partial K}(K^e)$ , for a  $e \in \{+, -\}$ . As a conclusion,

(C1) is not really a constraint.

The condition (C2) allows us to extend the flow without producing branching of the extension of the trajectories. We conjecture that such retractions exist generically when  $K^\pm$  are entrance or exit sets of an isolating block. At least they exist for the examples we draw our attention to.

We set

$$M := \{(r^+(x, s), s) \in K^+ \times [0, 1]\} \cup \{(r^-(x, s), s) \in K^- \times [0, 1]\}.$$

In other words, the set  $M \subset \partial K \times [0, 1]$  is the union of the two “graphs” of the retractions  $r^\pm$ . The boundary of  $M$  contains  $K^+ \times \{0\} \cup k^+$  and  $K^- \times \{0\} \cup k^-$ . With

$$d := K^+ \times \{0\} \cup K^- \times \{0\},$$

and

$$\begin{aligned} g &: d \rightarrow \partial K \\ &(x, 0) \mapsto x \end{aligned}$$

We construct the extended phase space  $\frac{K \cup M}{\sim}$  as described before. Here we have more explicitly for every pair of points  $x, y \in K \cup M$ ,  $x \sim y$  if and only if

$$x = y \tag{3.9}$$

$$\text{or } x \in \partial K, \quad y \in M \text{ and } y = (x, 0) \tag{3.10}$$

$$\text{or } y \in \partial K, \quad x \in M \text{ and } x = (y, 0) \tag{3.11}$$

This extended phase space is in general only a continuous manifold with boundary, differentiability may be reached; see Remark 3.5.24. The boundary of the extended phase space  $Ext(K)$  is the union  $\{(r^-(x, s), s), x \in K^- \cap K^+, s \in [0, 1]\} \cup \{(r^+(x, s), s), x \in K^- \cap K^+, s \in [0, 1]\} \cup k^- \cup k^+$ . To fix the ideas, let us state the following definition:

**Definition 3.5.15.** Let  $K$  be an isolating block for the maximal invariant set  $\mathcal{F}$ . Let  $r^\pm : [0, 1] \times K^\pm \rightarrow K^\pm$  be retraction satisfying Conditions (C1) and (C2). Let  $M$  be defined as the union of the graphs of  $r^\pm$ ; i. e.

$$M := \{(r^+(s, x), s), x \in K^+, s \in [0, 1]\} \cup \{(r^-(s, x), s), x \in K^-, s \in [0, 1]\}.$$

Furthermore let the equivalence relation  $\sim$  be defined through 3.9, 3.10, 3.11. The extended phase space  $Ext(K)$  is defined as the quotient

$$Ext(K) := \frac{K \cup M}{\sim}.$$

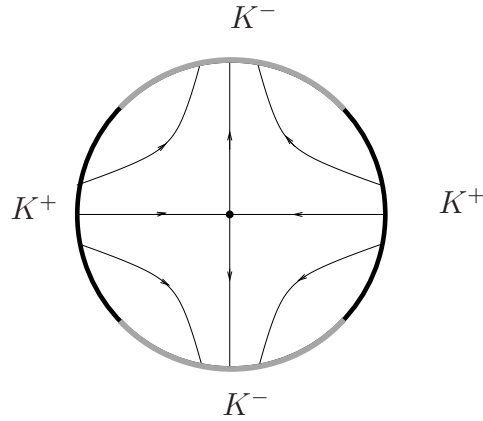

Figure 3.8: An isolating block  $K$  for  $\mathcal{F}$  with its immediate entrance and exit sets  $K^\pm$ .

**Example 3.5.16.** Let us make this construction on the easiest interesting example which is a linear vector field on  $\mathbb{R}^2$  where the origin is a saddle. The Bendixson compactification of this system is given in Chapter 1, 1.3.1, and illustrated in Figure 1.3. The point at infinity is not isolated invariant, but of isolated invariant complement. The maximal bounded invariant set is reduced to the origin,

$$\mathcal{F} = \{0\}.$$

Any disk centered at the origin provides an isolating block  $K$  for  $\mathcal{F}$ . The immediate entrance and exit sets are both the union of two disjoint arcs of a circle, see Figure 3.8. Therefore, both  $K^+$  and  $K^-$  are retractable to the disjoint union of two points. The retractions  $r^\pm$  can be easily chosen so as to satisfy conditions (C1) and (C2) by applying homotheties shrinking each arc of the circle on its middle point. The Figure 3.9 illustrates one of the four parts of the set  $M$  obtained by this construction. Finally, Figure 3.10 shows the extended phase space  $Ext(K)$ . This example will be continued in 3.5.18.

Now let us introduce the extension of the flow on  $Ext(K)$ .

**Second step: extend the flow.**

The trajectories in  $K$  are given by the compactified flow on the Bendixson sphere. This flow has to be extended on the extended phase space  $Ext(K) = \frac{K \cup M}{\sim}$ . We show how to do it for our special choice  $M = \{(r^+(x, s), s) \in K^+ \times [0, 1]\} \cup \{(r^-(x, s), s) \in K^- \times [0, 1]\}$ .

Let us describe the extended flow on the extended phase space. For this we associate to each  $x \in K$  the positive first exit time  $T_+(x)$  and the negative enter time  $T_-(x)$ , precisely defined as follows:

$$T_+(x) := \sup\{t \geq 0 / \varphi(x, t) \in K\} \in [0, +\infty],$$

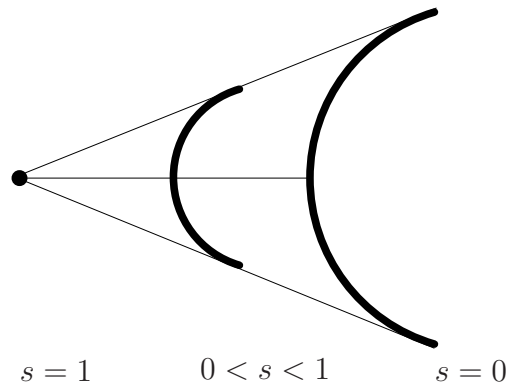
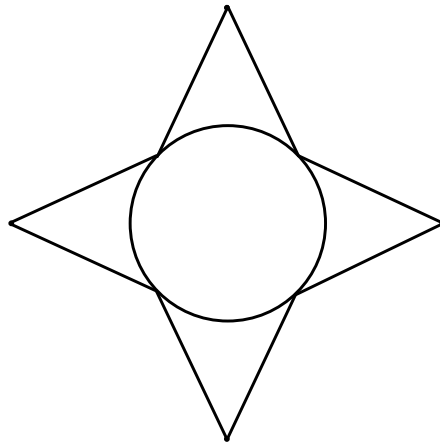

Figure 3.9: Retraction of each arc on a point.

Figure 3.10: The extended space  $Ext(K) = \frac{KUM}{\sim}$

$$T_-(x) := \inf\{t \leq 0 / \varphi(x, t) \in K\}, \in [-\infty, 0]$$

where  $\varphi$  is the compactified flow on the Bendixson sphere. Obviously holds for all  $x \in K$ , as soon as  $T_-(x)$  or  $T_+(x)$

$$\varphi(x, T_+(x)) \in K^-,$$

$$\varphi(x, T_-(x)) \in K^+.$$

Furthermore, due to the injectivity of  $r^\pm(s, \cdot)$  for  $s \in [0, 1]$ , for each  $(x, s) \in M$  with  $s \in [0, 1]$ , exists a unique  $X(x) \in \partial K$  such that

- $X(x)$  lies in  $K^+$  and  $x = r^+(X(x), s)$ ,
- or  $X(x)$  lies in  $K^-$  and  $x = r^-(X(x), s)$ ,

because of the definition of  $M$  and the conditions (C1) and (C2) required on the retractions  $r^\pm$ . For all  $x \in K^+ \cap K^-$ , holds  $r^-(x, 0) = r^+(x, 0) = x$ . Now we have all ingredients to define the extended flow  $\hat{\varphi}$  on  $\frac{K \cup M}{\sim}$ . We set  $s_\pm := \pm(1 - e^{\pm(T_\pm - t)})$  and define first  $\hat{\varphi}$  on  $K$ :

$$\hat{\varphi} : (t, x) \in \mathbb{R} \times K \mapsto \begin{cases} \varphi(t, x) & , \text{ if } T_-(x) \leq t \leq T_+(x) \\ (r^-(s_+, \varphi(T_+(x), x)), s_+) & , \text{ if } t \geq T_+(x) \\ (r^+(s_-, \varphi(T_-(x), x)), s_-) & , \text{ if } t \leq T_-(x) \end{cases} \quad (3.12)$$

where  $\varphi$  is the compactified flow on the Bendixson sphere. It remains to define  $\hat{\varphi}$  on  $M$ . We recall that to every  $(x, s) \in M$  with  $s \neq 1$ , we associate its unique preimage through  $r^\pm(\cdot, s)$  denoted by  $X(x) \in K^\pm \subset K$ , so that  $\hat{\varphi}(X(x), \tau)$  makes sense with the above definition of  $\hat{\varphi}$ .

$$\hat{\varphi} : (x, s) \in M \mapsto \begin{cases} \hat{\varphi}(\log(1 - s) + t, X(x)), & \text{ if } x \in r^+(K^+, s) \text{ and } s \in [0, 1[, \\ \hat{\varphi}(\log(1 - s) - t, X(x)), & \text{ if } x \in r^-(K^-, s) \text{ and } s \in [0, 1[, \\ (x, 1), & \text{ if } s = 1. \end{cases} \quad (3.13)$$

**Proposition 3.5.17.** *The map  $\hat{\varphi} : Ext(K) \times \mathbb{R} \rightarrow Ext(K)$  as defined through Formulas 3.12 and 3.13 builds a continuous flow on the extended phase space  $Ext(K)$ .*

*Proof.* Let us justify the group property of the map  $\hat{\varphi}$ ; i. e. for all  $t_1, t_2$ ,  $\hat{\varphi}(t_2, \hat{\varphi}(t_1, x)) = \hat{\varphi}(t_1 + t_2, x)$ . It is sufficient to prove this property outside of  $K$ , because in  $K$ , the flows  $\varphi$  and  $\hat{\varphi}$  coincide and therefore  $\hat{\varphi}$  inherit the group property of  $\varphi$ . When this is done, the global group property is proven by making stopovers on the boundary common to  $K$  and  $M$ .

Let  $x = (r^-(s, y), s), y \in K^-, s \in [0, 1]$  be an element of  $M$ , and  $t_1, t_2$  such that

$\log(1-s) \leq t_1, t_2, t_1 + t_2$ ; this guarantees that  $\hat{\varphi}(t_1, x)$ ,  $\hat{\varphi}(t_2, x)$ , and  $\hat{\varphi}(t_1 + t_2, x)$  are still in  $M$ . By definition of  $\hat{\varphi}$  holds

$$\begin{aligned} \hat{\varphi}(t_1, x) &= \hat{\varphi}(t_1, (r^-(s, y), s)) \\ &= \hat{\varphi}(-\log(1-s) + t_1, y) \\ &= (r^-(1 - e^{\log(1-s)-t_1}, y), 1 - e^{\log(1-s)-t_1}) \end{aligned}$$

Setting

$$\begin{aligned} s_1 &:= 1 - e^{\log(1-s)-t_1} \\ &= 1 - (1-s)e^{-t_1} \\ -\log(1-s_1) &= -\log(1 - 1 - (1-s)e^{-t_1}) \\ &= t_1 - \log(1-s), \end{aligned}$$

we get

$$\begin{aligned} \hat{\varphi}(t_2, \hat{\varphi}(t_1, x)) &= \hat{\varphi}(t_2 - \log(1-s_1), y) \\ &= \hat{\varphi}(t_2 + t_1 - \log(1-s), y) \\ &= \hat{\varphi}(t_1 + t_2, x). \end{aligned}$$

For arbitrary  $t_1, t_2$ , set  $\tau = \log(1-s)$ , which is exactly the time at which the trajectory through  $x$  enters  $K$  and prove the group property by a stopover at  $t = \tau$ .

The proof of the equality  $\hat{\varphi}(t_2, \hat{\varphi}(t_1, x)) = \hat{\varphi}(t_1 + t_2, x)$  for  $x = (r^+(s, y), s)$ ,  $y \in K^+$ ,  $s \in [0, 1]$  is similar.

Now the continuity of the flow uses the continuity of  $\varphi$ , of  $r^\pm$  and of  $T_\pm$  due to the fact that  $K$  is an isolating block. The extension  $\hat{\varphi}$  is constructed in such a way that the trajectories are not teared appart as they run through the sutures  $K^\pm \sim K^\pm \times \{0\}$ .  $\square$

**Example 3.5.18.** We continue here the basic example 3.5.16 and show the extended flow on  $Ext(K)$ . The trajectories, after leaving  $K$ , just follow the homothety shrinking the arcs of circle to a point, and this in the appropriate time direction depending on their belonging to  $K^+$  or  $K^-$ . The homothety factor is rescaled in such a way that the equilibrium on which an arc is shrunked, is reached in infinite time. See figure 3.11. This example will be continued in 3.5.23.

If the retractions  $r^\pm$  of  $K^\pm$  on  $k^\pm \subset K^\pm$  can be chosen with the conditions (C1), (C2), then the sets  $k^\pm \times \{1\} \subset Ext(M)$  under the extended flow  $\hat{\varphi}$  will have the following properties:

**Proposition 3.5.19.** *Consider a flow  $\varphi$  on the Bendixson sphere for which the point at infinity is of isolated invariant complement. Let  $K$  be an isolating block of the maximal bounded invariant set  $\mathcal{F}$ . Assume that the immediate entrance*

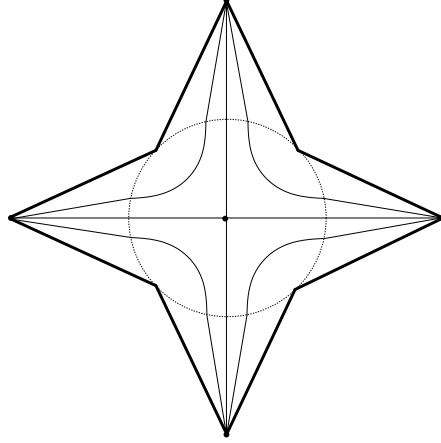
Figure 3.11: The extended flow  $\hat{\varphi}$ 

and exit sets  $K^\pm$  of  $K$  are retractable  $k^\pm$  by retractions  $H^\pm$  satisfying the above conditions (C1), (C2) above. Then, under the above constructed flow  $\hat{\varphi}$  on the extended phase space  $Ext(K)$  holds:

1. The sets  $k^-$  and  $k^+$  are isolated invariant,
2. the set  $k^-$  is an attractor,
3. the set  $k^+$  is a repeller.

*Proof.* Let  $U$  be defined as

$$U := \left\{ (r^-(s, x), s), x \in K^-, s \in \left[\frac{1}{2}, 1\right] \right\}.$$

The set  $U$  is a neighbourhood of  $k^-$  in the extended phase space  $Ext(M)$  and with respect to the extended flow  $\hat{\varphi}$  there obviously holds

$$\omega(U) = k^-,$$

so that  $k^-$  is an attractor.

Similarly, the set  $V$  defined as

$$V := \left\{ (r^+(s, x), s), x \in K^+, s \in \left[\frac{1}{2}, 1\right] \right\}$$

is a neighbourhood of  $k^+$  for which holds

$$\alpha(V) = k^+,$$

so that  $k^+$  is a repeller. □

**Remark 3.5.20.** Note that the construction is also possible if  $\varphi$  is only a semi flow. The extension  $\hat{\varphi}$  has to be done for each trajectory under  $\varphi$ . The extension does not exclude multiple prehistory, but does not create new branches of trajectories. The extension of a global semi flow on  $\mathcal{S}$  is a global semi flow on  $Ext(K)$ . Therefore we are able to formulate Theorems 3.5.22 and 3.5.27 on the existence of heteroclinic to infinity for semi flows, and not only for flows.

The sets  $k^\pm$  being isolated invariant with respect to the extended flow  $\hat{\varphi}$ , the Conley index is able to detect heteroclinic orbits to/from them. For this one has to compare some indices.

**Third step: compare indices.**

The classical Conley index theory for the flow  $\hat{\varphi}$  now comes into play. Consider a set  $S$  of the extended phase space  $Ext(K)$  that is isolated invariant under the extended flow  $\hat{\varphi}$ , and admits an attractor–repeller decomposition of the form  $(k^-, R)$ , where  $R \subset \mathcal{F} \subset int(K)$  is a bounded isolated invariant set. If there holds

$$h(S) \neq h(k^-) \vee h(R),$$

where the Conley indices are computed with respect to the extended flow  $\hat{\varphi}$  then the extended flow  $\hat{\varphi}$  admits a heteroclinic trajectory connecting  $R$  to  $b^-$ .

Let us translate this information for the compactification of the original flow on the Bendixson sphere. As the compactified flow and the extended flow coincide on  $K$ , the heteroclinic  $R \rightarrow k^-$  of the extended flow is, with respect to the original compactified flow, an orbit which leaves  $K$  in forward time direction. We denote this orbit by  $\sigma$ .

We cannot conclude that the  $\omega$  limit set  $\omega(\sigma)$  is the point at infinity because we know nothing about the flow outside  $K$ ; see for illustration Remark 3.5.21. However the fact that the point at infinity is of isolated invariant complement allows us to affirm that  $\omega(\sigma)$  is not contained in the maximal bounded invariant set  $\mathcal{F}$ . Indeed, if  $\omega(\sigma)$  were contained in  $\mathcal{F}$ , then  $\sigma$  would remain bounded away from the point at infinity. As a consequence, the trajectory  $\sigma$  would be bounded and invariant, and by definition of  $\mathcal{F}$ , we would have  $\sigma \subset \mathcal{F}$ . This contradicts the fact that  $\sigma$  leaves the block  $K$  isolating  $\mathcal{F}$ .

Therefore,  $\omega(\sigma)$  has to contain the point at infinity. We will also say that the orbit accumulates at the point at infinity to describe this phenomenon.

**Remark 3.5.21.** An orbit may accumulate on the point at infinity while the strict inclusion  $\{\infty\} \subsetneq \omega(x)$  still holds. We can observe this phenomenon again in example 1.3.2 illustrated in figure 1.4. From each finite equilibrium heteroclinics are running whose  $\omega$ –limit set is not solely the point at infinity: those orbits accumulate on a homoclinic cycle containing the point at infinity.

We summarize our conclusions in the following theorem:



**Theorem 3.5.22.** *Consider a compactified semi flow  $\varphi$  on the Bendixson sphere  $\mathcal{S}$  such that the point at infinity is of isolated invariant complement.*

*Fix an isolating block  $K$  of the maximal bounded invariant set  $\mathcal{F}$  and proceed to the construction of the extended phase space  $Ext(K)$  described by 3.5.15 and the extended semi flow  $\hat{\varphi}$  3.12, 3.13 as above.*

- *Assume there exists an isolated invariant set  $S$  with respect to the extended semi flow  $\hat{\varphi}$  admitting an attractor–repeller decomposition of the form  $(k^-, R)$ , where  $R$  is an isolated invariant subset of  $\mathcal{F}$ .*

*If*

$$h(S) \neq h(k^-) \vee h(R),$$

*then there exists an orbit  $\sigma(t)$  with*

$$\alpha(\sigma) \subset R$$

$$\omega(\sigma) \supset \{\infty\}$$

*connecting  $R$  to the point at infinity.*

- *Assume there exists an isolated invariant set  $S$  with respect to the extended semi flow  $\hat{\varphi}$  admitting an attractor–repeller decomposition of the form  $(A, k^+)$ , where  $A$  is an isolated invariant subset of  $\mathcal{F}$ .*

*If*

$$h(S) \neq h(A) \vee h(k^+),$$

*then there exists an orbit  $\sigma(t)$  with*

$$\alpha(\sigma) \supset \{\infty\}$$

$$\omega(\sigma) \subset A$$

*connecting the point at infinity to  $A$ .*

**Example 3.5.23.** This is the last part of example 3.5.16, 3.5.18. We notice in figure 3.11 that the extended flow is topologically equivalent to the Poincaré compactification of the linear saddle given in Example 2.1.1 and Figure 2.3. We have already seen that the Conley index methods are able to detect the heteroclinic orbits between the origin and the four equilibria at infinity.

On the other hand, the picture that we get is also comparable to the “blow up” methods introduced e. g. by Dumortier (see for example [13]) and applied to the point at infinity. Our approach to desingularize the point at infinity is more topological and may be more flexible, although in this case both methods provide the same picture.

**Remark 3.5.24.** Note that the flow  $\hat{\varphi}$  being not smooth but in general only continuous, the isolating blocks may be no manifolds (with boundary). This fact has consequences on the algebraic topology of the Conley index: we can be sure of the equality of the homology/cohomology of the quotient space  $\frac{N}{L}$  and of the relative homology/cohomology  $H(N, L)$  only if  $(N, L)$  is a "good pair". Such a "good pair" is given by a block together with its exit set, if one can find an isolating block which is a manifold with boundary. This is the usual argument used to prove the existence of a "good pair", and does not apply here. Therefore, we introduce the following condition (C3) on the retractions  $r^\pm$  and discuss how to make the extended phase space  $Ext(K)$  and the extended flow  $\hat{\varphi}$  smooth.

- (C3) The retractions  $r^\pm$  are smooth.

Let us comment why the conditions (C1), (C2) and (C3) are needed.

- (C1):  $k^\pm \subset int_{\partial K}(K^\pm)$   
avoid the intersection of  $k^+ \times \{1\}$  and  $k^- \times \{1\}$  as subsets of the extended phase space  $Ext(K)$ .
- (C2): The injectivity of  $r^\pm(s, \cdot)$  for  $s \in [0, 1[$  allows to define for each  $(x, s) \in M$ ,  $s \in [0, 1[$  a unique point  $X(x)$  on  $K^\pm$  with  $x = (r^\pm(s, X(x)), s)$ ; i. e. a unique preimage through  $r^\pm(s, \cdot)$ .
- (C3): Smoothness of  $r^\pm$  is a necessary condition for the smoothness of  $\hat{\varphi}$ .

However these conditions are still not sufficient to make the extension smooth. To reach this aim, we propose the following strategy:

The first source of non-smoothness of the extended space sits at the boundary  $\partial K$  of  $K$ : the gluing procedure do not respect the tangential phase spaces  $T_x\mathcal{S}$  of the Bendixson sphere  $\mathcal{S}$  for  $x \in \partial K$ . If we have retractions  $r^\pm$  fulfilling Condition (C1), (C2), (C3), we have to modify them in such a way that  $\frac{d}{dt}|_{t=0} \hat{\varphi}(t, x) \in T_x\mathcal{S}$  for every  $x \in \partial K$ . We are on the safe side if there holds

$$\forall x \in \partial K \quad \frac{d}{dt}|_{t=0} \hat{\varphi}(t, x) = \frac{d}{dt}|_{t=0} \varphi(t, x) \in T_x\mathcal{S}$$

According to Definition 3.12, it holds for  $x \in \partial K$

$$\frac{d}{dt}|_{t=0} \hat{\varphi}(t, x) = \left( \mp \frac{d}{ds}|_{s=0} r^\pm(s, x), \mp 1 \right)$$

Applying first an homotopy deforming  $\frac{d}{dt}|_{t=0} \varphi(t, x)$  into  $\left( \mp \frac{d}{ds}|_{s=0} r^\pm(s, x), \mp 1 \right)$ , and then the retraction  $r^\pm$ , and rescaling the deformation time interval from length 2 to length 1 should provide a smooth extension of the flow at the boundary

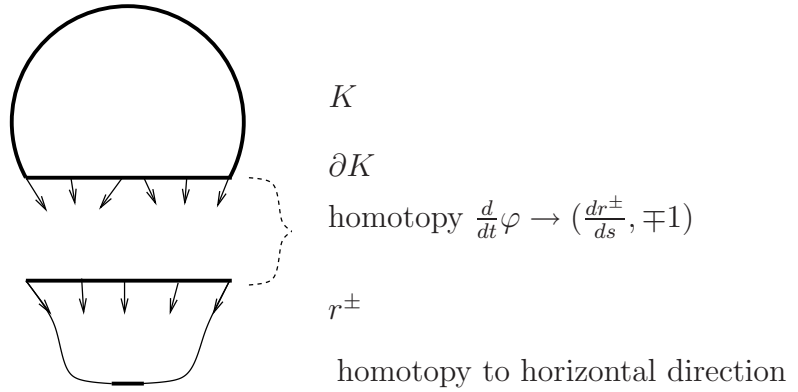

Figure 3.12: Sketch of the smoothing of  $Ext(K)$  and  $\hat{\varphi}$ .

$\partial K$ . A similar homotopy has to be applied at the end of the retractions  $r^\pm$  so that the derivative  $\frac{d}{dt}|_{t \rightarrow \mp \infty} \hat{\varphi}(t, x) = \left( \mp \frac{d}{ds}|_{s=1} r^\pm(s, x), \mp 1 \right)$  is deformed to the horizontal direction  $(a, 0)$ ,  $a \in \mathbb{R}^n$ . This construction is sketched in Figure 3.12.

**Conjecture 3.5.25.** It is generically possible to find retractions  $r^\pm$  fulfilling (C1), (C2), (C3) of the entrance and exit sets  $K^\pm$ .

**Conjecture 3.5.26.** It is generically possible to find homotopies smoothing the extended phase space  $Ext(K)$  and the extended flow  $\hat{\varphi}$  as described in Remark 3.5.24

If we know that that the extension may be smoothed, then the machinery coming from algebraic topology apply and we have the following theorem:

**Theorem 3.5.27.** *Assume that  $Ext(K)$  and  $\hat{\varphi}$  are smoothed. Then under the assumptions of Theorems 3.5.22,*

- if the connection map

$$\delta : H_*(R) \rightarrow H_*(k^-)$$

*is nontrivial, then there is a heteroclinic connection  $R \rightarrow k^-$  for the extended semi flow  $\hat{\varphi}$ . This orbit corresponds to a trajectory  $\sigma$  under the compactified flow on the Bendixson sphere  $\mathcal{S}$  with*

$$\alpha(\sigma) \subset R,$$

$$\omega(\sigma) \supset \{\infty\}.$$

- if the connection map

$$\delta : H_*(k^+) \rightarrow H_*(A)$$

is nontrivial, then there is a heteroclinic connection  $k^+ \rightarrow A$  for the extended semi flow  $\hat{\varphi}$ . This orbit corresponds to a trajectory  $\sigma$  under the compactified flow on the Bendixson sphere  $\mathcal{S}$  with

$$\alpha(\sigma) \supset \{\infty\},$$

$$\omega(\sigma) \subset A.$$

**Remark 3.5.28.** The theorem 3.5.22 is still true if one choose to extend the phase space in another manner, as long as the flow properties of the extension are respected. In other words,

- if one is able to embed an isolating block  $K$  of the maximal bounded invariant set  $\mathcal{F}$  in a bigger bounded phase space  $Y$  where the flow is an extension of the flow in  $K$ ,
- and if a connection between two isolated invariant sets  $B \subset \mathcal{F}$  and  $C \subset Y \setminus K$ ,

then the same conclusions follows as in Theorem 3.5.22.

Futhermore, if the extention can be smoothed, then the Theorem 3.5.27 also holds.

We describe a way of extending the flow which should work in quite general situation, but there may be situations where another choice is more natural or more efficient.

**Remark 3.5.29.** Let us try to describe here which type of connections may be detected by the above presented method. The set  $k^-$  being an attractor, it seems obvious that only a pair of the form  $(k^-, B)$ , where  $B$  is, say, a finite isolated invariant set, may be an attractor–repeller decomposition of an isolated invariant set  $S$  under the flow  $\hat{\varphi}$ . As the set  $B$  is an finite isolated invariant set, it is an invariant subset of  $\mathcal{F}$  and its indices under the flows  $\varphi$  and  $\hat{\varphi}$  coincide. Moreover, we know that  $k^-$  having an index of attractor in the sense of definition 3.1.39, the homotopy index  $H_*(k^-)$  will show a non trivial  $H_0(k^-)$ . Only if the homological Conley index of the set  $B$  shows a non trivial  $H_1(B)$ , the map  $\partial : H_1(B) \rightarrow H_0(k^-)$  has a chance to be nontrivial. This is the information that results directly of the dynamic we constructed on the glued part  $M$  of our extended phase space. On the other hand, the set  $k^-$  itself has a topology which may implies other nontrivial levels of homology index  $H_k(k^-)$ . The "good" sets  $B$  for which the connection map  $\partial : H_*(B) \rightarrow H(k^-)$  may detect a heteroclinic orbit are those with non trivial homology level  $H_{k+1}(B)$ .

Now let us address the question of the Morse decomposition

### Morse decomposition and connection matrices

The connection map for an attractor–repeller pair lays the groundwork of the connection matrix for a Morse decomposition. We show that our construction with the extended phase space embeds very well in this framework. We fix an isolating block  $K$  of  $\mathcal{F}$  and with this  $K$  construct the extended phase space  $Ext(K)$  equipped with the extended flow  $\hat{\varphi}$ . Assume that there exists an isolated invariant set  $S$  which admits a Morse decomposition  $\{M_p, p \in I, >\}$  satisfying the following conditions:

1. there exist  $i_+, i_- \in I$  such that  $M_{i_+} = k^+$  and  $M_{i_-} = k^-$ ,
2. for all  $j \in I, j \neq i_{\pm}, M_j \subset \mathcal{F}$ .

As  $k^-$  and  $k^+$  are attractor and repeller respectively, the admissible ordering should include them at the beginning or the end of a chain of ordering relations respectively. Such a Morse decomposition could be obtained by completing a Morse decomposition of the maximal bounded invariant set  $\mathcal{F}$  by  $k^+$  and  $k^-$  by the addition of  $k^-$  and  $k^+$  at extremities of chain of orders. Classical connection matrix theory then apply through Theorem 3.5.27, as soon as the extension can be smoothed - which we think is true except my be in pathological situations; see Remark 3.5.24. Theorem 3.5.27 translates the heteroclinics of the extended flow into heteroclinics of the original flow on the Bendixson sphere  $\mathcal{S}$ .

### 3.5.2 Under Poincaré compactification

We develop now definitions with many analogies to the ones in the last paragraph, this time in the context of the Poincaré compactification. Here again we consider semi flows for which we have existence of prehistory through each point of the Poincaré sphere. However we do not require uniqueness of the prehistory. The main differences with the Bendixson compactification we have to face are:

- The compactified phase space is now the Poincaré hemisphere  $\mathcal{H}$  which is a manifold with boundary. This make the classical Conley index theory more technical as we saw in section 3.1.1, because the index itself splits in three components.
- Infinity is represented by the equator  $\mathcal{E}$  of the hemisphere  $\mathcal{H}$  which is an invariant set. Infinity is not a single point any more but a whole sphere. It may contain more or less sophisticated invariant subsets  $S$ . Moreover there are issues of dynamics inside the equator. One may argue that they are artificial because they do not exist in the original phase space  $X$ , but they are in fact useful to describe how trajectories approach infinity.

Let us begin with the notion of isolation of the complement.

**Definition 3.5.30.** We consider a normalized semi flow  $\phi$  on the Poincaré hemisphere  $\mathcal{H}$ . Let  $S \subset \mathcal{E}$  be an invariant set contained in the sphere at infinity of the Poincaré hemisphere  $\mathcal{H}$ . The set  $S$  is called of isolated invariant complement if there exists a compact set  $K \subset \mathcal{H}$  with the following properties:

1. The compact  $K$  does not intersect with the invariant set  $S$ :  $K \cap S = \emptyset$ .
2. The set  $K$  is an isolating neighbourhood in the Poincaré hemisphere  $\mathcal{H}$ :  $Inv(K) \subset int_{\mathcal{H}}(K)$ .
3. Every compact neighbourhood  $K' \subset \mathcal{H}$  containing  $K$  which does not intersect the invariant set  $S$  is also an isolating neighbourhood:

$$\left\{ \begin{array}{l} K' \text{ compact neighbourhood} \\ K' \supset K \\ K' \cap S = \emptyset \end{array} \right. \Rightarrow K' \text{ isolating neighbourhood.}$$

Again we can define this concept equivalently with a continuous family of isolating neighbourhoods whose complement shrinks on the invariant set  $S$  contained in the sphere at infinity.

**Proposition 3.5.31.** *Consider an invariant set  $S \subset \mathcal{E}$  contained in the sphere at infinity of the Poincaré hemisphere  $\mathcal{H}$ . The set  $S$  is of invariant isolated complement if and only if there exist a compact neighbourhood  $\tilde{K}$  of the invariant set  $S$  in the hemisphere  $\mathcal{H}$  and a retraction*

$$H : [0, 1] \times \tilde{K} \rightarrow \tilde{K}$$

from the compact neighbourhood  $\tilde{K}$  to the invariant set at infinity  $S$  such that for all  $\lambda \in [0, 1[$ , the compact set  $K_\lambda := cl(H(\lambda, \tilde{K})^c)$  is an isolating neighbourhood in the Poincaré hemisphere  $\mathcal{H}$ . The map being a retraction means:

$$\begin{aligned} \forall x \in \tilde{K} \quad , \quad & H(0, x) = x, \\ \forall x \in \tilde{K} \quad , \quad & H(1, x) \in S \\ \forall \lambda \in [0, 1], \forall x \in S \quad , \quad & H(\lambda, x) = x, \\ \forall \lambda < \mu \in [0, 1] \quad , \quad & H(\lambda, \tilde{K}) \supsetneq H(\mu, \tilde{K}) \end{aligned}$$

We skip the proof of the equivalence as it is quite similar to the proof of proposition 3.5.4 in the previous paragraph.

In the case of the Bendixson compactification, the point at infinity being of isolated invariant complement was equivalent to the existence of a compact set  $\mathcal{F}$  containing all bounded trajectories. In the context of Poincaré compactification, we may observe the existence of an invariant set of isolated invariant complement in the sphere at infinity without the existence of a maximal bounded invariant

set  $\mathcal{F}$ . In fact, the existence of a maximal bounded invariant set  $\mathcal{F}$  is equivalent to the whole sphere at infinity  $\mathcal{E}$  being of isolated invariant complement. The set  $\mathcal{F}$  contains all globally bounded trajectories, which remains for all time bounded away from the sphere at infinity.

However, all the isolating neighbourhoods  $K'$  in the first definition 3.5.30 or equivalently the  $K_\lambda$  in the second definition 3.5.31, all isolate the same invariant set. We introduce the following notation:

**Definition 3.5.32.** Let  $S \subset \mathcal{E}$  be a set of isolated invariant complement. We define  $S_{comp}$  as the union of all trajectories for which whether the  $\alpha$ -limit set nor the  $\omega$ -limit set intersects  $S$ , or

$$S_{comp} := \{x \in \mathcal{H} / \alpha(x) \cap S = \omega(x) \cap S = \emptyset\}.$$

We denote  $S_{comp}$  by "complement" of  $S$ , not to be confused with the complement of  $S$  in  $\mathcal{H}$  denoted by  $S^c$ .

**Proposition 3.5.33.** *Let  $S$  be a set of isolated invariant complement. Then its complement  $S_{comp}$  is isolated invariant. Let  $K$  be a compact fulfilling the three conditions of the definition 3.5.1. Then every compact neighbourhood  $K'$  containing  $K$  isolates  $S_{comp}$ , in particular holds*

$$Inv(K') = Inv(K) = S_{comp}.$$

*Furthermore, let  $N$  be an isolating neighbourhood of  $S_{comp}$ . Then the compact  $N$  fulfills the three conditions of Definition 3.5.1.*

*Proof.* The proof is analog to the proof of proposition 3.5.2. □

**Remark 3.5.34.** The relationship between  $S$  and  $S_{comp}$  is comparable to the relationship between the point at infinity and the maximal bounded invariant set  $\mathcal{F}$  in the case of the Bendixson compactification. If the sphere at infinity  $\mathcal{E}$  is of isolated invariant complement, then  $\mathcal{E}_{comp} = \mathcal{F}$  is the set containing all bounded orbits. Otherwise the set  $S_{comp}$  and the sphere at infinity have no reason to be disjoint.

**Definition 3.5.35.** Let  $S$  be a compact set, invariant under a normalized flow on the Poincaré hemisphere and contained in the sphere at infinity. If the set  $S$  is of isolated invariant complement, we define the Conley index of  $S$  at infinity  $\hat{h}(S)$  as

$$\hat{h}(S) := h^-(S_{comp}),$$

where  $h^-(S_{comp})$  is the classical Conley index of  $S_{comp}$  computed with reversed time direction.

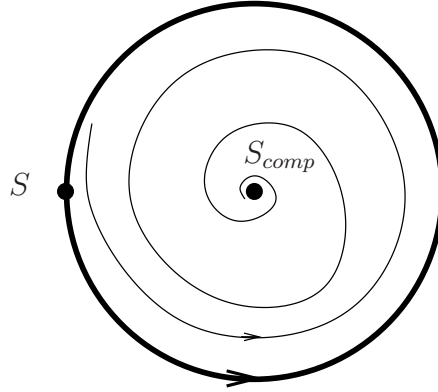

Figure 3.13: Classical index and index at infinity differs.

**Remark.** We want to recall here that, the Poincaré hemisphere  $\mathcal{H}$  being a manifold with boundary, the Conley indices split into three parts

$$\begin{aligned}\hat{h}(\mathcal{H}; S) &:= h^-(\mathcal{H}; S_{comp}) \\ \hat{h}(\mathcal{H}, \mathcal{E}; S) &:= h^-(\mathcal{H}, \mathcal{E}; S_{comp}) \\ \hat{h}(\mathcal{E}; S) &:= h^-(\mathcal{E}; S_{comp})\end{aligned}$$

as explained in ref.

**Proposition 3.5.36.** *Let  $S$  be an invariant set of isolated invariant complement  $S_{comp}$ . If we denote the homological and cohomological Conley index at infinity of  $S$  by  $\hat{H}_*$  and  $\hat{H}^*$  respectively, then the following equalities hold.*

$$\begin{aligned}\hat{H}^k(\mathcal{H}, \mathcal{E}; S) &= H_{n-k}(\mathcal{H}; S_{comp}) \\ \hat{H}^k(\mathcal{H}; S) &= H_{n-k}(\mathcal{H}, \mathcal{E}; S_{comp}) \\ \hat{H}^k(\mathcal{E}; S) &= H_{n-k}(\mathcal{E}; S_{comp})\end{aligned}$$

*Proof.* This is a direct consequence of Theorem 3.4.2 on time duality of the Conley index.  $\square$

**Remark 3.5.37.** If a set  $S \subset \mathcal{E}$  is both isolated invariant and of isolated invariant complement, then both indices  $h(S)$  and  $\hat{h}(S)$  are defined. They may not coincide as we see in figure 3.13. There we have an equilibrium  $S$  on the sphere at infinity of trivial classical Conley index  $h(\mathcal{H}; S) = h(\mathcal{H}, \mathcal{E}; S) = h(\mathcal{E}; S)$ . Its complement  $S_{comp}$  is a stable equilibrium at the origine whose Conley index is  $h(S_{comp}) = \Sigma^0$ . Hence holds  $\hat{h}(\mathcal{H}; S) = \hat{h}(\mathcal{H}, \mathcal{E}; S) = \Sigma^2$  and  $\hat{h}(\mathcal{E}; S) = \bar{0}$ .

Now let us state a proposition analog to 3.5.12 in the case of the classical Conley index and giving existence of trajectories accumulating on an invariant set  $S$  at infinity.



**Proposition 3.5.38.** *Consider a compactified flow on the Poincaré hemisphere  $\mathcal{H}$  admitting an invariant set  $S \subset \mathcal{E}$  at infinity of isolated invariant complement.*

- *If the Conley index at infinity  $\hat{h}(S)$  is the index of a repeller (In the sense of Definition 3.1.39), then there exists a trajectory accumulating on  $S$  in backward time direction, and on a  $\omega$ -limit set in  $S_{comp}$  in forward time direction. More precisely there exists a  $x \in \mathcal{H}$  such that*

$$\begin{cases} S \cap \alpha(x) \neq \emptyset \\ S_{comp} \cap \alpha(x) = \emptyset \\ \omega(x) \subset S_{comp} \end{cases}$$

- *If the Conley index at infinity  $\hat{h}(S)$  is the index of an attractor (in the sense of Definition 3.1.39), then there exists a trajectory accumulating on  $S$  in forward time direction, and on a  $\alpha$ -limit set in  $S_{comp}$  in backward time direction. More precisely there exists a  $x \in \mathcal{H}$  such that*

$$\begin{cases} S \cap \omega(x) \neq \emptyset \\ S_{comp} \cap \omega(x) = \emptyset \\ \alpha(x) \subset S_{comp} \end{cases}$$

- *If the Conley index at infinity  $\hat{h}(\infty)$  is neither that of an attractor nor that of a repeller then there exist trajectories accumulating on  $S$  in backward time direction, and trajectories accumulating on  $S$  in forward time direction. More precisely there exist  $x_1, x_2 \in \mathcal{F}$*

$$\begin{cases} S \cap \alpha(x_1) \neq \emptyset \\ S \cap \omega(x_2) \neq \emptyset \end{cases}$$

The proof is analog to the proof of 3.5.12, replacing the point at infinity  $\infty$  by  $S$  and the maximal bounded invariant set  $\mathcal{F}$  by the complement to  $S$ , i. e.  $S_{comp}$ .

The following proposition address a very natural question: Is it true that the disjoint union of invariant sets of isolated invariant complement builds again an invariant set of isolated invariant complement? We know that this is true for isolated invariant sets. The proposition answers the question with yes.

**Proposition 3.5.39.** *Consider a compactified semiflow on the Poincaré hemisphere  $\mathcal{H}$ . Assume that there exists a finite collection  $\{S_i\}_{i=1}^n \subset \mathcal{E}$  of compact invariant sets in the sphere at infinity that are pairwise disjoint and of isolated invariant complements  $\{S_{i,comp}\}_{i=1}^n \subset \mathcal{H}$ .*

Then the disjoint union  $\bigcup_{i=1}^n S_i \subset \mathcal{E}$  is an invariant set of isolated invariant complement. Furthermore holds

$$\left( \bigcup_{i=1}^n S_i \right)_{comp} = \bigcap_{i=1}^n S_{i_{comp}}.$$

If  $\{N_{i_\lambda}\}_{i=1}^n$  is a continuous family of isolating neighbourhoods of  $S_{i_{comp}}$  as in property 3.5.31, then there exists a  $\lambda_0 \in [0, 1[$  such that for every  $\lambda \geq \lambda_0$ , the set  $cl\left(\bigcap_{i=1}^n int(N_{i_\lambda})\right)$  is an isolating block for  $\left(\bigcup_{i=1}^n S_i\right)_{comp}$ .

*Proof.* Set  $N_\lambda := cl\left(\bigcap_{i=1}^n int(N_{i_\lambda})\right)$ . For every  $\lambda \in [0, 1[$  holds

$$\bigcap_{i=1}^n S_{i_{comp}} = cl\left(\bigcap_{i=1}^n int(N_{i_\lambda})\right) \quad (3.14)$$

$$\supset Inv\left(\left(\bigcap_{i=1}^n int(N_{i_\lambda})\right)\right) = N_\lambda \quad (3.15)$$

the equality being a priori only valid for flows but not necessarily when there are multiple prehistories.

For  $\lambda$  big enough holds

$$\bigcap_{i=1}^n S_{i_{comp}} \subset \bigcap_{i=1}^n N_{i_\lambda} = int(N).$$

Assume indeed that there is for a  $\lambda \in [0, 1[$  a nonempty intersection

$$\bigcap_{i=1}^n S_{i_{comp}} \cap \partial N_{j_\lambda} \neq \emptyset.$$

As the set  $\bigcap_{i=1}^n S_{i_{comp}}$  is at a positive distance from  $S_j$  and the complement  $\mathcal{H} \setminus N_{j_\lambda}$  of  $N_{j_\lambda}$  in  $\mathcal{H}$  shrinks on  $S_j$  as  $\lambda$  increases, we have for a  $\lambda_j > \lambda$

$$\bigcap_{i=1}^n S_{i_{comp}} \subset int(N_{j_{\lambda_j}}).$$

Taking  $\lambda$  big enough guarantees

$$\bigcap_{i=1}^n S_{i_{comp}} \subset \bigcap_{i=1}^n N_{i_\lambda} = int(N_\lambda).$$

In particular we know now that for  $\lambda$  big enough,  $\bigcap_{i=1}^n S_{i_{comp}} \subset N_\lambda$ . The set  $\bigcap_{i=1}^n S_{i_{comp}}$  is invariant, so that it is contained in the maximal invariant set in  $N_\lambda$ , i. e.

$$\bigcap_{i=1}^n S_{i_{comp}} \subset Inv(N_\lambda).$$

Together with the inclusion 3.14 this implies equality

$$\bigcap_{i=1}^n S_{i_{comp}} = Inv(N_\lambda) \subset int(N_\lambda)$$

in other words  $N_\lambda$  is an isolating neighbourhood of  $\bigcap_{i=1}^n S_{i_{comp}}$  for every  $\lambda$  big enough. Finally it holds

$$\begin{aligned} N_1 &= cl \left( \bigcap_{i=1}^n int(N_{i_1}) \right) \\ &= cl \left( \bigcap_{i=1}^n (\mathcal{H} \setminus S_i) \right) \\ &= cl \left( \mathcal{H} \setminus \left( \bigcup_{i=1}^n (S_i) \right) \right). \end{aligned}$$

This equality shows that the complement of  $N_\lambda$  shrinks on the union  $\bigcup_{i=1}^n (S_i)$  so that holds for  $\lambda < 1$  but big enough

$$\begin{aligned} \left( \bigcup_{i=1}^n (S_i) \right)_{comp} &= Inv(N_\lambda) \\ &= \bigcap_{i=1}^n S_{i_{comp}} \end{aligned}$$

and the property is proven.  $\square$

Now let us describe how to detect heteroclinic orbits to sets of isolated invariant complements.

### Detection of heteroclinic orbits

In the context of Poincaré compactification, infinity is represented by a whole sphere  $\mathcal{E}$  which may contain several pairwise disjoint invariant sets  $\{S_i\}_{i=1}^k$  of isolated invariant complements  $\{(S_i)_{comp}\}_{i=1}^k$  (for the definition of the isolated invariant complement see 3.5.32). To describe the global structure of the compactified dynamic, we want to proceed to the same construction as in the case of the Bendixson compactification - but for all the invariant sets  $\{S_i\}_{i=1}^k$  at one time. For this, we will be needing a collection of isolating blocks  $\{B_i\}_{i=1}^k$  of the isolated invariant complements  $\{(S_i)_{comp}\}_{i=1}^k$  which are big enough so that their complements  $\mathcal{H} \setminus B_i$  in the Poincaré hemisphere are pairwise disjoint. This will allow us to extend the flow without creating branches of forward trajectories. More precisely, the condition reads:

$$(NIC) \quad \forall i \neq j \in \{1, \dots, k\} \\ cl(\mathcal{H} \setminus B_i) \cap cl(\mathcal{H} \setminus B_j) = \emptyset$$

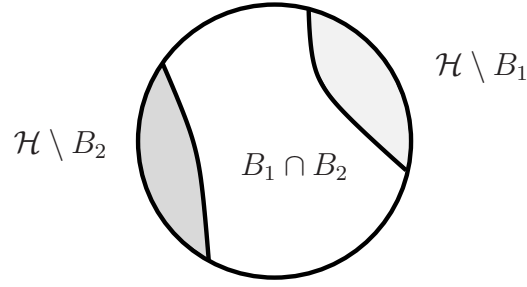

Figure 3.14: Two blocks satisfying Condition (NIC).

The condition (NIC) provide well separated  $\{cl(\mathcal{H} \setminus B_i)\}_{i=1}^k$ .

We illustrate it for  $n = 2$  in Figure 3.14: two blocks  $B_1$  and  $B_2$  fulfill the condition (NIC), their complements  $\mathcal{H} \setminus B_i$  do not intersect.

**Remark 3.5.40.** Let us consider a collection of blocks  $\{B_i\}_{i=1}^n$  satisfying the condition (NIC). Following Proposition 3.5.39, we define a  $B$  by setting

$$B = cl \left( \bigcap_{i=1}^n int(B_i) \right),$$

which is a priori only an isolating neighbourhood of  $(\bigcup_{i=1}^n S_i)_{comp}$ . It is easy to see that Condition (NIC) implies  $B = \bigcap_{i=1}^n B_i$ .

**Conjecture 3.5.41.** For every collection  $\{S_i\}_{i=1}^k \subset \mathcal{E}$  of pairwise disjoint invariant sets of isolated invariant complements, there exists a collection of compact neighbourhoods  $\{B_i\}_{i=1}^k$  such that

1. the set  $B_i$  is an isolating block for  $(S_i)_{comp}$ ,
2. the collection  $\{B_i\}_{i=1}^k$  satisfies the condition (NIC).

We know from Proposition 3.5.39 and its proof that we can find a family of isolating neighbourhoods satisfying the condition (NIC), but for isolating block it is not clear. However it was possible in the examples that we discuss. Let us assume the existence of such a family of blocks  $\{B_i\}_{i=1}^n$ .

**Claim 1:** Under this assumption the set

$$B = cl \left( \bigcap_{i=1}^n int(B_i) \right)$$

is an isolating block for  $(\bigcup S_i)_{comp}$ .

*Proof.* The set  $B$  is a compact neighbourhood because  $cl(int(B)) = cl(\bigcap_{i=1}^n int(B_i)) = B$ . Furthermore the set  $B$  contains  $(\bigcup_{i=1}^n S_i)_{comp} = \bigcap_{i=1}^n S_{i_{comp}}$  in its interior: for every  $i \in \{1, \dots, n\}$  holds  $S_{i_{comp}} \subset int(B_i)$  so that

$$\bigcap_{i=1}^n S_{i_{comp}} \subset \bigcap_{i=1}^n int(B_i) = int(B).$$

Finally holds the inclusion  $\partial B \subset \bigcup \partial B_i$ . The sets  $B_i$  being isolating blocks, they admit no internal tangency, and so does  $B$ . This completes the proof of the Claim 1.  $\square$

Moreover we prove the following.

**Claim 2:** The boundary, entrance and exit sets of the isolating block  $B$  split in the following way

$$\partial B = \bigcup_{i=1}^n \partial B_i \text{ and the union is disjoint.} \quad (3.16)$$

$$B^+ = \bigcup_{i=1}^n (B \cap B_i^+) \text{ and the union is disjoint.} \quad (3.17)$$

$$B^- = \bigcup_{i=1}^n (B \cap B_i^-) \text{ and the union is disjoint.} \quad (3.18)$$

*Proof.* As noticed previously, boundary, interior and closure are taken relatively to the Poincaré sphere  $\mathcal{H}$ . It holds

$$\begin{aligned} \partial B_i &= \partial(\mathcal{H} \setminus B_i) \\ &= cl(\mathcal{H} \setminus B_i) \setminus \mathcal{H} \setminus B_i. \end{aligned}$$

We assume the condition (NIC), which claims that the sets  $cl(\mathcal{H} \setminus B_i)$  are pairwise disjoint. Therefore the boundaries  $\partial B_i$  of the  $B_i$  relatively to  $\mathcal{H}$  are pairwise disjoint, and so are their subsets  $B \cap B_i^+$  and  $B \cap B_i^-$ .

The inclusion  $\partial B \subset \bigcup_{i=1}^n \partial B_i$  is obvious. The reverse inclusion  $\partial B \supset \bigcup_{i=1}^n \partial B_i$  is justified as follows. Consider a point  $x \in \partial B_i$  for a  $i \in \{1, \dots, n\}$ . Fix an arbitrary neighbourhood  $U$  of  $x$  in  $\mathcal{H}$ . The neighbourhood  $U$  intersects  $\mathcal{H} \setminus B_i$  as well as  $int(B_i)$ . The fact  $U \cap \mathcal{H} \setminus B_i \neq \emptyset$  implies

$$\begin{aligned} U \cap \bigcup_{i=1}^n (\mathcal{H} \setminus B_i) &= U \cap \left( \mathcal{H} \setminus \left( \bigcap_{i=1}^n B_i \right) \right) \\ &= U \cap \left( \mathcal{H} \setminus \left( \bigcap_{i=1}^n B_i \right) \right) \\ &\neq \emptyset \end{aligned}$$

As  $B = cl(\bigcap_{i=1}^n B_i) \subset \bigcap_{i=1}^n B_i$ ,  $U$  intersects also  $\mathcal{H} \setminus B$ .

Let us prove that  $U$  also intersects  $int(B)$ . As the point  $x \in \partial B_i$  we have

1. the neighbourhood  $U$  of  $x$  intersects  $int(B_i)$  and
2. for every  $j \neq i$  the distance  $dist(x, cl(\mathcal{H} \setminus B_j))$  is strictly positive because of the condition (NIC).

Hence for  $j \neq i$  holds

$$\begin{aligned} & \forall j \neq i \quad x \notin cl(\mathcal{H} \setminus B_j) \\ \Leftrightarrow & \forall j \neq i \quad x \in int(B_j) \\ \Leftrightarrow & x \in \bigcap_{i \neq j}^n int(B_j). \end{aligned}$$

Putting all together we get that  $U$  intersects  $int(B_i) \cap \left( \bigcap_{i \neq j}^n int(B_j) \right) = \bigcap_{j=1}^n int(B_j) = int(B)$ .

Now  $\partial B = \bigcup_{i=1}^n \partial B_i$  is proven.

Let us prove the two last equalities. For this, consider a point  $x \in \partial B$ . Because the Boundary of  $B$  is equal to the disjoint union  $\bigcup_{i=1}^n \partial B_i$ , the point  $x$  belongs to exactly one of the  $\partial B_i$  and we have the equivalence

$$\begin{aligned} x \text{ enters } B_i & \Leftrightarrow x \text{ enters } B \\ x \text{ leaves } B_i & \Leftrightarrow x \text{ leaves } B \end{aligned}$$

Hence the Claim 2 is proved. □

Let us now introduce the construction for the detection of heteroclinic orbits between the invariant sets  $S_i$  of isolated invariant complements and isolated invariant sets contained in  $B$ .

The idea of the construction of the extended phase space is to proceed for each  $B_i^\pm$  as in the case of the Bendixson compactification, where we only had a pair  $K^\pm$ . If we have "nice" retractions  $r_i^\pm$  from  $B_i^\pm$  to  $b_i^\pm$ , we glue  $B$  with the sets  $\{(\lambda, r_i^\pm(\lambda, B_i^\pm)), \lambda \in [0, 1]\}$  along  $\{0\} \times B_i^\pm \sim B_i^\pm$  and obtain the so called extended phase space. The details will be given below.

The construction of the extended flow is similar: as soon as a trajectory reaches a  $B_i^\pm$ , we extend this trajectory by following the retraction  $r_i^\pm$  from  $B_i^\pm$  to  $b_i^\pm$ , the time direction depending on the upper index  $+$  or  $-$ .

**Remark 3.5.42.** If the Conjecture 3.5.41 fails, and the Condition (NIC) is not fulfilled, it is still possible to detect heteroclinic orbits with the same method as we describe below. One must only consider one of the sets of isolated invariant complement at a time instead all simultaneously. In other words, do the following construction  $n$  times, one time for each of the  $S_i$ .

Now let us go into the details.

**First step: cut and glue**

Consider an isolating block  $B$  of  $(\bigcup_{i=1}^n S_i)_{comp}$  defined by  $B := cl(\bigcap_{i=1}^n int(B_i))$ , where  $B_i$  is a block for  $S_{i_{comp}}$  and the condition (NIC) is satisfied.

The entrance set  $B^+$  of  $B$  consists of  $n$  connected components  $\{B \cap B_i^+\}_{i=1}^n$ , and the exit set  $B^-$  of  $B$  consists of  $n$  connected components  $\{B \cap B_i^-\}_{i=1}^n$ . Assume that there exists  $2n$  retractions

$$r_i^\pm : [0, 1] \times B \cap B_i^\pm \rightarrow B \cap B_i^\pm$$

of  $B_i^\pm$  on  $b_i^\pm$ , that is

1.  $\forall x \in B \cap B_i^\pm, \forall s \in [0, 1], r_i^\pm(s, x) \in B \cap B_i^\pm$ ,
2.  $\forall x \in b_i^\pm, \forall s \in [0, 1], r_i^\pm(s, x) = x$ ,
3.  $\forall x \in B \cap B_i^\pm, r_i^\pm(0, x) = x$ ,
4.  $\forall x \in B \cap B_i^\pm, r_i^\pm(1, x) \in b_i^\pm$ .

The retractions  $r_i^\pm$  are also required to fulfill the conditions

- (C1)  $b_i^\pm \subset int_{\partial B} B_i^\pm$ , where the last denotes the interior of  $B_i^\pm$  relative to  $\partial B$ .
- (C2)  $\forall s \in [0, 1[, r_i^\pm(s, \cdot)$  is injective.

As in the case of the Bendixson compactification, those conditions are needed to extend the flow. We set

$$M_i^\pm := \{(r_i^\pm(s, x), s) \in [0, 1] \times B \cap B_i^\pm\}, \quad (3.19)$$

$$M := \left( \bigcup_{i=1}^n M_i^+ \right) \cup \left( \bigcup_{i=1}^n M_i^- \right) \quad (3.20)$$

This last union is not disjoint: for each  $i$ , the sets  $M_i^+$  and  $M_i^-$  may intersect at points of the form  $(x, s)$  where  $x \in B_i^+ \cap B_i^-$ , i. e.  $x$  is a point of external tangency to the block  $B_i$  for  $S_{i_{comp}}$ .

Furthermore define

$$m_i := \{(x, 0), x \in B \cap B_i^\pm\} \subset M_i^\pm \quad (3.21)$$

Now we glue each  $M_i^\pm$  along  $B \cap B_i^\pm \sim m_i^\pm$  through the following equivalence relation  $\sim$  on  $B \cup M$ : for all pair of points  $x, y \in B \cup M$ ,  $x \sim y$  if and only if

$$x = y \quad (3.22)$$

$$\text{or } \exists i \in \{1, \dots, n\}, e \in \{+, -\}, x \in m_i^e, y \in B \cap B_i^e \text{ and } x = (y, 0) \quad (3.23)$$

$$\text{or } \exists i \in \{1, \dots, n\}, e \in \{+, -\}, y \in m_i^e, x \in B \cap B_i^e \text{ and } y = (x, 0) \quad (3.24)$$

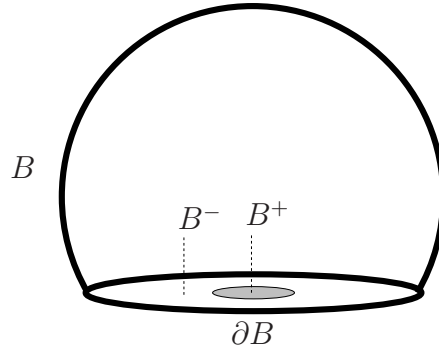
Figure 3.15: A block  $B$  for  $S_{comp}$ .

**Definition 3.5.43.** The extended phase space  $Ext(B)$  is defined as

$$Ext(B) = \frac{B \cup M}{\sim},$$

where the equivalence relation  $\sim$  is defined through 3.22.

**Example 3.5.44.** Let us construct the extended phase space for an example with  $n = 1$  =number of  $S_i$  of isolated invariant complements, to visualize how the extension works. For  $n > 1$ , the boundary of the block  $B$  relatively to the Poincaré hemisphere  $\mathcal{H}$  has more connected components on which the extension takes place.

We consider the compactification of a flow on  $\mathbb{R}^3$  so that the Poincaré hemisphere  $\mathcal{H}$  is a 3–dimensional manifold whose boundary  $\mathcal{E}$  is a 2–dimensional sphere at infinity. We draw  $\mathcal{H}$  as a 3–dimensional ball, the flattened hemisphere. Figure 3.15 shows an isolating block  $B$  for  $S_{comp}$ , where  $S$  is an invariant set at infinity of isolated invariant complement.

The boundary  $\partial B$  of  $B$  is a 2–dimensional disk. Its exit set  $B^-$  is a ring, hence it is retractable to a circle by a retraction  $r^-$  fulfilling Conditions (C1) and (C2). Its entrance set  $B^+$  is a 2–dimensional disk retractable to a single point by a retraction fulfilling Conditions (C1) and (C2). Figure 3.16 shows the extension of the phase space. This example will be continued in Example 3.5.48

**Remark 3.5.45.** The extended phase space is in general only a continuous manifold with boundary. We will comment on the smoothing of the extended space



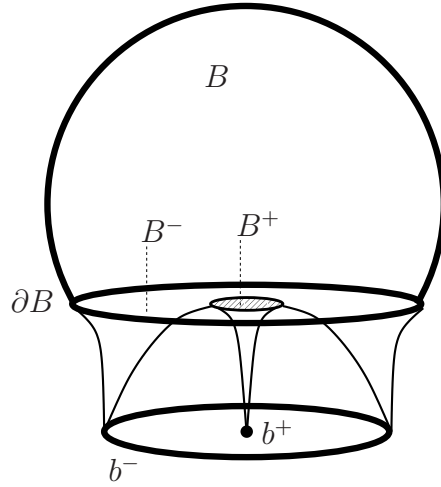

Figure 3.16: Extension of the phase space.

in Remark 3.5.52. The boundary  $\partial Ext(B)$  is the union

$$\begin{aligned} \partial Ext(B) = & \left( \bigcup_{i=1}^n \{(r_i^-(s, x), s), x \in B \cap B_i^+ \cap B_i^-, s \in [0, 1]\} \right) \\ & \cup \left( \bigcup_{i=1}^n \{(r_i^+(s, x), s), x \in B \cap B_i^+ \cap B_i^-, s \in [0, 1]\} \right) \\ & \cup \left( \bigcup_{i=1}^n b_i^+ \right) \cup \left( \bigcup_{i=1}^n b_i^- \right). \end{aligned}$$

Now we shall present the second step of the construction.

**second step: extend the flow**

As in the case of the Bendixson compactification, we construct an extension of the flow  $\varphi$  on  $B$  which follows the retractions  $r_i^\pm$  on the portions  $M_i^\pm$  of the extended phase space. More precisely, there exist for each  $x \in B$  times entrance and exit times  $T_-(x) \leq 0$  and  $T_+(x) \geq 0$  defined as

$$\begin{aligned} T_+(x) & := \sup\{t \leq 0 / \varphi(t, x) \in B\} \\ T_-(x) & := \inf\{t \geq 0 / \varphi(t, x) \in B\} \end{aligned}$$

Obviously, if  $T_+$  or  $T_-$  is finite, there holds

$$\begin{aligned} \varphi(T_+(x), x) & \in B^-, \\ \varphi(T_-(x), x) & \in B^+. \end{aligned}$$

As was proved in Claim 2, the sets  $B^+$  and  $B^-$  split in their connected components  $B \cap B_i^\pm$  so that there are for each  $x \in B$  with  $T_+$  or  $T_-$  finite, unique  $i(x)$  and  $j(x) \in \{1, \dots, n\}$  such that

$$\begin{aligned}\varphi(T_+(x), x) &\in B \cap B_{i(x)}^-, \\ \varphi(T_-(x), x) &\in B \cap B_{j(x)}^+.\end{aligned}$$

On the other hand, for each point  $(y, s) \in M_i^\pm$  with  $s \in [0, 1[$ , there exists a unique point  $Y(y) \in B \cap B_i^\pm$  for which  $r_i^\pm(s, Y(y)) = (y, s)$ .

For an initial condition  $x \in B$ , the extended flow  $\hat{\varphi}(t, x)$  is defined as follows:

$$\hat{\varphi}(t, x) = \begin{cases} \varphi(t, x) & \text{if } t \in [T_-(x), T_+(x)] \in B, \\ \left( r_{j(x)}^-(e^{T_+(x)-t}, X(x)), 1 - e^{T_+(x)-t} \right) & \in M_j^- \text{ for } t \geq T_+(x) \\ \left( r_{i(x)}^+(e^{t-T_-(x)}, X(x)), 1 - e^{t-T_-(x)} \right) & \in M_i^+ \text{ for } t \leq T_-(x) \end{cases} \quad (3.25)$$

In particular  $T_-(x) = -\infty$  implies  $\hat{\varphi}(t, x) = \varphi(t, x)$  for all  $t \leq 0$ , and  $T_+(x) = +\infty$  implies  $\hat{\varphi}(t, x) = \varphi(t, x)$  for all  $t \geq 0$ . Therefore,  $Inv_{\hat{\varphi}}(B) = Inv_\varphi(B)$ .

For an initial condition  $(y, s) \in M_i^-$ , the associated point  $Y(y) \in B \cap B_i^-$  with  $y = r_i^-(s, Y(y))$  belongs to  $B$  such that  $\hat{\varphi}(t, Y(y))$  is well defined through 3.25 for all  $t \in \mathbb{R}$ . Hence we can define  $\hat{\varphi}(t, (y, s))$  by the following:

$$\hat{\varphi}(t, (y, s)) = \begin{cases} (y, 1) & \text{if } s = 1 \\ \hat{\varphi}(t - \log(1 - s), Y(y)) & \text{if } s \in [0, 1[ \end{cases} \quad (3.26)$$

For an initial condition  $(y, s) \in M_i^+$ , the associated point  $Y(y) \in B \cap B_i^+$  with  $y = r_i^+(s, Y(y))$  belongs to  $B$  such that  $\hat{\varphi}(t, Y(y))$  is well defined through 3.25 for all  $t \in \mathbb{R}$ . Hence we can define  $\hat{\varphi}(t, (y, s))$  by the following:

$$\hat{\varphi}(t, (y, s)) = \begin{cases} (y, 1) & \text{if } s = 1 \\ \hat{\varphi}(\log(1 - s) - t, Y(y)) & \text{if } s \in [0, 1[ \end{cases} \quad (3.27)$$

**Proposition 3.5.46.** *The map  $\hat{\varphi} : \mathbb{R} \times \underline{BUM} \rightarrow \underline{BUM}$  defined through the Formulas 3.25, 3.26 and 3.27 is a continuous flow on the extended space.*

*Proof.* The proof of this proposition is totally similar to the proof of the Proposition 3.5.17 concerning the Bendixson compactification. The only difference is the following: to each trajectory through  $x \in B$  under the compactified flow  $\varphi$  that leaves the block  $B$  in forward time direction, is associated a unique  $i(x) \in \{1, \dots, n\}$  such that, at exit time  $+\infty > T_+(x) \geq 0$ ,  $\varphi(T_+(x), x) \in B \cap B_i^-$ , and the map  $x \mapsto i(x)$  is locally constant around points for which  $T_+(x)$  is finite. The same is true in backward time direction: to each trajectory through  $x \in B$  which leaves block  $B$  in backward time direction, is associated a unique

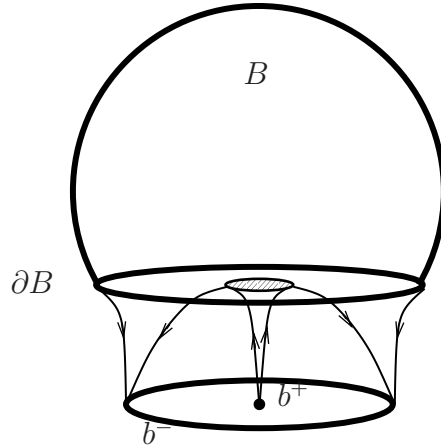

Figure 3.17: Extension of the flow.

$j(x) \in \{1, \dots, n\}$  such that, at entrance time  $-\infty < T_-(x)$ ,  $\varphi(T_-(x), x) \in B \cap B_j^+$ , and the map  $x \mapsto j(x)$  is locally constant around points with finite entrance time. This provides the continuity of  $\hat{\varphi}$ . The flow  $\hat{\varphi}$  defined through 3.25, 3.26 and 3.27 fulfills the semi group properties by the same calculation as in the Bendixson case, replacing  $r^+$  by one of the  $r_{i(x)}^+$  and  $r^+$  by one of the  $r_{j(x)}^+$ .  $\square$

**Remark 3.5.47.** As in the case of the Bendixson compactification, it is also possible in the case of the Poincaré compactification to extend a semi low by extending each of its full trajectory.

**Example 3.5.48.** The extended flow for Example 3.5.44 is illustrated in Figure 3.17, as far as  $M$  is concerned.

**Proposition 3.5.49.** *Under the extended flow  $\hat{\varphi}$  on the extended phase space  $Ext(B)$ , there holds for all  $i \in \{1, \dots, n\}$  that*

- *The set  $k_i^-$  are attractors.*
- *The sets  $k_i^+$  are repellers.*

The proof of this proposition is similar to the proof of Proposition 3.5.19 in the case of the Bendixson compactification.

**Third step: compare indices**

**Theorem 3.5.50.** *Consider a compactified semi flow  $\varphi$  on the Poincaré hemisphere  $\mathcal{H}$ . Assume that the sphere  $\mathcal{E}$  at infinity contains a finite collection  $\{S_i\}_{i=1}^n$*

of pairwise disjoint invariant sets of isolated invariant complement. Assume furthermore that there exist a collection  $\{B_i\}_{i=1}^n$  of isolating blocks of the  $\{S_{i_{comp}}\}_{i=1}^n$  fulfilling the condition (NIC). Set

$$B := cl \left( \bigcap_{i=1}^n \text{int}(B_i) \right),$$

which is an isolating block for  $(\bigcup_{i=1}^n S_i)_{comp}$  according to Claim 1. After construction of the extended phase space  $Ext(B)$  defined by 3.5.43 and of the extended semi flow  $\hat{\varphi}$  defined by 3.25 and 3.26 hold the following:

- Assume that there exists an isolated invariant set  $S \subset Ext(B)$  with respect to the extended flow  $\hat{\varphi}$  that admits an attractor–repeller decomposition of the form  $(k_i^-, R)$  for a  $i \in \{1, \dots, n\}$  and an invariant subset  $R$  of  $(\bigcup_{i=1}^n S_i)_{comp}$ . If

$$h(S) \neq h(k_i^-) \vee h(R),$$

then there exists an orbit  $\sigma$  of the semi flow  $\varphi$  on  $\mathcal{H}$  such that

$$\begin{aligned} \alpha(\sigma) &\subset R, \\ \omega(\sigma) \cap S_i &\neq \emptyset; \end{aligned}$$

*i. e.* the trajectory  $\sigma$  connects  $R$  to the invariant set  $S_i$  at infinity.

- Assume that there exists an isolated invariant set  $S \subset Ext(B)$  with respect to the extended flow  $\hat{\varphi}$  that admits an attractor–repeller decomposition of the form  $(A, k_i^+)$  for a  $i \in \{1, \dots, n\}$  and an invariant subset  $A$  of  $(\bigcup_{i=1}^n S_i)_{comp}$ . If

$$h(S) \neq h(k_i^+) \vee h(A),$$

then there exists an orbit  $\sigma$  of the semi flow  $\varphi$  on  $\mathcal{H}$  such that

$$\begin{aligned} \omega(\sigma) &\subset A, \\ \alpha(\sigma) \cap S_i &\neq \emptyset; \end{aligned}$$

*i. e.* the trajectory  $\sigma$  connects the invariant set  $S_i$  at infinity to  $A$ .

**Example 3.5.51.** We show on Figure 3.18 an full extended flow on  $B$  for Example 3.5.44, 3.5.48. The red connection is detected by the Conley index. Consider a cylindric neighbourhood of it, intersected with  $Ext(B)$  and denote it by  $K$ . The set  $K$  is an isolating block, as the reader will easily convince himself. We draw it on the right hand side of Figure 3.18 together with its exit set  $K^- \subset \partial K$  in red. If  $C := Inv(K)$ , there holds

$$\begin{aligned} h(Ext(B); C) &= \bar{0} \\ h(Ext(B), \partial Ext(B); C) &= \Sigma^3 \end{aligned}$$

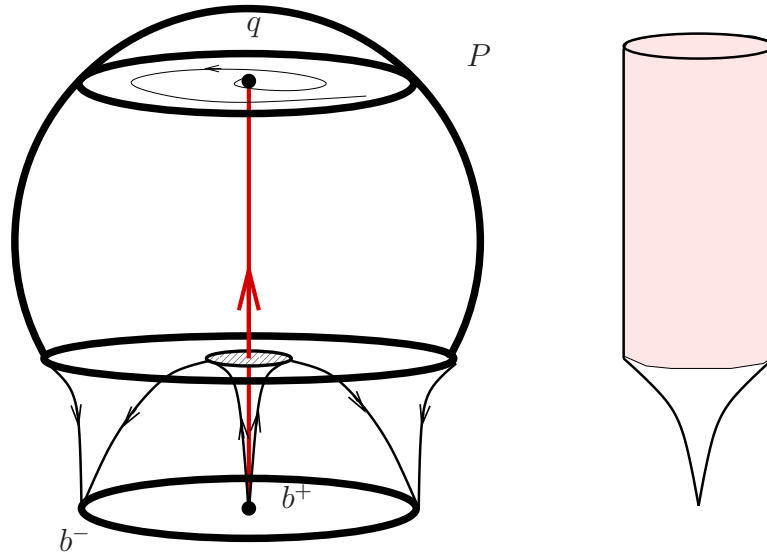

Figure 3.18: Flow on  $Ext(B)$ .

On the other hand, the set  $S$  admits an attractor–repeller decomposition  $(\{q\}, b^+)$  and the Conley indices of these read

$$h(q) = \Sigma^2 = h(Ext(B); q)h(Ext(B), \partial Ext(B); b^+), \text{ and}$$

$$\begin{aligned} h(Ext(B); b^+) &= \bar{0} \\ h(Ext(B), \partial Ext(B); b^+) &= \Sigma^3 \end{aligned}$$

It holds

$$\begin{aligned} h(Ext(B); C) &\neq h(Ext(B); b^+) \vee h(Ext(B); q), \\ h(Ext(B), \partial Ext(B); C) &\neq h(Ext(B), \partial Ext(B); b^+) \vee h(Ext(B), \partial Ext(B); q), \end{aligned}$$

so that the existence of the red orbit is proved, and translates via Theorem 3.5.50 to an orbit  $\sigma$ , under the compactified flow  $\varphi$  on the Poincaré hemisphere  $\mathcal{H}$ , from the set  $S$  of isolated invariant complement in the bottom to the equilibrium  $q$ , or more precisely

$$\begin{aligned} \alpha(\sigma) \cap S &\neq \emptyset \\ \omega(\sigma) &= \{q\} \end{aligned}$$

**Remark 3.5.52.** As in the case of the Bendixson compactification, we seek smoothness both of the extended phase space  $Ext(B)$  and of the extended flow  $\hat{\varphi}$ , because it allows to use the connection maps and the machinery from algebraic topology to detect heteroclinic orbits through connection matrix theory. Again,

the smoothness of the retractions  $r_i^\pm$  is a necessary condition. A smoothing of the extension both at the sutures  $B_i^\pm$  and at the extremities  $b_i^\pm$  of the portions of extensions should be generically possible. Therefore we state the following conjecture.

**Conjecture 3.5.53.** Generically, it is possible to smoothen the extended phase space  $Ext(B)$  and the extended semi flow  $\hat{\varphi}$  on  $Ext(B)$

**Theorem 3.5.54.** *Under the assumptions of Theorem 3.5.50, and assuming that there exists a smoothing of the extended phase space  $Ext(B)$  and of the extended semi flow  $\hat{\varphi}$ , we have:*

- Assume there exists an isolated invariant set  $S \subset Ext(B)$  with respect to the extended flow  $\hat{\varphi}$  that admits an attractor–repeller decomposition of the form  $(k_i^-, R)$  for a  $i \in \{1, \dots, n\}$  and an invariant subset  $R$  of  $(\bigcup_{i=1}^n S_i)_{comp}$ . If the connection map

$$\delta : H_*(R) \rightarrow H_*(k_i^-)$$

is not trivial, then there exists an orbit  $\sigma$  of the semi flow  $\varphi$  on  $\mathcal{H}$  such that

$$\begin{aligned} \alpha(\sigma) &\subset R, \\ \omega(\sigma) \cap S_i &\neq \emptyset; \end{aligned}$$

*i. e. the trajectory  $\sigma$  connects  $R$  to the invariant set  $S_i$  at infinity.*

- Assume there exists an isolated invariant set  $S \subset Ext(B)$  with respect to the extended flow  $\hat{\varphi}$  that admits an attractor–repeller decomposition of the form  $(A, k_i^+)$  for a  $i \in \{1, \dots, n\}$  and an invariant subset  $A$  of  $(\bigcup_{i=1}^n S_i)_{comp}$ . If the connection map

$$\delta : H_*(k_i^+) \rightarrow H_*(A)$$

is not trivial, then there exists an orbit  $\sigma$  of the semi flow  $\varphi$  on  $\mathcal{H}$  such that

$$\begin{aligned} \omega(\sigma) &\subset A, \\ \alpha(\sigma) \cap S_i &\neq \emptyset; \end{aligned}$$

*i. e. the trajectory  $\sigma$  connects the invariant set  $S_i$  at infinity to  $A$ .*

**Remark 3.5.55.** The fact that the  $k_i^-$  are attractors provides a nontrivial homology  $H_0(Ext(B); k_i^-)$ , and the topology of  $k_i^-$  may produce further nontrivial homologies  $H_j(Ext(B); k_i^-)$ . The type of connections that we expect to be detectable via our methods are from isolated invariant sets  $R$  with whether  $H_1(R)$  nontrivial, or  $H_{j+1}(R)$  nontrivial, so that the connection maps

$$\begin{aligned} \delta &: H_1(Ext(B); R) \rightarrow H_0(Ext(B); k_i^-), \\ \delta &: H_{j+1}(Ext(B); R) \rightarrow H_j(Ext(B); k_i^-), \end{aligned}$$

have a chance to be nontrivial.

Similarly for the  $k_i^+$ , we have  $H_n(k_i^+)$  nontrivial, where  $n$  is the dimension of the original phase space. Further homologies  $H_j(k_i^+)$  may be non trivial. For these, we look for isolated invariant sets  $A$  with  $H_{j-1}(A)$  non trivial, so that the connection maps

$$\begin{aligned}\delta : H_n(k_i^+) &\rightarrow H_{n-1}(A), \\ \delta : H_j(k_i^+) &\rightarrow H_{j-1}(A),\end{aligned}$$

have a chance to be nontrivial.

Now we address the question of the Morse decompositions.

### Morse decompositions

The Theorem 3.5.54 lays the groundwork to apply connection matrix theory to the extended semi flow. If the collection  $\{b_i^\pm\}_{i=1}^n$  can meld with a Morse decomposition of  $(\bigcup_{i=1}^n S_i)_{comp}$ , then they are at the extremities of some chain of order because they are attractors and repellers respectively. The connection matrix detects heteroclinics of the extended flow  $\hat{\varphi}$ , which translate to heteroclinic orbits of the compactified flow  $\varphi$  on  $\mathcal{H}$  via Theorem 3.5.54.

## 3.6 Limitations and properties

The following proposition underlines the fact that the Conley index of infinity being defined (in the classical way or over duality) implies the existence of interesting dynamics.

**Proposition 3.6.1.** *Consider a flow on the Bendixson sphere. Suppose that the point at infinity is no regular point, and that no orbit connects to it whether in forward time nor in backward time. Then the point at infinity is neither isolated invariant, nor of isolated invariant complement. In other words its Conley index is not defined.*

*Proof.* First let us prove indirectly that the point at infinity, alias the north pole, is not isolated invariant. We call  $\Phi$  the compactified and normalized flow on the Bendixson sphere. Suppose there exists an compact set  $K \subset \mathcal{S}$  isolating the point at infinity, i. e. it holds  $Inv(K) = \{\infty\} \subset int(K)$ . Now consider a sequence  $(x_n)_{n \in \mathbb{N}}$  converging to the point at infinity, but for all  $n \in \mathbb{N}$ ,  $x_n \neq \infty$ . As we chose  $x_n \notin Inv(K)$ , there is a time  $t_n \neq 0$  such that  $x_n$  has left  $K$  at time  $t_n$ , but is not gone too far: More precisely we fix a compact supset  $K'$  of  $K$  with  $K \subset int(K')$ . For every  $n$ , there exists a real number  $t_n \neq 0$  with  $\Phi(x_n, t_n) \in K' \setminus K$ . It is possible to choose  $t_n$  such that  $|t_n|$  is strictly increasing. Furthermore, up to a subsequence,  $(t_n)_{n \in \mathbb{N}}$  is of constant sign. As  $\Phi(x_n, t_n)$  lies in the compact set  $K'$ , it converges, up to a subsequence, to a limit  $x \in K'$ . The

sequence  $|t_n|$  cannot be bounded, otherwise it would converge to a finite  $t \in \mathbb{R}$  and as  $\Phi$  is continuous and  $(x_n)_{n \in \mathbb{N}}$  converges to the point at infinity, we would have  $\Phi(x, t) = \infty$  which cannot be the case for a normalized flow. So  $(|t_n|)_{n \in \mathbb{N}}$  goes to infinity, and the point at infinity is in the  $\alpha$  or  $\omega$  limit set of  $x$ , according to the sign of the sequence  $(t_n)_{n \in \mathbb{N}}$ . So we proved the first part of the claim.

Let us remark that replacing  $\{\infty\}$  by any invariant set  $\Sigma \subset \mathcal{S}$ , we just proved: if the set  $\Sigma$  is isolated invariant, there is a  $x \in \mathcal{S} \setminus \Sigma$  such that  $\alpha(x) \subset \Sigma$  or  $\omega(x) \subset \Sigma$ .

Now let us prove indirectly the second part of the claim. Suppose the point at infinity is of isolated invariant complement. We call  $R$  the maximal invariant set common to all complements of sufficiently small open neighbourhoods of the north pole. Applying the above remark to  $\Sigma = R$ , we find a  $x$  whose  $\alpha$  or  $\omega$  limit set is contained in  $R$ . It cannot be both of them, otherwise  $x$  itself would lie in  $R$ . So the trajectory through  $x$  connects  $R$  to infinity, which completes the proof.  $\square$

Of course we have an analog proposition concerning the Poincaré compactification.

**Proposition 3.6.2.** *If an invariant set at infinity  $S \subset \mathcal{E}$  admits no orbit connecting to it, then it is neither isolated invariant nor of isolated invariant complement.*

Let us comment about the realization of our method in concrete cases. In fact, the extension of the phase space and the flow is something abstract: all what we need to detect heteroclinics is

- A block  $K$  for  $\mathcal{F}$  (in the case of the Bendixson compactification) or for  $(\bigcup_{i=1}^n S_i)_{comp}$  (in the case of the Poincaré compactification).
- The homotopy type of the entrance and exit sets ( $k^\pm$  in the case of the Bendixson compactification,  $\{b_i^\pm\}_{i=1}^n$  in the case of the Poincaré compactification).
- Isolating blocks for the connections up to the boundary of  $K$

The third ingredient is the most problematic one, but it is always a difficulty in Conley index methods to find isolating blocks. The point is that the ingredients needed do not require an explicit extension: we only need to know that it exists and that Proposition 3.5.19 (Bendixson) or 3.5.49 (Poincaré) holds, telling that the  $k^\pm$  or  $k_i^\pm$  are attractor or repeller respectively.

The same is true for the smoothing: it is sufficient to know that it is possible to get the extended phase space and the extended flow smooth, but it is not necessary to perform it explicitly.

Finally we want to point out a limitation of this method: already in  $\mathbb{R}^2$ , presence of elliptic and hyperbolic sectors at an equilibria prevents both notions of isolation. Hence we cannot apply our construction in this case.



# Chapter 4

## Ordinary differential equations

### 4.1 Generalities on polynomial vector fields

Polynomial vector fields provide good examples for our approach because they are easily normalized under both compactifications we are using and they provide a wide variety of behaviours at infinity. Therefore we consider them as a good playground to explore the possibilities of Conley index methods to study dynamics at infinity. In this section we present a collection of known results concerning their behaviour at infinity.

#### 4.1.1 Classification results

Many authors have classified polynomial vector fields in the plane according to their Poincaré compactified phase portrait; see Schlomiuk, Vulpe [36, 40], Artés, Cairo, Llibre [2, 7], Brunella, Miari [4]. The sphere at infinity  $\mathcal{E}$  is, in this case, a one dimensional sphere  $S^1$ , which is invariant under the compactified flow. Therefore the dynamics on the sphere at infinity is rather simple: the whole sphere at infinity may be a periodic orbit under the compactified flow; otherwise it contains equilibria and the solutions that are not stationary follow an arc of the circle and are connections between equilibria. The study of the dynamics at infinity (i. e. in a neighbourhood of the sphere at infinity) almost reduces to the study of equilibria. The difficulty lies in the fact that these equilibria may be very degenerate in the sense that the first non zero derivative of the compactified vector field is of high order, so that methods as presented in [30] or [1] are not always powerful enough. We quote in a later section a result by Artés and Llibre, Theorem 4.3.1, where the zoo of all possible Poincaré compactified phase portraits of quadratic Hamiltonian planar vector fields is presented; see [2]. Their result is also based on a former classification of planar quadratic vector fields with a center by Vulpe [40].

Another important theorem has been proven by Schlomiuk and Vulpe in [36].

They classify essentially quadratic planar vector fields according to their phase portrait in a neighbourhood of the sphere at infinity. They obtain 40 different phase portraits. Of these, 24 admit only equilibria at infinity for which the classical Conley indices are well defined; 13 of them also admit equilibria at infinity which are of isolated invariant complement without being isolated invariant, so that the methods developed in the previous chapter apply; 3 of the 40 possible phase portraits show equilibria with both hyperbolic and elliptic sectors so that they are neither isolated invariant nor of isolated invariant complement and Conley index methods do not apply at all.

To obtain this result, they first reduce the number of parameters. The number of coefficients of the two polynomials is 12, the number of parameters after reduction is 5. Algebraic invariants and comittants of polynomials are used together with integer-valued invariants related to the dynamic near the sphere at infinity. There are other papers dealing with such questions, which address cubic vector fields or even vector fields of higher degree, but restrict to very specific classes of equations, see for example [7]. In the zoo of phase portraits presented in this paper, the sphere at infinity consists only of equilibria, and thus these phase portraits could only provide example for the Bendixson compactification, but the Poincaré compactification is not a good choice to study them with Conley index methods.

### 4.1.2 Critical points at infinity

This section is dedicated to applications of compactification methods on polynomial vector fields which do not involve Conley index methods at all, but concentrate on equilibria or critical points at infinity and the study of the local dynamic near them. The local analysis of equilibria at infinity may give information on the existence of unbounded solutions. Indeed consider a Poincaré compactified vector field which admits a hyperbolic equilibrium on the equator. Hyperbolicity together with the fact that the equator is flow invariant, guarantees that the eigenvectors span the whole tangent half space: one of them points to the interior of the half space (i. e. the interior of the Poincaré hemisphere) and the other eigenvectors build a basis of the tangent space to the equator at the equilibrium. If the eigendirection pointing to the interior of the Poincaré hemisphere is stable, then there is a trajectory which follows this direction, and hence is unbounded in forward time direction. On the contrary, if the eigendirection pointing to the interior of the Poincaré hemisphere is unstable, then there is a trajectory which, following this unstable direction, is unbounded in backward time direction. This idea has been deepened in several papers on which we shall report here.

We to begin this section by summarizing the paper [19] by Velasco. This paper deals with generic properties and structural stability of the dynamics on the sphere at infinity for polynomial vector fields. A property is called generic in

this context if it holds for an open and dense subset of the vector space

$$\mathcal{X} = \{ \text{polynomial vector fields on } \mathbb{R}^n \text{ of degree } \leq d \}.$$

The dimension  $n$  and the degree  $d$  being fixed, each vector field  $f \in \mathcal{X}$  can be identified with the vector of its coefficients. Hence  $\mathcal{X}$  is finite dimensional. If  $f \in \mathcal{X}$  is a vector field on  $\mathbb{R}^n$ , it induces, after Poincaré compactification and normalization, a vector field on the Poincaré hemisphere  $\mathcal{H}$  and in particular a vector field on the equator  $\mathcal{E}$  of  $\mathcal{H}$ , alias the  $(n-1)$ -dimensional sphere at infinity defined through Equation 2.10: following [19] we denote this induced vector field on the sphere  $\mathcal{E}$  at infinity by  $\pi_\infty(f)$ . An important result which holds in any dimension is the following:

**Theorem 4.1.1.** *Define*

$$\mathcal{Hyp} := \{ f \in \mathcal{X} / \text{every equilibrium of } \pi_\infty(f) \text{ is hyperbolic} \}.$$

*The set  $\mathcal{Hyp}$  is open and dense in  $\mathcal{X}$ . In other words, an equilibrium of  $\pi_\infty(f)$  on the sphere at infinity is generically hyperbolic.*

The proof of this theorem relies on standard methods and are not detailed in [19].

**Remark 4.1.2.** The hyperbolicity in this theorem concerns only the dynamic on the sphere at infinity. The behaviour in a  $\mathcal{H}$ -neighbourhood around an equilibrium at infinity could still be degenerate.

For more precise results, planar vector fields and higher dimensional ones have to be distinguished.

If the original vector field is planar, its Poincaré compactification has a 2-dimensional disk as phase space, the 2-dimensional Poincaré hemisphere. Hence the sphere at infinity  $\mathcal{E}$  is a circle. Either  $\mathcal{E}$  contains equilibria and connections between them, or the whole sphere at infinity builds a periodic orbit.

In the first case the equilibria of the vector field  $\pi_\infty(X)$  may be hyperbolic or not. Define

$$\mathcal{P} := \{ f \in \mathcal{X} / \pi_\infty(X) \text{ admits at least one non-hyperbolic equilibrium} \}.$$

In the second case, the sphere at infinity  $\mathcal{E}$  may be a hyperbolic periodic orbit in the Poincaré hemisphere or belong to a ring of periodic orbits. Define

$$\mathcal{O} := \{ f \in \mathcal{X} / \mathcal{E} \text{ has zero Floquet exponent} \}.$$

The next theorem states that the behaviours at infinity are generically not in  $\mathcal{P}$  or  $\mathcal{O}$ .

**Theorem 4.1.3.** *Consider the space  $\mathcal{X}$  of polynomial planar vector fields. The set  $\mathcal{G}$  defined as*

$$\mathcal{G} = \mathcal{X} \setminus (\mathcal{P} \cup \mathcal{O})$$

*is open and dense in  $\mathcal{X}$ .*

The proof of this theorem is based on the fact that there exist explicit formulas to determine if a vector field is in  $\mathcal{P} \cup \mathcal{O}$  or not.

The set  $\mathcal{P}$  is contained in the union of varieties (i. e. zero level sets of polynomial functions) which does not coincide with the whole space  $\mathcal{X}$ , so that  $\mathcal{X} \setminus \mathcal{P}$  is open and dense. The argumentation for the density of  $\mathcal{X} \setminus \mathcal{O}$  is more demanding, but here again the computation of an explicit integral formula allows to check whether a vector field  $X$  belongs to  $\mathcal{O}$  or not. For details see [19].

Let us recall the definition of structural stability in the context of the dynamics at infinity.

**Definition 4.1.4.** A vector field  $f \in \mathcal{X}$  is structurally stable at infinity if and only if there exists a neighbourhood  $N$  of the sphere  $\mathcal{E}$  at infinity in  $\mathcal{H}$  and a neighbourhood  $U$  of  $f$  in  $\mathcal{X}$  such that for every  $g \in U$ , there exists a homeomorphism  $h : N \rightarrow N$  leaving the sphere at infinity  $\mathcal{E}$  invariant and transforming trajectories of the Poincaré compactification of  $f$  into trajectories of the Poincaré compactification of  $g$ .

**Remark 4.1.5.** This definition does not only concern the vector field  $\pi_\infty(f)$  on the sphere at infinity  $\mathcal{E}$ , but the compactification of the vector field  $f$  in a whole neighbourhood of infinity in  $\mathcal{H}$ , and in this way it differs from Theorems 4.1.1 or 4.1.3.

If  $\Sigma$  denotes the set of all vector fields  $f \in \mathcal{X}$  that are structurally stable at infinity, González Velasco proves that in the planar case there holds

$$\Sigma = \mathcal{G}.$$

This fact has important consequences. In particular, a vector field  $f$  is structurally stable as soon as all equilibria of  $\pi_\infty(f)$  on  $\mathcal{E}$  are hyperbolic. Such an equilibrium at infinity could show homoclinic petals in the interior of the Poincaré hemisphere without losing its structural stability.

In higher dimensions the results of [19] are restricted to gradient vector fields. We will see in Theorem 4.2.1 that gradient vector fields induce a strict Lyapunov function for the vector field  $\pi_\infty(f)$  on the sphere at infinity. As a consequence,  $\alpha$ ,  $\omega$ -limit sets of trajectories on the sphere at infinity, or more generally the non-wandering set  $\Omega(\pi_\infty(f)) \subset \mathcal{E}$ , is the set of critical points of the vector field  $\pi_\infty(f)$  induced on  $\mathcal{E}$  by  $f$ . The paper [19] formulates the following genericity result:

**Theorem 4.1.6.** *Let  $f$  be a gradient polynomial vector field on  $\mathbb{R}^n$  and  $\pi_\infty(f)$  its induced vector field on the sphere  $\mathcal{E}$  at infinity. The non-wandering set  $\Omega(\pi_\infty(f))$  is generically a finite union of hyperbolic equilibria.*

This theorem is a consequence of Theorem 4.1.1 together with Theorem 4.2.1. This work contains no result on structural stability in dimension greater than 2.

Another genericity result on polynomial vector fields related to their dynamics at infinity was proven by Cima and Llibre in [8]. This work deals with polynomial vector fields on  $\mathbb{R}^n$  whose trajectories are bounded in forward time direction and their aim is to classify them with respect to their dynamic at infinity, which takes place in the backward time direction. For each  $m = (m_1, \dots, m_n) \in \mathbb{N}^n$  define

$$\mathcal{X}_m := \{\text{polynomial vector field } f = (P^1, \dots, P^n) \text{ on } \mathbb{R}^n / \deg(P^i) = m_i\}.$$

Furthermore, define for each  $i \in \{1, \dots, n\}$  the homogenous part of  $P^i$  of highest degree as  $P_{m_i}^i$ . For vector fields  $f = (P^1, \dots, P^n)$  in  $\mathcal{X}_m$ , the set of all bounded equilibria is bounded if and only if the vector field built from the componentwise homogenous parts of highest degrees  $g = (P_{m_1}^1, \dots, P_{m_n}^n)$  admits only the origin as equilibrium. The set  $\mathcal{G}_m$  is the set of vector fields with this property; in other words,

$$\mathcal{G}_m := \{f = (P^1, \dots, P^n) \in \mathcal{X}_m / g = (P_{m_1}^1, \dots, P_{m_n}^n) \text{ admits only the origin as equilibrium}\}.$$

The following is proven:

**Theorem 4.1.7.** *There exists a polynomial function  $\Phi : \mathcal{X}_m \rightarrow \mathbb{R}$  such that the set  $\mathcal{X}_m \setminus \mathcal{G}_m$  is contained in the hypersurface  $\Phi^{-1}(0)$  of  $\mathcal{X}_m$ . In particular, belonging to  $\mathcal{G}_m$  is a generic property, i. e.  $\mathcal{G}_m$  is open and dense in  $\mathcal{X}_m$ .*

This theorem means that the homogenous part of highest degree  $g$  of a polynomial vector field  $f$  generically does not contribute to the finite dynamics. For example, the homogenous vector field  $g$  on  $\mathbb{R}^n$  generically does not show any line of equilibria, but concentrates the finite dynamics of  $f$  at the origin.

Next, let us summarize [14]. This paper stresses the fact that admitting a critical point at infinity is an intrinsic property of a vector field and not an artefact of the chosen compactification. There, autonomous polynomial vector fields in  $\mathbb{R}^n$  are considered. We generalize, as far as it is possible, to a general Hilbert space  $X$  whose scalar product and norm are denoted by  $\langle \cdot, \cdot \rangle$  and  $\|\cdot\|$  respectively. This part may seem repetitive after the introduction of the Poincaré compactification, but we want to show here that there is a more general way to define compactifications called “admissible” (see definition 4.1.8 below) and critical points at infinity. Conley index methods apply with these compactification as well, as long as the conditions for its definition are fulfilled. An admissible compactification is defined by the following:

**Definition 4.1.8.** Let  $\kappa : X \rightarrow \mathbb{R}$  be a  $C^1$  strictly positive function, and  $U$  the unit ball of  $X$ . The mapping

$$\begin{aligned} T &: X \rightarrow U \\ y &\mapsto x = \frac{y}{\kappa(y)} \end{aligned}$$

is called an admissible compactification if it satisfies the following four conditions:

1.  $\kappa(y) > \|y\|$
2.  $\kappa(y) \sim \|y\|$  as  $\|y\| \rightarrow \infty$
3.  $\nabla\kappa(y) \sim \frac{y}{\|y\|}$  as  $\|y\| \rightarrow \infty$
4.  $\langle y, \nabla\kappa(y) \rangle < \kappa(y)$

The first condition guarantees that the whole space  $X$  is mapped on the interior of the unit ball  $U$ . The second condition guarantees that infinity is mapped on the boundary  $\partial U$ . The third condition guarantees the “normalisation”, so that trajectories do not run into critical points at the boundary in finite time; this will be the point of Proposition 4.1.13. Finally the fourth condition guarantees the bijectivity of the map  $T$ . Indeed holds

$$\begin{aligned} Id &= \kappa(y)DT(y) + \frac{\langle \nabla\kappa(y), y \rangle}{\kappa(y)} Id \\ DT(y) &= \frac{1}{\kappa(y)} \left( 1 - \frac{\langle \nabla\kappa(y), y \rangle}{\kappa(y)} \right) Id. \end{aligned}$$

Hence  $T$  is locally invertible if and only if  $\kappa(y) - \langle \nabla\kappa(y), y \rangle \neq 0$ . Since this quantity is positive at  $y = 0$ , Condition 4 of definition 4.1.8 is justified. Global bijectivity is then given by the fact that every ray  $\lambda y, \lambda \in \mathbb{R}, y \in X$  contains its image under  $T$ : on every ray, local bijectivity implies global bijectivity onto the image. Therefore the map  $T^{-1} : U \rightarrow X$  is well defined.

The Poincaré compactification can be seen as an admissible compactification if we consider the flattened Poincaré hemisphere. The corresponding map  $\kappa$  is given by  $\kappa(y) = (1 + \langle y, y \rangle)^{1/2}$ . It is straightforward to verify the conditions 1-4 of definition 4.1.8. The Conley index methods expounded in the previous chapter are, of course, applicable with any admissible compactifications: the point is that the neighbourhoods of infinity have to be made bounded (compare to compactification) for those methods to apply, and without destroying the flow or semiflow properties (compare to normalization). If it seems more convenient, they may be applied on any admissibly compactified phase space.

Tending to infinity in the direction  $p, \|p\| = 1$ , is defined by the following:

**Definition 4.1.9.** Consider a sequence of points  $(y_n)_{n \in \mathbb{N}} \subset X$ . This sequence is said to tend to infinity in the direction  $p, \|p\| = 1$ , if and only if  $y_k/\|y_k\|$  goes to  $p$  as  $k$  goes to infinity.

Now if, on the Hilbert space  $X$ , we consider the differential equation

$$y_t = f(y), \quad (4.1)$$

we get, after application of an admissible compactification, the following differential equation on the open unit ball  $U$  of  $X$ :

$$x_t = \frac{1}{\kappa}(f(\kappa x) - \langle \nabla \kappa, f(\kappa x) \rangle x) \quad (4.2)$$

Here here  $\kappa = \kappa(T^{-1}(x))$ . We have the following proposition.

**Proposition 4.1.10.** *The point  $x_0 \in U$  is a critical point of equation 4.2 if and only if the point  $y_0 := T^{-1}(x_0)$  is a critical point of equation 4.1.*

*Proof.* If  $y_0$  is a critical point of 4.1, then  $f(\kappa x) = f(\kappa(y_0)x) = f(y_0) = 0$ , so that  $x_0$  is a critical point of 4.2. The converse is a consequence of the fourth condition of definition 4.1.8. Equilibria of equation 4.2 are given by the equation

$$f(\kappa x) - \langle \nabla \kappa, f(\kappa x) \rangle x = 0. \quad (4.3)$$

This implies, by doing the scalar product with  $\nabla \kappa$ ,

$$\langle \nabla \kappa, f(\kappa x) \rangle (1 - \langle \nabla \kappa, x \rangle) = 0. \quad (4.4)$$

According to Condition 4 on admissible compactifications, there holds

$$|\langle \nabla \kappa, x \rangle| = |\langle \nabla \kappa(y), y/\kappa(y) \rangle| < 1.$$

Hence  $(1 - \langle \nabla \kappa, x \rangle) \neq 0$ , so that Equality 4.4 implies  $\langle \nabla \kappa, f(\kappa x) \rangle = 0$ , which together with Equation 4.3 implies  $f(y) = f(\kappa x) = 0$ : i. e.  $y$  is a critical point of Equation 4.1.  $\square$

**Remark.** In other words, the previous proposition tells us that finite equilibria in the original equation are equivalent to equilibria in the interior of the unit disk  $U$  for the rescaled equation.

Equation 4.2 is singular at the boundary of the unit disk  $\partial U$ , which represents the directions at infinity. As we have seen for the Bendixson and Poincaré compactification, this equation has to be normalized to make sense there. We apply these technics to polynomial vector fields of the form

$$f(y) = p_0(y) + p_1(y) + \dots + p_L(y), \quad (4.5)$$

where each  $p_i$  is the homogeneous part of  $f$  of degree  $i$ . The normalization of the vector field is straightforward and given by

$$\tilde{f}(x) = \kappa^{-L} f(\kappa x) = \kappa^{-L} p_0(x) + \kappa^{-L+1} p_1(x) + \dots + p_L(x), \quad (4.6)$$

where  $\kappa^{-L}$  is strictly positive so that no new equilibria arise and trajectories are unchanged by the multiplication of the vector field by  $\kappa^{-L}$ . After the orientation preserving change of time variable

$$d\tau = \kappa^{L-1}(y(t))dt, \quad (4.7)$$

Equation 4.2 transforms to its compactified version on the closed unit ball  $\bar{U}$  of  $X$

$$x_\tau = \tilde{f}(x) - \langle \nabla \kappa, \tilde{f}(x) \rangle x. \quad (4.8)$$

This equation allows to define the notion of critical point or equilibrium at infinity.

**Definition 4.1.11.** The original equation 4.1 on  $X$  is said to have a critical point at infinity in direction  $x \in X$ ,  $\|x\| = 1$ , if and only if Equation 4.8 admits  $x \in \partial U$  as a critical point.

**Remark 4.1.12.** On the boundary  $\partial U$ , Equation 4.8 reads

$$x_\tau = p_L(x) - \langle \nabla \kappa, p_L(x) \rangle x, \quad (4.9)$$

exactly like in the case of the Poincaré compactification, see 2.10.

In the case of polynomial vector fields, blow-up in forward or backward time direction corresponds to critical points at infinity as described in the following proposition:

**Proposition 4.1.13.** *If a trajectory of equation 4.1 blow up in finite (forward or backward) time direction, and tends to infinity in direction  $p$ , then  $p$  is a critical point of the compactified equation 4.8 on  $\partial U$ .*

*Proof.* Let us consider a blow-up in positive time direction, the case of a blow-up in negative time direction is proven similarly. Let  $T > 0$  be the blow-up time where by assumption holds  $\lim_{t \nearrow T} \frac{y(t)}{\|y(t)\|} = p$ . For the rescaled variable  $x \in \bar{U}$  holds according to the condition (2) of the Definition 4.1.8 of an admissible compactification

$$x = \frac{y}{\kappa} \sim \frac{y}{\|y\|} \rightarrow p \text{ as } \|y\| \rightarrow +\infty.$$

The rescaled time variable  $\tau$  goes to  $+\infty$  as  $t \nearrow T$ : the contrary leads to the regularity of  $p$  and provides, after rescaling back to the original variables  $y, t$ , a contradiction to the maximality of  $T$ . Hence it holds  $\lim_{\tau \rightarrow +\infty} x(\tau) = p$ , and as a consequence  $p$  is a critical point of Equation 4.8  $\square$

Furthermore the notion of critical point is not an artefact of the compactification, but an intrinsic property of the dynamical system as the next proposition shows.



**Proposition 4.1.14.** *The definition of a critical point at infinity is independent of the choice of the admissible compactification.*

The proof of this property is obvious when considering the proposition 4.1.15. Now let us point out which equation governs the dynamics on  $\partial U$ , which is the sphere at infinity.

**Proposition 4.1.15.** *The dynamics inside the sphere at infinity  $\partial U$  is independent of the choice of the compactification and is governed by the following equation, which depends only on the highest order terms of the polynomial vector field:*

$$x_\tau = p_L(x) - \langle x, p_L(x) \rangle x \quad (4.10)$$

Here  $x \in \partial U$  i. e.  $\|x\| = 1$ . Furthermore, if  $p \in \partial U$  is a critical point of 4.10, so is  $-p$ .

*Proof.* The map  $\tilde{f}$  defined on  $U$  by the Equation 4.6 admits a limit as the variable  $x$  tends to the boundary  $\partial U = \{\|x\| = 1\}$  of  $U$ :

$$\lim_{x \rightarrow \partial U} \tilde{f}(x) = p_L(x)$$

Together with Condition (3) of Definition 4.1.8, Equation 4.10 holds on the boundary.

The last claim comes from the fact that the right hand side of Equation 4.10 is odd or even; the homogeneity of  $p_L$  implies

$$p_L(-x) - \langle -x, p_L(-x) \rangle (-x) = (-1)^L (p_L(x) - \langle x, p_L(x) \rangle x).$$

Hence, if  $p$  is an equilibrium of Equation 4.10, so is  $-p$ . □

If the dynamics inside the sphere at infinity depends only on the highest order terms, we have to take more terms into account to determine the dynamics near critical points at infinity. More precisely, in [14] Elias and Gingold prove the following:

**Proposition 4.1.16. Rate of blow up.**

*Consider a polynomial equation of the form 4.1 on a finite dimensional space  $X = \mathbb{R}^n$ , where the degree of the vector field is  $L$ . Assume it admits a critical point  $p$  at infinity. The linearisation of the rescaled Equation 4.8 at an equilibrium  $p \in \partial U$  (i. e. the Jacobian  $J(p)$  of the right hand side) depends only on the terms  $p_L$  and  $p_{L-1}$ . Assume furthermore that  $p$  is a stable equilibrium (i. e. the eigenvalues  $\lambda_i$  of  $J(p)$  have all a strictly negative real part) and no resonance relations of the form*

$$\lambda_j = \sum_{i=1}^k m_i \lambda_i,$$

are satisfied, where  $m_i \geq 0$  are integers.

Then there exists an  $n$ -parameter family of solutions of Equation 4.1 tending to infinity in the direction  $p$  at the blow-up rate

$$\|y(t)\| = c(T - t)^{-1/(L-1)} \text{ as } t \nearrow T,$$

where  $T > 0$  is the blow-up time, and  $c$  is a constant. The same is true for the equilibrium  $-p$  at infinity

We do not reproduce the proof of this proposition here because it relies on a particular admissible compactification, which we do not wish to introduce here in details. This compactification being chosen, the Jacobian is computed and the claim of Theorem 4.1.16 follows. For details, see [14].

The paper [33] by Röhrl and Walcher also presents results on the existence of unbounded solutions using other compactification schemes. The originality of this paper is to propose alternative compactifications, not only on the unit disc or the Poincaré hemisphere, but more generally on a hypersurface of the form

$$\{\rho(x) = \alpha\},$$

where  $\rho : X \rightarrow \mathbb{R}$  is an homogeneous polynomial of fixed degree. The authors of [33] prove the existence of unbounded trajectories in the original system by the analysis of “equilibria at infinity” which are also in this context critical points of the compactified system lying in the the projection of infinity. Examples of degenerate situations in the plane are given, where the methods of [1] and [30, 2.11] work out nicely. Second order equations are also considered and some conditions for the existence of unbounded solutions are given. No result are given concerning heteroclinic connections to infinity, however.

In the Paper [9] by Coleman, a more general point of view is taken for the analysis of the dynamics at infinity in the sense that the tools presented there can deal with invariant sets at infinity other than equilibria. The theory developed there deals with “positive limit orbits”, as defined in 4.1.17 below. Consider a polynomial vector field of degree  $d$  on  $\mathbb{R}^n$  written as

$$x_t = p_d(x) + p(x), \tag{4.11}$$

where  $p_d$  is the homogenous part of the vector field of degree  $d$ , and  $p$  contains all the terms of lower order. In parallel, we consider the homogenous vector field of degree  $d$  on  $\mathbb{R}^n$

$$z_t = p_d(z). \tag{4.12}$$

The two vector fields 4.11 and 4.12 show the same dynamics at infinity. The system 4.12 undergoes the following “radial” change of variables:

$$\begin{cases} r = \|z\|, \text{ radius} \\ y = \frac{z}{\|z\|} \in \text{unit sphere } S^{n-1} \\ d\tau = r^{k-1} dt, \text{ normalized time variable,} \end{cases} \tag{4.13}$$

This change of variables is not really a compactification because the radius may grow indefinitely. The unit sphere here is NOT the sphere at infinity: if a trajectory  $z$  converges to a finite equilibrium  $e$ , the corresponding variable  $y$  will also converge to the equilibrium  $\frac{e}{\|e\|}$ , which is no equilibrium at infinity in the sense of the compactifications encountered previously. In the variables  $r, y, \tau$ , the flow is global and the equations describing it read

$$r_\tau = \langle ry, p_d(y) \rangle \quad (4.14)$$

$$y_\tau = p_d(y) - \langle y, p_d(y) \rangle y. \quad (4.15)$$

Now we have all of the ingredients to define the positive limit orbits.

**Definition 4.1.17.** An orbit  $\Gamma = \{z(t), t \in [0, T]\}$  solving the homogenous System 4.12 is a positive limit orbit if its corresponding orbit  $\{(r(\tau), y(\tau)), \tau \in \mathbb{R}\}$  solving the System (4.14, 4.15) is such that the orbit  $\{y(\tau), \tau \in \mathbb{R}\} \subset S^{n-1}$  is contained in the  $\omega$ -limit set of a solution of Equation 4.15 on the unit sphere  $S^{n-1}$ .

**Remark 4.1.18.** This definition invites to a few comments. Positive limit orbits are solution of the homogenous Equation 4.12, hence no trajectory of the original Equation 4.11: only their behaviour at infinity are comparable, because they are governed by the terms of highest degree. In Equation 4.12, and very roughly speaking, the finite dynamics is squeezed to the origin.

Positive limit orbits are subsets of  $\mathbb{R}^n$ . They are characterized by the fact that, after the radial change of Variables 4.13, the orbit of the variable  $y$  on the unit sphere  $\{y(\tau), \tau \in \mathbb{R}\}$  is contained in an  $\omega$ -limit set of the flow defined by Equation 4.15 on the unit sphere and independant of the radial variable  $r$ . This  $\omega$ -limit may be an equilibrium, a periodic orbit, or some more sophisticated invariant set in the unit sphere with respect to the flow defined by Equation 4.15. An  $\omega$ -limit arising in this way as a positive limit orbit does not need to be isolated invariant in the sense of Definition 3.1.3: it could be, for example, an equilibrium of center type surrounded by periodic orbits.

The study of the behaviour of the radial variable  $\{r(\tau), \tau \in \mathbb{R}\} \subset \mathbb{R}_*^+$  of a positive limit orbit gives us information about whether the positive limit orbit converges "at infinity" or not. More precisely, the type numbers are defined by the following:

**Definition 4.1.19.** Let  $\Gamma$  be a positive limit orbit with coordinates  $(r(\tau), y(\tau))$ ,  $\tau \in \mathbb{R}$ . The upper type number of  $\Gamma$  is defined as

$$M(\Gamma) := \limsup_{\tau \rightarrow +\infty} \frac{1}{\tau} r(\tau).$$

The lower type number of  $\Gamma$  is defined as

$$m(\Gamma) := \liminf_{\tau \rightarrow +\infty} \frac{1}{\tau} r(\tau).$$

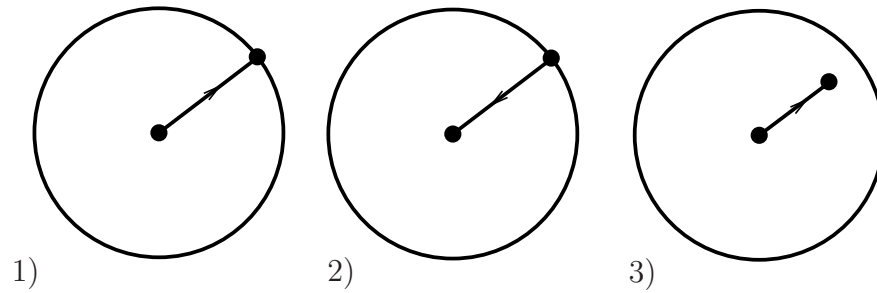

Figure 4.1: Three examples for the type numbers.

**Example 4.1.20.** Let us explain the concept of type numbers through three examples of compactified flow on the Poincaré hemisphere. Figure 4.1 represents the Poincaré compactification of three positive limit orbits  $\{z(t), t \in [0, T]\}$  on the Poincaré hemisphere. Those orbits run along a ray from the origin. Hence the corresponding variable  $y = \frac{z}{\|z\|} \in \partial U$ , the unit sphere of  $\mathbb{R}^2$ , is stationary for all three cases. The long-time behaviour of the radius differs for the three cases, which is reflected by the type numbers.

In the first case,

$$\lim_{\tau \rightarrow +\infty} r(\tau) = +\infty,$$

such that

$$\limsup_{\tau \rightarrow +\infty} \frac{r(\tau)}{\tau} \geq \liminf_{\tau \rightarrow +\infty} \frac{r(\tau)}{\tau} \geq 0.$$

Both type numbers are strictly positive if the growth of  $r$  is at least exponential.

In the second case

$$\lim_{\tau \rightarrow +\infty} r(\tau) = 0,$$

such that

$$0 \geq \limsup_{\tau \rightarrow +\infty} \frac{r(\tau)}{\tau} \geq \liminf_{\tau \rightarrow +\infty} \frac{r(\tau)}{\tau}.$$

Both type numbers are strictly negative if the decay of  $r$  is exponential.

In the last case,

$$\lim_{\tau \rightarrow +\infty} r(\tau) = a > 0.$$

It follows that

$$\lim_{\tau \rightarrow +\infty} \frac{r(\tau)}{\tau} = 0.$$

Both type numbers are equal to zero.

The concept of type numbers allows one to prove the following theorems:

**Theorem 4.1.21.** *If the upper and lower type numbers of every positive limit orbits of system 4.12 are negative, then system 4.11 is bounded in forward time direction.*

**Theorem 4.1.22.** *If system 4.12 admits a ray solution (i. e. a solution running along a ray from the origin) with a positive type number, then the system 4.11 is unbounded.*

In fact, the ray defines an equilibrium on the sphere at infinity. A positive type number implies that a trajectory coming from the inside of the Poincaré hemisphere accumulates in forward time direction on the equilibrium at the “end” of the ray from the origin. Note that one may also consider negative time  $\tau$  direction and get similar results.

The interplay between the dimension of the phase space and the degree of the polynomial vector field influences the existence of unbounded orbits. The following theorem holds:

**Theorem 4.1.23.** *Suppose the homogenous system 4.12 has an isolated critical point at the origin.*

- *If the degree  $k$  of the polynomial field is even, then the homogenous system 4.12 admits a ray solution with positive type number.*
- *If the dimension  $n$  of the phase space is odd, then the homogenous system 4.12 admits a ray solution, but not necessarily one with a positive type number.*
- *If  $k$  is odd and  $n$  is even, there need not be any ray solution at all.*

As a consequence holds the following corollary.

**Corollary 4.1.24.** *If  $k$  is even and the origin is an isolated critical point of the homogenous system 4.12, then the system 4.11 is unbounded.*

Those results are concerned with existence or non-existence of blow-up or grow-up and gives also information on the behaviour at infinity. However this theory is based on the homogenous version, Equation 4.12, and not on the original equation, Equation 4.11. Therefore it does not take the finite dynamics into consideration. Hence no information about transfinite heteroclinics can be expected.

## 4.2 Gradient vector fields

In this section we consider a polynomial gradient vector field in  $\mathbb{R}^n$ . Let  $V : \mathbb{R}^n \rightarrow \mathbb{R}$  be a polynomial of degree  $d$ . We consider the vector field defined by

$$x_t = -\nabla V(x), \quad x \in \mathbb{R}^n. \quad (4.16)$$

Due to the fact that

$$\frac{dV(x(t))}{dt} = -\langle \nabla V(x(t)), \nabla V(x(t)) \rangle \leq 0,$$

the quantity  $V$ , often called the potential, is strictly decreasing along trajectories, except at equilibria, where it has no other choice than to be constant. This implies that all of the  $\omega$  or  $\alpha$ -limit sets are equilibria, and that we have a Morse decomposition (for a precise definition of this concept see Chapter 3). Gradient vector fields exhibit this very convenient property, which makes them quite special. However according to Theorem 3.1.66 by Conley, they can be considered as a model for every vector field. This theorem says that, up to recurrent behaviour, every field is gradient. For this reason, we draw special attention to them.

We prove that we have the same type of structure in the sphere at infinity.

**Proposition 4.2.1.** *Let  $V : \mathbb{R}^n \rightarrow \mathbb{R}$  be a polynomial potential of degree  $d$ . The vector field on  $\mathbb{R}^n$  given by*

$$x_t = -\nabla V(x)$$

*induces a vector field on the sphere at infinity by Poincaré compactification and normalization. This induced vector field on  $\mathcal{E}$  admits a Lyapunov function. As a consequence, the  $\omega$  or  $\alpha$ -limit sets, as well as the non-wandering set in the sphere at infinity consist of equilibria only. Moreover, the sphere at infinity admits a Morse decomposition.*

*Proof.* Let us decompose  $V$  into two parts:

$$V = v_d + w,$$

where  $v_d$  contains all the terms of highest degree  $d$ , and  $w$  contains all terms of degree at most  $d - 1$ . We work now with the equation 2.7 giving the time evolution of  $(\chi, z) \in \mathcal{H}$  because it is the only equation offering an overview of the sphere at infinity as a whole. After normalization by multiplying with  $z^{d-2}$ , the equations on the Poincaré hemisphere  $\mathcal{H}$  have the following form:

$$\chi_\tau = \langle \chi, \nabla v_d(\chi) + z^{d-1} \nabla w(z^{-1} \chi) \rangle \chi - (\nabla v_d(\chi) + z^{d-1} \nabla w(z^{-1} \chi)) \quad (4.17)$$

$$z_\tau = \langle \chi, \nabla v_d(\chi) + z^{d-1} \nabla w(z^{-1} \chi) \rangle z \quad (4.18)$$

The terms of lower order disappear as  $z$  goes to zero and the dynamics in the sphere at infinity  $\mathcal{E}$  where  $z = 0$  is governed by the equation

$$\chi_t = -(\nabla v_d(\chi) - \langle \chi, \nabla v_d(\chi) \rangle \chi). \quad (4.19)$$

Now we compute the derivative with respect to the time of  $v_d(\chi(t))$ :

$$\begin{aligned} \frac{dv_d(\chi(t))}{dt} &= \langle \chi_t, \nabla v_d(\chi) \rangle \\ &= \langle \chi_t, \nabla v_d(\chi) - \langle \chi, \nabla v_d(\chi) \rangle \chi \rangle \text{ as } \chi \perp \chi_t \\ &= -\langle \chi_t, \chi_t \rangle \leq 0. \\ &= 0 \text{ if and only if } \chi_t = 0 \end{aligned}$$

Hence  $v_d$  is a strict Lyapunov function for the dynamics in the sphere at infinity; i. e. it decreases strictly along trajectories - unless the trajectory is stationary. This proves the claim.  $\square$

**Remark 4.2.2.** The same is true for a potential  $V$  of polynomial growth; i.e. where  $V$  is of the form  $V(x) = \sum_{|\alpha|=d} a_\alpha x^\alpha + g(x)$ , where  $\frac{\nabla g(x)}{\|x\|^{d-1}} \rightarrow 0$  as  $x$  goes to infinity.

**Remark 4.2.3.** As already pointed out, a gradient vector field induces a Morse decomposition with bounded equilibria as Morse sets. On the one hand, if the potential  $V$  is polynomial, its homogenous part of highest degree induces a Morse decomposition of the sphere at infinity  $\mathcal{E}$ , with equilibria at infinity as Morse sets. Unfortunately, the only knowledge of these two separated Morse decompositions is not sufficient to reconstruct a global Morse decomposition of the whole Poincaré hemisphere. It remains to determine if and how the two partial orders meld to build an admissible order on the union of the Morse sets of the two decompositions.

**Remark 4.2.4.** In the proof of this proposition we make no use of the finite dimensionality. The same is true for an infinite dimensional Hilbert space  $X$ . We will see in the next chapter that this plays an important role.

## 4.3 Hamiltonian vector fields

### 4.3.1 Generalities on Hamiltonian vector fields

Another class of well known vector fields is the class of Hamiltonian vector fields. In this context, there is a  $C^2$  energy function (or Hamiltonian)  $H$  on  $\mathbb{R}^{2n}$  with the coordinates  $(x, y) \in \mathbb{R}^n \times \mathbb{R}^n$ . The energy  $H : \mathbb{R}^{2n} \rightarrow \mathbb{R}$  generates a vector field

$$x_t = \frac{\partial H}{\partial y}(x, y) \quad (4.20)$$

$$y_t = -\frac{\partial H}{\partial x}(x, y), \quad (4.21)$$

with the property that  $H$  is constant along trajectories . This fact follows from

$$\frac{d}{dt}H(x(t), y(t)) = \left\langle \left( \frac{\partial H}{\partial x}, \frac{\partial H}{\partial y} \right), \left( \frac{\partial H}{\partial y}, -\frac{\partial H}{\partial x} \right) \right\rangle = \left\langle \frac{\partial H}{\partial x}, \frac{\partial H}{\partial y} \right\rangle - \left\langle \frac{\partial H}{\partial y}, \frac{\partial H}{\partial x} \right\rangle = 0.$$

This structure is not inherited after compactification by the flow on the sphere at infinity. The coordinates on the sphere at infinity are  $(\chi, \eta) \in \mathbb{R}^n$  with  $\langle \chi, \chi \rangle + \langle \eta, \eta \rangle = 1$  Assume  $H$  is a polynomial vector field and  $h_d$  its homogenous part of

highest degree  $d$ . The vector field on the sphere at infinity after normalization reads

$$\begin{pmatrix} \chi_\tau \\ \eta_\tau \end{pmatrix} = \begin{pmatrix} \frac{\partial h_d}{\partial \eta} \\ -\frac{\partial h_d}{\partial \chi} \end{pmatrix} - \left\langle \begin{pmatrix} \frac{\partial h_d}{\partial \eta} \\ -\frac{\partial h_d}{\partial \chi} \end{pmatrix}, \begin{pmatrix} \chi \\ \eta \end{pmatrix} \right\rangle \begin{pmatrix} \chi \\ \eta \end{pmatrix} \quad (4.22)$$

This vector field is generated by  $h_d$  in the sense that it is the projection of  $\begin{pmatrix} \frac{\partial h_d}{\partial \eta} \\ -\frac{\partial h_d}{\partial \chi} \end{pmatrix}$  onto the tangent space to the sphere at infinity. Hence the standard candidate for a function constant along trajectories on the sphere at infinity would be  $h_d$ . But computing the derivative of  $h$  along trajectories on the sphere at infinity yields the following.

$$\begin{aligned} \frac{dh_d}{dt}(\chi(t), \eta(t)) &= \langle \nabla h_d, (\chi_t, \eta_t) \rangle \\ &= \left\langle \frac{\partial h_d}{\partial \chi}, \frac{\partial h_d}{\partial \eta} - \left( \left\langle \frac{\partial h_d}{\partial \eta}, \chi \right\rangle + \left\langle -\frac{\partial h_d}{\partial \chi}, \eta \right\rangle \right) \chi \right\rangle \\ &\quad + \left\langle \frac{\partial h_d}{\partial \eta}, \frac{\partial h_d}{\partial \chi} - \left( \left\langle \frac{\partial h_d}{\partial \eta}, \chi \right\rangle + \left\langle -\frac{\partial h_d}{\partial \chi}, \eta \right\rangle \right) \eta \right\rangle \\ &= - \left\langle \nabla h_d, \begin{pmatrix} \chi \\ \eta \end{pmatrix} \right\rangle \left\langle \nabla h_d^\perp, \begin{pmatrix} \chi \\ \eta \end{pmatrix} \right\rangle, \end{aligned}$$

where  $\nabla h_d$  denotes the vector  $(\frac{\partial h_d}{\partial \chi}, \frac{\partial h_d}{\partial \eta})$  and  $\nabla h_d^\perp$  denotes the vector  $(\frac{\partial h_d}{\partial \eta}, -\frac{\partial h_d}{\partial \chi})$ . There is no reason for the product to be identically zero.

### 4.3.2 Planar quadratic Hamiltonian vector fields

In this paragraph we summarize the results obtained by Artés and Llibre in [2] about quadratic Hamiltonian vector fields in the plane and comment on them regarding the generalization of the Conley index theory developed in the present thesis. In this paper the authors classify all planar quadratic Hamiltonian vector fields according to their global phase portraits on the Poincaré hemisphere. More precisely, their main theorem is the following:

**Theorem 4.3.1.** *Let  $f$  be a quadratic Hamiltonian vector field in the plane. Then the Poincaré compactified phase portrait of  $f$  on the Poincaré hemisphere is topologically equivalent to one of the 28 configurations given in figure 4.2. Moreover, each of the configurations of figure 4.2 is realizable by quadratic Hamiltonian vector field.*

Their proof of this theorem can be decomposed in the following steps:

- Use the classification of quadratic planar vector fields with a center obtained by Vulpe in [40].



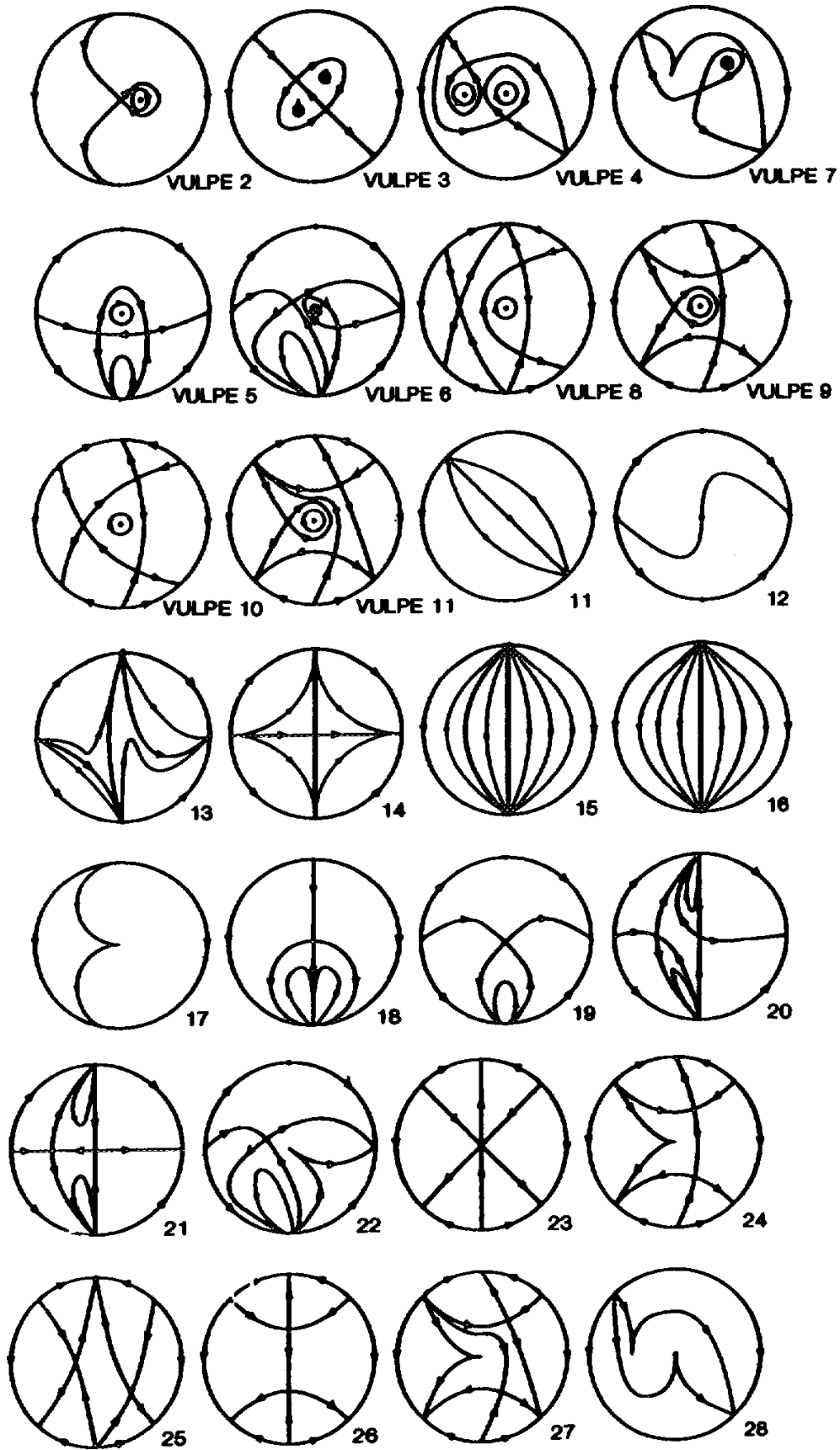

Figure 4.2: Classification of planar quadratic Hamiltonian vector fields.

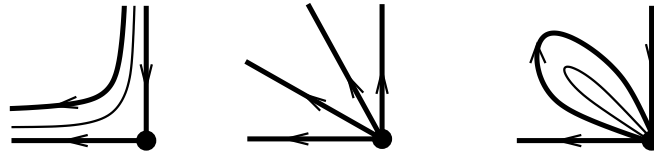

Figure 4.3: Hyperbolic, parabolic and elliptic sectors.

- Reduce the parameter space consisting of the coefficients of the polynomial field to 32 different normal forms depending on at most 4 parameters.
- Study the phase portraits for the various normal forms. Here methods described in [1] are applied successfully to study degenerate fixed points at infinity.

The success of this strategy is based on the fact that the fields under consideration are only quadratic and not of higher degree. Moreover the study of the phase portraits relies on the decomposition of neighbourhoods of fixed points in hyperbolic, elliptic and parabolic sectors as illustrated in Figure 4.3: this property is very 2-dimensional and cannot be generalized to higher dimensions. For more details on the decomposition in sectors see [1, VIII.17.2]. Furthermore, other 2-dimensional theorems like Poincaré–Bendixson are used to match together the local phase portraits around equilibria to a global phase portrait. For planar quadratic Hamiltonian vector fields, the Conley index methods we develop will not permit us to discover anything new; but they have the advantage that they are applicable in higher dimensions. The analysis of the behaviour near fixed points as in [1] is then replaced by the computation of the Conley index, and the matching of the heteroclinics is provided by connection matrices. We illustrate this approach on some phase portraits of the classification of Artés and Llibre in Figure 4.2. We choose the portraits 5, and 18.

### Portrait 5:

The phase portrait number 5 of the classification 4.2 contains an equilibrium  $p$  of isolated invariant complement in the sphere at infinity whose Conley index at infinity  $\hat{h}(p)$  is trivial. As we noticed in the previous chapter, this triviality is no obstacle to the detection of connecting orbits by the method we developed. Let us apply it here. The Figure 4.4 shows on the left an isolating block  $B$  for the isolated invariant set  $p_{comp}$  with its entrance and exit sets  $B^+$  and  $B^-$  respectively. Both  $B^+$  and  $B^-$  are retractable to a point. On the right hand side of the Figure 4.4 the extended flow is constructed. In this extended flow, the degenerate equilibrium  $p$  at infinity is replaced by two equilibria:  $b^-$  is an attracting fixpoint of Conley index  $h(b^-) = \Sigma^0$ ,  $b^+$  a repelling fixpoint of Conley index  $h(b^+) = \Sigma^2$ .

The other isolated invariant sets are the same in the original flow and in the

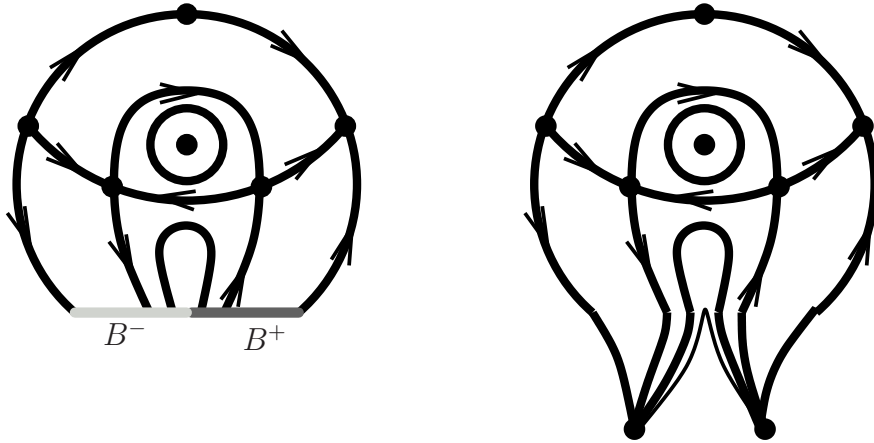

Figure 4.4: The extended flow for Portrait 5 of 4.2.

extended flow. If we denote by  $S$  the region filled with periodic orbits together with the two finite saddle points and the heteroclinic between them, it holds  $h(S) = \Sigma^1 \vee \Sigma^1$ . There are three further fixpoints in the sphere at infinity: the upper one has trivial classical Conley index so that no connection to him is detected. The last two are a repeller  $r$  on the left handside and an attractor  $a$  on the right hand side. Therefore holds  $h(\mathcal{H}, \mathcal{E}; r) = \Sigma^2$  and  $h(\mathcal{H}; a) = \Sigma^0$ . A Morse decomposition of the extended phase portrait is given by the partial order on the Morse sets

$$r, b^+ > S > a, b^-.$$

The connection maps (which correspond to the first subdiagonal of the connection matrix) detect the all heteroclinics that are detectable:

$$\begin{aligned} r &\rightarrow S \\ b^+ &\rightarrow S \\ S &\rightarrow a \\ S &\rightarrow b^- \end{aligned}$$

We illustrate in Figure 4.5 two of the isolating blocks that we use to detect the connection, together with their exit sets in red. The block on the right handside contains an isolated invariant set  $Q$  whose Conley index reads  $h(\mathcal{H}; \mathcal{E}; Q) = \bar{0}$ . The block on the left handside contains an isolated invariant set  $P$  whose Conley index reads  $h(\mathcal{H}, \mathcal{E}; P) = \bar{0}$ . The block on the right handside contains an isolating invariant set admitting  $(S, r)$  as an attractor–repeller pair. The block on the right handside contains an isolated invariant set admitting  $(S, b^+)$  as an attractor–repeller pair. Recalling that  $h(S) = h(\mathcal{H}; S) = h(\mathcal{H}, \mathcal{E}; S)$  as  $S \subset \text{int}(\mathcal{H})$ , it holds

$$h(\mathcal{H}, \mathcal{E}; r) \vee h(S) = \Sigma^0 \vee \Sigma^1 \vee \Sigma^1 \neq \bar{0},$$

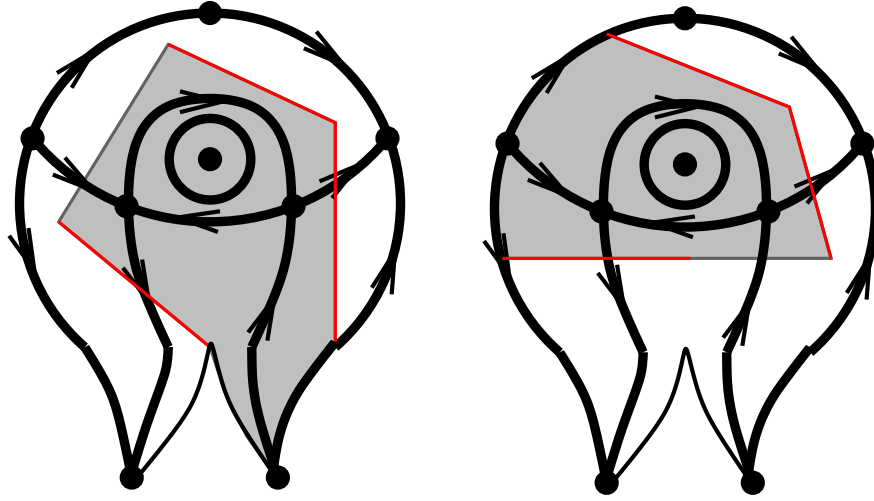

Figure 4.5: Isolating blocks of connections in Portrait 5 of 4.2.

and

$$h(\mathcal{H}, \mathcal{E}; b^+) \vee h(S) = \Sigma^2 \vee \Sigma^1 \vee \Sigma^1 \neq \bar{0}.$$

Those inequalities in the indices implies the nontriviality of the corresponding connection maps and hence the two connections  $r \rightarrow S$  and  $b^+ \rightarrow S$ .

The reader will easily see how to choose the two isolating blocks to prove the two remaining connections  $S \rightarrow a$  and  $S \rightarrow b^-$ .

The heteroclinic orbits  $b^+ \rightarrow S$  and  $b^- \rightarrow S$  correspond in the original phase portrait to orbits  $\sigma_1$  and  $\sigma_2$  with

$$\left\{ \begin{array}{l} \alpha(\sigma_1) \subset S \\ \omega(\sigma_1) \supset \{p\} \end{array} \right\}, \left\{ \begin{array}{l} \alpha(\sigma_2) \supset \{p\} \\ \omega(\sigma_2) \subset S \end{array} \right\},$$

where  $p$  denotes the equilibrium at infinity of isolated invariant complement.

### Portrait 18:

The compactified phase portrait 18 of Figure 4.2 admits an equilibrium at infinity of isolated invariant complement in the bottom that we denote by  $p$ . The Figure 4.6 shows a block  $B$  for its complement  $p_{comp}$  on the left handside. Its exit set  $B^-$  consists of two intervals and is contractible to the disjoint union of two points  $b_1^-, b_2^-$ . Both of them are attracting fixpoints in the extended phase space whose construction is exposed in paragraph 3.5.2. The entrance set  $B^+$  is contractible to one fixpoint  $b^+$ , which is a repeller in the extended flow.

On the right handside of Figure 4.6 the extended flow is shown for this example. The complement  $p_{comp}$  of our degenerate fixpoint contains two fixpoints: an equilibrium  $r$  at infinity, which is a repeller of Conley index  $h(\mathcal{H}, \mathcal{E}; r) = \Sigma^2$  and

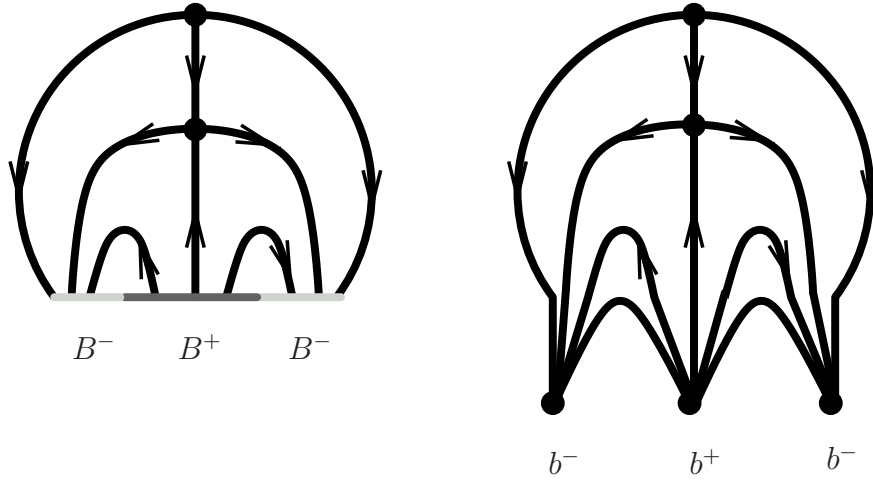

Figure 4.6: Extended flow for Portrait 18 of 4.2.

a finite equilibrium  $s$  which is a saddle point of index  $h(s) = \Sigma^1$ . Furthermore, the Conley indices of  $b^+$  and  $b^-$  reads

$$h(\mathcal{H}, \mathcal{E}; b^-) = \Sigma^2 \vee \Sigma^2,$$

$$h(\mathcal{H}; b^+) = \Sigma^0.$$

A Morse decomposition of the extended flow is given by the partial order

$$b^+, r > s > b^-.$$

The Figure 4.7 below shows isolating blocks and their exit set for the connections  $b^+ \rightarrow s$  and  $s \rightarrow b^-$ . Let us call  $P$  the set isolated by the left block, and  $Q$  the set isolated by the right block. It holds  $h(\mathcal{H}, \mathcal{E}; P) = \bar{0}$  and  $h(\mathcal{H}; Q) = \Sigma^0$ . To detect the heteroclinic orbits, one has to compare the followings:

$$h(\mathcal{H}, \mathcal{E}; b^+) \vee h(s) = \Sigma^2 \vee \Sigma^2 \vee \Sigma^1 \neq \bar{0},$$

$$h(\mathcal{H}; b^-) \vee h(s) = \Sigma^0 \vee \Sigma^1 \neq \bar{0}.$$

Hence the connection maps involved are not trivial and the Conley index methods developed in paragraph 3.5.2 are able to detect the heteroclinic orbits  $b^+ \rightarrow s \rightarrow b^-$ . Therefore there exist in the original phase portrait orbits  $\sigma_{1,2}$  with

$$\begin{cases} \alpha(\sigma_1) \supset \{p\} \\ \omega(\sigma_1) = \{s\} = \alpha(\sigma_2) \\ \omega(\sigma_2) \supset \{p\} \end{cases}$$

The heteroclinic  $r \rightarrow s$  is detectable by the classical Conley index as the reader will easily convince himself.

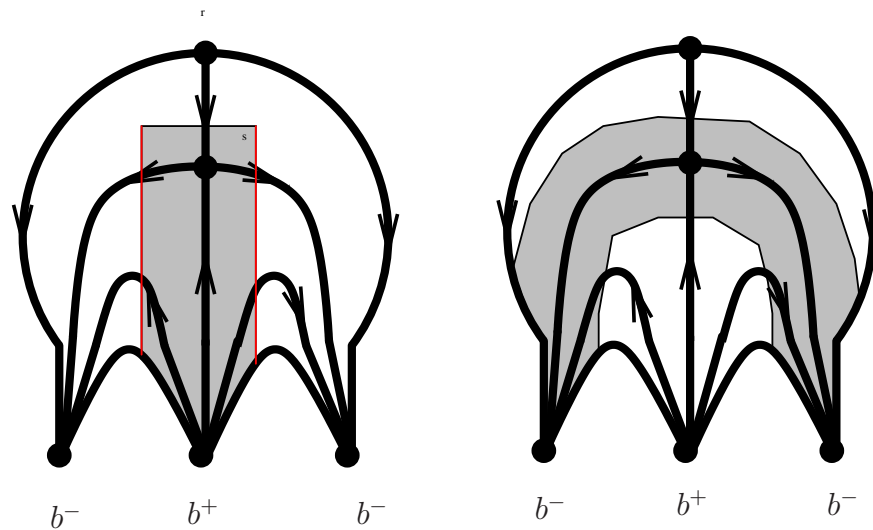

Figure 4.7: Isolating blocks for the extended flow of Portrait 18.

## 4.4 A cube at infinity

We present here the case of a polynomial vector field  $P$  in  $\mathbb{R}^n$  whose highest order terms take the form

$$p_d(x_1, \dots, x_n) = (x_1^d, \dots, x_n^d).$$

This polynomial vector field is not only interesting for itself, but also because it may be interpreted as the discretization of the partial differential equation  $u_t = u_{xx} + u^d + f(u)$ , where  $f$  contains terms of order smaller than  $d$ . For  $x \in [a, b]$ , we fix  $n$  points  $x_1, \dots, x_n$  in the interval  $[a, b]$ , and define  $u_k := u(x_k)$ ,  $k = 1, \dots, n$ . Then the equation  $(u_k)_t = u_k^d$ ,  $k = 1, \dots, n$ , governs the dynamic at infinity of the  $u_k$ 's. We will study this discretisation more precisely in paragraph 4.4.3.

Let us first see the structure appearing in the sphere at infinity. After this we will look at examples and discuss the connections between finite and infinite dynamic.

### 4.4.1 A cubic structure in the sphere at infinity

We consider the following system in  $\mathbb{R}^n$ :

$$\begin{aligned} (x_k)_t &= x_k^d, \\ k &\in \{1, \dots, n\}. \end{aligned} \tag{4.23}$$

This system is a gradient system with potential  $V(x) = \sum_{k=1}^n \frac{x_k^{d+1}}{d+1}$ . We recall that as a consequence, the  $\omega$  and  $\alpha$ -limit sets are all equilibria. In particular,

there exist no periodic orbits. To fix the ideas, let us fix  $d$  odd and at least 2. We analyse in this paragraph the dynamic inside the sphere at infinity. For this we proceed to a Poincaré compactification and use the atlas of the Poincaré hemisphere  $\mathcal{H}$  consisting of the vertical charts  $\{\xi_i = \pm 1, \zeta \geq 0\}$  as described in figure 2.2. We consider only the sphere at infinity alias the equator  $\mathcal{E}$  of  $\mathcal{H}$  which is invariant under the normalized flow on  $\mathcal{H}$ . This corresponds to the vertical coordinate  $\zeta$  being set to zero. The equations, already normalized by  $\varrho(\zeta) = \zeta^{d-1}$ , in each of the chart  $\{\xi_i = \pm 1, \zeta = 0\}$  of the sphere at infinity, read

$$\begin{cases} (\xi_k)_t &= (1 - \xi_k^d)\xi_k, \\ k &= 1, \dots, n, k \neq i. \end{cases} \quad (4.24)$$

The equilibria are vectors whose entries  $\xi_k$  are 0, 1 or -1. The stability of those equilibria depends on the linearisation of the projected vector field at those points, or more precisely on the sign of its eigenvalues. As

$$\begin{aligned} \frac{\partial P_k}{\partial \xi_k} &= 1 - d\xi_k^{d-1} \\ \frac{\partial P_k}{\partial \xi_j} &= 0 \text{ for } j \neq k, \end{aligned}$$

the Jacobian of the vector field is a diagonal matrix with diagonal entries  $J_{m,m} = 1 - d\xi_m^{d-1}$ , the nondiagonal entries being all trivial. Consider an equilibrium  $e$  of coordinates  $\xi_k = 0, 1$ , or  $-1$ . An entry  $\xi_k = 0$  in the equilibrium will result in a unstable eigenvalue 1 of the Jacobian at the equilibrium  $e$ , while an entry  $\xi_k = \pm 1$  will result in a stable eigenvalue  $1 - d$ . The corresponding eigenvector being in both cases the  $k$ -th vector of the canonical basis of  $\{\xi_i = \pm 1, \zeta = 0\} \simeq \mathbb{R}^{n-1}$ . Hence an equilibrium with  $p$  entries equal to zero has Morse index  $p$  for the flow restricted to the sphere at infinity (we do not consider the vertical direction  $\zeta$  in this paragraph as the sphere at infinity is invariant under the normalized flow on the Poincaré hemisphere).

When projected back on the sphere at infinity, the vector field admits  $3^n - 1$  distinct equilibria. To understand the structure of the connections between the equilibria inside the sphere at infinity, let us have a closer look at the compactified equations. For symmetry reasons, the same behaviour is taking place in every chart  $\{\xi_i = \pm 1, \zeta = 0\}$  of the sphere at infinity. We claim that, in every chart an equilibrium with an entry  $\xi_k = 0$  connects to the two equilibria having the  $k$ -th entry  $\xi_k = \pm 1$ , and else the same coordinates as the first. This connection corresponds to the unstable direction of  $e$  led by the  $k$ -th basisvector which is eigenvector of unstable eigenvalue 1. The Figure 4.8 below summarizes those connections. We choose to represent it as a cube rather than a sphere to make a representation in higher dimensions possible. To obtain the sphere at infinity, imagine it round.

The surface of a  $n + 1$ -dimensional cube shows facets of dimension  $k = n, n -$

$1, \dots, 0$ . We put in the center of the  $k$ -dimensional facets the equilibria  $e$  with exactly  $k$  coordinates equal to zero. Each of these unstable directions connects to the center of a  $k-1$ -dimensional facet - except if  $k=0$ ,  $e$  being then totally stable and in a corner of the cube. The structure of heteroclinics described in Figure 4.8 arises. The heteroclinics drawn on the  $(n-1)$ -dimensional cube surface in

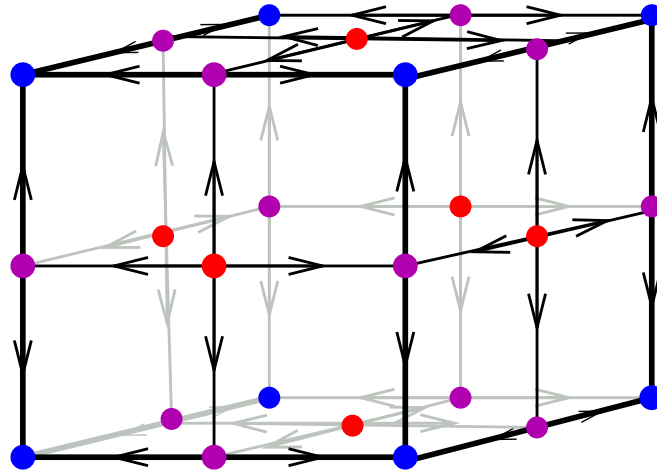

Figure 4.8: Sphere at infinity for 4.23 in  $\mathbb{R}^3$ .

fact run on the  $(n-1)$ -dimensional sphere at infinity, alias the equator  $\mathcal{E}$  of the Poincaré hemisphere  $\mathcal{H}$ .

The cube has  $2n$   $(n-1)$ -dimensional facets. Their centers correspond on the sphere at infinity  $\mathcal{E} = \{(\chi, z) \in \mathbb{R}^n \times \mathbb{R} / \|\chi\| = 1, z = 0\}$  to equilibria at infinity of the form  $\chi = \pm e_{k_0}$ ,  $z = 0$ , where  $e_{k_0}$  is the  $k_0$ -th vector of the canonical basis of  $\mathbb{R}^n$ .

The centers of the  $k$ -dimensional facets correspond on the sphere at infinity  $\mathcal{E} = \{(\chi, z) \in \mathbb{R}^n \times \mathbb{R} / \|\chi\| = 1, z = 0\}$  to equilibria at infinity of the form  $(a, 0) \in \mathbb{R}^n \times \mathbb{R}$  such that  $a$  admits exactly  $k$  nontrivial entries equal to  $\pm \frac{1}{\sqrt{k}}$ . There are  $2C_n^k$  of them, where  $C_n^k$  is the binomial coefficient.

#### 4.4.2 Finite dynamic without lower order terms

In fact the system 4.23 is explicitly solvable. For completeness we want to give here the explicit formula describing the trajectories. For every  $k = 1, \dots, n$ , the equation

$$(x_k)_t = x_k^d$$

is solved as follows:

- If the initial condition  $x_k(0)$  is zero,  $x_k(t) \equiv 0$  is solution;



- otherwise  $x_k(t)$  is of constant sign and integrating

$$\frac{(x_k)_t}{x_k^d} = 1$$

provides for the solution  $x_k(t)$  the explicit formula

$$x_k(t) = x_k(o) (1 + x_k^{d-1}(o)(1 - d)t)^{\frac{-1}{d-1}}. \quad (4.25)$$

This solution blows up at the positive time  $T_k$  defined by

$$T_k = \frac{1}{(d - 1)x_k^{d-1}(o)}. \quad (4.26)$$

Putting the collection of  $x_k$ ,  $k = 1, \dots, n$ , together, we see that the origin is unstable: every initial condition with at least one coordinate different from zero will blow up in forward time  $T_{k_0}$ , where  $x_{k_0}(0)$  denotes the greatest positive coordinate of the initial condition. For time  $t$  going to  $\infty$ , the trajectories all converge to the origine. The origine is not hyperbolic, so its Morse index is a priori not well defined but clearly its Conley index is the one of a repeller, i. e.  $\Sigma^n$ .

On the Poincaré hemisphere, a non-trivial trajectory, i. e. a trajectory with initial condition distinct from the origine, will converge to an equilibrium at infinity determined in the following way from the initial condition: generically the maximum of the set  $\{|x_k(0)|, k = 1, \dots, n\}$  will be reached for exactly one  $k_0$ ; then the trajectory projected on the Poincaré hemisphere will converge to the equilibrium at infinity  $(\chi, \zeta) = (\text{sign}(x_{k_0}(0))e_{k_0}, 0)$ , where  $e_{k_0}$  is the  $k_0$ -th vector of the canonical basis of  $\mathbb{R}^n$ . This corresponds in our cubic graph to the center of the  $n - 1$ -dimensional face associated to the direction  $\text{sign}(x_{k_0}(0))e_{k_0}$ . If the maximum of the set  $\{|x_k(0)|, k = 1, \dots, n\}$  is reached by several coordinates, say for  $k_{j_1}, \dots, k_{j_m}$ , the trajectory wil converge to the equilibrium on the sphere at infinity given by

$$\chi_k = \begin{cases} \frac{\text{sign}(x_k)}{\sqrt{m}} & \text{if } k \in \{k_1, \dots, k_m\} \\ 0 & \text{otherwise} \end{cases}$$

This equilibrium at infinity corresponds in the cubic graph to the center of the  $m$ -dimensional face associated to the "diagonal" direction  $\sum_{i=1}^m \text{sign}(x_{k_i})e_{k_i}$ .

**Remark 4.4.1.** The dynamics of System 4.24 without terms of order smaller than the degree  $d$  gives us important information about the dynamics of equations of the form (4.24)+linear terms, as soon as  $d$  is greater or equal 3. The sphere at infinity  $\mathcal{E}$  is an attractor for System 4.24, whose Conley index is  $h(\mathcal{H}; \mathcal{E}) = S^{n-1} \cup \{*\}$ . It is still an attractor when we add linear terms, so that the maximal bounded invariant set  $\mathcal{F}$  containing all globally bounded solutions, exists and its Conley index is  $\Sigma^n$ , because it coincides with the Conley index of the origin for System 4.24.

### 4.4.3 Finite dynamic with discrete Laplacian operator

Let divide the real interval  $[0, 1]$  in  $n$  subintervals  $[a_k, a_{k+1}]$ ,  $k \in \{0, \dots, n\}$  of equal length  $\frac{1}{n}$ . Consider a map  $u : [0, 1] \rightarrow \mathbb{R}$ . The discrete Laplace operator  $\Delta$  is given by

$$\Delta u(a_k) = \frac{1}{n^2}(u(a_{k-1}) - 2u(a_k) + u(a_{k+1})) \quad (4.27)$$

Instead of studying the partial differential equation  $u_t = \Delta(u) + u^p$ , we consider its discrete version. To this purpose, set  $x_k = u(a_k)$ . The boundary conditions may be chosen as Neumann or Dirichlet boundary conditions.

Neumann boundary conditions:  $x_0 = x_1$  and  $x_{n-1} = x_n$ .

Dirichlet boundary condition:  $x_0 = x_n = 0$ .

We get the following systems of ODEs:

$$\text{Neumann} \begin{cases} (x_1)_t = \frac{1}{n^2}(x_2 - x_1) + x_1^d \\ (x_2)_t = \frac{1}{n^2}(x_3 - 2x_2 + x_1) + x_2^d \\ \dots \\ (x_k)_t = \frac{1}{n^2}(x_{k+1} - 2x_k + x_{k-1}) + x_k^d \\ \dots \\ (x_{n-1})_t = \frac{1}{n^2}(-x_{n-1} + x_{n-2}) + x_{n-1}^d \end{cases} \quad (4.28)$$

$$\text{Dirichlet} \begin{cases} (x_1)_t = \frac{1}{n^2}(x_2 - 2x_1) + x_1^d \\ (x_2)_t = \frac{1}{n^2}(x_3 - 2x_2 + x_1) + x_2^d \\ \dots \\ (x_k)_t = \frac{1}{n^2}(x_{k+1} - 2x_k + x_{k-1}) + x_k^d \\ \dots \\ (x_{n-1})_t = \frac{1}{n^2}(-2x_{n-1} + x_{n-2}) + x_{n-1}^d \end{cases} \quad (4.29)$$

The finite equilibria of these systems solve  $(x_k)_t = 0$  for every  $k \in \{1, \dots, n-1\}$ . The first equation of the system may be reformulated so as to express  $x_2$  as a function of  $x_1$ , and so on so that every  $x_k$ ,  $k \in \{2, \dots, n-1\}$  is expressed as a function of  $x_1$ . Furthermore, this function is a polynomial of degree  $d^k$ .

The sum of all the equations of the system reads in the Neumann case

$$\sum_{i=1}^{n-1} x_i^d = 0,$$

and in the Dirichlet case

$$-x_1 - x_{n-1} + \sum_{i=1}^{n-1} x_i^d = 0.$$

This equation may be rewritten only in term of  $x_1$ . The unknown  $x_1$  has to solve this equation which is polynomial of degree  $d^n$ . The other variables are then fully determined. The calculations of the finite equilibria and their Conley index are done numerically and are summarized in the sketch below.

Furthermore, the discretization inherits the gradient structure of the partial differential equation: setting for  $x = (x_0, x_1, \dots, x_{n-1}, x_n)$

$$J(x) = \sum_{i=1}^{n-1} \frac{1}{2} \left( \frac{x_i - x_{i+1}}{n} \right)^2 - \sum_{i=1}^n \frac{x_i^{d+1}}{d+1}$$

It holds

$$\begin{aligned} \frac{dJ(x(t))}{dt} &= - \langle x_t, x_t \rangle \leq 0 \\ &= 0 \text{ only at equilibria,} \end{aligned}$$

where we took the boundary conditions (Neumann or Dirichlet) into consideration. As a consequence,  $\alpha$  and  $\omega$ -limit sets consist of equilibria only. We noticed in Remark 4.4.1 that the maximal bounded invariant set  $\mathcal{F}$  exists for the systems we consider, which is of the form (homogenous of degree  $d \geq 3$ )+(linear terms). This set  $\mathcal{F}$  consists of the bounded equilibria and the heteroclinic between them. We stick to the case  $d = 3$  to keep calculations reasonable.

#### **n=3, Neumann boundary conditions**

Origin:  $h(0) = \Sigma^0$   
2 equilibria of indices  $\Sigma^2$ .

#### **n=3, Dirichlet boundary conditions**

Origin:  $h(0) = \Sigma^0$   
2 equilibria of indices  $\Sigma^2$   
2 equilibria of indices  $\Sigma^1$   
Cascade  $\Sigma^2 \rightarrow \Sigma^1 \rightarrow \Sigma^0$ .  
Transfinite cascade  $\Sigma^2 \rightarrow \Sigma^1 \rightarrow \Sigma^0$ .

#### **n=4, Neumann boundary conditions**

Origin:  $h(0) = \Sigma^0$   
2 equilibria of indices  $\Sigma^2$   
2 equilibria of indices  $\Sigma^3$

#### **n=4, Dirichlet boundary conditions**

Origin:  $h(0) = \Sigma^0$   
2 equilibria of indices  $\Sigma^1$   
2 equilibria of indices  $\Sigma^2$   
2 equilibria of indices  $\Sigma^3$

Cascade  $\Sigma^3 \rightarrow \Sigma^2 \rightarrow \Sigma^1 \rightarrow \Sigma^0$ .

Transfinite cascade  $\Sigma^3 \rightarrow \Sigma^2 \rightarrow \Sigma^1 \rightarrow \Sigma^0$ .

## 4.5 The Lorenz equations

The following system is famous because it gives rise to the Lorenz-attractor for certain values of the parameters.

$$\begin{cases} x_t = \sigma(y - x) \\ y_t = rx - y - xz \\ z_t = -bz + xy \end{cases} \quad (4.30)$$

As it is a polynomial system, it is tempting to make use of compactification techniques to study its behaviour at infinity. In fact it has already been done in several papers. The paper [27] sums up the most information, see also [24]. We want here to give a short survey of their results and interpret them under the point of view of Conley index theory.

In the Bendixson compactification, the point at infinity is a repeller with Conley index  $\Sigma^3$ , as soon as the parameters are all strictly positive. This has already been shown by Conley. He observed that the function

$$V(x, y, z) = \frac{1}{2}(rx^2 + \sigma y^2 - \sigma(z - 2r)^2)$$

has a strictly negative derivative along trajectory as soon as one computes it far enough from the origin. In fact holds

$$\frac{d}{dt}V(x(t), y(t), z(t)) = \sigma(-rx^2 - y^2 - b(z - r)^2 + br^2).$$

The constant term is dominated by the squares. The level sets of  $V$  are ellipsoids. Hence there exist a global attractor which is the maximal invariant set contained in a big ellipsoid playing the role of an isolating block with empty exit set. The global attractor has Conley index  $\Sigma^0$  and it is also the maximal bounded invariant  $\mathcal{F}$  set in the sense of Property 3.5.2. The Conley index of the point at infinity is clearly  $h(\infty) = \Sigma^3$ .

For certain parameters, the Lorenz system shows a strange butterfly-shaped attractor called the Lorenz attractor. The complexity of the structure of the Lorenz attractor may be explained as a bifurcation from a singularly degenerate heteroclinic cycle which consists of an invariant set formed by a line of equilibria together with a heteroclinic connecting two of those equilibria, as suggested in

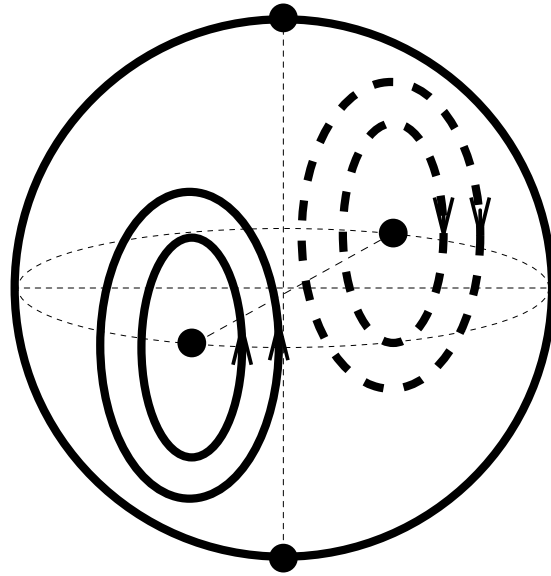

Figure 4.9: The dynamic of the Lorenz system in the sphere at infinity.

[24]. This approach could explain the generation of strange "butterflies" attractors in all Lorenz-like systems. The dynamic at infinity plays an important role in the study of the degenerate heteroclinic cycles because the line of equilibria is infinite and hits the sphere at infinity in an equilibrium. In [27], numerical evidence are given for the appearance of such degenerate heteroclinic cycles as the parameter  $b$  is crossing the value 0: for  $b \neq 0$ , the positive and the negative part of the  $z$ -axis are heteroclinic connection between the origine and equilibria at infinity, the direction of which depends on the sign of  $b$ . For the value  $b = 0$ , the  $z$ -axis is a line of normally hyperbolic equilibria. Some of them have a one-dimensional unstable manifold, others have a two-dimensional stable manifold. The unstable manifolds of the firsts connect to the stable ones for  $t \rightarrow +\infty$ , or so show the numerical study at least.

As the reader easily sees, the choice of the coefficients of the Lorenz equations 4.30 does not affect the highest order terms. As a consequence, the dynamic in the sphere at infinity is independant of those coefficients. Messias gives a precise description of the dynamic in the sphere at infinity in [27]. An overview of the dynamic at infinity is given by the following and is illustrated in figure 4.9. It contains two equilibria at the ends of the  $x$ -axis that are centers. They are hence surrounded by peridic orbits which degenerates in a circle of equilibria at infinity in the  $(y, z)$ -plane.

The sphere at infinity contains neither a non trivial (i. e. empty) isolated invariant set, nor a non trivial invariant set of isolated invariant complement: any neighbourhood of any equilibria at infinity admits whether equilibria on its boundary, or inner periodic orbits touching from inside, and outer periodic orbits

touching it from outside. Therefore the methods exposed in chapter 3 cannot be applied for the Poincaré compactification.

The global attractor admits a Morse decomposition, at least for some reasonable parameter range. The paper [35] by Sanjurjo addresses this question and presents a way of computing the cohomological Conley indices. In particular the Conley index of the strange attractor is computed. We refer the reader to [35] for the details. Unfortunately it is not possible to detect the connections of the different Morse sets of the global attractor to the sphere at infinity by Conley index methods because no part of the sphere at infinity is isolated invariant or of isolated invariant complement.

# Chapter 5

## Partial differential equations

### 5.1 Chafee–Infante structure at infinity

In this chapter we want to consider infinite dimensional dynamical systems. First let us look at a linear one. There we observe the existence in the sphere at infinity of a structure analog to the Chafee–Infante attractor studied in [20, 5, 6]. This is the purpose of this section to describe how this structure comes up.

We consider in the Hilbert space  $X$  the equation

$$u_t = Au, \tag{5.1}$$

with initial condition

$$u(0) = u_0,$$

where  $u, u_0 \in X$  and  $A : D(A) \rightarrow X$  is a densely defined linear operator. The space  $X$  being Hilbertian, it admits a countable orthonormal basis. Furthermore let us assume that there exists a basis  $(e_n)_{n \in \mathbb{N}}$  of  $X$  consisting of eigenvectors of  $A$  and that the associated eigenvalues  $(\mu_n)_{n \in \mathbb{N}}$  are pairwise distinct and ordered the following way:

$$\mu_0 > \mu_1 > \mu_2 > \cdots \tag{5.2}$$

This is for example the case for the Laplace operator on a bounded domain  $[0, L]$ , with Neumann boundary conditions and  $X = L^2$  (see section 5.3 and followings where we discuss concrete problems in more details). The basis  $(e_n)_{n \in \mathbb{N}}$  provides for each  $u \in X$  coordinates  $(u_n)_{n \in \mathbb{N}}$ . In those coordinates, the equation 5.1 reads

$$(u_n)_t = \mu_n u_n \text{ for all } n \in \mathbb{N}.$$

We now apply the Poincaré compactification on this equation as described in chapter 2. The space  $X \simeq X \times \{1\}$  is projected gnomically on the Poincaré hemisphere  $\mathcal{H} = \{(\chi, z) \in X \times \mathbb{R} / \langle \chi, \chi \rangle + z^2 = 1, z \geq 0\}$ , the equator  $\{(\chi, z) \in X \times \mathbb{R} / \langle \chi, \chi \rangle = 1, z = 0\}$  being the sphere at infinity. The Poincaré compactified

equation does not need to be normalized. Let us study it in the vertical half-hyperplanes  $C_i^\pm$  of the space  $X \times \mathbb{R}$  defined for all  $i \in \mathbb{N}$  as

$$C_i^\pm := \{(\xi, \zeta) \in X \times \mathbb{R} / \xi_i = \pm 1, \zeta \geq 0\}.$$

For that we project again gnomically from the Poincaré hemisphere  $\mathcal{H} \setminus \{\text{north pole}\}$  to  $C_i^\pm$ . The collection of the projections on the half-hyperplanes  $(C_i^\pm)_{i \in \mathbb{N}}$  forms an atlas of the Poincaré hemisphere up to the north pole. The coordinates in those hyperplanes are called  $(\xi_n)_{n \in \mathbb{N}}$  and  $\zeta$ , just as in chapter 2. In each half-hyperplanes  $C_i^\pm$ , the projected equation reads

$$(\xi_n)_t = (\mu_n - \mu_i)\xi_n \text{ for all } n \in \mathbb{N} \quad (5.3)$$

$$\zeta_t = -\mu_i\zeta \quad (5.4)$$

For each fixed  $i \in \mathbb{N}$  the vertical half-hyperplane  $C_i^\pm = \{\xi_i = \pm 1, \zeta \geq 0\}$  contain exactly one equilibrium: the origine denoted by  $\Phi_i^\pm$  with coordinates in the basis of  $X \times \mathbb{R}$  composed of  $(e_n, 0)$ ,  $n \in \mathbb{N}$  and  $(0, 1)$  as follows:

$$\Phi_i^\pm : \begin{cases} \xi_i = \pm 1, \\ \xi_n = 0 \text{ for } n \neq i, \\ \zeta = 0. \end{cases}$$

In other words we have on the sphere at infinity a countable infinity of equilibria  $\Phi_i^\pm$  with coordinates in the Poincaré hemisphere  $\mathbb{H}$ :

$$\Phi_i^\pm : \begin{cases} \chi_i = \pm 1, \\ \chi_n = 0 \text{ for } n \neq i, \\ z = 0. \end{cases}$$

Let us determine the stability of these equilibria with the help of equation 5.3.

For  $i = 0$ , all  $\mu_n$ ,  $n \neq 0$ , are smaller than  $\mu_0$  so that  $(\mu_n - \mu_0)$  is always negative and the two equilibria  $\Phi_0^\pm$  are stable.

For  $i \geq 1$ ,  $(\mu_n - \mu_i)$  is positive for  $0 \leq n \leq i - 1$  and negative for  $n \geq i + 1$ . Hence the two equilibria  $\Phi_i^\pm$  with coordinates  $\xi_i = \pm 1$ ,  $\xi_n = 0$  for  $n \neq i$ , admits  $i$  unstable directions and infinitely many stable ones. In terms of Morse index, this fact just means that the Morse index of  $\Phi_i^\pm$  is equal to  $i$ , as the Morse index counts the unstable directions.

Now let us describe the heteroclinic orbits connecting those equilibria  $(\Phi_i^\pm)_{i \in \mathbb{N}}$  with one another in the sphere at infinity. For this we make again use of the equation 5.3. Let us fix a  $i \in \mathbb{N}$  and also  $\varepsilon \in \{+1, -1\}$ . Then for each  $n \neq i$ , the  $\xi_n$ -axis is invariant and consists of heteroclinics

- from  $\Phi_i^\varepsilon$  to  $\Phi_n^\pm$  if  $\mu_n - \mu_i < 0$ , i. e.  $n \in \{0, \dots, i - 1\}$ ,
- from  $\Phi_n^\pm$  to  $\Phi_i^\varepsilon$  if  $\mu_n - \mu_i > 0$ , i. e.  $n \geq i + 1$ .



[5, 6] Furthermore a generic initial condition in the  $i$ -dimensional unstable subspace of  $\Phi_i^\pm$  converges to  $\Phi_0^\pm$ . More precisely, if  $\chi = (\chi_n)_{n \in \mathbb{N}}$  fulfils

$$\begin{cases} \chi_n = 0 & \text{for } n \geq i + 1, \\ \chi_n \neq 0 & \text{for } n \in \{0, \dots, i - 1\}, \\ \langle \chi, \chi \rangle = 1 & , \end{cases}$$

the trajectory through  $\chi$  converges to  $\Phi_0^{sign(\chi_0)}$  after having spent long time near  $\Phi_n^{sign(\chi_n)}$ ,  $\dots$ ,  $\Phi_1^{sign(\chi_1)}$  successively. This behaviour is caused by the fact that  $\mu_0 - \mu_i$  is the strongest unstable eigenvalue of the equilibria  $\Phi_i^\pm$ .

We compare this structure to the structure of the global attractor in the Chafee–Infante problem for the following reason: In both cases we have equilibria of every possible Morse index. Heteroclinic orbits from an equilibrium with lower Morse index to an equilibrium with higher Morse index are forbidden. Moreover an heteroclinic between two equilibria whose Morse index differs of more than one is forbidden too, unless there exists a cascade of heteroclinics where the Morse index decreases of one in each step between the two equilibria considered (. In the Chafee–Infante as well as in our sphere at infinity, every heteroclinic which is not forbidden by the Morse indices is eventually taking place, so that the complete cascade of heteroclinics is realised. The following Graph describes this structure, where some arrows with Morse index decay bigger than one are missing for the sake of clarity.

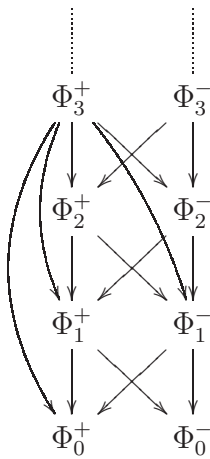

This is what we call a Chafee–Infante–like structure. We observe two differences between the structure in our sphere at infinity and the classical Chafee–Infante attractor:

- Here we observe two equilibria of Morse index zero instead of a single one in the classical Chafee–Infante attractor.
- More important is the second difference: in the classical Chafee–Infante structure, there is arbitrarily many equilibria by adjusting the parameter, but for each fixed parameter finitely many. In our case we have a countable infinity of equilibria (except if the space  $X$  was finite dimensional from the beginning).

In figure 5.1 we show the Chafee–Infante–like structure at infinity in a sphere at infinity of dimension 2 (i.e. for  $X = \mathbb{R}^3$ ), which is the greatest dimension one can reasonably try to draw. In reality, the sphere at infinity we are considering is infinite dimensional. The blue equilibria are  $\Phi_0^\pm$ , the purple ones  $\Phi_1^\pm$ , the red ones  $\Phi_2^\pm$ .

Note that this structure occurs independently from the stability of the finite saddle sitting at the origin of  $X$  in the original system. Only the difference

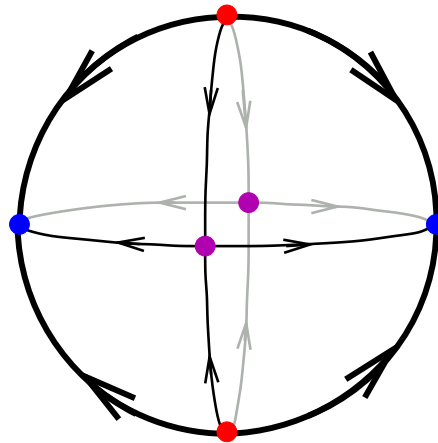

Figure 5.1: 2–dimensional sphere at infinity with Chafee–Infante–like structure.

$\mu_n - \mu_i$  of its eigenvalues plays a role in the dynamic of the sphere at infinity: the spectrum of the finite equilibria sitting at the origine may be translated by considering  $A + bId$  instead of  $A$ , changing the number of unstable directions, without destroying the Chafee–Infante–like structure in the sphere at infinity.

Now a few words about the transfinite heteroclinics between the origine and the equilibria  $\Phi_i^\pm$  at infinity. These are determined by the equation 5.4 in the half–hyperplanes  $C_i^\pm$  which reads  $\zeta_t = -\mu_i\zeta$ . This equation provides the following information:

- If the  $i$ –th eigenvalue  $\mu_i$  is positive, there are transfinite heteroclinics from the north pole  $(0, 1)$  of the Poincaré hemisphere (alias the origin of  $X$  in the original system) to the equilibria  $\Phi_i^\pm$  at infinity.
- If the  $i$ –th eigenvalue  $\mu_i$  is negative, there are transfinite heteroclinics from the equilibria  $\Phi_i^\pm$  at infinity to the north pole  $(0, 1)$  of the Poincaré hemisphere.

Those heteroclinics follow the meridian of the Poincaré hemisphere given by the projection of the straight line directed by  $(e_i, 1)$  in  $X \times \{1\}$ , where  $e_i$  was the  $i$ –th basis vector of  $X$ . Furthermore a generic initial condition in the unstable subspace of the origine will be attracted by  $\Phi_0$  for the same reasons as given before. This transient behaviour of the growing up trajectories is shown in figure 5.2 below. This figure shows the case where  $\mu_0 > \mu_1 > \mu_2 > 0 > \mu_3 > \dots$ , so that the origine of the original system has a 3–dimensional unstable subspace. Here the Poincaré hemisphere is projected in the equatorial hyperplane of  $X \times \mathbb{R}$ : its image under this projection is a disk whose boundary is the sphere at infinity and the interior the finite space. We show only the projected 3–dimensional unstable subspace of the origine.

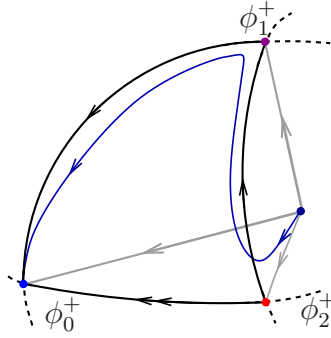

Figure 5.2: Transient behaviour of the grow up solutions.

**Remark 5.1.1.** Note that a pair of complex conjugate eigenvalues  $\lambda, \bar{\lambda}$  of the linear map  $A$  generates in the sphere at infinity  $\mathcal{E}$  a periodic orbit. The stability of the eigendirection of the linearisation along this periodic orbit pointing to the inside of the Poincaré sphere  $\mathcal{H}$  depends on the sign of the real part of  $\lambda$  : if the real part  $Re(\lambda)$  is positive, then this direction is stable for the periodic orbit at infinity; on the contrary, if  $Re(\lambda) < 0$ , then the periodic orbit at infinity is unstable in this direction. Otherwise, the stability of the directions tangent to the sphere at infinity depends on the sign of the differences between  $Re(\lambda)$  and the other eigenvalues, as in the case where all eigenvalues of  $A$  were real.

## 5.2 Case of a sublinear non-linearity

In this section we consider an equation with a non-linearity growing slower than the linear part. We show that the dynamic at infinity reveals the same structure as in the linear case. But to this aim we have to precise a bit the settings on our vector space  $X$ . This should be an Hilbert space, typically a subspace of  $L^2$ , containing functions from a bounded domain of  $\mathbb{R}^n$  to  $\mathbb{R}$ , which admits a basis of eigenvectors of a linear operator  $A$ . Let  $f : \mathbb{R} \rightarrow \mathbb{R}$  be sufficiently smooth sublinear, i.e.

$$\frac{f(x)}{x} \rightarrow 0 \text{ as } x \rightarrow \pm\infty.$$

For example, as we will see in the next section, we may consider  $X = L^2(0, \pi)$ ,  $A = \frac{\partial^2}{\partial x^2} + bI$ . In this context,  $f$  twice continuously differentiable is sufficient to guarantee a local semi-flow solving the equation:

$$u_t = Au + f(u). \quad (5.5)$$

Now let us write in coordinates the equations governing the dynamic in the sphere at infinity. For that we apply the procedure of Poincaré compactification as described precisely in chapter 2. The space of functions  $X$ , whose basis  $(e_n)_{n \in \mathbb{N}}$

is composed of eigenvectors of  $A$ , is projected gnomonically onto an hemisphere. The behaviour at infinity is contained in the equator of the hemisphere. For comfort we prefer to compute in the vertical hyperplanes tangent to the equator, so that we project the dynamic on them. In the half-hyperplanes  $\{\xi_i = \pm 1, \zeta \geq 0\}$  we get in coordinates the equation

$$(\xi_n)_t = (\mu_n - \mu_i)\xi_n + (\langle f_\zeta(\xi), e_i \rangle \xi_n + \langle f_\zeta(\xi), e_n \rangle) \quad (5.6)$$

$$\zeta_t = -\langle f_\zeta(\xi), e_i \rangle \zeta. \quad (5.7)$$

The equation 5.7 reads  $\zeta_t = 0$  as  $\zeta$  goes to zero and confirms that the equator is invariant, as expected. Because of the sublinearity condition on  $f$ , the terms  $\langle f_\zeta(\xi), e_k \rangle$  in the equation 5.6 are zero for  $\zeta = 0$ , such that at the equator it just reads:

$$\text{for all } n \neq i, (\xi_n)_t = (\mu_n - \mu_i)\xi_n$$

From this we can conclude that the dynamic in the sphere at infinity is the same as in the linear case. Of course the analogy stops as soon as  $\zeta > 0$ . The finite and transfinite dynamic have to be determined for each choice of nonlinearities  $f$ . We see an example in the next section.

### 5.3 Example of a bounded non-linearity

In this section we present a brief survey of the results of [3] who studied the equation

$$u_t = u_{xx} + bu + \sin u, x \in ]0, \pi[ \quad (5.8)$$

$$u_x(0) = u_x(\pi) = 0 \quad (5.9)$$

where  $b$  is a bifurcation parameter. This equation is gradient for the potential

$$V(u) = \int_0^\pi \left( -\frac{1}{2}u_x^2 + \frac{1}{2}bu^2 - \cos u \right) dx. \quad (5.10)$$

This fact provides convergence of the bounded trajectories to equilibria on the one hand, but also a gradient structure in the sphere at infinity, as proposition 4.2.1 is also valid in infinite dimensional context.

We give now a very impressionistic overview of the bifurcation diagram the heteroclinics between finite equilibria and the transfinite heteroclinic connecting finite equilibria to equilibria at infinity. The methods in fact involved to eventually prove this picture and contained in [3] are the following:

- The bifurcation diagram is constructed with the help of the time map, among other things.

- The existence of a non bounded global attractor requires an inertial manifold theorem for the non dissipative case, which is proven in [3] for a more general equation than Equation 5.8.
- Nodal properties and the  $Y$ -map are used to prove the existence of heteroclinics.

The origin is an equilibrium, and the linearisation at the origin has eigenvalues  $\lambda_j = b - j^2 + 1$ . The origin undergoes a Pitchfork bifurcation as the parameter  $b$  takes values  $b = j^2 - 1$ , and lose a stable direction, while two equilibria are created nearby. For  $(j - 1)^2 < b < j^2 - 1$ , the origin admits exactly  $j$  unstable directions and its Conley index reads  $h(0) = \Sigma^j$ . It connects to the equilibria at infinity  $\phi_0^\pm, \dots, \phi_{j-1}^\pm$  in forward time direction, and to the equilibria  $\phi_k^\pm$  for  $k \geq j$ . This is the left vertical line of Figure 5.3.

The Pitchfork bifurcation of the origine generates a branch of equilibria denoted by  $p_1^\pm$  which inherits its stability: for  $b > j^2 - 1$  but nearby, the two equilibria have  $j$  unstable directions and their Conley indices read  $h(p_1^\pm) = \Sigma^j$ , while the index of the origin is now  $h(0) = \Sigma^{j+1}$ . The equilibria  $p_i^\pm$  connect in forward time direction to the equilibria at infinity  $\phi_0^\pm, \dots, \phi_{j-1}^\pm$ . This situation takes place on the second plain vertical line corresponding to such a value of  $b > j^2 - 1$  but nearby.

On the second plain vertical line, there exists not only two finite equilibria  $p_1^\pm$ , but three equilibria  $p_1^\pm, p_2^\pm$ , and  $p_3^\pm$ . The two new equilibria are born in saddle node bifurcations taking place at the vertical dotted lines right and left. The saddle node bifurcation on the right hand side justifies the heteroclinics  $p_2^\pm \rightarrow p_1^\pm$ ; the saddle node bifurcation on the left hand side justifies the heteroclinics  $p_2^\pm \rightarrow p_3^\pm$ . Now we have understood what happens on the third vertical plain line. When the value of  $b$  approach  $n^2$  from below, more and more finite equilibria are born in saddle node bifurcations. They connect to each other alternatively, and they still connect in forward time direction to the equilibria  $\phi_0^\pm, \dots, \phi_{j-1}^\pm$  at infinity.

At the critical value  $b = j^2$ , the eigendirection of the equilibria  $\phi_j^\pm$  at infinity which points to the interior of the Poincaré hemisphere changes its stability: it was unstable for  $b < j^2$ , it gets stable for  $b > j^2$ . At the value  $b = j^2$ , finite equilibria accumulate on  $\phi_j^\pm$  which is not isolated invariant any more. The eigendirections tangent to the sphere at infinity do not change their stability. For the values  $b = j^2$ , the equilibria  $\phi_j^+$  and  $\phi_j^-$  are not isolated invariant, and they are not of isolated invariant complement: a compact neighbourhood that does not contain, say,  $\phi_j^+$ , will contain more and more of these accumulating equilibria if we let it grow in such a way that its complement shrinks to it.

On the right hand side of the vertical line  $b = j^2$ , we have again only finitely many finite equilibria  $0, p_1^\pm, \dots$  and they all connect in forward time direction to the equilibria at infinity  $\phi_0^\pm, \dots, \phi_{j-1}^\pm$ , and the last of them, say,  $p_m^+$  connects to  $\phi_j^+$  in forward time direction, while  $p_m^-$  connects to  $\phi_j^-$ .

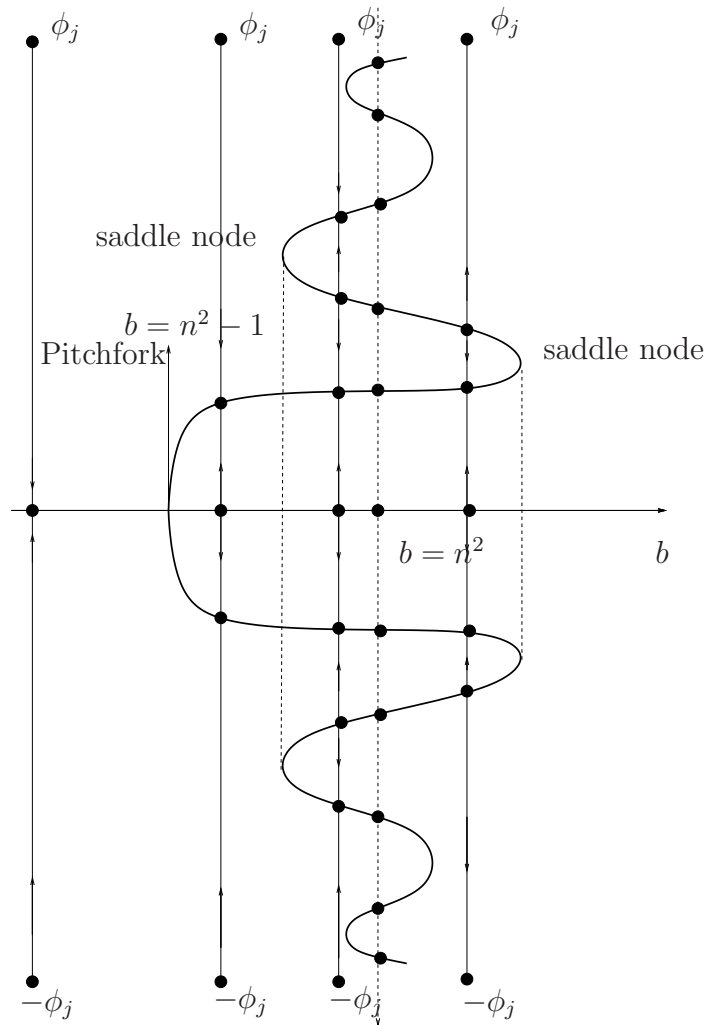

Figure 5.3: Bifurcation diagram for the equation 5.8.

The equilibria  $\phi_k^\pm$  at infinity correspond to a grow-up profile which is shown on Figure 5.4. There we see how the 3-dimensional unstable manifold of a finite equilibrium escape to the sphere at infinity. Typically, a trajectory tends to infinity with grow-up profile  $\phi_0^\pm$  after a transient behaviour near  $\phi_2^\pm$  and  $\phi_1^\pm$ .

## 5.4 Abstract polynomial PDE

The aim of this paragraph is to see how the procedure of compactification acts on a abstract partial differential equation and which problems do arise. Although solving these problems would go beyond the frame of this thesis, we want to point out which properties the compactified equation inherit from the original

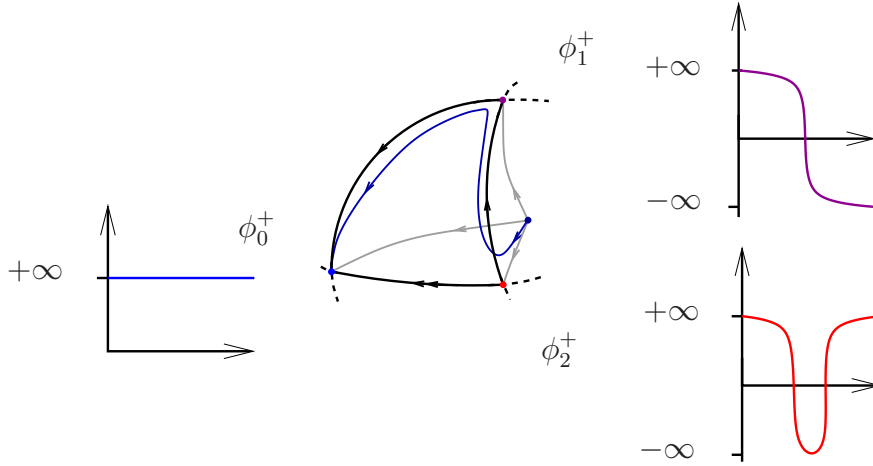

Figure 5.4: Transient behaviour of grow-up solution.

PDE and so put the basis of further work to be done.

The PDE for which we are able to compactify the phase space  $X$  are of the form

$$u_t = P(u), \tag{5.11}$$

where  $P$  can be decomposed into two parts

$$P = p_d + p,$$

such that the first is homogenous of degree  $d$ :

$$\forall \lambda > 0, \quad p_d(\lambda u) = \lambda^d p_d(u),$$

and the second part is of lower order:

$$\lambda^d p(\lambda^{-1} u) \rightarrow 0 \text{ as } \lambda \searrow 0$$

We denote such an equation by “polynomial ” PDE, because its leading term grows polynomially. Of course, it must not be a polynomial, but may contain space derivatives of  $u$  for example.

The homothety  $P_z(\chi) := zP(z^{-1}\chi)$  of  $P$ ,  $z > 0$ , reads

$$\begin{aligned} P_z(\chi) &= zP(z^{-1}\chi) \\ &= z^{1-d} p_d(\chi) z p(z^{-1}\chi) \end{aligned}$$

The normalization is realized by  $\rho(z) = z^{d-1}$  so that  $\rho(z)P_z$  has a limit as  $z \searrow 0$ :

$$\begin{aligned} \rho(z)P_z(\chi) &= p_d(\chi) + z^d p(z^{-1}\chi) \\ &\rightarrow p_d(\chi) \text{ as } z \searrow 0 \end{aligned}$$

Finally, the dynamic on the sphere at infinity  $\mathcal{E} = \{\chi \in X / \langle \chi, \chi \rangle = 1\}$  is governed by the equation

$$\chi_t = p_d(\chi) - \langle p_d(\chi), \chi \rangle \chi. \quad (5.12)$$

The Hilbert space  $X$  is a function space, the unknown  $\chi$  is a function of time and space  $\chi(t, y)$ , where  $t \in \mathbb{R}$  and  $y \in \Omega \subset \mathbb{R}^n$ . The scalar product is of integral form, for instance

$$\int_{\Omega} p_d(\chi(t, y)) \chi(t, y) dy.$$

Therefore the term  $\langle p_d(\chi), \chi \rangle$  is not a local term. It does not really matter for the existence of trajectories, because those are inherited from the original equation 5.11. However, we are interested in invariant sets at infinity - and more modestly in equilibria at infinity. Those are given by the equation

$$0 = p_d(\chi) - \langle p_d(\chi), \chi \rangle \chi.$$

It is rather difficult to find out equilibria through this equation. Therefore it seems important to relate the Poincaré compactification with other methods for studying blow-up and to translate the information they may provide about dynamics at infinity into terms of invariant sets in the sphere at infinity. An example of such methods are the similarity variables that we introduce in the next section.

Furthermore, the infinity dimension of such function space is a problem for the method we developed in the previous chapter. This method consists of, roughly speaking, cutting away invariant sets of isolated invariant complement and replace him by pieces of flow, each of them containing an attractor or a repeller. The problem is that the Conley index of repeller is not well defined in infinite dimensional phase space. In the book by Rybakowsky, certain compactness conditions are required to be able to define the Conley index in this context. For, say, hyperbolic equilibria, those conditions impose a finite number of unstable dimensions - which is violated for repellers. To understand this, imagine that the Conley index of a repelling point was defined for a repelling point with infinitely many unstable directions, then it would be an infinite dimensional pointed sphere. But those are retractable to a point. Hence this Conley index would be trivial, which makes no sense.

For these reasons, the construction that we exposed has to be done in some finite dimensional submanifold escaping to infinity, to have a chance to work.

## 5.5 Blow-up and Similarity variables

Partial differential equations showing blow-up phenomena may be analyzed by a tool called similarity variables. This is a change of the time and space variables together with a rescaling of the solutions: this is not a compactification of the



function space in the sense(s) we introduced before. However, this change of variables let at least part of the bow-up behaviour become a finite problem. We will discuss equations such as nonlinear reaction-diffusion (see Section 5.5.2) of the form

$$u_t = \Delta u + |u|^{p-1}u,$$

or the parabolic scalar curvature equation in its following form

$$u_t = u^2 \Delta u + fu^3$$

in Section 5.5.3. But let us first introduce the general idea of similarity variables.

### 5.5.1 Philosophy of the Similarity Variables

Similarity variables is a change of variables which zoom in a blow-up point at the blow-up time. This change of variables is based on the following idea. Consider for example a domain  $\Omega \subset \mathbb{R}$ , a function

$$v : \Omega \rightarrow \mathbb{R},$$

and a point  $a \in \Omega$ . The function  $u : \Omega \rightarrow \mathbb{R}$  has a graph which is homothetic of factor  $\lambda$  to the graph of  $v$  with respect to the point  $a \in \Omega$  if  $u$  and  $v$  are related by the following formula.

$$\forall x \in \Omega, u(x) = \lambda v(\lambda^{-1}(x - a))$$

The figure 5.5 illustrate this formula.

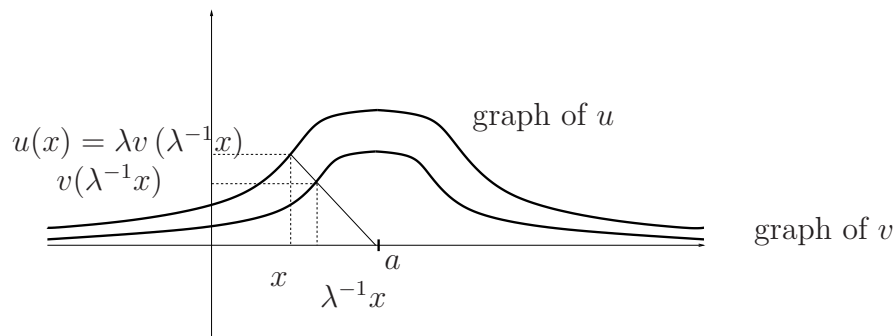

Figure 5.5: Homothetical function graphs.

Now we consider a partial differential equation of the form

$$u_t = P(u, \nabla u, \Delta u, \dots, x), \quad x \in \Omega. \tag{5.13}$$

A solution  $u$  of 5.13 is called self-similar if there exists a function  $v$  (satisfying the right boundary condition if  $\Omega$  is bounded) such that

$$u(t, x) = \lambda(t)v(\lambda^\alpha(x - a)).$$

The exponent  $\alpha$  may be different from the  $-1$  that we had for homothetic graph. The choice of the exponent  $\alpha$  depends on the equation considered.

The behaviour of  $\lambda(t)$  is related with the blow-up phenomena and more precisely with the blow-up rate. If  $|\lambda(t)| \rightarrow \infty$  as  $t \nearrow T$ , then  $\|u(t, \cdot)\|_\infty \rightarrow \infty$  as  $t \nearrow T$ .

To fix the ideas, think of the right hand side  $P$  of equation 5.13 as being polynomial in  $u$  and its spatial derivatives, and, say, not depending on the space variable  $x$  for simplicity. We keep in mind that nonlinearities like  $e^u$  are also analyzed with those methods. Looking for solutions  $u$  of Equation 5.13 constant in space, i. e. setting its partial derivatives to zero, provides a polynomial ordinary differential equation

$$u_t = p(u), \tag{5.14}$$

where  $u$  depends only on the time variable  $t$  and  $p$  is a polynomial as  $P$  was. The degree of the polynomial  $p$  determines the rate of blow-up of the ODE 5.14. The equation  $u_t = u^d$  is explicitly solvable by  $u(t) = (T - t)^{\frac{1}{d-1}}$  where  $T$  is the blow-up time (see Section 4.4.2 for the details of this calculation). If  $p$  is of the degree  $d$ , the term  $u^d$  dominates in the Equation 5.14 and determinates its blow-up rate. Anyway the ODE 5.14 provides a blow-up rate of the form  $(T - t)^\beta$  where  $\beta < 0$ .

The first step towards the similarity variables is to make the ansatz that solutions of the PDE 5.13 blow up at exactly the same rate so that the quantity

$$(T - t)^{-\beta} \|u(t, \cdot)\|_\infty$$

remains bounded, where  $T$  is the blow-up time. This is the reason for the following choice of rescaling

$$w(s, y) = (T - t)^{\frac{1}{p-1}} u(t, x),$$

where the time and space variables  $(s, y)$  are to be defined. Here, blow-up is defined as the explosion of the supremum norm i. e.

$$\lim_{t \nearrow T} \|u(t, \cdot)\|_\infty = \infty.$$

Furthermore, for a initial condition  $u_0$  blowing up at time  $T$ , the blow-up set  $B(u_0)$  is the set of points where  $u$  tends to infinity as  $t \nearrow T$ , i. e.

$$B(u_0) = \{a \in \bar{\Omega} / \exists(x_n) \rightarrow a, (t_n) \rightarrow T | u(t_n, x_n) \rightarrow \infty\}.$$

The first variable that is changed is the time in such a way that the new time variable goes to  $+\infty$  as the old goes to  $T$ , in other words

$$s = \log(T - t).$$

Furthermore the space variable gets rescaled through

$$y = (T - t)^\gamma(x - a),$$

where  $a$  is a blow-up point. The exponent  $\gamma$  is to be chosen according to the equation so that the equation on  $w$  is "nice". We will see which role it plays in the examples.

The similarity change of variables depends on blow-up time  $T$  and blow-up point  $a$ . However the equation on  $w$  does not depend on  $T$  and  $a$ . Let us give this equation a name:

$$w_s = q(w, \nabla w, \nabla, y) \tag{5.15}$$

If  $w^*$  is an equilibrium of Equation 5.15, then the corresponding  $u$  solution of the original equation 5.13 reads

$$u(t, x) = (T - t)^\beta w^* ((T - t)^\gamma(x - a)),$$

and is a self-similar solution and blows up exactly at the rate of the ODE 5.14.

Moreover the original equation 5.13 often admits an energy functional  $E(u)$  which is decreasing along trajectories. This energy induces a Lyapunov function also for the rescaled equation 5.15. This helps proving the convergence of bounded solutions  $w(s, \cdot)$  towards equilibria that we will denote by  $w^*$ .

We have that the similarity variables allows to translate a problem at infinity into a finite problem by rescaling the original partial differential equation appropriately. However, there is a crucial difference between the similarity variables and the compactifications by Bendixson or Poincaré: the lasts are global transformations projecting a vector space on a bounded manifold. The similarity change of variables is something local, which zooms in the blow-up points in the following sense. Recall that the new space variable  $y$  is defined as  $y = (T - t)^\gamma(x - a)$ ,

$$\text{where } \begin{cases} T = \text{blow-up time} \\ a = \text{blow-up point} \\ \gamma < 0 \end{cases} .$$

Hence at the blow-up time  $t \nearrow T$  or equivalently  $s \rightarrow \infty$ , it holds for  $x \neq a$ ,  $|y| \rightarrow \infty$ : the points  $x$  that are distant from the blow-up point  $a$  are pushed away to infinity by the similarity variables as time  $s$  goes by. Considering an arbitrary blow-up solution  $u(t, x)$  of equation 5.13 admitting a blow-up time  $a$ , and its rescaled version  $w_a(s, y)$  by similarity change of variables around the point  $a$ , the limiting equilibrium

$$w^*(y) = \lim_{s \rightarrow \infty} w(s, y) \tag{5.16}$$

$$(\text{=} \lim_{t \nearrow T} (T - t)^\beta u(t, a + (T - t)^\gamma y)), \tag{5.17}$$

if it exists, is called **local** blow-up profile.

This is to be compared with the **global** blow-up profile

$$u(T, x) = \lim_{t \nearrow T} u(t, x) \in \mathbb{R} \cup \{\pm\infty\}, \tag{5.18}$$

if this limit exists. For example this limit exists for self-similar solutions with blow-up set reduced to one point.

To fix the ideas, let us consider a blow-up solution  $u$  of the original equation 5.13 admitting finitely many blow-up points  $\{a_1, \dots, a_m\}$ . Making at each  $a_i$  a similarity change of variables provides rescaled solution around blow-up points  $a_i$  that we denote by  $w_{a_i}(s, t)$ ,  $i \in \{1, \dots, m\}$  which may converge to equilibria  $w_i^*$  of equation 5.15, which are called local blow-up profiles. The  $w_i^*$  give only information about the behaviour of  $u$  around each blow-up point  $a_i$  at blow-up time (see the dotted graphs in Figure 5.6, this is only a caricature as  $w^*$  and  $u$  cannot be represented in the same space-time coordinates simultaneously at time  $T$ ) while the global profile gives information about the profile between the blow-up points at blow-up time (see the solid graph in Figure 5.6).

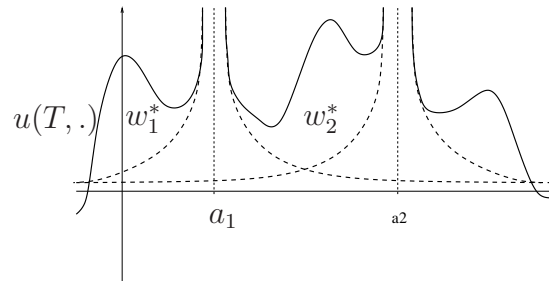

Figure 5.6: Global and local blow-up profiles.

In the context of similarity variables, blow-up is considered in the supremum norm. The self-similar blow-up solutions escape to something that we intuitively expect to be an equilibrium at infinity, and the global blow-up profiles are also objects that we expect to be stationary at infinity. It is natural to think about these as being equilibria on the sphere at infinity in the Poincaré compactification. However, things are not so simple: the function space  $X$  in which the original equation lives has to be chosen carefully for these objects to be in the sphere at infinity defined by the norm of  $X$  which comes from a scalar product - which is not the case for the supremum norm. There is here obviously a gap to fill in order to be able to interpret the information given by the similarity variables in the language of the Poincaré compactification. Here again, we will address this question for the two examples below.

However, as we try in this section to understand heuristically what the similarity of blow-up means, let us assume that we are in a situation where self-similar solution and more generally all solution admitting a global blow-up profile converges in the Poincaré compactification towards equilibria on the sphere at infinity. Given a fixed finite set of blow-up points  $B = \{a_1, \dots, a_m\}$ : how are solutions related whose blow-up set is a subset of the set  $B$ ? Or more precisely do their global blow-up profiles build a submanifold of the sphere at infinity? If

this is the case, can we parametrize it? Parametrization by shape of the global blow-up profile for some unstable manifolds escaping to infinity have been done by Fiedler and Matano [15] on the one hand, and by Georgi [18] on the other hand.

A last important point concerning the similarity variables is the following: nobody says that the rate of blow-up of solutions of the original equation 5.13 has to be exactly the rate of the corresponding ODE 5.14. We will eventually see in the next section that blow-up at a different rate may happen. This phenomenon is called blow-up of type II and is more precisely defined by the fact that

$$\limsup_{t \nearrow T} (T - t)^\alpha \|u(t, \cdot)\|_\infty = \infty,$$

where  $\alpha$  is the blow-up rate of the ODE 5.14.

After those general considerations, let us look at examples.

### 5.5.2 Power Nonlinearity

The first example we look at will make some of the speculations that we made in the previous section concrete. Matano and Merle in their Paper [25] study blow-up phenomena of the equation

$$\begin{cases} u_t = \Delta u + |u|^{p-1}u & (x \in \Omega, t > 0) \\ u(0, x) = u_0(x) & (x \in \Omega) \end{cases} \quad (5.19)$$

where  $\Omega$  is either the whole  $\mathbb{R}^n$  or an open ball  $B_R(0)$  around the origin of  $\mathbb{R}^n$ . In the last case, Dirichlet boundary conditions are considered. Furthermore we consider only radially symmetric solutions  $u(t, x) = u(t, |x|)$ .

They are using the following similarity change of variables for fixed blow-up time  $T$  and blow-up point  $a$ :

$$w = (T - t)^{-\frac{1}{p-1}} u(t, x), \quad (5.20)$$

$$y = (T - t)^{\frac{1}{2}}, \quad (5.21)$$

$$s = -\log(T - t). \quad (5.22)$$

Then the equation solved by  $w$  does not depend on  $a$  and  $T$  and reads

$$w_s = \Delta w - \frac{1}{2}y \cdot \nabla w - \frac{1}{p-1}w + |w|^{p-1}w. \quad (5.23)$$

A blow-up solution  $u$  of Equation 5.19 is self-similar if and only if the corresponding  $w$  defined by the rescaling 5.20 is constant in time, i. e. is a stationary solution  $w^*$  of Equation 5.23. Furthermore, the blow-up of a solution  $u$  at the point  $a$  is of type I if and only if the corresponding  $w$  defined by the rescaling

5.20 remains bounded as  $s \rightarrow \infty$ . With the help of a decreasing energy functional and parabolic estimates, it is possible to prove that a bounded solution  $w(s, y)$  converges to an equilibrium  $w^*$  of Equation 5.23, meaning blow-up of type I is locally self-similar.

As we already indicate before, let us denote equilibria of Equation by  $w^*$ . There are two of them which are constant in space and solve the equation

$$0 = -\frac{1}{p-1}w^* + |w^*|^{p-1}w^*.$$

beside the trivial equilibrium, we have two spatially homogenous equilibria

$$\pm\kappa = \pm(p-1)^{-\frac{1}{p-1}}. \quad (5.24)$$

Note that the domain of the new space variable  $y$  is  $\mathbb{R}^n$  so that we do not have boundary conditions to satisfy for  $w$ .

Until now the dimension of the space variable  $n$  or the exponent of the non-linearity  $p$  did not play any role. We want here to restrict us to the cases where there are as many blow-up behaviours as possible. More precisely

$$\begin{aligned} n &\geq 3 \\ p &> p_{JL} > p_S, \end{aligned}$$

where  $p_S$  is the critical Sobolev exponent

$$p_S = \frac{n+2}{n-2},$$

and

$$p_{JL} = 1 + \frac{4}{n-4-2\sqrt{n-1}}.$$

The inequality  $p > p_S$  guarantees the existence of equilibria  $w^*$  non spatially homogenous. The inequality  $p > p_{JL}$  guarantees the existence of type II blow-up. See [25] for details and history. In these settings, we have beside the homogenous equilibria  $\pm\kappa$  also equilibria  $w^*(y)$  of Equation 5.23 that we do not know explicitly. Furthermore there are singular equilibria given by

$$\pm\varphi^*(x) = \pm \left( \frac{2}{p-1} \left( n-2 - \frac{2}{p-1} \right) \right) |x|^{-\frac{2}{p-1}}$$

Furthermore, a blow-up of type II can only happen at the blow-up point  $a = 0$ , while blow-up at points  $a \neq 0$  are always of type I, where the limiting equilibrium  $w^*$  may be spatially homogenous or not. The following proposition guarantees the existence of local blow-up profiles (See [25][Th. 3.1]).

**Proposition 5.5.1. Existence of Local Blow-up Profiles at the origin**

Let  $p > p_S$  be a fixed subcritical exponent and  $u_0$  a  $L^\infty(\Omega)$  initial condition blowing-up at time  $T$ . The limit 5.16 defining the local blow-up profiles exists, the convergence being locally uniform in  $y \in \mathbb{R}^n$ . This limit is either a radial symmetric equilibrium  $w^*$  of Equation 5.23, or a singular stationary solution  $\pm\varphi^*$

Note that local blow-up profiles also exist at blow-up points  $a \neq 0$ , but the limit can only be an equilibrium  $w^*$  and not a singular one. The singular equilibria  $\pm\varphi^*$  are closely related to blow-up of type II in the following sense (See [25][Th. 3.2]).

**Proposition 5.5.2. Characterisation of type II blow-up**

Let  $p > p_S$  be a fixed subcritical exponent,  $u_0$  a  $L^\infty(\Omega)$  initial condition blowing-up at time  $T$  and  $v^*$  its local blow-up profile at the origin as in Proposition 5.5.1. The following four condition are equivalent.

1. The blow-up is of type II.
2.  $\lim_{t \nearrow T} (T - t)^{\frac{1}{p-1}} \|u(t, \cdot)\|_\infty = \infty$ .
3.  $v^*(y) = \pm\varphi^*(y)$ .
4.  $\lim_{x \rightarrow 0} \frac{u(T, x)}{\varphi^*(x)} = \pm 1$ .

The singular equilibrium  $\varphi^*$  of Equation 5.23 plays a role in the determination of the local blow-up profile around the blow-up point 0.

**Proposition 5.5.3. Classification of focused blow-up ( $p_S < p < \infty$ )**

$$\lim_{x \rightarrow 0} \frac{u(T, x)}{\varphi^*(x)} = \begin{cases} \infty \text{ or } +\infty & \Leftrightarrow \text{type I with } w^* = \pm\kappa \\ \text{finite but } \neq 0, \pm 1 & \Leftrightarrow \text{type with nonconstant } w^* \\ \pm 1 & \Leftrightarrow \text{type II} \\ 0 & \Leftrightarrow 0 \text{ is not a blow-up point} \end{cases}$$

Now let us draw our attention to the equilibria of the rescaled Equation 5.23 which are given explicitly. First consider the spatial homogenous equilibria  $w^* = \pm\kappa$ . It corresponds for the original Equation 5.19 to a selfsimilar blow-up solution given by

$$u(t, x) = \pm(T - t)^{-\frac{1}{p-1}} \kappa,$$

which is also spatially homogenous. If the domain is  $\Omega = B_0(R)$ , such a solution does not fulfill the Dirichlet boundary conditions that are assume through [25]. If the domain is  $\Omega = \mathbb{R}^n$ , then the  $L^2$ -norm of  $u$  is infinite for all time. We see on this example that translating self-similar blow-up into equilibria on the Poincaré sphere is not an easy task because the information given by the first is local, and

the information given by the second is global.

The second explicit equilibrium that we have is the singular one  $\varphi^*$ . Let us compute its  $L^2$ -norm.

$$\begin{aligned} \|\varphi^*\|^2 &= cst_1 \int_{\mathbb{R}^n} |x|^{-2\frac{2}{p-1}} dx \\ &= cst_2 \lim_{R \rightarrow \infty} R^n \int_0^R r^{-\frac{4}{p-1}} dr \\ &= cst_2 \lim_{R \rightarrow \infty} R^n \left[ \frac{1}{1 - \frac{4}{p-1}} r^{1 - \frac{4}{p-1}} \right]_0^R \\ &= cst_3 \lim_{R \rightarrow \infty} R^n \left[ r^{1 - \frac{4}{p-1}} \right]_0^R \end{aligned}$$

If  $1 - \frac{4}{p-1} < 0$ , then  $\|\varphi^*\|^2 = \infty$  because  $r^{1 - \frac{4}{p-1}}$  admits no limit as  $r$  goes to zero. This condition is equivalent to  $1 < p < 5$ .

If  $1 - \frac{4}{p-1} > 0$ , i.e.  $p \geq 5$ , then  $\lim_{r \searrow 0} r^{1 - \frac{4}{p-1}} = 0$  and it holds

$$\begin{aligned} \|\varphi^*\|^2 &= cst_3 \lim_{R \rightarrow \infty} R^n R^{1 - \frac{4}{p-1}} \\ &= cst_3 \lim_{R \rightarrow \infty} R^{n+1 - \frac{4}{p-1}} \end{aligned}$$

This limit is finite if and only if  $n + 1 - \frac{4}{p-1} \leq 0$ . This is equivalent to  $1 < p \leq 1 + \frac{4}{n-1}$ , which seriously reduces the choice of the exponent. In particular, it is not compatible with the first condition  $p \geq 5$ . Therefore  $\|\varphi^*\|^2$  is infinite and we cannot interpret  $\frac{\varphi^*}{\|\varphi^*\|}$  as an equilibrium on the sphere at infinity of  $L^2$ , because with this choice of norm, this makes no sense.

Again, we cannot identify equilibria at infinity corresponding to  $\pm\varphi^*$ . If the  $L^2$ -norm is not finite, norms involving additional derivatives will not help. Considering weighted spaces may help in this context. We see that the choice of the scalar product on the space  $X$  is a delicate question.

### 5.5.3 Parabolic Scalar Curvature Equation

Brian Smith studied in [37] blow-up phenomena for the parabolic scalar curvature equation. Let us briefly introduce this equation and his results.

Let  $M$  be a manifold foliated by 2-dimensional spheres, i. e. one can write  $M$  as the product  $M = I \times S^2$ , where  $I$  is a real interval. Furthermore, the metric  $g$  on  $M$  is supposed to have the following structure

$$g = u^2 dr^2 + r^2 \gamma,$$



where  $\gamma$  is a fixed metric on the spheres  $\{r\} \times S^2$ , and  $u$  is a unknown function that we desire to determine in such a way that the scalar curvature on  $M$  is a prescribed function  $R$ . This setting leads to the complicated equation on  $u$ :

$$2r\partial_r u = u^2 \Delta u + u + fu^3,$$

where  $\Delta$  is the Laplacian on  $S^2$  with metric  $\gamma$ . Transforming the radial variable in a time variable and rescaling  $u$  in  $\tilde{u}$  leads to the following equation that we want to draw our attention on. For the details of its derivation, see [37].

$$\tilde{u}_t = \tilde{u}^2 \Delta \tilde{u} + f\tilde{u} \quad (5.25)$$

This equation undergoes blow-up. The blow-up rate of the corresponding ODE is  $(T-t)^{-\frac{1}{2}}$ , and similarity variable can be used to study blow-up. Here, the homogeneity of the equation 5.25 has for consequence that we do not need to rescale the space variable: in this case, the similarity variable have not the effect that we zoom in the blow-up point at blow-up time, but keep the same space coordinate  $p \in S^2$ . We will see that this has nice effects. To be more precise, the change of variables is the following:

$$\begin{cases} e^{-\tau} = T - t \\ v = (T - t)^{\frac{1}{2}} \tilde{u} \end{cases} \quad (5.26)$$

The equation on  $v$  reads

$$v_\tau = v^2 \Delta v + fv^3 - \frac{1}{2}v. \quad (5.27)$$

The results of Smith concerning the long time behaviour of this equation can be summarized in the following theorem.

**Theorem 5.5.4** (Smith). *Any solution  $v$  of Equation 5.27 which is positive and remain bounded away from 0; i.e. there exist a  $\mu > 0$  with  $v \geq \mu$ , is also bounded from above by  $+\infty > M \geq v$ . Furthermore, a solution  $v$  of Equation 5.27 which is bounded by  $0 < \mu \leq v \leq M < +\infty$  converges for  $\tau \nearrow +\infty$  to an equilibrium  $w^*$  of Equation 5.27 in the sense of  $C^k(S^2)$ .*

This describes in fact a blow-up of type I of the original Equation 5.25; i.e. at the ODE rate. Note that blow-up of type II is not excluded: it could happen for solutions  $v$  of Equation 5.27 which do remain bounded away from 0 and may escape to infinity. Under this viewpoint, it could be promising to study the stable and unstable manifold of the origin, which may contain such blow-up solutions of type II.

Now let us look at Equation 5.25 from the viewpoint of Poincaré compactification.

The Equation 5.25 induce on the sphere at infinity the following normalized equation, where the scalar product is the scalar product of  $L^2(S^2)$ .

$$\chi_t = g(\chi) - \langle g(\chi), \chi \rangle \chi. \quad (5.28)$$

Here  $g(\chi) = \chi^2 \Delta \chi + f \chi^3$ . If  $w^*$  is a stationary solution of the rescaled Equation 5.27, we set  $\chi^* := \frac{w^*}{\|w^*\|}$  and observe that  $\chi^*$  is a stationary solution of Equation 5.28 in the sphere at infinity  $\mathcal{E}$ . For this equation, homogeneity makes us a favour and let the self-similar blow-up translate nicely to equilibria at infinity.

In the case that  $f$  is a constant, we can explicitly determine stationary solutions which are constant in space: for  $w^*(p) \equiv cst$ ,  $p \in S^2$ , the condition that  $w^*$  is an equilibrium of Equation 5.27 reads

$$0 = w^*(fw^2 - \frac{1}{2})$$

For  $f > 0$ , we end up with two nontrivial spatially homogenous equilibria of Equation 5.27

$$w^* = \pm \frac{1}{\sqrt{2f}}.$$

The linearization at these equilibria of Equation 5.27 reads

$$Lh = \frac{1}{2f} \Delta h + h. \quad (5.29)$$

The Eigenvalues of  $L$  are

$$1 > 1 - \frac{\lambda_0}{2f} > 1 - \frac{\lambda_1}{2f} > \dots$$

where  $\{\lambda_i\}_{i \in \mathbb{N}}$  are the positive eigenvalues of  $-\Delta$  on the sphere. For  $f$  small, the spectrum of  $L$  looks like on Figure 5.7: the eigenvalue 1 corresponding to constant eigenfunctions is unstable, and the others are stable. As  $f$  grows, finitely many eigenvalues  $1 - \frac{\lambda_i}{2f}$  becomes unstable.

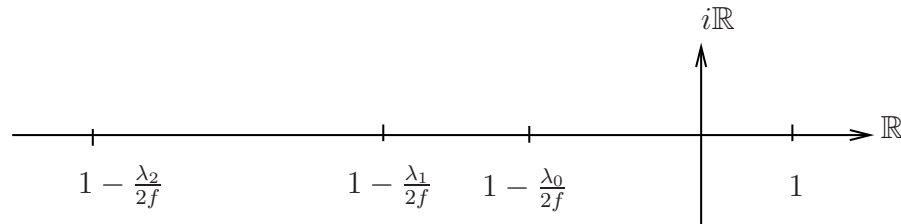

Figure 5.7: Spectrum of  $L$ .

Now let us shortly have a look at the finite equilibria, i.e. equilibria of Equation 5.25 in the case where  $f$  is a positive constant. They are given by the equation

$$0 = \tilde{u}^2(\Delta \tilde{u}) + f \tilde{u}.$$

Equation 5.25 admits nontrivial finite equilibria if and only if  $-f$  is an eigenvalue  $\lambda_i > 0$  of  $-\Delta$ , and in this cases, the whole line spanned by the corresponding eigenfunction is a line of equilibria. This line of equilibria generates two antipodal equilibria in the sphere at infinity  $\mathcal{E}$ .

Work has still to be done to relate the finite and the infinite dynamics of this problem. In particular studying type II blow-up; understanding how the Laplacian plays a role in the dynamics at infinity, as it belongs to the terms of highest order.



# Conclusions

In this work, we have defined the concept of invariant sets of isolated invariant complement. They have the particularity that they do not admit a robust isolating neighbourhood. However, they admit a “dynamical” complement, which contains the dynamic that remains bounded away from them; and their dynamical complement is isolated invariant. We are able to extract information about heteroclinic connections to a set of isolated invariant complement via Conley index methods, which a priori are expected to fail in such a situation.

To this purpose, we cut away the set which does not fit the requirements of Conley index theory, and consider the flow on an isolating block of the complement. Then we glue at the boundary of the block an “ersatz” which fulfills these requirements. Because of the dynamical complementarity of the two invariant sets considered, connections in the extended phase space provides orbit accumulating on the set of isolated complement in the original phase space. The choice of the ersatz is important. Extending arbitrarily outside of the fixed block isolating the complement could provide isolated invariant sets in the extension - but the artificial connections arising in the extended phase space have to be detectable by Conley index methods. We believe that we defined the “right” ersatz; with that, we mean that it should be in many situations the easiest way of extending the flow outside of the block.

We have developed these concepts because we were interested in applying Conley index methods to detect heteroclinics to infinity. In the compactified phase space, there may be in the sphere at infinity invariant sets of isolated complements (and not isolated themselves) and whose behaviour near infinity is structurally stable.

In particular, we are interested in blow-up phenomena for partial differential equations. We have seen in the last chapter that the compactifications we use works well in the asymptotically linear case. They provide dynamics at infinity with a lot of structure: equilibria at infinity connected by cascades of connections show up.

In case where the dynamic at infinity is leaded by higher order terms, things get unclear. It is not even clear what is infinity in this case. Because on infinite dimensional spaces the norms are not all equivalent, a solution may become infinite in the one norm, but not in the other.

A “good” choice for the norm should allow us to make sense of results about blow

up obtained by other means - for example involving the similarity variables. We want the self similar blow-up results prove by such means to become equilibria at infinity in our compactification. Furthermore, we need more than existence results on them to use Conley Index methods, but need to know their behaviour in a neighbourhood.

Before we can apply Conley index methods to them, we have to clarify which norm has to be used to define infinity. Or how the different spheres at infinity interact, because it is possible that we need several choices of norm to see several type of blow-up.

We think that this way of considering blow-up phenomena is worth exploring and that the concepts developed in the thesis will find applications in this context. This work lays the groundwork for further research in this direction.

# Appendix

## Zusammenfassung

Diese Arbeit beschäftigt sich mit der Analyse der Dynamik im Unendlichen, und wie diese mit der endlichen Dynamik zusammenhängt. Eine Trajektorie explodiert, wenn sie in endlicher Zeit unendlich groß wird: dieses Phänomen wird als Blow-up bezeichnet. Solche Trajektorien betrachten wir als heterokline Orbits zum Unendlichen. Wir wollen beschreiben, welche invarianten Mengen mit dem Unendlichen durch solchen explodierenden Orbits verbunden sind. Zum Nachweis heterokliner Trajektorien existiert eine klassische Methode, die auf Topologie basiert: die Conley-Index Theorie. Allerdings kann man den Conley-Index nicht auf unbeschränkte Mengen anwenden. Um diese Schwierigkeit zu umgehen, wird eine "Kompaktifizierung" des Phasenraumes vorgenommen. Dabei geht es darum, den Phasenraum  $X$  auf eine beschränkte Mannigfaltigkeit zu projizieren. Dies kann auf verschiedene Art und Weise geschehen. Wir konzentrieren uns auf zwei: die Bendixson-Kompaktifizierung, und die Poincaré-Kompaktifizierung. Diese wurden ursprünglich für die Analyse von planaren Vektorfeldern entwickelt. Wir zeigen aber, dass diese Kompaktifizierungen in einem Hilbertraum durchführbar sind. Bei einem unendlich-dimensionalen Raum  $X$  ist die Bezeichnung "Kompaktifizierung" eigentlich falsch, da die Hilbert-Mannigfaltigkeit, die dabei herauskommt, zwar beschränkt ist, aber wegen ihrer unendlichen Dimension nicht kompakt. Wir behalten den Namen trotzdem aus historischen Gründen. Bei der Bendixson-Kompaktifizierung wird Unendlich auf einem Punkt abgebildet, während in der Poincaré-Kompaktifizierung es sich in einer ganzen Sphäre ausbreiten kann. Die direkte Anwendung der Conley-Index Methoden auf dem Punkt im Unendlichen, oder auf einer invarianten Menge in der Sphäre im Unendlichen ist nicht immer möglich: die ausschlaggebende Voraussetzung der isolierten Invarianz ist oft im Unendlichen verletzt. Schon planare quadratische Vektorfelder besitzen Equilibria im Unendlichen, die elliptische Sektoren zeigen und sich nicht mit der klassischen Theorie behandeln lassen. Wir führen das Konzept einer invariante Menge  $S$  im Unendlichen, die einen isoliert invariantes "dynamischen" Komplement  $S_{comp}$  besitzt, ein. Dieses dynamische Komplement enthält, grob gesagt, die Dynamik, die fern von  $S$  bleibt. Es erlaubt uns, einen erweiterten Phasenraum und einen erweiterten Fluss zu konstruieren, wobei die "degenerierte" invariante Menge  $S$  durch etwas ersetzt wird, womit der Conley-Index gut umgehen kann. Unser Hauptresultat besagt, dass die Existenz von heteroklinen Trajektorien zwischen einer invarianten Menge  $R \subset S_{comp}$  und dem "Ersatz" unter dem erweiterten Fluss von Conley-Index Methoden nachweisbar ist, und liefert die Existenz von echten heteroklinen Trajektorien nach  $S$ . Darüber hinaus zeigen wir Beispielen für Dynamik im Unendlichen und die Anwendung dieser Methoden für gewöhnliche und teilweise auch für partielle Differentialgleichungen. In dem Gebiet der partiellen Differentialgleichungen müssen noch zahlreiche Hürden überwunden werden, und diese Arbeit soll ein erster Schritt in diese Richtung sein.



# Bibliography

- [1] A.A. Andronov, E.A. Leontovich, I.I. Gordon, and A.G. Maier. *Qualitative Theory of Second-Order Dynamic Systems. Translated from Russian by D. Louvish.* Halsted Press Book, 1973.
- [2] Joan C. Artés and Jaume Llibre. Quadratic hamiltonian vector fields. *Journal of Differential Equations*, 1994.
- [3] Nitsan Ben-Gal. *Grow-Up Solutions and Heteroclinics to Infinity for Scalar Parabolic PDEs — in preparation.* PhD thesis, Brown University, Providence, USA, 2009.
- [4] Marco Brunella and Massimo Miari. Topological equivalence of a plane vector field with its principal part defined through newton polyhedra. *Journal of differential equations*, 1990.
- [5] P. Brunovský and B. Fiedler. Connecting orbits in scalar reaction diffusion equations. *Dyn. Rep.* 1, 57-89 (1988)., 1988.
- [6] P. Brunovský and B. Fiedler. Connecting orbits in scalar reaction diffusion equations. ii: The complete solution. *J. Differ. Equations*, 81(1):106–135, 1989.
- [7] Laurent Cairo and Llibre Jaume. Phase portraits of cubic polynomial vector fields of lotka–volterra type having a rational first integral of degree 2. *J. Phys. A: Math. Theor.*, 2007.
- [8] Anna Cima and Llibre Jaumes. Bounded polynomial vector fields. *Transactions of the American Mathematical Society*, 1990.
- [9] Courtney S. Coleman. Boundedness and unboundedness in polynomial differential systems. *Nonlinear Analysis. Theory, Methods and Applications*, 1984.
- [10] Charles Conley. Isolated invariant sets and the morse index. *CMBS Regional Conf. Ser. Math.*, 38, 1978.

- [11] Charles C. Conley. The gradient structure of a flow. *Ergod. Th. Dynam. Sys.*, 1988.
- [12] Albrecht Dold. *Lectures on Algebraic Topology*. Springer–Verlag, 1972.
- [13] Freddy Dumortier. Techniques in the theory of local bifurcations: Blow-up, normal forms, nilpotent bifurcations, singular perturbations., 1993.
- [14] Uri Elias and Harry Gingold. Critical points at infinity and blow-up of solutions of autonomous polynomial differential systems via compactification. *Journal of mathematical analysis and applications*, 2006.
- [15] Bernold Fiedler and Hiroshi Matano. Global dynamics of blow-up profiles in one dimensional reaction diffusion equations. *J. Dyn. Diff. Eqs.*, 2007.
- [16] Robert D. Franzosa. The connection matrix theory for morse decompositions. *Trans. Am. Math. Soc.*, 311(2):561–592, 1989.
- [17] Robert D. Franzosa and Konstantin Mischaikow. The connection matrix theory for semiflows on (not necessarily locally compact) metric spaces. *J. Differ. Equations*, 71(2):270–287, 1988.
- [18] Marc Georgi. The shape of profiles exhibiting blow up in forward and backward time. download under <http://dynamics.mi.fu-berlin.de/persons/georgi.php>.
- [19] Enrique A. González Velasco. Generic Properties of Polynomial Vector Fields at Infinity. *Trans. Am. Math. Soc.*, 143:201–222, 1969.
- [20] Dan Henry. Some infinite-dimensional morse-smale systems defined by parabolic partial differential equations. *J. Differ. Equations*, 59:165–205, 1985.
- [21] Efthimios Kappos. The conley index and global bifurcations. i: Concepts and theory. *Int. J. Bifurcation Chaos Appl. Sci. Eng.*, 5(4):937–953, 1995.
- [22] Efthimios Kappos. The conley index and global bifurcations. ii: Illustrative applications. *Int. J. Bifurcation Chaos Appl. Sci. Eng.*, 6(12b):2491–2505, 1996.
- [23] Efthimios Kappos. Compactified dynamics and peaking. In *Circuits and Systems, 2000. Proceedings. ISCAS 2000 Geneva.*, 2000.
- [24] Hiroshi Kokubu and Robert Roussarie. Existence of a singularly degenerate heteroclinic cycle in the lorenz system and its dynamical consequences. i. *J. Dyn. Differ. Equations*, 16(2):513–557, 2004.

- [25] Hiroshi Matano and Frank Merle. Classification of type i and type ii behaviors for a supercritical nonlinear heat equation. *Journal of Functional Analysis*, 2009.
- [26] Christopher McCord. Poincaré–Lefschetz duality for the homology Conley index. *Transactions of the American Mathematical Society*, 1992.
- [27] Marcelo Messias. Dynamics at infinity and the existence of singularly degenerate heteroclinic cycles in the lorenz system. *J.Phys. A: Math Theor*, 2009.
- [28] Richard Moeckel. Morse decomposition and connection matrices. *Ergod. Th. and Dynam. Sys.* , 1988.
- [29] Marian Mrozek and Roman Szrednicki. On time-duality of the conley index. *Result. Math.*, 24(1-2):161–167, 1993.
- [30] Lawrence Perko. *Differential Equations and Dynamical Systems*. Springer-Verlag., 1991.
- [31] H. Poincaré. Mémoire sur les Courbes Définies par une Equation Différentielle. *Oeuvres.*, 1881.
- [32] J. Reineck. *The Connection Matrix and the Classification of Flows Arising from Ecological Models*. PhD thesis, University of Wisconsin–Madison, 1985.
- [33] Helmut Röhrl and Sebastian Walcher. Projections of polynomial vector fields and the poincaré sphere. *J. Differ. Equations*, 1997.
- [34] Krzysztof P. Rybakowski. *The Homotopy Index and Partial Differential Equations*. Springer-Verlag., 1987.
- [35] José M. R. Sanjurjo. Global topological properties of th hopf bifurcation. *Journal of Differential Equations*, 2007.
- [36] Dana Schlomiuk and Nicolae Vulpe. Geometry of quadratic differential systems in the neighborhood of infinity. *J. Differ. Equations*, 215(2):357–400, 2005.
- [37] Brian Smith. Blow–up in the parabolic scalar curvature equation. *arXiv*, 2007.
- [38] Joel Smoller. *Shock Waves and Reaction-Diffusion Equations*. Springer-Verlag, 1983.
- [39] Edwin H. Spanier. *Algebraic Topologie*. Springer–Verlag, 1966.
- [40] N.I. Vulpe. Affine-invariant conditions for the topological discrimination of quadratic systems with a center. *Differ. Equations*, 19:273–280, 1983.