



(nach v. Marées Karte 1)



a) Nordostspitze von Leukas mit Meerenge u. Westufer der Plagia-Halbinsel (nach v. Marées Karte 2)



b) Stadtgebiet, im Hintergrund Meerenge und Nehrung Gyrapetra, von Südwesten



c) Meerenge zwischen Leukas und Festland, von Südosten

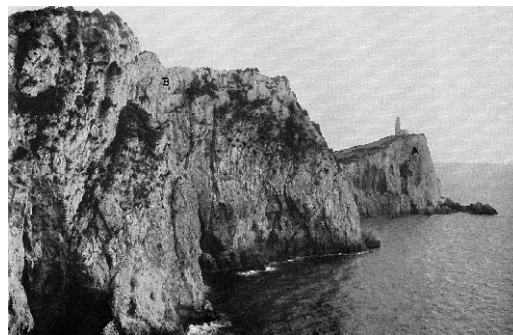

d) Westküste mit Kap Leukatas

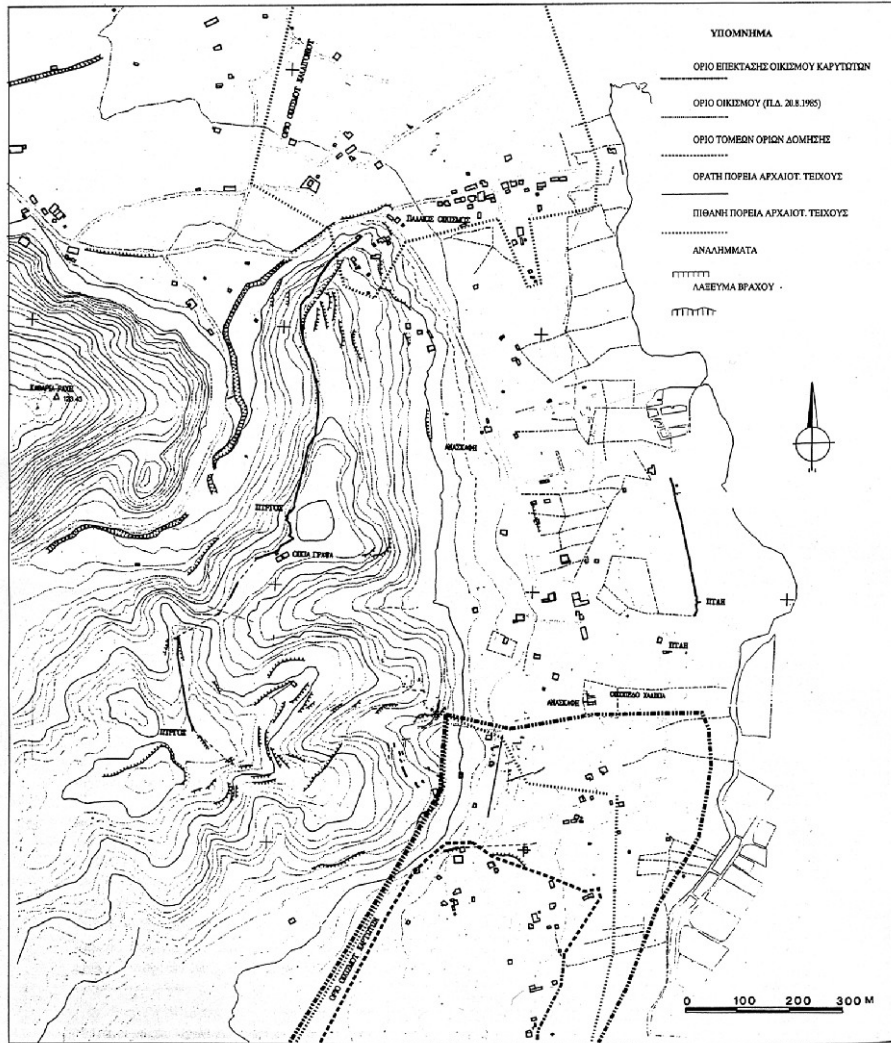

a) Antikes Stadtareal, topographische Aufnahme (G. Pliakou, ADelt 49, 1994, Chron 392ff. Abb. 11)

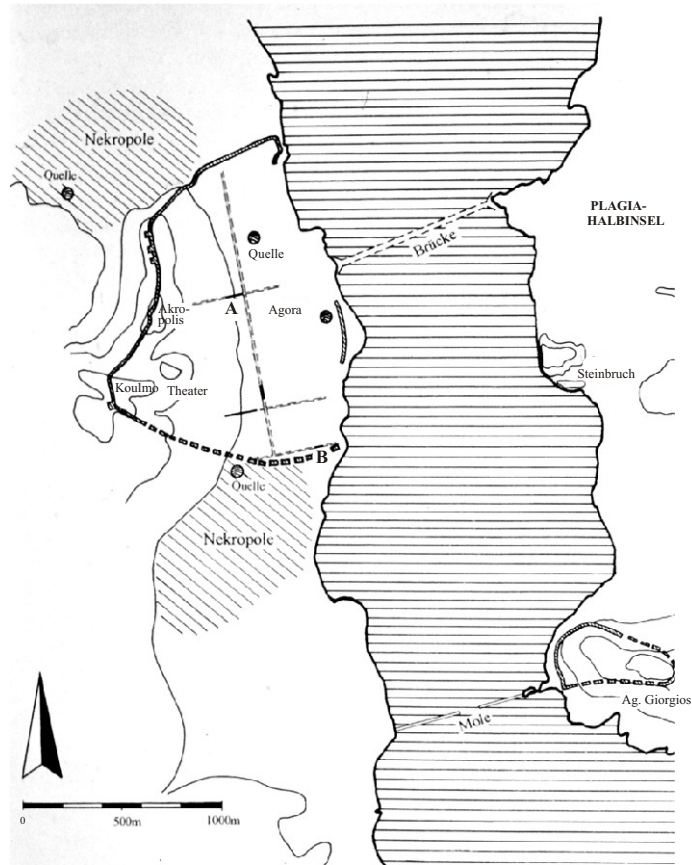

b) Stadt Leukas und Umgebung



a) vorn Ufer der Plagia-Halbinsel, im Hintergrund Stadt Leukas
(von Nordosten)

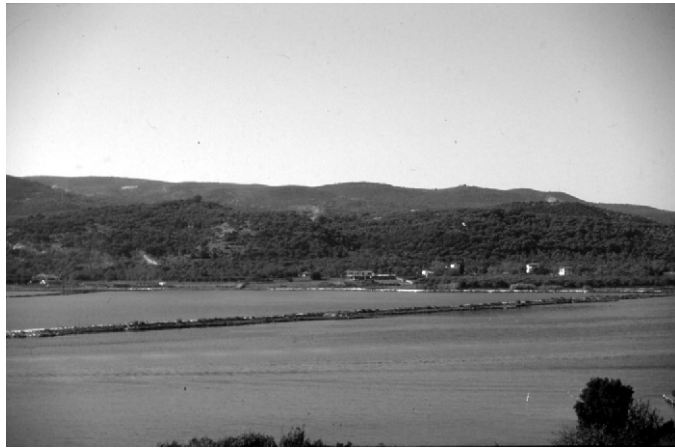

b) Stadtgebiet von Leukas (von Osten)



c) Blick von der Akropolis auf die Stadtebene und den Sund
(von Westen)



a) Stadtmauerabschnitt, 'kyklopisches' Mauerwerk (Alt-Ithaka Blg. 49b)



a) Stadtmauerabschnitt, polygonales Mauerwerk, darüber mittelalterliche Mauer
(Alt-Ithaka Blg. 49a)

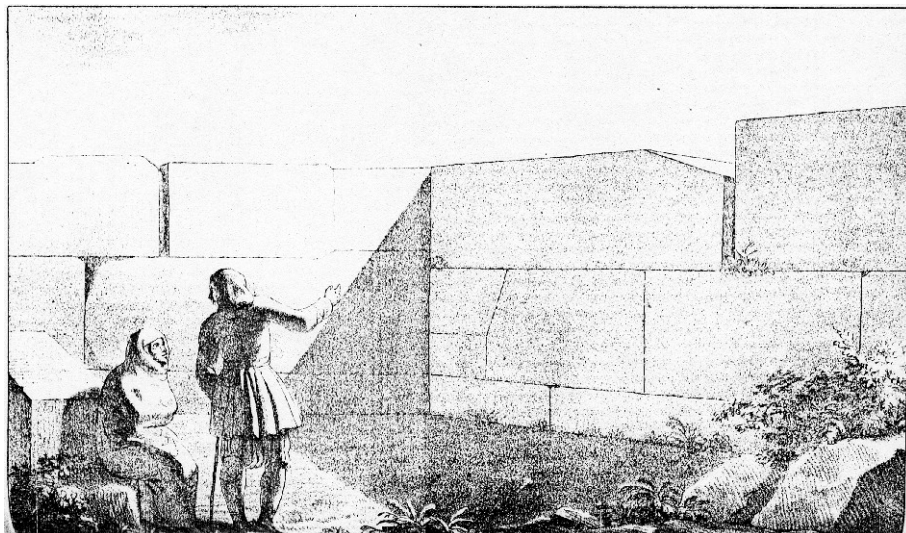

a) Skizze der Stadtmauer aus dem frühen 19. Jahrhundert (Goodisson Taf. I)

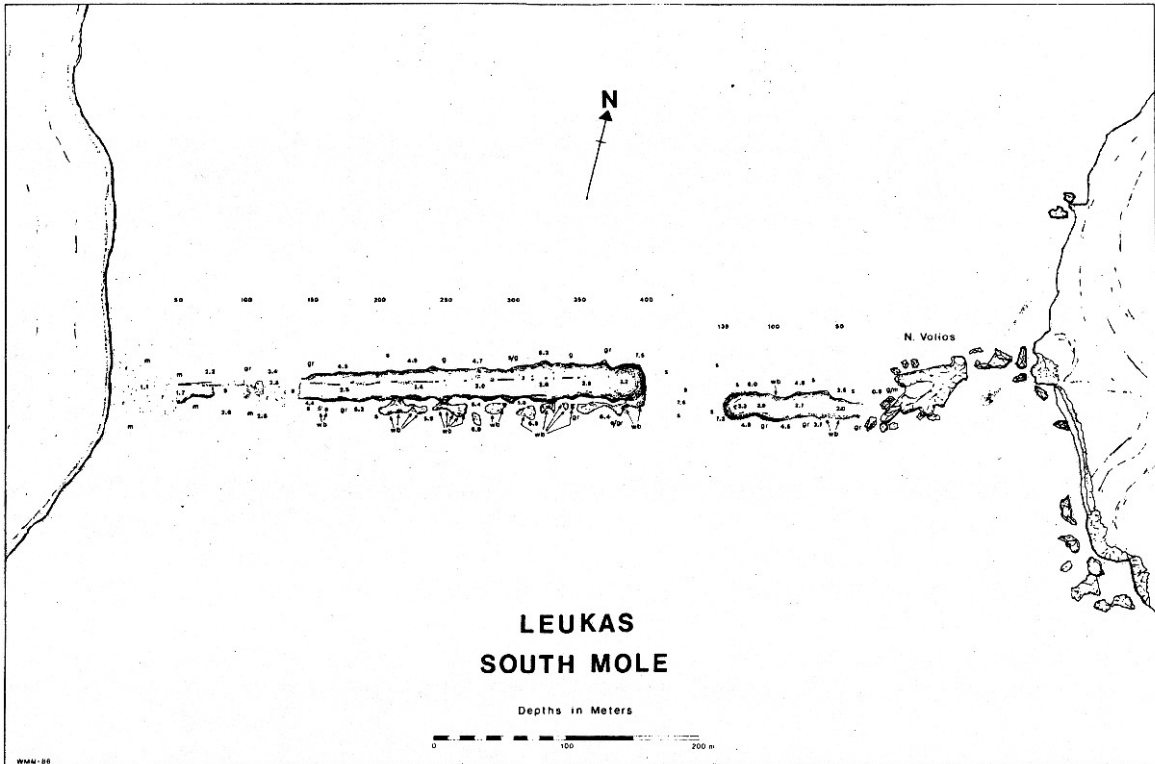

a) Mole an der südlichen Einfahrt in den Sund (W.M. Murray, in: Archaeology of Coastal Changes [1988] Abb. 4)



b) Reste der Steinbrücke am akarnanischen Ufer, im Hintergrund die Stadt Leukas



c) Reste der Steinbrücke am akarnanischen Ufer

Hausgrundrisse

Tafel 7 bis 13

a) Bauphase 1 (AII.1)

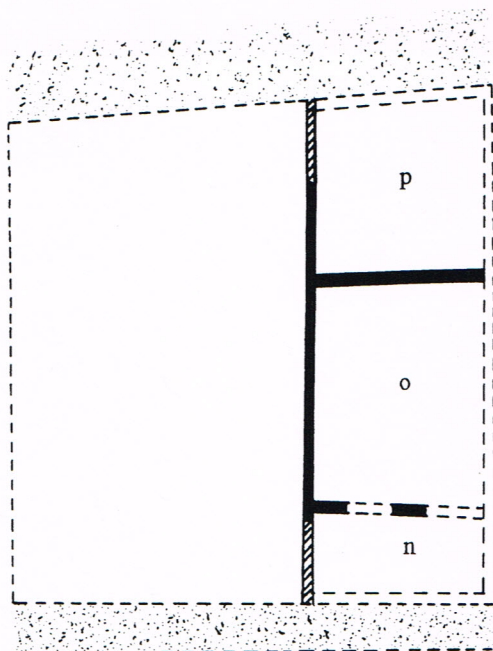



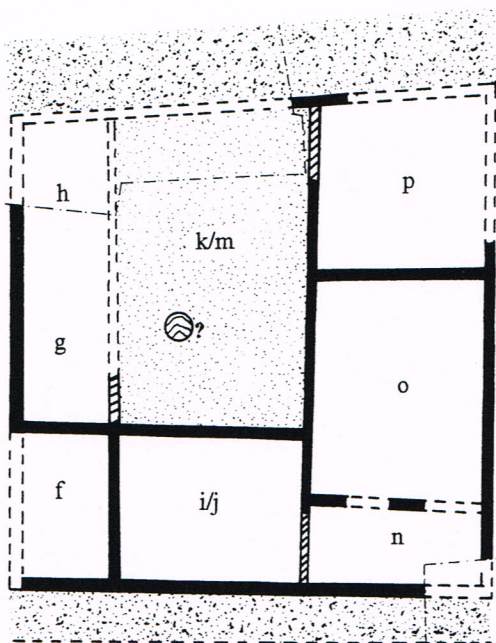

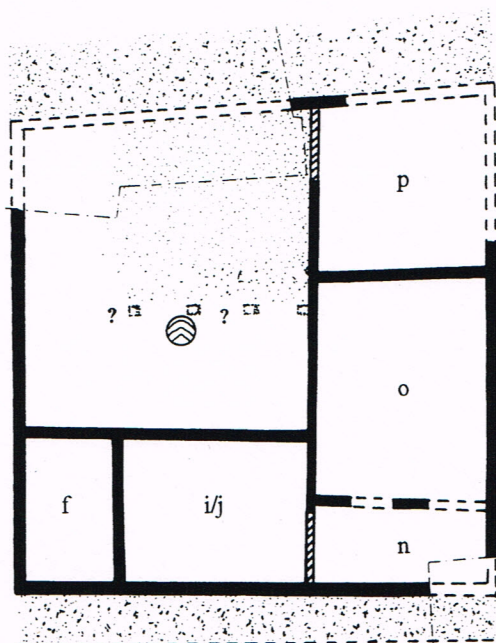

b) Bauphase 2 (AII.2)



c) Bauphase 3 (AII.3)



-  Mauerverlauf gesichert
-  Mauerverlauf wahrscheinlich (abgetragen oder verdeckt)
-  Mauerverlauf hypothetisch
-  Türdurchgang
-  vermutlicher Türdurchgang

 **Grundstück A**
Haus II
Bauphasen 1 bis 3
M 1:200

a) Bauphase 4 (AII.4)

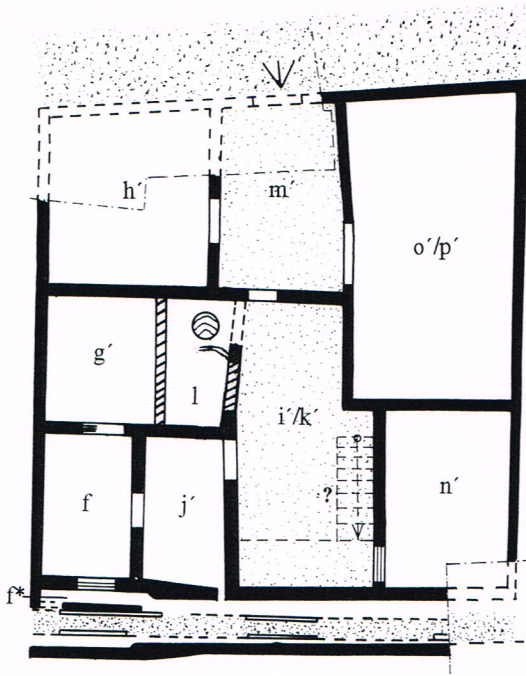

b) Bauphase 5 (AII.5)

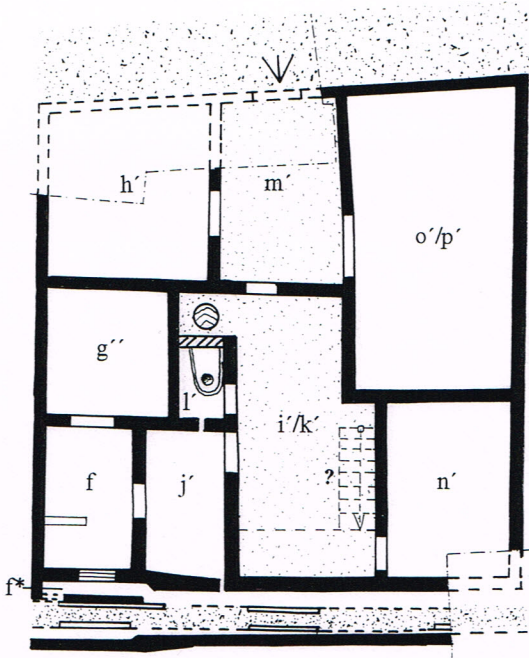

c) Bauphase 6 (AII.6)

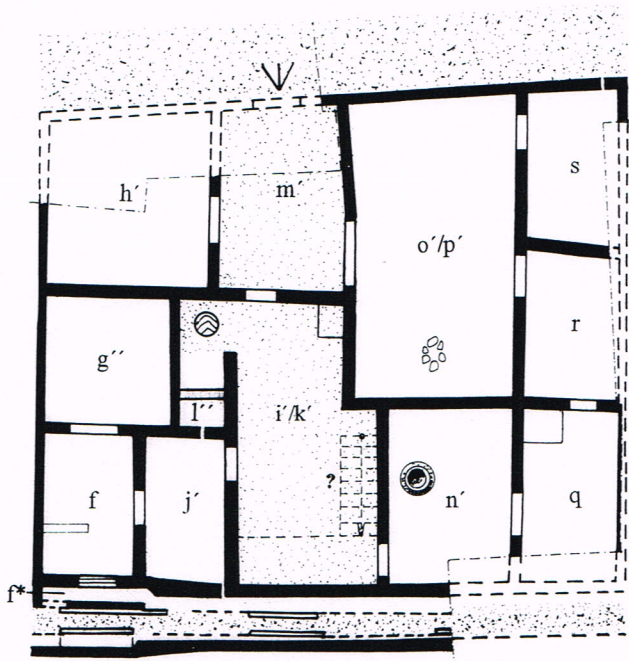

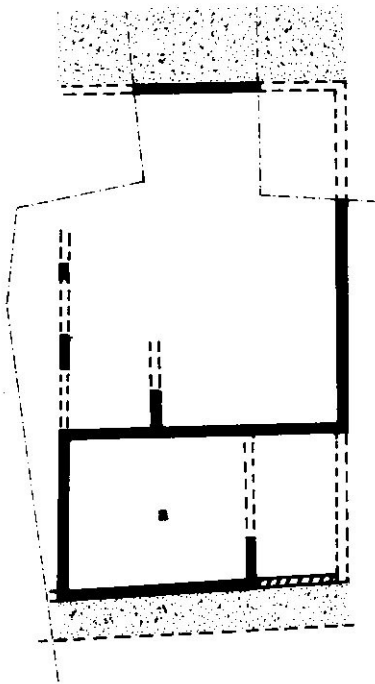

a) Bauphase 1 (AI.1)

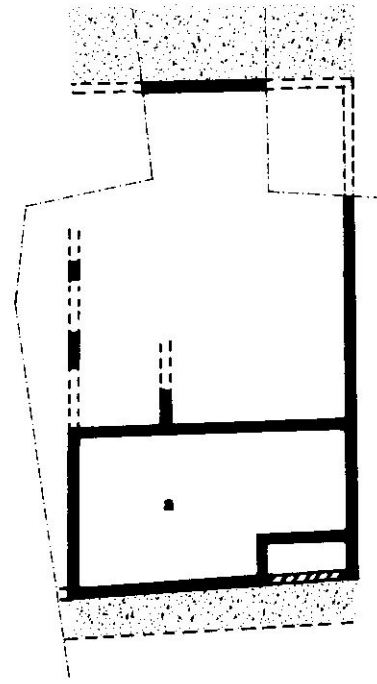

b) Bauphase 2 (AI.2)

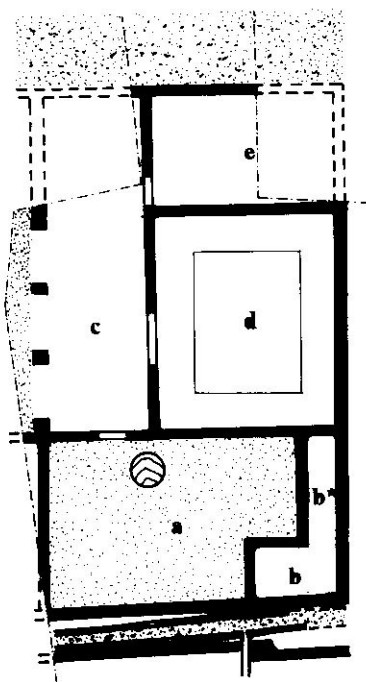

c) Bauphase 3 (AI.3)

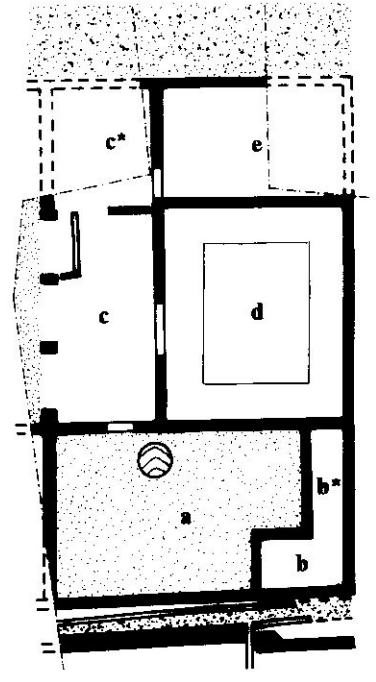

d) Bauphase 4 (AI.4)

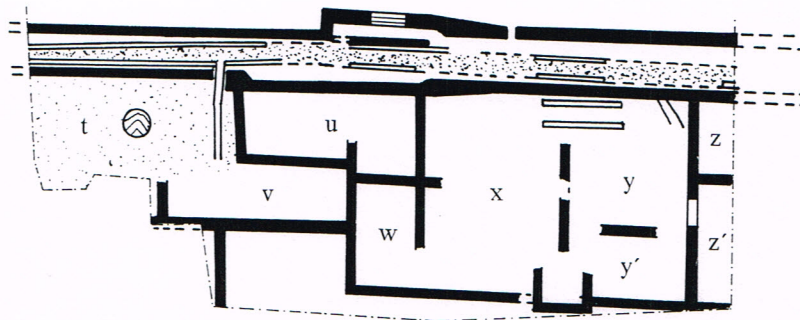

Grundstück A
Haus IV und V
M 1: 200

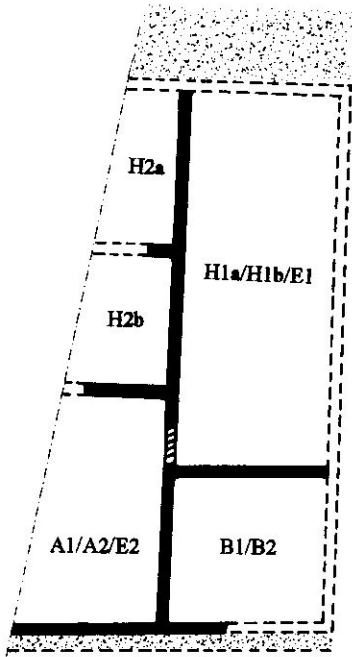

a) Bauphase 1 (BI.1)

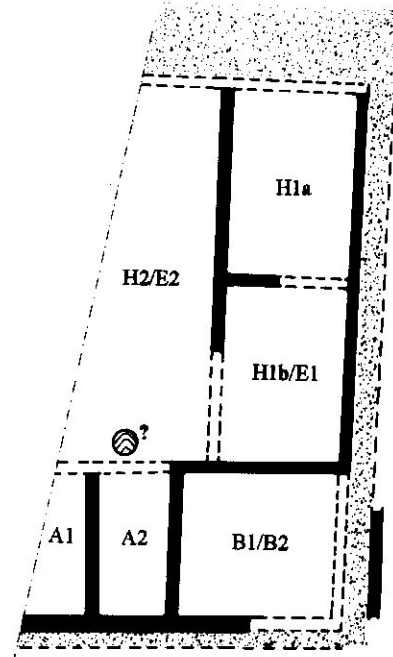

b) Bauphase 2 (BI.2)

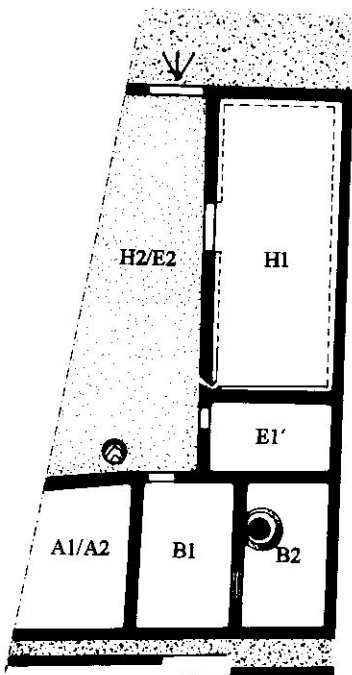

c) Bauphase 3 (BI.3)

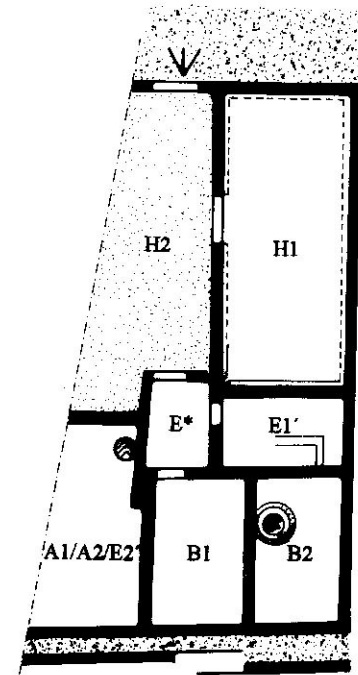

d) Bauphase 4 (BI.4)

Grundstück B
Haus I
Bauphasen 1 bis 4
M 1:200

a) Bauphase 1 (BII.1)

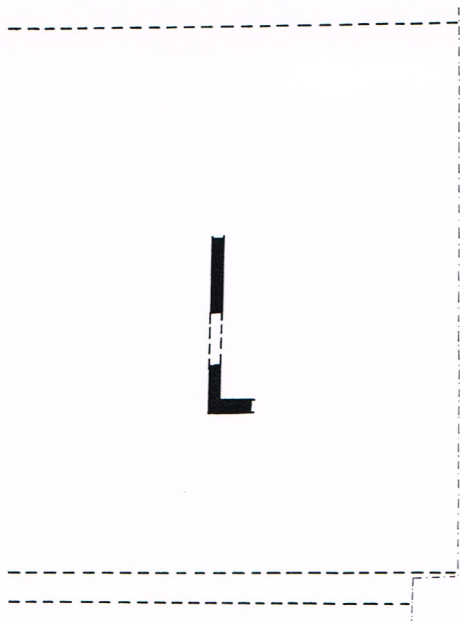

b) Bauphase 2 (BII.2)

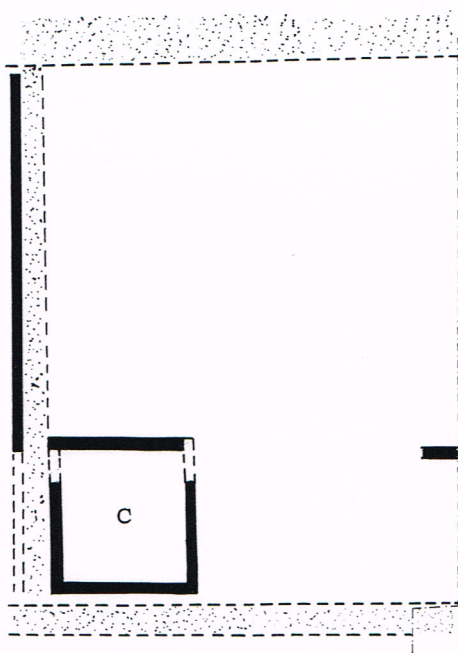

c) Bauphase 3 (BII.3)

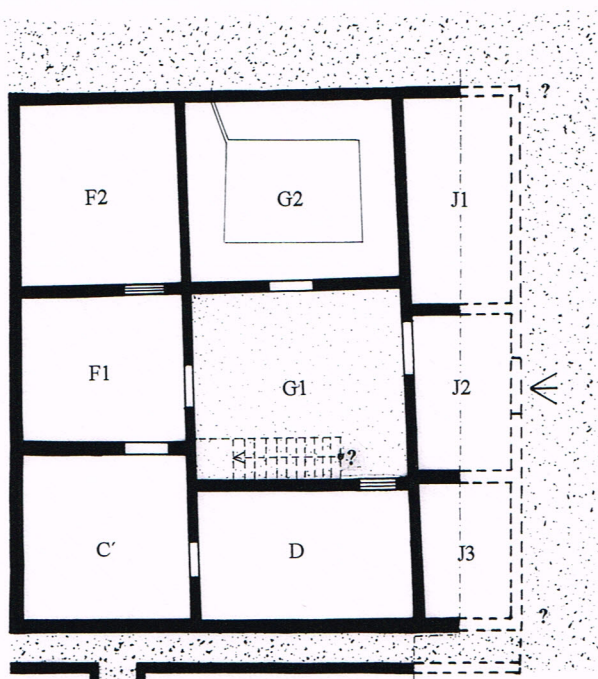

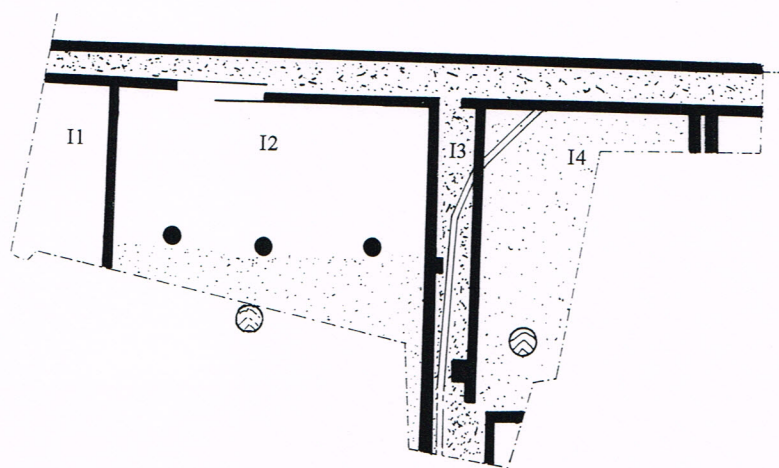

Grundstück B
Gebäude III und IV
M 1: 200

Grundstück A

Grabungspläne und Profilzeichnungen

Tafel 14 bis 17

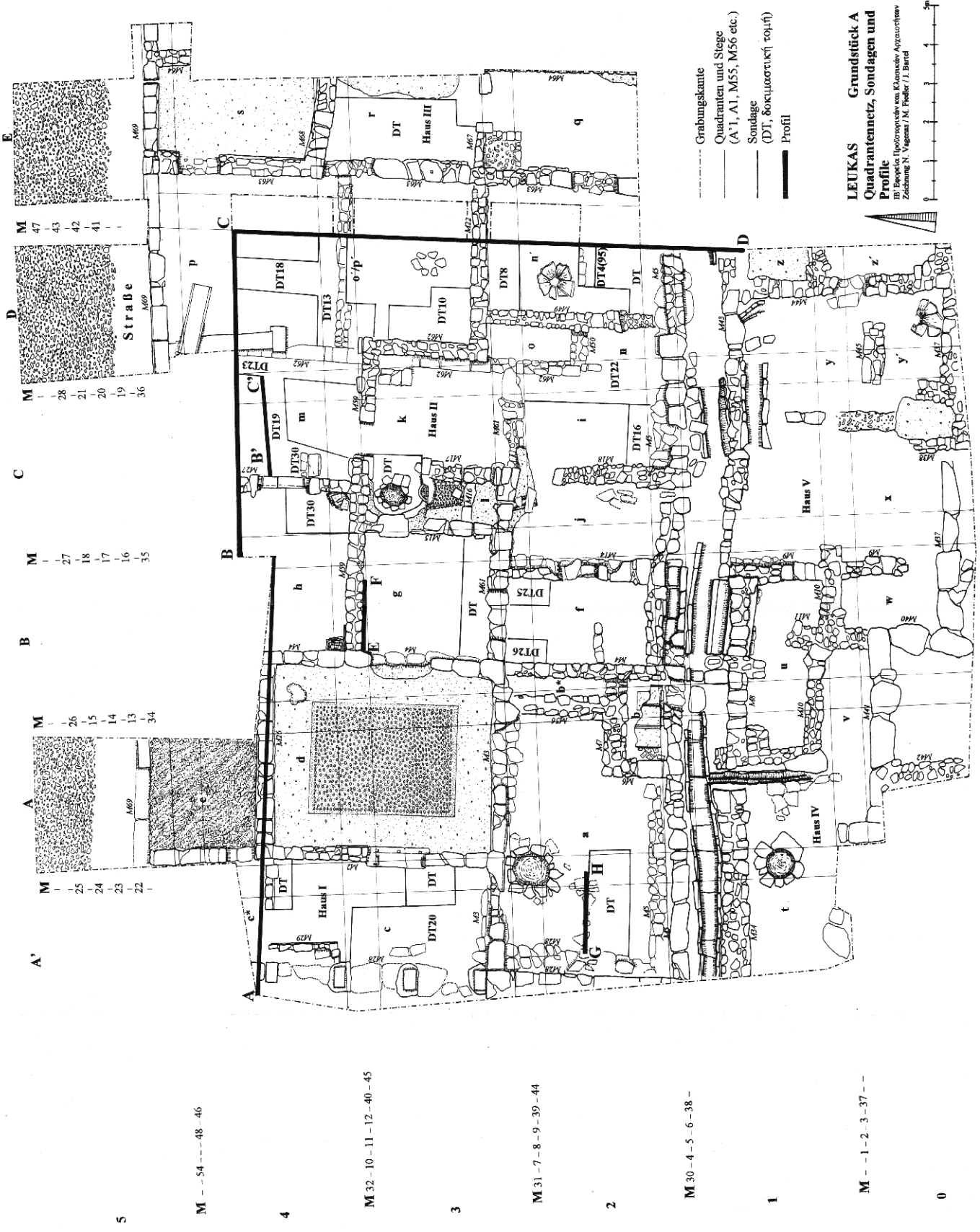

LEUKAS Grundstück A
Quadrantenetz, Sondagen und Profile
 (A', A1, M55, M56 etc.)
 DT: δοκιμαστικὴ τοίχη
 Profil

| | | | | | |
|----|---|----|----|----|----|
| A' | M | 25 | 24 | 23 | 22 |
| B | M | 27 | 18 | 17 | 16 |
| C | M | 28 | 21 | 20 | 19 |
| D | M | 47 | 43 | 42 | 41 |
| E | M | 36 | | | |

5

M - 54 - - - 48 - 46

4

M 32 - 10 - 11 - 12 - 40 - 45

3

M 31 - 7 - 8 - 9 - 39 - 44

2

M 30 - 4 - 5 - 6 - 38 -

1

M - 1 - 2 - 3 - 37 - -

0



LEUKAS
Grundstück A Steinplan
1:100
Requisitor Photographisch von K. Lorenz
Zeichnung N. Vögeler / M. Triller / J. Barbel

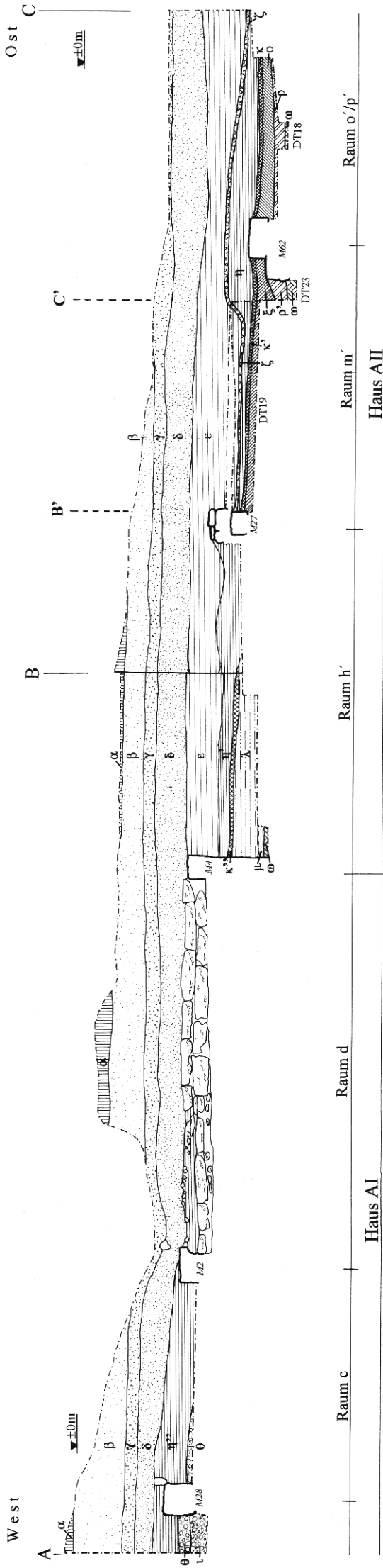

Nord - Profil

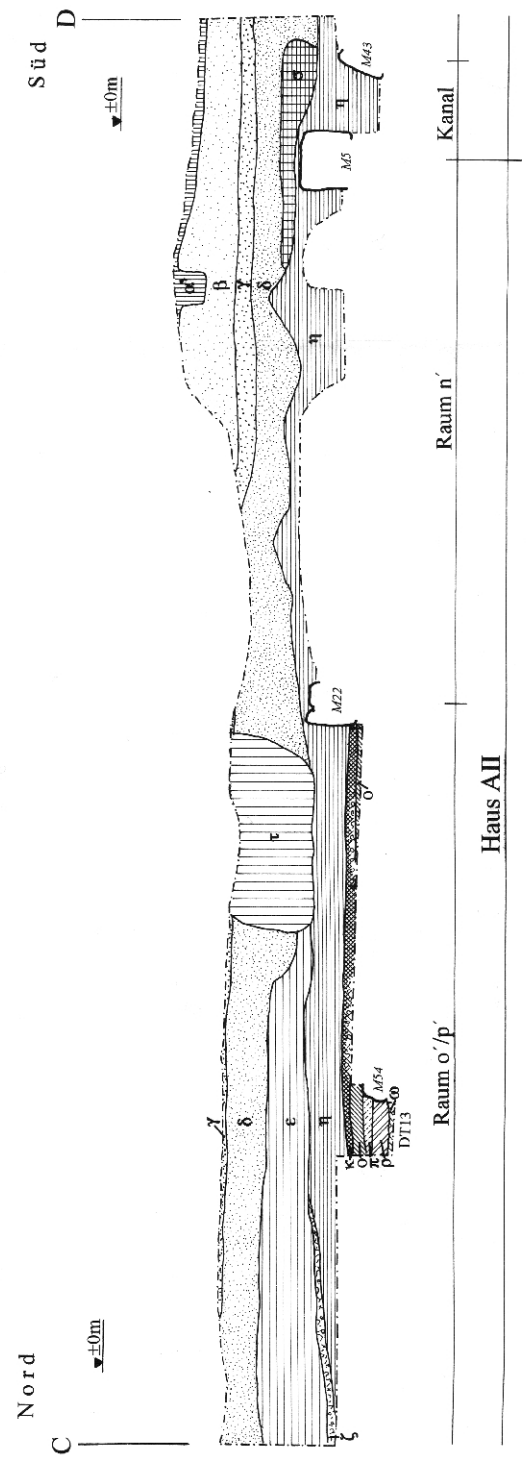

Ost - Profil



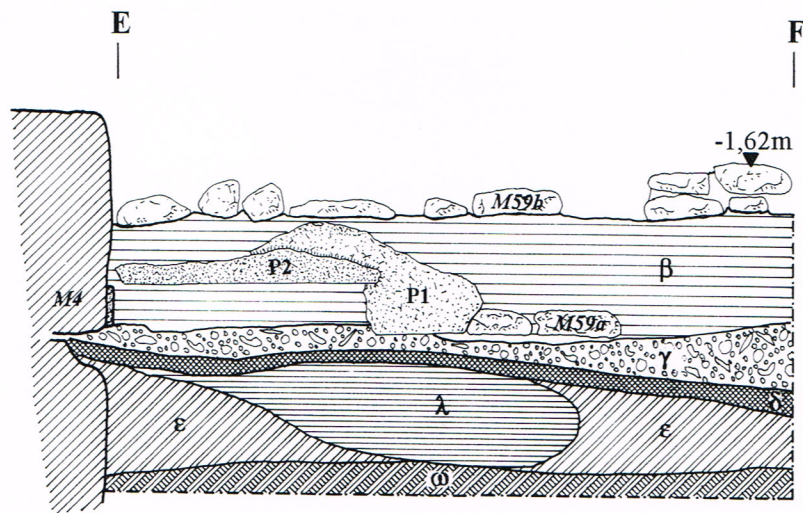

a) LEUKAS
 Grundstück A Profil M 1:20
 Haus II, Profil E - F
 IB* Εφορεία Προϊστορικών και Κλασικών Αρχαιοτήτων
 Zeichnung M. Fiedler / J. Bartel

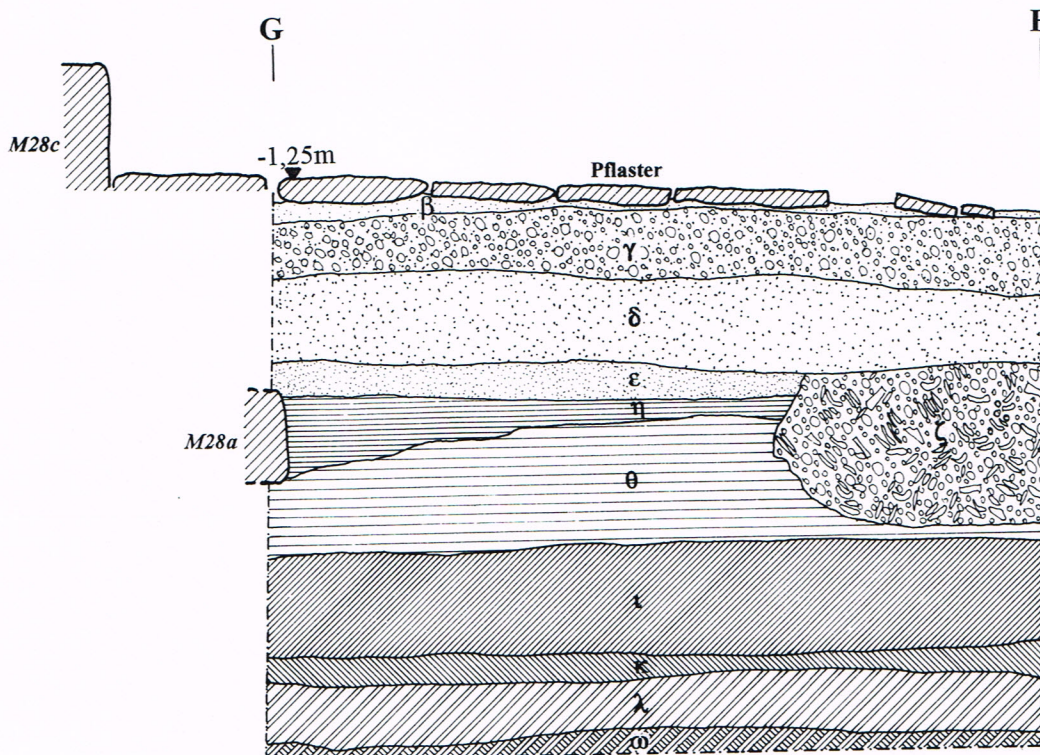

b) LEUKAS
 Grundstück A Profil M 1:20
 Haus I, Sondage in a, Profil G - H
 IB* Εφορεία Προϊστορικών και Κλασικών Αρχαιοτήτων
 Zeichnung M. Fiedler / J. Bartel

Grundstück A

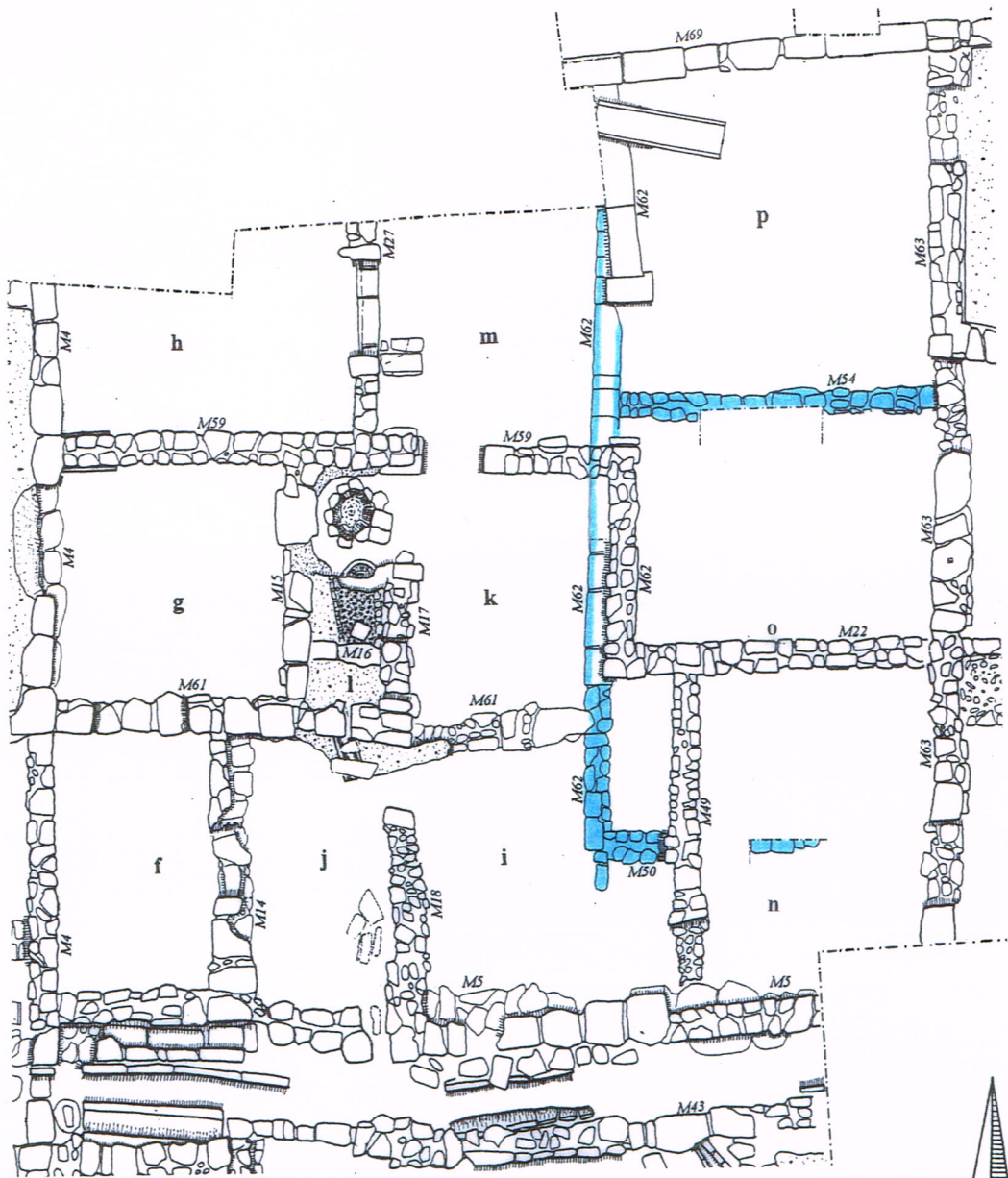

Steinpläne und Fotografien

Tafel 18 bis 39

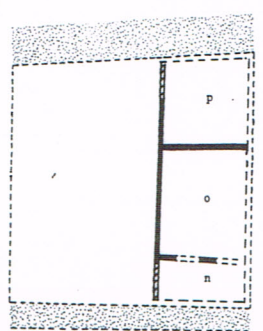

M 1:100 



 zur Phase gehörige Mauern
 zur Phase gehörige Mauern,
 von jüngeren Mauern überbaut

Grundstück A
Haus II Bauphase 1 (AII.1)

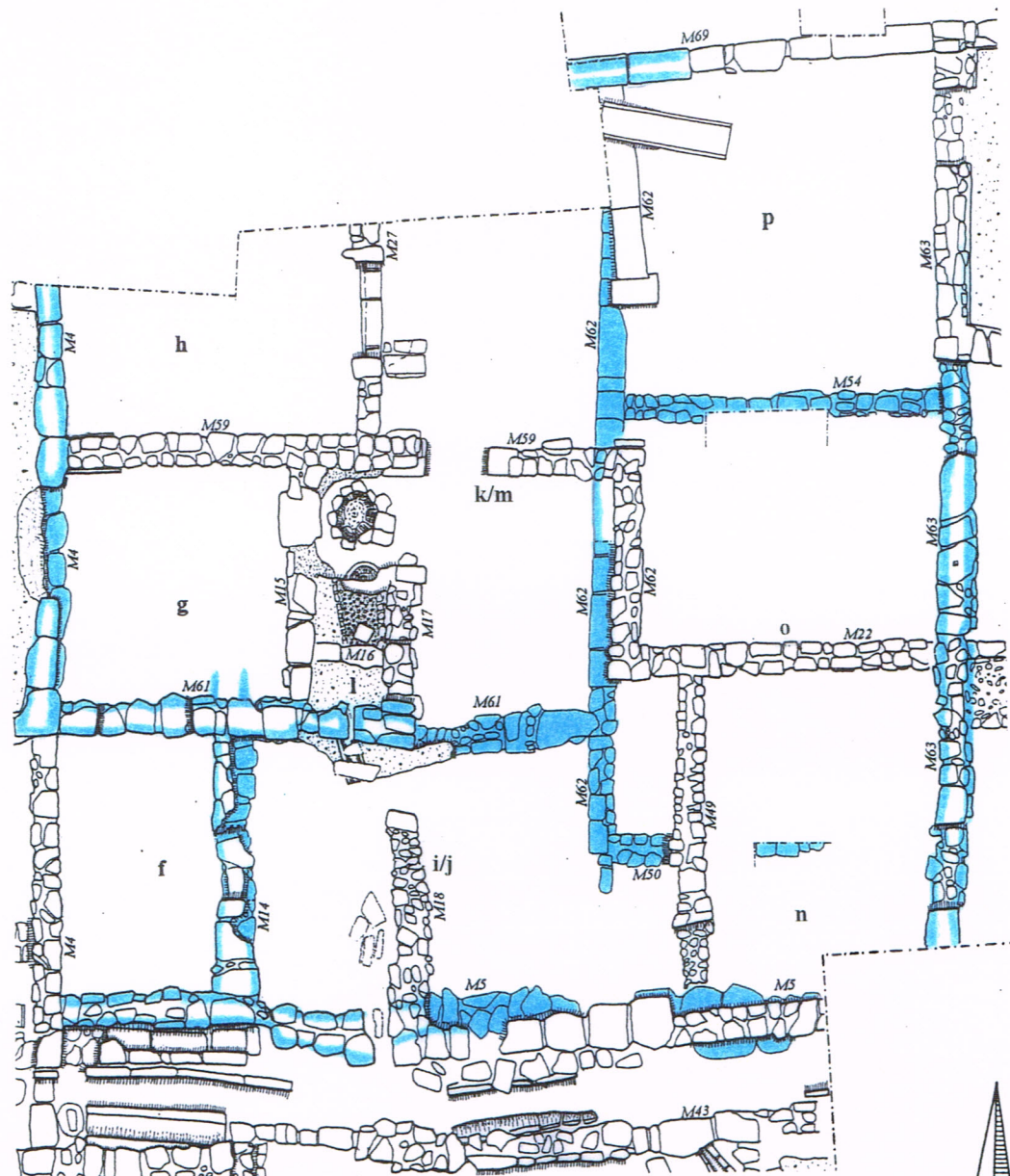

M 1:100

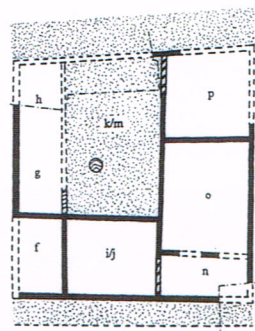

Grundstück A
Haus II Bauphase 2 (AII.2)

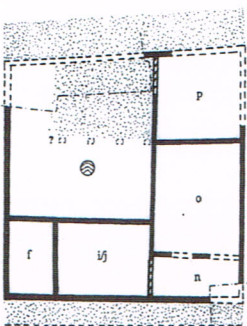
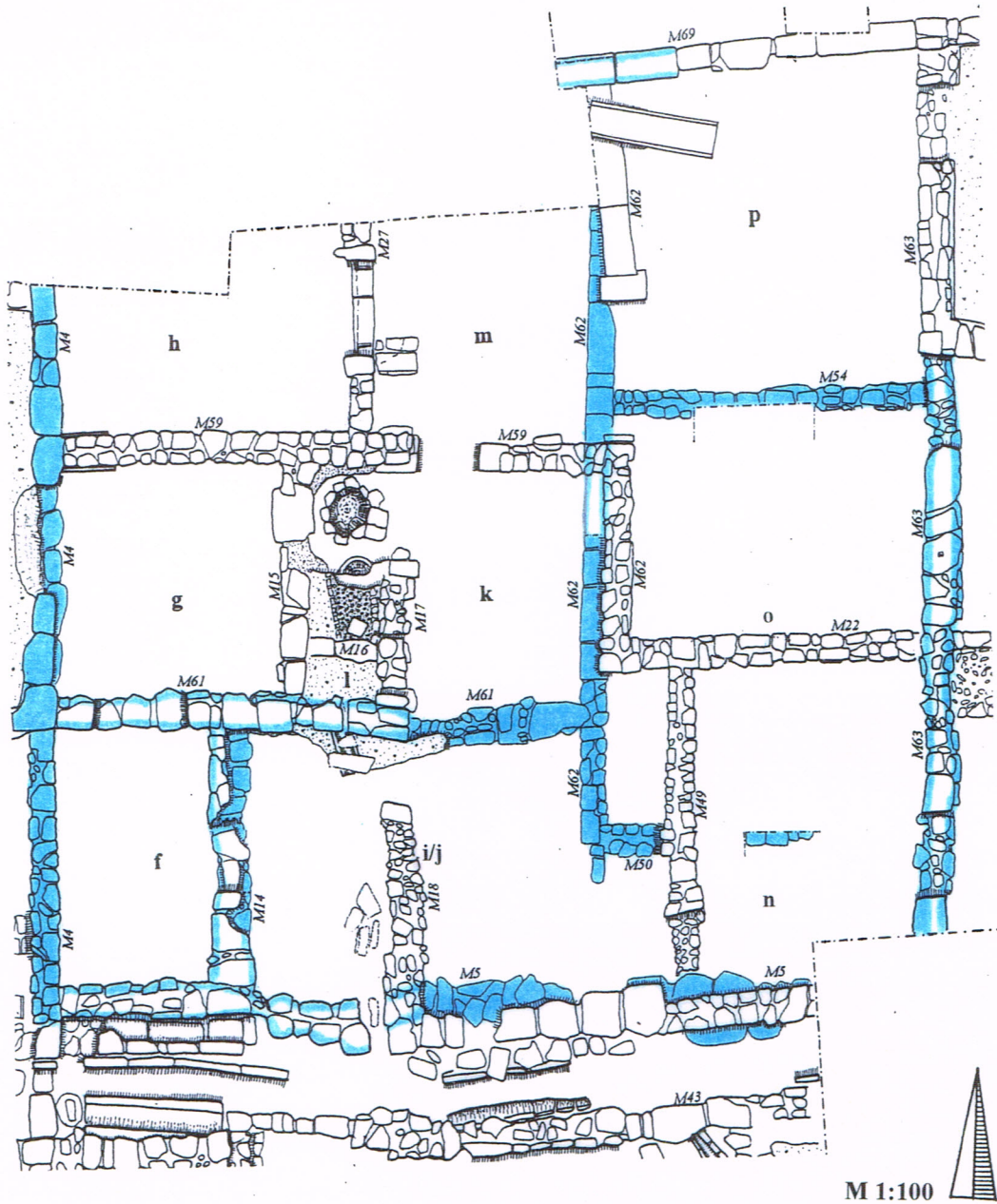

Grundstück A
Haus II Bauphase 3 (AII.3)

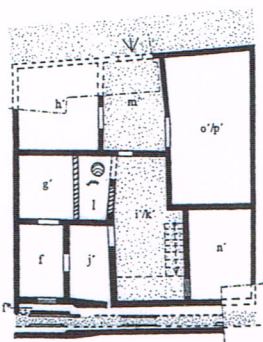
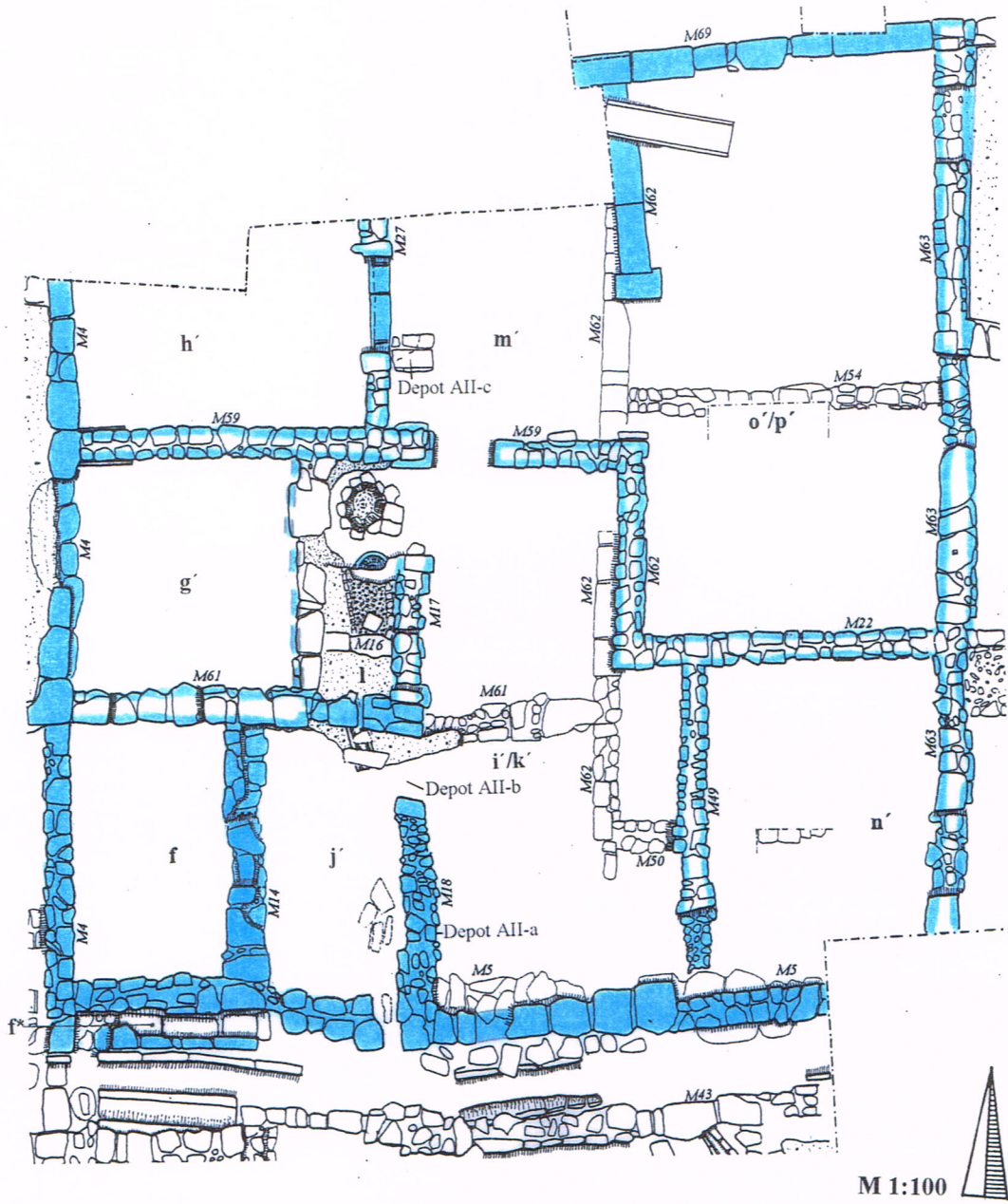

Grundstück A
Haus II Bauphase 4 (AII.4)

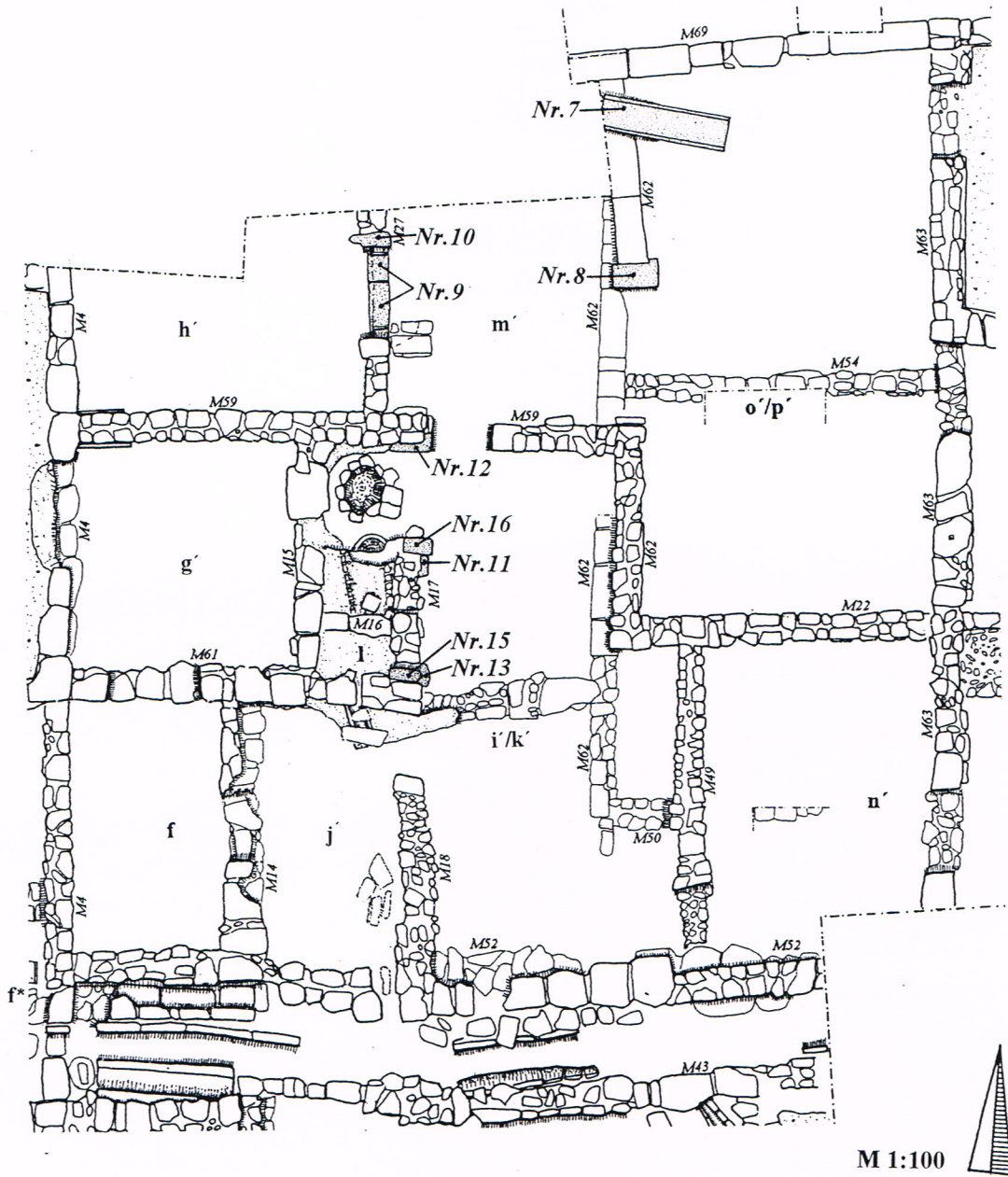

Grundstück A
Haus II Bauphase 4 und 5 (AII.4/5)
Spolien

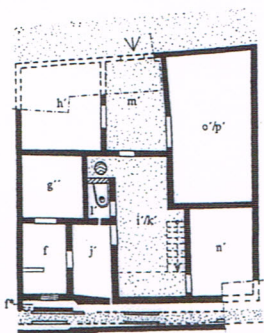
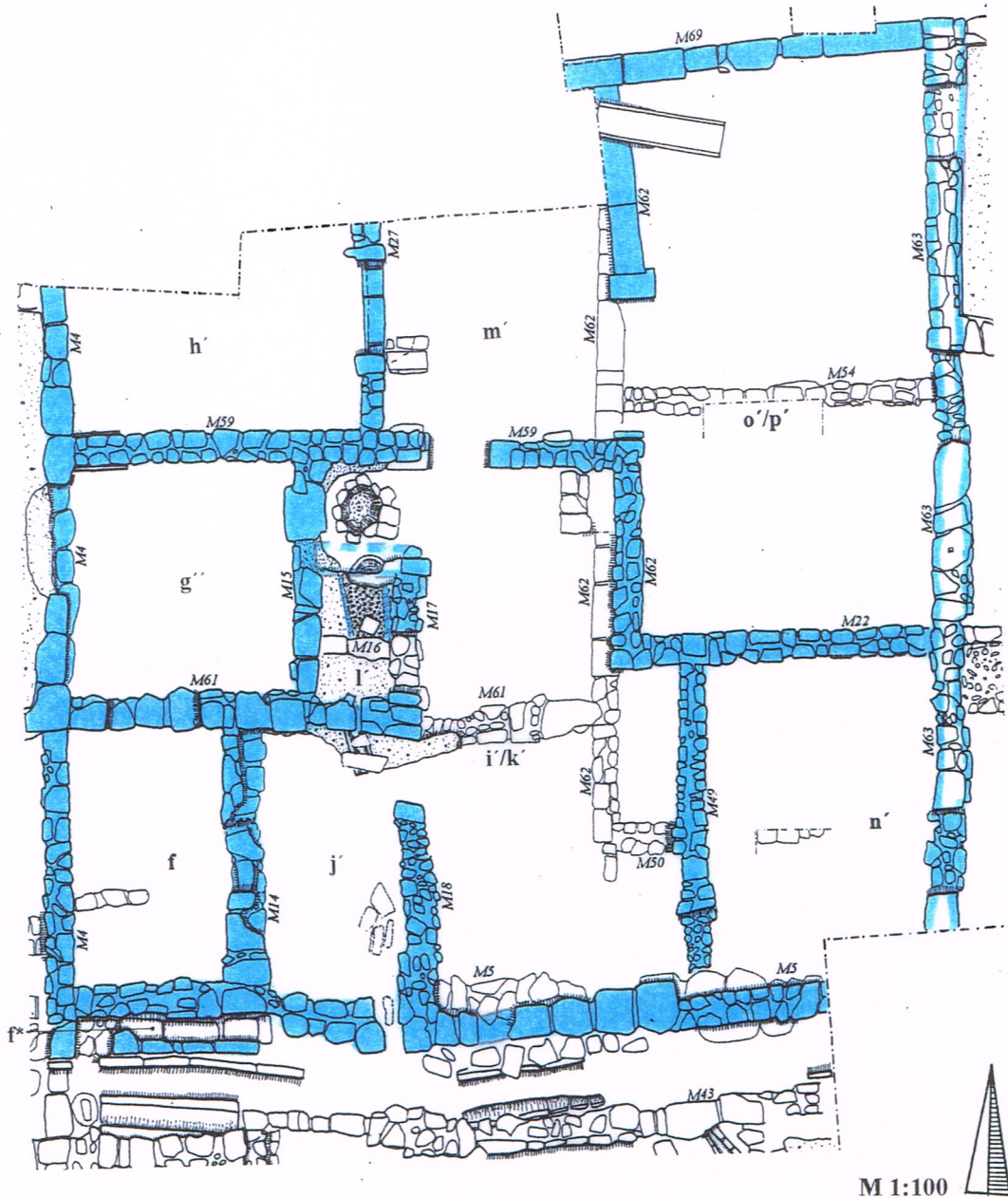

Grundstück A
Haus II Bauphase 5 (AII.5)

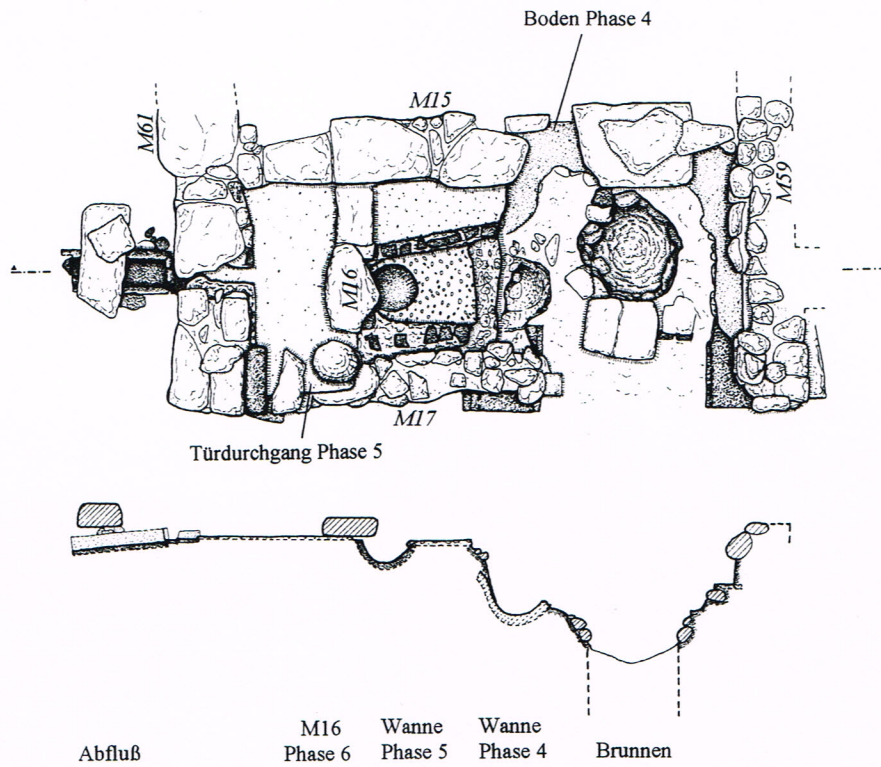

Abfluß

M16
Phase 6

Wanne
Phase 5

Wanne
Phase 4

Brunnen



LEUKAS Grundstück A
Haus II Badezimmer I
Bauphasen 4 bis 6
M 1:50

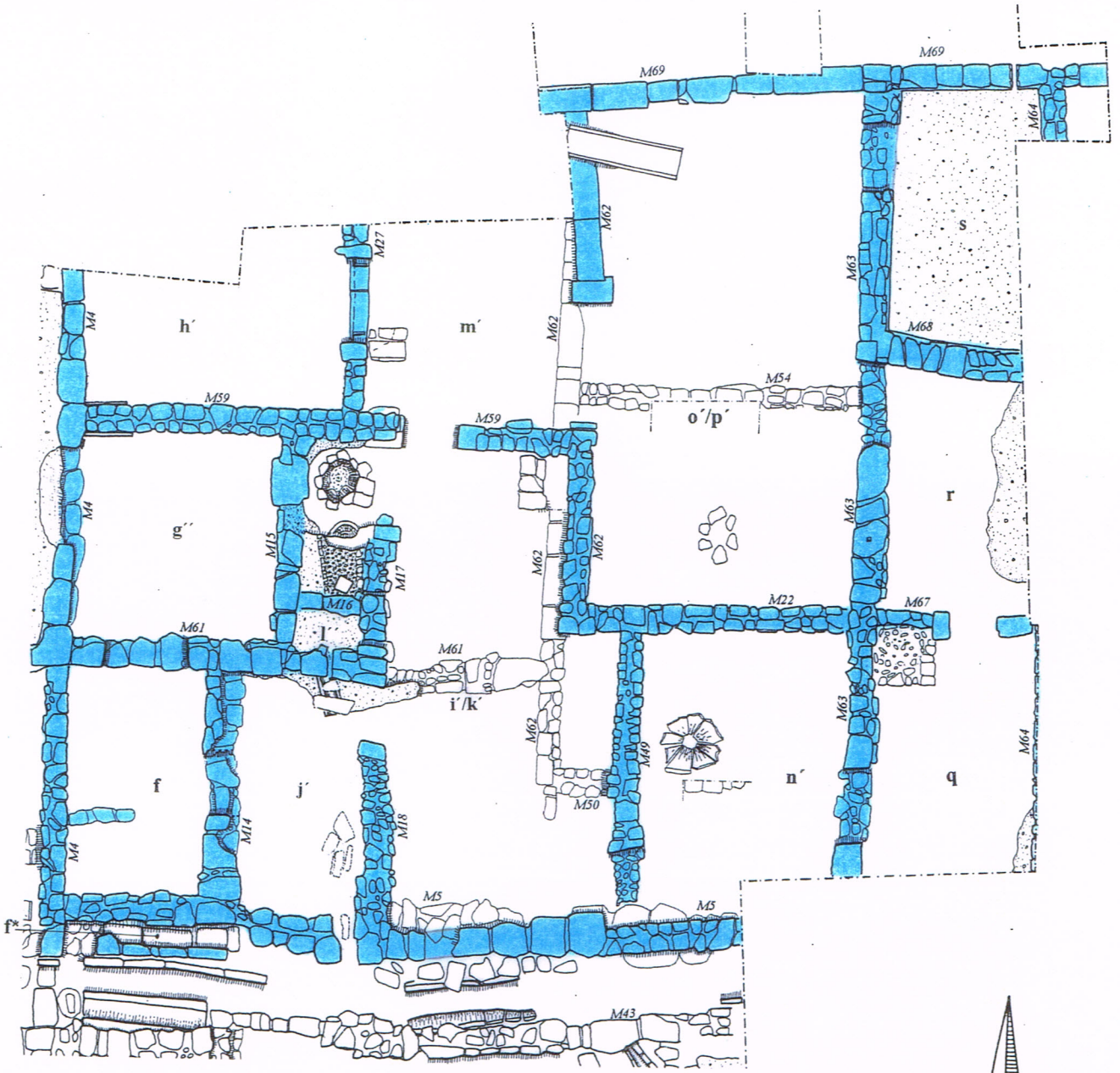

M 1:100 

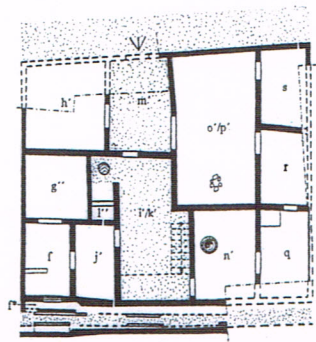

Grundstück A
Haus II Bauphase 6 (AII.6)

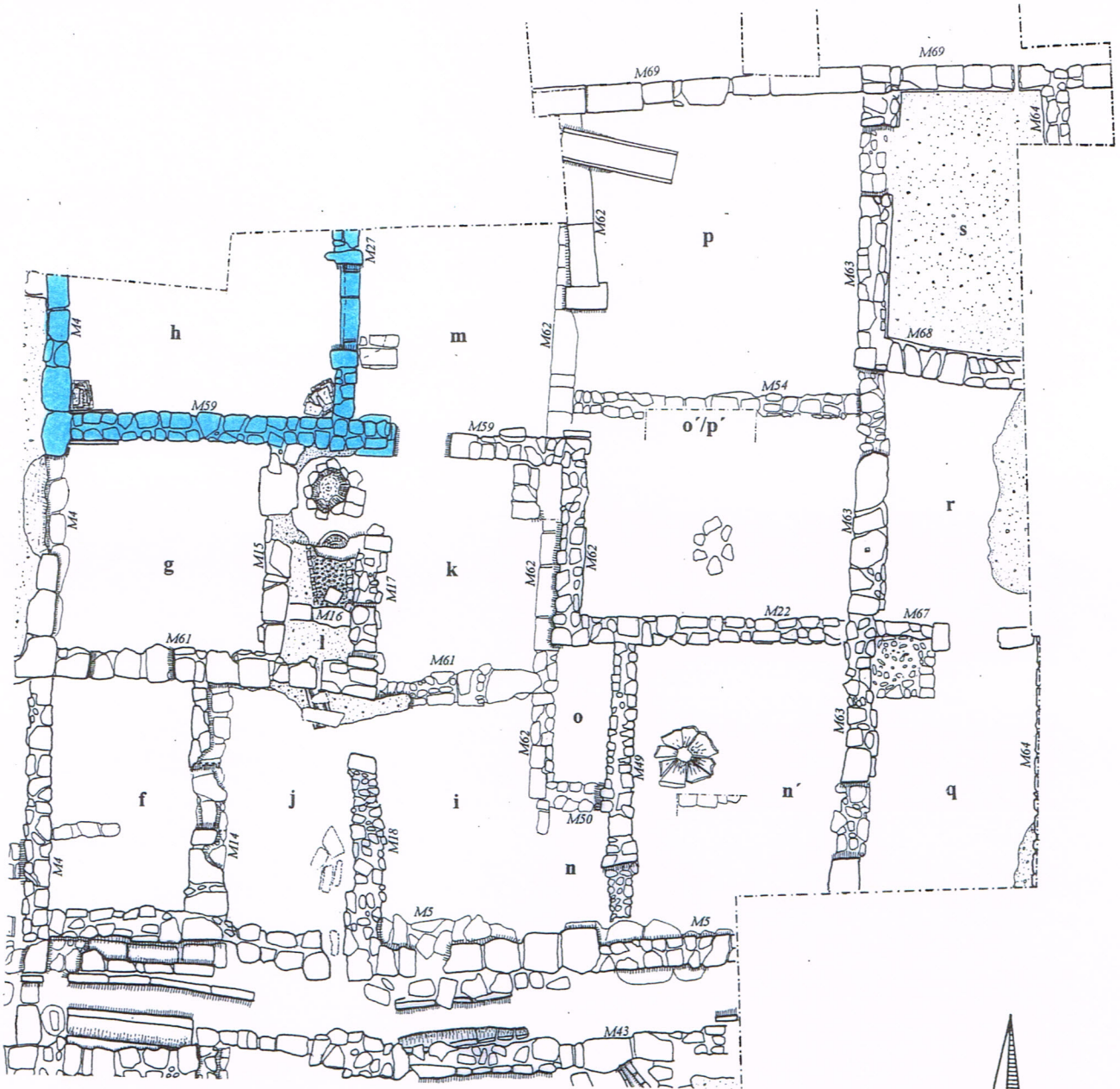

M 1:100

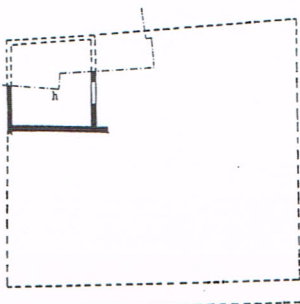

Grundstück A
Haus II Bauphase 7 (AII.7)

Tafel 27
(entfällt)



a) Haus AII.1-3: M54 (von Norden)



b) Haus AII.1-3: M54, M62a (von Nordosten)



c) Haus AII.1-3: M54, M62a (von Nordwesten)

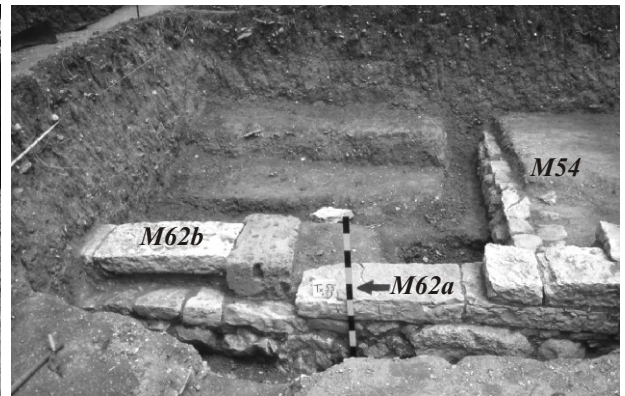

d) Haus AII.1-3: M54, M62a (von Westen)

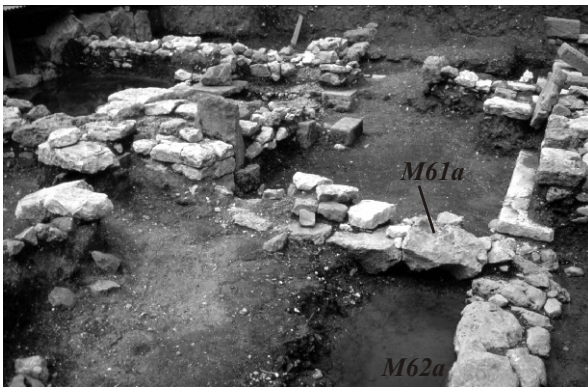

e) Haus AII.1-3: M61a, M62a (von Süden)

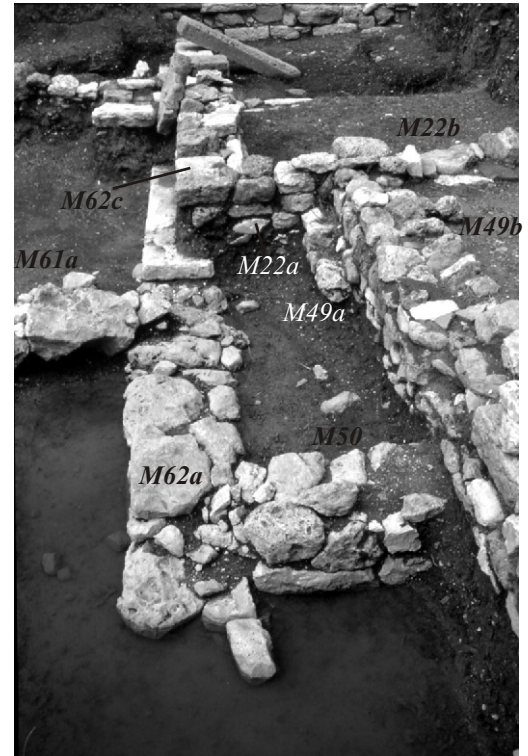

f) Haus AII.1-6: M22a, M22b, M49a, M49b, M50, M61a, M62a, M62c (von Süden)



g) Haus AII.2-6: M69a, M69b (von Norden)



a) Haus AII.2-6: M4, M14a, M14b, M61a, M61b, M61c (von Süden)

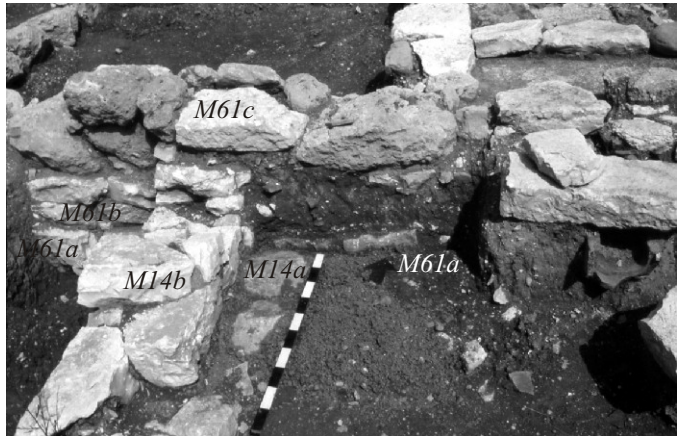

b) Haus AII.2-6: M14a, M14b, M61a, M61b, M61c (von Süden)



c) Haus AII.2-6: M4, M14a, M14b (von Süden)

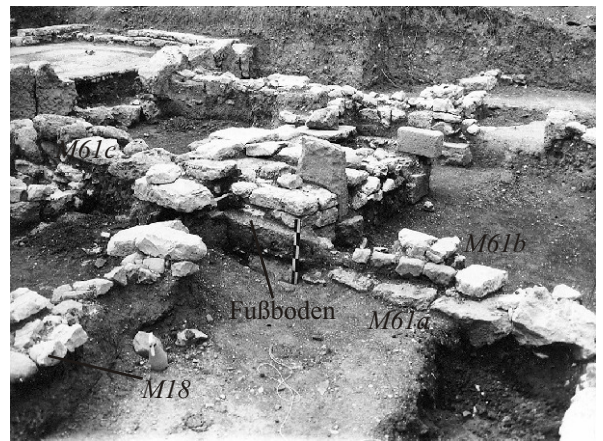

d) Haus AII.2-6: M61a, M61b, M18, Mörtelboden in i/j (von Südwesten)



e) in Haus AII.4&5 verbaute Spolien (von Osten)



f) Haus AII.1-6 von Norden

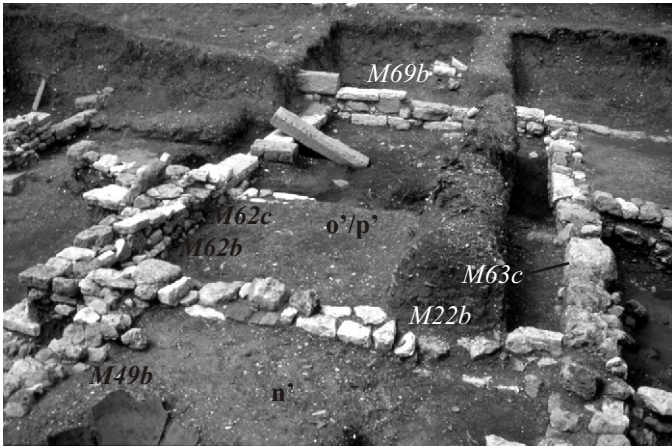

a) Haus AII.4-6: Raum n' und o'/p', M22b, M49b, M63c, M69b (von Süden)



b) Haus AII.4-6: M69b (von Norden)

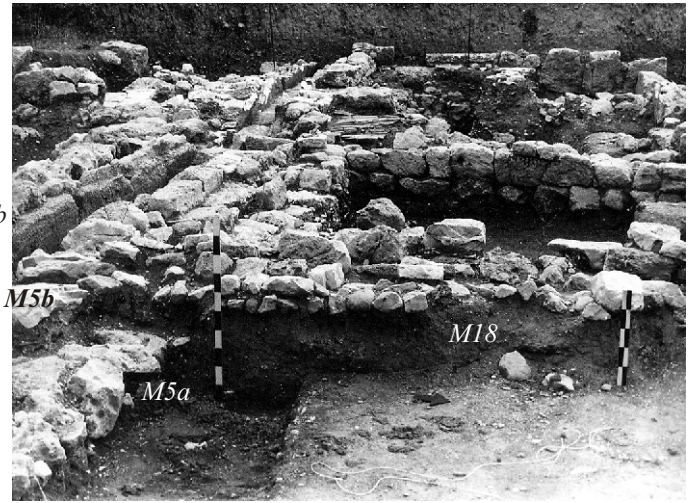

d) Haus AII.4-6: M5a, M5b, M18 (von Osten)

c) Haus AII.4: Bauopfer-Depot AII-a, Ziegelplatte unter M18 (von Osten)

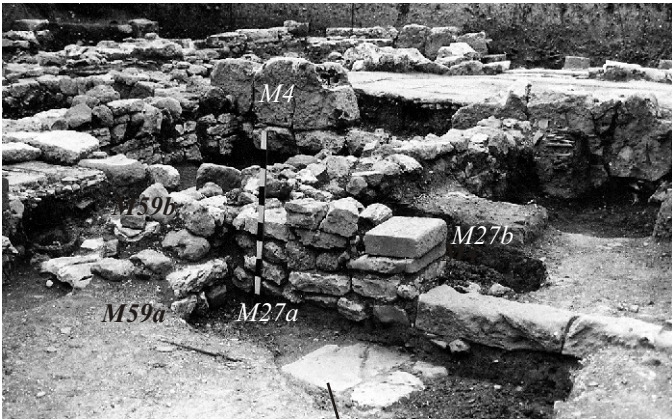

e) AII.4-6: M4, M27, M59, Steinplatte des Depot AII-b (von Nordosten)



f) AII.5-6: Raum g'/g'', Putzschichten P1/P2 (vgl. Taf. 17a)



g) Haus AII.4-6: Mittelkanal, M5b (von Osten)



h) Haus AII.4
Badewanne



i) Haus AII.4-6
Rinne (Latrine?)



a) Haus AII.4-6: Badezimmer I (I') mit Badewannen (von Norden)



b) Haus AII.4-6: Badezimmer I (I') mit Badewannen (von Nordosten)

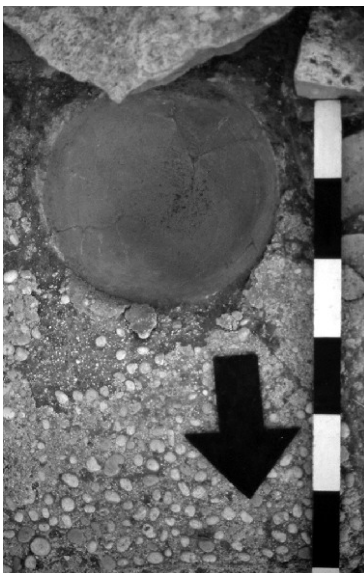

d) Haus AII.5: Badewanne in Bad I', Schöpfmulde und Wannensboden



c) Haus AII.4-6: Badezimmer I (I') mit Badewannen und Brunnen

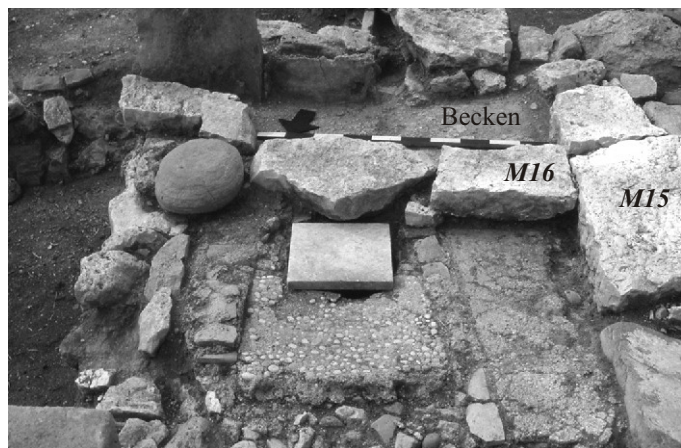

e) Haus AII.6: ehem. Bad I'' ('Waschküche') mit 'Becken' und Spuren der Badewanne von Phase 5



g) Haus AII.4-6: Abfluß mit zur Seite gelegten Abdecksteinen (von Süden)



f) Haus AII.4-6: Abfluß des Badezimmers (von Süden)



a) Haus AII.4-6: M22b, M49, M50 (von Westen)



b) Haus AII.4-6: Hof i'k', Raum n, M49 (v. Süden)



c) Haus AII.6: Herd in Küche q,
(von Nordosten)

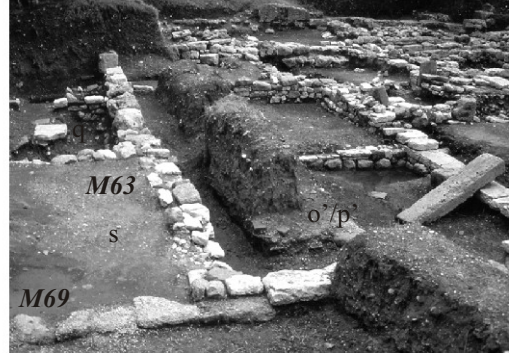

d) Haus AII.6: Raum s, q, o'p', M63, M69 (v. Norden)

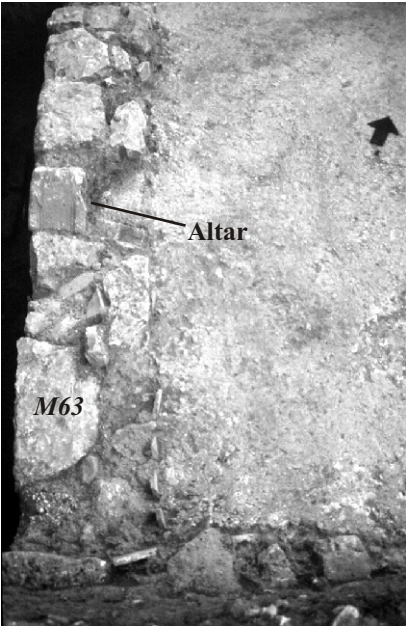

f) Haus AII.6: Raum s, Mörtelboden,
Altar Kat.-Nr. 1057 (in situ)



e) Haus AII.6: Raum q, M64 (von Westen)



g) Haus AII.6: Grube unter Raum r mit versenkter
Brunnenfassung (Kat.-Nr. 31)



h) Haus AII.6: Raum s, Abfluß



i) Haus AII.6:
Hof i'k', Bank?



j) Haus AII.4-7: Raum h', M27b, M59b, Dachziegelstapel



k) Haus AII.7: Raum h', Dachziegelstapel

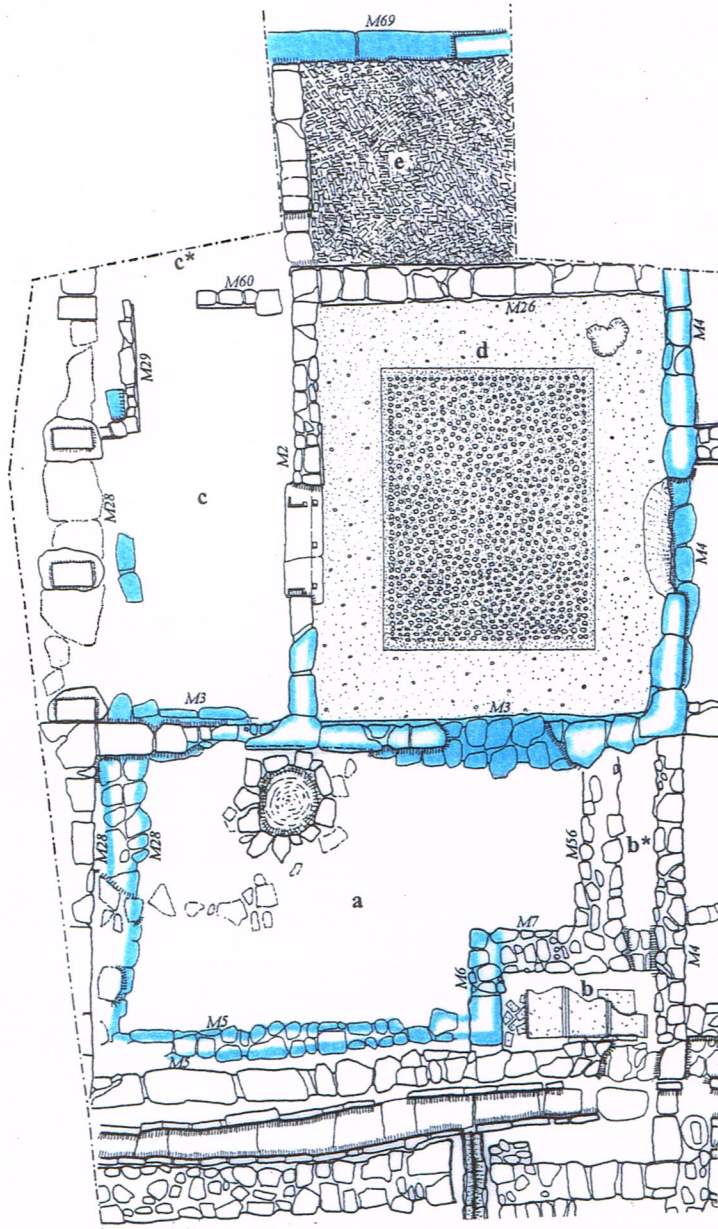

M 1:100

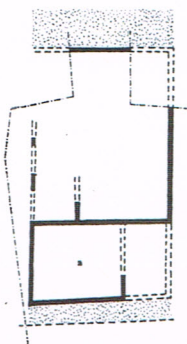

Grundstück A
Haus I Bauphase 1 (AI.1)

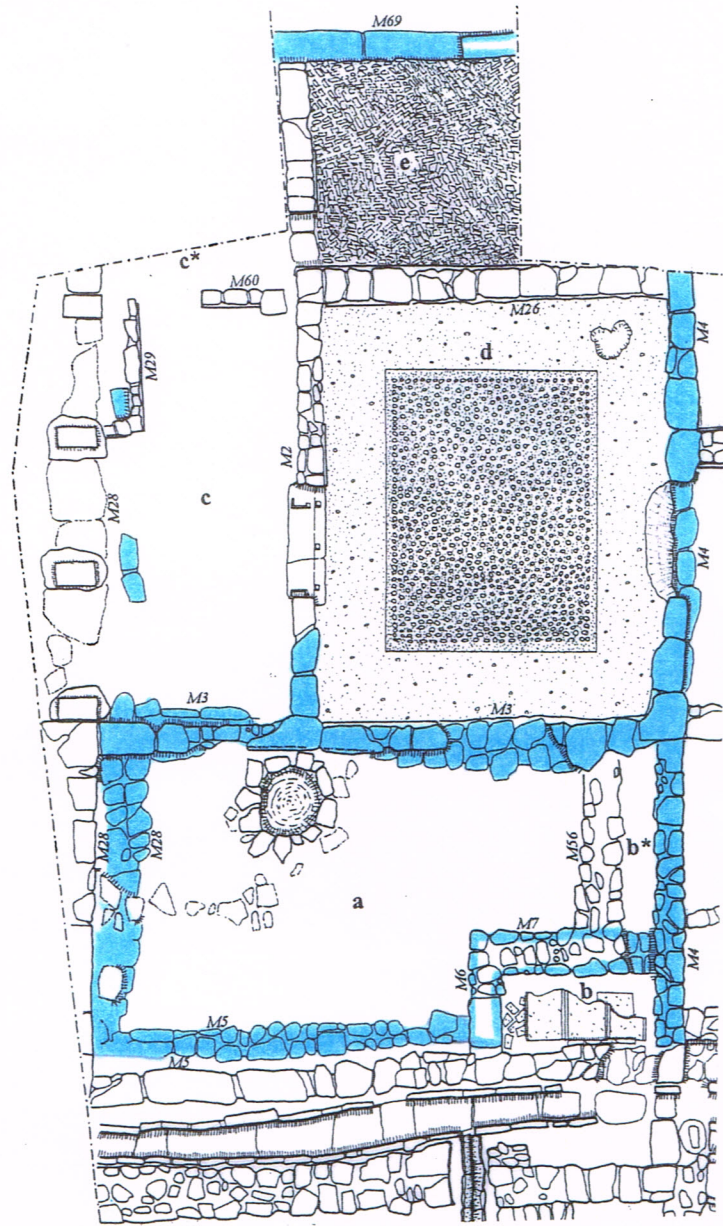

M 1:100

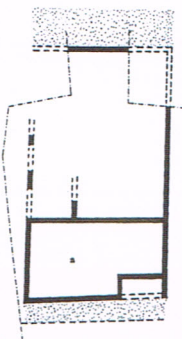

Grundstück A
Haus I Bauphase 2 (AI.2)

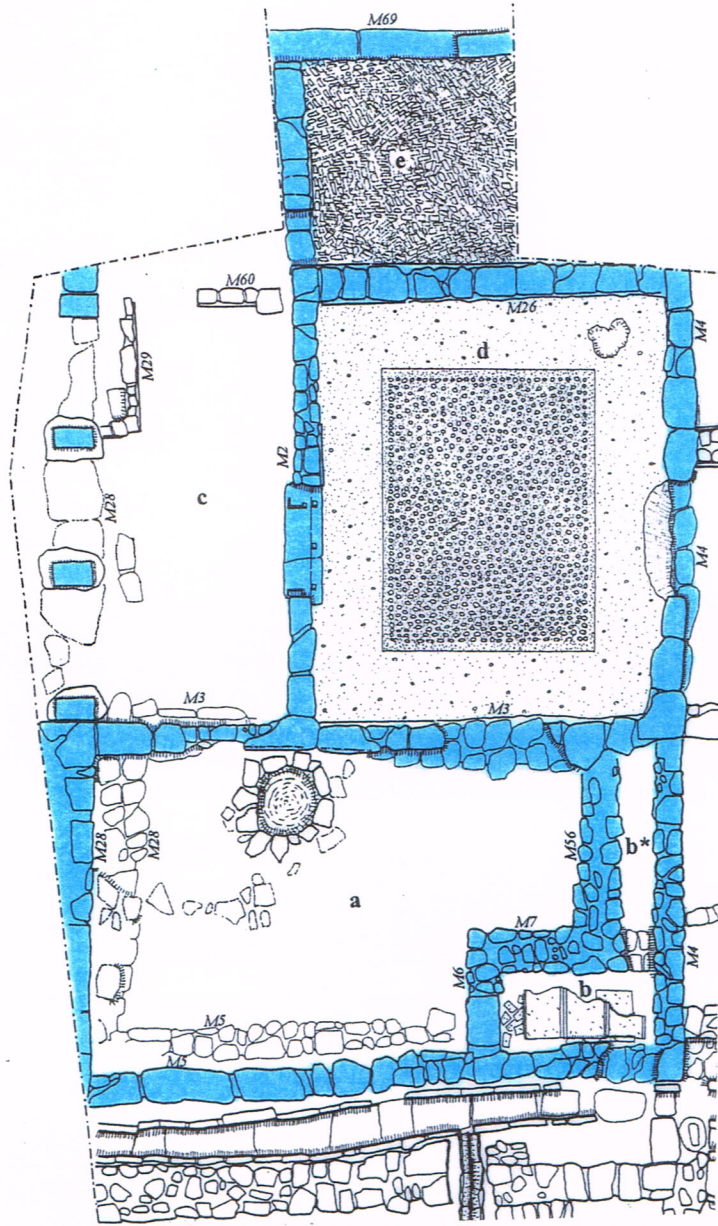

M 1:100

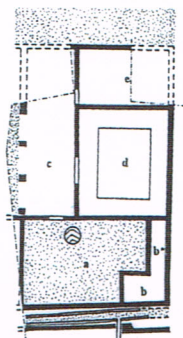

Grundstück A
Haus I Bauphase 3 (AI.3)

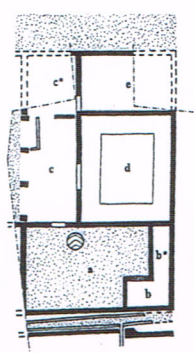
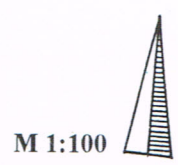
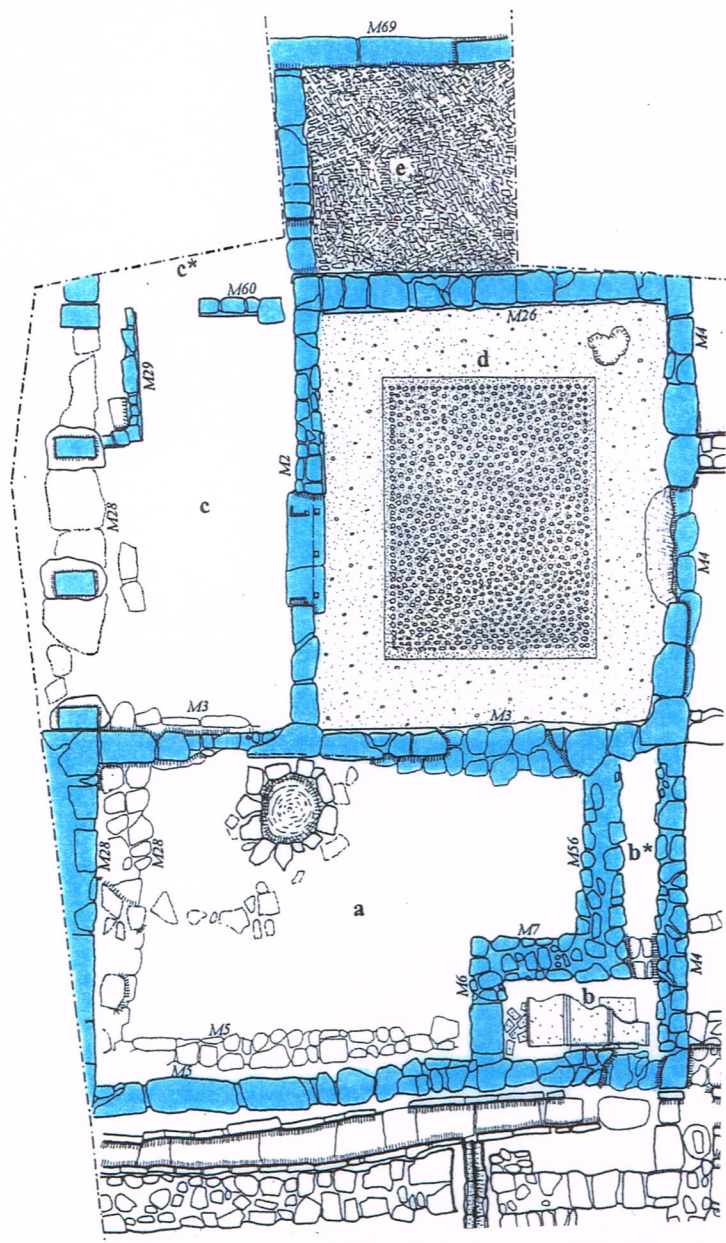

Grundstück A
Haus I Bauphase 4 (AI.4)

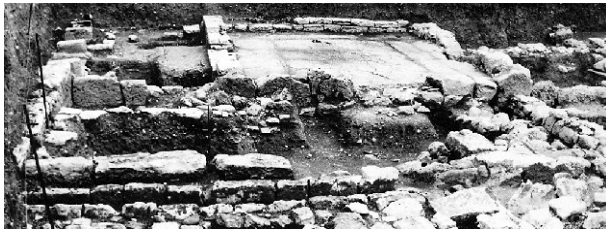

a) Haus AI.3-4 (von Süden)

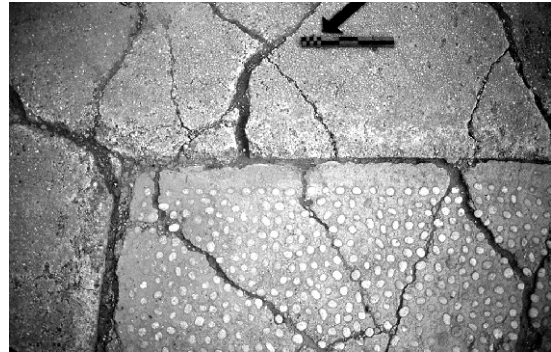

b) Haus AI.3-4: Fußboden des Bankettraums **d**



c) Haus AI.3-4: Bankettraum **d** (von Norden)



d) Haus AI.3-4: im Vordergrund Bankettraum **d**, im Hintergrund Halle **c** (von Westen)



e) Haus AI.3-4: Basen der Vorhalle **c**, in AI.4 durch *M29* zugesetzt (von Westen)



f) Haus AI.3-4: Raum **e** (von Nordosten)



g) Haus AI.3-4: Ziegelfußboden von Raum **e**



h) Haus AI.3-4: Hof **a** mit Steinpflaster (von Süden)



i) Haus AI.3-4: Hof **a**, Abarbeitung für Gefache (*M3*), Brunnen und Steinpflaster des Hofes (von Westen)



a) Haus AI.2-4: Raum **b** (von Nordwesten)



b) Haus AI.3-4: Raum **b** (von Nordwesten)



c) Haus AI.4: Raum **b**, Ziegelfußboden (von Norden)



d) Haus AIV: Hof **t** mit Hofpflaster und Brunnen (von Nordwesten)



e) Grundstück A: Mittelkanal (von Westen)



f) Grundstück A: Mittelkanal (von Osten)

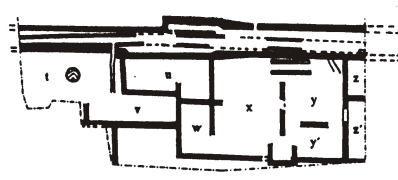
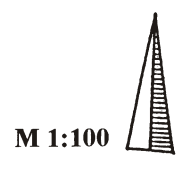
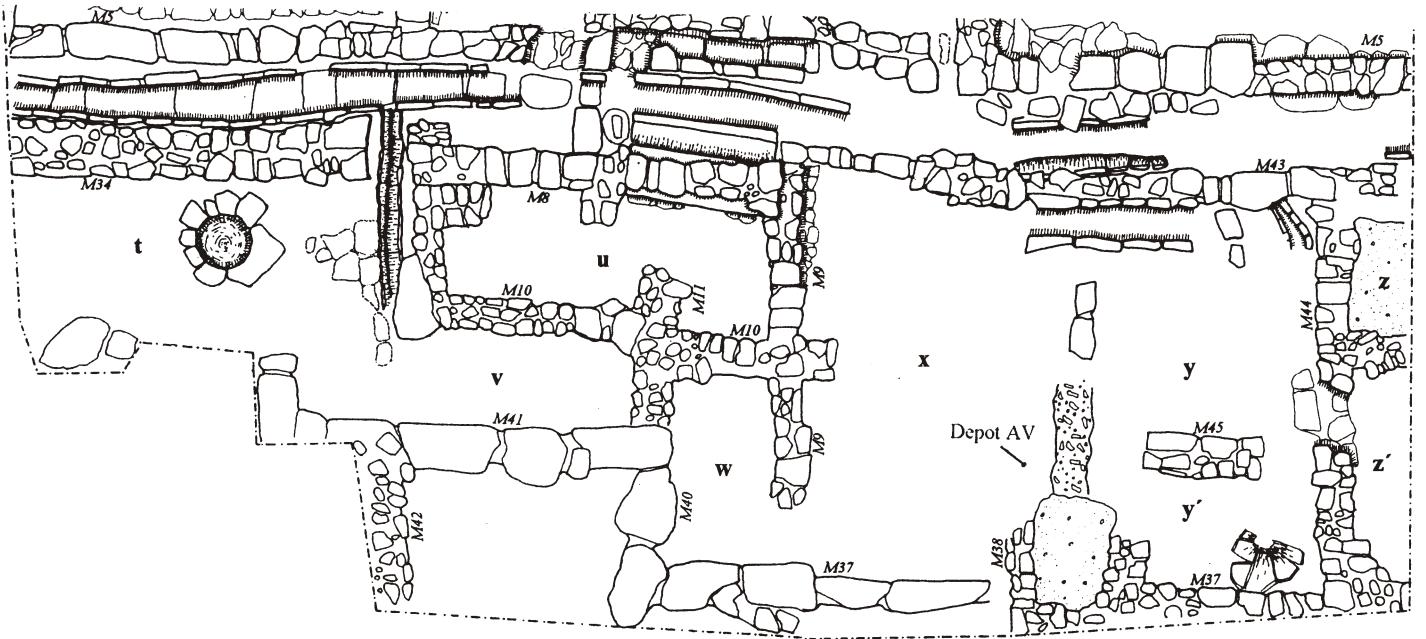

Grundstück A
Haus IV und V (AIV, AV)

Grundstück B

Grabungsplan

Tafel 40



LEUKAS
Grundstück B Steinplan
IB' Εφορεία Προϊστορικών και Κλασικών Αρχαιοτήτων
Zeichnung N. Vagenas / M. Fiedler / J. Bartel

Grundstück B

Steinpläne und Fotografien

Tafel 41 bis 53

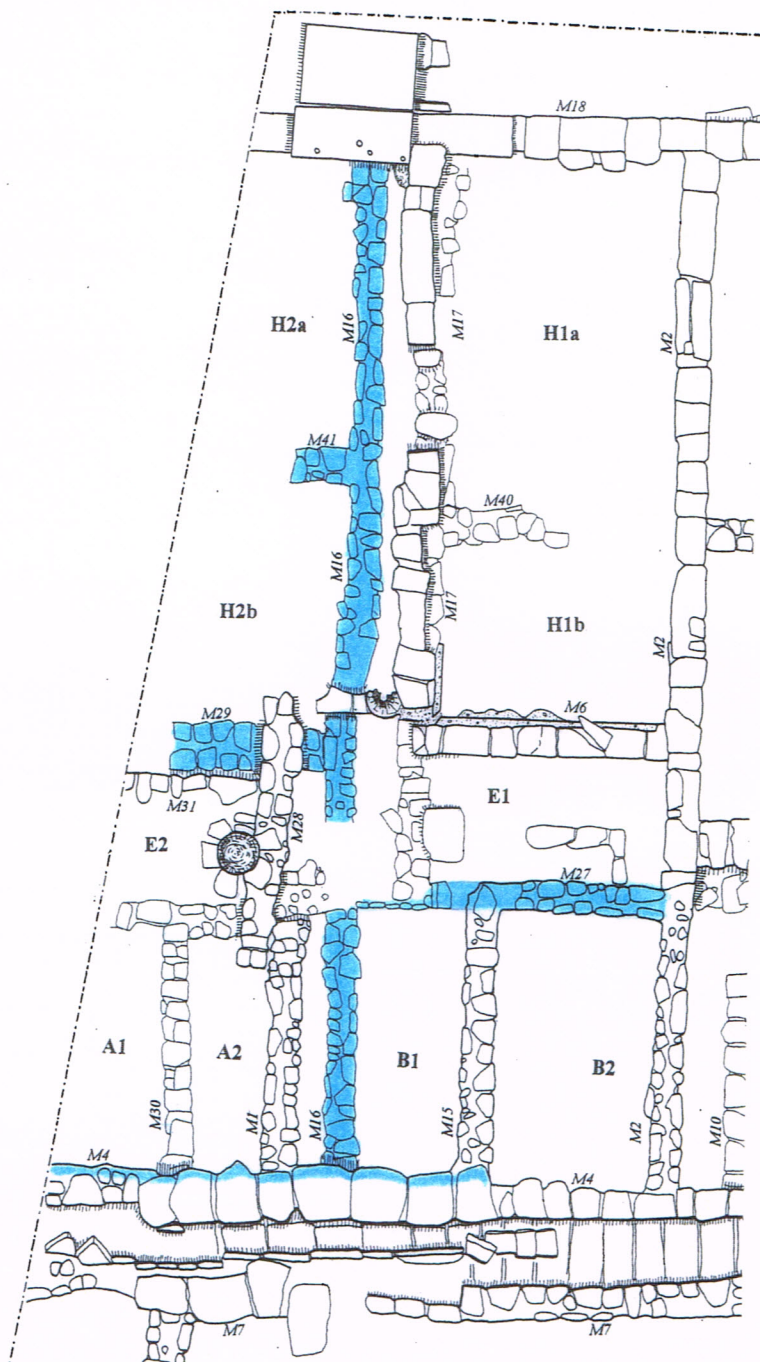

M 1:100

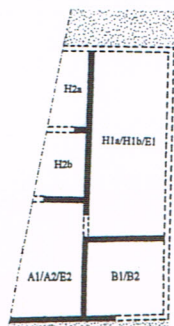

Grundstück B
Haus I Bauphase 1 (BI.1)

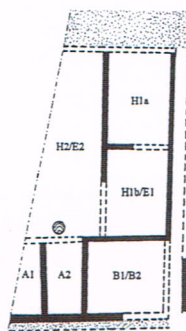
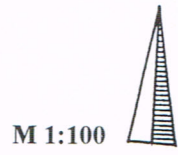
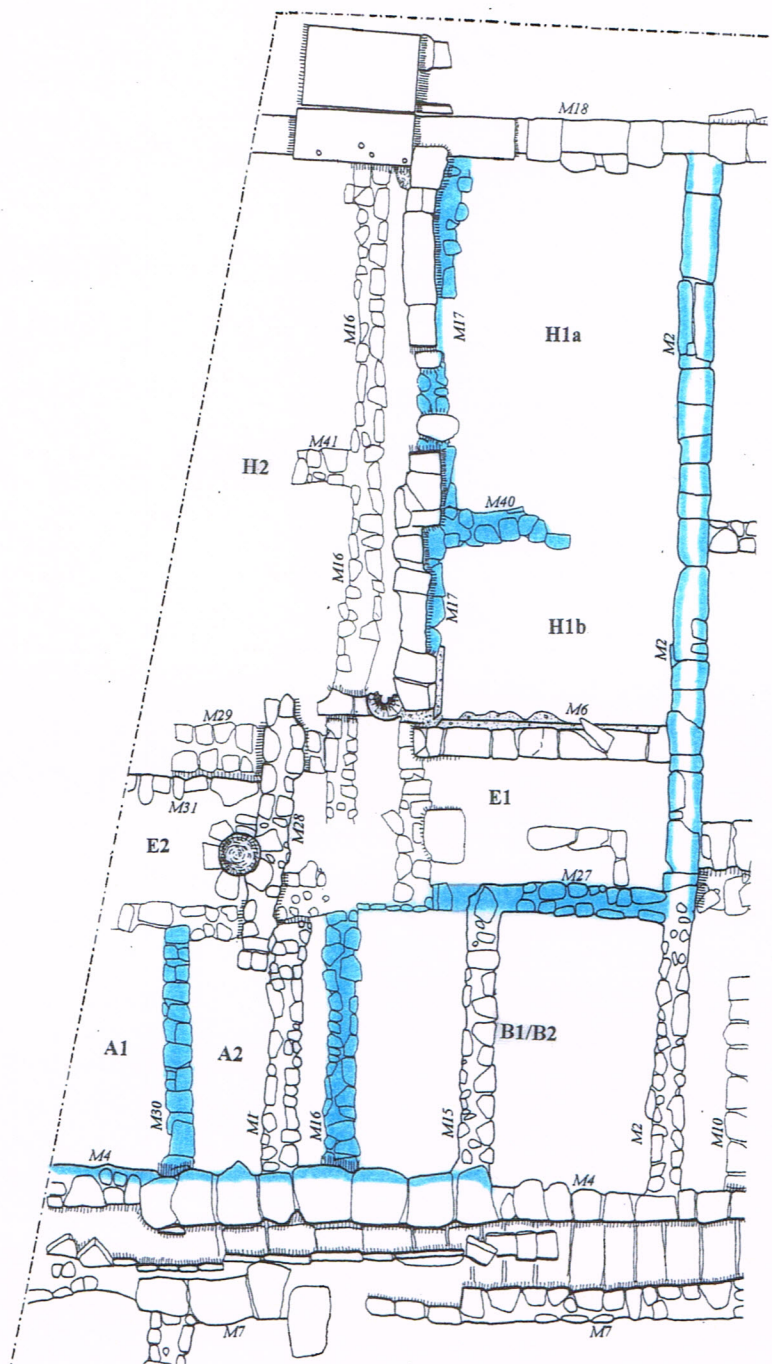

Grundstück B
Haus I Bauphase 2 (BI.2)

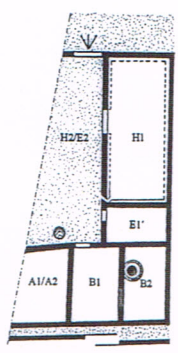
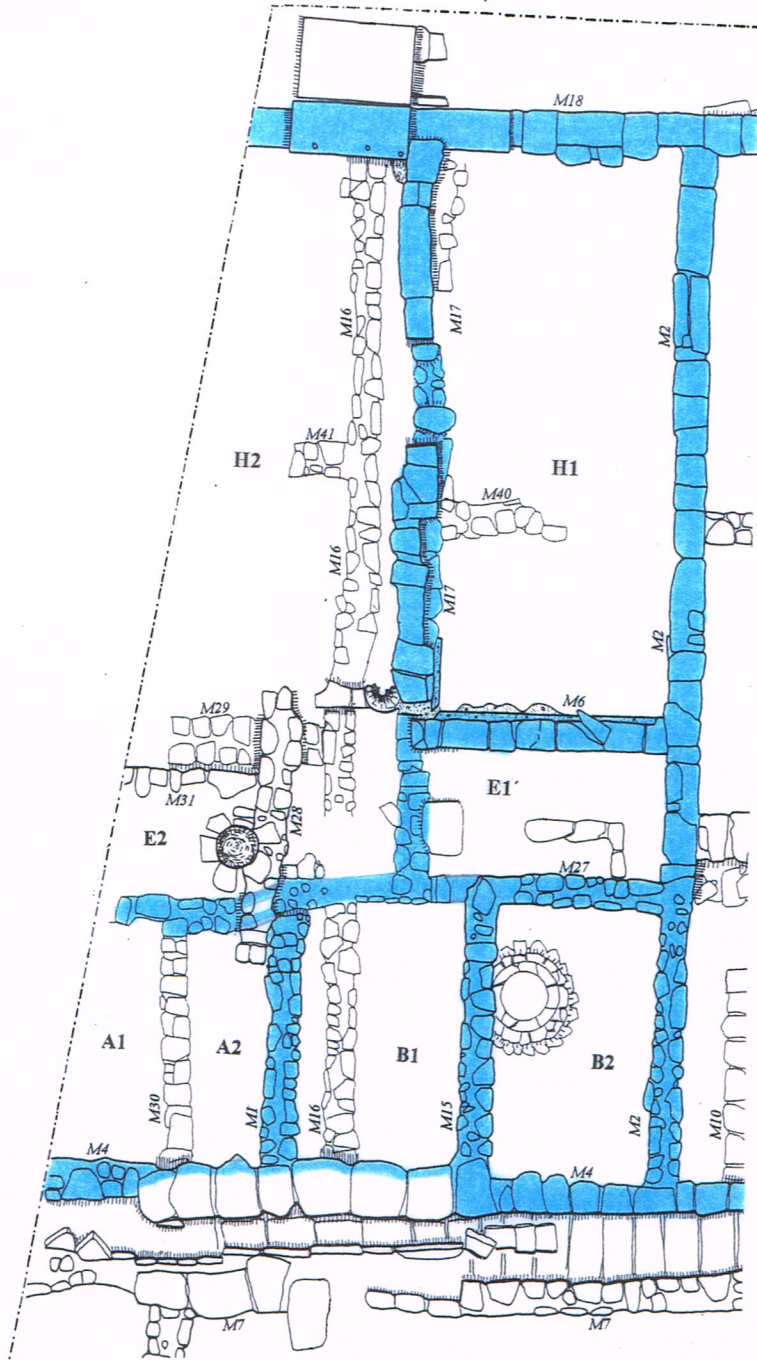

Grundstück B
Haus I Bauphase 3 (Bl.3)

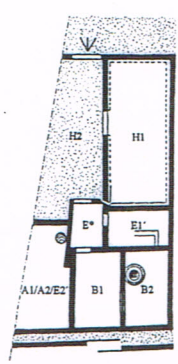
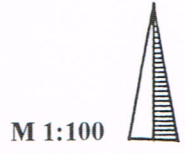
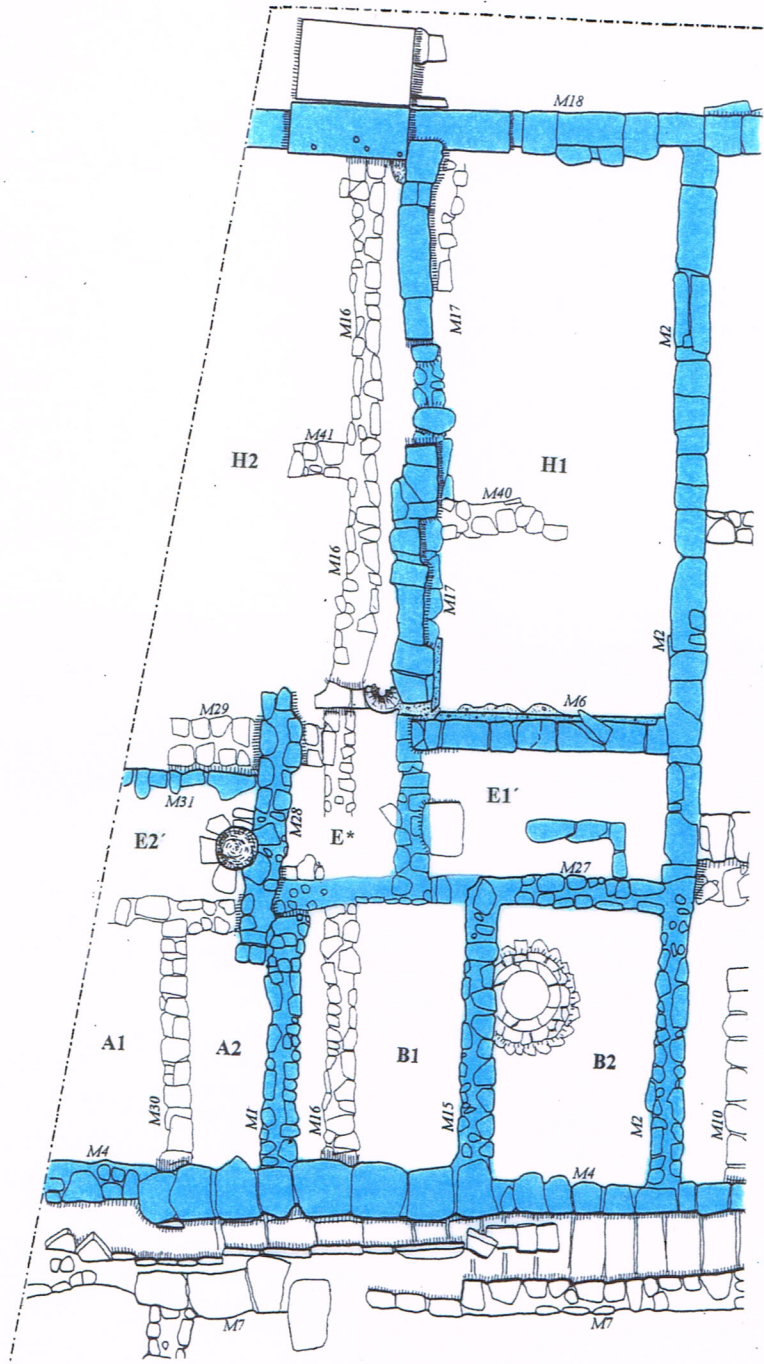

Grundstück B
Haus I Bauphase 4 (BI.4)

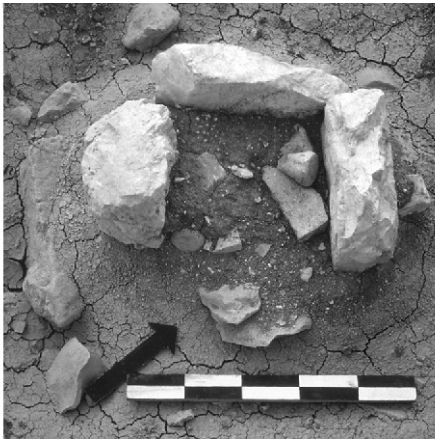

a) Haus BI: Steinsetzung in **H1a**



b) Haus BI (von Norden)

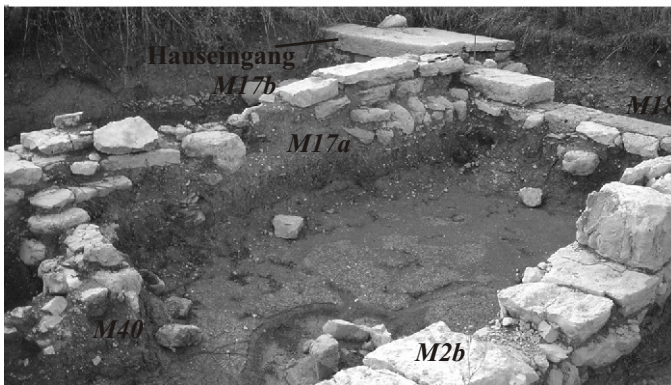

c) Haus BI.2-4: Raum **H1**, *M2b*, *M17a*, *M17b*, *M18*, *M40* (v. Südosten)

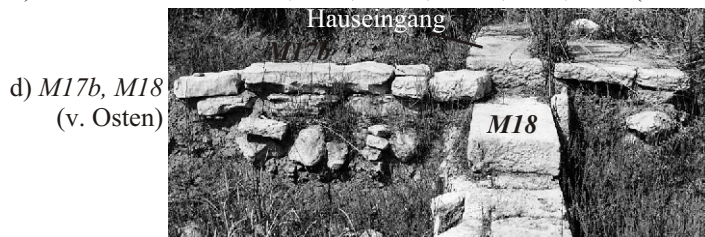

d) *M17b*, *M18*
(v. Osten)



e) Haus BI.1: *M16* (von Norden)



f) Haus BI.2-4: Raum **H1**,
M2b, *M6*, *M17b*, *M40* (von Norden)

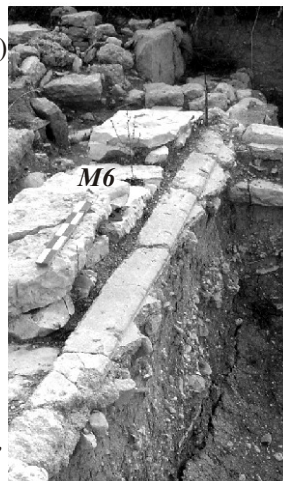

g) Haus BI.3&4: Raum **H1**, *M6*,
Mörtelabsatz in **H1** (von Osten)

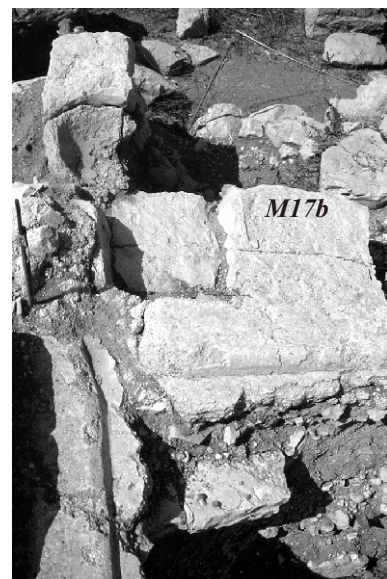

h) Haus BI.3&4: Mörtelabsatz mit
Rinne in **H1** (von Osten)

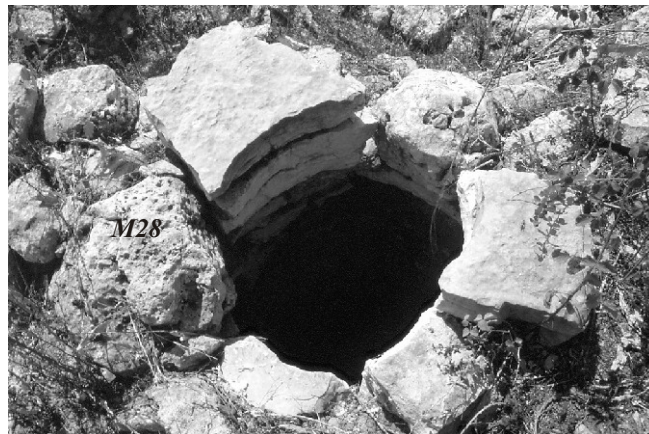

a) Haus BI.2-4: Brunnen, *M28* (von Norden)



b) Haus BI.3&4: Raum *E1'*, *M6*, *M17b* (von Westen)



c) Haus BI.3&4: Raum *E1'*, *M6*, *M17b* (von Südwesten)



d) Haus BI.3&4, Haus BII.2&3: *M2*, *M3*, *M4*, *M15* (von Westen)

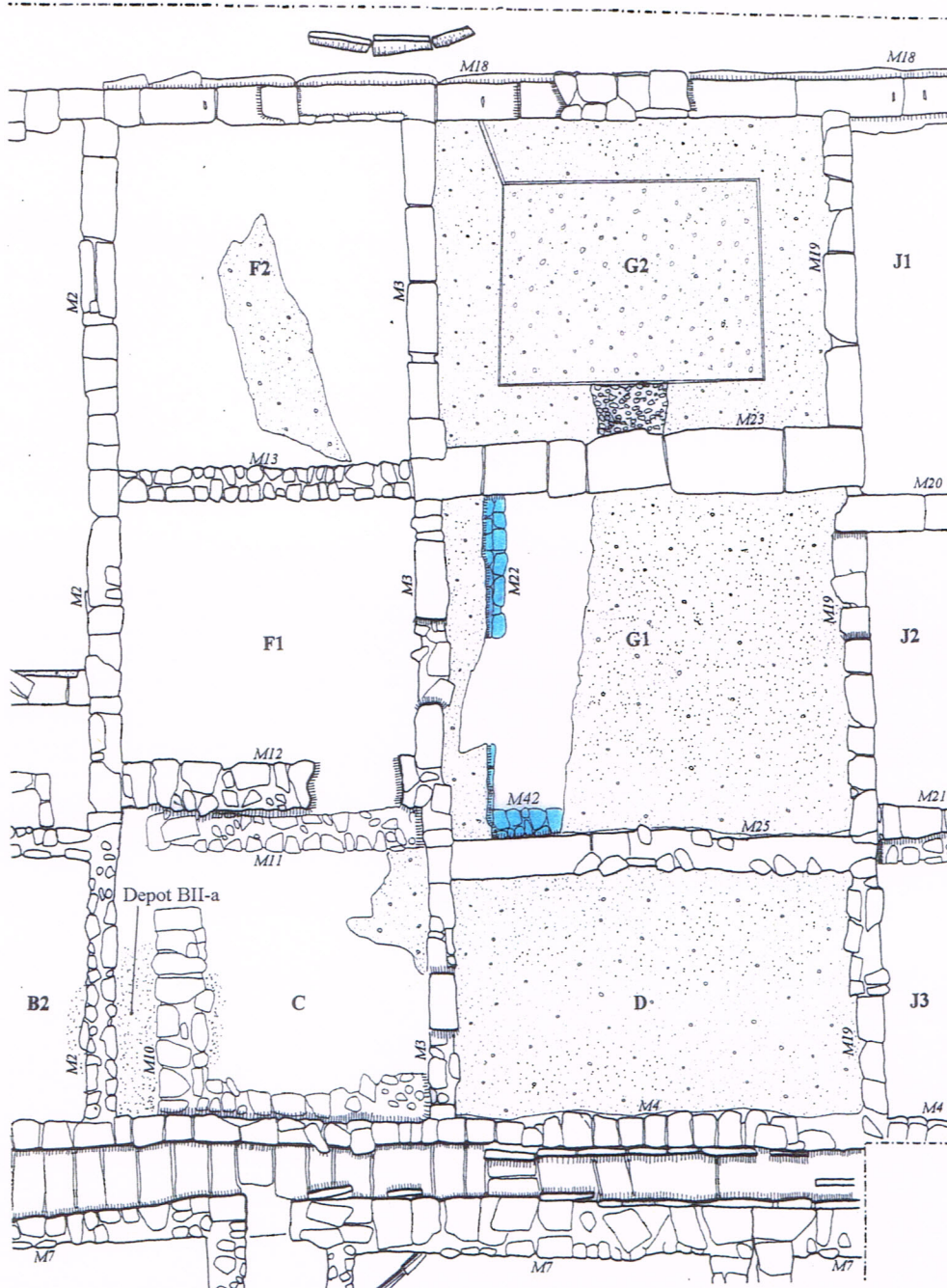

M 1:100

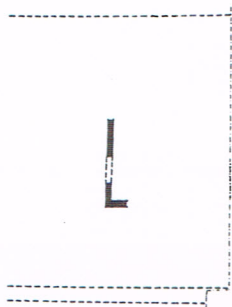

Grundstück B
Haus II Bauphase 1 (BII.1)

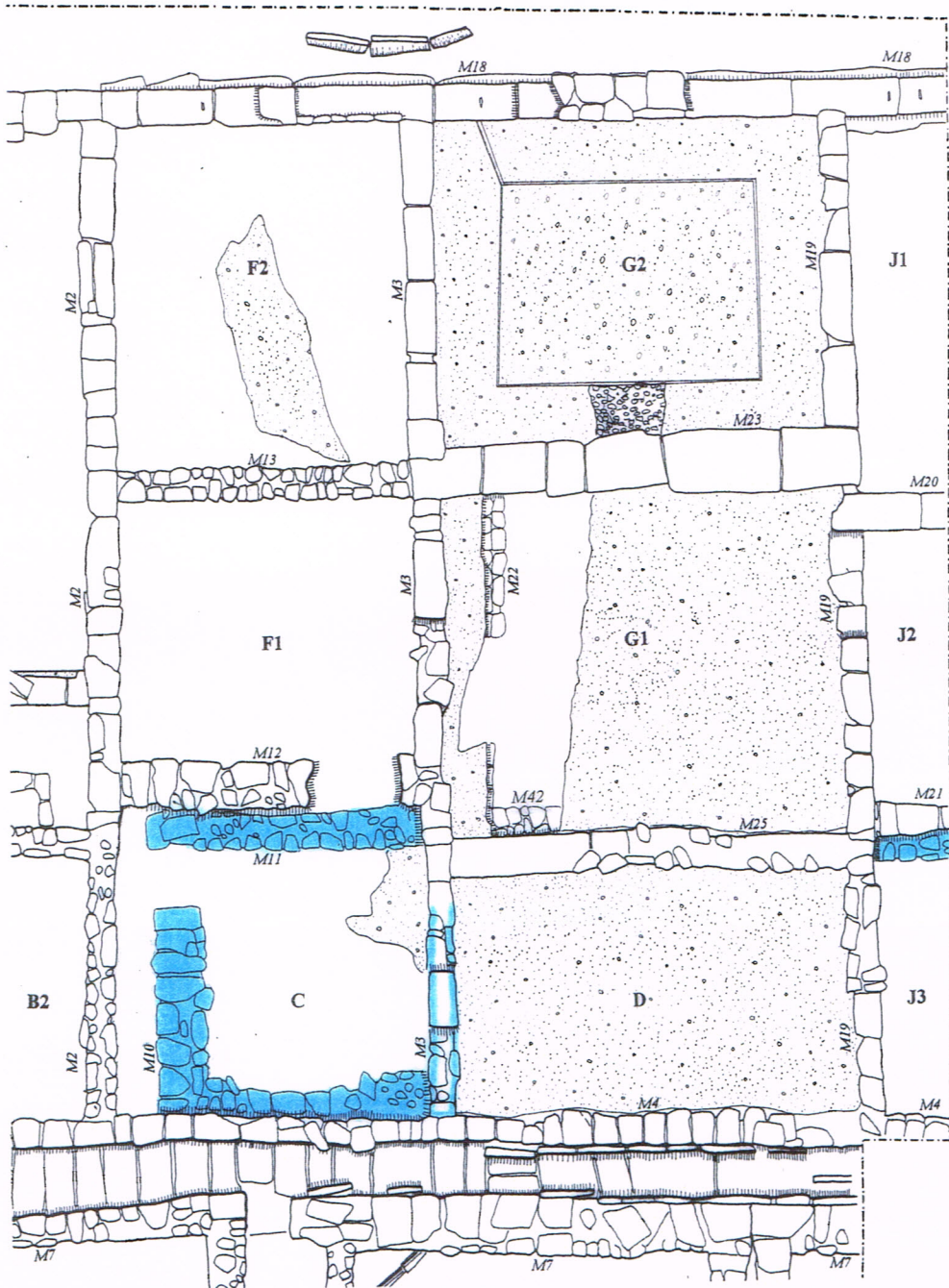

M 1:100

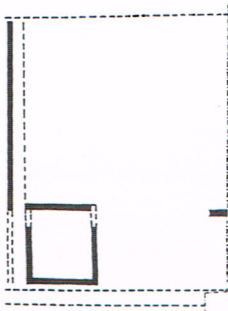

Grundstück B
Haus II Bauphase 2 (BII.2)

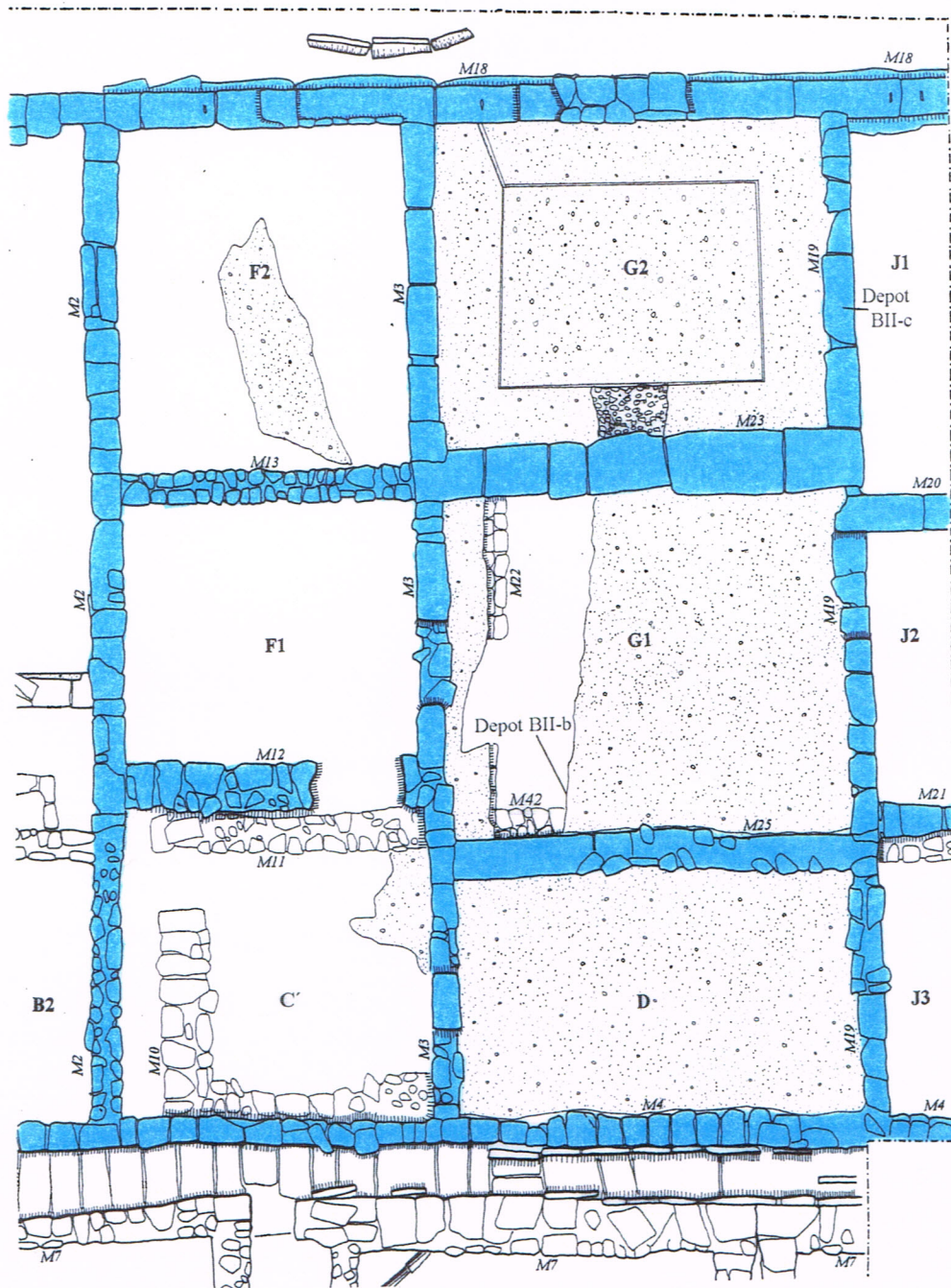

M 1:100

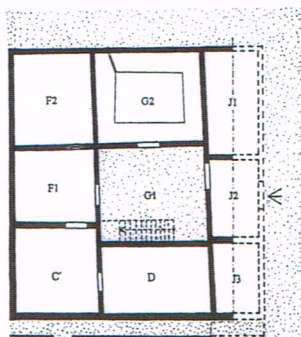

Grundstück B
Haus II Bauphase 3 (BII.3)



a) Haus BII.3 (von Norden)

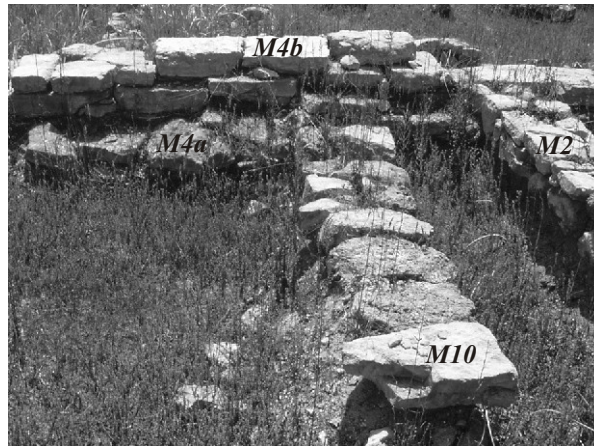

b) Haus BII.2&3: M2, M10, M4a, M4b (von Norden)

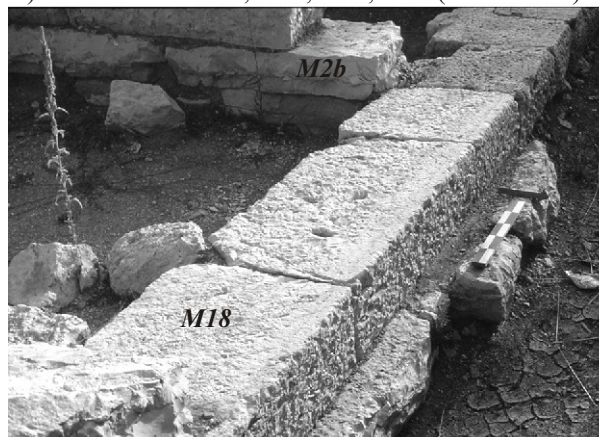

c) Haus BII.3: M2b, M18 (von Nordosten)



d) Haus BII.3: M18 (von Norden)



e) Haus BII.3: M2b, M3b (von Südwesten)



a) BII.3: Hof **G1** mit Presse *in situ*, *M3b*, *M18* (von Nordwesten)



b) Haus BII.2&3: *M2b*, *M3a*, *M3b*, *M4b* (von Westen)

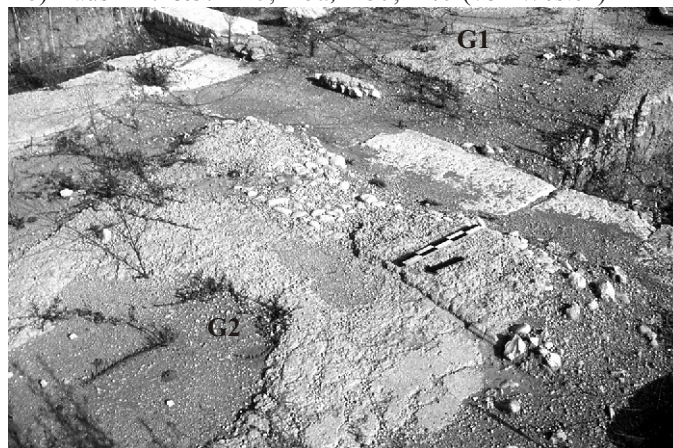

c) Haus BII.3: Bankettraum **G2**
(von Nordwesten)



d) Haus BII.3: Mörtelboden in F2

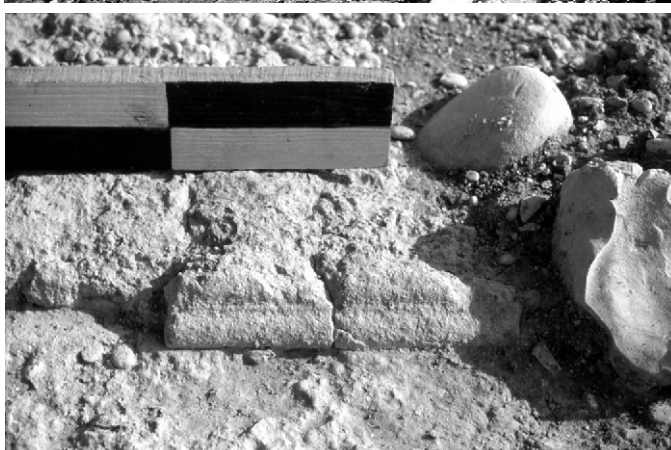

e) Haus BII.3: Bankettraum **G2**,
Fußboden mit Bankettabsatz

f) Haus BII.3: Bankettraum **G2**,
profilierter Bankettabsatz

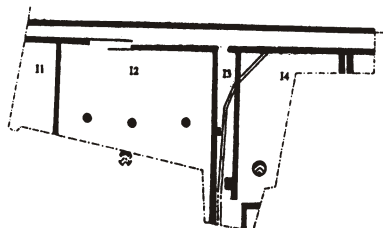
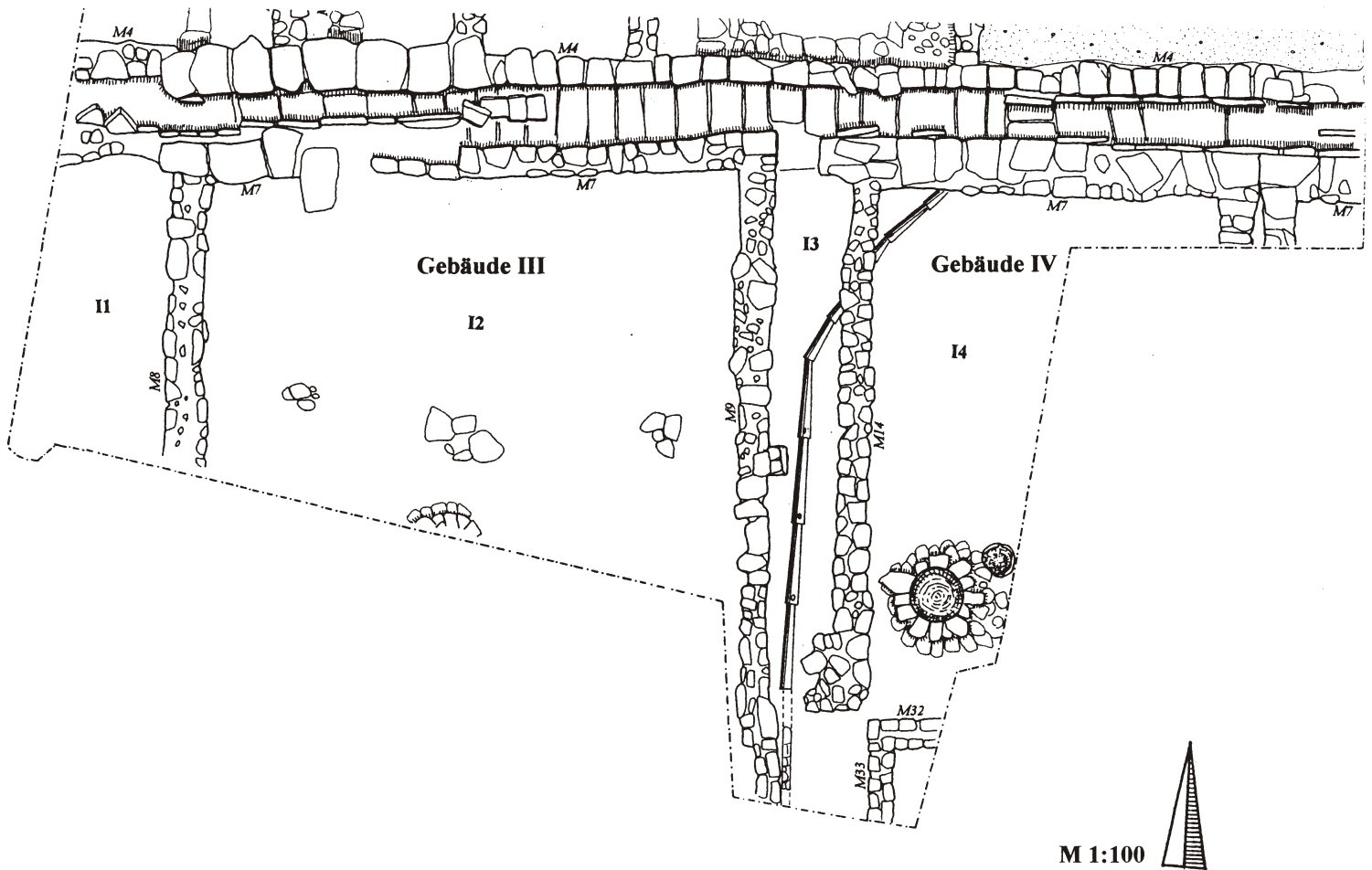

Grundstück B
Gebäude III und IV (BIII, BIV)



a) Tonrohrwasserleitung zwischen BIII und BIV

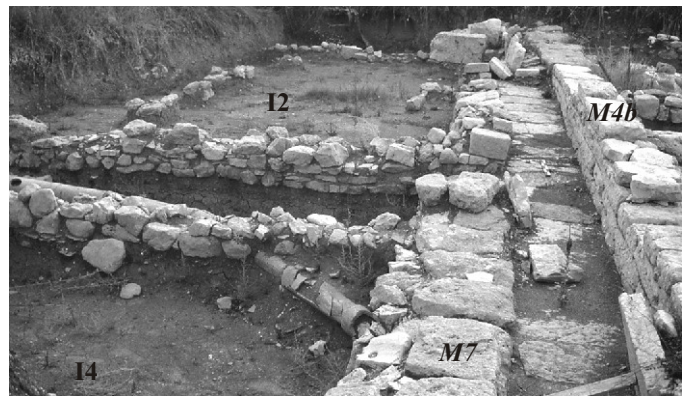

b) Grundstück B: Mittelkanal, Gebäude BIII (12), M4b, M7 (von Osten)

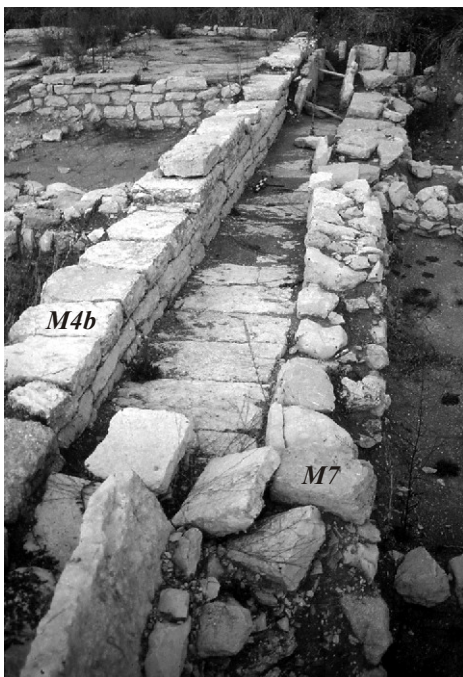

c) Grundstück B: Mittelkanal, M4b, M4c (von Westen)

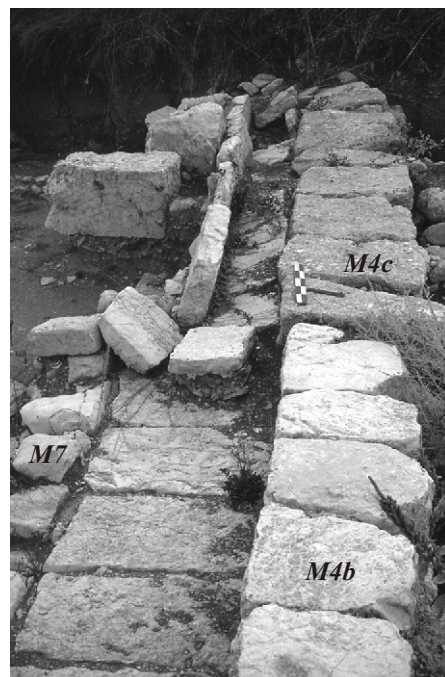

d) Grundstück B: Mittelkanal, M4b, M4c (von Osten)

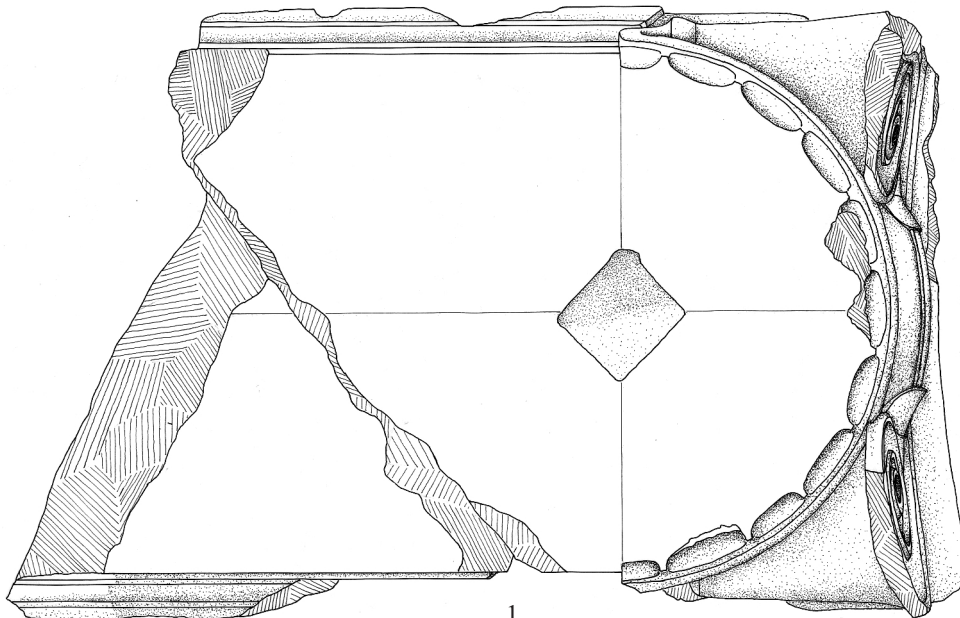
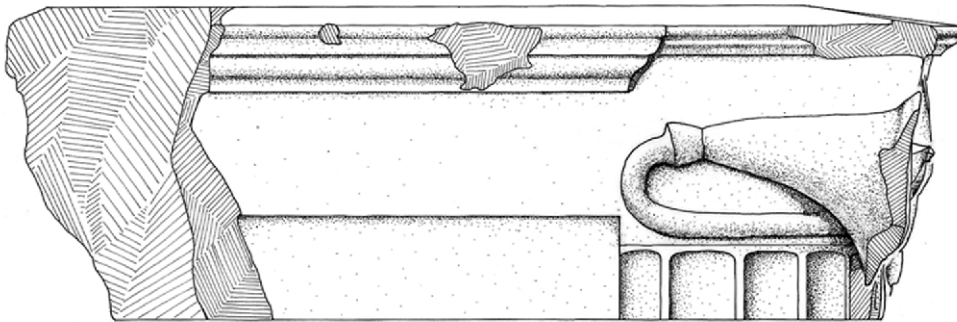
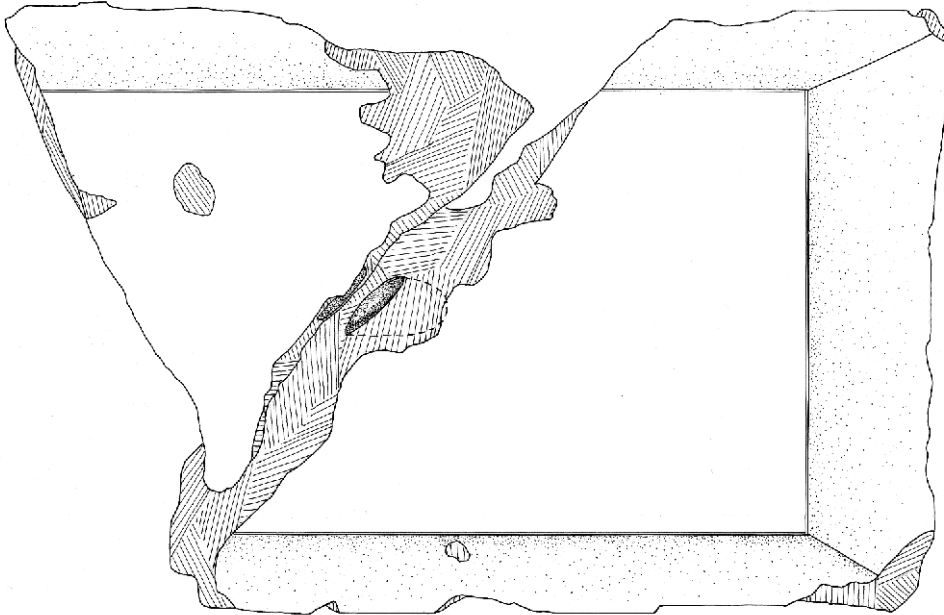
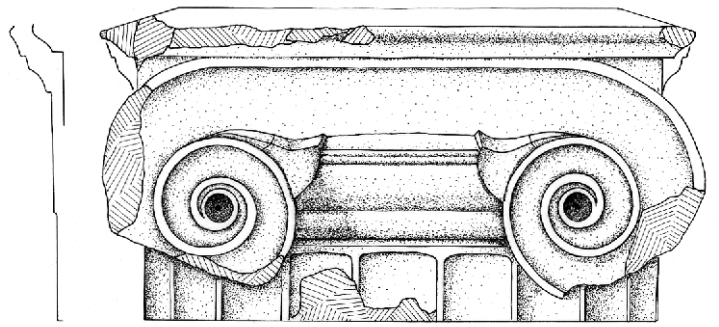
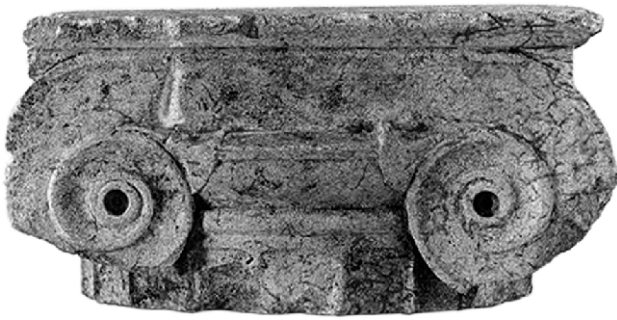

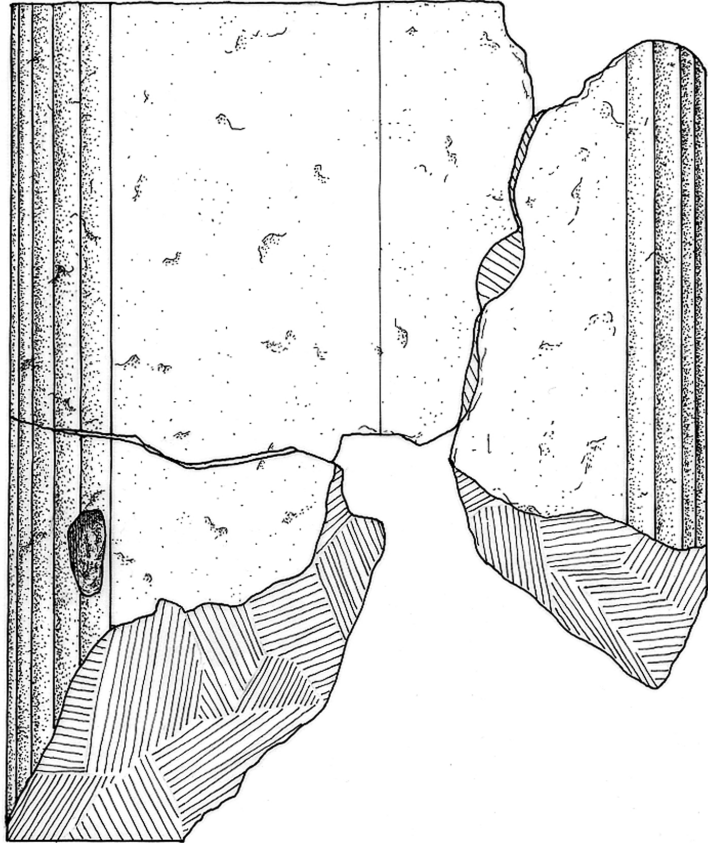
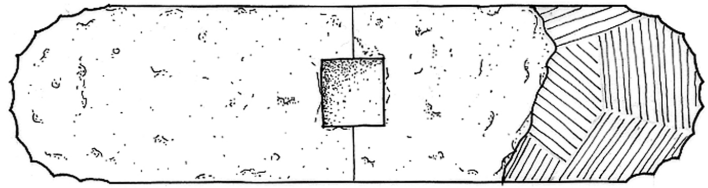

2

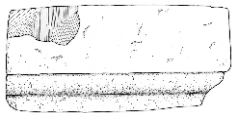

3



6



4



5

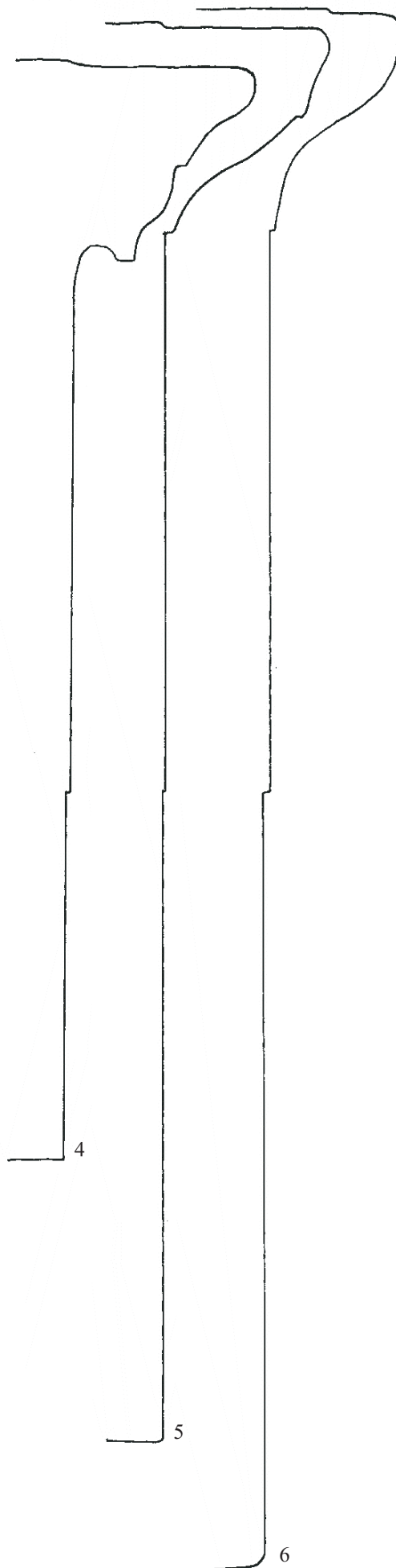

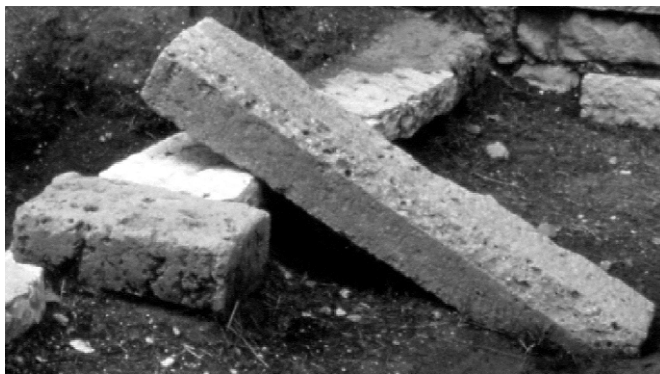
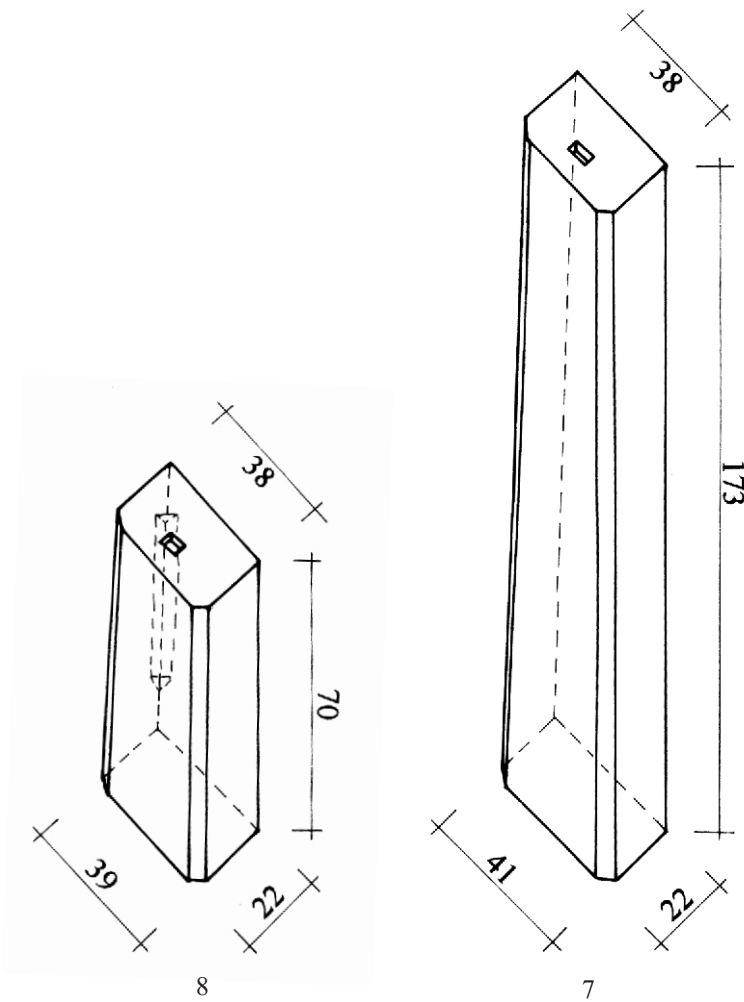

8

7



9

10

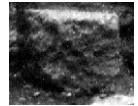
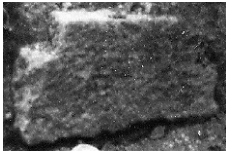

13

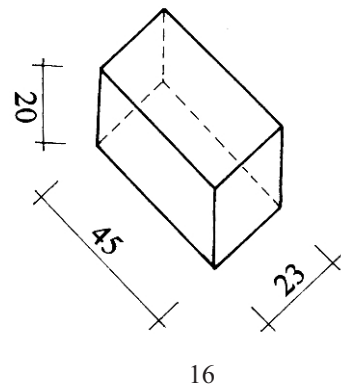
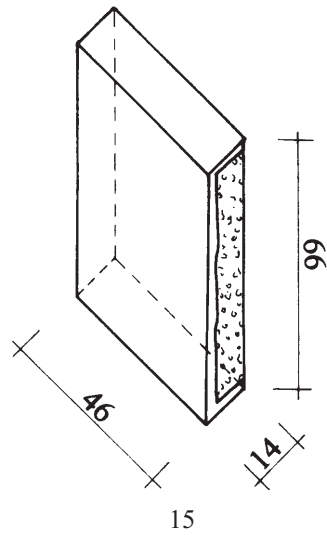
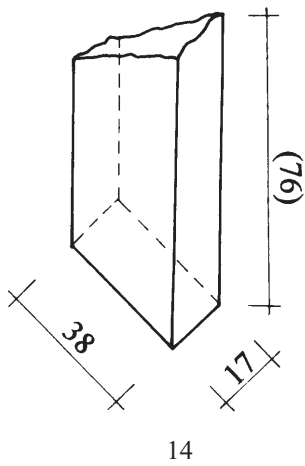
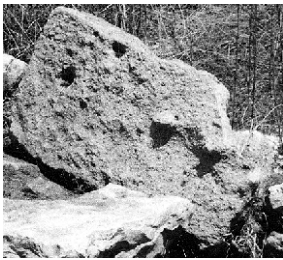
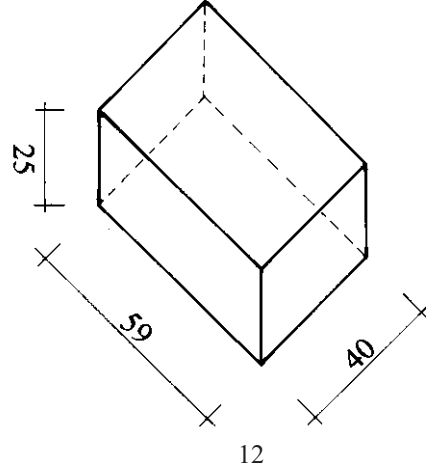
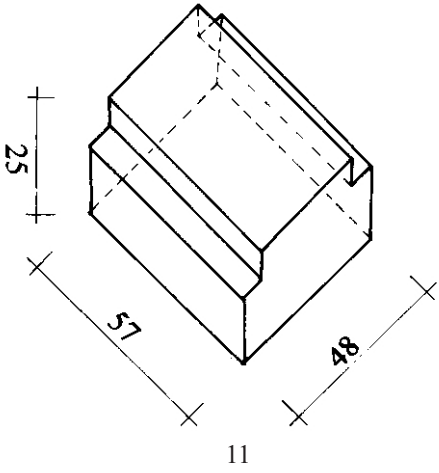

17

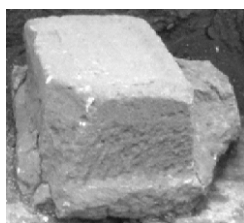

18

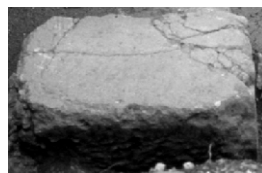

19



20

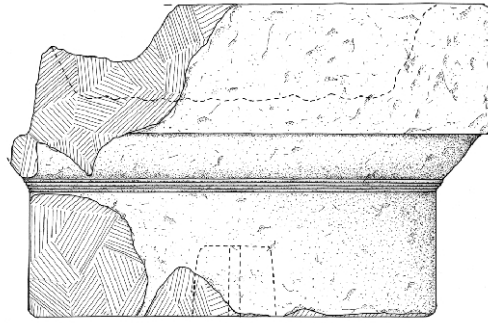

21

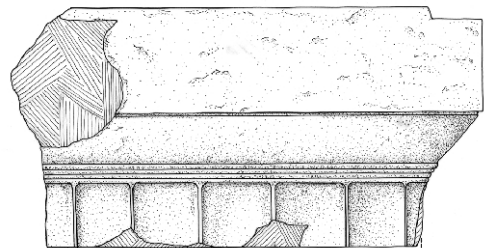
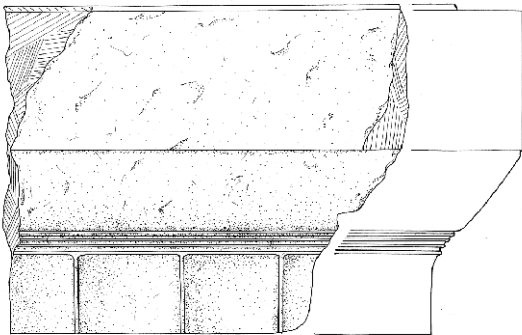

23



22

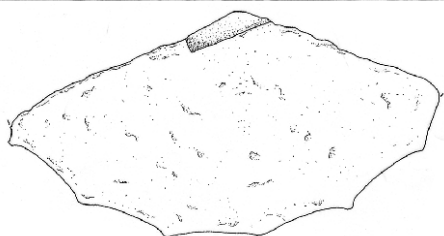

24

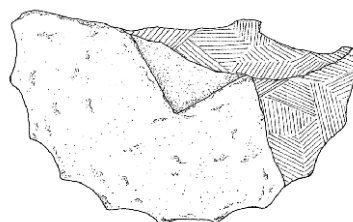

25

1:5

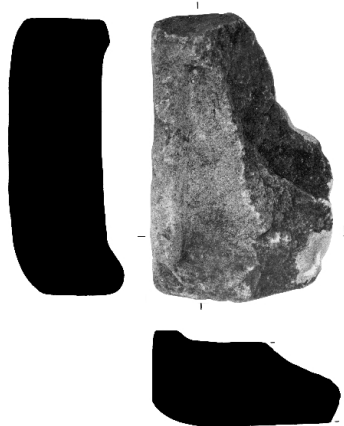

26



30

1:4



27

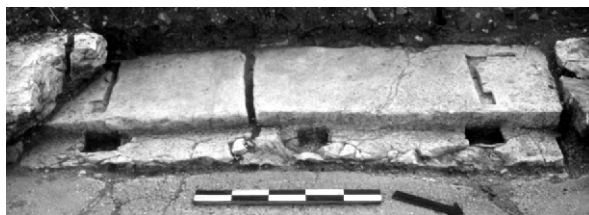

28

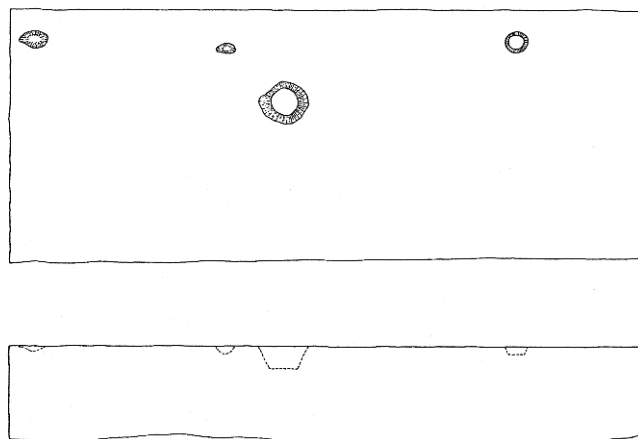

29



31



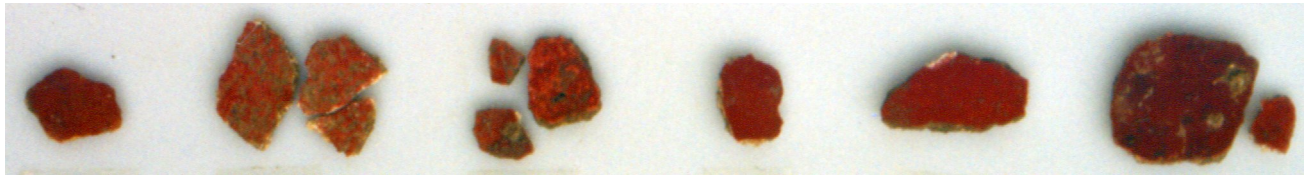

46

65

60

63

66

43



59

58

72



64

45

70

67

44/53



83

79

81



78/82

48

39

71



36



55/56

57

2:3

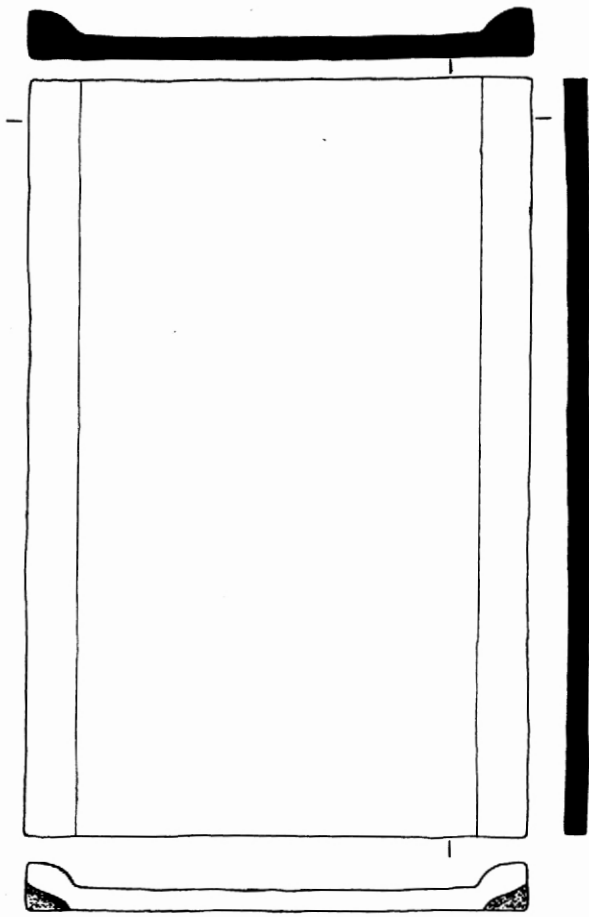

98, Var. A1

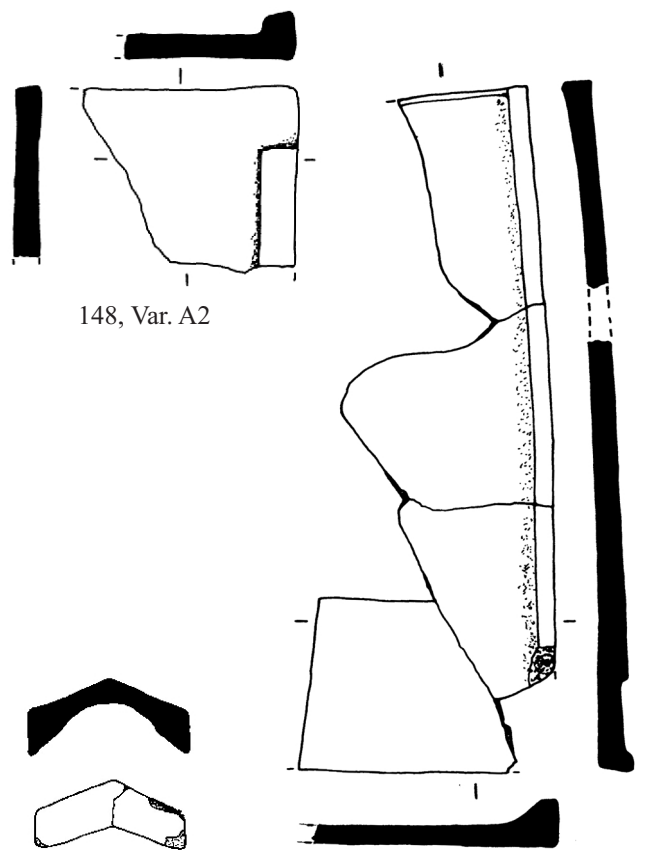

148, Var. A2

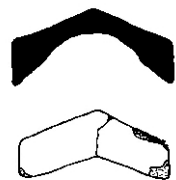

131

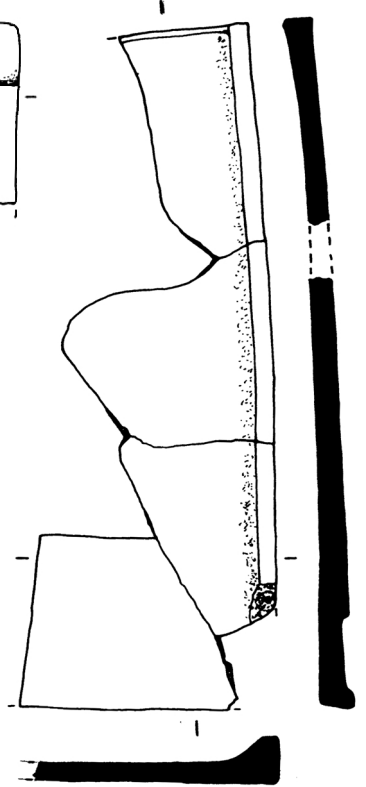

104, Var. B

1:8



88

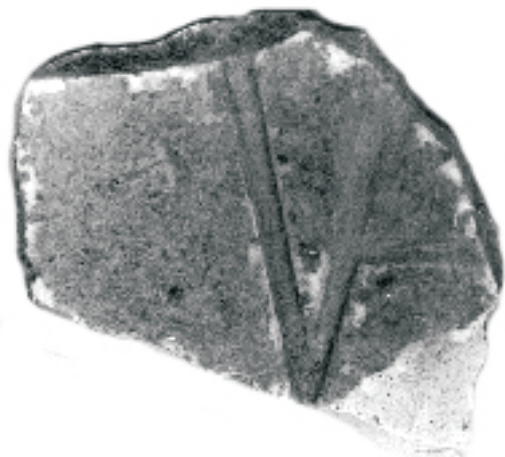
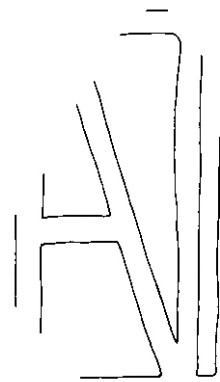

89

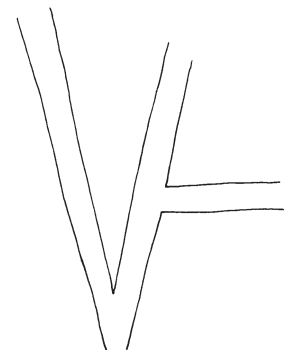

1:2

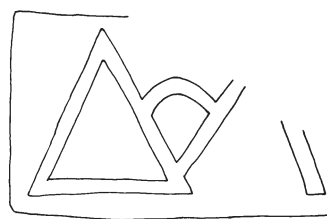
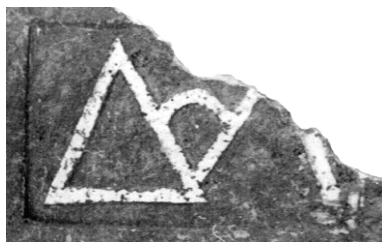

92

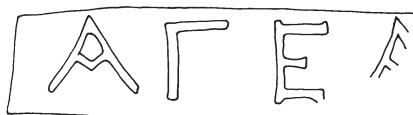
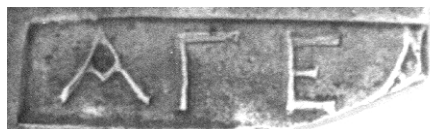

93

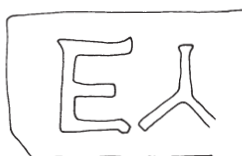

94



95



96

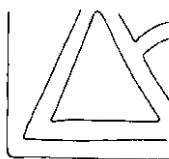

97



141



143



144



168





170

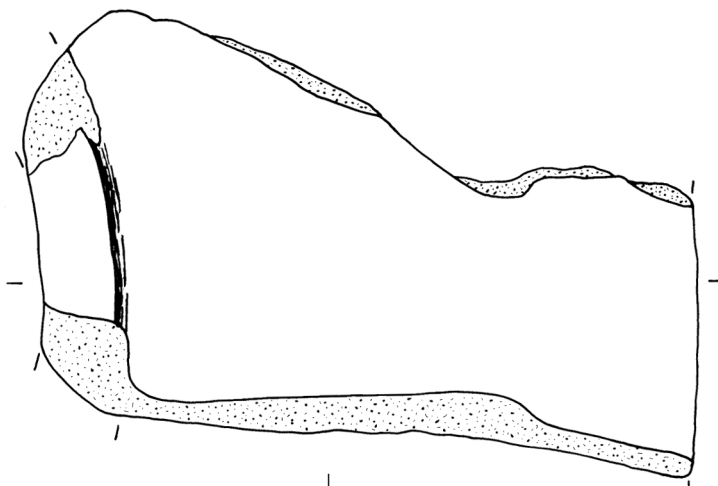

171

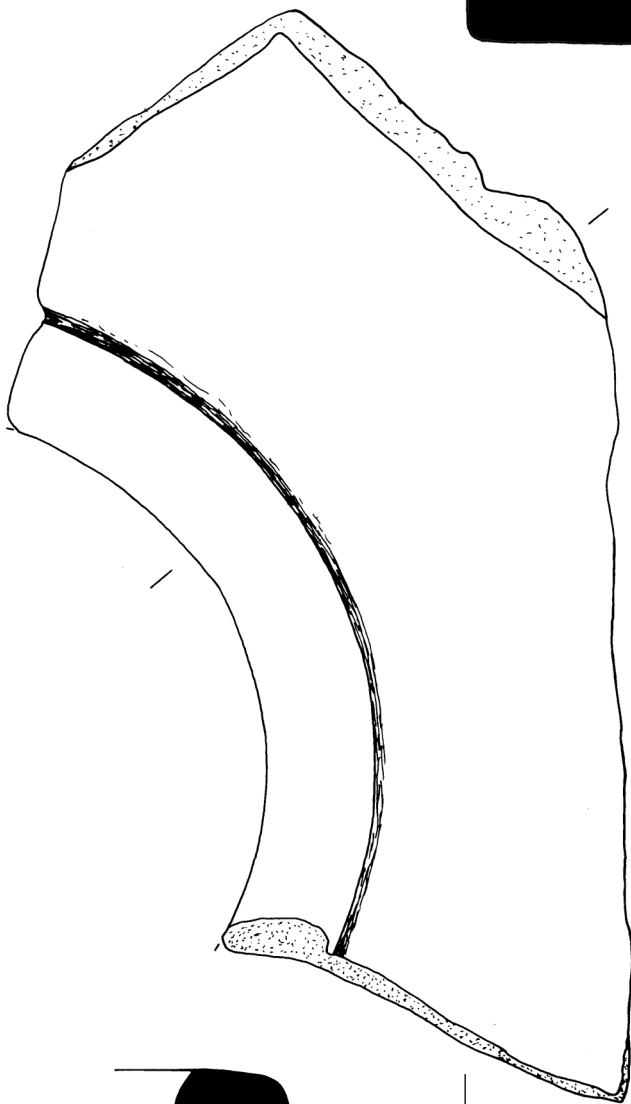

172

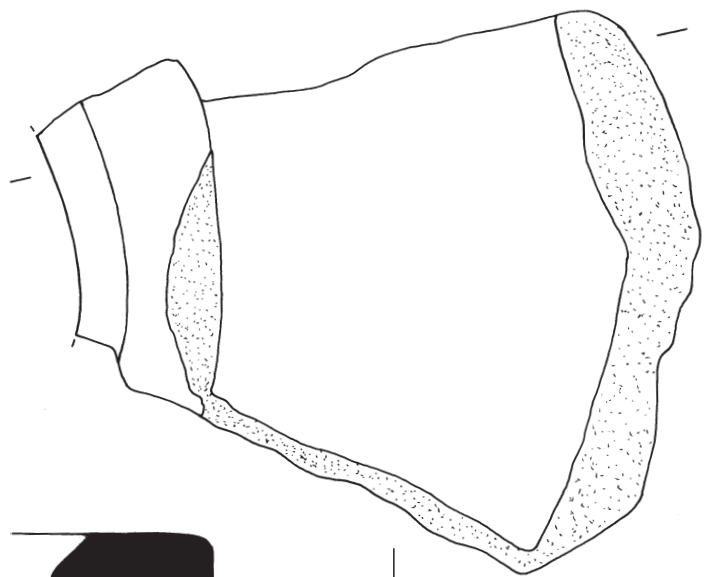

173



174

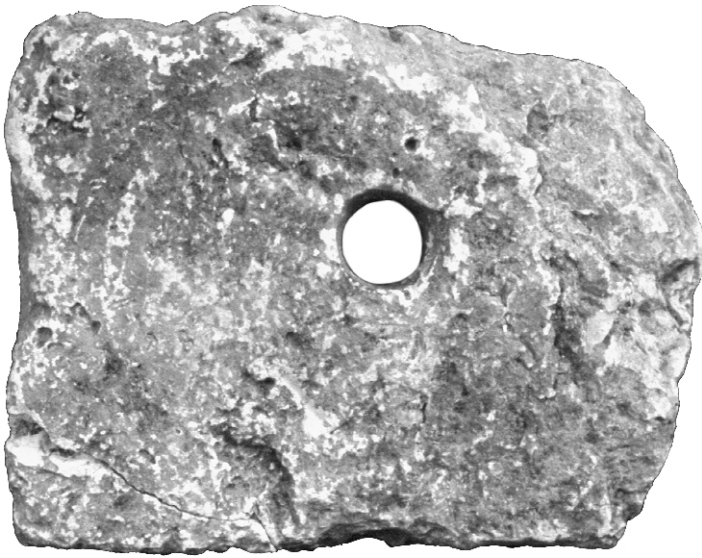

176



187

1:3



192



1:2

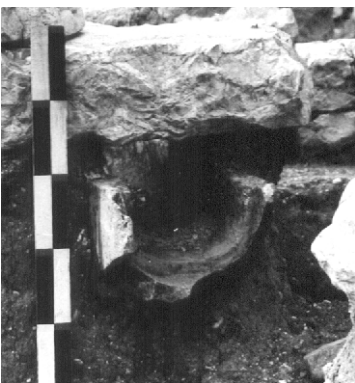

1:10

188



Typ a



Typ b



190

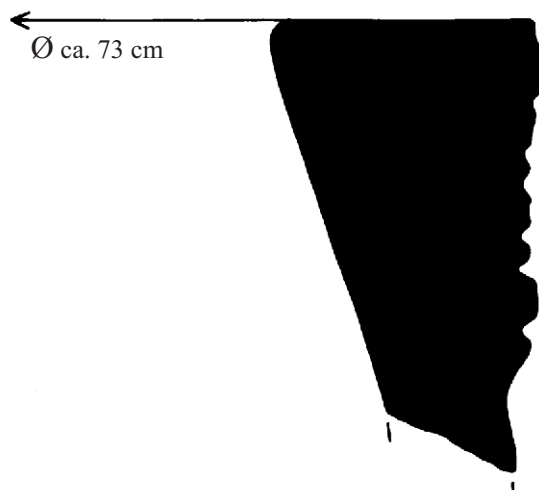
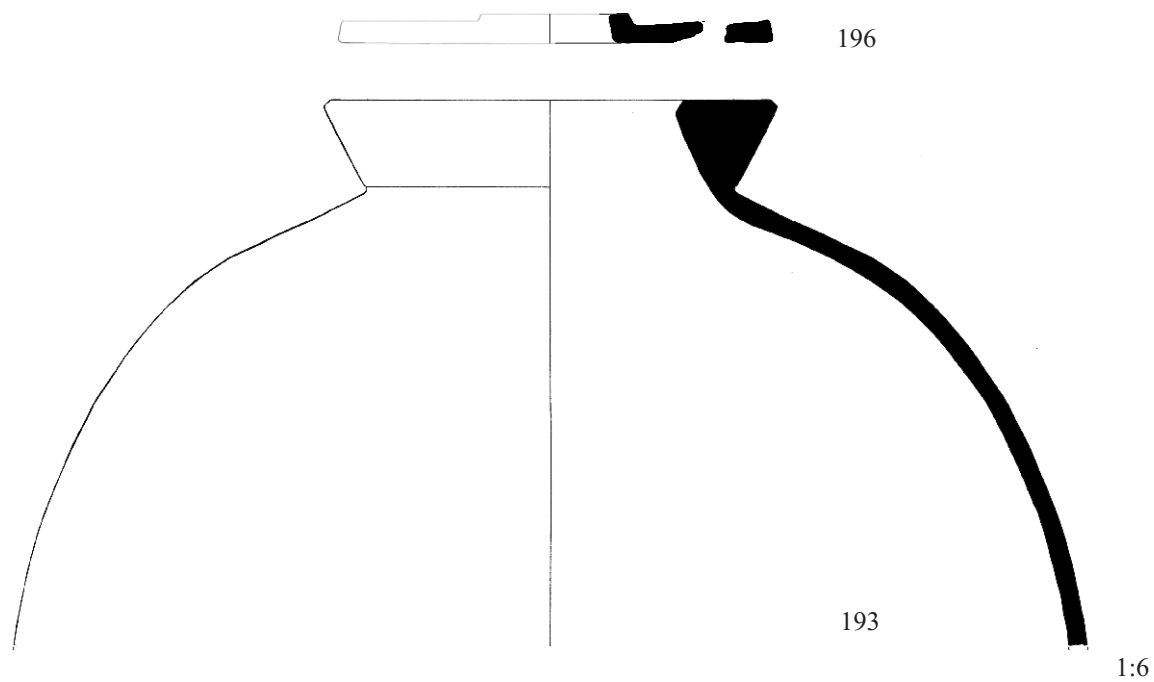



200

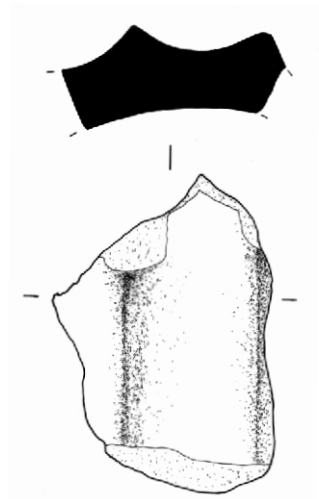

199

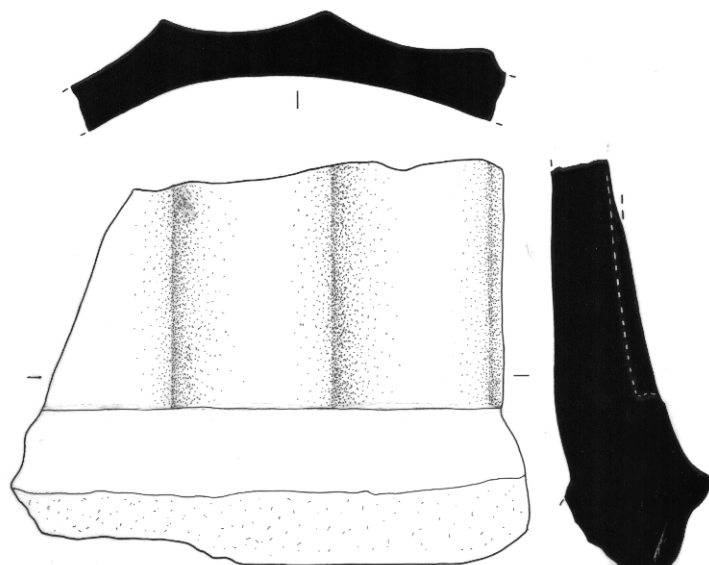

198

Ø 40 cm



210

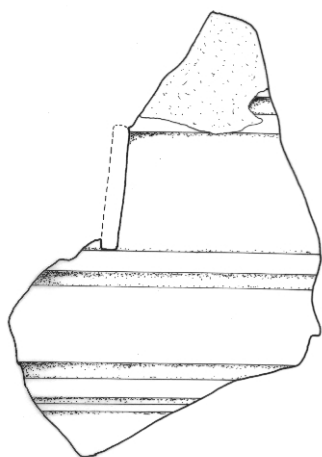

202

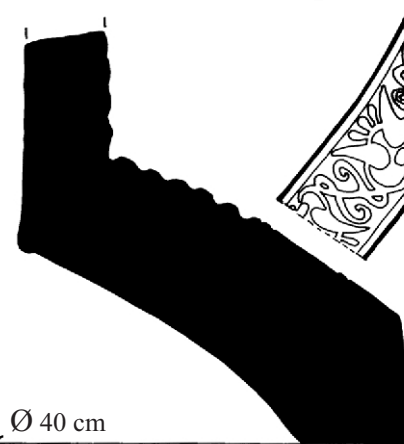

204



1:2

Ø 40 cm

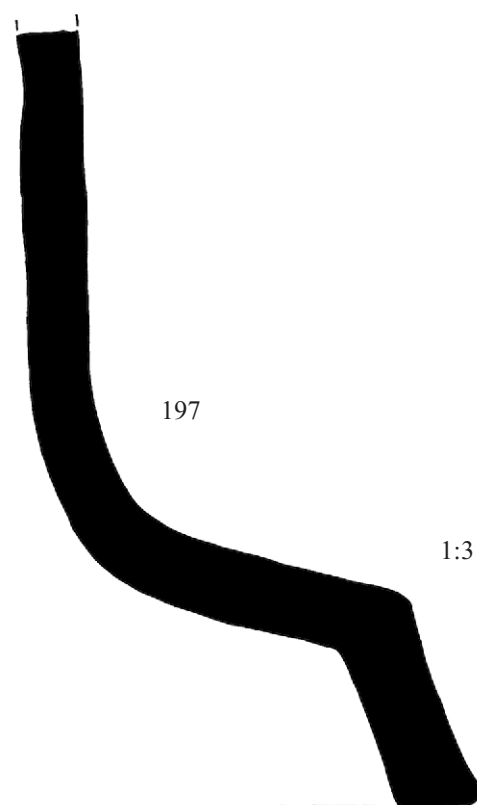
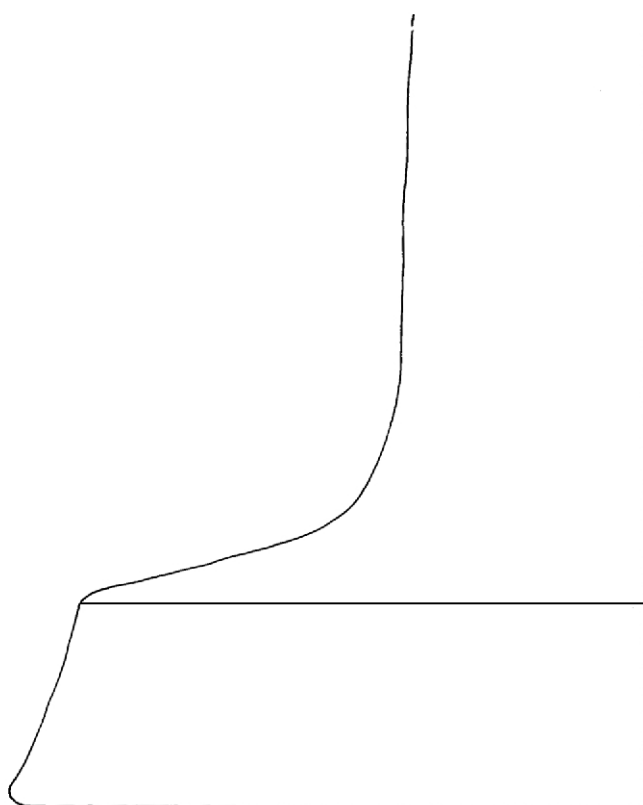

197

1:3



1:2



205

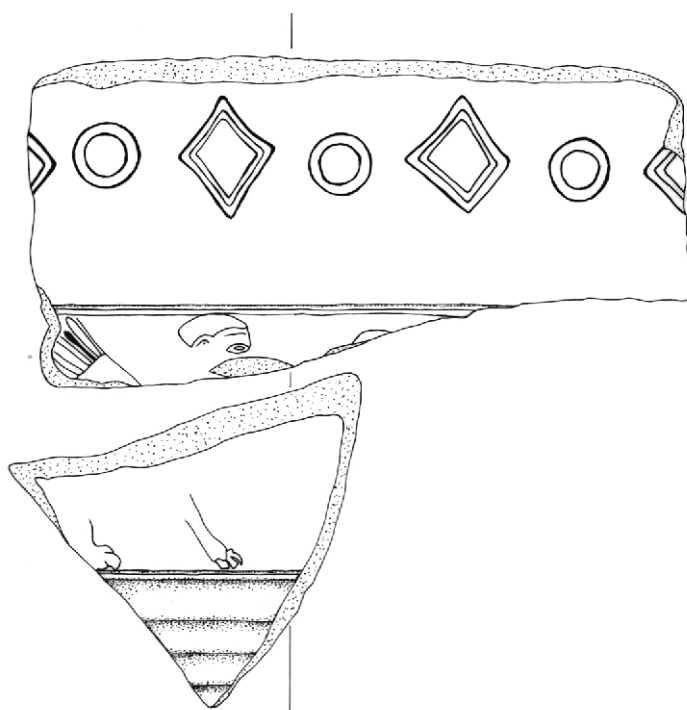

207

1:2

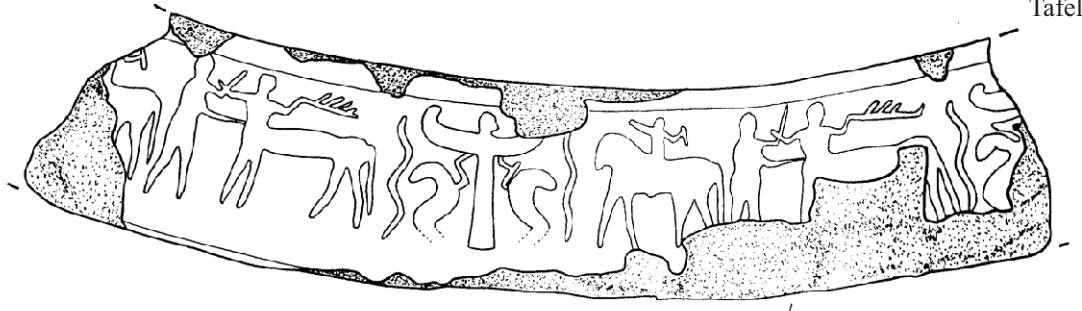

Ø 73 cm

206



2:3

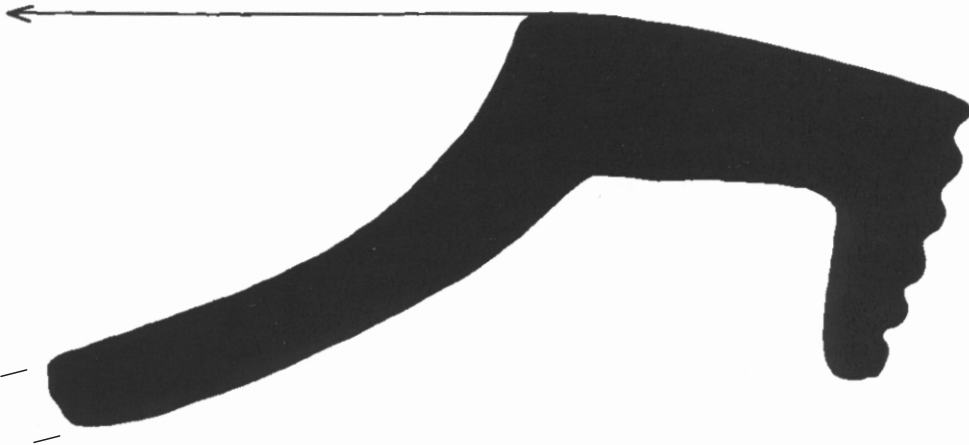

Ø ca. 60 cm

214

212



215

Ø um 50 cm



217

Ø 54 cm

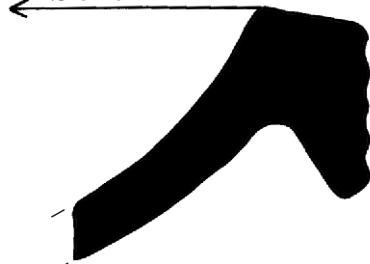

218

Ø 50 cm

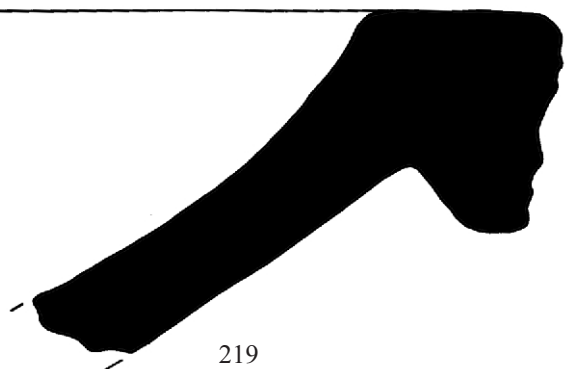

219

2:3

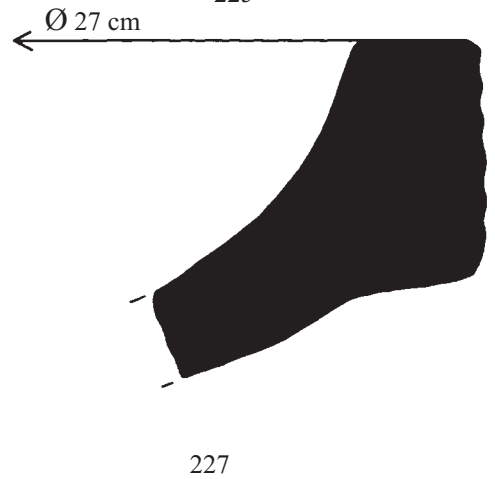
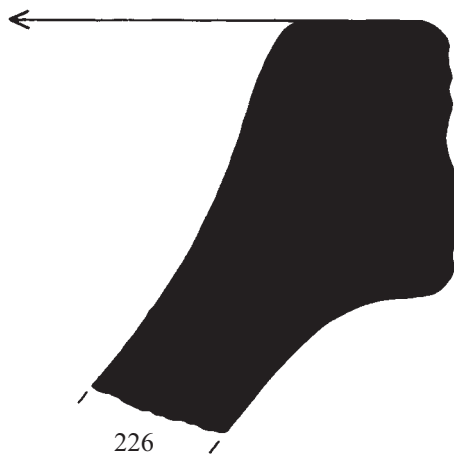
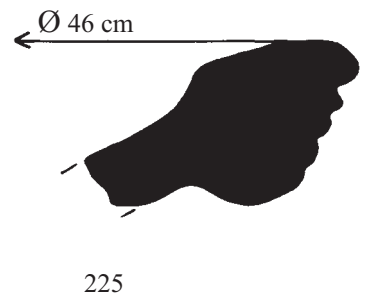
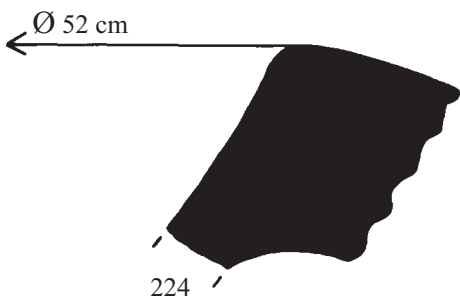
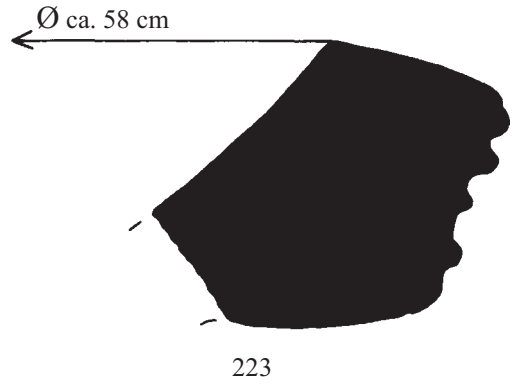
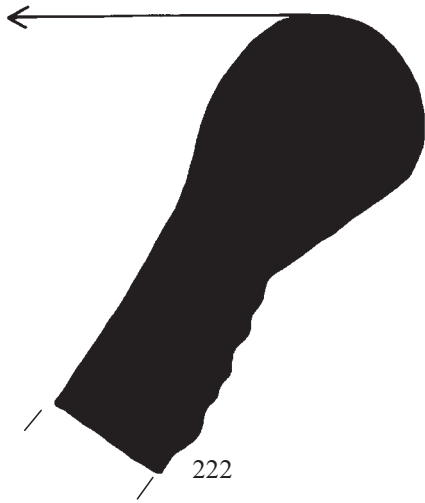
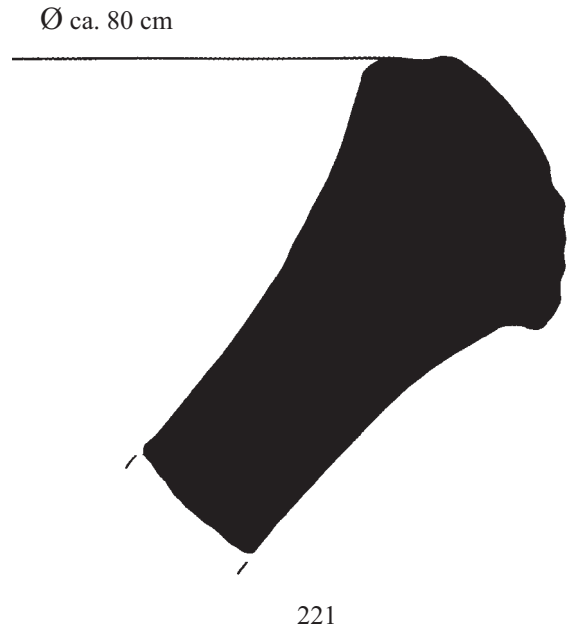
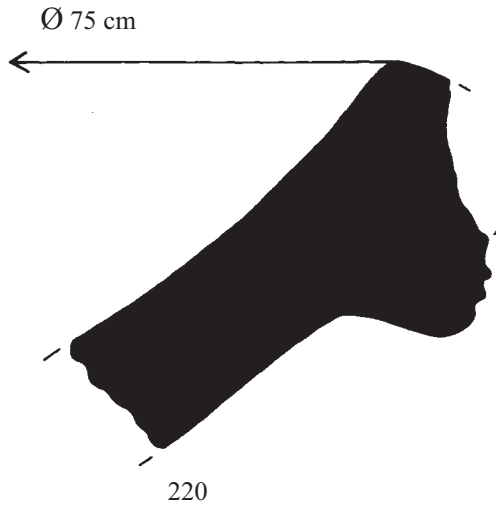

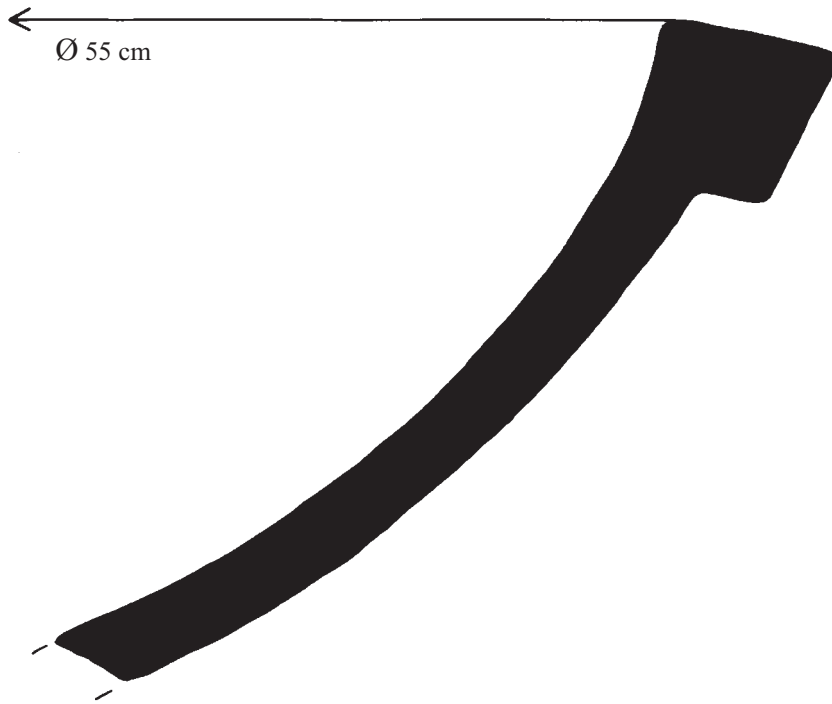

228

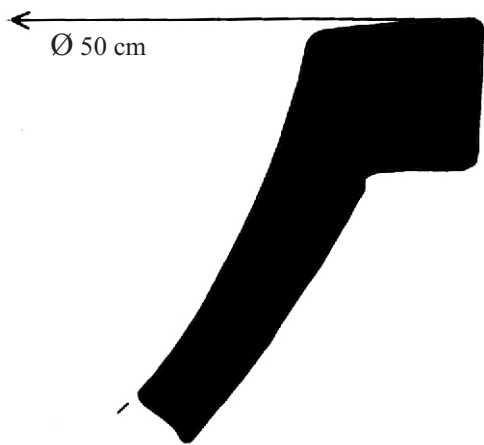

229

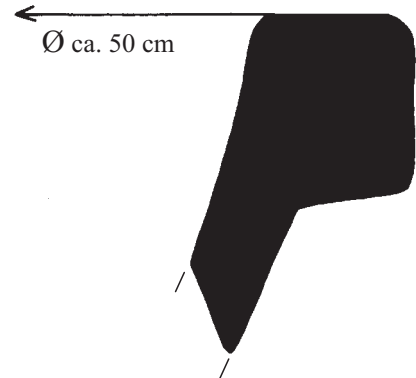

230



231

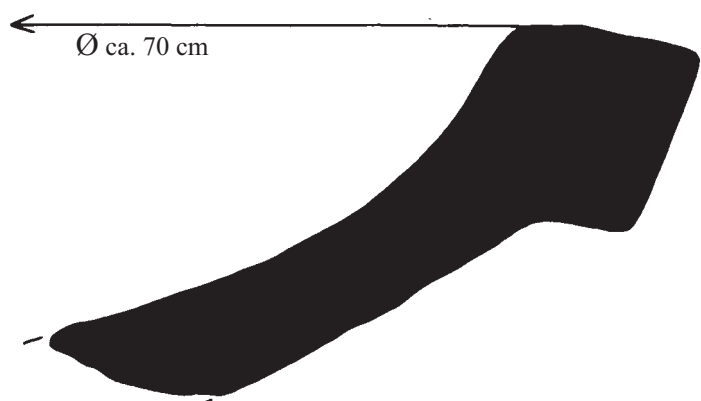

232

2:3

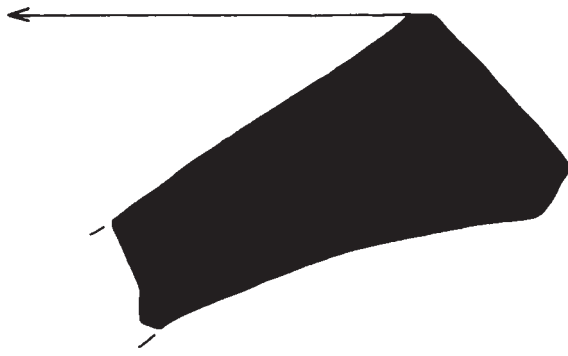

233

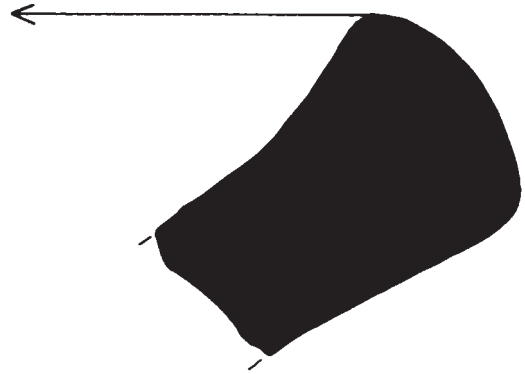

234

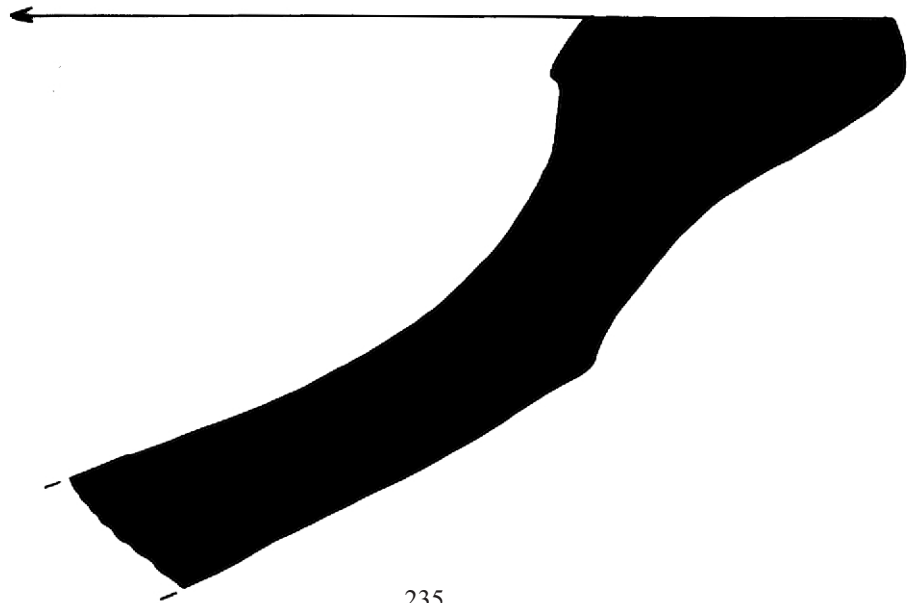

235



236

2:3



238



1:3

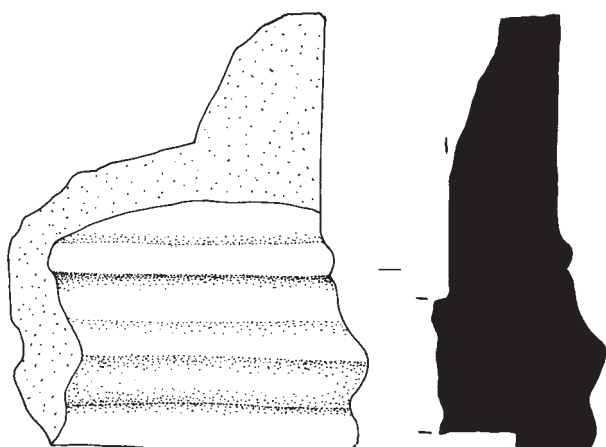

239



240

2:3



242



243

1:1



246

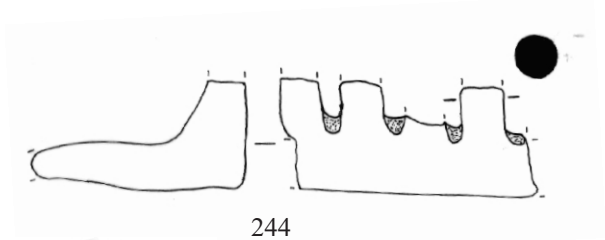
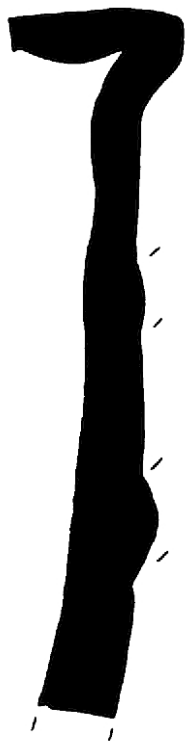

244



248



247

2:3

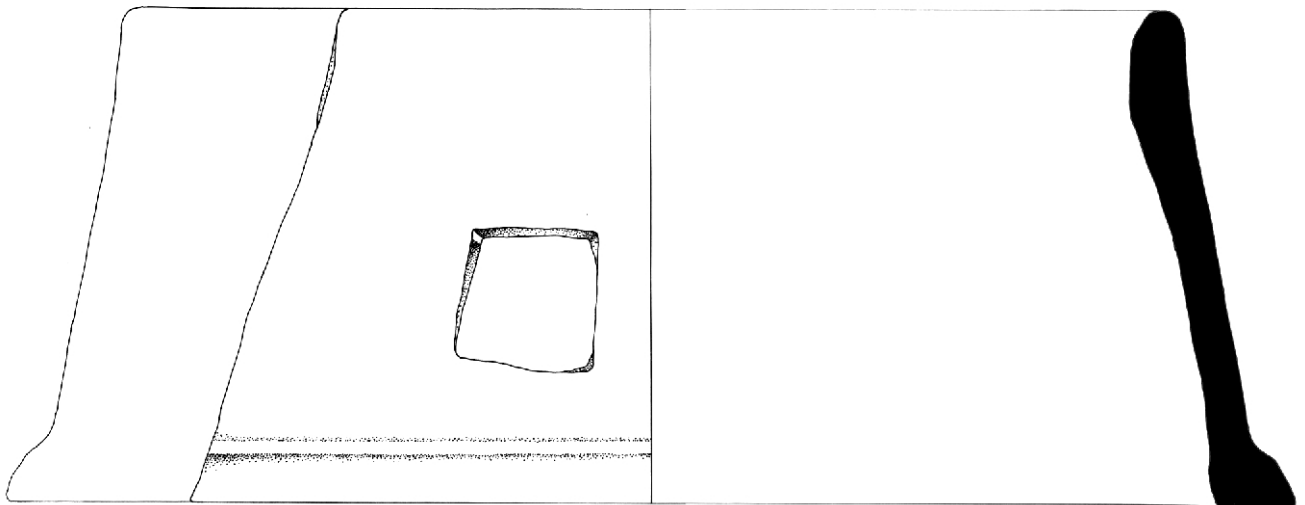

249

1:2

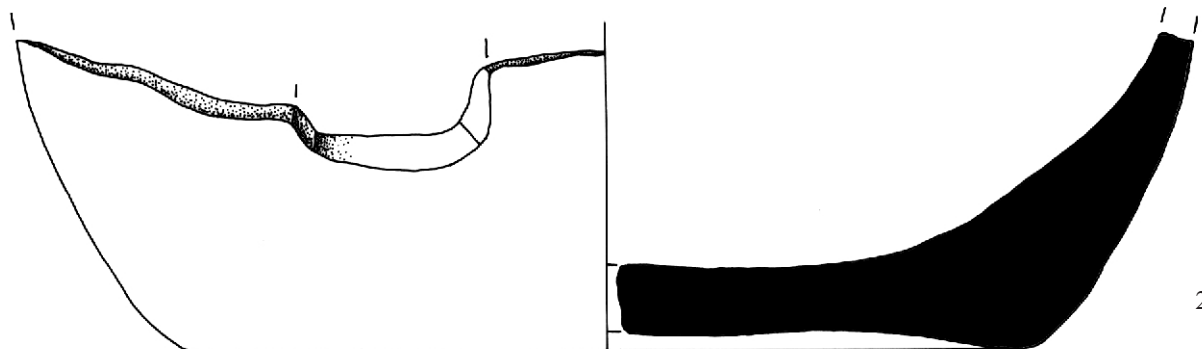

250

2:3

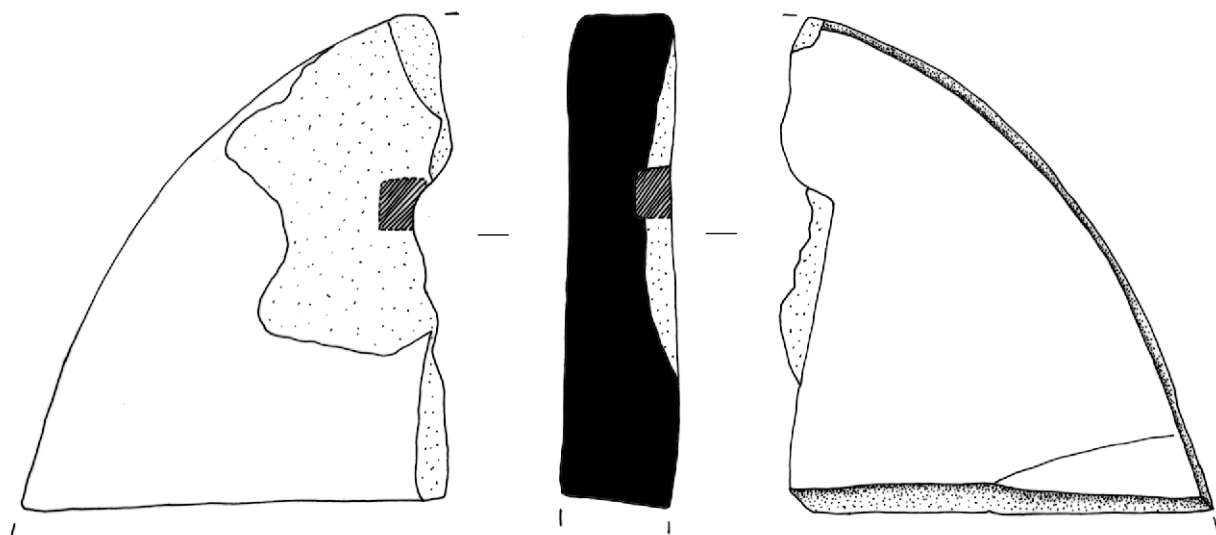

251

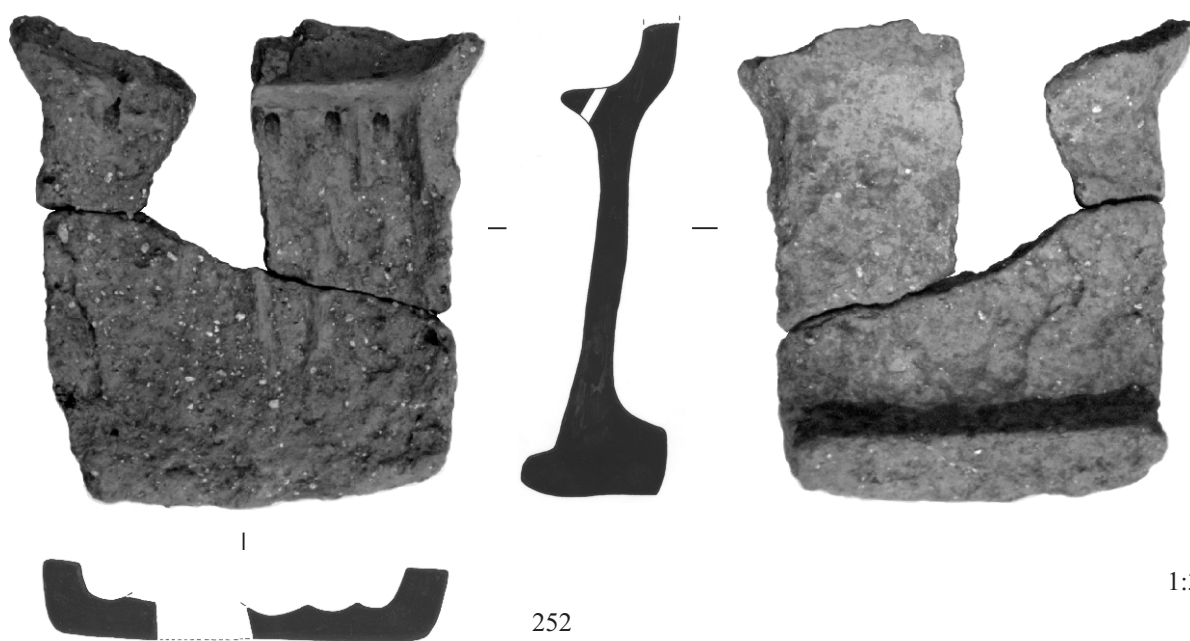

252

1:3



253

1:2

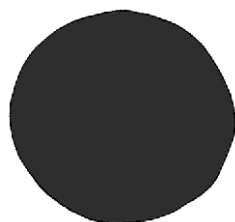

257

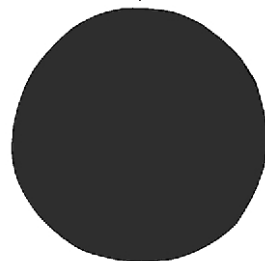

258



255



259



260



261

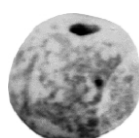

262

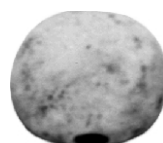

263

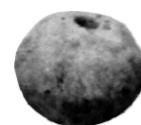

264



267



268a



268b

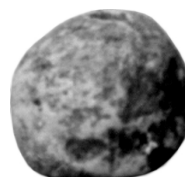

268c

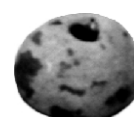

272



318



340



350



364



368



373

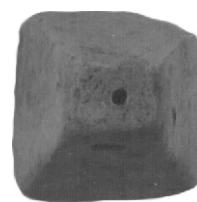

375

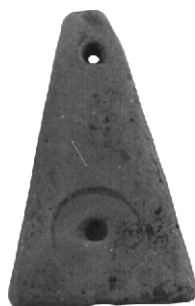

377



385



403



418

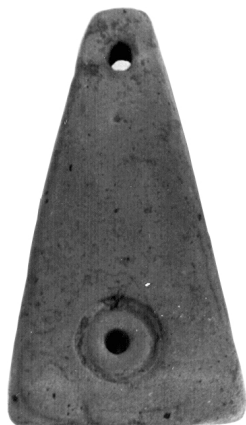

420



430



442



453b



455a



458



579



497



503b



504



506b



523



520b



524



539



540a



542



544



545



546



557

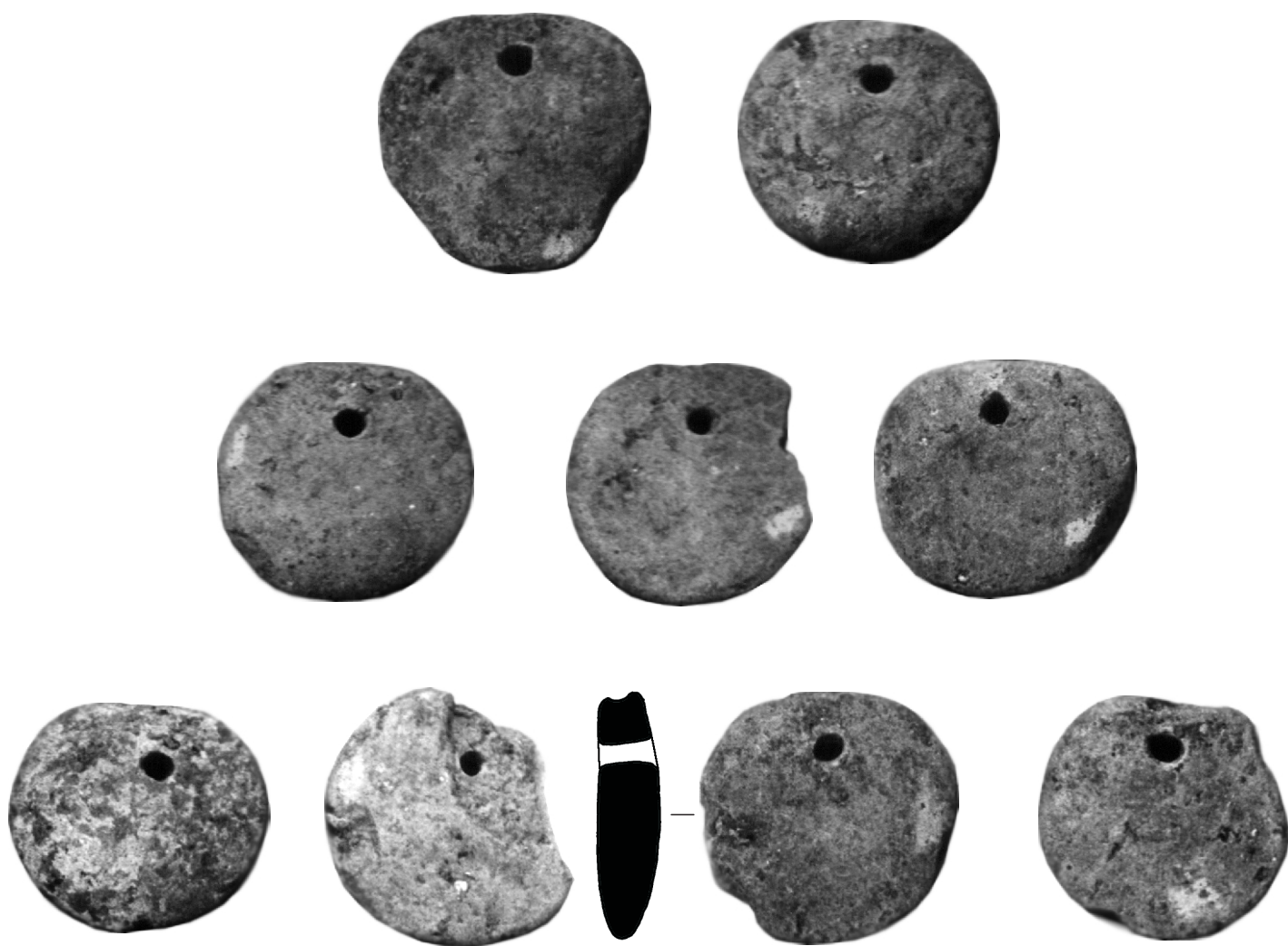

443d bis 443 l

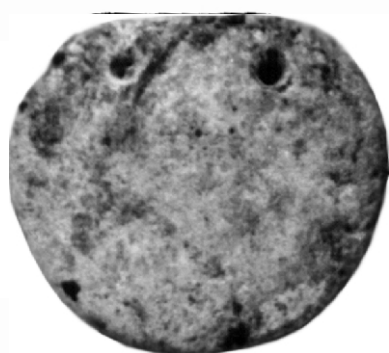

450

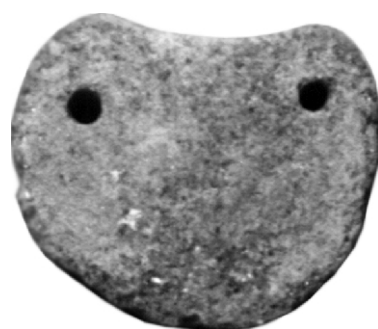

583



585



591



2:3



592



593



594



595



598



599



602



603



604



610



611



613



615



616



617



618



619



622



623



624

2:3



621



631



632



649



1:1



650



652



651



653



657



656



661



662



663



664



665



669



666



671



672

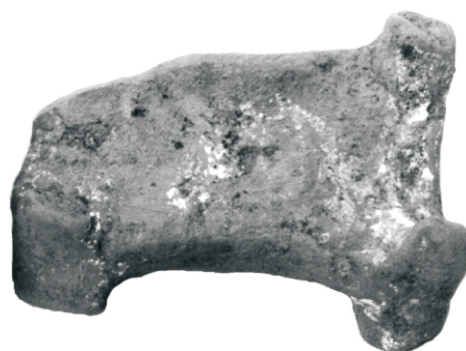

673



675



678



674



681



680



682



684



687



686

688

689

690



692



694



695



691



696

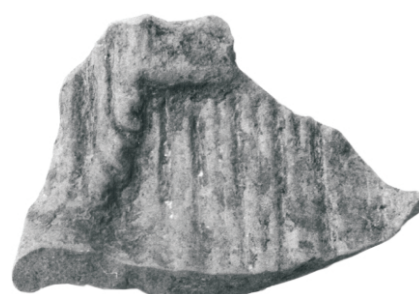

698



697



699



702



703



704



705



706



707



708



709



710



711



700



714



712



715

2:3



719

1:1



717



718

2:3



723



724



725

1:1



730



731

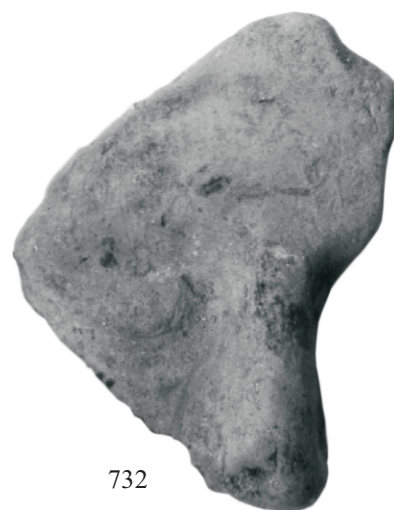

732



733



735



736



737



763



764



766



767



769



768



770



780

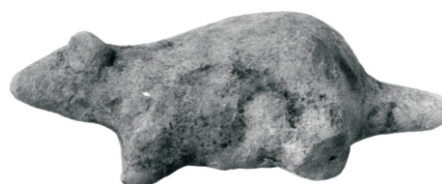

781



782



783



786



787



788

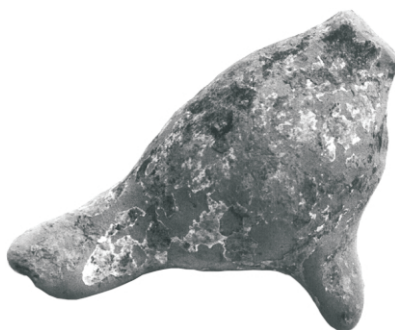

789



791



792



793



794



796



797



795

1:1



827



828

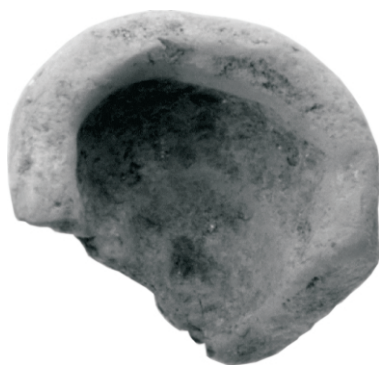

829

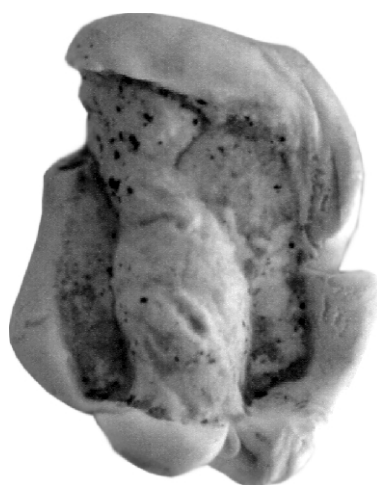

831



830



832

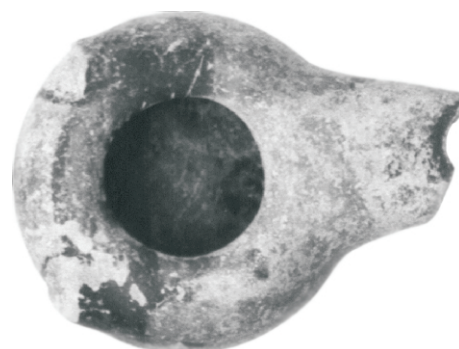
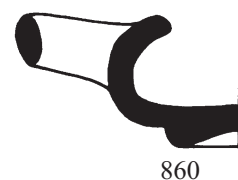
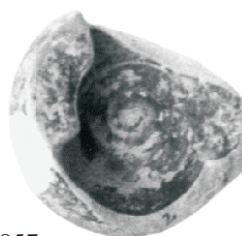
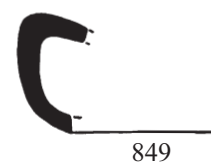
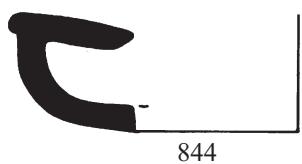
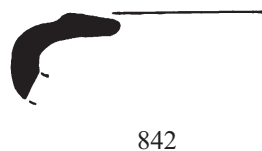
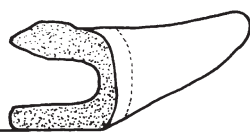

858



861

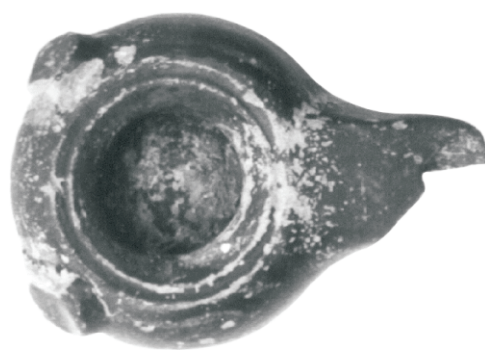

862



863

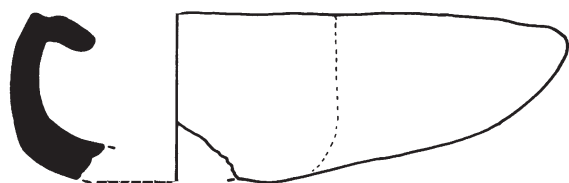

864

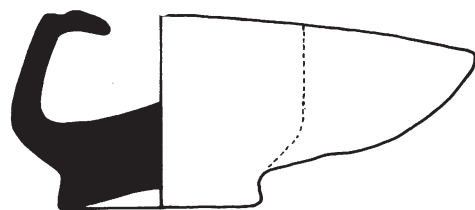

868

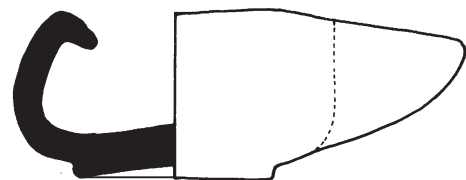

870



872

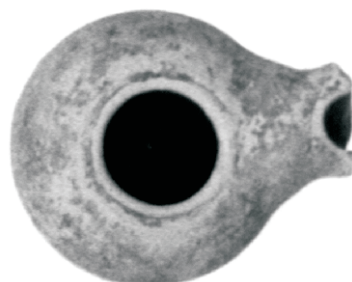
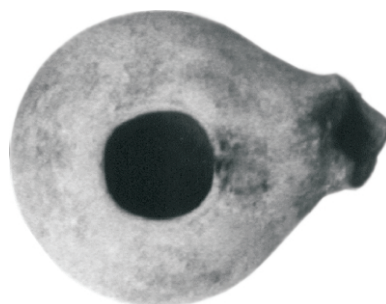
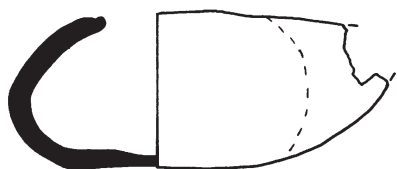
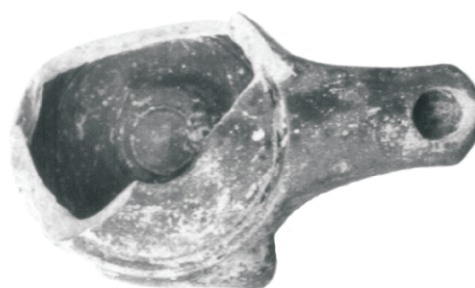
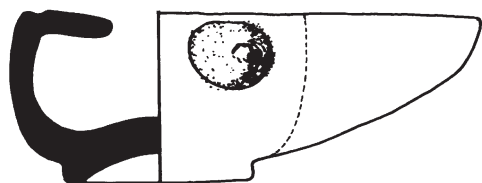
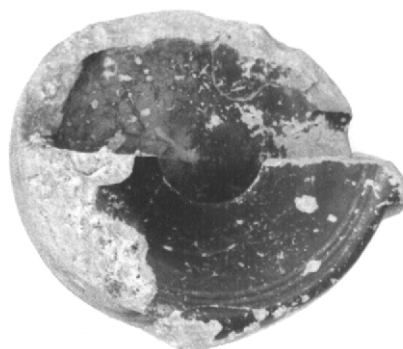
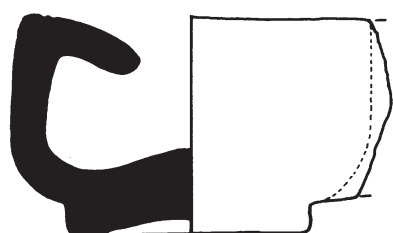
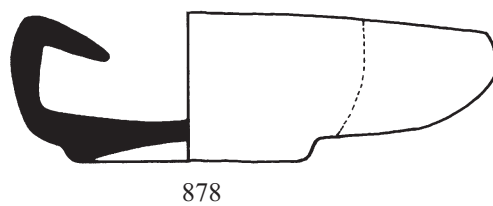
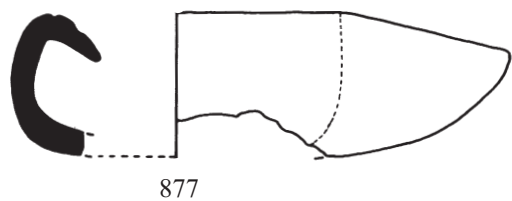

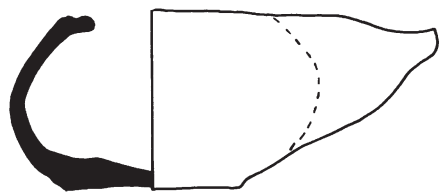

897



898

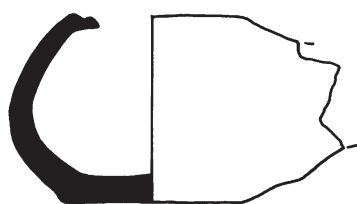

899

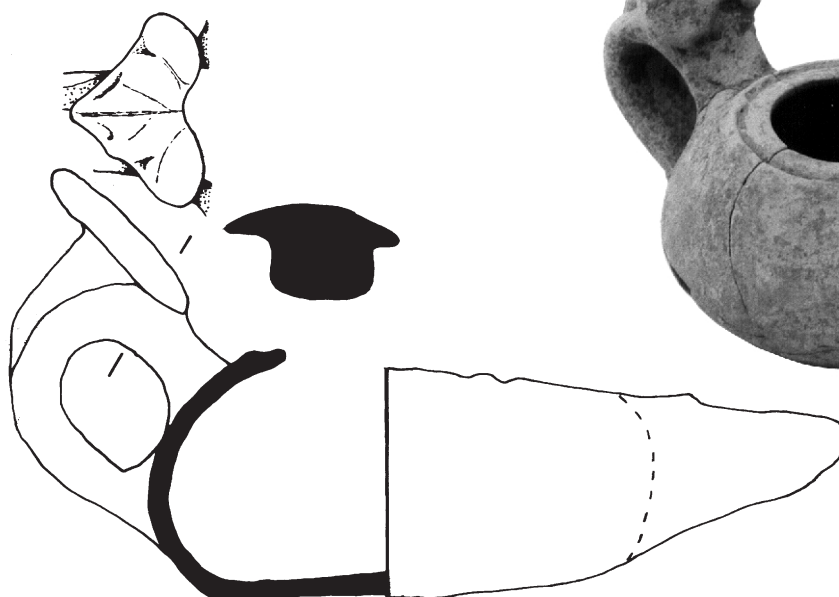

900



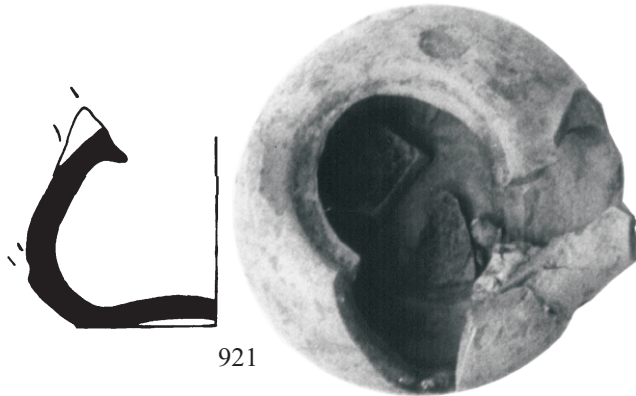
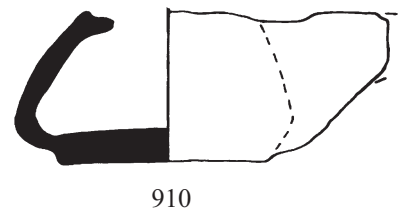
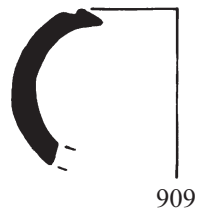
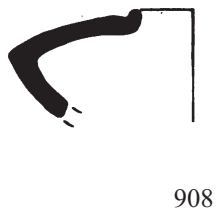
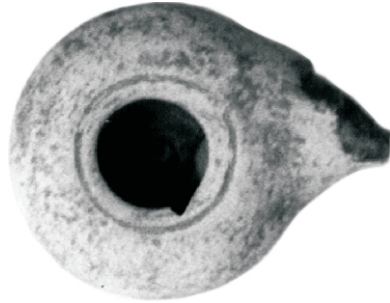
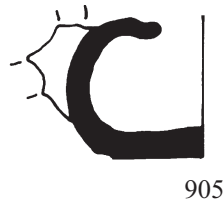

921

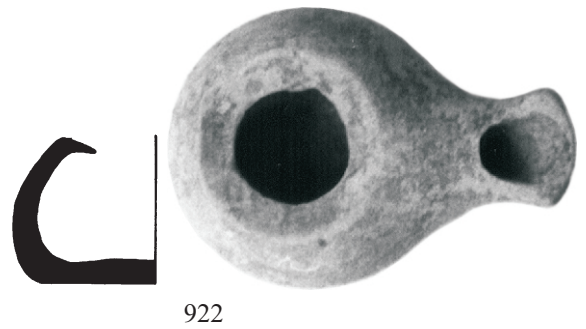

922

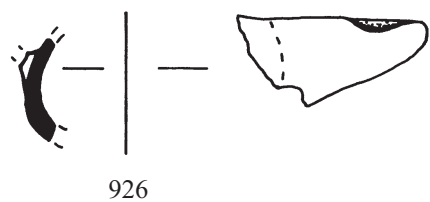
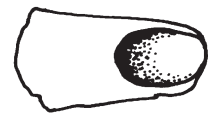
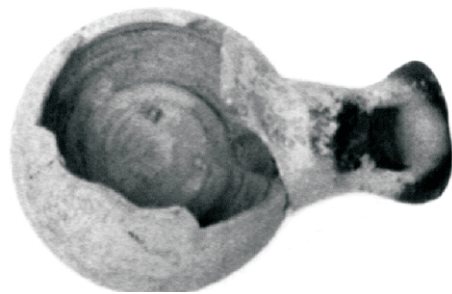
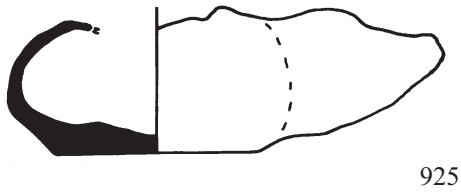

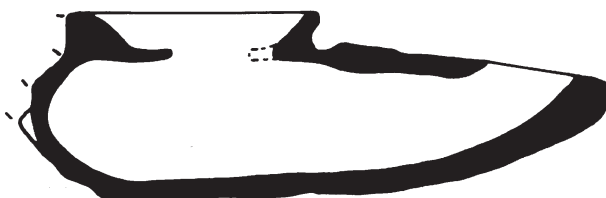
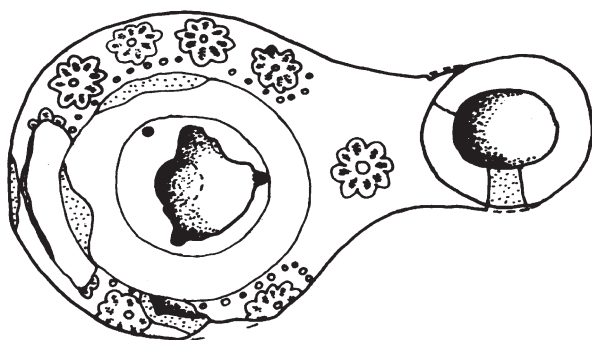

927

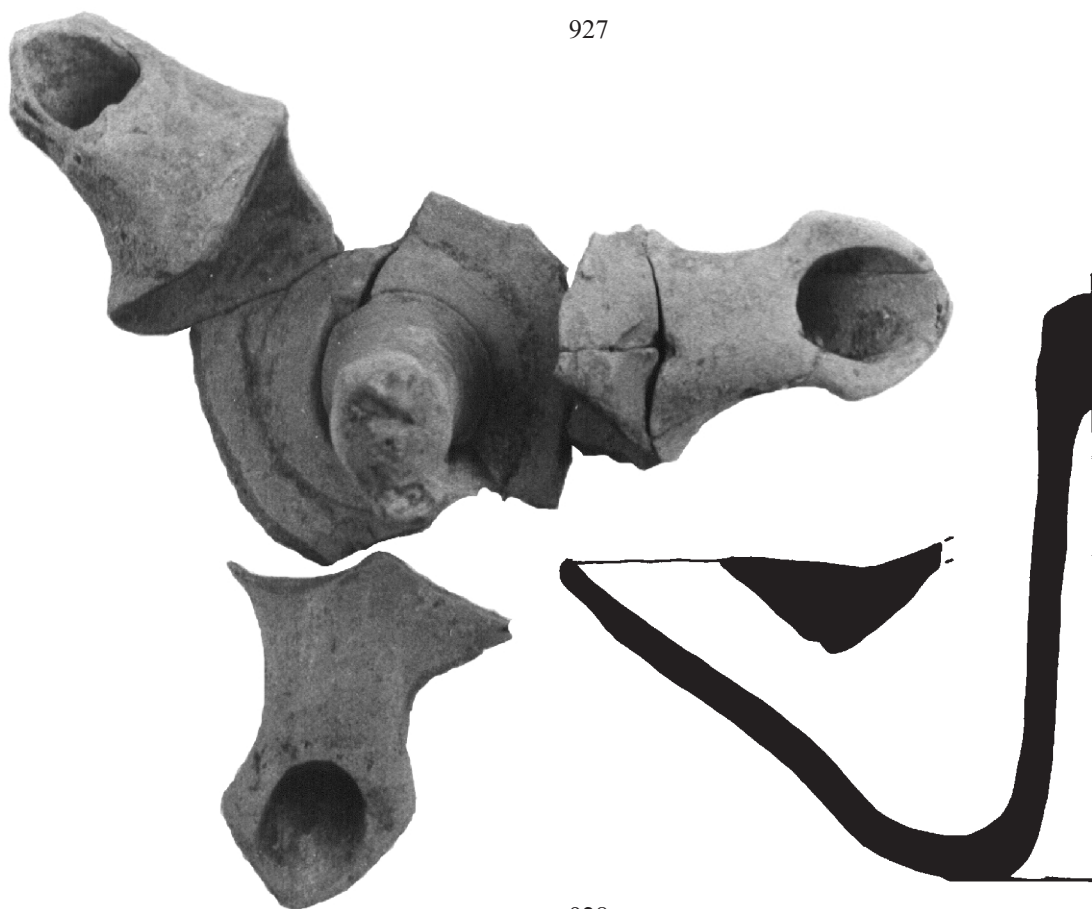

928

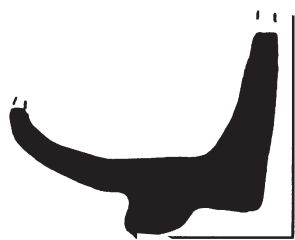

931



932



933



934

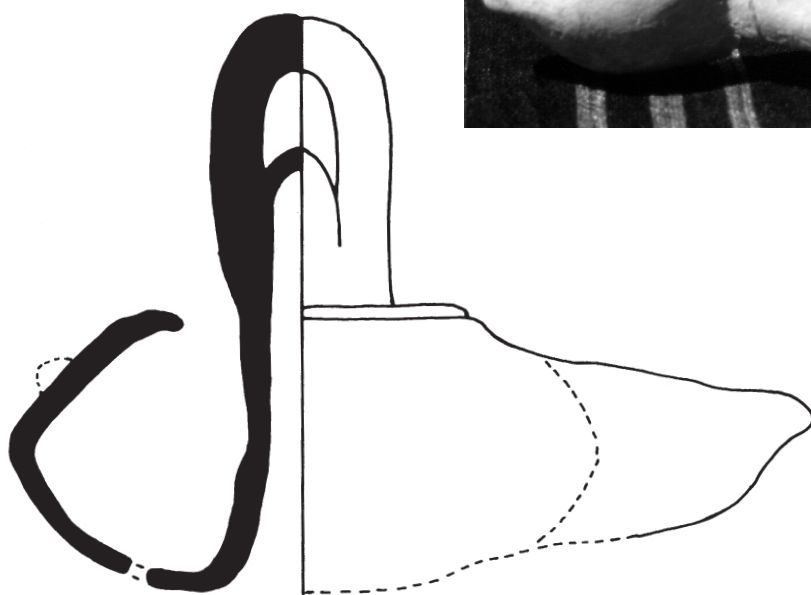

929

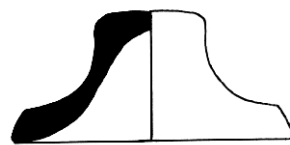

936

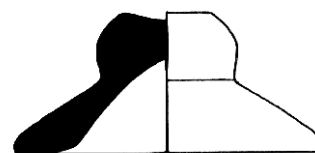

935

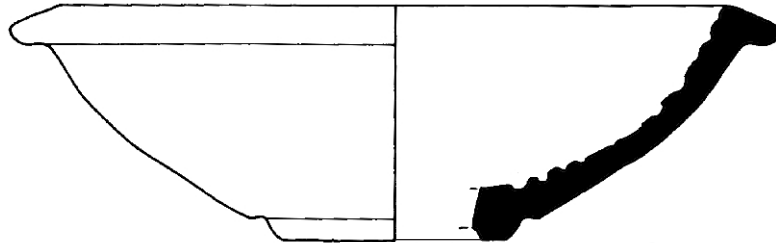

978, 979

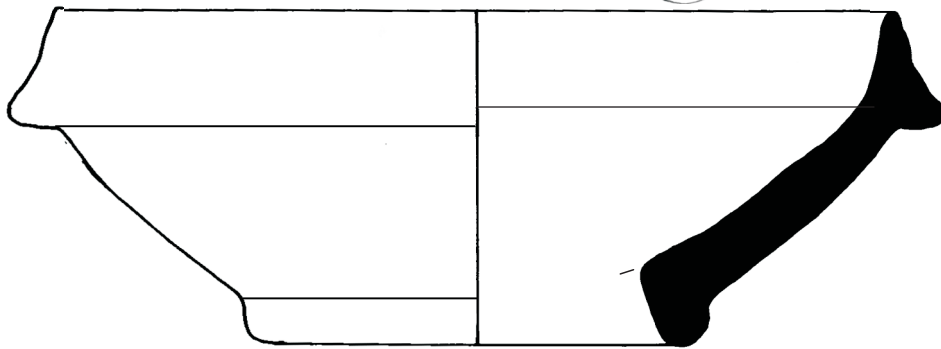
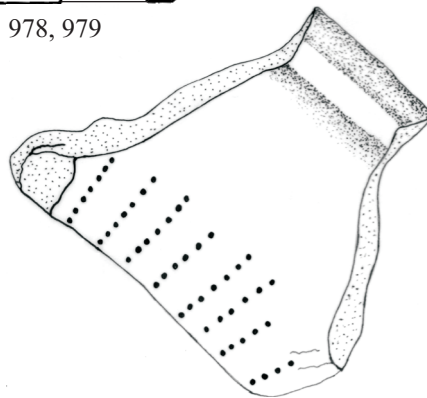

980

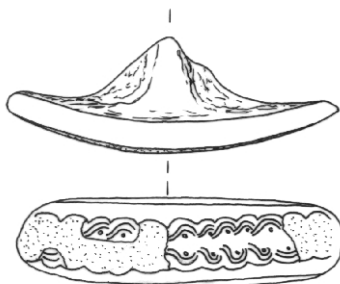

981



991



988



989



990





982

1:2

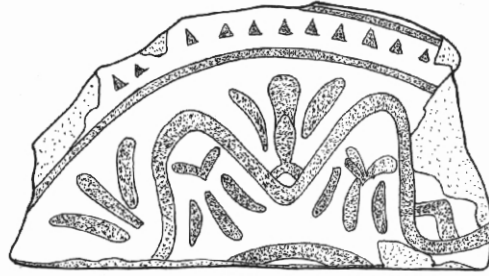

983

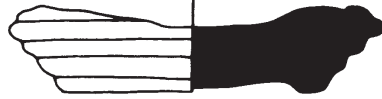

984



986



985



2:3

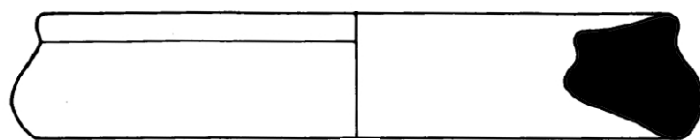

993

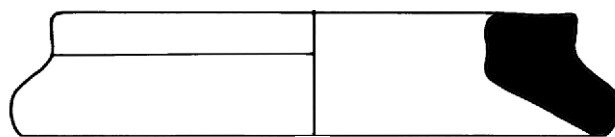

996

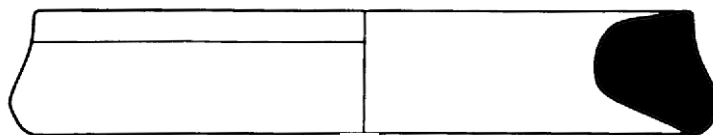

997

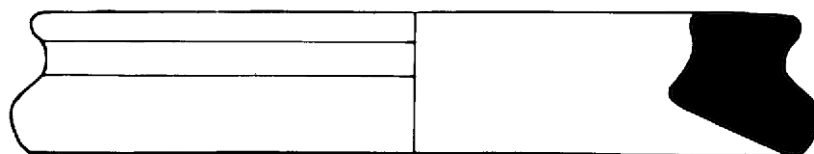

1008

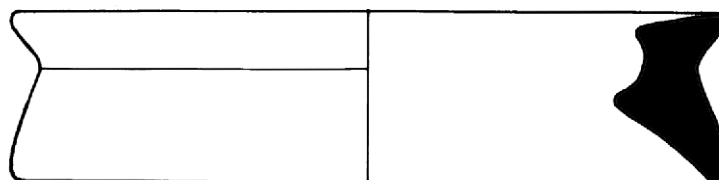

1016

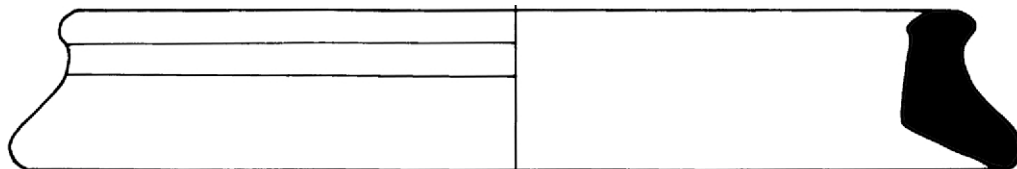

1020

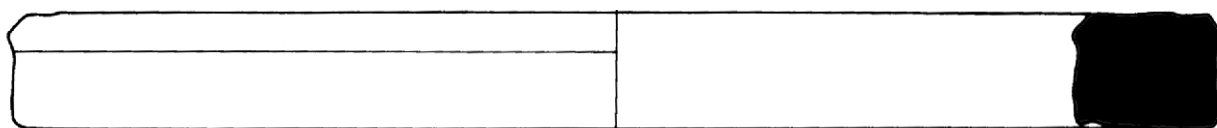

1022



1024

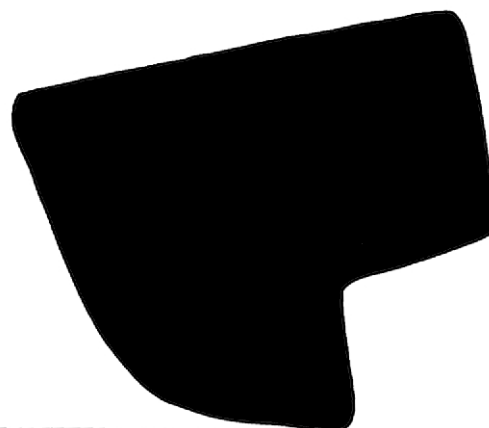

← Ø 44 cm

1023



1027

1:1



1025

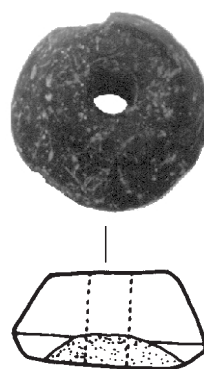

1026

2:3



← Ø ca. 50 cm

2:3



1028

← Ø ca. 41 cm

1:6



1029

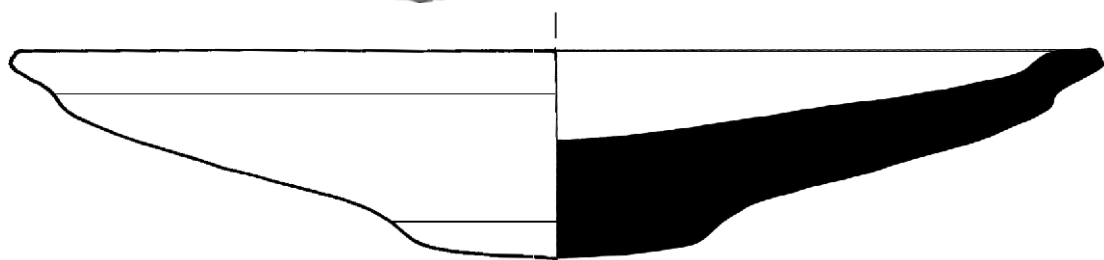
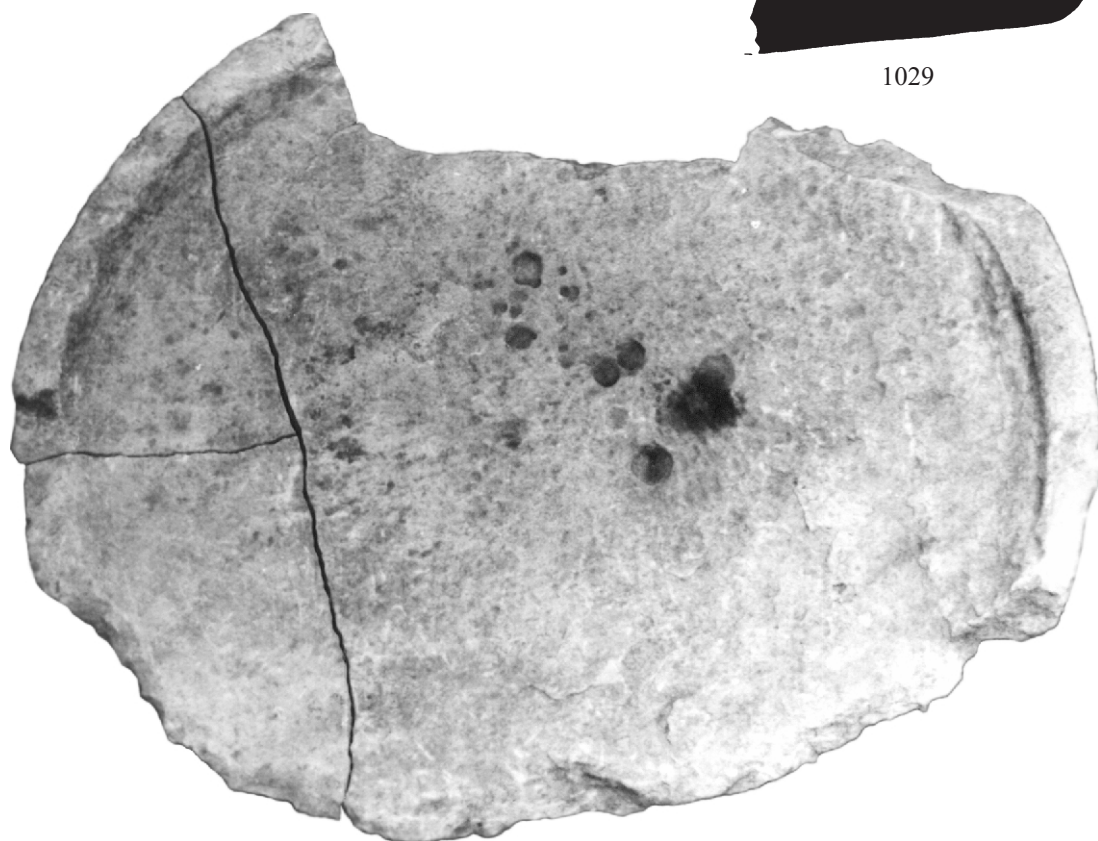

1030

1:6

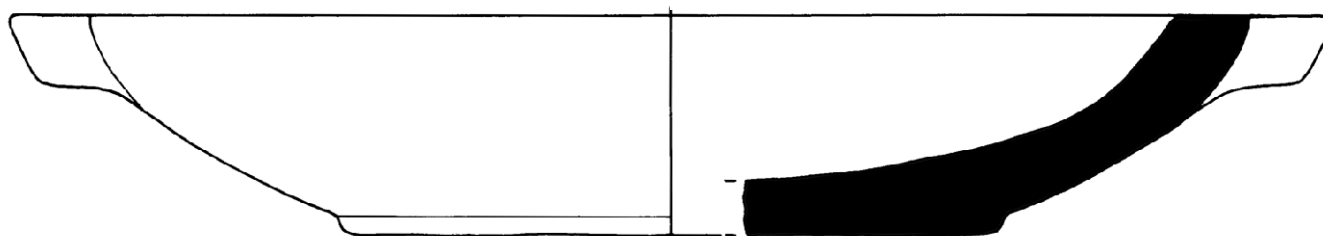

1031

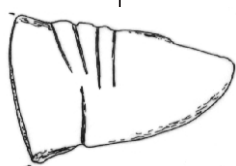
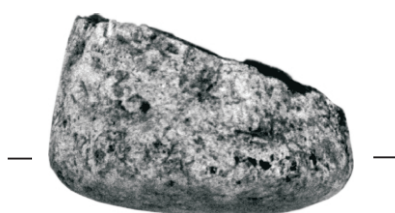

1032

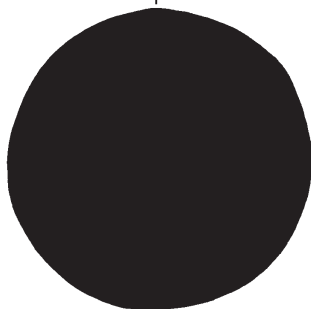

1033



1034

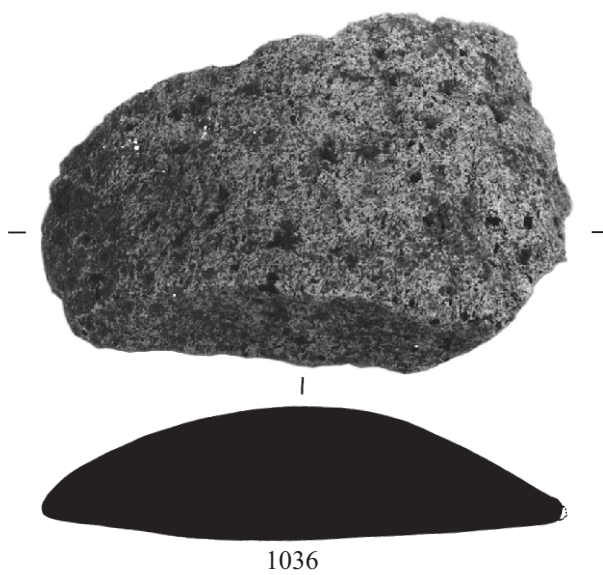

1:2

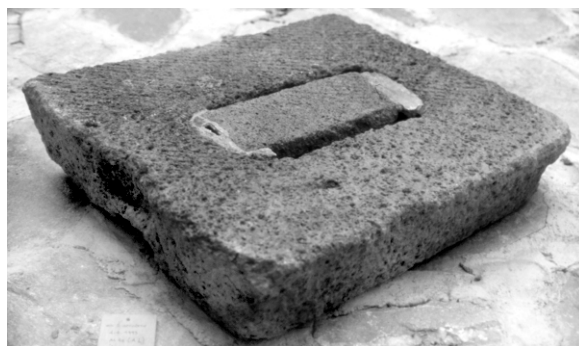

1037

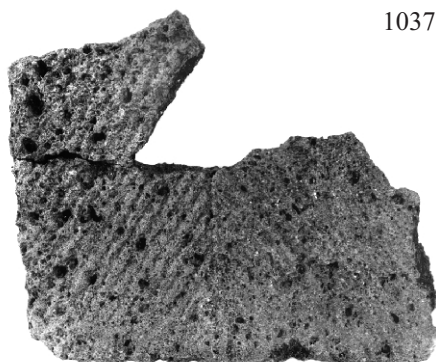

1042



1043

1:5

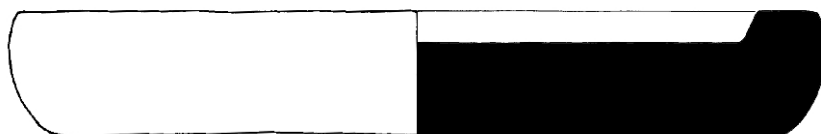
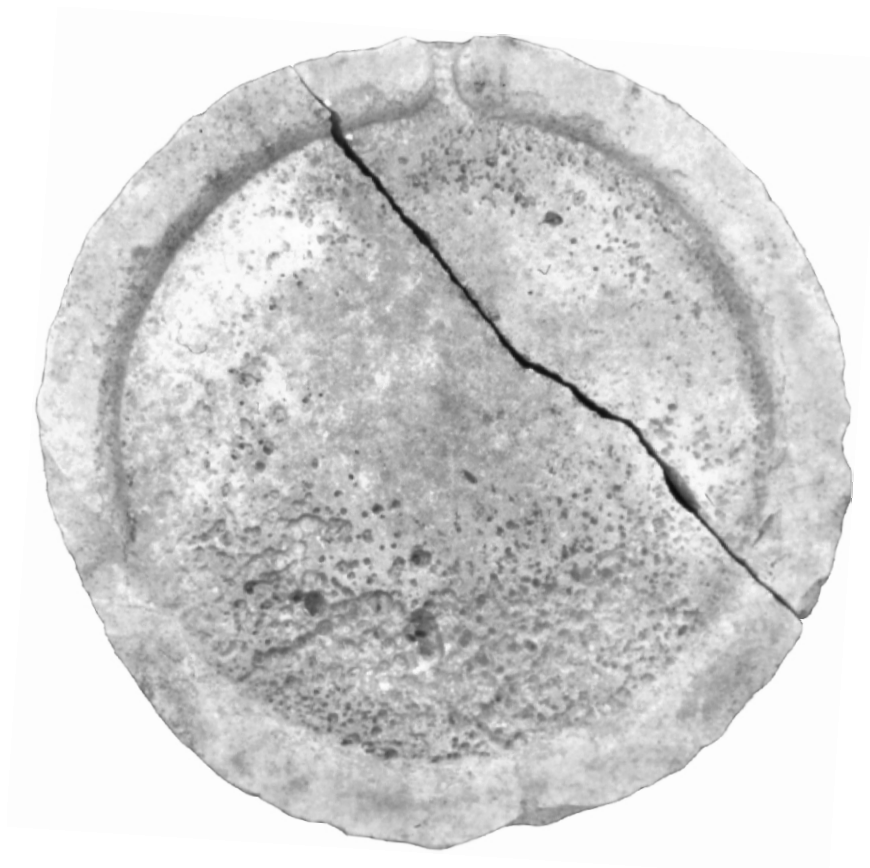

1044

1:4

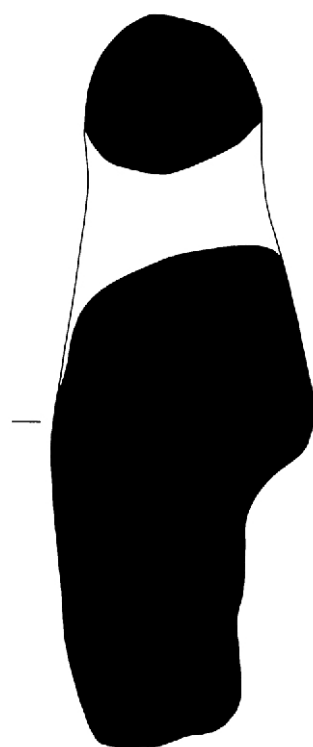

1047



1045



1046



1048



1049

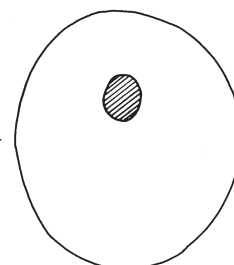

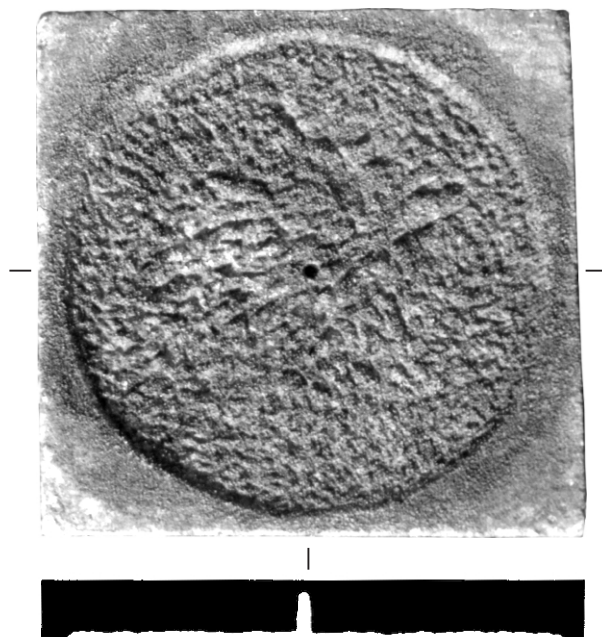

1051

1:4



1050

1:1



1052

1:2

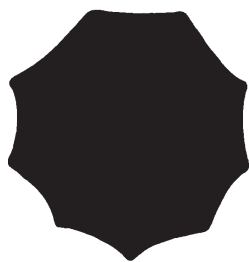

1053

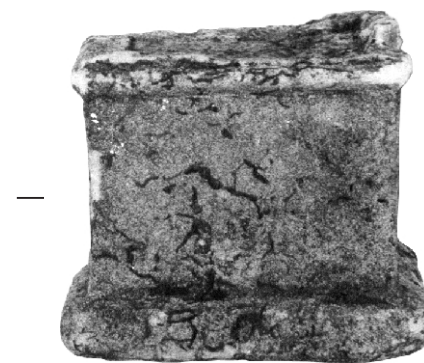
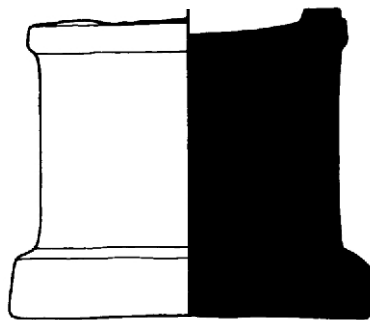

1054

2:3

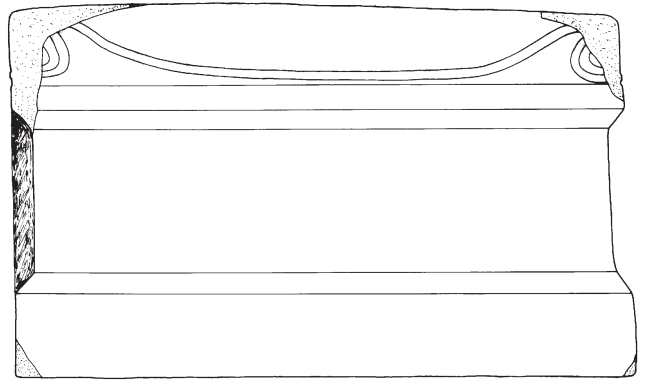
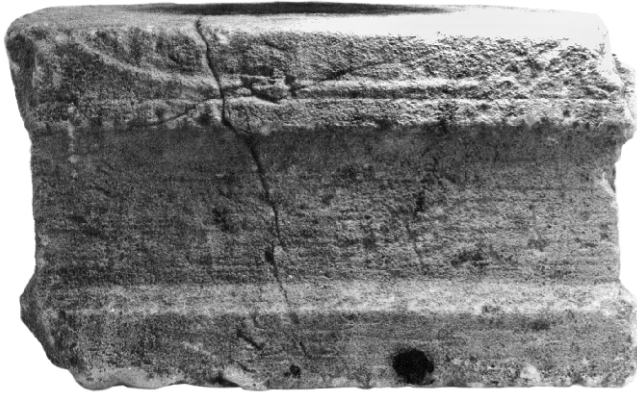
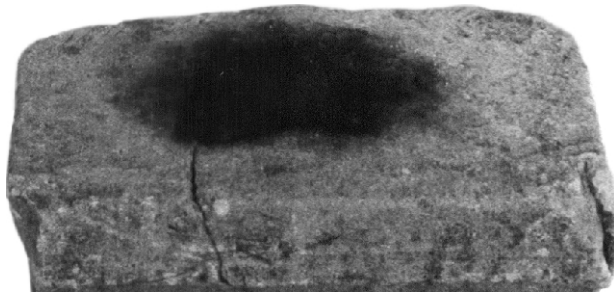

1055

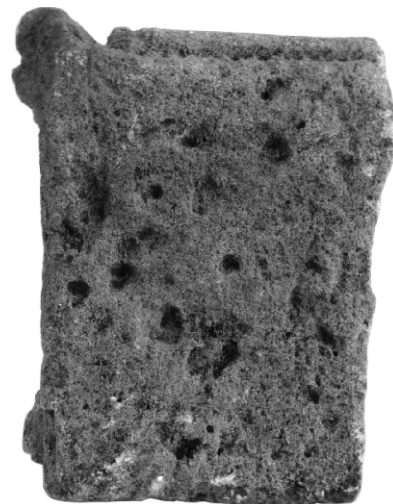

1056

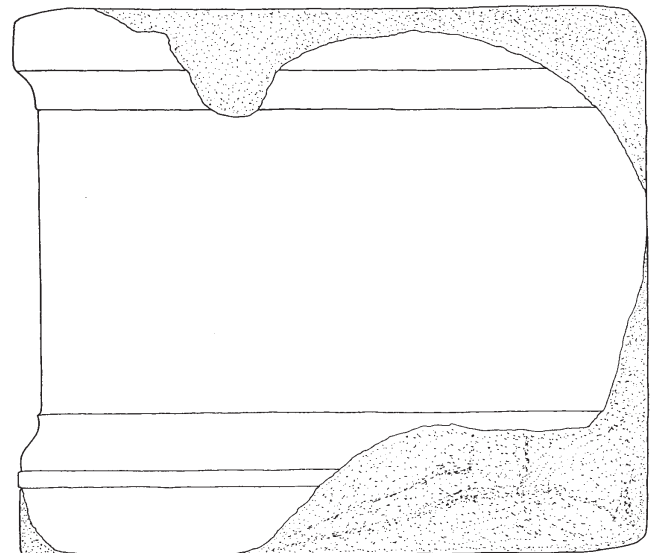
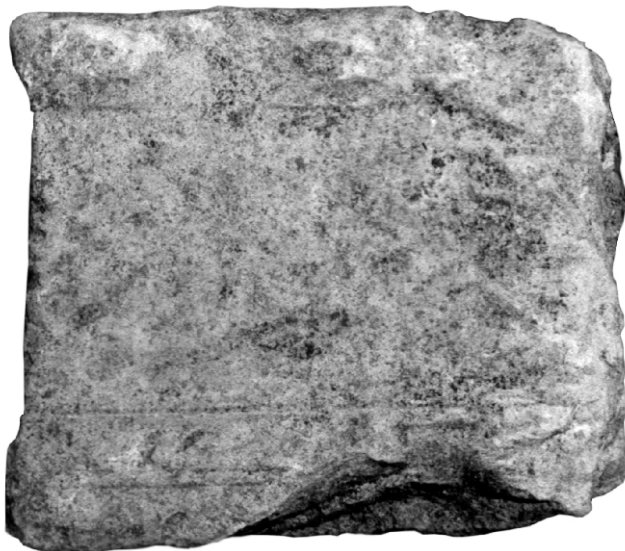

1057

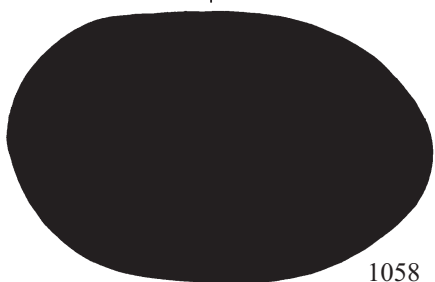

1058



1059



1064



1062



1060



1063

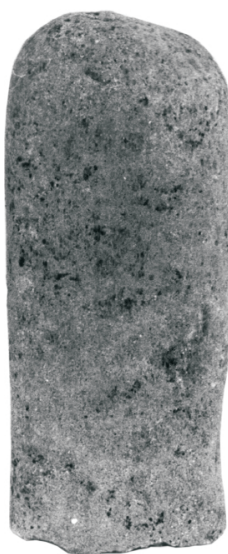

1061

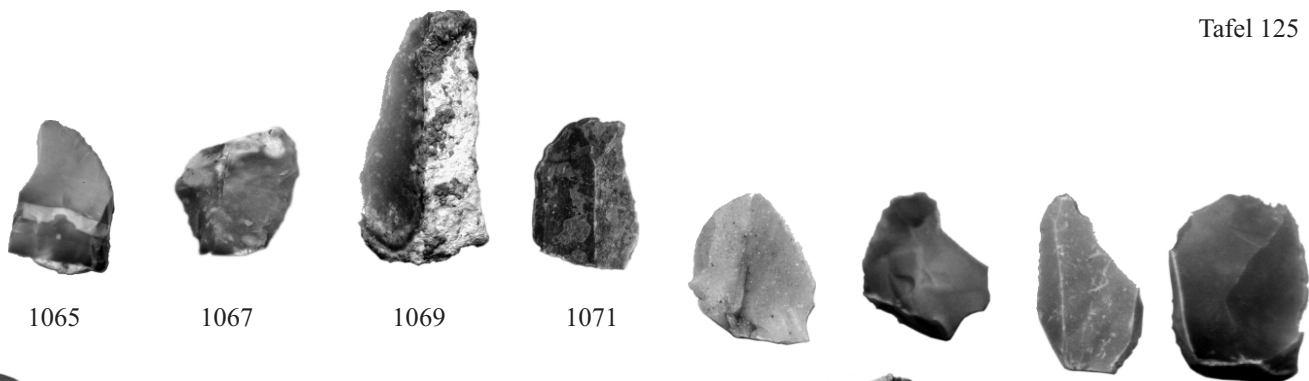

1065

1067

1069

1071

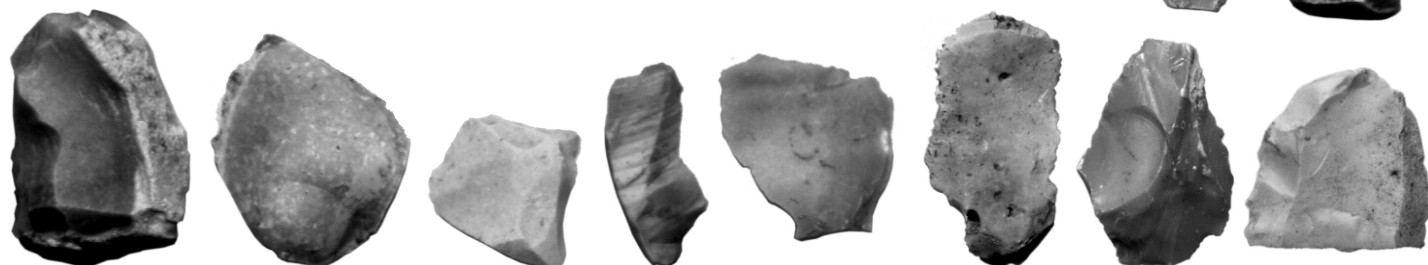

1072

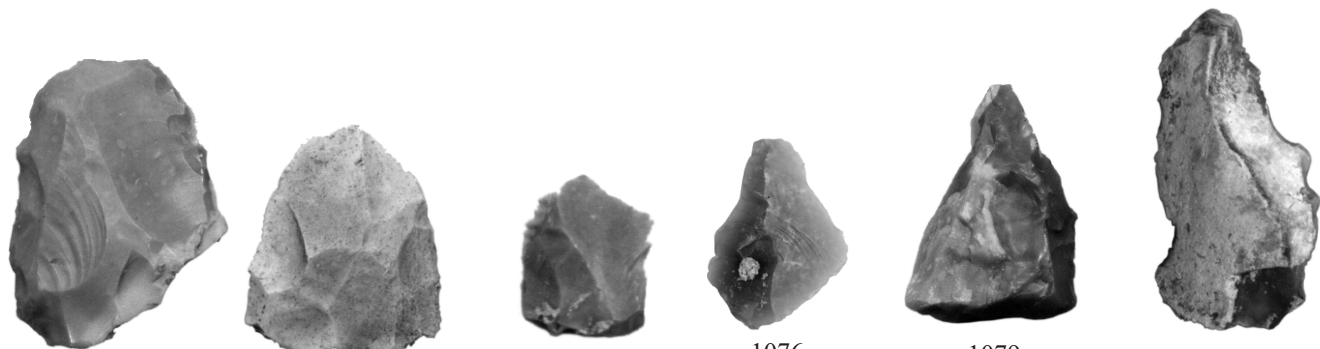

1073

1074

1076

1079

1080

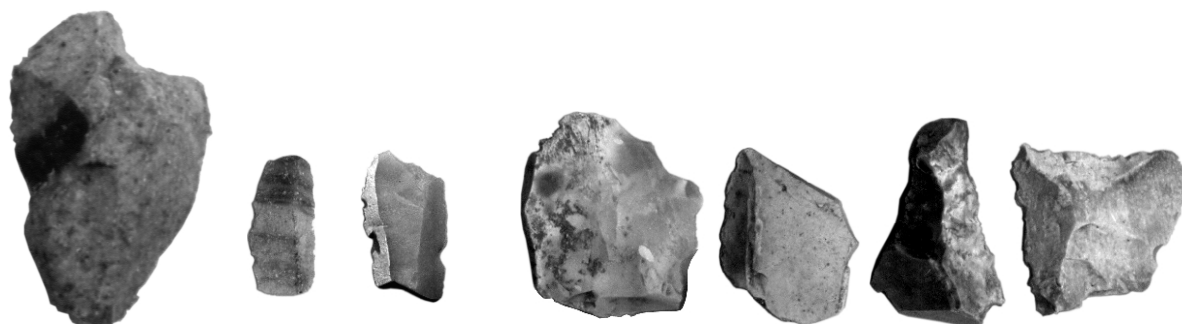

1081

1082

1083

1087



1091

1092

1093

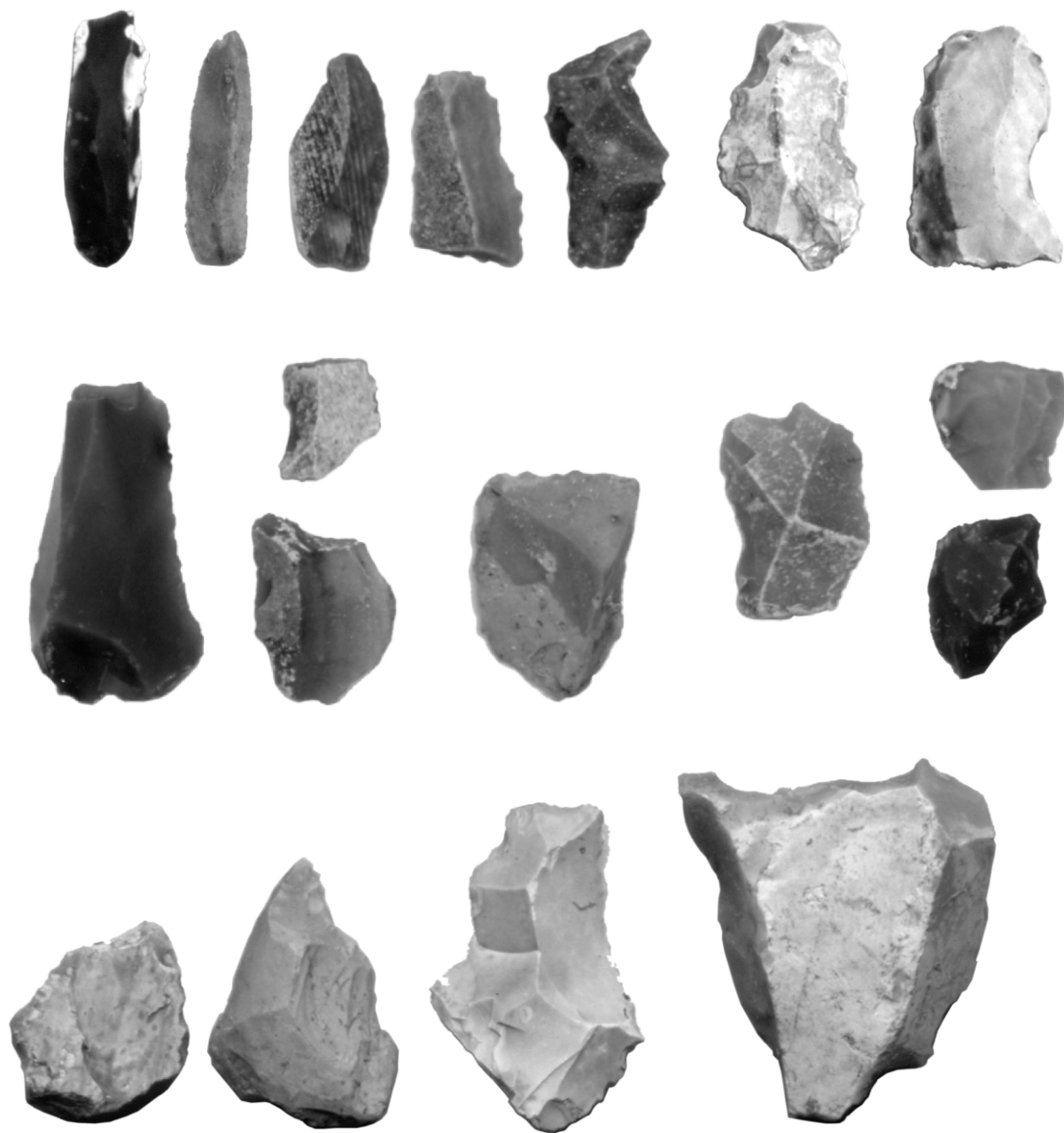

1095



1096

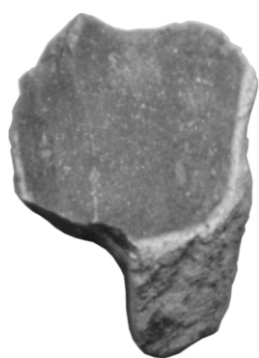

1097



1098

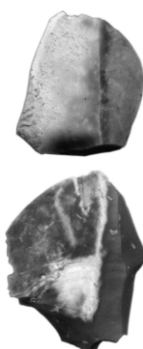

1099



2:3

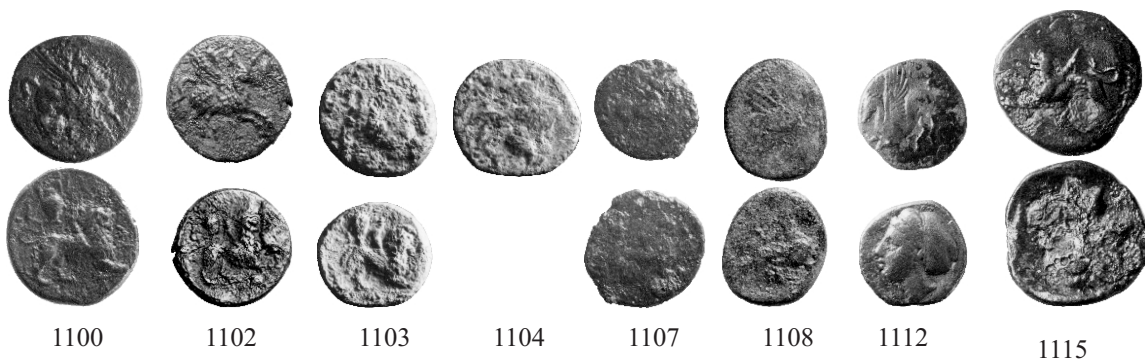

1100 1102 1103 1104 1107 1108 1112 1115

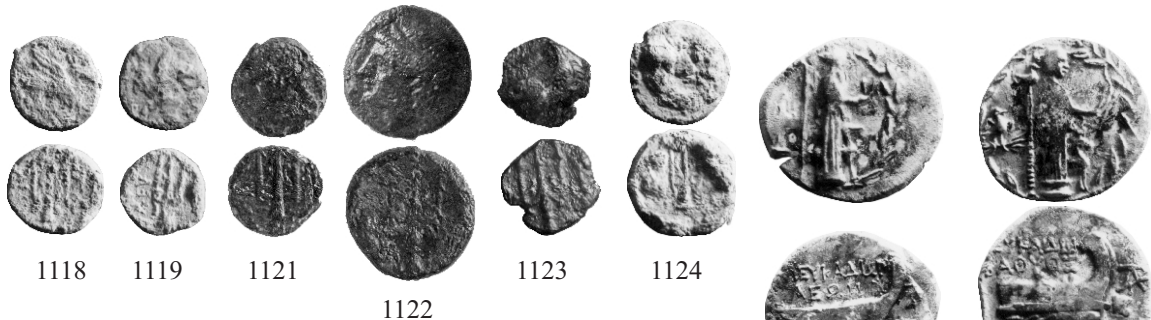

1118 1119 1121 1122 1123 1124

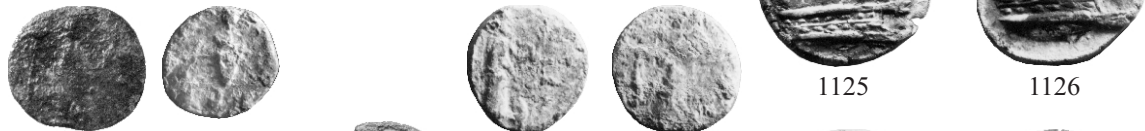

1125 1126

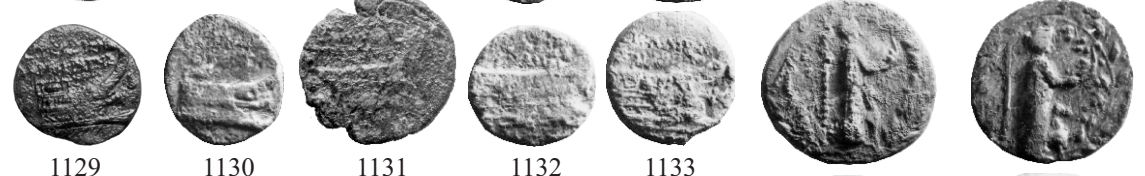

1129 1130 1131 1132 1133



1127 1128



1134 1135 1136 1137



1149 1139 1140 1148 1153 1155 1157 1158



1159 1162 1165 1168 1169 1175 1176 1185 1187



1161 1170 1174

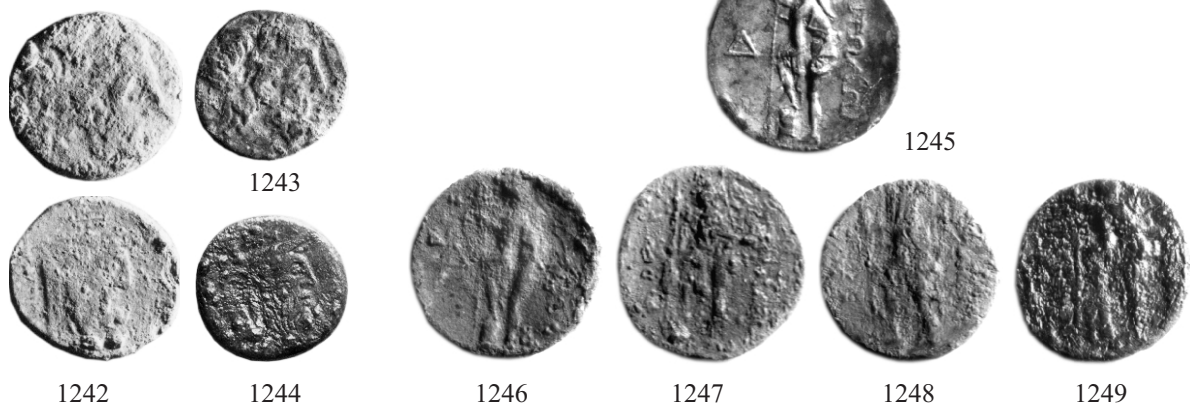
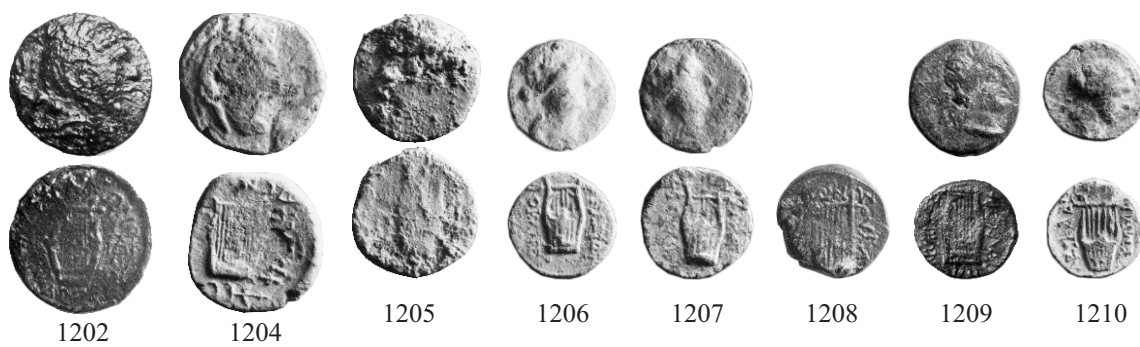

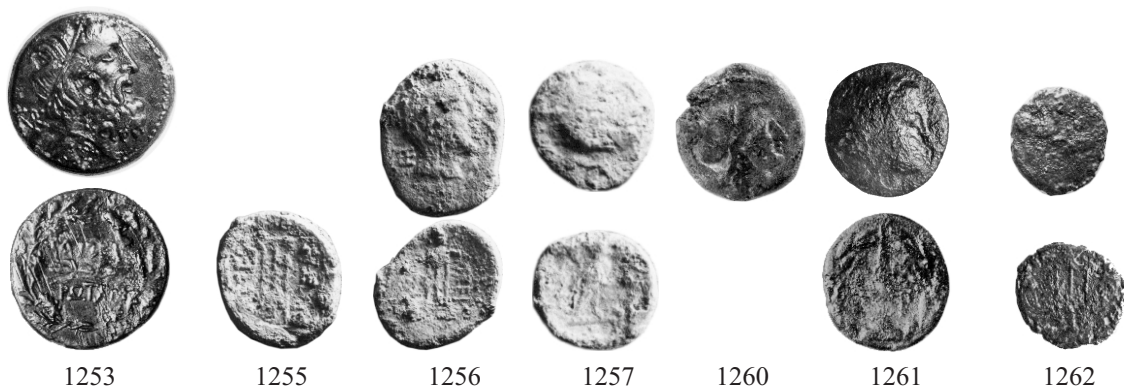

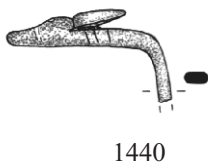
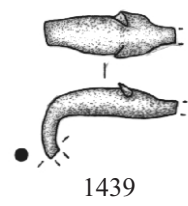
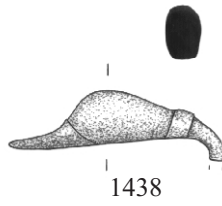
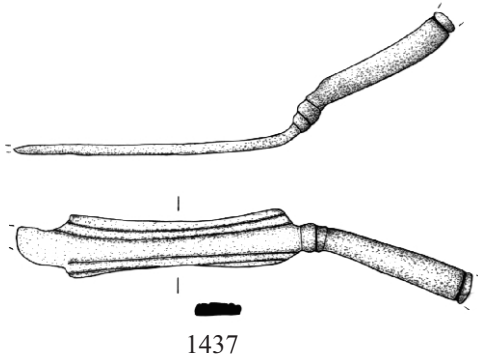
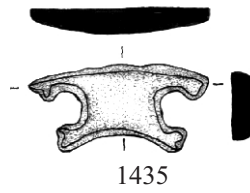
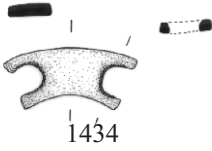
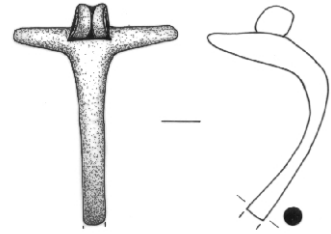
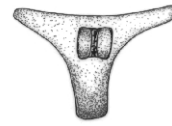
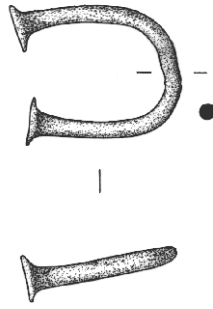
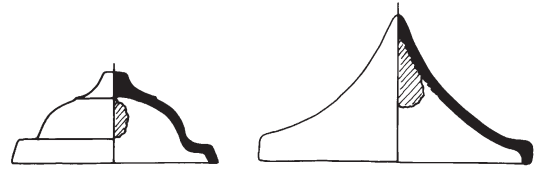
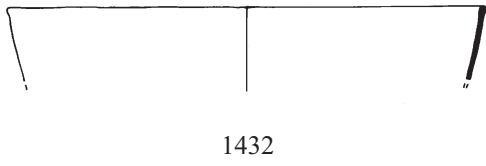

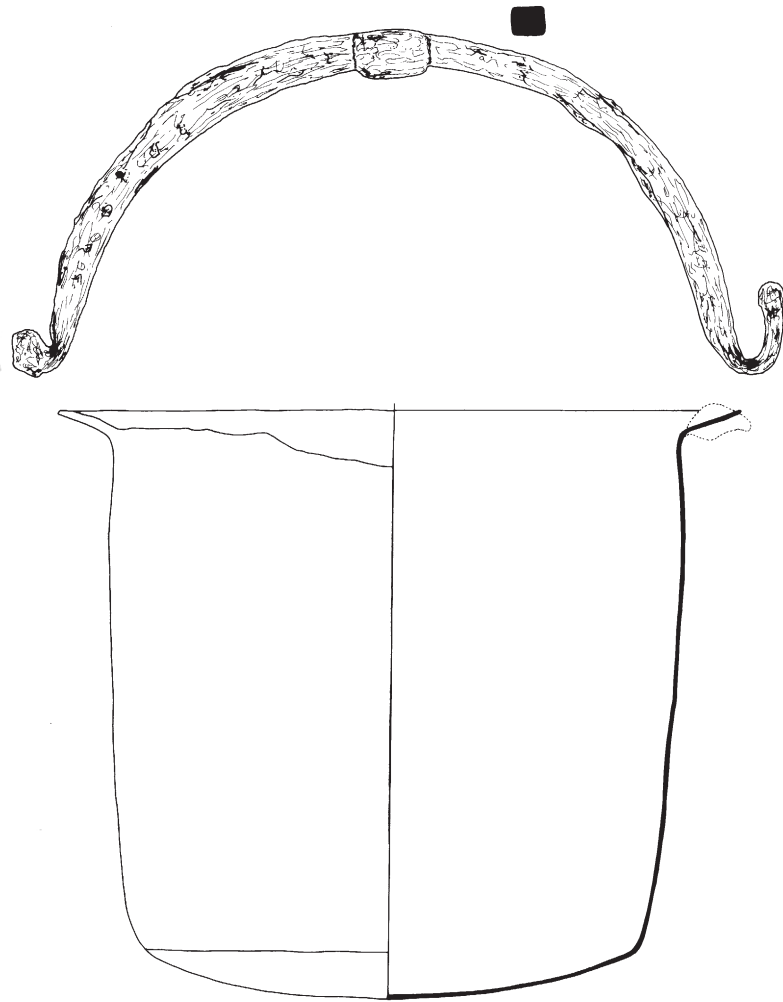

1442

1:2

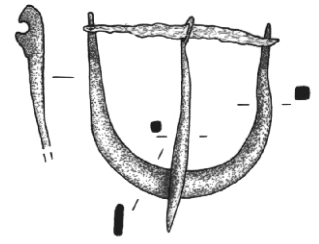
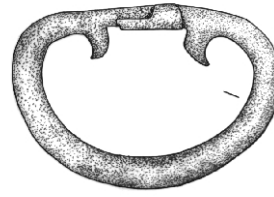

1446

1448

1450

1451

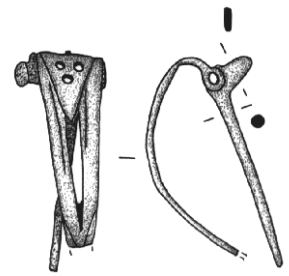
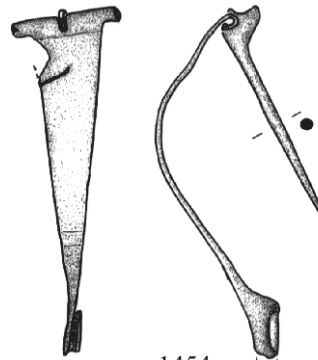
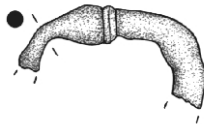
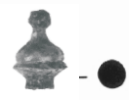

1443

1453

1454

1455

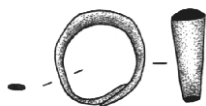

1456

1460

1459

1457

1458

1462

1463

1461

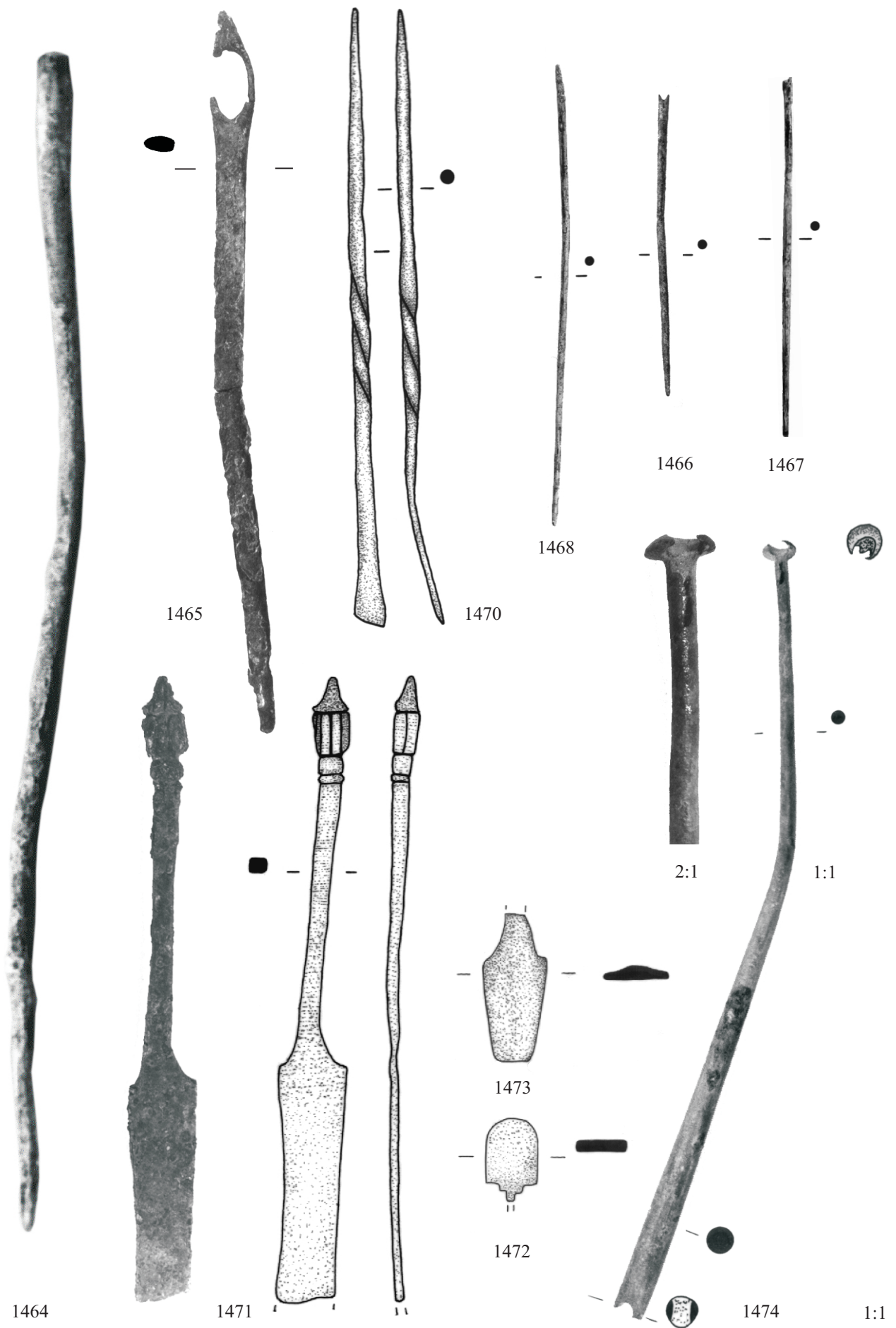

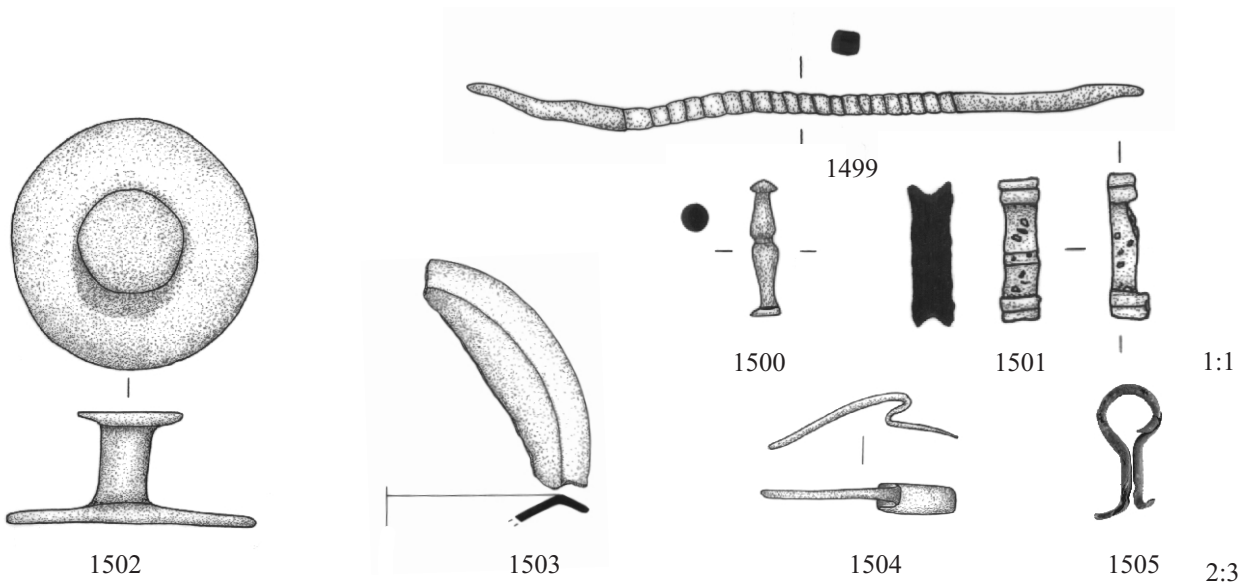
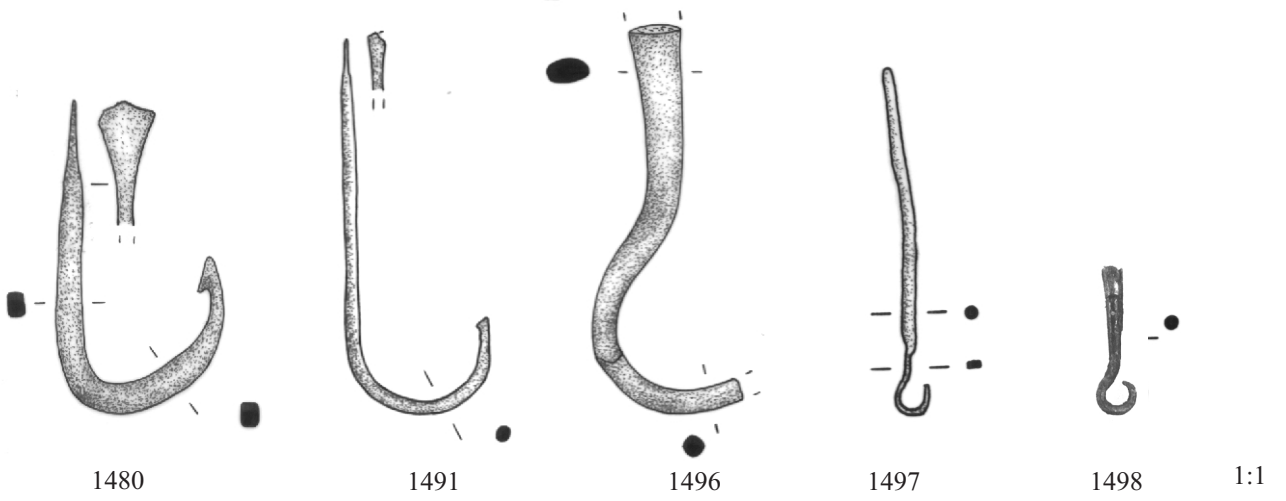
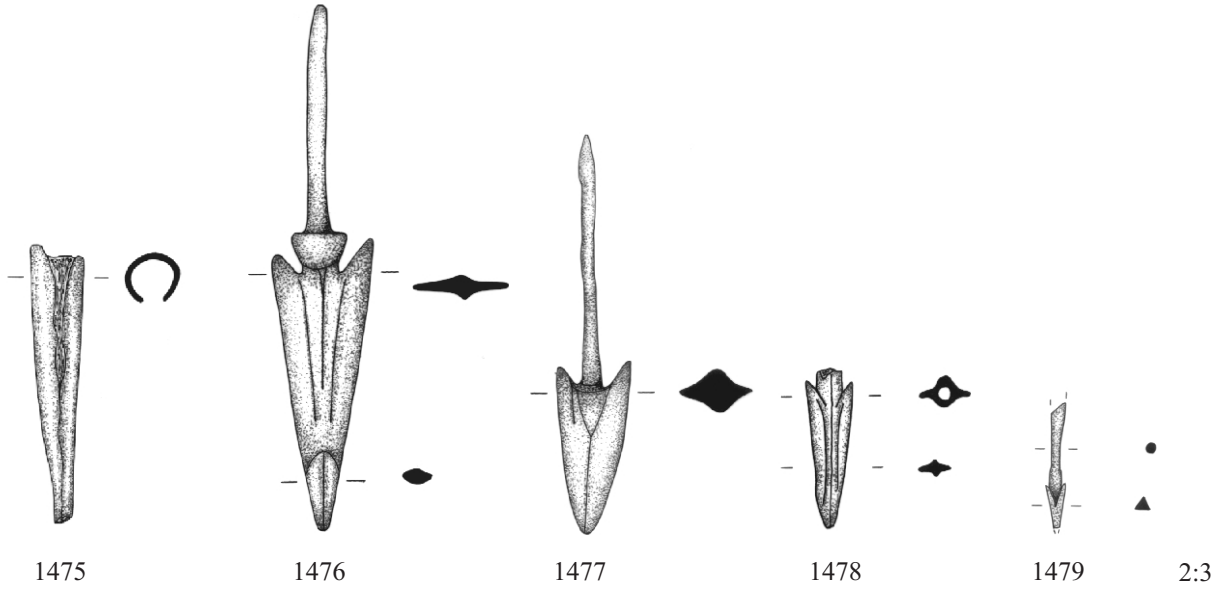

Bronzenägel

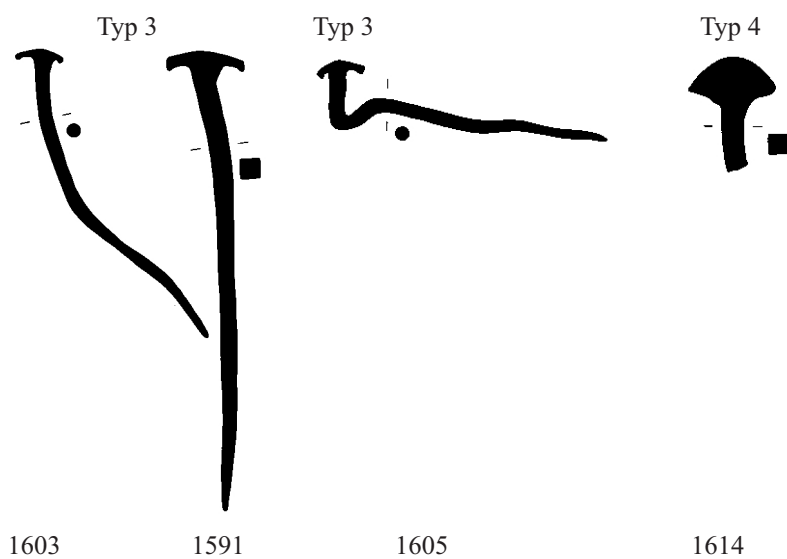
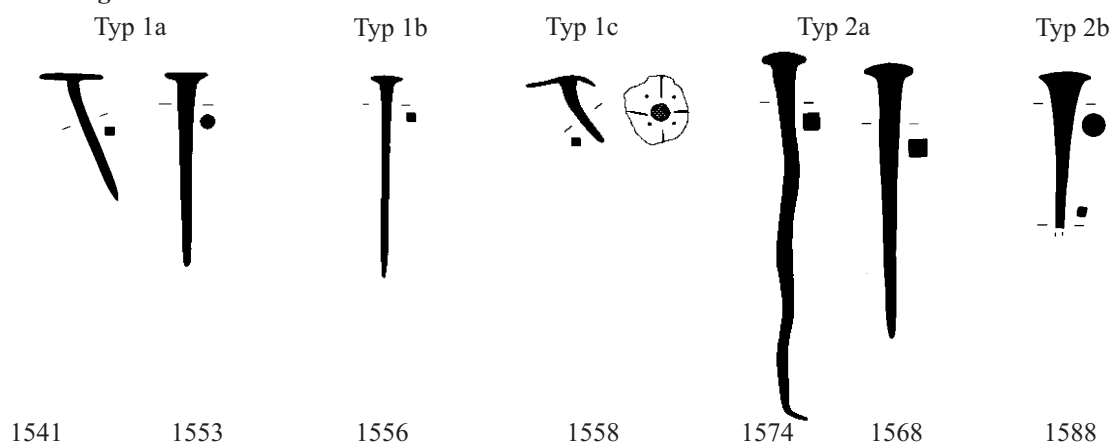

Eisennägel

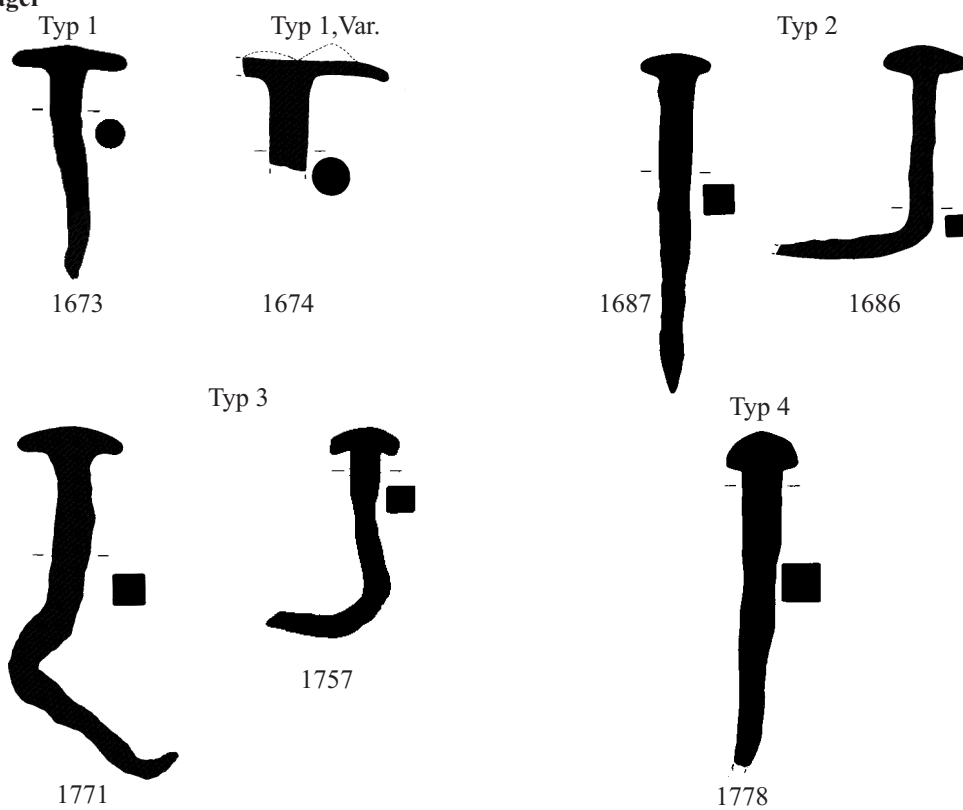



1855



1858



1856

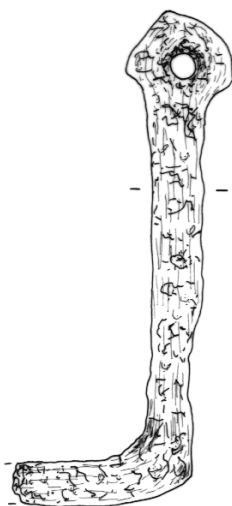

1857



1860



1859



1861

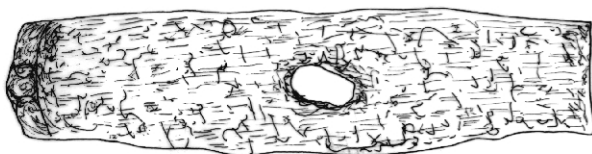

1862





1863

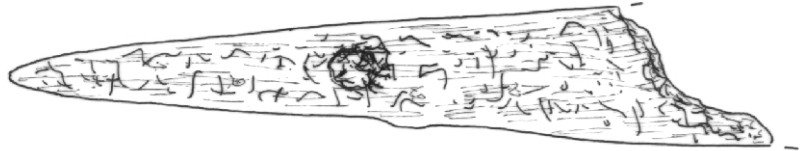

1864



1865



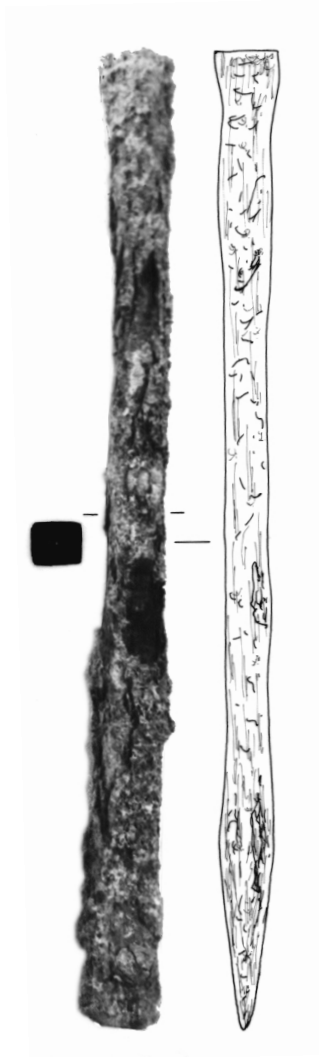

1866

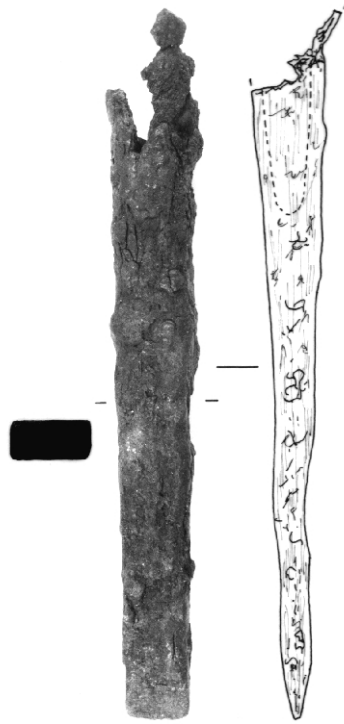

1867



1868

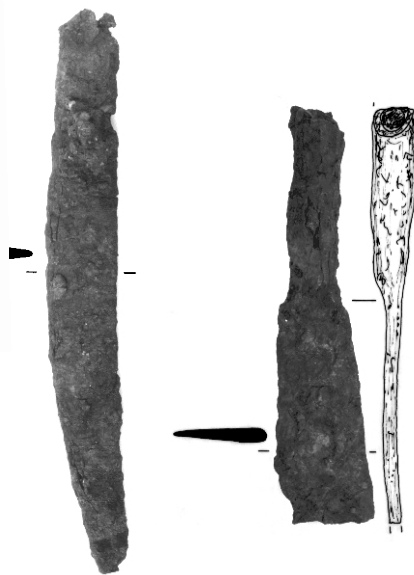

1869

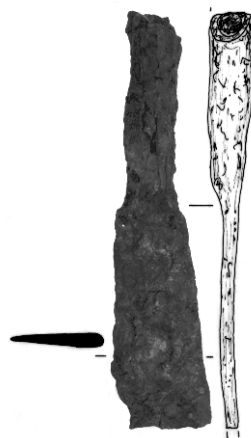

1870

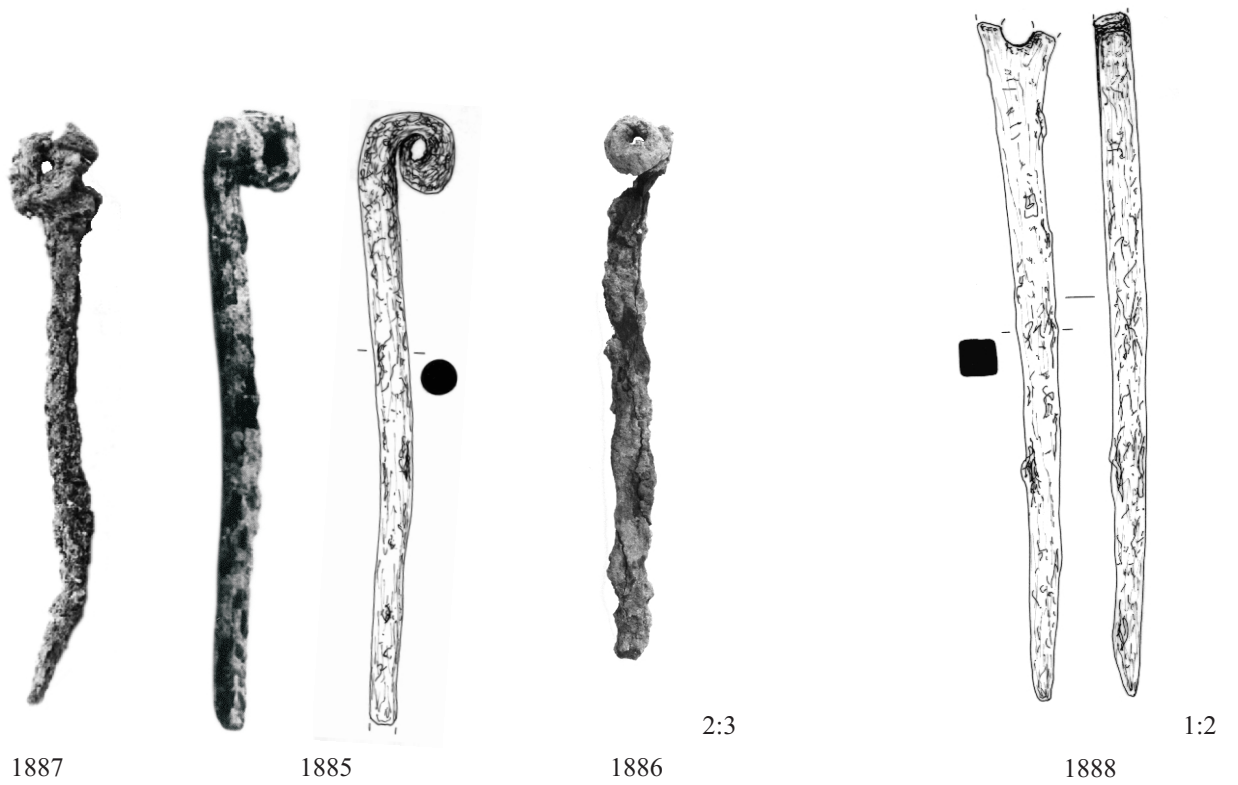
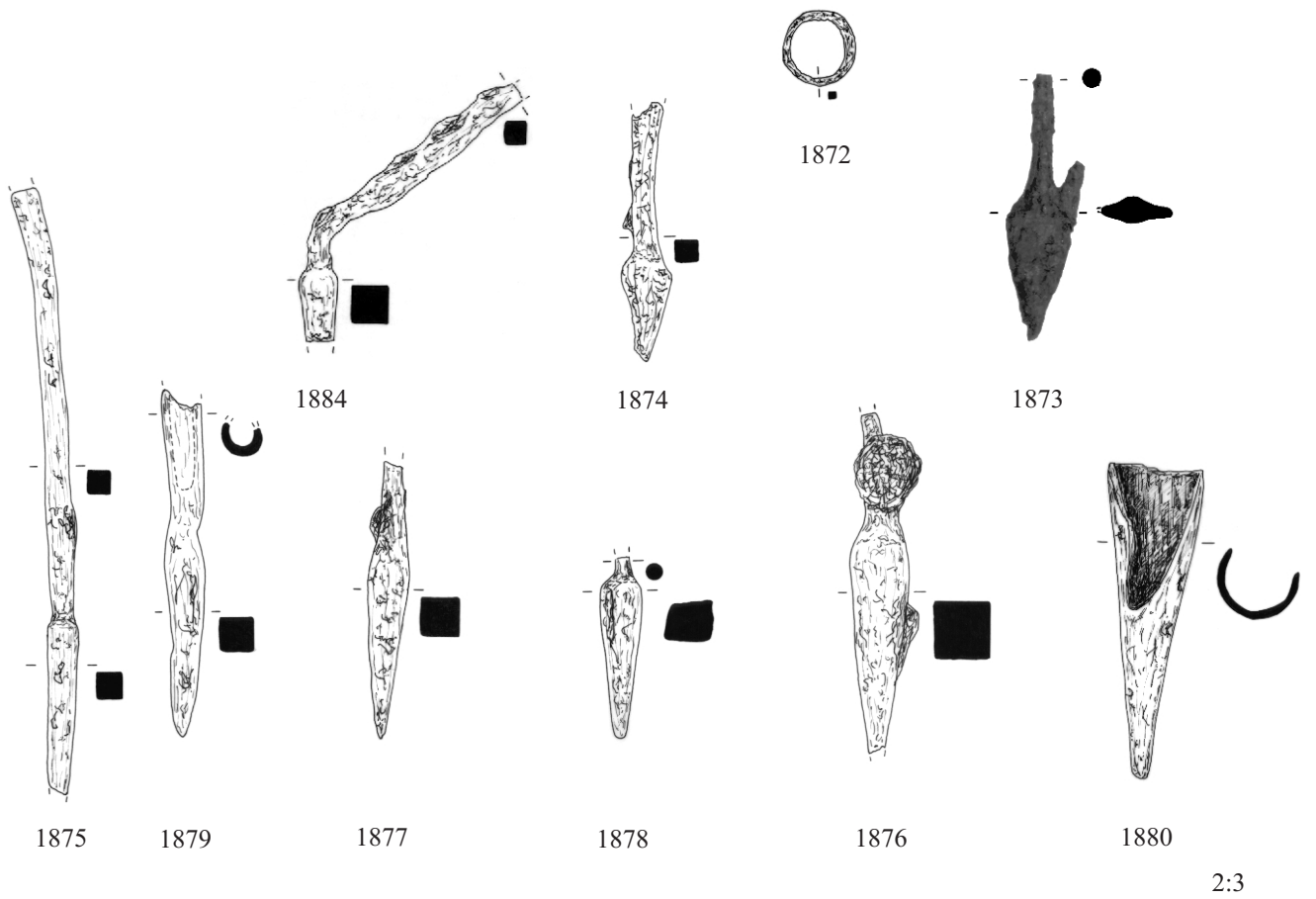

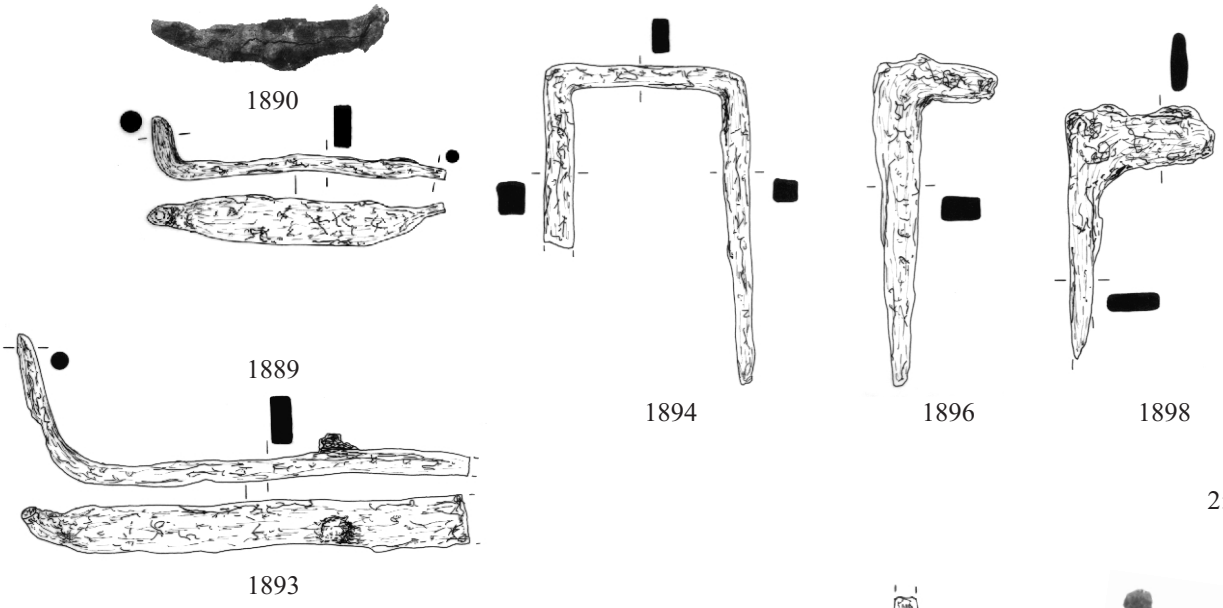

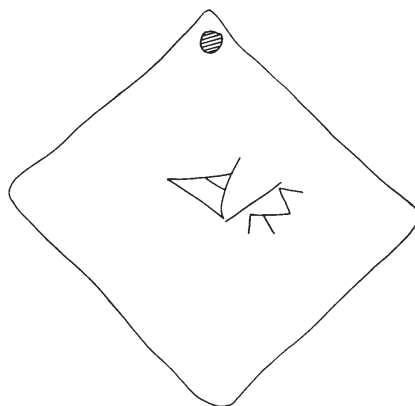
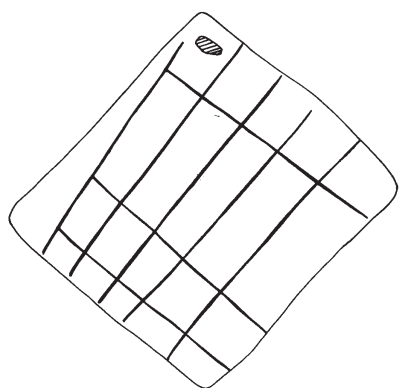
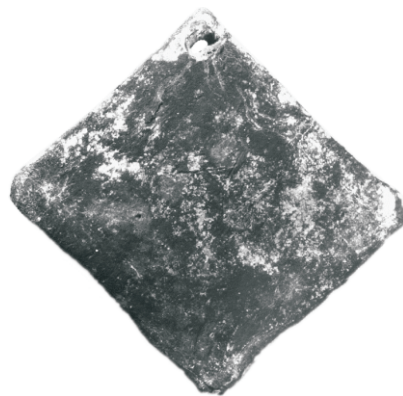
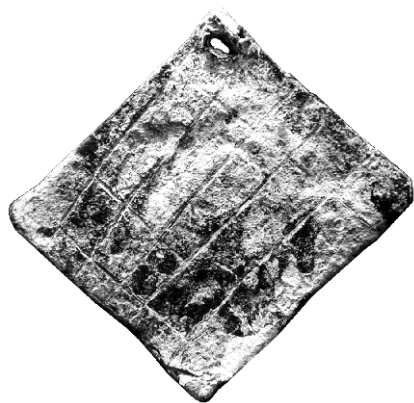

1943

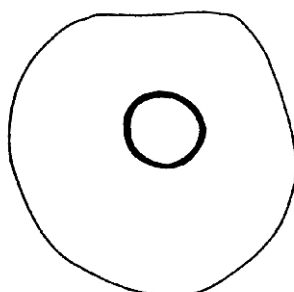
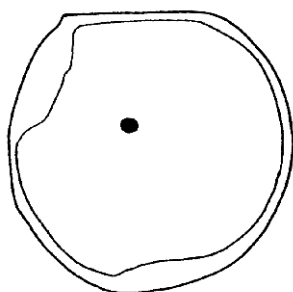

1944



1945



1946



1947



1948

1949

1950

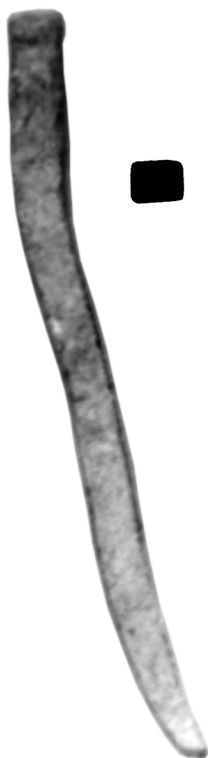

1954



1951



1952



1955



1957



1953



1958

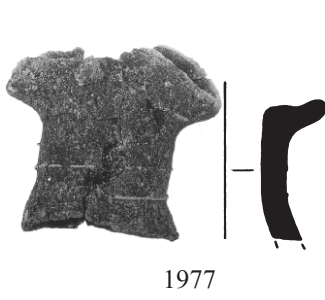

1977

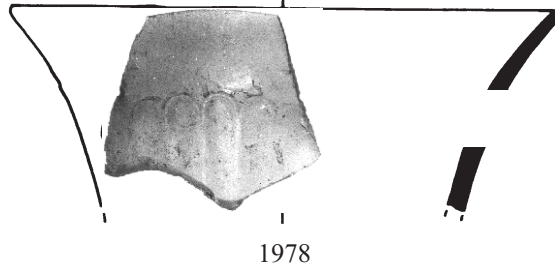

1978

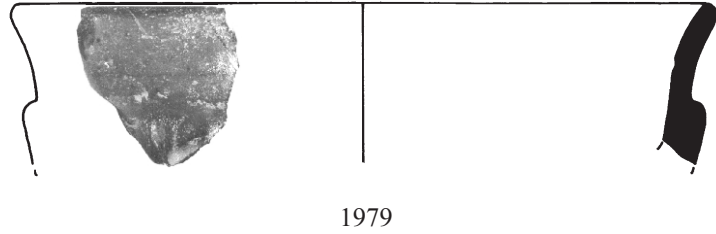

1979

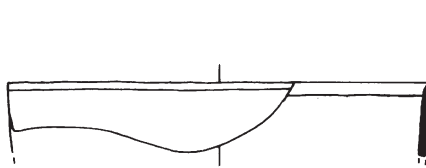

1983

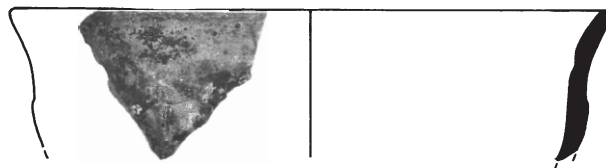

1980

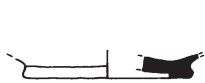

1985

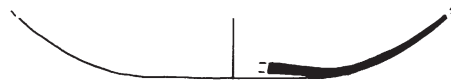

1984



1989



1994

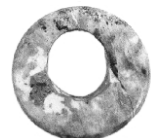

1998



1996



1995



1999



1991

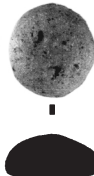

1992



1993



1990

1:1

1997

2:3

2:3



2000

1:2



2002



1:1

2003



1:1

2004



2005



2006



2007

2:3

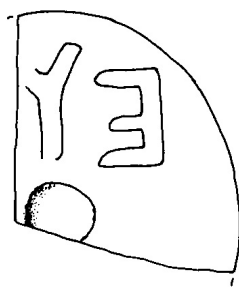

2010

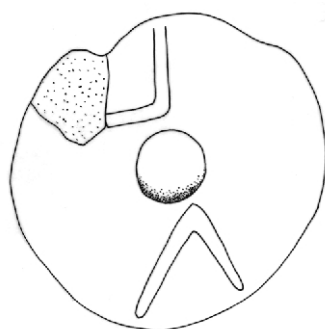

2008

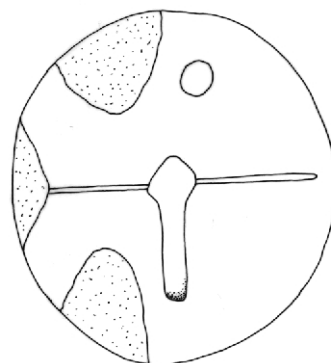
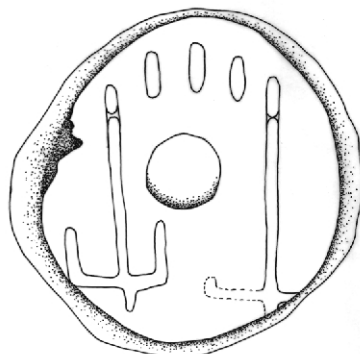
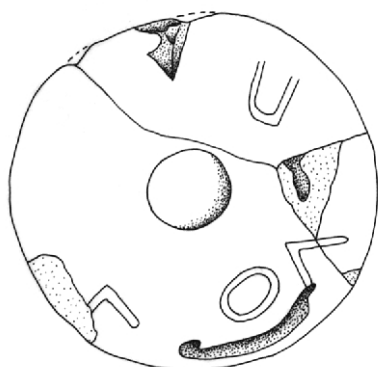

2009



2011



2012

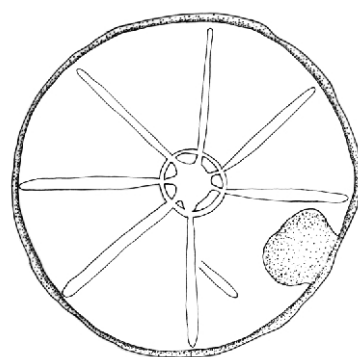
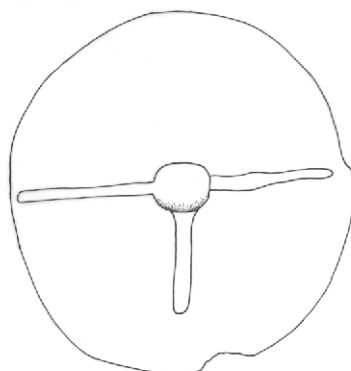
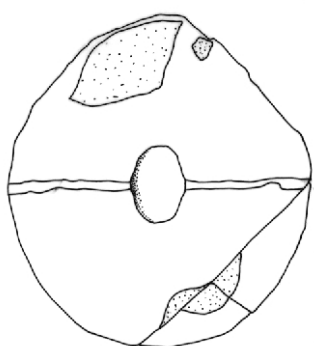

2013



2014



2015

1:2

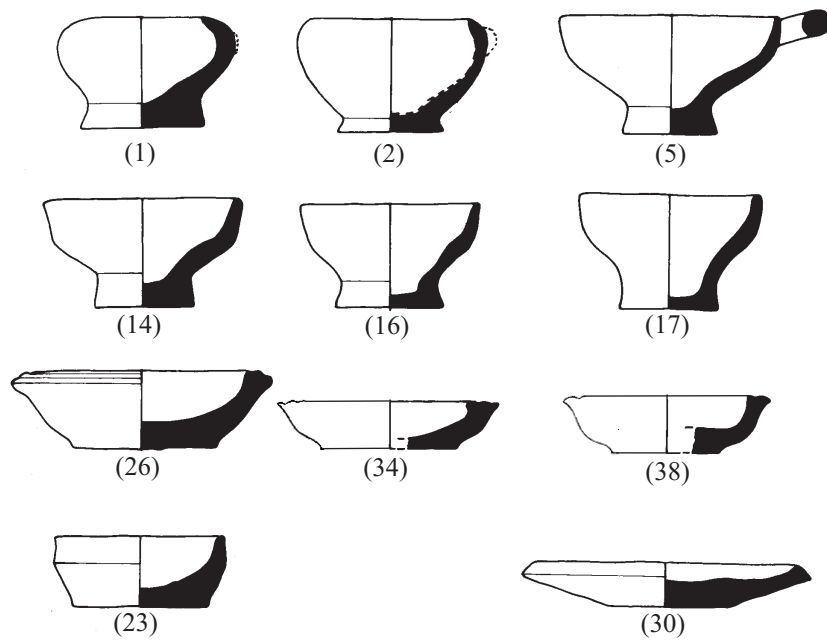

2:3



2016

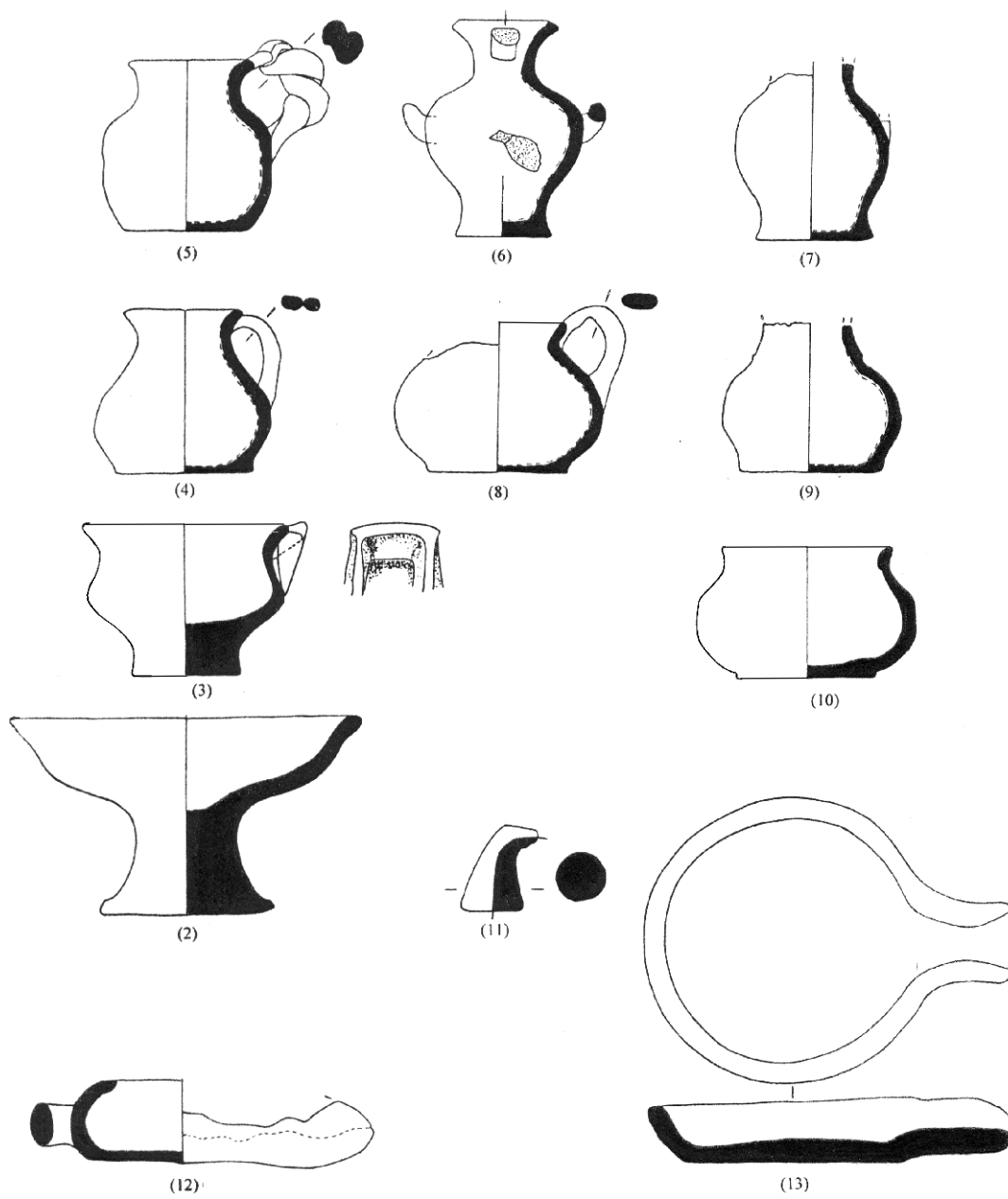

2:3



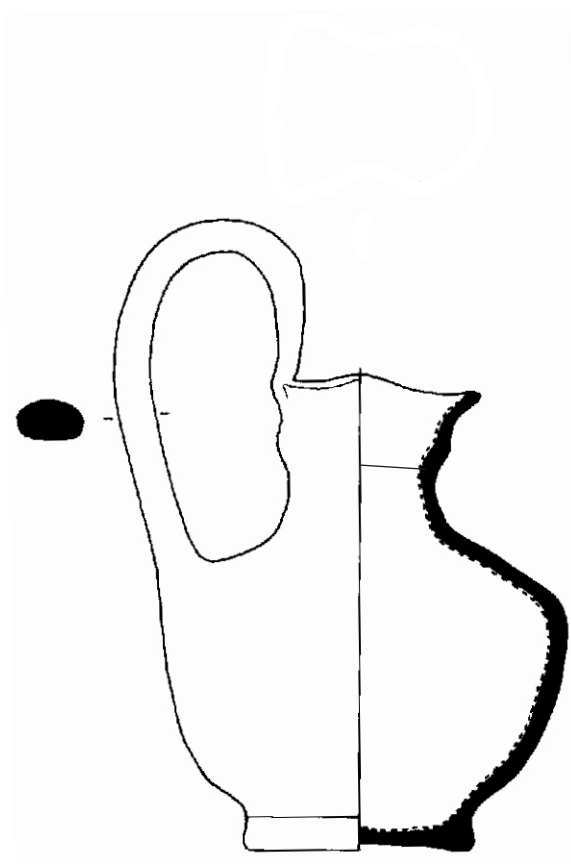

2018



2:3



2019

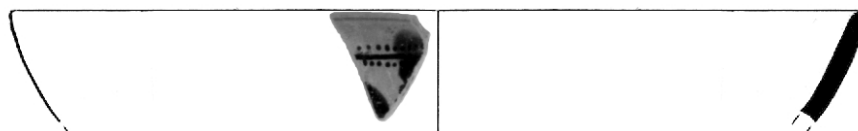

2020

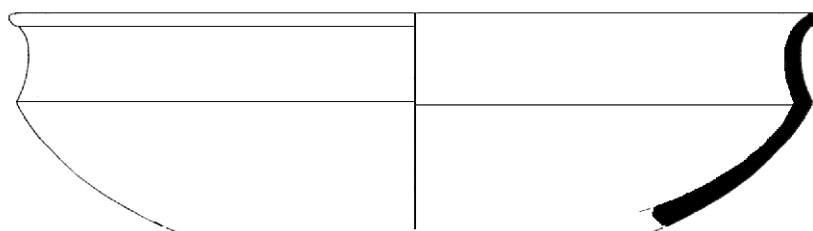

2021

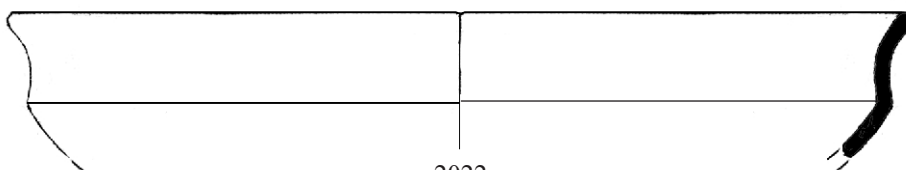

2022

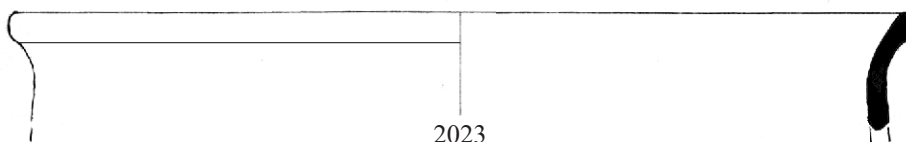

2023

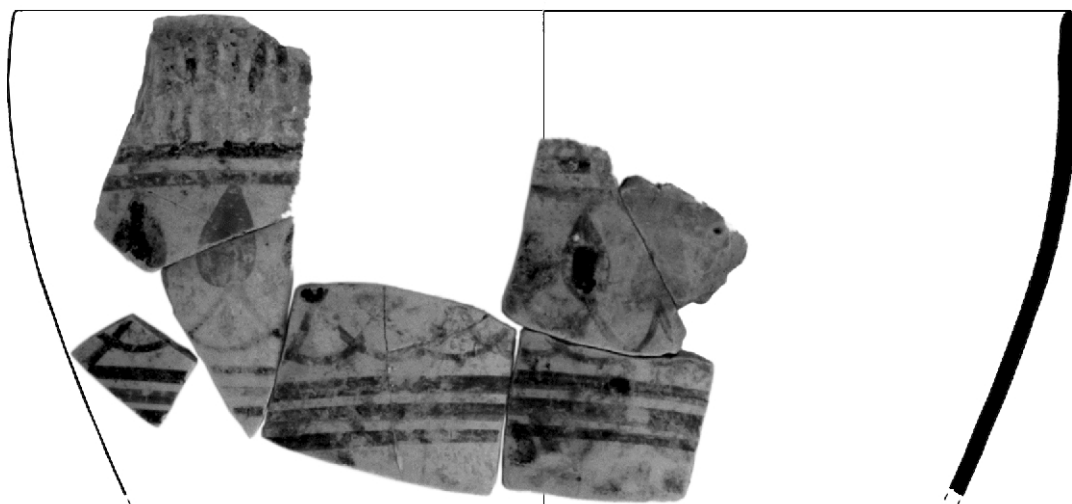

2024

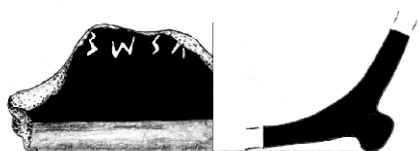

2028

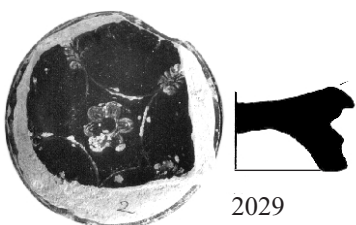

2029

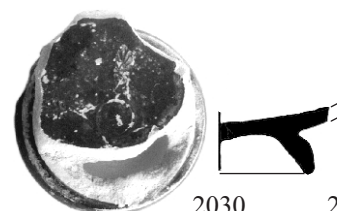

2030

2:3



2031

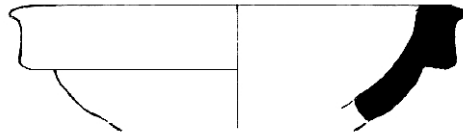

2032

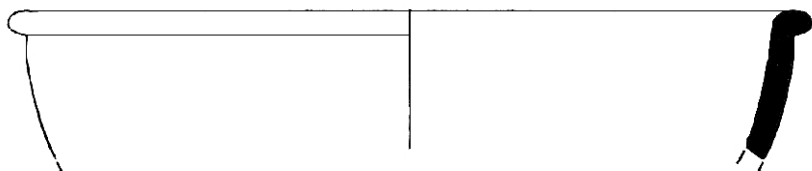

2034

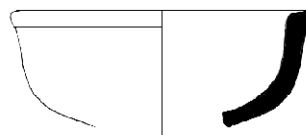

2033



2035

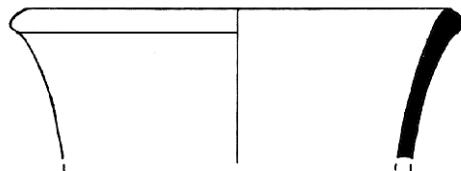

2036

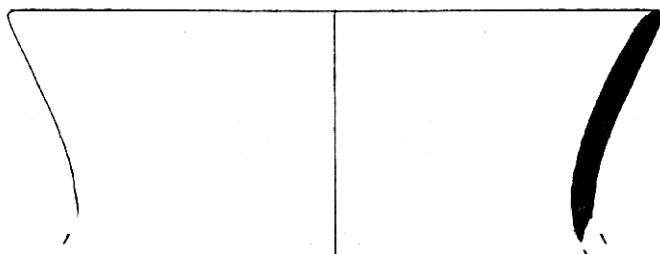

2037

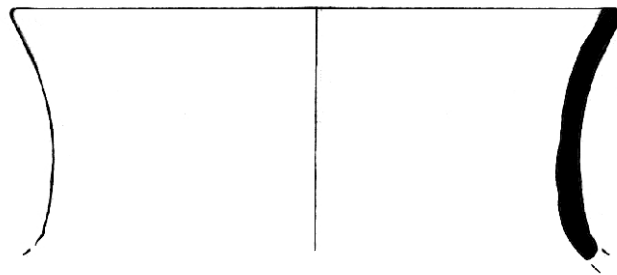

2038

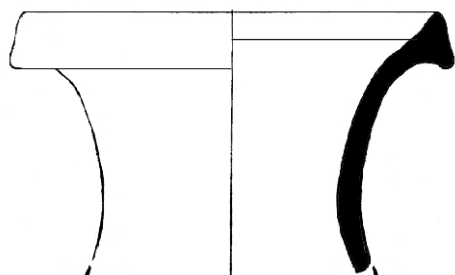

2039

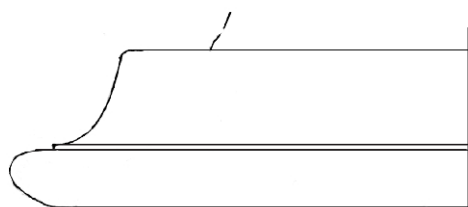

2040



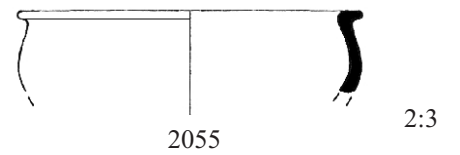
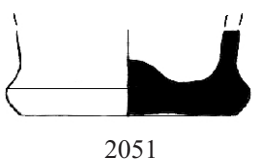
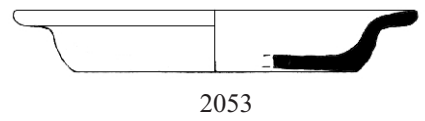
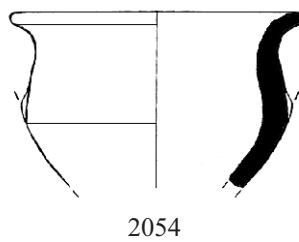
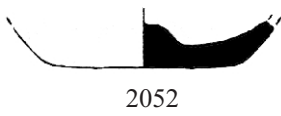
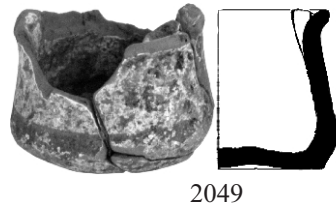
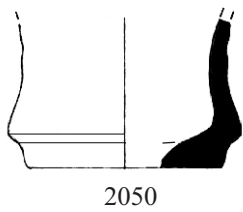
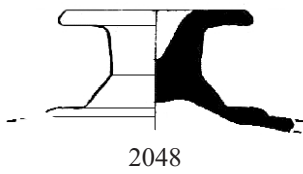
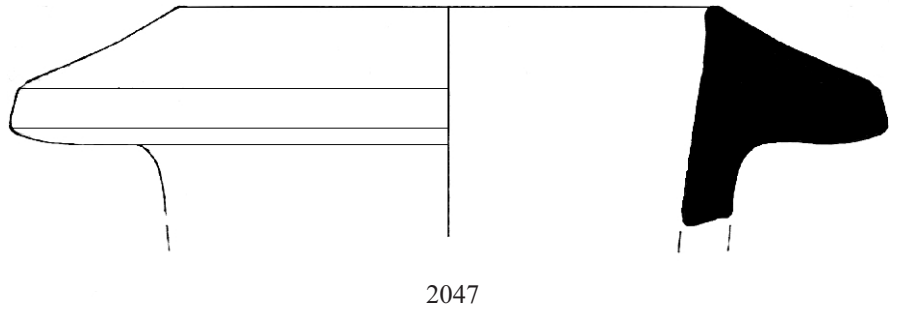
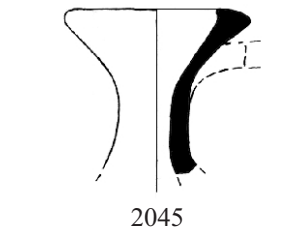
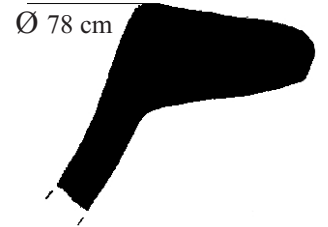
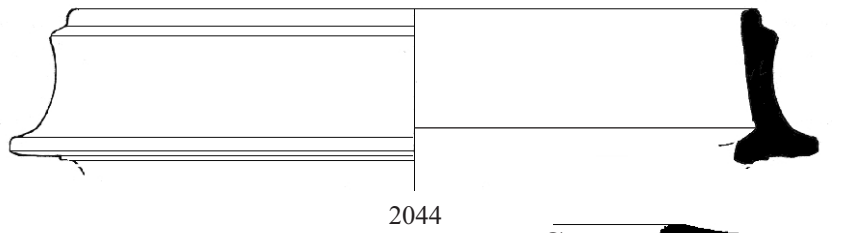
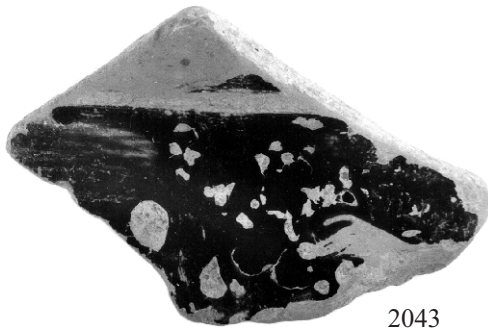
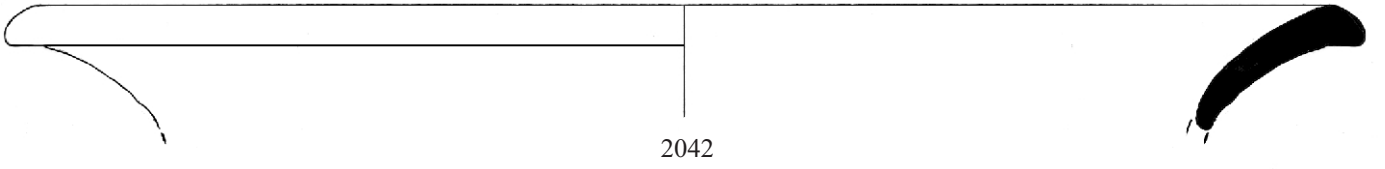
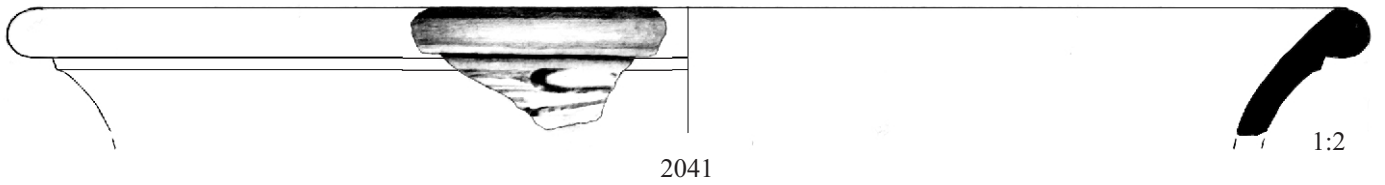

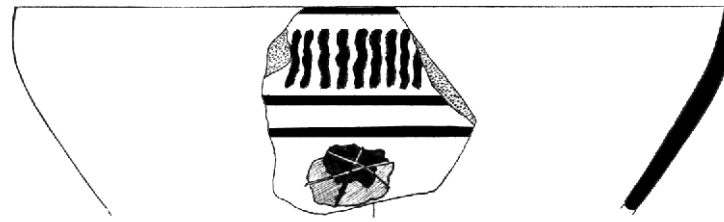

2056

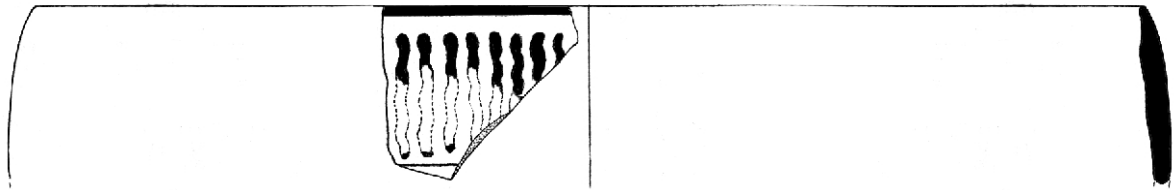

2057

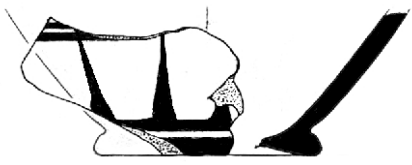

2058

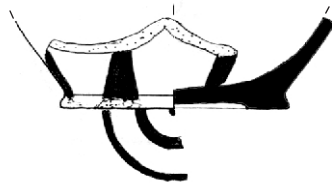

2059

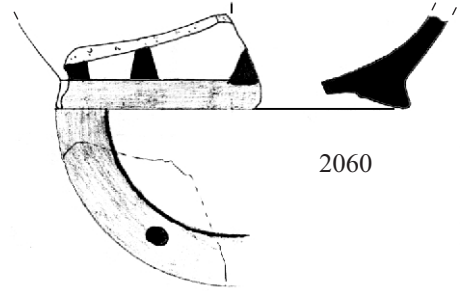

2060

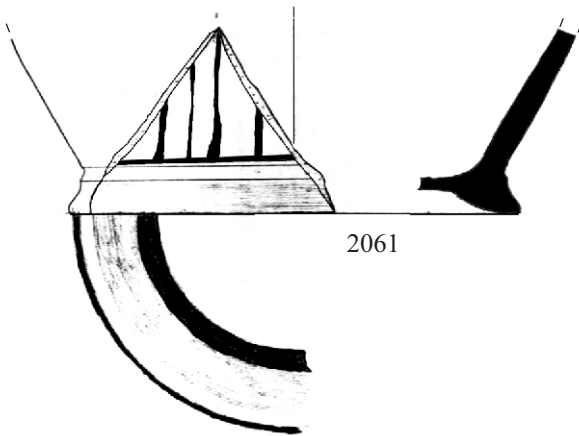

2061

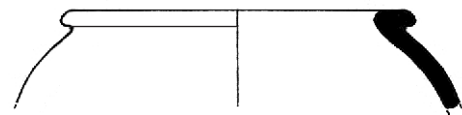

2062

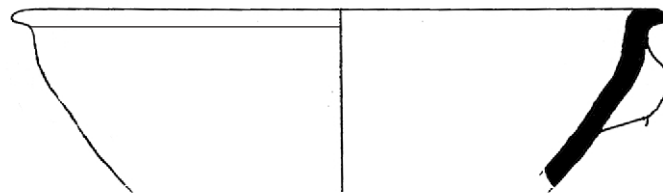

2063

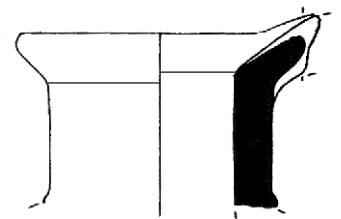

2065

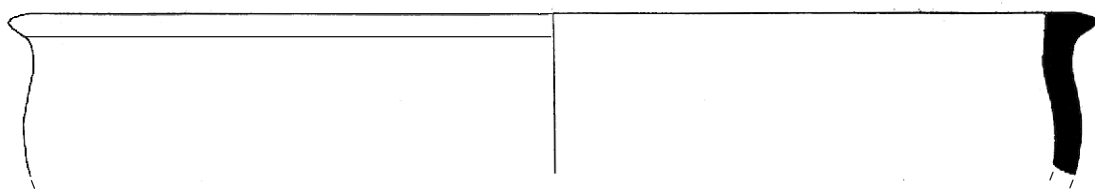

2064

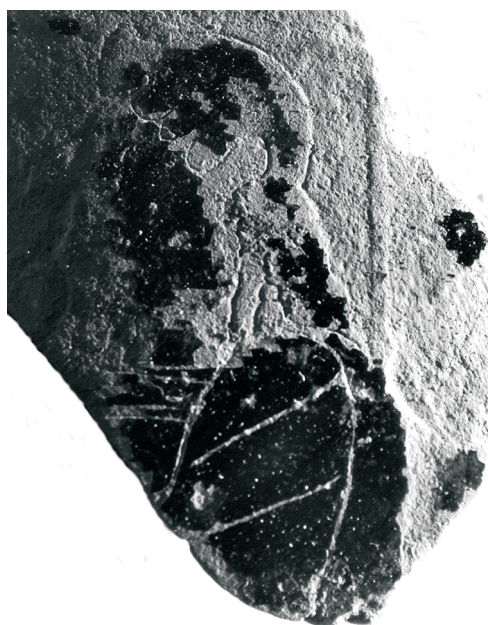

2:1

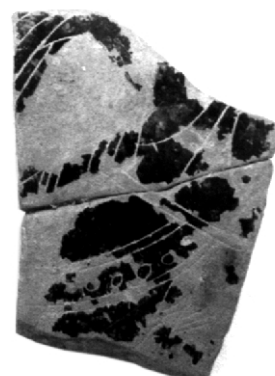

1:1

2066

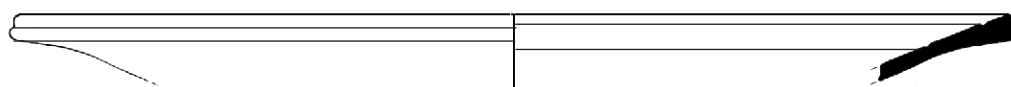
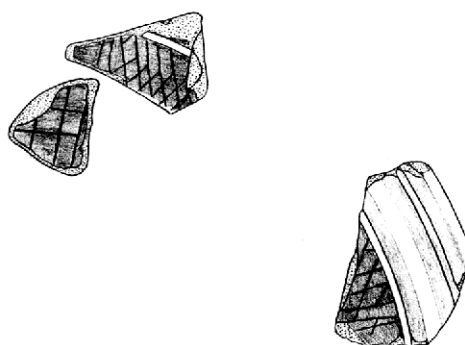

2067

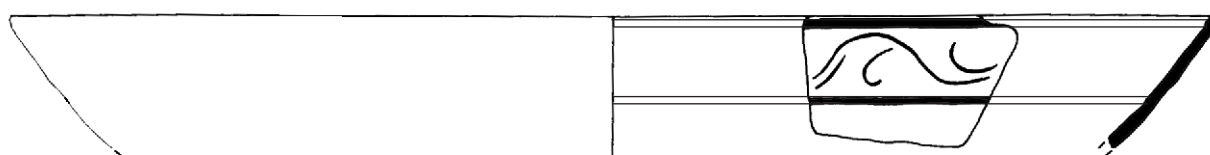

2068

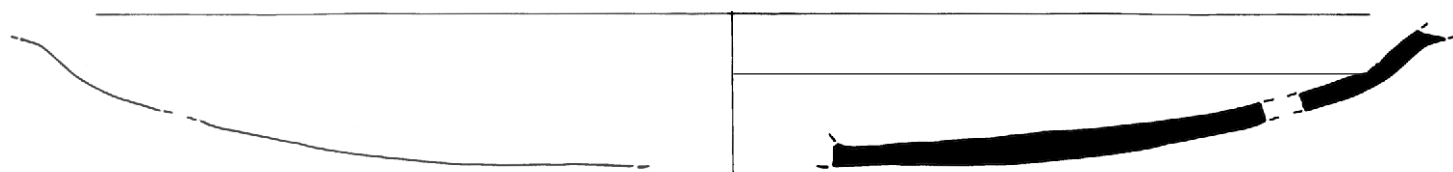
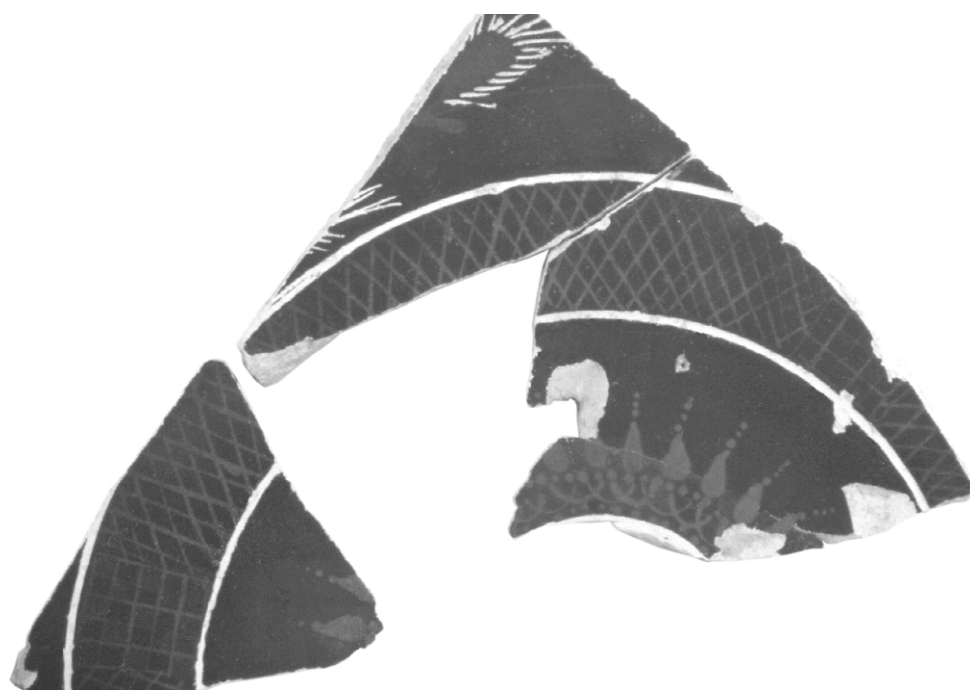

2069

1:2

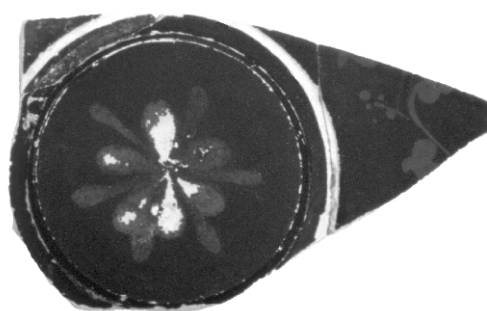

2070

2:3

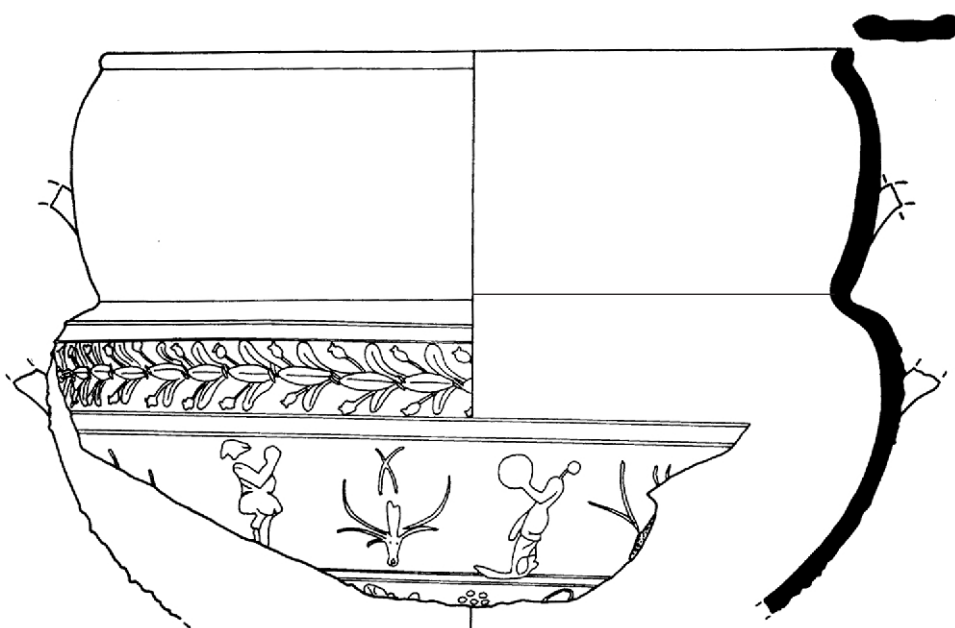

2071

2:3

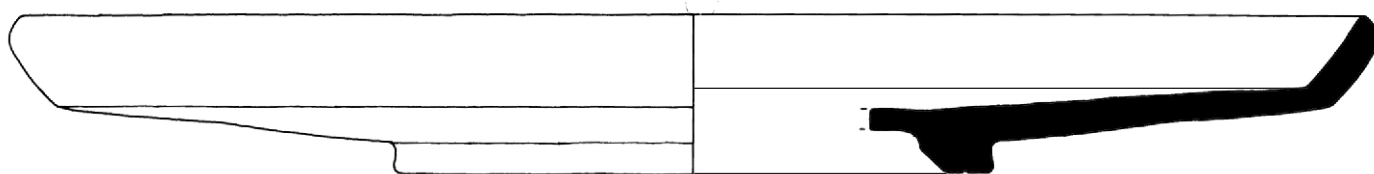

2072

1:2

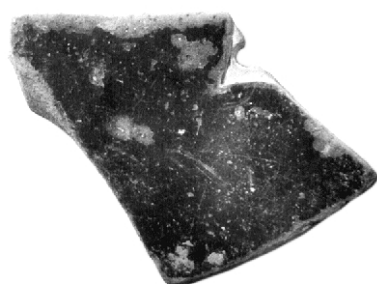

2073



2074

2:3

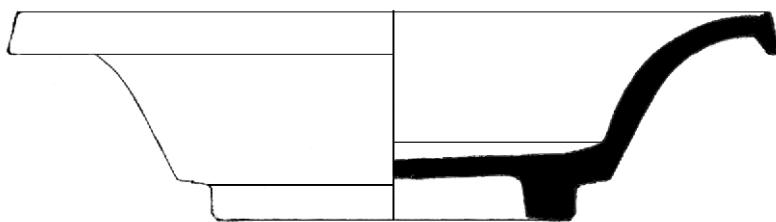

2075

2:3



2076

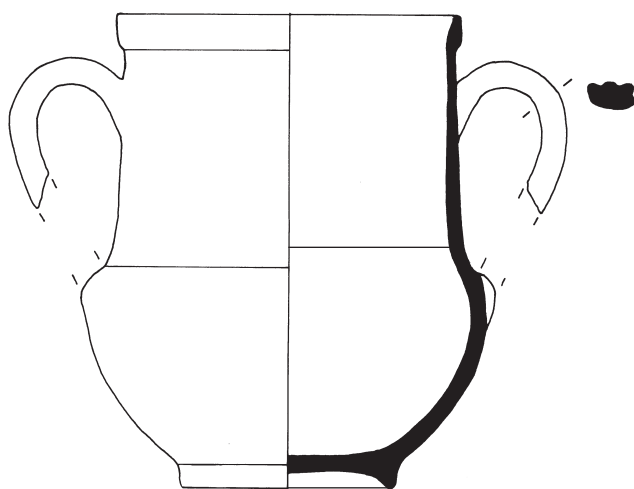
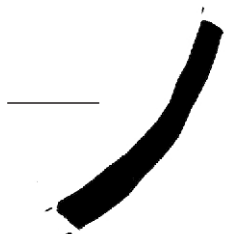

2077

2:3

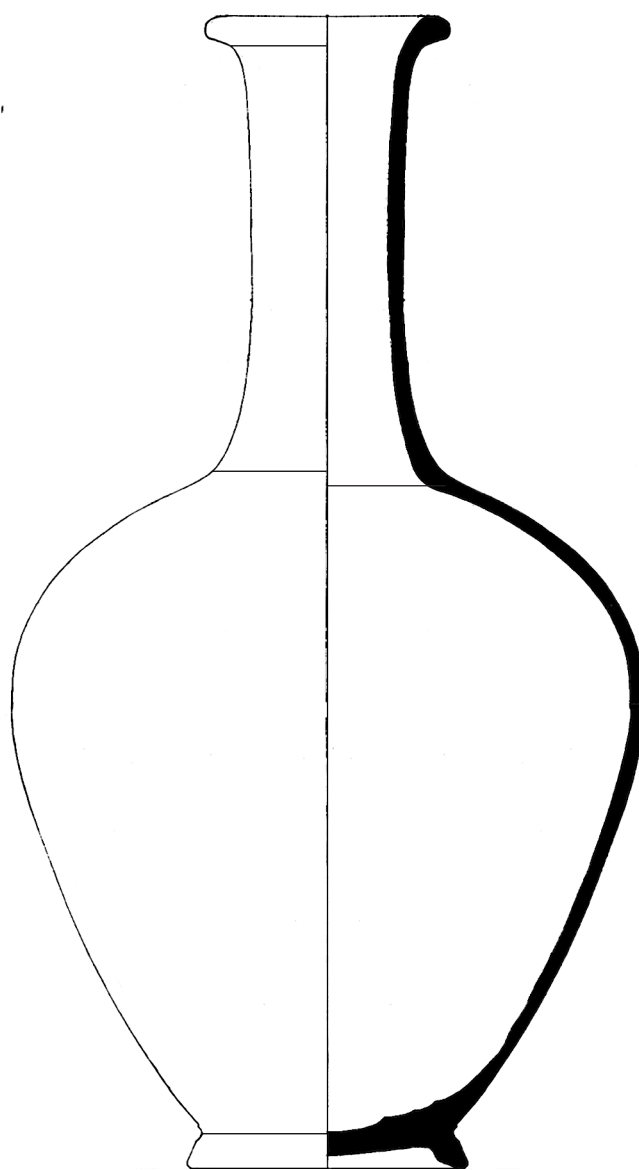

2078

1:2

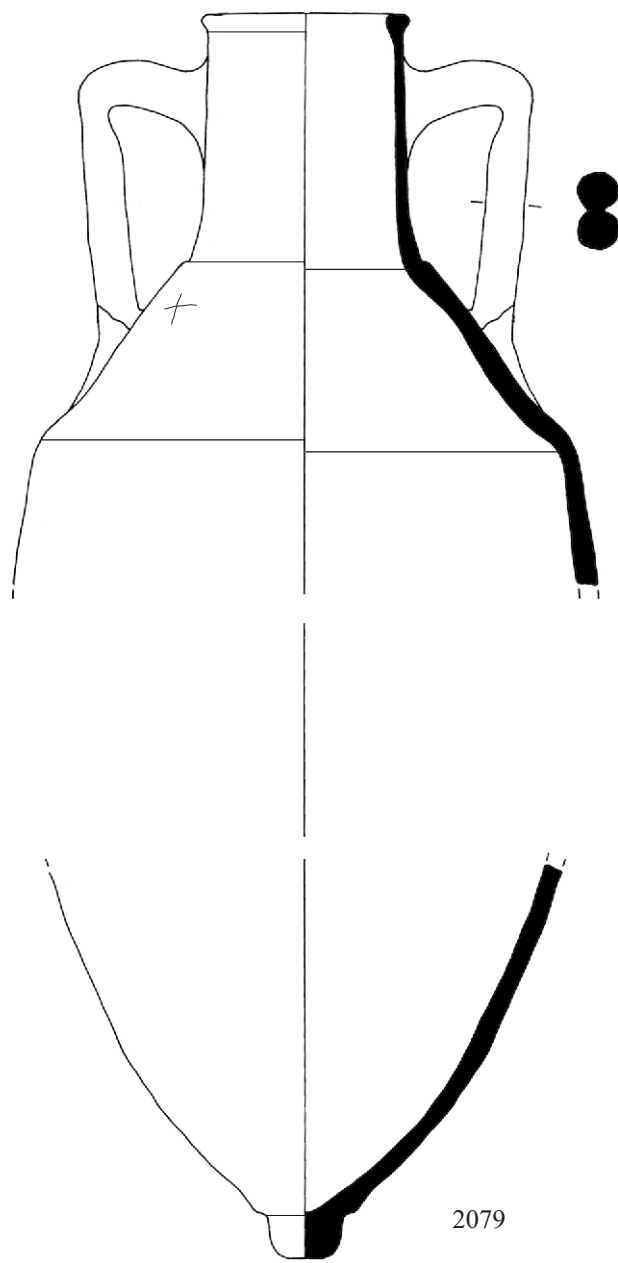

1:6

2079

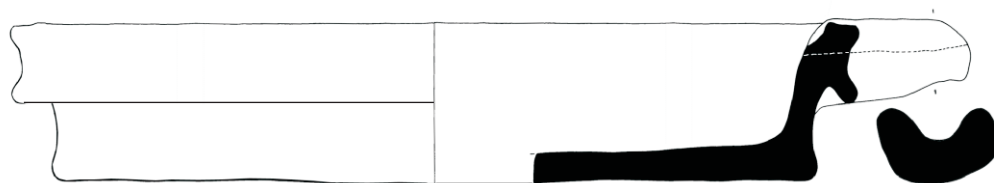

1:3



2080

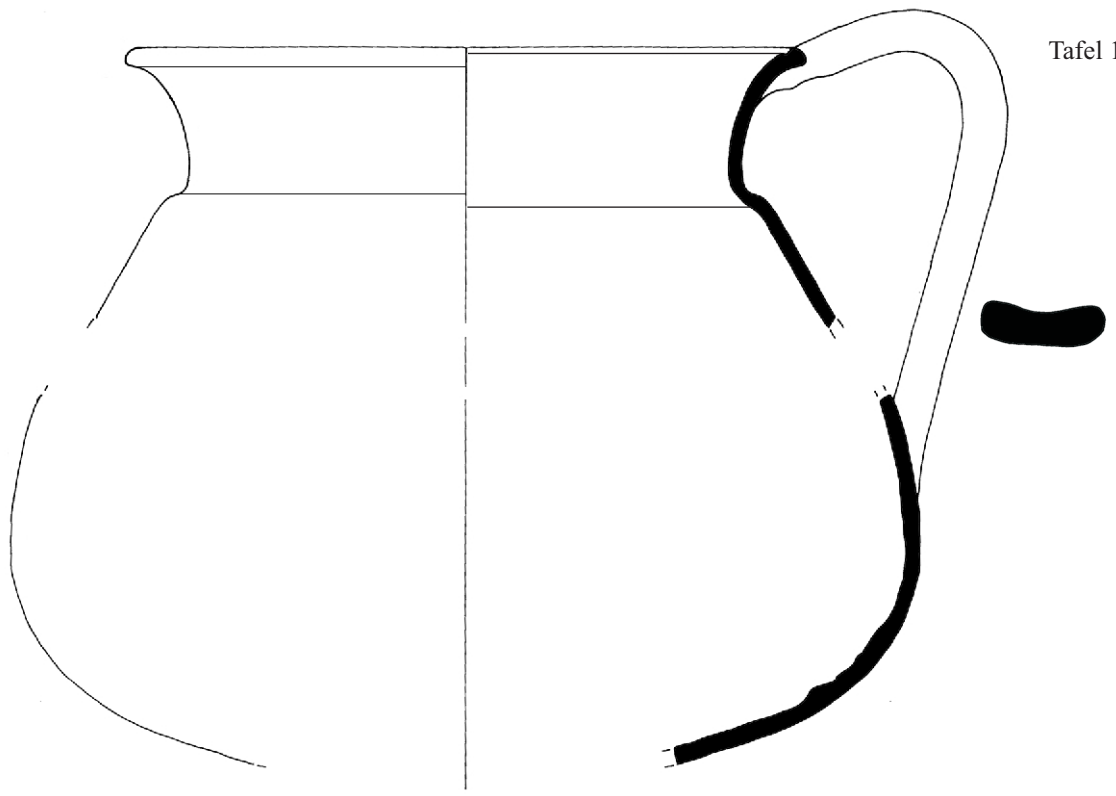

2081



2083

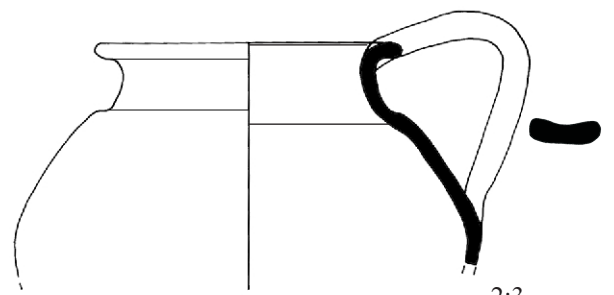

2:3

2082

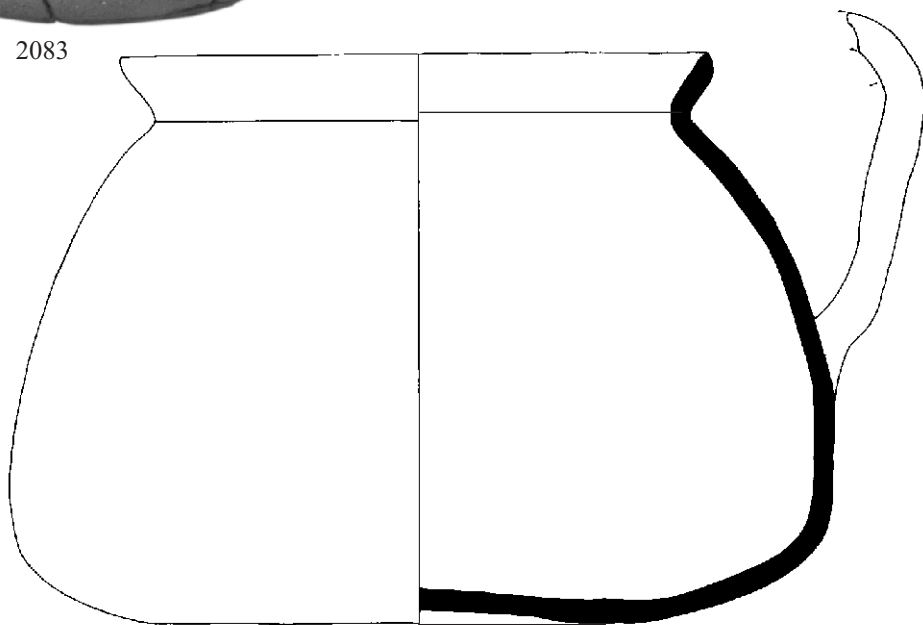

2083

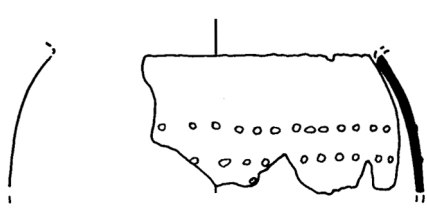

2084

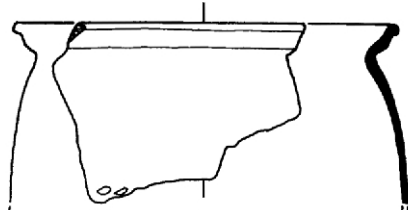

2085

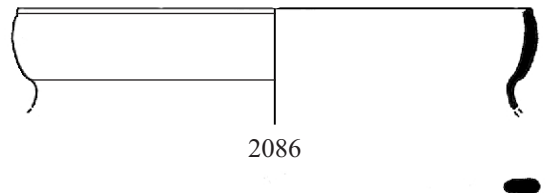

2086

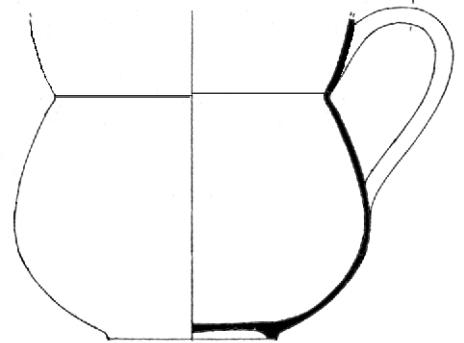
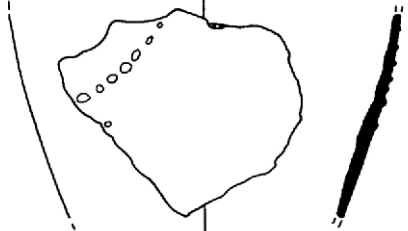
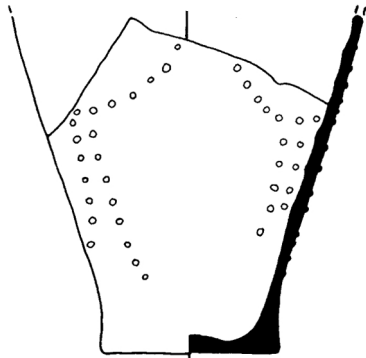

2087

2:3

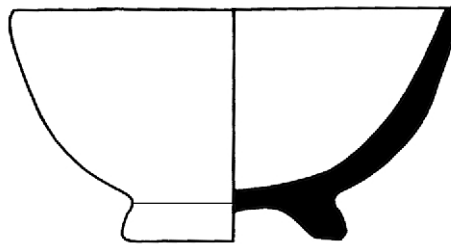

2087



2088

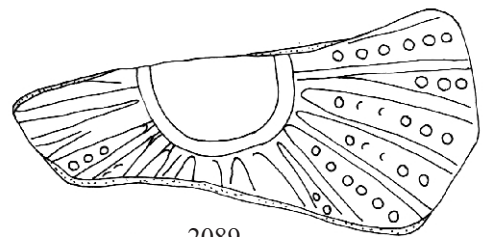

2089

2:3

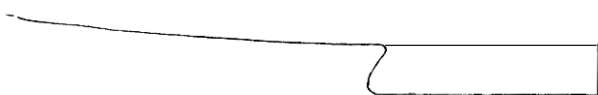

2090

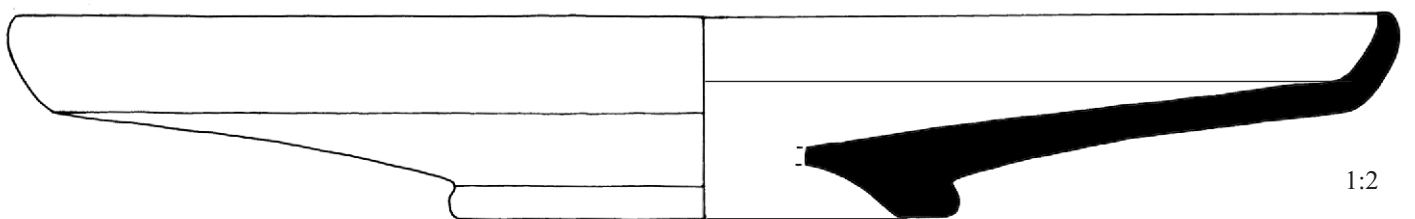
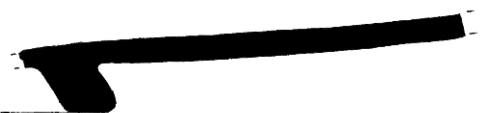

2091

1:2

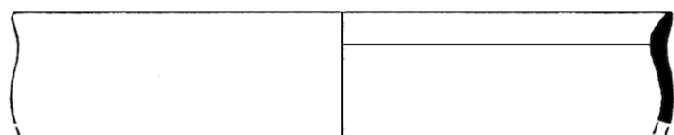

2093

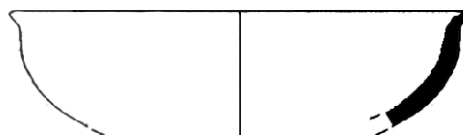

2094

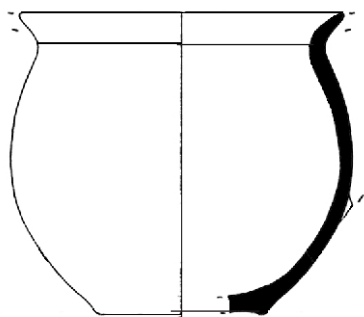

2095

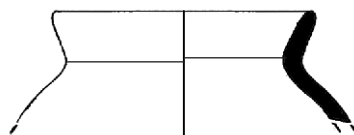

2098

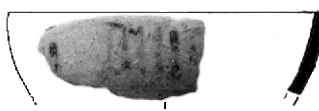

2097

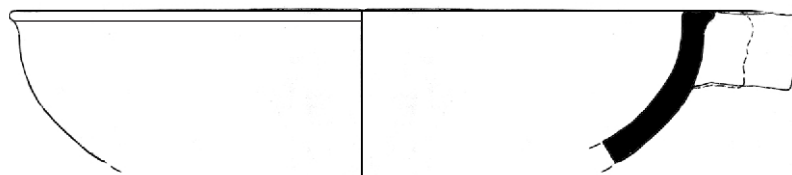
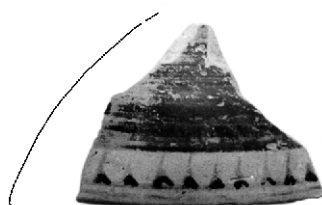
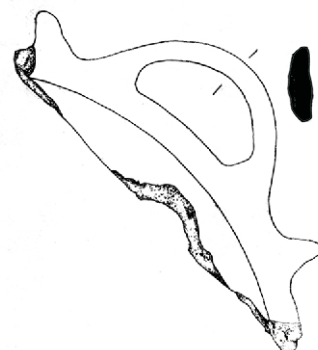

2099

2096

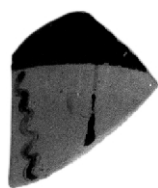

2100



2101

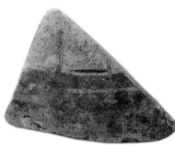

2102



2103



2104



2105

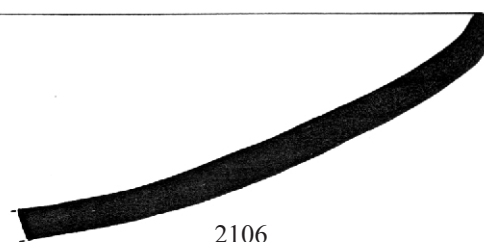
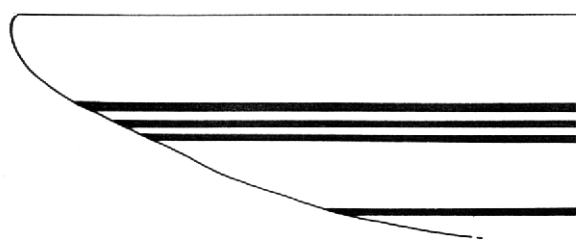

2106

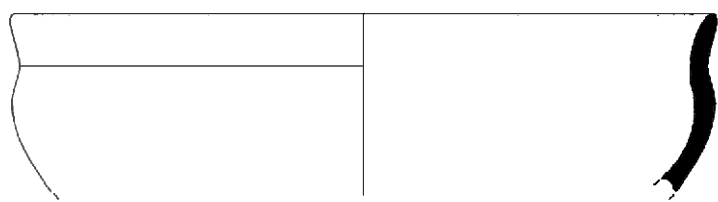

2107

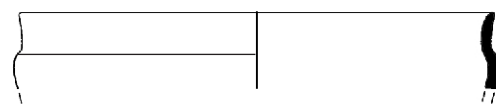

2108

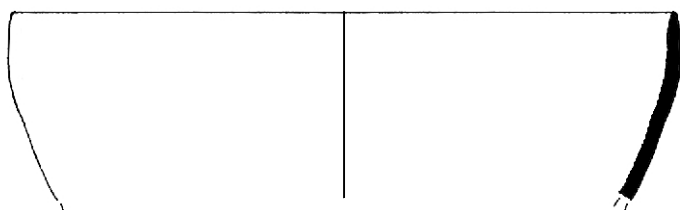

2109

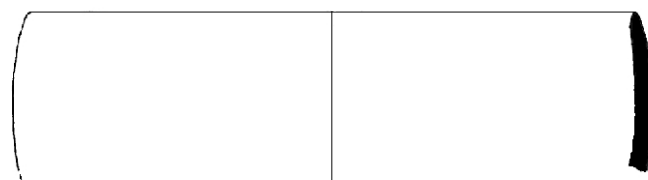

2110

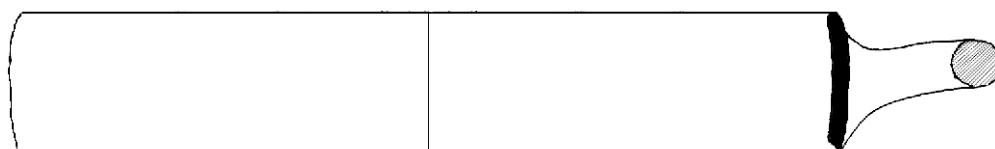

2111

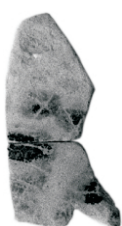

2113

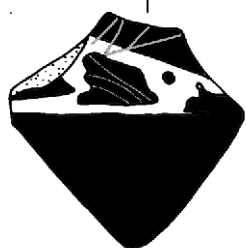

2112



2115



2114



2117

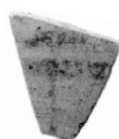

2116

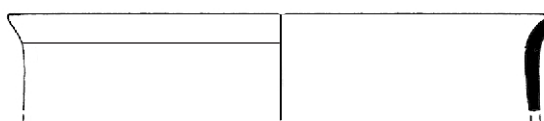

2118

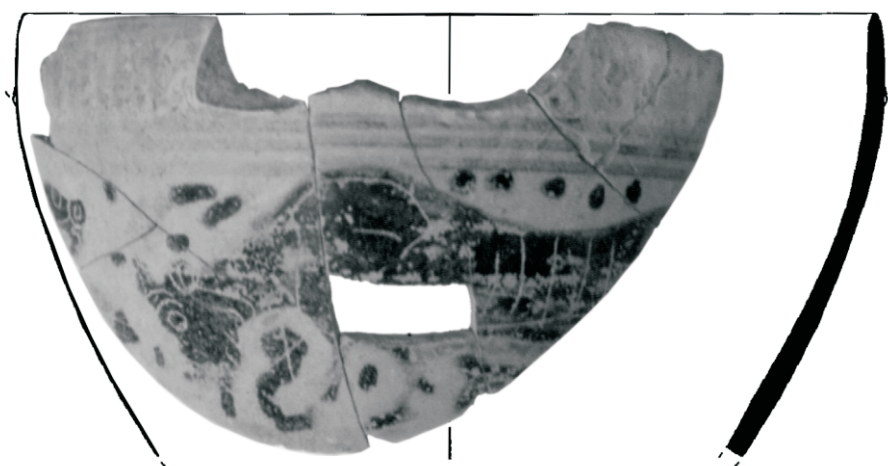

2119

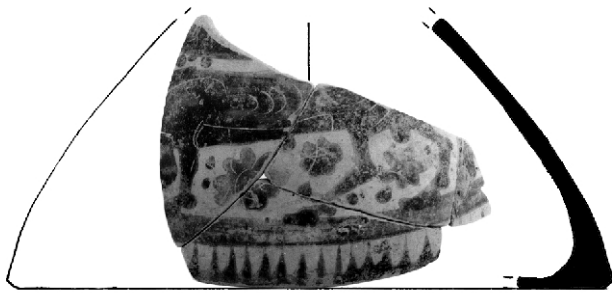

2120



2121



2122

2126

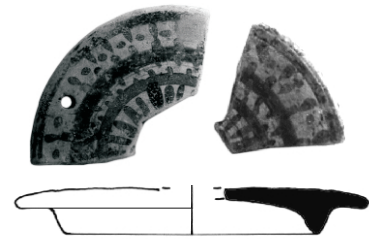

2125

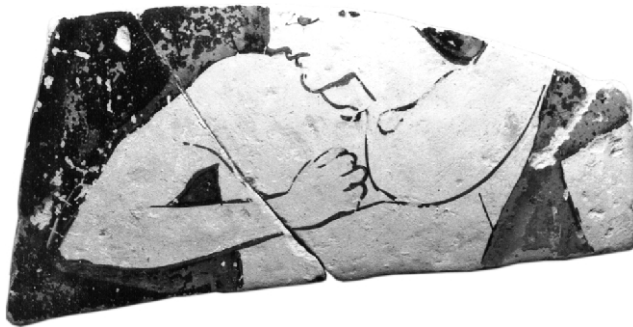

2123

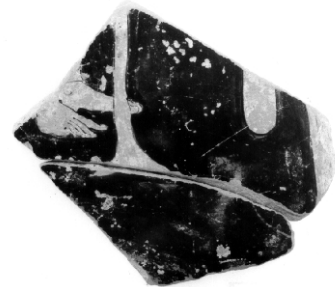

2127

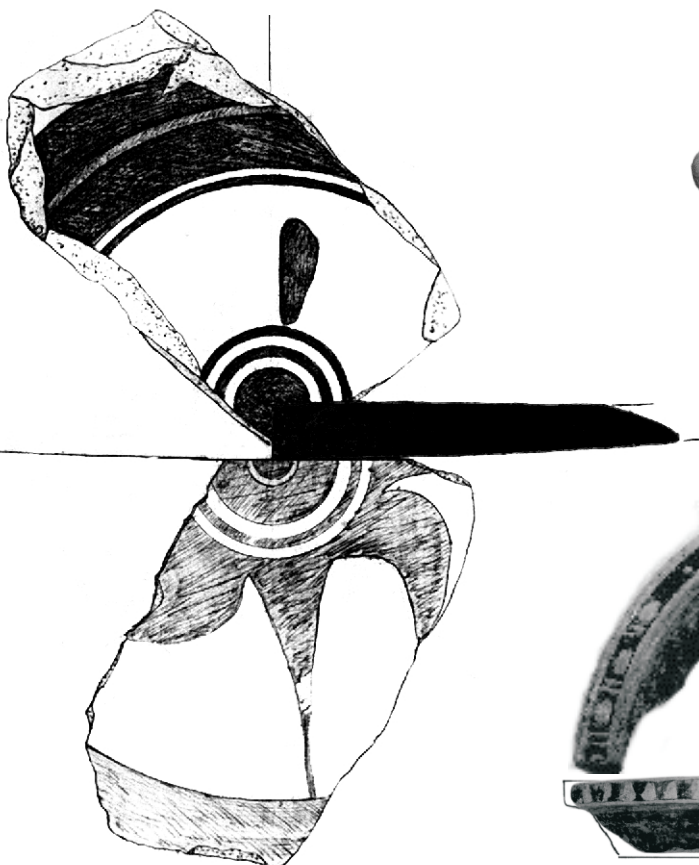

2124



2128



2129

Ø 40 cm

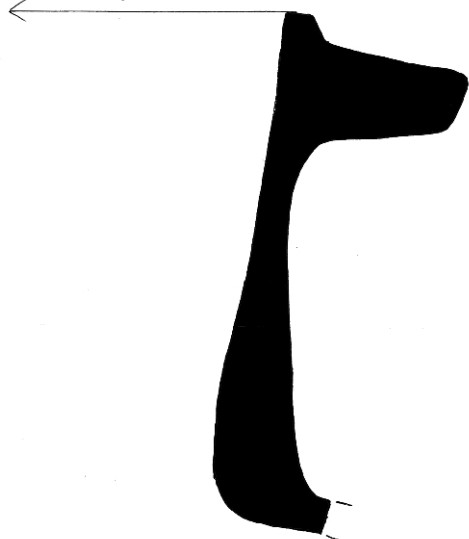

2131

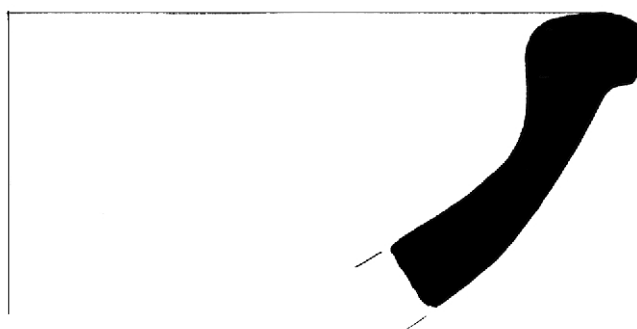

2132

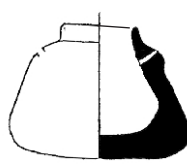

2130

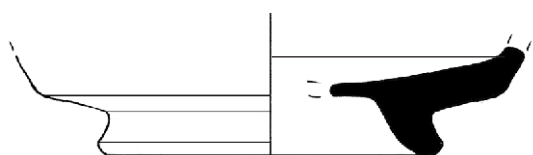

2133

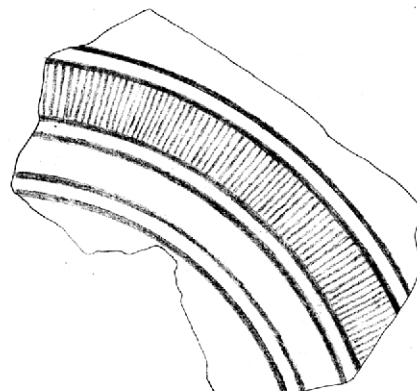

2134

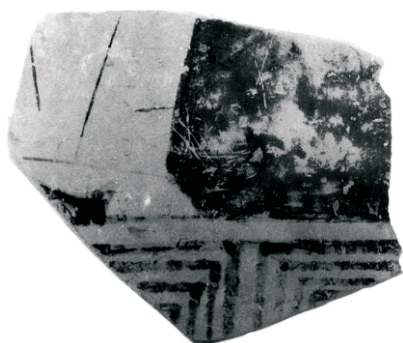

2136

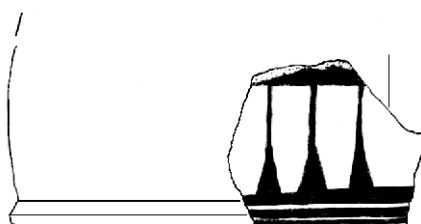

2135

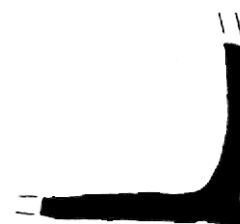

Lebenslauf

Der Lebenslauf ist in der Online-Version aus Gründen des Datenschutzes nicht enthalten.