

A grammar of Vamale

Jean Rohleder

Comprehensive Grammar Library 9



Comprehensive Grammar Library

Editor: Martin Haspelmath

In this series:

1. Jacques, Guillaume. A grammar of Japhug.
2. Grimm, Nadine. A grammar of Gyeli.
3. Maurer-Cecchini, Philippe. A grammar of Tuatschin: A Sursilvan Romansh dialect.
4. Visser, Eline. A grammar of Kalamang.
5. Caballero, Gabriela. A grammar of Choguita Rarámuri: In collaboration with Luz Elena León Ramírez, Sebastián Fuentes Holguín, Bertha Fuentes Loya and other Choguita Rarámuri language experts.
6. Barlow, Russell. A grammar of Ulwa (Papua New Guinea).
7. Terhart, Lena. A grammar of Paunaka.
8. Pebley, Carol J. & Thomas E. Payne. A grammar of Kagayanen.
9. Rohleder, Jean. A grammar of Vamale.

ISSN (print): 2748-971X
ISSN (electronic): 2749-7798

A grammar of Vamale

Jean Rohleder



Jean Rohleder. 2024. *A grammar of Vamale* (Comprehensive Grammar Library 9). Berlin: Language Science Press.

This title can be downloaded at:

<http://langsci-press.org/catalog/book/445>

© 2024, Jean Rohleder

Published under the Creative Commons Attribution 4.0 Licence (CC BY 4.0):

<http://creativecommons.org/licenses/by/4.0/> 

ISBN: 978-3-96110-479-6 (Digital)

978-3-98554-108-9 (Hardcover)

ISSN (print): 2748-971X

ISSN (electronic): 2749-7798

DOI: 10.5281/zenodo.12606066

Source code available from www.github.com/langsci/445

Errata: paperhive.org/documents/remote?type=langsci&id=445

Cover and concept of design: Ulrike Harbort

Typesetting: Jean Rohleder

Proofreading: Benjamin Brosig, Carrie Dyck, Elliott Pearl, Ezekiel Bolaji, Jeroen van de Weijer, Katja Politt, Lachlan Mackenzie, Jean Nitzke, Mary Ann Walter, Philip Duncan, Tabea Reiner, Tim Ongenae, Yvonne Treis

Fonts: Libertinus, Arimo, DejaVu Sans Mono

Typesetting software: $\text{X}_{\text{L}}\text{A}_{\text{T}}\text{E}_{\text{X}}$

Language Science Press

xHain

Grünberger Str. 16

10243 Berlin, Germany

<http://langsci-press.org>

Storage and cataloguing done by FU Berlin

Freie Universität  Berlin

Contents

Acknowledgments	ix
Abbreviations	xi
1 Typological overview	1
1.1 Phonology	1
1.2 Example sentences	3
1.3 Person forms and demonstratives	4
1.4 Element order	6
1.5 Argument coding	6
1.6 Word classes	8
1.7 Verbs and verb phrases	9
1.8 Derivation	10
1.9 Nouns and noun phrases	10
1.10 Possessive constructions and compounds	11
1.11 Prepositions	12
1.12 Subordinate clauses	12
2 Methodology	15
2.1 Types of data recorded	15
2.2 Equipment used	16
2.3 Field trips	16
2.4 Consultants	17
2.4.1 André Nigai Kalène	18
2.4.2 Christophe Keela Pei	18
2.4.3 Jacob Keela Ganap Oué	18
2.4.4 Jean-Philippe Emyl Téin Oué	18
2.5 Notes on fieldwork in Vamale country	19
2.5.1 Climate	20
2.5.2 Lodging	20
2.5.3 Cultural notes	21
2.5.4 The place of language in Kanak culture	23

Contents

2.6	Language name	24
3	Language family, neighbors and previous work	27
3.1	Current geographical location of Vamale	29
3.1.1	Téganpaïk	30
3.1.2	Wanaa	32
3.1.3	We Hava	33
3.1.4	Tiendanite	34
3.2	Language family	34
3.2.1	Linguistic context	43
3.2.2	Multilingualism and variation	47
3.2.3	Neighboring languages	47
3.3	Previous work	49
4	History of speakers	51
4.1	Pre-1917	51
4.2	The 1917 War	52
4.3	French policy and decline of the language	57
5	Phonology	61
5.1	Transcription	61
5.2	Consonants	63
5.2.1	Examples	63
5.2.2	Marginal phonemes	64
5.2.3	Labio-velarized consonants	67
5.2.4	Voiceless nasals	68
5.2.5	Aspiration	68
5.2.6	Allophones of consonants	73
5.3	Vowels	73
5.3.1	Quantity	74
5.3.2	Quality	75
5.3.3	Vowel sequences	76
5.3.4	Allophones of vowels	76
5.4	Phonotactics/syllable structure	80
5.5	Reduplication	80
5.6	Stress	80
6	Word classes	83
6.1	What is a word?	83
6.1.1	Concerning <i>vwa</i>	84

6.1.2	Prosodic words and grammatical words	84
6.1.3	Affixes and clitics	85
6.2	The distinction between verbs and nouns	86
6.2.1	Syntactic criteria	86
6.2.2	Morphological criteria	87
6.2.3	Semantic criteria	89
6.3	Articles	90
6.3.1	The question of definiteness	91
6.3.2	The articles <i>ca</i> and <i>eca</i> ‘some’	93
6.3.3	Variation: <i>li</i> vs <i>ni</i>	95
6.3.4	Other, related languages	95
6.4	Demonstratives	98
6.5	Nouns	99
6.5.1	Classifiers	99
6.5.2	Relational nouns	100
6.6	Independent personal pronouns	101
6.7	Subject-indexing bound pronouns	101
6.8	Prepositions	102
6.9	Subject marker <i>ka</i>	103
6.10	Relativizer	104
6.11	TAM markers	104
6.12	Verbs	105
6.13	Adverbs	107
6.13.1	Temporal adverbs	108
6.13.2	Locative adverbs	108
6.13.3	<i>hman</i> ‘also’	109
6.14	Complementizer <i>hapi</i>	110
6.15	Conjunctions	110
6.15.1	Nominal conjunctions	110
6.15.2	Verbal conjunctions	111
6.16	Subordinators	112
6.17	Negation markers	114
6.18	Assertive <i>tha</i>	114
6.19	Intensifiers	115
6.20	Repetitive <i>mwa</i>	116
6.21	Interjections	117
6.22	Quantifiers	118

Contents

7	Nouns	119
7.1	Animacy	120
7.2	Possession	120
7.2.1	Alienable	126
7.2.2	Inalienable	126
7.3	Classifiers	128
7.3.1	Relational classifiers: Food	128
7.3.2	Relational classifier <i>ka</i>	128
7.3.3	Focussed Possession marker <i>ka</i>	131
7.3.4	Noun classifiers	132
7.4	Compound nouns	133
7.4.1	N + N compounds	135
7.4.2	The question of Noun + Adverb compounds	138
7.4.3	N + V compounds	139
7.4.4	V + N compounds	139
8	Noun phrases	141
8.1	Case marking	142
8.1.1	Agentive marker <i>ka</i>	143
8.1.2	Oblique markers	144
8.2	Pronouns	148
8.2.1	Personal pronouns	150
8.2.2	Demonstrative pronouns	150
8.3	Fronting	153
8.4	Modifying a noun	154
8.4.1	Particles <i>se, been</i> ‘other’	154
8.4.2	Quantification	155
8.4.3	Relativizer <i>a</i>	156
8.4.4	Noun phrase subordinator <i>ko-</i>	157
8.4.5	Demonstrative suffixes	157
8.4.6	Dependent verbs in modified noun phrases	158
8.5	Coordination of noun phrases	160
8.5.1	Comitative <i>ma</i> ‘with’	161
8.5.2	Additive <i>ka</i> ‘also, too’	162
8.5.3	Alternative <i>hai</i> ‘or’	162
9	Verbs	165
9.1	Impersonal verbs	166

9.2	Stative verbs	168
9.2.1	Dependent stative verbs	170
9.2.2	Numerals	172
9.2.3	Possessible verbs	176
9.3	Active verbs	177
9.3.1	Transitive verbs	178
9.3.2	Benefactive nouns	185
9.4	Space	186
9.4.1	Up/down	186
9.4.2	Upstream/downstream	187
9.4.3	Spatial adverbs	187
9.4.4	<i>Nya</i> ‘around, towards, inside’	189
9.4.5	Same-level axis	190
9.4.6	Centripetal/-fugal axis <i>-me, -le</i>	190
9.4.7	Origin of motion	191
9.4.8	Others	191
9.5	Prefixes	191
9.5.1	Prefixes of manner	192
9.5.2	<i>the-</i>	193
9.5.3	<i>da</i> ‘do first’, <i>ra-</i> ‘do afterwards’	196
9.5.4	Pluractional <i>e-</i>	197
9.6	Complex verbs	198
9.6.1	Reduplication	198
9.6.2	Compound verbs	199
9.6.3	Incorporated object constructions	200
9.7	Nominal derivation	200
9.7.1	<i>e-</i>	201
9.7.2	<i>xa-</i>	201
9.7.3	<i>hun-</i>	202
9.7.4	<i>ape-</i>	204
9.7.5	Nominalized verb phrases	204
9.7.6	Nominalization with <i>ka-n</i>	206
10	Verb phrases	211
10.1	What is a verb phrase?	211
10.2	Negation	212
10.2.1	Verbal negation <i>cipa</i>	212
10.2.2	Existential negation <i>cika</i>	213
10.2.3	Other negative expressions and lexical items	213

Contents

10.3	Verbal elements of the verb phrase	214
10.3.1	Serial verb constructions	216
10.3.2	Asymmetrical verb strings	218
10.4	Adverbs	224
10.4.1	Spatial adverbs and proximity	225
10.4.2	<i>meekan</i> ‘everywhere’	225
10.5	Comparison	225
11	Voice	227
11.1	Reflexive and reciprocal	227
11.1.1	Reflexive	227
11.1.2	Reciprocal	229
11.2	Middle	230
11.2.1	Lack of volitional agent	232
11.2.2	Lack of endpoint	232
11.2.3	Mode of grouping	232
11.2.4	Symmetrical point	233
11.3	Causatives	233
11.4	“Passive”	235
12	Aspect and mood	237
12.1	Aktionsart	238
12.2	Irrealis <i>bo</i>	238
12.3	Imperfective and future <i>bwa</i>	239
12.3.1	Imperfective <i>bwa</i>	240
12.3.2	Attenuating <i>bwa ju</i>	240
12.3.3	Prospective <i>bwa</i>	241
12.3.4	Negated <i>bwa(n)</i>	243
12.4	Progressive <i>kon</i>	243
12.5	Combination of <i>kon</i> with <i>bwa</i>	244
12.6	Continuative and realis <i>balan</i>	244
12.6.1	Continuative <i>balan</i>	246
12.6.2	Realis <i>balan</i>	247
12.6.3	Finally, continuative: <i>ja balan</i>	248
12.6.4	Finally: <i>bwa balan</i>	249
12.6.5	<i>kon balan</i> ‘about to, recently started’	250
12.6.6	<i>bo balan</i> ‘about to’	250
12.6.7	Summary: Combinations with <i>balan</i>	251
12.7	Perfective <i>pa (ja)</i>	251

12.8	Perfect <i>ja</i> ‘finally’	253
12.9	Present perfective <i>kon ja</i>	254
12.10	Frequentative and iterative <i>mu</i>	254
12.11	Combinations	256
13	Simple clauses	259
13.1	Word order	259
13.2	Clause types	260
13.2.1	Declarative clauses	260
13.2.2	Verbless clauses	262
13.2.3	Interrogative clauses	263
13.2.4	Imperative and prohibitive clauses	264
13.3	Modality	265
13.3.1	Assertive <i>tha</i>	266
13.3.2	Epistemic modality	266
13.3.3	Deontic modality	267
13.4	Repetitive and deictic <i>mwa</i>	267
13.4.1	Repetition	267
13.4.2	Deixis	269
14	Complex clauses	273
14.1	Coordination	274
14.1.1	Comitative <i>ma</i>	275
14.1.2	<i>kona, kon</i> ‘then’	276
14.1.3	<i>hai</i> ‘or’	276
14.1.4	Contrastive <i>ka</i>	277
14.1.5	<i>ko</i> ‘but’	277
14.1.6	<i>koin</i> ‘then’	278
14.1.7	Contrastive <i>kavi</i>	279
14.2	Subordination	279
14.2.1	Complementation	280
14.2.2	Adverbial clauses with <i>can</i>	282
14.2.3	Relative clauses	282
14.2.4	Purposive function of <i>ma</i>	284
14.2.5	Conditional <i>ma, cama</i> ‘if’	284
14.2.6	Realis ‘while’	285
14.2.7	<i>ko</i> ‘because, thanks to’	285
14.3	Insubordination	286

Contents

15 Conclusion	287
Appendix A: The Rat, the Swamp Hen, and the Squid (Philippe Gohoupe)	291
Appendix B: The 1917 Tipije War (Philippe Gohoupe)	297
B.1 Introduction	297
B.2 Story	298
B.3 Death of Bwaxat	302
B.4 Black Money and the Return of the People	303
Appendix C: The Story of the Dance Beat (Yvonne Sahilé)	305
C.1 The Flood	307
C.2 The Cannibal	310
C.3 The Boys Grow Up	316
C.4 Mathila	321
C.5 Going Home	325
C.6 Conclusion	328
References	331
Index	339
Name index	339
Language index	341
Subject index	341

Acknowledgments

This book is a version of a PhD dissertation, written between 2016–2021, and would not have been possible without the insightful comments and patience of my supervisors Professor Fernando Zúñiga, University of Berne, and Professor Isabelle Bril of the LACITO-CNRS. Thank you for taking the time to read and think, and for your patience. I came to you too rarely.

Florian Matter, Dominique Knuchel, Sarah Dopierala, Joël Schregenberg, für ds Läse vo Kapitle u natürlich für ds Mitdänke. Am Flo none bsungere Dank, für ds unermüedliche Hingrfrage vo myne Aanahme, für ds Daate-wöue-gseh, u ständig mit \LaTeX , Chaarte, u angerne Sache cho häuffe.

Hao Cakeo, e holeke i wî-je! Jacob Ganap Oué, Jean-Philippe Oué, André Nigai Kalène, Christophe Keela Pei, holeke thuan nyakovwe i vaaya fine thoatit, li délire ka meeka li been aman! Nyasi Baptiste Ucian, Elise Kalène, e holeke i hun-titabwi ko i ape-thapoke kan, Jethro ma Hedwige Delly ko i hun-wago, ka meeka li apuli xa-moo pala-vwe ko i hun-moo-le! Un deuxième merci encore au groupe de travail, qui sont les deuxièmes auteurs de ce livre.

Daniel Pei, pour m’avoir accueilli, introduit, et logé, Cécile Pei pour m’avoir nourri pendant si longtemps, Richard Pei, Eugénie Pei, Kafeyat Pei, Roger Pei, Kukwe Pei, et toutes les mamans et papas qui m’ont élevé pendant ce temps-là, et Pwiya pour son amour maternel. Merci à Alain Mindia Pei et sa famille pour le jardin, l’accueil et l’amitié.

Doriane Pei, Béty Gohoupe pour avoir été des soeurs, et pour m’avoir montré un côté du pays qui me reste chaud au coeur. Aouh bwaau, les jacks et les soirées à la plage avec vous me manquent!

My thanks to Mandana Seyfeddinipur, Sophie Salfner, and Stephanie Petit of ELAR for their patient work.

My family, Olivia Schneider, and Ghada ben Yahia, for support and patience along the way. It was a long one, and I appreciate your help more than I’ll ever be able to say.

A heap of gratitude belongs to Martin Haspelmath and Sebastian Nordhoff for the comments and help with putting the thesis into the shape of a published grammar. Thanks for their valuable insight and attentive lecture also go to Ezekiel Bolaji, Benjamin Brosig, Christian Döhler, Philip Duncan, Carrie Dyck, Lachlan

Acknowledgments

Mackenzie, Jean Nitzke, Tim Ongenae, Elliott Pearl, Katja Politt, Tabea Reiner, Yvonne Treis, Jeroen van de Wijer, Mary Ann Walter, as well as two anonymous reviewers. Thank you for your help!

Abbreviations

Glossing abbreviations

1	first person	DEM	demonstrative
2	second person	DIR	direct
3	third person	DIR.CF	away from speaker ("centrifugal")
A	argument marked like the agent in prototypical transitive action verb	DIR.CP	towards speaker ("centripetal")
ABSP	absolutive	DISC	discourse marker
ACCP	finally	DIST	distal
ADD	additive	DU	dual
ADV	adverb	DUR	durative
AGT	agent	EXCL	exclusive
ALR	present perfective ("already")	EXIST	existential
ANA	anaphoric	EXPL	expletive
ANIM	animate	FOC	focus
ART	article	FREQ	frequentative
ASS	assertive	FUT	future
ATT	attenuative	HAB	habitual
BEN	benefactive	INAN	inanimate
CAUS	causative	INCL	inclusive
CLF	classifier	IND	indicative
CNJ	conjunction	INDF	indefinite
CNTR	contrastive	INS	instrumental
COM	comitative	INTS	intensifier
COMP	complementizer	IPFV	imperfective
COND	conditional	IRR	irrealis
CONT	continuative	ITER	iterative
CPR	comparative	LINK	linker
DEF	definite	LOC	locative
DEICT	deictic	MID	middle
		NEG	negation

Abbreviations

NMLZ	nominalizer	RECCONT	have been doing for some time
NSG	non-singular	RECP	reciprocal
NSPEC	non-specific	REFL	reflexive
OBJ	object	REL	relative
OBL	oblique	REP	repetitive
ORD	ordinal number	S	argument marked like that of an intransitive change of state verb
P	argument marked like the patient in prototypical transitive action verb	S _A	S marked like A
PFV	perfective	S _P	S marked like P
PL	plural	SBJ	subject
POSS	possessive	SG	singular
PROG	progressive	SPEC	specific
PROH	prohibitive	SUBR	subordinator
PROX	proximal	THE _{DUR}	durative <i>the-</i>
PSM	possessum	THE _{PUNC}	punctual <i>the-</i>
PSR	possessor	TOP	topic
PUN	punctual	TR	transitive
PURP	purposive		
REAL	realis		

Data sources and corresponding FLEx text titles

AG1	2018-08-09 Adèle 1	DT	2017-10-09 Tipije Nigai
B1	2017-08-22 Wanaa Batis	Dy	2017-10-30 Deli
B2	2017-08-29 Batis elicitation	EB	2018-07-05 Enterrement Batis
B3	2017-09-05 Batis elicitation	EB	2018 Enterrement We
Bw	2017-10-16 discours Pei	ET	2018 Enterrement Tontons
CD	2017-07-21 Chant de deuil	G1	2017-07-31 Keela
CP1	2018 enterrement 1	G2	2017-08-16 Keela
CP2	2018 enterrement 2	G3	2018-07-11 conte poulpe
D1	2017-07-31 Ningai	G4	2018-07-13 Jacob Oue
D3	2017-08-30-Nigai Thèa	G5	2019-07-17 Ho Hava Ganap
D6	2018-10-13 Dédé Nêlêmwa	G6	2019-08-11 Ganap
D7	2018-10-26 Dédé gramm. Nêlêmwa	G7	2019-08-18 Gana grammaire
DP	2017-10-30 Deli pirogue montagne	GB	2019-08-11 Chant bilingue Gana
		GC	2018-09-14 conte
		GD	2018-09-18 dictons

GL	2019-07-03	Lexique Gana	L2	2017-10-18	Discours du Chef apéro
Gl1	2017-08-23	Wanaa Gale	L3	2017-10-21	discours chef retour
GP	2017-08-11	récit de pêche	N1	2017-07-27	Nigai
GP	2017-08-11	récit de pêche	NE1	2018-09-13	Nigai
GS	2019-08-11	Chanson - Gana	NG	2018	Discours Néa Gale
GT	2017-10-05	Gana Tipije	PE1	2017-10-30	Pauty Ecole et punition
Hc1	2016	Tipije 1	PE2	2017-10-30	P_P_Ecole
HC19	2019-07-09	Hao Cakeo	PJ	2017-10-31	transcription Pauty
HC2	2016-11-15	Le poulpe et le rat	PL	2019	Pwai et Kalen lexique
J1	2017-10-13	J-P tha	PQ	2017-10-30	Pauty Questions
J2	2018-07-19	JP	Pw	2017-09-29	Pwai
J3	2018-07-20	JP	RP	2017-08-06	rivière pollution
J4	2019-07-11	JP grammaire	TE	2017-08-29	texte écolo
J5	2019-07-21	JP grammaire	TN	2018-07-06	transcriptions notes
J6	2019-07-22	JP see me	V1	2017-09-05	le vent du Nord
J7	2019-07-25	JP grammaire	V2	2017-10-	le vent du Sud
J8	2019-07-29	JP grammaire	X1	2017-07-24	Teganpaik
J9	2019-08-05	JP ka	X10	2017-09-01	elicitation
Ja1	2017-07-23	Mahéna	X11	2018-07-17	
Jn1	2017-07-31	Jonas	X12	2018-07-04	élicitation
JN1	2018-11-07	JP Nelemwa 1	X2	2017-07-27	
JR	2017-08-29	redaction	X3	2017-07-29	
JR2	2017-08-30	redaction	X4	2017-07-31	
JU	2018	enterrement	X5	2017-08-02	
JV	2018-11-27	Vent du Nord JP	X6	2017-08-04	
K1	2017-07-27	Kito	X7	2017-08-11	Kito Keela
K2	2017-10-05	Kito	X8	2017-08-18	
KE	2017-11-08	Kaina école	X9	2017-08-25	elicitation
KG	2019-08-30	Kito Gas Station	XL1	2017-09-19	Leenhardt
KL	2017-08-06	Kaina long	XL2	2017-10-05	Lexique
KM	2017-11-08	Kaina Miel	XL3	2017-11-24	Leenhardt 570-
KP	2017-11-08	Kaina pauvreté			
L1	2017-10-16	discours du chef			

1 Typological overview

This chapter gives some introductory information on the typological profile of Vamale. Vamale, or Hmwaeke, is spoken on the northeast coast of New Caledonia, about half-way between the administrative centres of Hienghène and Touho. As a result of colonization, the language has gone from perhaps 2000 to 180 speakers, with most children speaking French instead. The geographical and historical context is described in Chapter 3. Vamale is a Southern Oceanic language, an eastern Voh-Koné variety in the Northern branch of Mainland New Caledonian.

Vamale ([ˈva.ma.le]) is an Oceanic language and conforms in many aspects to the canonical family profile established by Ross (2004). It is head-first, uses verbs to express meanings for which European languages use other word classes, e.g. numerals and adjectives, and makes ample use of complex verb constructions. Vamale features dual and plural, as well as inclusive and exclusive pronouns. There is no gender, but animacy plays a role in object marking on verbs, among other things. It has no tense in the strict sense and uses aspectual and modal particles to express its predicate's temporal makeup.

The language fits in neatly with its immediate, New Caledonian neighbors: like other Northern branch languages, Vamale has a large consonant inventory (35 phonemes), and features contrastive length and nasalization in vowels (20 phonemes). Stress is mostly penultimate, with some influence of syllable weight, syllable position in the word, and (g-)wordhood status.

However, there are also rarer facets to Vamale. Verb agreement, for example, shows tripartite alignment.

1.1 Phonology

Vamale's consonant and vowel phonemes are shown in Table 1.1 and Figure 1.1. As is typical of the area, there are many consonants, including labiovelarized and aspirate ones. Voiced plosives are pre-nasalized, and historical geminates have become “fortis” consonants, either voiceless or aspirated plosives, or voiceless nasals and liquids. They attract stress and tend to nasalize the following vowel: [k^hɛ̃k^hɛ̃] ‘parrot’, /han/ [hãn] ‘to go’.

1 Typological overview

Table 1.1: Consonants in Vamale. Non-phonemes are in brackets.

	Bilabial	Lab. Bilab.	Labiod.	Lab. Labiod.	
Plosive	p ^h p ^{mb}	(p ^{hw}) p ^{w mbw}			
Nasal	ɱ m	ɱ ^w m ^w			
Tap					
Fricative			f v	f ^w v ^w	
Approximant					
Lat. Approx.					
	Alveolar	Palatal	Velar	Lab. Velar	Glott.
Plosive	t ^h t nd	(c ^h) c ^ɲ	k ^h k ^{ng}		
Nasal	ɲ n	ɲ̃ ñ	(ŋ) ŋ		
Tap	(r)				
Fricative	s		x ɣ	x ^w	h
Approximant		j		w	
Lat. Approx.	l̥				

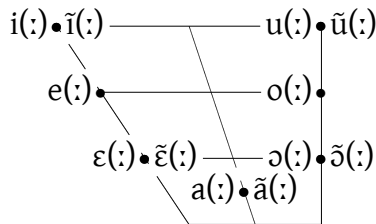

Figure 1.1: Vowel qualities in Vamale

There are five phonemic vowel qualities /a, e, i, o, u/, with phonemic nasality and length: *tha* ‘assertive particle’ *thâ* ‘excrement’ *the* ‘algae’ *thê* ‘rock’ *tho* ‘call’ *thu* ‘banyan tree’. The phonemic status of [ɔ̃] and [ũ] is a matter of analysis, as there are no minimal pairs with oral counterparts.

All vowels following nasal stops tend to be nasalized. There is limited allophonic variation in vowels, concerning chiefly /a/ pronounced [a] after labiovelar approximants and /u/, which is pronounced [y] after /i/, e.g. *vwa* ‘do’ [v^wa], *si-ung* ‘hand-1SG.POSS’ [sɲŋ]. Possibly as a result of contact with neighbouring languages featuring more vowel phonemes, /o/ and /e/ have more open allophones in short closed syllables ([sɛn] ‘poison’) or before a consonant in the same syllable ([ɔ:t]

‘rope, tendon, vine’), than in open ones ([ko] ‘at’) or in long nasal-bounded ones ([so:m] ‘swim’). Consonants may be lenited or fricativized in fast speech, and phonemically voiceless nasals and liquids may not be audibly realized as such (e.g. [m̥ũ:n] ~ [mũ:n] ‘smoke, dust’), but this is not a regular process.

Syllables never feature two consonants one after the other ((C)V(:)(C)), and may only end on a vowel, a nasal, or /p,t,c,k/, e.g. [t^hu] ‘banyan tree’, [t^hu:p] ‘bathe’, [tu:n] ‘clan’. The early French loanword *cheval* [ʃø.val] ‘horse’ was phonologically adapted to [so.van], as -l cannot occur syllable-finally.

Whether Vamale has true diphthongs (where both vowels occur in the same syllable) depends on the analysis. The second vowel in a syllable is always either /i/ or /u/ and not functionally distinct from the glides /j/ and /w/. Either Vamale has only diphthongs ending on /i/ or /u/, or Vamale has no diphthongs but may end the syllable on a glide.

The main stress is on the second-to-last (penultimate) syllable for most words, or on the first of three syllables, e.g. [v^waⁿ.di] ‘peel by hand’, [a.pu.li] ‘person’. Vamale does not have native phonological words with more than three syllables: though morphologically speaking, there are longer structures, speakers split these up into intonational units of three syllables maximum, e.g. *xa-vwa-tau* ‘NMLZ-do-impact (fisherman)’ is pronounced [ya.v^wa.^htau] but the four-syllable word *xa-vwa-buke* ‘NMLZ-do-flower (flower seller)’ is pronounced [ya.v^wa.^hmbu.ke]. Derivational prefixes, transitivity marking suffixes, possessive markers and other grammatical morphemes may behave differently stress-wise: bisyllabic morphemes may be counted as one stress unit, and some suffixes are even ignored completely, e.g.

- [mu.lip] ‘life’
- [mu.'lip.ga.vwe] ‘life-2PL.POSS’
- [ɲi.mã] ‘heart, thought’
- [ɲi.mã.ke] ‘to think’

1.2 Example sentences

The example sentences have three different sources. The reference is given in brackets under the examples. Most of the examples were elicited or found in recorded free text (see §2 for details on recording and transcription methods) and can be traced to an audio file via the FLEx database uploaded to ELAR. The

1 Typological overview

text collection on FLEx can be ordered by “Abbreviation”. The abbreviations used correspond to the code of one or two letters and sometimes a number, and the number after the colon is the line in the text (e.g. AG1:394). Other examples were not audio-recorded, but noted in writing. Their references start by the date of the entry (e.g. 180722 p.93, or 07.11.18 p.93). Other examples were transcribed from audio files but not yet included in a Flex file, and are referenced by the filename and the time stamp, also on ELAR (e.g. vamale-181107.jpnelemwa-04: 00:00:30-00:00:32). Unreferenced examples were constructed for the purpose of writing up the grammar, and checked with speakers.

1.3 Person forms and demonstratives

Vamale distinguishes subject (A/S_A) and object (P) person forms (Table 1.2). There are three numbers, singular, dual, and plural. The language distinguishes inclusive (‘us and you’) and exclusive (‘us but not you’) first person forms. Object pronouns are never independent as seen in (2), whereas the others may be attached to the verb or occur in a free form (1).

Table 1.2: Subject and object markers for active and stative verbs

		cross-indexes		pro-indexes	
	Free form	A=/ S _A =	-S _P	-P	
1SG	<i>io</i>	<i>e=</i>	<i>-o(ng)</i>	<i>-o</i>	
1DU.INCL	<i>gasu</i>	<i>gasu=</i>	<i>-gasu</i>	<i>-kaeu</i>	
1PL.INCL	<i>gaa/gase</i>	<i>ga(se)=</i>	<i>-gaa</i>	<i>-kaa</i>	
1DU.EXCL	<i>abu</i>	<i>abu=</i>	<i>-abu</i>	<i>-(a)bu</i>	
1PL.EXCL	<i>abe</i>	<i>abe=</i>	<i>-abe</i>	<i>-(a)be</i>	
2SG	<i>go</i>	<i>go=</i>	<i>-go</i>	<i>-ko</i>	
2DU	<i>gau</i>	<i>gau=</i>	<i>-gau</i>	<i>-kau</i>	
2PL	<i>gavwe</i>	<i>gavwe=</i>	<i>-gavwe</i>	<i>-kavwe</i>	
3SG	<i>ia</i>	<i>a=</i>	<i>-(e)a</i>	<i>-(e)a</i>	
3DU	<i>lu</i>	<i>lu=</i>	<i>-lu</i>	<i>-lu</i>	
3PL	<i>le</i>	<i>le=</i>	<i>-le</i>	<i>-le</i>	

- (1) *e=xale-ko ka=yo*
 1SG=see-2SG.OBJ SBJ=1SG
 ‘I see you.’

- (2) * *e=xale go*
 1SG=see 2SG
 (for: 'I see you')

Most personal pronouns look similar to their free form counterpart, and were probably historically derived from them. Suffixes indexing objects and stative subjects (s_p) always refer to people or animals, whereas active subjects (A and s_A) do not mark the animacy of their referent.

- (3) *phwaat i=thala*
 clean DEF.SG=knife
 'The knife is clean.'

- (4) *a=tabo i=thala*
 3SG=sit DEF.SG=knife
 'The knife lies (there).'

The stative subject (s_p) and the object suffixes cannot co-occur with an independent person form (pro-indexing person forms).

Demonstratives distinguish number (singular, dual, plural) as well as proximity (proximal *-hni*/distal (*-na*)). The demonstratives resemble in part the articles, which are also listed in Table 1.3. Two demonstratives, *na* and its repeated form *ha* (meaning it is used if the information is repeated, often with insistence), cannot be used as predicates, nor do they mark number or proximity: they are deictic pronouns that take a nominal predicate. They are illustrated in (5) and (6).

Table 1.3: Demonstrative pronouns and articles

	Demonstrative pronouns		Articles	
	Proximal	Distal	SPEC and DEF	SPEC and INDF
SG	<i>e-hni</i>	<i>e-na</i>	<i>i</i>	<i>(e)ca</i>
DU	<i>muu-hni</i>	<i>muu-na</i>	<i>mu</i>	<i>muca</i>
PL	<i>ni-e-hni</i>	<i>ni-e-na</i>	<i>li / ni</i>	<i>ca(been)</i>

- (5) *na yo*
 DEM 1SG
 'It's me.'

1 Typological overview

- (6) *li=xa-vuki vai ko-n thexhwaade, [ha] [li=kalen]*
DEF.PL=NMLZ-stem stone on-NSPEC T. DEM.REP DEF.PL=K
'The owners of Thexhwaade rock, are the Kalens (and no-one else).'
[DP:12]

1.4 Element order

Like many other Oceanic languages in the area, Vamale is predominantly VOS (7), though the pragmatically most important element (usually the subject) is frequently fronted (8). Modifiers follow the modified, as in (9).

- (7) *le=fwii i=jamwa-m ka=li=mani*
3SG=wake.up DEF.SG=father-1SG.POSS SBJ=DEF.PL=bird
'The birds wake my father up.'
- (8) *i=jamwa-m, go=fwi-a*
DEF.SG=father-2SG.POSS 2SG=wake.up-3SG
'Your father, you wake him up.'
- (9) *go=fwii i=jamwa-m a=meebam*
2SG=wake.up DEF.SG=father-2SG.POSS REL=sleep
'You wake up your sleeping father.'

1.5 Argument coding

Vamale has several strategies for argument coding. Its differences from those of Vamale's closest relatives, are likely due to contact with surrounding languages. (Pro)nominal subjects are marked differently from objects. As with all Northern New Caledonian languages, subject noun phrases of all verb classes are marked with dedicated (pro-clitic) particle, in this case *ka*, e.g. (10), or *a* when following a consonant-final word (e.g. *a=soom a=ya* 'she=swims SBJ=she'). However, *ka* 'SBJ' is optional and unusual for intransitive subjects, while it is obligatory for transitive ones. This is a tripartite alignment system as illustrated in Figure 1.2, and found in other Voh-Koné languages as well.

"Active verbs" may be either transitive or intransitive. They index transitive subjects *A* identically to agent-like intransitive subjects *s_A*, and distinguish them from objects *P*, as in (10). Another group of verbs, "stative verbs", are always intransitive (11), and mark the subject *s_p* similarly to undergoers in transitive

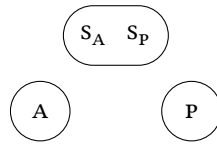

Figure 1.2: Alignment of noun phrases

verbs, but are distinct from them (see Table 1.2 for the forms). It is a tripartite system shown in Figure 1.3, but differently so than the one for noun phrases.

- (10) *e=bune i=balô ka=yo*
 1SG=steal DEF.SG=ball SBJ=1SG
 ‘I steal the ball.’
- (11) *xawe-ong ka=yo*
 young-1SG SBJ=1SG
 ‘I am young.’

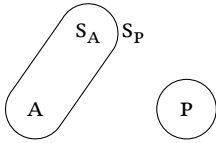
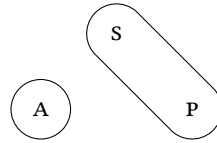

Figure 1.3: Alignment with verbs

Figure 1.4: Alignment with *ka-n* nominalizations

This means that additionally to split-transitivity, which is common in the area, Vamale features a split along A, $S_A/S_P/P$. Some constructions, however, show yet different patterns: de-verbal nominalizations exhibit ergative alignment for inanimate subjects and undergoers, see (12) and Figure 1.4. This last strategy is most likely related to possessive constructions, and uses similar morphemes (*ka* and *ka(-n)*, respectively). With active verb subjects (S/A -arguments), the cross-indexes occur under all circumstances, but with patient objects (P -arguments) and stative subjects, the pro-indexing suffixes cannot co-occur with the full nominal.

- (12) *i=hun-coopwi ka i=vai*
 DEF.SG=NMLZ-bury LINK DEF.SG=stone
 ‘the burying of the stone’

1 Typological overview

- (13) *i=ape-tabo ka i=vai*
DEF.SG=NMLZ-sit LINK DEF.SG=stone
'the position of the stone'

Ditransitive constructions distinguish human recipients from non-human ones; *nya-si-* 'put-hand' is used for humans and *nya-ko* for non-humans and humans in informal contexts alike. The markers can be discontinuous, as seen in (15). The constituent order is relatively free and subject to pragmatic preferences (compare (14) and (15)).

- (14) *e=ila-ke nyasi-m i=vai ka=yo*
1SG=make.request-TR BEN-2SG.POSS DEF.SG=stone SBJ=1SG
'I (politely) ask you for the stone (lit. I request the stone from you).'
- (15) *a=nya li=saleka-n si li=apuli*
3SG=give DEF.PL=property-3SG.POSS BEN DEF.PL=person
'He gives his things away to the people.'

1.6 Word classes

Verbs can be sub-classified into free and dependent verbs, stative (i.e. state-like) and active (activity-like) ones. Nouns distinguish classifiers and different subclasses nouns depending on their possessive morphology and ability to head a phrase. There are a number of subordinators, tense/aspect/mood markers, different kinds of pronouns etc. Typologically interesting aspects include the lack of a dedicated numeral class, whose function is instead covered by stative verbs, e.g. *thalo-lu* 'two-3DU' 'there are two, they are two'. There are no adjectives either, as is common in the area, where predicative adjectival functions are covered by stative verbs, and attributive ones by relative clauses, as seen in (16) and (17).

- (16) *vun-eo(ng)*
blue-1SG
'I am blue.'
- (17) *a=thêên a i=thamo (a=) en maa-n*
3SG=run SBJ DEF.SG=woman REL= fine face-3SG.POSS
'The beautiful (lit. 'fine-faced') woman is running.'

The negator *cipa*, the assertive marker *tha*, and epistemic mood markers such as the irrealis conditional *cama* 'if ever' can precede both verbal and nominal (i.e. equational) clauses, see (18).

- (18) *tha cipa=le=hân*
 ASS NEG=3PL=go
 ‘They did not leave.’

1.7 Verbs and verb phrases

Verbs in Vamale are either free or dependent, meaning they may head a verb phrase or not. Serial verb constructions and other complex verbs are common and a productive way to express a series of related events, a complex action, or just to modify a verb.

Free verbs may take person-indexing proclitics (in the case of active verbs) or suffixes (for stative verbs), but usually omit them if in the imperative or prohibitive mood. The latter is marked by a particle *cipii* (19), related to the predicate negator *cipa* (20).

- (19) *cipii (go)=see!*
 PROH 2SG=cry
 ‘Don’t (you) cry!’

- (20) *cipa=go=xaleke?*
 NEG=2SG=see
 ‘Don’t you see?’

A set of particles precede the predicate to mark aspect and mood, as in (21). They can be combined, with sometimes idiosyncratic new meanings, and are sensitive to the verb’s semantic nature (“aktionsart”). Their basic members are the imperfective *bwa(n)*, perfective *pa*, perfect *ja*, progressive *koon*, irrealis (*b*)*o*, continuative/realis *balan*, and frequentative/iterative *mu*.

Verbs do not inflect for tense; indeed there are no dedicated tense markers, though the imperfective marker *bwa* and the irrealis *bo* are used to suggest future actions (as in ex. 21), progressive *koon* implies (relative) present tense and the perfectives *pa* and *ja* refer to the past.

- (21) *e=bwa=yahan*
 1SG=IPFV=leave
 ‘I will leave, I am just leaving.’

1.8 Derivation

Many verbs are nominalized simply by putting an article before them, and some nouns can be verbalized by adding the transitive suffix *-ke*. Indeed, entire verb phrases with arguments (but not tense or aspect markers) may be nominalized with an article. Other derivational affixes are the locative nominalizer *ape-* (*ape-tabo* ‘place-sit; chair’), the manner nominalizer *hun-* (*hun-mata* ‘manner-sing; singing style’), the instrumental *e-* and the agentive *xa-*. While *e-* is ancient, others can be transparently reconstructed as former preposed nouns: *ape-n* ‘trace’, *xa-* from *xayu* ‘man, male’. See (12) for two examples of nominalizers.

1.9 Nouns and noun phrases

Nouns can be classified as inalienable (obligatory possessive morphology) or, if the morphology can be omitted, as alienable (see Table 1.4 for the suffixes). This follows a semantic logic, as is typical of Oceanic languages: inalienable nouns include kinship terms, body parts, and other parts of an individual (e.g. *dedoong* ‘shadow-my’). Nouns can be possessed via direct (i.e. suffixal) or indirect (i.e. clitical) constructions, which usually depends on their alienability. However, a small number of nouns are alienable yet have directly possessed forms showing etymological stems: *fedat* ‘blood’, *fedal-ong* ‘my blood’. Nouns are either specific (using a definite or an indefinite article), or generic (without an article), as shown in (22). Number is also shown on the article instead of the noun. The only type of inflection found on nouns is adpossessive person marking (for animate possessors), and the formerly independent linker *-n* indicating that the noun is possessed by a usually post-poned fully nominal possessor (24). Vamale has no adjectives; instead, nouns are modified via relative clauses.

- (22) *i=xa-vwa* *i=xam*
DEF.SG=NMLZ-do DEF.SG=mat
‘the maker of the mat’

- (23) *i=xa-vwa* *xam*
DEF.SG=nmlz-do mat
‘the mat-maker, the maker of mats’

Table 1.4: Possessive suffix paradigms

		inalienable	alienable
SG	1	-ng	-eong
	2	-m	-go
	3	-n	-ea
DU	1INCL	-ju	-gaeu
	1EXCL	-bu	-abu
	2	-u	-gau
	3	-lu	-lu
PL	1INCL	-je	-gaa
	1EXCL	-be	-abe
	2	-vwe	-gavwe
	3	-le	-le

1.10 Possessive constructions and compounds

An adpossessor nominal is unmarked (e.g. *udee* in (24)) and follows the possessed noun, which in turn carries a linker suffix *-n* if the stem ends on a vowel, e.g. *mwa-n*.

(24) *mwa-n udee*
 house-LINK medicine
 ‘pharmacy’

(25) *inya-m*
 mother-2SG.POSS
 ‘your mother’

When the possessed noun is an inalienable term, it is marked for adpossessor person (see Table 1.4, and (25)). Nominal compounds (26) are formally very similar to some nouns modified by relative clauses (27). However, the latter forbids articles in the modifying noun phrase, and the stress contours differ: a compound noun is treated as one unit instead of several.

(26) [i.t^hamõ'xa.o.ḡũ]
i=thamo-xhaohmu
 DEF.SG=woman-elder
 ‘the old woman’

1 Typological overview

- (27) [i^ha,mõ 'ya,so:m]
i=thamo (a= i=) *xa-hnyimake*
 DEF.SG=woman (REL= DEF.SG=) NMLZ=swim
 ‘the swimmer woman, the woman who swims’

1.11 Prepositions

Vamale prepositions can be divided into prepositions proper (e.g. *patemwano* ‘very close by’) and “relational nouns”, which have nominal morphology and can sometimes be linked to a (voiced) nominal counterpart, see Table 1.5.

Table 1.5: A selection of prepositions

Relational nouns		Related noun or meaning
<i>cela-n</i>	‘next to’	<i>jela-n</i> ‘side’
<i>pwa-n</i>	‘on top of’	<i>bwa-n</i> ‘head, top’
<i>can-hawâ-n</i>	‘facing’	in-face-LINK
<i>cake-bwa-n</i>	‘on the other riverbank’	scoop.water-top-LINK
<i>cai-n</i>	‘behind an animate entity’	<i>jèi-n</i> ‘back’ (Cèmuhî)
<i>xala-n</i>	‘under’	
(<i>can</i>) <i>dawee-n</i>	‘(in-) between’	
<i>ca-n</i>	‘in, at’	
<i>ko-n</i>	‘on, at’	
<i>pathabua-n</i>	‘before (spatial and temporal)’	

Prepositions introduce adjuncts like points in time or locations, but also oblique noun phrases (*nyako, nyasi*, see (28)), causes (*ko*), adverbial clauses (*can*), and subordinate clauses (*ma, koma, cama*).

- (28) *e=vi nyakoo-m*
 1SG=say OBL-2SG.POSS
 ‘I say (it) to you.’

1.12 Subordinate clauses

There are relative clauses, adverbial clauses, conditional clauses, and, related to the latter, complement clauses. Relative clauses are the main way to modify a

noun, adverbial clauses are one of the most important strategies to modify a verb, and many verbs require a complement clause. Relative clauses are introduced by the pro-clitic *a*, probably related to the third person singular cross-indexing pronoun (*a*), see (29).

- (29) *li=dube a=xakoo(-le)*
 DEF.PL=deer REL=wild-3PL
 ‘the wild deer’

Both the relativizer *a* and the subject-indexing pro-clitic may be omitted (the latter only if the subject of the main clause is the same as the relative one). Subordinate clauses are formally identical to main clauses in both word order and content; only the subordinator marks the subordinate clause as such. Coordinate clauses are identical to subordinate ones except that that the subordinate clause may be fronted (30), while coordinate clauses have a fixed order.

- (30) [*ma le=tiike*], *tha vwa ca=peipa la*
 SUBR 3PL=write ASS EXIST INDF.SG=paper here
 ‘For them to write, there is some paper here.’

As shown in (31), adverbial clauses are introduced by *can*; contrary to other types of subordinate clauses, this type must omit the subordinate subject if it has the same referent as the main clause’s. Complement clauses following verbs of opinion, speech, thought, etc are introduced by the complementizer *hapi*, which developed from *a=pii* ‘s/he says’ (32). The other complement clauses follow either *ma* ‘with; if, when; in order to’ (33), or, in more specific contexts, *ko* ‘because; on’, *ko-ma* ‘in order to’, and other particles.

- (31) *go=han [can pala kon yee]*
 2SG=walk ADV.SUBR talk OBL.NSPEC tree
 ‘You walk while talking about trees.’

- (32) *vaang [hapi na hmwaana]*
 unknown COMP DEM like.this
 ‘It is not clear that it is like this.’

- (33) *nyima-m [ma go=pala]?*
 will-2SG.POSS COMP 2SG=talk
 ‘Do you want to talk?’

2 Methodology

This chapter provides meta-information on our data collection, that is, that of the work group and me. It gives an overview of the methods used by us to gather the data discussed in the book. This includes the methods and thematic foci of data elicitation, the speakers we worked with in general and who the main consultants were, as well as some notes on climate and culture.

2.1 Types of data recorded

While the author hopes that this will not be the last work done on the language, this work attempts to give as comprehensive a description as possible. Since this may well be the last record of the language, and in any case the only one of Vamale as spoken in this period, the usability of the data is crucial. The work group recorded as much as possible, with members of every clan, spanning every generation but the youngest, and both genders (though a focus on males was hard to avoid for cultural reasons). We made videos of ceremonies, everyday activities, in Vamale as well as in other languages, and still missed hunts, funerals, and a women's craft week. The work group usually met three times a week and spent the entire day together. The days in between were spent transcribing and annotating, as well as preparing the next session. The elicitation sessions were usually structured in the following way: once the date, speaker, and location had been recorded, consent was established, and an overview of the topics of the day was given, in case a consultant wanted to avoid a certain topic. While the interviews with members of the local clans were conducted in Vamale as much as possible to avoid priming, the elicitation sessions with the work group most often featured questions and discussions in French, and answers in Vamale. Coffee, tobacco and food were provided by the researcher, along with customary gifts when meeting a consultant for the first time.

Data from transcribed data incorporated into FLE_x carries references in the format L(L)(N):NN(N), e.g. KL:126, where the first part designates the text in the FLE_x database, and the second the line number. Other data either shows the title of the audio recording and the time signature of the utterance, or the date and page of the notebook entry. Some data was overheard or so frequently used that no reference was given.

2 Methodology

As explained in other sections (§4.3, §3.2.2), there are few villages in the area that speak a single language, and Vamale is spoken exclusively in multilingual environments. French dominates in most places, but even where most people communicate in Oceanic languages, Vamale is almost never the majority language. This complex sociolinguistic situation is one reason for the relatively long period spent in the field, as every clan idiolect was recorded. The recordings are all marked for the speakers and place involved, leaving material for future research on language variation. A simple dictionary was compiled in the field using Leenhardt's (1946) wordlist and existing dictionaries of other languages as prompts, as well as the recorded data. Priming and misunderstandings were unavoidable, and language attrition contributed to the difficulties. Several elicitation sessions were dedicated to cross-checking this data and illustrating it with example sentences, and elders were visited explicitly to check old words. All materials are open-access and available online via the Endangered Languages Archive (ELAR), collection 0470. The recorded data is also stored in the Archive of the Northern Province in Hienghène, as well as on SD cards left with the respective speakers.

2.2 Equipment used

The project used the following equipment:

- Sennheiser headphones HD201, with a splitter to listen to recordings in groups
- Røde NTG-2 super-cardioid “shotgun” microphone (a dead cat is appropriate on the coast due to the winds), and a Sennheiser EW122 lavalier microphone.
- a Canon XA30 camera, which can record audio in .wav format, has a powerful visual zoom, but a weak battery
- a Zoom H6 recorder

2.3 Field trips

A first field trip was undertaken in 2016, chiefly to ask for permission and support in the speaker area and from the relevant organizations: the Academy of Kanak Languages, the University of Nouméa, and the local customary authorities. This took two weeks, during which first lexicographical data were gathered.

The research in 2017 lasted a little over 5 months, between June and December, the dry season. The first major stay was dedicated to gathering data from every speaker clan, and to do so in the form of stories and life recollections, as this was important to legitimize the project in the eyes of the speaker communities. The interviews were usually public, and several people would sit, listen, and occasionally chime in. I often mixed grammatical elicitation with text production, i.e. the first part would ask the consultants to check prepared sentences in Vamale or translate French ones, and the second part would invite them to speak about what they wanted. The latter part often revolved around the societal changes that occurred in their lifetimes, but some also commented on climate change, or narrated oral history. Most of these interviews were filmed as well, depending on the consent given (however, the camera battery gave out more than once in the first year). I also gathered botanical and zoological data and filmed people gardening and fishing, as well as building roofs and boats. Whenever possible, I participated in the activities I documented. The second field trip in 2018, around four months long, shifted the focus more to elicitation sessions, as the Bwattoo, Nêlêmwa, and Cêmuhî grammars were used as reference points to identify gaps in the description of Vamale. A third trip in 2019 focused on filling gaps, handing over data to the respective speakers (on SD cards, which was useless as most lack access to card readers; will be done differently next time), and transcribing as much as possible of the data gathered in the previous years.

Because of the amount of data recorded, time in the field did not allow for a complete transcription of the recordings. In order to alleviate the task, the author attempted to hire and train two locals to help him transcribe. This did not succeed as people were not used to sitting for hours, nor to working with computers. The most useful technique was to ask people to listen to the recording and repeat it clearly word for word for him to write down. This was particularly effective for the recordings of elders who were difficult to understand.

2.4 Consultants

Working on Vamale meant finding speakers willing to work with the researcher for free (except for transcriptions), in order to perpetuate the local custom initiated by French researchers. In exchange, consultants and speakers were welcome to discuss the goals of the project and change them. The project was assigned a team of three motivated representatives of the most powerful local clans. Apart from the crucial fact that they had the time and the motivation to do it, they each had a different array of languages and social relations, which was very useful.

2 Methodology

From this nucleus grew a loose team of speakers joining in. The team members had lives and priorities of their own, and the group's makeup changed several times over the three stays.

This section says a few words about the four main consultants. My deepest gratitude belongs to all of them. Other important people were Mr. Baptiste Ucian who kick-started the lexicon and most of the first months' elicitations, Mrs. Elise Kalène who gave a lot of her time to elucidate phonemes, and the entire population of the villages who were happy to share their views on the world, answer spontaneous questions, and always sympathetically asked how the work was going.

2.4.1 André Nigai Kalène

Mr. Kalène is the eldest brother of Tiouandé's chieftain and grew up bilingual in Pije and Vamale. Extremely knowledgeable in traditions and a skillful boat-and house-builder, he was the most patient and reliable consultant and, in the beginning, walked an hour every day to our meetings. He has been politically invested in protecting indigenous rights his entire life. His extensive family network helped us tremendously.

2.4.2 Christophe Keela Pei

Mr. Pei is the herald of the powerful Pei clan, which housed and fed the author for ten months. Except for French, Mr. Pei is one of the rare monolingual speakers of Vamale, which helped decide whether a word was Vamale or a loan. Mr. Pei is a master fisherman and hunter. We often gathered at his house during the first research period.

2.4.3 Jacob Keela Ganap Oué

Mr. Oué is the eldest man in the land-owning clan of Wanaa and knows much about traditions, land ownership, and local history. A passionate gardener and ecologist, Mr. Oué spent time with Mr. Kalène rehabilitating mangroves, and is very knowledgeable about plants and animals. We spent most of our elicitation sessions at his house and he hosted the author for the last month. Mr. Oué speaks Vamale, Pije, and Fwâi, as well as excellent French.

2.4.4 Jean-Philippe Emyl Téin Oué

Mr. Oué was the only one in the group who was the author's age, and we spent a lot of time together in his garden, at his house, in his woods, and driving around.

2.5 Notes on fieldwork in Vamale country



Figure 2.1: Mr. Jacob Oué and the author

A speaker of Vamale, and able to understand Pije and Fwâi, he was the consultant most interested in syntax, morphology, and semantics, and spent many patient hours working on transcriptions, subtle differences between morphemes, and phonological questions.

The four men mentioned here guided the work through unspoken customs and laws, taught the author Vamale, and poured their time and hearts into the project. Without their help, most speakers would not have spoken to the author, nor would he have known where to go, and very little would have seen the light of day. *Holeke thuan nyakoovwe ka gavwe i vaaya!*

2.5 Notes on fieldwork in Vamale country

This work is a linguistic contribution, but some anthropological information is relevant for the reader to understand the cultural context in which the language is embedded, and some hints for future researchers may be useful. The northern east coast of New Caledonia is over 90% ethnically Kanak, and everyday life is very much defined by this fact.

2 Methodology

2.5.1 Climate

Although the temperature is relatively stable between 23°C and 28°C, humidity and sudden, unpredictable rain (even more so with climate change) can be dangerous for electronic equipment. The project used waterproof bags and silica gel packs to protect the equipment from humidity, and Lavaliers and hyper-directional microphones to mitigate the noise of the rain. Many roads become difficult when it rains, and most houses are tin-roofed, making recordings inside difficult due to echoes and rain/sticks falling on the roof. Noise from cars driving by on the main road was an almost unavoidable problem for recordings, though chickens took over that role wherever the setting was rural enough to exclude traffic.

When it rains, it does so violently, and sometimes for days on end, with brief interludes. Tap water becomes murky, then brown, and finally stops working, so water-purifying pills are useful. Electricity may stop working if trees fall on the power lines. Because of the powerful weather, the obligation to attend ceremonies (especially unforeseeable funerals), the difficulty of planning an appointment etc., it is advisable to carry recording equipment at all times and record whenever possible, and to understand that plans can change at short notice. Life moves slowly, and people prefer to finish a thing properly to strictly adhering to an appointment. It may be frustrating to consultants to interrupt an interview, so it seemed preferable to keep the day planning flexible instead of 'making the most of it' and seeing three consultants in one day.

2.5.2 Lodging

The author rented a small house from his first contact and stayed there for most of his time in the area. With the exception of old bachelors and widowers, the researcher was the only person in the village who had a house to themselves, slept alone in a room, and could retire to work whenever needed. On the other hand, this also alienated the author from the others and prolonged the time it took him to integrate into the community. It took approximately six weeks for the shyness to subside on both sides. The author still recommends individual housing, if at all possible. Participating in as many activities as possible helps bridge the gap between the community and the stranger, as recommended by Patience Epps for fieldwork in Hup country (Epps 2008: 37). Be aware of your imposition on a family, contribute in food and money so as to alleviate the burden you represent. Spend free, disinterested time with your consultants and family, as purely professional relationships hardly exist in a tribal setting.

2.5 Notes on fieldwork in Vamale country

People usually keep a Spartan interior, with little furniture except for beds, TVs, and an occasional table. Mostly, meals take place outside, where the kitchen tends to be located. In general, most people have little to no disposable income. Most families rely on the employment of a family member as well as their own gardens for subsistence. Customary ceremonies are a major part of life, and exchanging produce, clothing, and money in this context has a function of leveling inequalities: some people can only contribute bananas or fruit bats, but leave a ceremony with clothing, money and sugar.

Some anthropological information is relevant to the reader. The northern East Coast of New Caledonia, uncontested *Kanaky*, is not the easiest terrain to work in, and the culture is very different from Western contexts. I hope that the following words will help anyone interested in working in the area, as well as shed some light on the problems commonly encountered by Westerners in this country.

2.5.3 Cultural notes

Politically, traditional Kanak society is organized in family units headed by the father. The next bigger unit is the clan, to which all persons sharing a particular totem, or a common ancestor, belong. This is usually headed by the eldest male, though another elder may be chosen if the former works in the capital, for instance. Local clan branches send an elder (not necessarily the oldest member) to a clan council which makes the decisions concerning a community. The chief (or “small chief”) is either appointed or inherits his position, and represents the community in spiritual matters,¹ but also to the great chief, whose authority stretches over several villages, and in some cases even covers whole islands (e.g. Isle of Pines/Kunyié). The decisions by chiefs are supposed to be decisions made in consensus with all clan elders. This is relevant to fieldworkers as decisions regarding their research may take a long time, and access to speakers is usually negotiated through several layers. For example, one might need to first ask the regional customary council for permission, then the high chief, then the local one, and in rare cases the clan chief. As long as the customary road is followed, individuals will not refuse to work with outsiders. To save face, unwilling consultants will simply not be home at the discussed date. Trying to force them into showing up e.g. by getting the clan chief involved may work once, but is unethical.

¹Part of this position is often held by the chief’s younger brother, or the head of a lower branch of the chiefly clan. While the “sorcerer” will lead the New Yam ceremony and perform incantations over the steam of the new year’s first pot of yam (*vwa bwa jadoon*), a ceremony which still happens today, he is not usually held responsible for changes in the weather or a failing harvest anymore, due to missionary influences.

2 Methodology

The respect towards elders is a strong institution and, coupled with a reluctance to ask questions² has made it difficult for heritage speakers to learn the language later in life. Face and shame remain powerful control mechanisms in Kanak society. Youths who make a mistake while talking will often be reprimanded, which discourages them even more from talking. Pedagogy traditionally consists of teaching-by-showing, or rather learning-by-paying-attention, which is mirrored in a reluctance to explain more than a small aspect at a time, and speaking quietly. Interrupting somebody is rude, and seniority plays a major role in turn-taking. Patience is paramount; many people willingly talk if the proper introductions were made and they are not rushed by questions.

Exogamous, virilocal marriage practices mean that in every traditional couple, the man is a local and the woman has moved from outside onto the land he inherited from his father (Salomon 2000: 321), although uxorilocal movements were attested in the late nineteenth century (Guiart 1992: 89). This also means that every traditional couple is at least bilingual. However, since everyone in younger couples speaks French, many do not learn their spouse's language, choosing to communicate in French instead. This is one of the reasons for the decline in speaker numbers. Speaking to the women is often useful, as they had to learn the language as well and may explain difficult concepts. Reanalysis and mistakes are possible, however.

Since every adult is supposed to raise offspring, adoptions are a common way of ensuring every household contributes to the perpetuation of the clan. Traditionally, one child goes back to the mother's family, to replace her and take care of the elders. Couples who struggle to have children may also ask for a child, and receive it soon after it is weaned. Families with too many children may give some away as well. In many cases, the children grow up close to their biological family and spend much time with their blood kin. As no terminological, or indeed salient cultural difference, is made between siblings and cousins, all members of the same "generation" (formerly: the group that is initiated together, *yidan*) descend from the same male ancestor and grow up together. The importance of parent-child relationships is thus somewhat lessened, and adoption less of a traumatic event than a Westerner might think. Outsiders' comments on adoption, land use, the role of women and other things are as unwelcome to the Kanak as they would be to anyone else, though curiosity is generally tolerated.

²This has two reasons: it could embarrass the elder in case they do not know the answer, but more importantly, information is a wealth that is volunteered rather than asked for, like all forms of wealth in Kanak society. Refusing an offer or query is tricky for all involved, as it threatens face.

2.5 Notes on fieldwork in Vamale country

The traditional social hierarchy is *de iure* still salient, as the customary authorities have the backing and acceptance of the State (Demmer 2003: 2). However, the chiefs' authority is not undisputed. This likely has different reasons, including the current chiefs' ancestors being installed by colonial forces (Demmer 2003: 3), which results in a hereditary system more rigid than what is described by Guiart for pre-colonial societies (Guiart 1954: 5,8). This is relevant because relying solely on the chief to organize research participants may exclude non-loyal residents, and introduce blind spots and complex jealousies. Pastors tend to have more unanimous prestige. The adoptions, dispersals of clans, feuds between different people, confessional differences, language diversity, and stark contrasts in the access to public transportation (and stable roads) make the social web extremely complex. Being instrumentalized is unavoidable and rarely detrimental to the project. This complex web also means that one is quickly known, word-of-mouth is fast and effective, and interested parties will often join a workshop or an activity by themselves.

Ceremonies occupy a central part of speakers' lives. They frame historical commemorations, some sporting events, and most cultural gatherings. All weddings, birth celebrations and funerals still follow traditional patterns, with ceremonies at every step. In all cases, the custodians of the land will receive symbolic gifts from the guests, and speeches in the native language will be held (comprehension is not required). This is one of the domains in which Vamale is not likely to be replaced by French as long as there are still fluent speakers. It is recommended to attend as many cultural gatherings as possible and to participate in preparing the location, the food, etc. Willingness to work (*vapula*) is highly valued in Kanak society, as is tending to a garden, sharing wealth, and being parsimonious with speech.

There is widespread distrust of outsiders, but this usually subsides after a conversation or two. Though the author never met any negative views against his person, his presence as a European scholar was regarded critically by some, and even bemoaned by Mr. Philippe Gohoupe. It helps to be accompanied by a local when visiting people for interviews.

2.5.4 The place of language in Kanak culture

Kanak identity is tied to language (Lynch et al. 2002: 29) and land (Bensa & Goromido 1997: 91). Similarly, an individual's paternal language is linked to their land tenure (Sallabank 2015: 40). The emphasis in the literature is often on the clan name, inherited from the father, and the accompanying land rights. This is also the case in everyday discourse. The language used changes according to need

(see §3.2.2), and people moving to a new place will usually adopt the local language. While this is considered polite, there is also a deeper function: strangers and newcomers have reduced speaking rights at the council and a lower social status. In modern society, with written land tenure records and weakened land master clans, being a newcomer also often means having no land. However, traditionally, especially in the post-1774 period, geographical mobility often went hand-in-hand with a change of name to get land rights (Bensa & Goromido 1997: 92). Identity is a complex matter nowadays. *Métissage*, ‘racial’ mixture with descendants of Kabyls, Europeans, Polynesians, but also from other Kanak nations, is a factor as much as traditional values such as where one plants their yam or to which clans one is related. In an increasingly complex society, being *juu* ‘real’ is also negotiated through speaking the language. Nowadays, young people (who often do not speak their heritage language) refer to themselves via the name of their village or their community in graffiti, tattoos, on Facebook, etc. Older people will relate through clan ties, but especially Pije and Vamale are so small, due to a shared history, that speaking them unites people.

2.6 Language name

The language described in this book has been called *’Moaeke* (Leenhardt 1946), *Hmwaeke* (especially in Anglophonic literature), or *Vamale*. A language called *Hmwaeke*, or *Fa Tieta*, is spoken in Tiéta, and is a very close relative of *Vamale*. In the Kanak conception, languages are defined via the area they are spoken in (Sallabank 2015: 40). Although some broader terms are used, such as *thiie* ‘Cè-muhi’, *vije* ‘Pije’, or *cì/thi* ‘Paicì’, one’s own language is often just called *juu fati* ‘real/indigenous language’, or *fati-je* ‘our language’. Dialectal differences within one’s own language are described as *li vataan geen fati* ‘the different voices/accents of language’, or simply as ‘the language of X’. As mentioned in §3.2.3.4, maintaining a dialect’s individuality is important to speakers. Whether the idea that there are “true, correct” languages is new or not, distinctions are nowadays made between the “real” *Vamale* and the *Vamale* of, say, Usa, or Tiéta. This was never mentioned in a derogatory way, as each family is understood to have its own influences and language histories. The mutually intelligible variety spoken in Tiendanite by descendants of refugees from Usa will thus be called *Vamale Usa*, as they call themselves *Vamale* speakers. Speakers of *western Voh-Koné* varieties do not use the term *Vamale*, as it is tied to the specific valley of origin. Speakers of other languages often use one term for all the *Voh-Koné* varieties, calling them e.g. “*Vamale* of the other coast”. The names *Haake*,

Haeke, *Haveeke*, *Hmwaveeke*, *Hmwaeke* are all derived from the greeting “How [are you]?” and were given for the sake of naming. However, though the names suggest only slight dialectal differences, *Haeke* is not easily understood by *Vamale* speakers, nor do the respective speakers consider themselves to speak the same language (albeit acknowledging their similarities). Each community having their own speech is especially important to people who had a different history than the other speech communities, as the last hundred years have strongly contributed to the identity .

Naming the language after its place and not a distinctive feature that ties it to the dialect cluster is closer to peoples’ own conceptions, namely that they are defined by their geographic origins and share more with the east coast than the west coast. *Vamale* speakers do not consider themselves to form a cultural unit with other speakers of *Voh-Koné* languages, preferring to identify with their three home villages, their commune Touho, and in general the east coast of the northern province. Since this is not a region that has a name useable for our purposes, the historical origin, Pamale ~ *Vamale*, used by the speakers, seems appropriate. Apart from differences in phonology, lexicon, syntax, society and linguistic context, there is also a political reason to call this language *Vamale* instead of *Hmwaeke*.

Voh-Koné is a cluster of varieties that are called dialects in the literature. This means that their speakers are counted as a unit, and amount, together, to over 1,000 people, which makes them seem a robust language group. However, most of these varieties, except *Haveeke*, have few young speakers and are thus endangered. Labeling them “dialects” and not “languages” has hindered efforts to protect them, as the former concept enjoys less prestige than the latter. While many people acknowledge that *Cèmuhi*, and *Paici*, are languages with a grammar and a literary tradition, the author was told by Kanaks and Europeans alike that *Vamale* was a waste of time, as it had no “grammar”. Without going into more detail, this book will usually refer to *Vamale* as a language, or a variety, but avoid the word “dialect”.

If *Vamale* is ever to be taught at school in Touho, it must be recognised as a language separate from *Haeke*, which is already an official language of schooling in the cultural *aire* Paici-Camuki. Crucially, *Haeke* is only taught in the *Koné* area. The separate status of *Vamale*, and its emplacement on the east coast, was recognized by the cultural bureau in Pwäriwâ (Ponérihouen) in 2019. Finally, since *Vamale* is called *Vamale* and not *Hmwaeke* by its speakers and their neighbors, this book will keep to their own usage.

3 Language family, neighbors and previous work

- (1) *juu va m=e=juu saxhuti nyakoo-vwe i=jaxhut ko*
real too.much SUBR=1SG=real narrate for-2PL DEF.SG=story about
i=vamale...
DEF.SG=Vamale

‘It is beyond me to properly tell you the story of the Vamale language...’

This chapter aims to introduce Vamale in its genealogical context, as well as its current geographical environment. The language has been affected by its role in the area over time, its neighbors, and the contact situations born of that. Because Vamale speakers were one of the most severely impacted speaker communities of the 20th century in New Caledonia (see Chapter 4), *i vaa can vije*, the 1917 Kanak revolt or war, plays a crucial role in understanding why so few speakers remain, and why Vamale is a pluricentric language spoken by traumatized people. Chapter 4 summarizes the background and main events of this war.

Vamale is said to have approximately 100 speakers left (Eberhard et al. 2020). Asking community members to list everyone capable of having a conversation in 2017 yielded 186 names, nine of whom have since passed away (as of January 2021). Worryingly, only 32 speakers are younger than thirty, and only 2 are minors. Most fluent speakers are over 60 years old. Though the language is used in ceremonies and some households (e.g. Téganpaik chief’s house), and amongst many adult speakers, persons under 25 years of age barely use it with each other. A notable exception is the village We Hava, where a majority of residents understand, and many speak, the language. In one, maybe two generations, the language will stop being spoken, unless the trend is reversed. On a hopeful note, an association was founded in 2019 with the goal of maintaining the language vital and promote its use (pictured in Figure 3.1). Several workshops to this end have already taken place since the beginning of the research project, like the one shown in Figure 3.2.

This section describes the situation of Vamale today. Below are brief descriptions of the villages in which most speakers live (Nouméa, the capital, is exempt), and a list of the languages found in the direct vicinity of Vamale.

3 Language family, neighbors and previous work



Figure 3.1: The founding members of the Association Vamale.



Figure 3.2: A language workshop in late 2018, with members of the Academy of Kanak Languages.

3.1 Current geographical location of Vamale

Vamale is spoken on the northeastern coast of *Grande Terre*, the biggest island in the archipelago of New Caledonia (Figure 3.8). These islands, located south of Vanuatu in the subtropical Coral Sea, were settled around 3,200 years ago by Lapita sailors from Vanuatu (Lynch 2004: 334, Sand et al. 2007: 309). Contacted in 1774 for the first time by Europeans, the archipelago was formally claimed by the French in 1853, to break up British dominion in the area. French settlement, and the plantations tied to it, led to an influx of speakers of Vietnamese, Polynesian, Vanuatuan, and French varieties. Before this period, the islands hosted a family of at least 35 South Oceanic varieties¹ as well as a Nuclear Polynesian language spoken on Iaa/Uvea since the 17th century: Fagauvea (see Figure 3.8) Vamale is the only member of the Voh-Koné linkage situated on the rainy east side of the central mountain range, about 375 km northeast of the capital Nouméa. The sea immediately to the east, and steep, sparsely populated mountains to the west mean that there is an about 5km large belt in which humans live in any density to speak of, and where Kanak languages are mostly found nowadays. Vamale is spoken in an area approximating 25 km², but apart from isolated houses like Laurient Gohoupe's far upstream of We Hava, the speakers can be found in five villages (and, of course, the bigger towns of the territory). These will be described in more detail in §3.1.

Vamale is spoken in several villages in the communes of Touho and Hienghène along the east coast of northern New Caledonia, in some villages in the mountains, and perhaps close to the west coast (Baco, Koné). The community is thus relatively widespread, which has given rise to a number of “family idioms”. The Vamale-speaking area is large but sparsely populated, and concentrates on four villages. This work will usually prefer the word “village” to “tribe”, which would be the translation of the official French term *tribu*, because the Vamale word used for village, *xhoogo*, means ‘home’ and has no connotation of a tightly-knit group of clans (especially since the 1917 war), and because it ultimately derives from a colonial vocabulary trying to establish a fundamental difference between Kanaks and settlers. This section will thus describe the villages in which Vamale is spoken.

¹Leenhardt described 36 varieties, some of which are considered dialects of the same language, e.g. Orowe, Hamea, and Ajië. Given that in the 1940s, many of them were already quasi-extinct (e.g. Waamwang, Arhâ, and the ceremonial varieties of Drehu and Nengone), and given the catastrophic decline of the Caledonian population, *and* how many small languages still co-exist in the North, a larger number may be presumed to have existed.



Figure 3.3: Map of speaker households. Approximate map of speaker households on the east coast (Gouvernement de la Nouvelle-Calédonie, 2017-11-22), dots are my own, thanks to Florian Matter.

3.1.1 Téganpaïk

⟨Téganpaïk⟩, or in Pije [tʰeŋgane 'pa:ik] ‘split stone’, after a placename close to the cemetery, is a village of about 200 inhabitants. Haudricourt translates the name as *tnek-ngen-paik* ‘oven-in-stone’ (Haudricourt 1968: 229). A Shell gas station, a community center and a church are the only public buildings; the closest school is in Cèmuhî-speaking Touho, though many children go even further to Paicî-speaking Poindimié for secondary education. Téganpaïk is the biggest Vamale-speaking village, and the research project was based there. Traditionally Pije, many families are bilingual, and old marriage alliances have brought women speaking other languages as well. In most families, Kanak language transmission stopped around 1990. The village is a string of houses along the national road RN1 and squeezed between steep mountains and the sea (there are rarely more than 100 metres between them). While the pre-contact population of the fertile Tipije (Pij. *ti pije* ‘estuary snare’, the Pije name for the river itself is *le pije* ‘in snare’), and Tiwaka valleys, was likely large, this coastal strip harbors no fields and few fruit trees, and may not have been as densely populated before the arrival of Vamale speakers. Almost beachless, and facing sharp, mostly dead coral at low tide,

3.1 Current geographical location of Vamale

Téganpaïk does not attract many tourists, and with a chiefly ban on kava bars,² the only points of interest to travelers are the Shell gas station and a picknick area near the sea. Touho has a diving school and boats one can rent, whereas the only bigger boat the village had, the *Dongan*, was lifted and crashed on the other side of the road by cyclone Betty in 1995. This disbanded the fishing cooperative that had begun between villagers, and the boat's low-tide haven, a pool created by coral blocks, is now used for swimming and as a sardine reproduction sanctuary. Cyclones are becoming stronger almost every year, and with warmer, more acidic waters, the coral barriers protecting Grande Terre against the occasional tsunamis and other high waves are deteriorating. Villagers have begun planting mangrove trees to attract fish and crabs, but also as a protection against coastal erosion and waves. The author did not meet anybody unworried about climate change.

Téganpaïk is a tightly-knit community. Its children play together, the men go hunting on horseback and in pickup trucks and fish on bamboo rafts and in motorboats. The protestant church is an important center to the community, and one of the main domains of Vamale. Téganpaïk's clan council also administrates Wanaa (see §3.1.2) as well as the former leper colony Mahena/Maïna, which is composed of few houses and can be considered a suburb of Téganpaïk.



Figure 3.4: Mr. Christophe Pei fishing for sardines in Téganpaïk

²The next village to the East, (Kongouma) (Cèm. /ko-goo-mwa/ 'on the wall'), sports three *nakamals* and kava drinkers come from Hienghène and Touho to lift *sels*.

3 Language family, neighbors and previous work

3.1.2 Wanaa

⟨Ouanache⟩ [wā'nā:]³ has only 11 houses, but fluent child speakers of Vamale, and many fields belonging to Téganpaik inhabitants. Wanaa was Pije-speaking before 1917, but is now one of the biggest speaker-centers of Vamale. Contrary to Téganpaik, it is an official tribe, though its chief Luc Oué resides in the former village. A war location in 1917, it welcomed some of the inland refugees. The village concentrates in two road loops close to the neighboring villages Téganpaik and Tiouandé, but the tribal grounds stretch south-east following a valley shown in Figure 3.5 until a mountain pass leads to Poyes (see Chapter 4). Considering that some of its uninhabited mountain flanks show remains of taro terraces, and that planted araucaria trees can be seen much further upstream, the settling of youths in the wild backyard of the village, Tanaka, is more a reclaiming of former living grounds than a human invasion.



Figure 3.5: The Kacabwec valley leading to Wanaa. Only part of it is inhabited now.

3.1.2.1 Tiouandé

⟨Tiouandé⟩ (Pije [t^he'x^wa:n^{de}] 'rock garden') borders the Tipije river on its northernmost end, the sea on the northeastern side, steep mountains and rock formations like "Napoleon's hat" (Vam. *vaci that* 'wind's nucleus') on the west (shown on the left in Figure 3.6), and the hill Kapohiyoak ("children-making

³According to inhabitants, possibly from Pije *hwada* 'planting spot' (Haudricourt & Ozanne-Rivierre 1982: 106) or Vamale (*e-*)*wanaa* 'dispute'.

3.1 Current geographical location of Vamale

place”) which separates it from Téganpaïk. Tiouandé is the village with the most Pije speakers in the region, and is in close and active contact with Téganpaïk. Its chieftaincy is held by the Kalène clan, though the Bwiya have held it until the current chief took over.



Figure 3.6: The Tiouandé estuary

3.1.3 We Hava

⟨Oué Hava⟩, Vam. [’we hava] ‘*Broussonetia papyrifera*⁴ creek’, built along a tributary of the Tipije river, is a group of settlements, about four or five, each consisting of several huts and small houses. An exception makes a classic colonial building, white and facing the river, which is now inhabited by We Hava’s former chief Kaina Fouan. The chieftaincy has returned to the traditional owners, the ⟨Tchéou⟩ /ceu/ clan. The long road to *Cake-O* ‘scoop, bail out-bamboo’, We Hava’s last dwelling and home of the oldest Vamale speaker Philippe Gohupe (the author of the Tipije text in Appendix B), is now bordered by bamboo groves and forest in various states,⁵ but all along the road, traces of abandoned villages can be seen on both sides of the river. We Hava and the settlement on the other side, Tipije, are what remains of ca. 14 settlements in the valley.

⁴Used for its bark to make *tapa* cloth.

⁵Burning brush is a problem for local forestry. While careful burns were part of the slash-and-burn agricultural model, unsupervised fires are a common cause nowadays for wildfires, and are universally frowned upon and creates problems for wildlife, water table, and of course botany. The straw needed for traditional thatching is especially vulnerable.



Figure 3.7: The We Hava river

3.1.4 Tiendanite

⟨Tiendanite⟩, in Vamale [ʼse:ʰjaŋit], the home village of the politician Jean-Marie Tjibaou, is buried in misty hills up-stream of a Tipije tributary. It mostly houses eastern Nemi and Mountain Pije speakers, but also three households of Vamale Usa speakers, who are in irregular contact with coastal speakers. Usa is a Voh-Koné variety formerly spoken in a valley tributary to Pamale, and has a half-dozen speakers under 40 years of age. Children run around speaking Pije. Vamale speakers arrived there after the war (Couhia & Maepas 2008: 62), though their earlier presence is likely.

Having provided a brief overview over the places in which Vamale is spoken, the chapter now introduces some important societal points.

3.2 Language family

Lynch et al. (2002: 112) classifies the New Caledonian language family and the Southern Vanuatu family as part of the Southern Melanesian family. With South Efate languages, this group forms the Southern Oceanic linkage (Lynch et al. 2002: 112), itself a linkage in East Malayo-Polynesian (see Figure 3.8 for a map). Lynch (2004: 334) hypothesizes that New Caledonia was settled rather directly from Efate, which would make sense with its status of a family inside a linkage.

Oceanic languages are grouped into innovation-defined groups and innovation-linked ones (Lynch et al. 2002: 93), distinguishing languages which descend from a reconstructible proto-language, from languages that form a group through innovations shared via contact, or where innovations have occurred in overlapping smaller groups. The latter case is much more frequent in this area of the world.

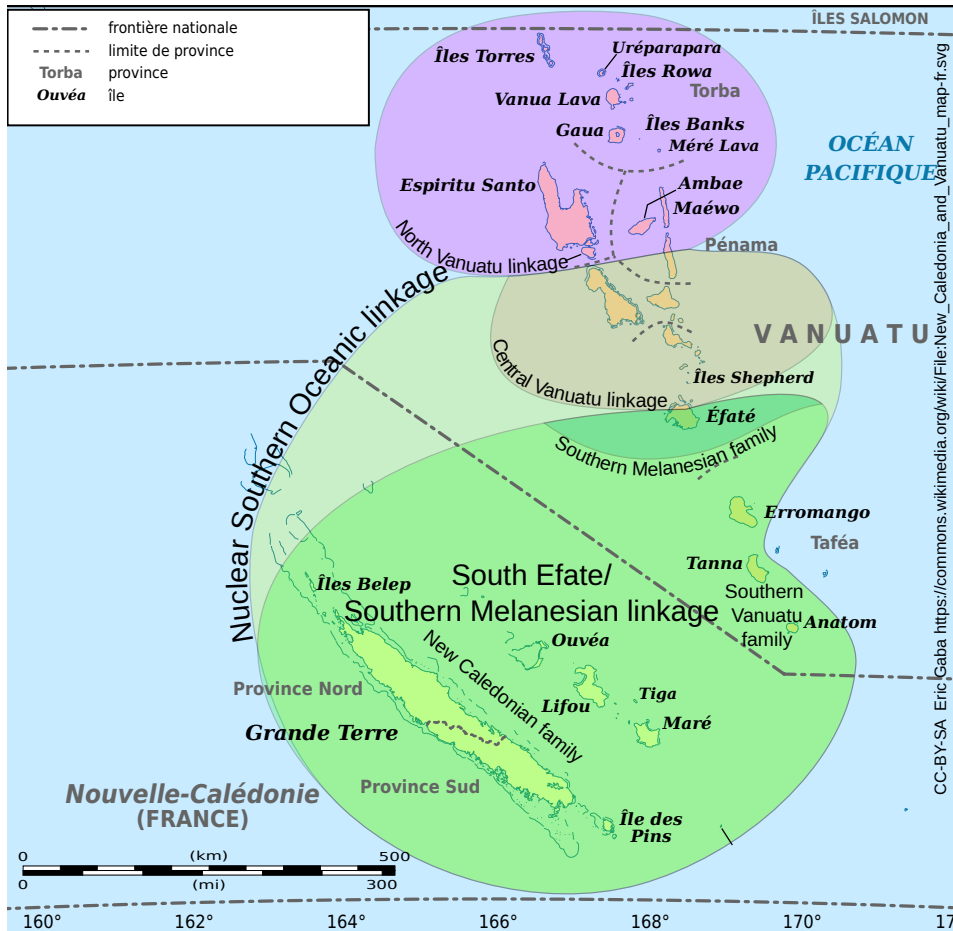

Figure 3.8: New Caledonian within the Southern Oceanic linkage (Lynch et al. 2002: 113)

Lynch uses the term “Southern Oceanic” to refer to “a linkage whose members today comprise the 130 or so non-Polynesian languages of Vanuatu and New Caledonia” (Lynch 1999, 2004: 313). The linkage is defined by the innovations from Proto-Oceanic (POc) listed below, among others.

3 Language family, neighbors and previous work

- POc *R was dropped in absolute word-final position (Lynch 2004: 313) While northern New Caledonian languages do not feature *-l* or *-r* in non-loans, possessed forms hint at a merger with *-t* rather than an apocope; compare Vamale *fedat* ‘blood’ from POc *daaR to its possessed form *fedala-*.
- “Third person pronouns accreted *na-.” (Lynch 2004: 313) The singular article *na- was not conserved in New Caledonian, but Ozanne-Rivierre (1992: 197–201) argues that a trace was responsible for some non-etymological prenasalized consonants (Lynch 2004: 316). Compare *talik ‘sea’ → Vamale ^ŋ*jati*.
- “POc *k → Proto-Southern Oceanic (PSO) *g in some pronouns” (Lynch 2004: 316). Compare
 - *POc *kita ‘1PL.INCL’ → Southern Melanesian *gida or *gadV → Vam. *gase*
 - *POc *ko ‘2SG’ → PNC, and Vam. *go*
 - *POc *ka[m]u, *kamiu ‘2NSG’ → PNC *ga(m)u → Vam. *gau* ‘2DU’
- “The ancestral system of two transitive suffixes reduced to one (or none)” (Lynch 2004: 313). This relates to the transitive suffixes *-akini and *-i, both of which may still have reflexes in Vamale in the form of *-ke* and *-i*, respectively (see §9.3.1.1). While *-i* is found in many northern languages, *-ke* may now be unique to Voh-Koné. This potential disagreement with Lynch is grounds for more research.

Southern Oceanic contains the Southern Melanesian family, defined amongst other things by its voicing of the initial plosive in certain pronouns (e.g. POc *kita ‘1INCL’ → SM *gida, later *gadV → Vam. *gase/gasu*) (Lynch 2004: 317). New Caledonian as a family is well-defined by sound changes, listed below, and some lexical innovations (Lynch 2004: 316). Table 3.1 summarizes and illustrates some of the consonant sound changes from Proto-Oceanic through Proto-New Caledonian, to modern-day Vamale and Bwato.

- Merger of POc *c, *s → *s
- Merger of POc *n, *ñ, *l → *n
- Loss of POc *R and *y
- POc *puV → PNC *p^wV
- POc *ai → PNC *e/*e: (Lynch 2004: 317)

Table 3.1: Voh-Koné reflexes of POc forms

POc form	Bwato	Vamale
Proto-Oceanic		
*p		
PNC		
*p, *pw → v, v ^w		
*paRi ‘ray(fish)’	<i>ve</i>	<i>ve</i>
*poñu ‘turtle’	<i>v^wen</i>	<i>v^wen</i>
PNC		
*pp, *ppw → f, f ^w		
*posi ‘press’	<i>f^wati</i>	<i>f^wati</i>
POc		
*d / *r		
PNC		
*t, *nd → ⁿ d		
*daun ‘leaf’	<i>ⁿdoon</i>	<i>ⁿdoon</i>
*daRoq ‘ground’	<i>ⁿdoot</i>	<i>ⁿdoop</i>
Proto-North		
*t ^h		
t ^h at ‘pandanus’	<i>t^hat</i>	<i>t^hat</i>
t ^h ap ‘oral thrush’	<i>t^hap</i>	<i>t^hap</i>
POc		
*t		
PNC		
*t, *d → ⁿ j		
*tasi ‘younger sibling’	<i>ⁿjati-</i>	<i>ⁿjati-</i>
*tupa ‘grandfather’	<i>ⁿji^mbu-ⁿji^mbu-</i>	
PNC		
*tt → θ/s		
*tumpuq ‘swollen’	<i>θi^mbu</i>	<i>si^mbu</i>
POc		
*s		
PNC		
*s, *n ^s → d/t		
*sapa ‘what?’	<i>ⁿda</i>	<i>ⁿda</i>
*sake ‘go up’	<i>ta</i>	<i>ta</i>

3 Language family, neighbors and previous work

POc form	Bwato	Vamale
*suRi ‘bone’	<i>ⁿduu-</i>	<i>ⁿduu-</i>
PNC		
*ss → t ^h		
*susu ‘breast’	<i>t^hi</i>	<i>t^hi</i>
*suki ‘pierce’	<i>t^hi</i>	<i>t^hi</i>
POc		
*k		
PNC		
*k → δ/j ~ ∅		
*kulit ‘skin’	<i>δii</i>	<i>i-</i>
*kuRita ‘squid’	<i>δiia</i>	<i>i^mbwen</i>
PNC		
*kk → θ/s		
*kuku ‘claw’	<i>θi-</i>	<i>si-</i>
*kau ‘swim’	<i>θoom</i>	<i>soom</i>
POc		
*q		
PNC		
*q → y/∅		
*qusan ‘rain’	<i>yuta/ wuta</i>	<i>uta</i>
*qupi ‘yam’	<i>yuu</i>	<i>uvu</i>
*qata ‘man’	<i>yau</i>	<i>yaju</i>
*qaso ‘sun’	<i>yat</i>	<i>yat</i>
PNC		
*qq → x		
*quma ‘grow, cultivate’	<i>xuum</i>	<i>xumi</i>
*qulos ‘worm’	<i>xuṅat</i>	<i>xuṅat</i>

The Southern Oceanic languages spoken in New Caledonia can be split roughly into two groups: Mainland (i.e. *Grande Terre*) languages, and the three Loyalty Islands languages Iaa, Drehu, and Nengone (Ozanne-Rivierre 1992). Mainland languages split into northern and southern languages (see Figure 3.9), with a tendency for northern languages to have 5 or so vowel phonemes and over 35 consonant ones, and an opposite trend for large vowel inventories and small consonant ones in the South (Ozanne-Rivierre 1982: 25). In the North, a

Far Northern branch (*Extrême Nord* in French) and a Northern branch split into some dozen languages (see Figure 3.11 for a map).

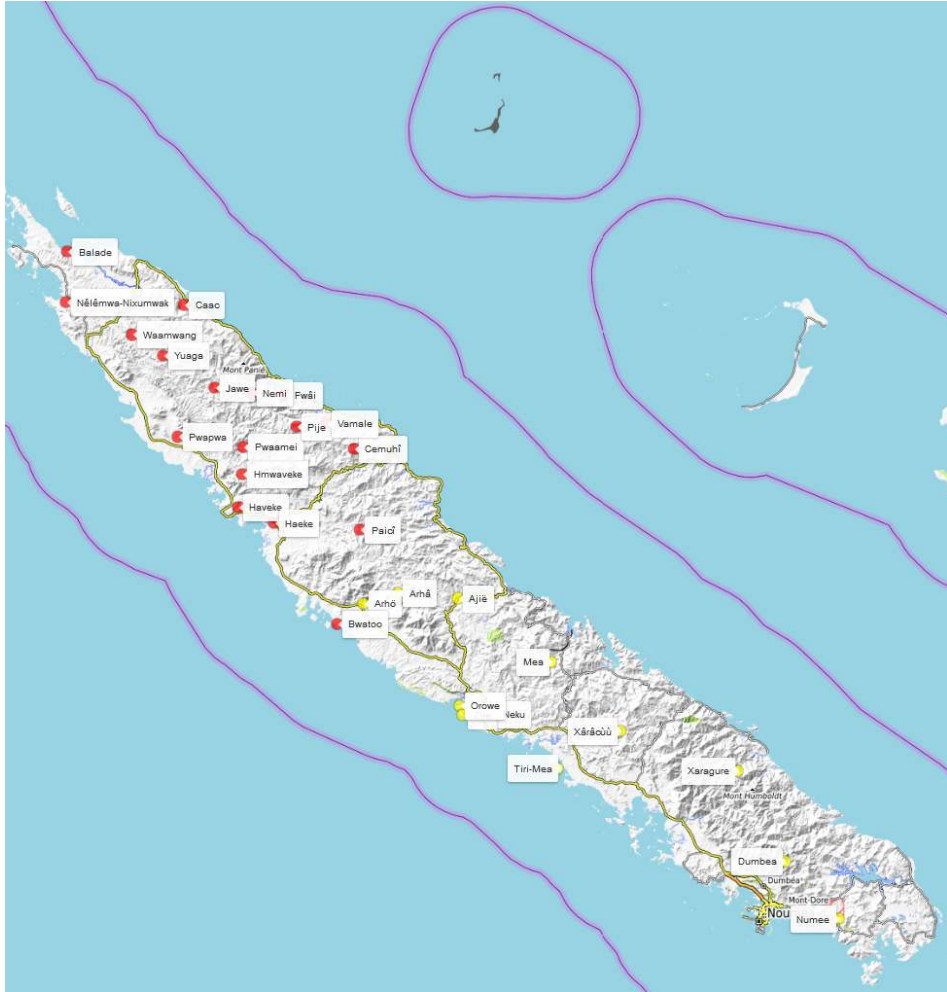

Figure 3.9: Mainland New Caledonian, North (red) and South (yellow) (Hammarström et al. 2020)

The latter is split into the so-called Hienghène cluster, the Voh-Koné dialects, and the tonal languages Cèmuhi and Paicî, to which Voh-Koné is more closely related than to the other branches, (Rivierre & Ehrhardt 2006: 19) see Figure 3.10 for a language tree. The language described in this book is part of the Voh-Koné cluster. The question of dialect vs language, as well as of the name given to the variety in question, will be addressed in §2.6.

3 Language family, neighbors and previous work

Voh-Koné is defined as a group mostly by phonological changes that set it apart from the rest of the Northern and Far Northern languages. Comparing sound changes in the Northern family is difficult due to sparse data. Valuable work was done by Haudricourt (Haudricourt 1948: 73–97) and especially Ozanne-Rivierre (1995, 1992). The following is mostly a summary of her work, with some Vamale data added.

Compared to other Northern languages, Voh-Koné is mostly distinct by its lenition of $*c \rightarrow j$ and initial $*p$ to v (see Figure 3.10). The latter was dropped in some Vamale words such as the singular article $*vi \rightarrow i$ (but not the language’s name). Geminate of $*q$, $*k$, $*p$, historically the result of reducing the first syllable in reduplicated contexts, yielded aspirated initial consonants everywhere in the North (Ozanne-Rivierre 1992: 57), but have voiceless fricative reflexes in Voh-Koné (see Table 3.1). Voh-Koné languages do have aspirated plosives which evolved from the same source, too, however. This is partly due to borrowing, but given their almost exclusive occurrence before nasal vowels, this study suggests that the leniting sound changes which led to a fricativization did not occur completely (see §5.2.5).

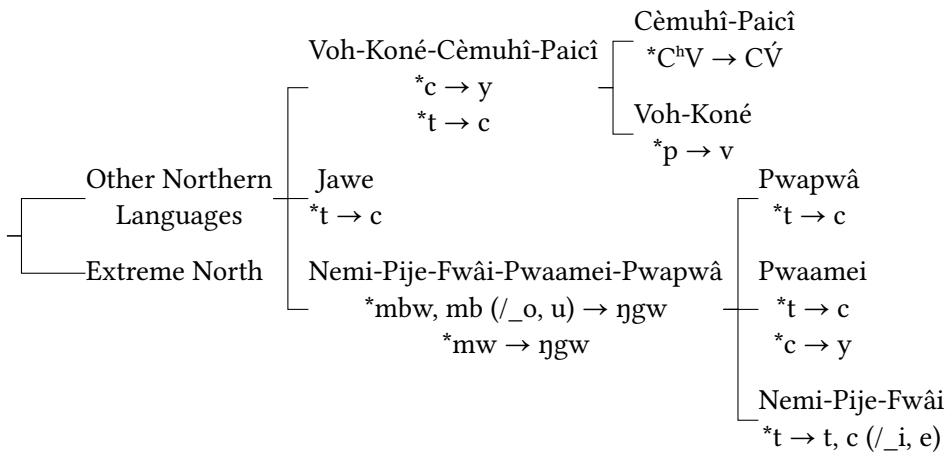

Figure 3.10: Language tree of some North New Caledonian languages (Ozanne-Rivierre 1995: 63)

Vamale is a member of the Voh-Koné languages, a group of mutually mostly intelligible varieties which forms a belt on the western shore from Voh to Né pou including Koné and Baco, then follows the Tiéta river upstream and breaks off around Temala, before picking up again in the east around Tiendanite, Ouen Kout and We Hava (see Figure 3.11). As is typical of dialect chains, the varieties furthest apart have distinct grammatical morphemes, distinct lexicon, and different phonological systems. Because of this, Vamale and Bwato are not readily

understood by speakers of the other variety. Table 3.2 compares Voh-Koné pronouns, along with Pwapwâ, a neighbor of Bwatoo, as they were recorded in the 1940s.

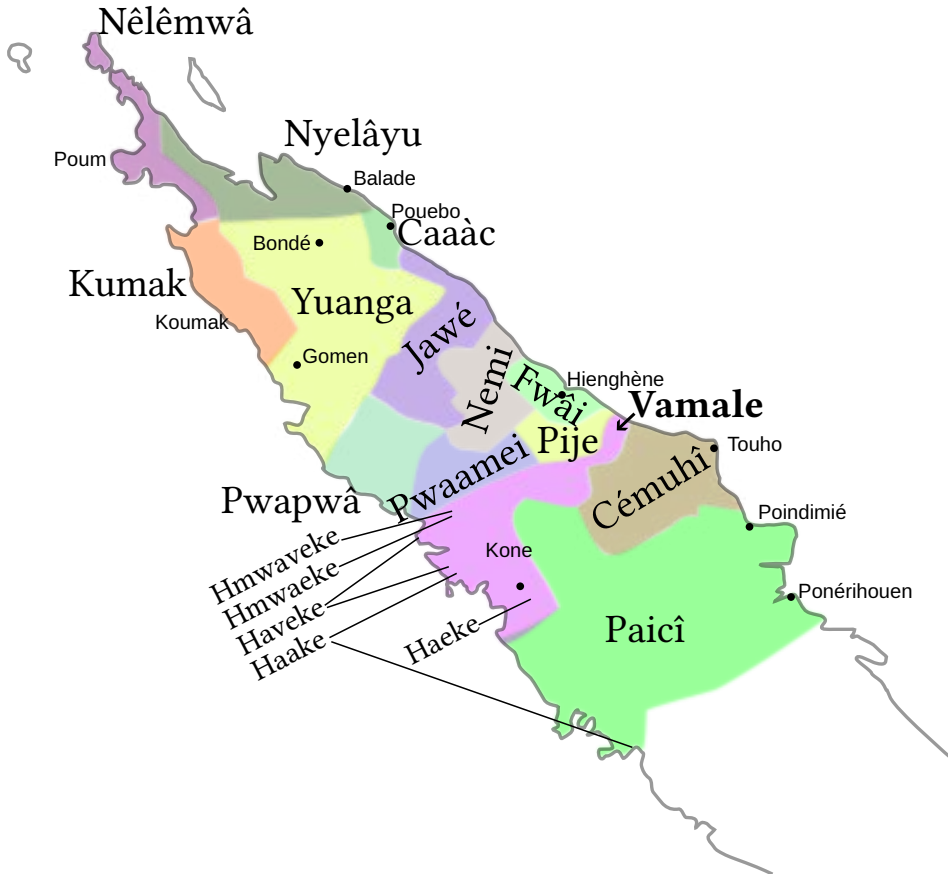

Figure 3.11: Northern New Caledonian languages (Ozanne-Rivierre 1995: 45)

The languages of Voh-Koné probably spread from the eponymous region on the west coast to the Upper Tiéta valley, where Hmwaeke⁶ is spoken. Until the early 20th century, the neighboring valleys of the Pamale and its tributaries were inhabited by some 2,000 people according to oral tradition (Couhia & Maepas 2008: 62). Since this region fell under colonial control only in the wake of World War I, no census before the Tipije war can confirm or contest this number. The

⁶ *hmwaeke* is a common greeting in the eponymous variety meaning ‘how [is it going]?’.

Table 3.2: Voh-Koné object-indexing pronouns after Leenhardt (1946: 504–507), modern Vamale added on the left.

	Vamale		Hmwaveke	Waamwang	Haveke	Haeke	Bwato	Pwapwá
	now	1946						
1SG	(e)o	o	yó	ng	ng	ong/ng	ng	ng
2SG	ko	ko	go	m	go	go/m	m	m
3SG	(e)a	kon, ke ^a	kon, ke	n	gon	mon/n	n	n
1DU.INCL	ju						ju	
1DU.EXCL	bu						bu	
2DU	u						u	
3DU	lu						lu	
1PL.INCL	ga	ga	ga	je?	gaie	ngaie/je	je	je
1PL.EXCL	be	be	be	be	gabe	ngabe/be	be	be
2PL	gav ^v e	gae	v ^v e	we	gae	o	e	e
3PL	le	le, ke	le	le	le, ke	le, ke/le	le	le

^aNote that *kon* may refer to an oblique marker *ko-n* and *-ke* is a transitive suffix.

entire population of the valley was either killed or scattered (see Chapter 4). A map of the main movements can be found in Figure 4.3. Those who went west assimilated into their linguistic cousins, whereas the eastward fugitives kept a language alive which they call Vamale today. Leenhardt called it ‘Moaeke’ of the East Coast and counted 50 speakers (Leenhardt 1946: 162).

Within Voh-Koné, the major division opposes western, coastal varieties and eastern, mountain-based ones. Interdental fricatives /θ/ and /ð/ are features of Bwato, Haveke, Haeke and Waamwang, whereas Hmwaveke and Vamale present the alveolar fricative /s/ instead of /θ/, and have lenited /ð/ to /j/, or dropped it before /i/ (e.g. *kult ‘skin’ → Bw. *ðii*, Vam. *i*).

Proto-Oceanic initial *q has become /ɣ/ in Vamale, except before /u/ (e.g. **qu-san* ‘rain’ → *uta*); western varieties keep /ɣ/ before /u/. The only case of a voiced fricative before /u/ is an allophone of /h/. [ɣ] is also dropped before /o/ (Bwato *yop* ‘high tide’, *op* in Vamale).

Intervocalic /v/ within a morpheme is rare, which is a contrast to the western languages.⁷ Hmwaveke, part of the mountain group, still shows intervocalic /v/ lost in Vamale, which suggests that this sound change originated in the East. Finally, some final consonants (chiefly /k/ and /c/) were lost in Vamale that remain in Hmwaveke.

Historical sources suggest a sort of *Urheimat*, given that Guiart mentions a bigger Haekic coalition on the west coast before the Paicî influx of the 18th and 19th centuries (Guiart 1963: 131,260). Compare the map by Leenhardt in Figure 3.12 to Figure 3.11: Voh-Koné languages retreated to the North, and the coast between Koné and Poya is almost exclusively Paicî-speaking today. Interestingly, the map treats Pwapwâ and Pwaamei as dialects of Nemi. As the map, along with many of the language materials in the book was compiled using second-hand accounts (Leenhardt 1946: xi,xiii,xlviii), its accuracy depends on the area depicted. Since Leenhardt himself traveled to Pamalé in 1903 (Leenhardt 1978b), we can rely on the map for Vamale’s historical position, even if it was inaccurate by the time of its publication. Until 1917, Vamale was spoken in an area inhabited since 420–610 AD (Sand 2012: 172) (though probably not by Voh-Koné speaking people), and represents the easternmost point of a putative inward expansion of a dialect continuum.

Spatial proximity groups coastal Haveke and mountainous Hmwaveke together, so that there is a middle zone, as is typical of dialect chains. In addition to this blurring factor, language contact changed dramatically in the last century, with

⁷Except for *fava* ‘4’, but Pije *hovac*, Fwâi *fovec* (Haudricourt & Ozanne-Rivierre 1982: 261). Bwato *fae*, Oundjo-Haveke *favac* (Rivierre & Ehrhardt 2006: 135).

3 Language family, neighbors and previous work

an influx of refugee Hmwaeke and Vamale speakers that changed Haveke and Hmwaveke. Vamale itself may have changed faster in its relative isolation.

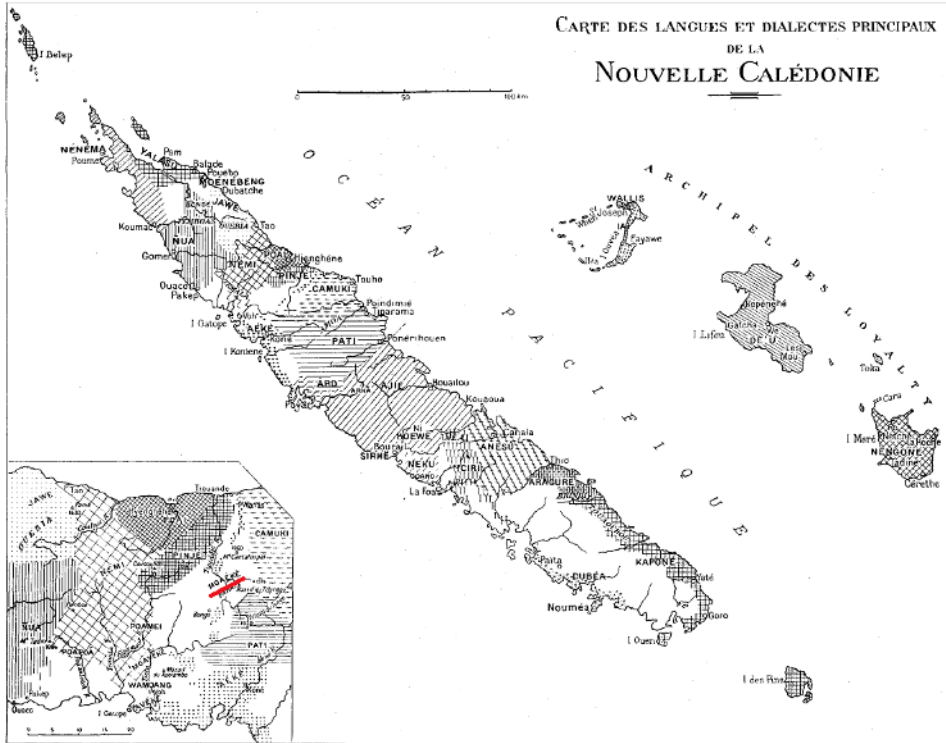

Figure 3.12: Languages in the region around 1917 (Leenhardt 1946: 658), with Vamale (“Moaké”) underlined in red.

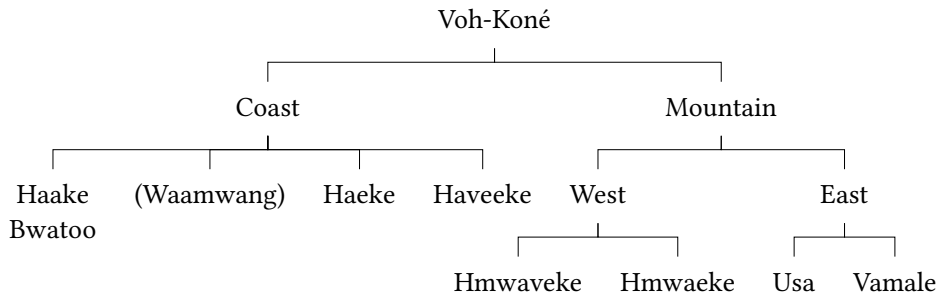

Figure 3.13: Possible language tree of Voh-Koné languages

3.2.1 Linguistic context

This section aims to describe how Vamale relates to other languages surrounding it. Historically, it is likely that the Voh-Koné languages spread eastwards into the mountains, which would suggest that Vamale/Hmwaeke is most closely related to Hmwaeke proper, then Hmwaveke, maybe Waamwang, and finally Haveke, Haeke, and Bwattoo.

People formerly would cross the mountains on foot- and horse trails, leading to Pije, Fwâi, and Cèmuhi speaking areas, but more importantly other Voh-Koné speaking areas: Tiéta (Haveke), Temala (Hmwaveke), and some isolated houses in the middle, as well as diasporically in Bopope and Atéou. Nowadays, work in the nickel mines and the cargo ports, coupled with a lack of legal restrictions to buy cars without a driver's license, have afforded most families with the means of traveling long distances to visit relatives and maintain social ties. This, however, has also changed the languages with which Vamale speakers are in contact. Nowadays, cars dominate mobility and define it. Roads lead to Hienghène and Touho, so Fwâi and Cèmuhi have gained influence. Crossing the mountains leads through Cèmuhi and Paicî areas, and going to Tiéta and Temala takes up to 4 hours. The nearest road connecting the coasts leaves the shore for the mountains at Touho, 30 km from the southernmost Vamale community, Téganpaik. Tiéta,⁸ where Vamale's closest linguistic neighbor Hmwaveke is spoken, can only be reached via Voh (a journey of 3 hours minimum by car). As Rivierre notes, this has led to a differentiation of the former language Hmwaeke into Fa Tiéta (Hmwaeke mixed with Hmwaveke) and Vamale (influenced by Pije, Fwâi, and Cèmuhi) (Rivierre & Ehrhardt 2006: 14). Furthermore, traveling used to imply staying somewhere for a while, since it was impractical to walk for days only to stay for a short while. This tradition of longer stays used to cause intensive language contact, and is now in decline. While there are still people alive who used to travel regularly to the other side, and mixed marriages connecting the two coasts are not rare, there is a real break between the speech communities. The two coastal villages Téganpaik and Tiouandé are right on the national main road which runs along most of the east coast, while the others, We Hava and Tiendanite, are between 20 and 45 minutes by car from this main axis. The latter experience less contact, and less attrition.

Vamale has been in contact with other, not readily intelligible, languages for centuries. It is surrounded by North Northern Caledonian languages of the Hienghène cluster, and Central Northern Cèmuhi, see Figure 3.14. While this is also the case for Haeke and Bwattoo (Haake), which mostly interact with Paicî, some

⁸Ceta/Caa-ta 'setting down the foot to go up, doorsill'

3 Language family, neighbors and previous work

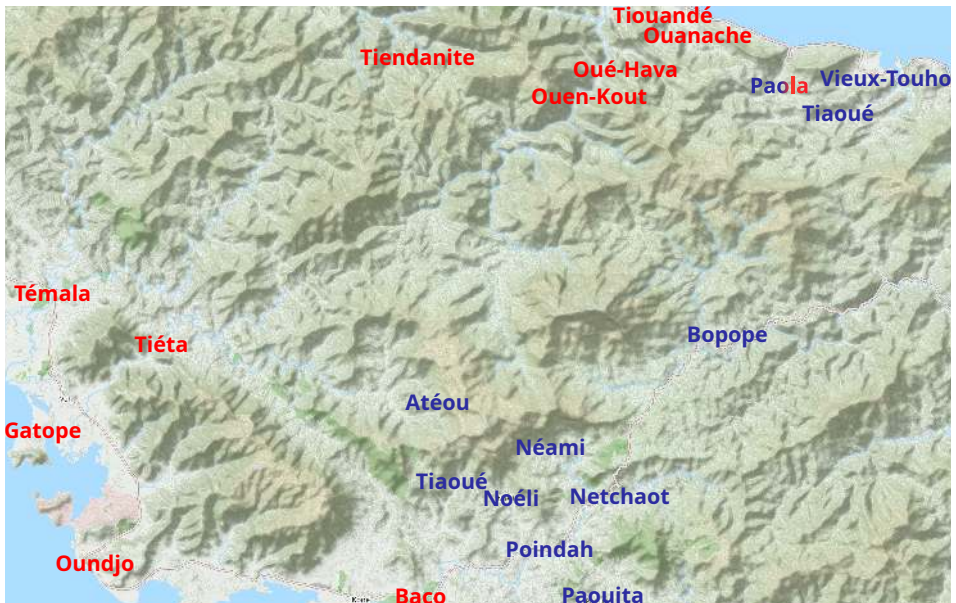

Figure 3.14: Languages in the region, Voh-Koné-speaking villages in red, Paicî-Cemuhî-speaking ones in blue (adapted from Gouvernement de la Nouvelle-Calédonie 2019)

© OpenStreetMap contributors. Tiles courtesy of Andy Allan

Cèmuhî, and Pwaamei in the north, only Vamale is surrounded from all sides by non-Voh-Koné languages. Vamale has adopted the subject marker *e* = ‘1SG’, as well as phonological traits from Cèmuhî (see §5.3.2), as well as loan phones from Pije. Leenhardt’s (1946) description suggests that lexical changes have occurred. (Leenhardt 1946: 162–168)

- *da* ‘who’, still used in western varieties, is now *kai* ‘who’ in Vamale, and *kai kai* ‘for whom?’ was substituted with *nya(si/ko) kai*.
- The indefinite articles have all changed: *en* ‘a, other’, still found as *ven* in the Usa variety, is lost in Vamale, which now uses *eca* ‘INDF.SG’ and *se* ‘other’. *men* ‘INDF.PL’ and *mun* ‘INDF.DU’ were used in demonstrative settings (Leenhardt 1946: 165). Nowadays, putative equivalents would be *ca* for the plural and *muca* for the dual.
- There used to be more forms for adhortative exclamations (“vocative”), distinguishing adults from children (*hai* and *hnei*, respectively), whereas now there is only *ha*.

3.2.2 Multilingualism and variation

The author has met no-one between Téganpaik and Hienghène who speaks a Kanak language since birth without speaking another one. This is one of the first things someone will tell you: “I do Vamale a bit but also Pije and Fwâi”. People swear in three languages, they freely mix in words from other languages if they can’t remember them, and they constantly code-switch functionally to mark their belonging to a group, to the description project, if they do not want somebody to understand, etc. This includes Usa, the variety spoken in Tiendanite. Speakers are able to adapt to coastal varieties, weave in Pije words, etc. In 2017, the author was present at the council of clans in Tiouandé, a monthly public meeting where all local affairs are discussed. I was there to give an update on the work. A conversation about a local criminal was done almost entirely in Pije, before the council switched back to Vamale. This was likely due to privacy reasons, as they knew that I grasped some Vamale but no Pije. The choice of language among most middle age adults is functional and relatively free. There is thus probably no native speaker in the area who is not fluent or at least somewhat competent in another Kanak language. Male Cèmuhi speakers are an exception and usually only speak this one Kanak language; due to exogamy, many women come from another language area.

3.2.3 Neighboring languages

Vamale speakers have daily contact with other languages, most of which would not be readily intelligible. Pije is spoken in every Vamale-speaking village, and Cèmuhi by neighboring villages, as well as by local political authorities. Haeke, a Voh-Koné language, will also be discussed in some more detail below, not for its geographic proximity, but because the increased mobility of speakers has intensified contact with it.

3.2.3.1 Pije

Pije (ISO 639-3 piz) is spoken in the same villages as Vamale. There is a coastal variety with about 70 speakers left; the Tipije varieties having all but disappeared due to the war. A mountain variety spoken in Tiendanite, called *tha* (Haudricourt 1968: 229), is relatively vital; it is the majority language there and practiced by many children (whereas Usa’s youngest speaker is in her 20s). Pije is the most spoken indigenous second language of Vamale speakers. During elicitation sessions, Pije words were often given before being corrected. One reason for Pije’s dominance in the area I’m focusing on is indigeneity: Pije is the land-owners’

3 *Language family, neighbors and previous work*

language here, the coast between Téganpaik and Pedaa (Pindache) used to be in Pije-speaking hands, and a migration of Vamale speakers led to a complexification of the sociolinguistic situation. With the Vamale river flowing into the Tipije, language contact was always a fact of life in the upper valleys, but this contact has changed and intensified after the war. This also means that Pije is a language of prestige, the “original” language, and many families reported a paternal (land-owning), Pije-speaking bloodline coupled to a maternal, Vamale-speaking one. Many residents were doubtful of the legitimacy of the project, as it should be Pije, more endangered and more autochthonous as it is, that should have been documented before Vamale.

3.2.3.2 Fwâi

Fwâi (ISO 639-3 fwa) is the language of Hye-hen (Hienghène, ‘cry-walk’), the administrative center north of the Tipije river, and the school town of We Hava. The hospital, the market, an active cultural scene, and a bar, all attract residents of the three villages, and since the main road connecting Hienghène to the south runs through Tiouandé and Teganpaik, language contact is extensive. The main lexical influence seems to be swearwords, and the languages are not mutually intelligible.

3.2.3.3 Cèmuhi

Cèmuhi or Camuki (ISO 639-3 cam) is a tonal language with 3 register tones. It is spoken in the villages west of Téganpaik up to Kokingone, and is the language of Great Chief Bouillant/Bwiyâ as well as most villages in the Great Chief’s domain (to which most Vamale speakers belong). It is used for official purposes by the Great Chief’s *porte-parole* ‘heralds’, and can thus be considered a regular contact language for Vamale, but is not intelligible with the latter and functional communication occurs in French. With around 3,300 speakers, it is one of the biggest languages in the area.

Vamale would have been surrounded by Cèmuhi speakers for some time before being moved to the coast. The villages Netchaot (Paicî/Cèmuhi) and Bopope (Cèmuhi), as well as the warring factions in the 1903 conflict Touho and Poyes, all spoke Cèmuhi. There was, however, a relatively stable and cohesive dialect chain of Voh-Koné languages from the west coast to Pamale, which suggests that for a while, contact happened eye-to-eye.

3.2.3.4 Haeke

Haeke (ISO 639-3 aek) speakers, especially of the clans Wabealo and Cidopwaan, are tied through marriage to Vamale speakers, and according to Guiart, the mentioned clans claim to descend from the Paicî Naoutchoue/Naauuwè lineage (Guiart 1992: 92), with whom the Pei clan (important in Téganpaïk) is closely tied. Speakers of Vamale, thanks to cars, family ties (see the map Figure 4.2) and frequent festivities, are now in more regular contact with other Voh-Koné varieties, especially Bwato and Haeke. However, the speakers the author spoke to were very aware of the differences between different speech practices and desirous to keep them distinct. Haeke is closer to Bwato and features typical Western Voh-Koné traits such as interdental fricatives, but as a funeral ceremony speech held in Haeke was understood by most Vamale speakers, some mutual intelligibility may be postulated. Haeke is highly endangered as well, and most contact happens in French.

3.3 Previous work

Vamale is almost exclusively an oral language. It is used in church (at least in Téganpaïk) for songs; Néa Galé of Baco has published some prose, and some songs are archived, recorded by Haudricourt in 1963 (Nea 1963). The Protestant missionary and pastor Maurice Leenhardt was based in Houaïlou, but was active across the entire archipelago and wrote extensively about Kanak languages and cultures. His most important linguistic work is *Langues et dialectes de l'Austro-Mélanésie*, published in 1946. Short grammar sketches on almost every language at the time are followed by a comparative word list of over 1,000 items. This is the most extensive work done on Vamale (“*Moaëke*”) to this day. While a number of items were deemed by speakers to be loans from other languages, mostly Pije, the list is the only published trace of the names of gods, dances, and objects since lost.

André-Georges Haudricourt worked in New Caledonia between the 1940s and the late 1970s. The relevant articles are overviews over the phonological systems of all then-described languages (1961), and grammatical typologies of the archipelago (e.g. 1948, 1972, 1948). Haudricourt’s only work on Vamale, a dictionary project, was never published and is presumably lost (Rivierre & Ehrhardt 2006: 18).

Jean-Claude Rivierre worked on Paicî (1983) and Cèmuhi (1980, 1993), as well as on Bwato (2006, a grammar sketch of 45 pages with a detailed dictionary following), and was the most important author on Vamale’s immediate neighbors (e.g. 1994). He also assembled a precious dictionary of Hmwaveke containing

3 Language family, neighbors and previous work

Vamale items, unfortunately not yet published: *Projet de Dictionnaire Thématique En Langue de Tyéta (Hmwaveke)*.

ma gavwe xaleke, ka caihnan. ‘May you see, and know.’



Figure 3.15: Mr. Pei and Mr. Kalène on the path to Wanaa

4 History of speakers

Knowing the history of the speech community helps to understand the length and intensity of exposure to today's contact languages, and to identify possible past dwelling places of speakers. The exact history of Vamale speakers is poorly studied. This section mainly aims at reconstructing the approximate distribution and the contact languages prior to the major population movements of 1904 and 1917, and to give a brief overview of the reasons why the language lost so many speakers. The account given here is different from the situation described in detail by Guiart (1984: 91–93), and yet different from Leenhardt (1978a: 20), partly because most clans have changed names. The following is a summary of written and oral sources; some details remain unclear.

4.1 Pre-1917

Pamare (the Paicî name)/Pamale/Vamale is the name of a river tributary to the Tipije, flowing northwards from (Na Unu) Pamale mountain, just southwest of the Cigu Tchingou massif. Oriented almost exactly south-north, it flows from an area today uninhabited and bordered by Cèmuhî speakers (see Figure 4.1), until it unites with the Vawe river,¹ at a river bend and becomes the Tipije T̃ipindjé river, joined after a few kilometres by the Usa creek.

The Vawe, Pamale, and the upper Tipije valleys are said today to have been inhabited by Vamale speakers. Pamale is said to have been a great chieftaincy (Gohoup 2008: 59). The North of the island, roughly north of the Cèmuhî domain, was loosely structured into two alliances: *Hoot* 'great tide' and *Whaap* 'raven', today eponymous of the customary area *Hoot ma Whaap*. The Tipije valley was *Hoot* but the later refugees of Pamale people, Wanas/Wanaa, Temala and Tiéta, were *Whaap* (Guiart 1954: 6), so a cautious assumption may be made that Pamale refugees followed old paths of alliance. See Figure 4.2 for a visual representation of Guiart's analysis.

The local distribution of languages before the 19th century is difficult to estimate. However, around the turn of the last century, the land between the Cigu

¹The Vawe tribe is mentioned in Leenhardt (1978b: 26) as well as in Sand & Ouetcho (2001), and the Pei and Fouan clans claim to be from there.

4 History of speakers



Figure 4.1: Map of the Pamale river

mountains and Koné, south of the Hienghène and at least up until Wan Kuut is likely to have been speaking varieties of Hmwaeke/Vamale. Clans speaking it almost certainly formed minority speaker populations in the allied valleys of Wanaa(s) (Ouanache), Thexhwaade (Tiouandé), We Hava, Pwey (Poyes), and on the other side of the mountains in Temala, Ceta (Tiéta), and Koogo (now deserted), as frequent exchanges were maintained with these villages, and this is where the refugees went (see Figure 4.3). The chiefs of Wanaa and We Hava spoke Vamale (Leenhardt 1978a: 20).

4.2 The 1917 War

On May 10th 1901, a peace meeting took place in Pamale (*Paix de Pamalé*). At the time, the area was not yet directly concerned by land spoliations or missions, though oral accounts speak of Pamale as a refuge for people driven from their lands (Bensa et al. 2015: 368, 369). The parties discussed the “Affair of Poyes”, a



Figure 4.2: Selection of precolonial clans adapted from Guiart's 1979 map *Clans autochtones: Situation pré-coloniale*, green highlights for Hoot and yellow for Hwaap lineages, red for Bai and blue for Dui. (Guiart 1981: 71)

conflict between war chief Amané of Poyes and chief Hippolyte of Touho. Whatever the real reason was – a woman, capitation tax, cooperation with Europeans, or land – the two reconciled.

On the one side was Amané, a powerful war chief in the Cèmuhi-speaking village Poyes, who claimed land all the way till Paola on the west coast, according to a police report (Leenhardt 1978b: 24). He was a brother of Bwiyang, chief of Poyes. According to Amané himself, he had been promised since birth a woman whom Hippolyte of Touho took for himself. Amané wanted her back. Another explanation is the difference in stance towards Europeans. Hippolyte was Catholic and in close cooperation with European missionaries. Due to his exposed situation on the coast, his father Napoléon had already been in contact with Europeans, whereas Poyes remained relatively independent (Leenhardt 1978a: 21). According to (Protestant) Leenhardt, Hippolyte ruling over a militarily weak tribe (Leenhardt 1978b: 28) was manipulated by the local Catholic missionaries, the peace meeting was an overreaction and the Poyes had not even attacked yet. It may also have concerned the capitation tax (Leenhardt 1978b: 23, Philcat 1989: 13), which Amané refused to pay, whereas Hippolyte cooperated with the occupier. In any case, Amané met with his adversary, and Governor Paul Feillet, the missionary Maurice Leenhardt, as well as Kanak dignitaries from as far away as Houailou,

4 History of speakers

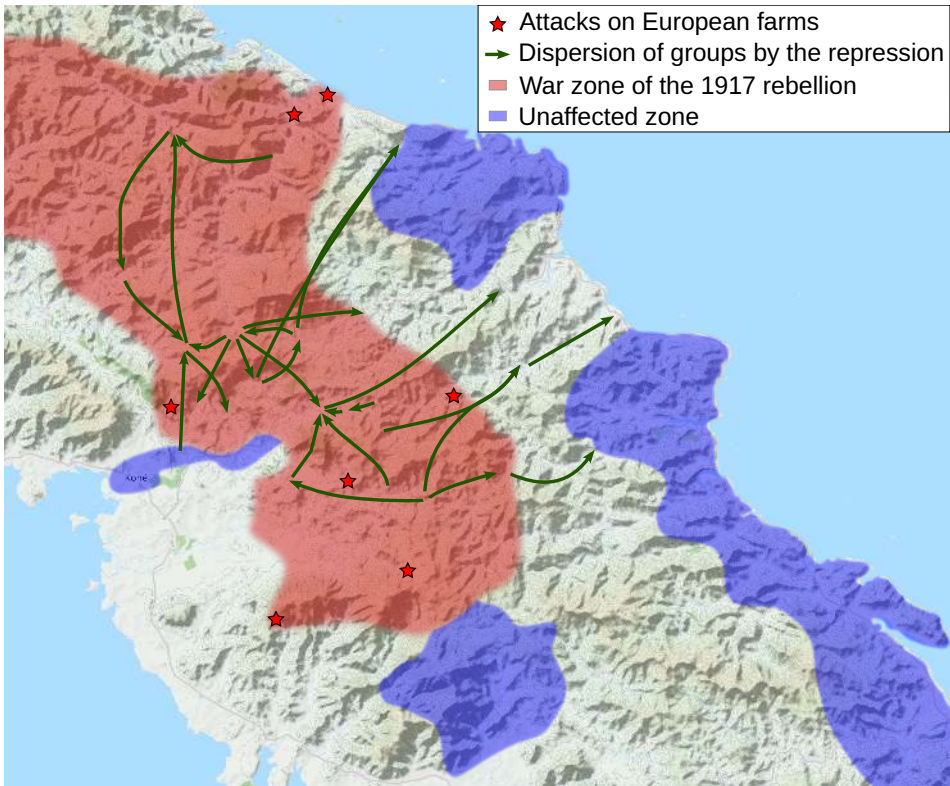

Figure 4.3: Main movements of refugees following 1917 (Bensa 2008: 7). Many movements leave Pamale (“Pëmäre”).

for a peace palabre Leenhardt (1978b: 24). The two reconciled. After the peace meeting, the ‘Thunder of Poyes’ Amane held several reunions in Pamale.

Possibly in response to this subversive behavior (Saussol 1979: 289), or because Pamale was a safe haven for refugees, the Pamale lands’ reservation status was revoked by the government by the (unpublished) *arrêté* n°775 on June 30th 1903 (Guiart 1970: 282), enacted on July 30th 1904 (Guiart 1992: 92, Philcat 1989: 22).

The reservation status had been Pamale’s only protection from state-sanctioned spoliations (Demmer 2003: 3), and the land was bought by the Belgian cattle rancher Charles Metzdorf. He founded a cattle “station”, a ranch, at Pamale (Guiart 1970: 273). The same year, possibly to avoid conflict with the population, Metzdorf’s manager brought in *gendarmes* who burned the houses of the Pamale, as well as the houses and the Protestant temples in Pije-speaking Pupay (Puepaek) and in Paada, and the village of Pwekea Kalemumak (upper

Voh valley, probably Haveke-speaking) (Guiart 1970: 266). This act of war may have targeted clans who were allied to Pamale families and their neighbors, and who could have taken in refugees. Governor Feillet claims his group arrived on Charles Metzdorf's cattle-station in Pamale on the 10th of May 1901 and slept in the recently abandoned cattle station in Vawe (Leenhardt 1978b: 26), both of which can only have existed legally 3 years later, after Pamale was erased from the map with fire and guns, as mentioned above (Leenhardt 1978b: 27). Governor Feillet cannot have confused the dates because he left for France on October 18th 1902 and died in Montpellier September 2nd 1903 (Leenhardt 1978b: 29). Whether Metzdorf came earlier than officially claimed and then had the reservation revoked in order to avoid neighborly conflicts with the dispossessed former inhabitants could not be reconstructed by the author. Metzdorf would later leave the area to be succeeded by the Ouaco mining company. It, too, left by the early 1930s (Guiart 1970: 266). The land is now in customary hands and used as hunting grounds by the villages Néami and Noéli.

As a reaction to the destruction of their houses, the Pamale tribe,² which had moved north, hosted war *pilous*³ in 1913 (Guiart 1970: 266). This took place in a simmering martial context, and several attacks from various tribes on European stations erupted all over the area in the years after. A book dedicated to the topic is *Les Sanglots de l'aigle pêcheur – Nouvelle-Calédonie : La Guerre Kanak de 1917* (Bensa et al., 2015).

The Bwaarhat clan, great chiefs of the Fwâi-speaking Hienghène coast, had been in conflict with the European forces since the 19th century, and several generations of chiefs had been sent to exile in Tahiti (Clifford 1982: 102). When Bwaarhat sent the black war money up the Tipije, its great chief Kafeyat Cidopwaan sent it further up to Pamale.⁴

The Tipije war of 1917 broke out after long discussions between the chieftaincies. Whether Pamale's chief Athea Sergent Mërëatu actually agreed to participate in the fighting or not is unclear, but does not seem to have played a crucial role. He was not a chief of an existing settlement anymore (Guiart 1970: 277). Warriors from Pamale were among those who slaughtered the Grassin family, the settler Papin and the Tahitian soldier Elizera in We Hava on June 16th 1917 (Boubin-Boyer 2015: 24). They were also part of the war party from whom the

²Since a decentral spatial organisation was described for Pamale in 1857, I use the same term as my sources here instead of "village", which is more appropriate for the current situation.

³A Kanak word for 'dance', *vila* in Vamale, for festive meetings and palabres.

⁴He, too, is a controversial figure. Muckle expands on his changing reputation with the colonial government (Muckle 2010: 139–141).

4 *History of speakers*

settler Ragot in Wanaa was saved either by Leenhardt (according to his descendant, Leenhardt 1978a: 20) or defended by the locals (according to Ragot's descendants). In total, 8 settlers were killed in the area. As a result, almost every village, involved or not, was burned down between Koné and Poyes. Over a dozen villages in the Tipije valley and its tributaries have disappeared, including the ones to which Pamale residents had fled after their valley's destruction in 1904. While this account focuses on Vamale, the majority of the villages concerned were Pije-speaking, a language which is now even more endangered than Vamale.



Figure 4.4: Metzdorf's cattle-ranching station. CC-BY-SA Heim, (Heim 1921)

Philippe Dejo Gohoupe (“Hao Cakeo”)’s account from the 11th November 2016 claims that Vamale speakers came from Mt. Pamale further southwest in the mountain range, and at some point moved to the valley of Tipije, whence they were chased in 1917. This is confirmed by late Galé Kalen’s account from the 6th September 2017, as well as Bensa & Goromido (1997) and Leenhardt (1978b), among others. A resettlement of the Pamale valley is unlikely in the near future, as it is considered cursed and the traditional ownership is far from clear. Some families fled to Tiendanite (confirmed by Agnès Wathea, 29.11.2017), while others chose to follow the Tipije river down to its tributary We Hava and the Pije-named

4.3 French policy and decline of the language

coastal villages Téganpaik, Wanaa and Tiouandé. This would explain not only the dispersion of the community, but also the languages with which they are in contact: Pije, Nemi, and Fwâi⁵ for Tiendanite and We Hava, Pije and Cèmuhi for the coastal villages.

The Usa variety is nowadays spoken in Tiendanite. Politically, Tiendanite is chief Goa's domain, a rival of chief Bwaarhat, whereas in 1917, Wan Kuut's chief Kavéat was an ally of both Bwaarhat and Pamale's Athea Sergeant. Usa speaker Agnès Wathea mentioned that her father's clan, from Usa, was welcomed to Tiendanite by its chief, though Usa was under Athea's control, and thus not a village allied to Tiendanite. Furthermore, Vamale speakers are likely to have been on the coast prior to the war. Although the coast was disturbed by European presence, Vamale-speaking chiefs were already well in place in We Hava and Wanas by 1917 (Leenhardt 1978a: 20). Overall, this suggests a speaker mobility on an individual and family level that was relatively unimpressed by chiefs and higher politics, and followed personal alliances. This is supported by Bensa's map in Figure 4.5, which shows a visual representation of three oral histories, mostly pre-colonial. Regardless of this free individual networking, most family histories are tainted by the war.

4.3 French policy and decline of the language

After the war, contact with the French and their language was sporadic until the 1950s. The colonial government locked Kanaks of diverse origins into reservations, hoping that their catastrophic demographic decline from perhaps 400,000⁶ people before contact (Sand et al. 2007: 316) to just about 27,000 in the early 1920s (Sand et al. 2007: 309) would in time lead to a total disappearance in contact with a "superior race" (Stern 1943: 289, Salaün 2005: 2). French colonial language policy was not very invasive and concentrated on prohibiting the use of indigenous languages in public⁷ (Salaün 2005: 2). However, most Kanaks were confined to reservations (Demmer 2003: 3) in which the only outsiders were missionaries and *gendarmes*, so even that policy did not affect many people.

⁵Tiendanite and We Hava send their children to school in Fwâi-speaking Hienghène.

⁶To our knowledge, the only person to have proposed a density model for Grande Terre was the geographer J. P. Doumenge, who believed in a low population of about 65,000 people at contact. Nevertheless, he proposed a density of "130 to 145 inhabitants per square kilometer of used horticultural surface" (Doumenge 1982: 463, original text in French). Reducing his figures by half (i.e., seventy p/km²) to account for the vague status of the phrase "used horticultural surfaces", and again using only one-third of the surface of the island, we would arrive at 400,000 people." (Sand et al. 2007: 316)

⁷The "public" being defined by the presence of settlers.

4 History of speakers

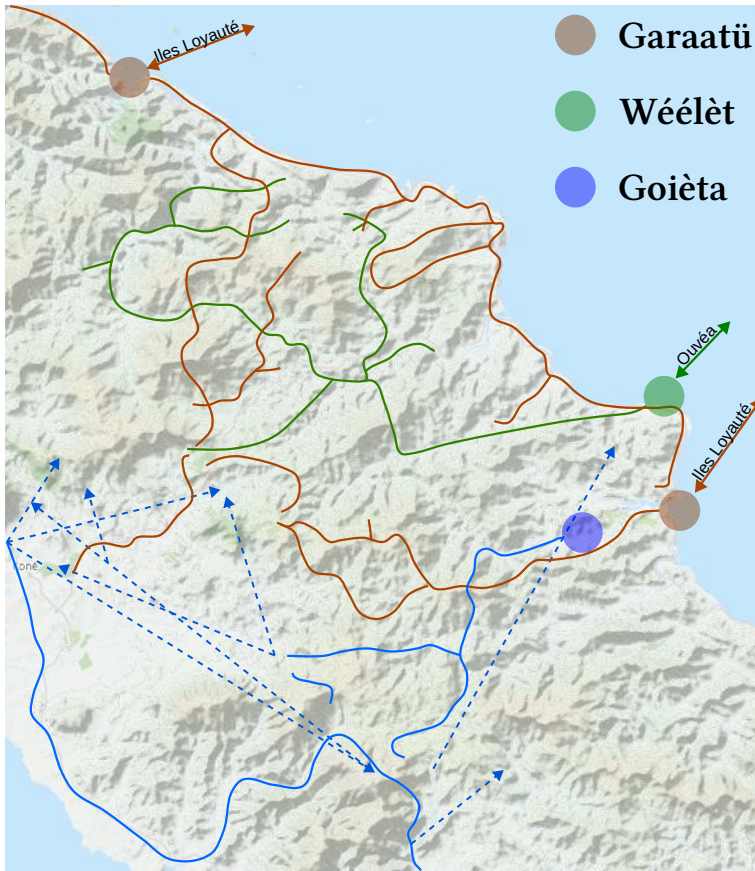

Figure 4.5: Map showing some clans' migrations in the Touho-Hienghène area, following Guiart 1981: 71

The event truly leading to speaker decline was schooling, which only began on any scale to speak of in the 1950s.⁸ Before that, Kanaks were not citizens,⁹ and the only schooling was privately done by the churches. Most elders in the villages do not enjoy speaking French and are multilingual in Kanak languages. Until the 1980s, the Vamale-speaking area was untouched by public schooling. Most children went to the Protestant private school in Tiouandé (*Fédération de l'enseignement libre protestant, F.E.L.P.*, closed in the 1980s) or to Catholic institu-

⁸Note that Leendhardt counted only around 50 speakers in the 1940s, but schooling prevented a subsequent language transmission, and therefore a quicker recovery.

⁹The *Code de l'Indigénat* specifying this was abolished in 1946, but this was not noticeably implemented until 1952.

4.3 French policy and decline of the language

tions like the one in Tuo Mission. Nowadays, all children go to the public schools in Hienghène (for Oué Hava) and Touho (for Tiouandé and Téganpaik), where the dominant Kanak languages are Fwâi and Cèmuhî respectively. TV, radio, the spread of smartphones and the advent of mobile internet in early 2019 have added to language contact.

5 Phonology

There are 55 phonemes; 20 phonemic vowels (5 qualities, length and nasality are contrastive) and 35 consonants. The number of both consonant and vowel phonemes puts the phoneme inventory of Vamale in the top 10% on Phoible (with ca. 3000 compared inventories) (Moran & McCloy 2019), and in the second-largest group of the sample studied by Maddieson et. al in *The World Atlas of Language Structures Online*, which assigns it a high consonant-to-vowel quality ratio.¹ The emphasis on consonants is typical of the Northern and Far Northern languages, and was not diminished by the proximity of consonant-poorer Cèmuhî, nor was it substantially enriched by Pije, which has e.g. /t̪/.

5.1 Transcription

Following the transcription system established by Ozanne-Rivierre (1982), this work will use ⟨h⟩ after plosives to mark aspiration (regardless of its phonemic status), ⟨h⟩ before nasals and liquids to mark voicelessness, and the circumflex diacritic to mark nasal quality in vowels (see Table 5.1 for an overview). All voiced plosives are typically pre-nasalized: /^mb/, /ⁿd/, /^ɲʒ/, /^ŋg/. This is systematic and, following the local linguistic tradition, will not be represented. Vowels are nasalized after nasals, and often also before them (this includes the pre-nasal elements in voiced plosives such as /^mb/, to an extent). There is also interplay with aspirated plosives for historical reasons (see §5.2.5). Only phonemically nasal vowels will be represented as nasal, with the circumflex diacritic ⟨[^]⟩ used in all Northern transcription systems. Compare the representations of (1) with phonemic nasalization with (2) with predictable aspiration.

- (1) [wĩːn jeː]
wĩː-n yee
strength-NSPEC.POSS tree
'strength of a tree'

¹Note that this counts vowel qualities but not contrastive quantity, hence 35 consonants/5 vowels yielding a ratio of 7.

5 Phonology

- (2) [wĩ:n je:]
wii-n yee
 field-NSPEC.POSS tree
 ‘orchard’

True minimal pairs between oral and phonemic nasal vowels are rare, while contexts in which phonemically oral vowels are nasalized abound. The degree of nasality depends on the speaker, so the phonetic difference depicted in example (1) is not a representative or reliable criterion to identify phonemically nasal vowels, though the latter tend to be more strongly nasal than nasalized ones.

Table 5.1: Transliteration system used in this book

⟨ph⟩ /p ^h /	⟨phw⟩ /p ^{hw} /	⟨th⟩ /t ^h /	⟨ch⟩ [c ^h]	⟨kh⟩ /k ^h /	
⟨p⟩ /p/	⟨pw⟩ /p ^w /	⟨t⟩ /t/	⟨c⟩ /c/	⟨k⟩ /k/	
⟨b⟩ / ^m b/	⟨bw⟩ / ^m b ^w /	⟨d⟩ / ⁿ d/	⟨j⟩ / ⁿ ʃ/	⟨g⟩ / ⁿ g/	
⟨hm⟩ /m̥/	⟨hmw⟩ /m̥ ^w /	⟨hn⟩ /ŋ/	⟨hny⟩ /j̥/	⟨hng⟩ /ŋ̥/	
⟨m⟩ /m/	⟨mw⟩ /m ^w /	⟨n⟩ /n/	⟨ny⟩ /ɲ/	⟨ng⟩ /ŋ/	
⟨f⟩ /f/	⟨fw⟩ /f ^w /	⟨s⟩ /s/	⟨xh⟩ /x/	⟨xw⟩ /x ^w /	⟨h⟩ /h/
⟨v⟩ /v/	⟨vw⟩ /v ^w /		⟨x⟩ /ʃ/		
		⟨l⟩ /l/	⟨y⟩ /j/	⟨w⟩ /w/	
		⟨hl⟩ /l̥/	⟨hy⟩ [ç] ~ [j]		
⟨i⟩ /i/		⟨ii⟩ /i:/			
⟨î⟩ /ĩ/		⟨îî⟩ /ĩ:/			
⟨e⟩ [e] ~ [ɛ]	⟨ee⟩ [e:] ~ [ɛ:]				
⟨ê⟩ /ẽ/		⟨êê⟩ /ẽ:/			
⟨o⟩ [o] ~ [ɔ]	⟨oo⟩ [o:] ~ [ɔ:]				
⟨ô⟩ /õ/		⟨ôô⟩ /õ:/			

Vamale speakers frequently code-switch to French. Established loanwords such as *watuut* ‘car’ are transcribed according to the system in Table 5.1, whereas *ad hoc* loans are written as they would be in French and italicized to help distinguish them from older Vamale words (3).

- (3) *tha le=vwa devoirs-le*
 ASS 3PL=do homework-3PL.POSS
 ‘They do their homework.’

5.2 Consonants

The consonants, shown in Table 5.2, can be classified along two axes: aspiration (aspirated vs. non-aspirated) and nasality (nasal vs. semi-nasal vs. oral). This has historical reasons, as will be shown in §5.2.4. While all consonants may appear word-initially and between vowels, a historical neutralization has reduced the set of syllable-final ones: /p, t, tɕ, k, m, n, ɲ, ŋ/, i.e. simple voiced nasals and voiceless plosives. Syllable-final /k/, /tɕ/ and /ŋ/ are much rarer than the others and are undergoing mergers with /ʔ/, /t/, and /n/ respectively.

- /piuk/ ‘spark’ → [pi.uʔ]
- /jilowec/ ‘tree sp.’ → [ˈɲi.lo.wɛt]
- /wap/ ‘consequence of taboo breaking’ → [wan]

/k/ and /tɕ/ are often simply dropped. The deletion of final consonants is a sound change that is described as affecting mountain Voh-Koné varieties (Campbell 1987: 25), and is furthest advanced in the coastal variety of Vamale. This final consonant deletion only concerns inherited lexemes, since numerous loanwords from French and Kanak languages feature other syllable-final consonants (*bagaas* ‘luggage’, *cakes* ‘EXPL’). While syllable-final /k/ is often dropped, /k/ is also rare in syllable onsets: many words with k- are either loans or grammatical terms, e.g. *ka* ‘SBJ’, *ka* ‘CNJ’, *ko* ‘obl’, *-ke* ‘TR’, *kai* ‘who?’, *kacahô* ‘rather than’, *kavi* ‘but’. Lexical, apparently non-borrowed words number fewer than 10 items in the recorded dictionary. While a historical sound change lenited *k- to ɣ- (see §5.2.2), explaining the rarity of k-, it is noteworthy that many words that retained initial k- are grammatical terms.

Vamale consonants distinguish a voiceless series from a pre-nasalized voiced series. This is a feature retained from Proto-Oceanic, and not widespread east of New Caledonia (Ozanne-Rivierre 1992: 196–197). A typical feature of Northern New Caledonian is the presence of labio-velar plosives and fricatives, and voiceless nasals and liquids. Labio-velarized consonants do not precede /u/ and /o/ for historical reasons: one element merged into the other.

5.2.1 Examples

A table listing examples in word-initial, -internal, and -final positions is given in Table 5.3. No study was done on the frequency of the phonemes, but some consonants are much rarer than others. Syllable-final /k/ has all but disappeared in

5 Phonology

Table 5.2: Consonants in Vamale. Non-phonemes are in brackets.

	Bilabial	Lab. Bilab.	Labiod.	Lab. Labiod.	
Plosive	p ^h p ^{mb}	(p ^{hw}) p ^{w mbw}			
Nasal	m̥ m	m ^w m ^w			
Tap					
Fricative			f v	f ^w v ^w	
Approximant					
Lat. Approx.					
	Alveolar	Palatal	Velar	Lab. Velar	Glott.
Plosive	t ^h t nd	(c ^h) c ^{nɟ}	k ^h k ^{ng}		
Nasal	n̥ n	ɲ̥ ɲ	(ŋ̥) ŋ		
Tap	(r)				
Fricative	s		x ɣ	x ^w	h
Approximant		j		w	
Lat. Approx.	l̥ l̥				

a regular sound-change, and occurs only in loans from Pije and other languages: e.g. *piuk* ‘nail’² and *xhwahyuk* ‘whistle’ are originally Pije. /r/ only occurs in loans. Initial /ŋ/ is probably a loan phone from Pije, given that it only appears in one plant species name (*ngeein*), and is in free variation with *mwangin* ~ *ngangin* ‘sour’. Finally, all aspirated plosives except /t^h/ are rare.

5.2.2 Marginal phonemes

Some segments appear rarely, are not produced by all speakers, or present a distribution which hints at (former) allophony. This affects most voiceless plosives, the tap ⟨r⟩ [r], the voiceless lateral approximant [l̥] and the voiceless velar nasal. ⟨hng⟩ /ŋ̥/ only appears in *jahngan* ‘length’, and is in free variation with its voiced counterpart. Three factors indicate that /ŋ̥/ is a loan in this word: (a) the aspiration of nasals can be almost or completely inaudible (intervocalic nasals are more audibly aspirated than initial ones), (b) neither Bwato nor Hmwaveke seem to have it in any other words, and (c) only Western Nemi (no present-day contact) has it as a phoneme.

²POc *pituqun, *pijuk* ‘star’ in Nêlêmwa (Bril 2002: 21).

Table 5.3: Examples showing Vamale consonants in monomorphemic words.

Initial		Medial		Final
Plosives				
<i>pwan</i>	‘on’	<i>sapwen</i>	‘clothing’	
<i>phwaat</i>	‘clear’	<i>xhwaaphwê</i>	‘araucaria sp.’	
<i>bwan</i>	‘head’	<i>siibwi</i>	‘rat’	
<i>pa</i>	‘PRF’	<i>ape-</i>	‘trace’	<i>thap</i> ‘pandanus’
<i>phuake</i>	‘prod’			
<i>ba</i>	‘wall’	<i>abu</i>	‘1DU.EXCL’	
<i>thake</i>	‘throw’	<i>mathila</i>	‘bird sp’	
<i>ta</i>	‘go up’	<i>mata</i>	‘sing’	<i>fuut</i> ‘whistle’
<i>da</i>	‘spear’	<i>udu</i>	‘drink’	
<i>cabi</i>	‘break’	<i>kicaa</i>	‘jealous’	<i>tuuc</i> ‘take out’
<i>jigo</i>	‘mangrove’	<i>vije</i>	‘bird snare’	
<i>ka</i>	‘SBJ’	<i>buke</i>	‘flower’	<i>piuk</i> ‘spark’
<i>gi</i>	‘adze’	<i>hagu</i>	‘snake’	
Fricatives, glides, and liquids				
<i>fuu</i>	‘wash’	<i>fufudo</i>	‘foam’	
<i>vaa</i>	‘war’	<i>fava</i>	‘four’	
<i>fwa</i>	‘hole’	<i>waafwap</i>	‘raven’	
<i>vwa</i>	‘do, have’	<i>xhaavwa</i>	‘wait’	
<i>siteke</i>	‘sacred’	<i>gase</i>	‘1PL.INCL’	
<i>xhopwen</i>	‘big’	<i>haxhi</i>	‘forgive’	
<i>xhwatin</i>	‘small’	<i>sixhwe</i>	‘imitate’	
<i>holeeke</i>	‘thank’	<i>yahan</i>	‘leave’	
<i>xat</i>	‘sun’			
<i>xhat</i>	‘clitoris’	<i>bwaxhu</i>	‘hat’	
<i>yatan</i>	‘name’	<i>vaya</i>	‘work’	
<i>wadan</i>	‘time’	<i>nyawan</i>	‘spirit’	
<i>ra-</i>	‘RECCONT’	<i>gere</i>	‘fat’	
<i>lu</i>	‘3DU’	<i>pwalalu</i>	‘rainbow’	
<i>hluupwi</i>	‘suck in’	<i>bwahli</i>	‘long’	
Nasals				
<i>hmwet</i>	‘tired’	<i>saahmwa</i>	‘banana’	
<i>mwa</i>	‘house’	<i>imwi</i>	‘grab’	
<i>hma</i>	‘arrive’	<i>cahma</i>	‘whereas’	
<i>ma</i>	‘COM’	<i>cama</i>	‘if’	<i>xam</i> ‘mat’
<i>hnep</i>	‘sail’	<i>ehni</i>	‘prox’	
<i>naen</i>	‘now’	<i>jinu</i>	‘power’	<i>thiin</i> ‘close’
<i>hnyimake</i>	‘think’	<i>bwihnyo</i>	‘clam’	
<i>nyau</i>	‘bad’	<i>xhanyip</i>	‘dream’	<i>wany</i> ‘punishment’
<i>ngein</i>	‘cycas sp.’	<i>dingan</i>	‘creek’	<i>vaang</i> ‘unknown’

5 Phonology

The tap ⟨r⟩ [r] is a phoneme in Nemi and in Fwâi (Ozanne-Rivierre 1982: 18; 19). It appears only in loanwords in Pije (Ozanne-Rivierre 1982: 17) and Cèmuhî (Rivierre 1980: 21), and does the same in Vamale. There is one instance where I recorded ⟨ra-⟩ as an aspectual prefix ‘to have been doing for a short while’ in unelicited speech. I was able to contrast it with ⟨xa-⟩ /ɣa/, compare examples (4) and (5).

- (4) *a=xa-soom la*
 3SG=AGT.NMLZ-swim be.here
 ‘S/he usually swims here.’

- (5) *a=ra-xa-soom la*
 3SG=RECCONT-AGT.NMLZ-swim be.here
 ‘S/he recently picked up the habit of swimming here.’

⟨ra-⟩ is described for Bwattoo as a continuative particle, see example (6) (Rivierre & Ehrhardt 2006: 57), whereas ⟨xha⟩ /xa/ is the habitual aspect marker (/ɣa-/ in Vamale). *Ra* is not used in these contexts in Vamale (where the continuative marker is *balan*). *Ra* is probably a loan from the West Coast, and [r] most likely a relatively free variant of /ɣ/, except in this one prefix *ra-* ‘RECCONT’.

- (6) *ka le ra vila na ni bee-le*
 CNJ 3PL *persist.* dance AGT DEF.PL peer-3PL.POSS
 ‘The others keep dancing.’

- (7) *a bwaa ra Numea*
 3SG IPFV *persist.* N.
 ‘S/he is still in Noumea.’

The status of [k^h] is tricky in the sense that, while both the aspirated and the non-aspirated phone exist, the aspirated one only very rarely occurs without a nasalized vowel following it. There are no minimal pairs with [k], and the few occurrences of [k^h] before oral vowels are loanwords or due to fortis-spreading (see §5.2.5).

Bilabial voiceless plosives exist with aspiration and without, as well as with labiovelarization. So far, the origin of either remains to be established, as the regular sound changes reconstructed by Ozanne-Rivierre mostly led to the development of fricatives. [p^h] is attested before the oral rounded vowels [u] and [o], and before nasal vowels. The latter are a sound class intimately related to aspiration, as is discussed in §5.2.5. Most instances of [p^h] before a nasal vowel may

be produced with a velar fricative [p^{hw}] ~ [pχ]. The glide [w] and rounded back vowels have merged in modern Vamale. There are no minimal pairs between [p^h] and [p^{hw}]. There are no perfect minimal pairs with either and /p/, though this contrast is clearer, e.g. neither /p/ nor /p^w/ precedes nasal vowels. Both /p/ and [p^h] before oral back vowels are rare. The following words constitute the entirety of the types recorded in the lexicon, many of which are found in non-Voh-Koné languages as well:

- *pu* ‘on the ground’
- *puput* ‘behind sth inanimate’
- *phuake* ‘wiggle’
- *poon* ‘coconut fibre’
- *phoop* ‘snail’, *phom* ‘butterfly’
- *pola* ‘type of weaving’
- *photha* ‘sexual taboo; women’s part of the village’³

Furthermore, there are no instances of /f/ and /f^w/ followed by a nasal vowel, but many cases of /f/ before rounded back vowels. Hence, an imperfect distribution of labiodental fricatives and bilabial aspirated plosives can be identified: front and central vowels are only found after fricatives, nasal vowels only after plosives, and rounded back vowels can follow either. In conclusion, [p^h] and [p^{hw}] may be former allophones of /f/ and /f^w/ before nasal vowels, and [p^h] is now present before oral vowels due to contact with other languages, perhaps Pije (Rivierre 1994: 518). The unaspirated bilabial plosives were borrowed from neighboring languages as well (Rivierre 1994: 516), or constitute remains of an incomplete sound change *p → v.

5.2.3 Labio-velarized consonants

Labio-velar consonants in Vamale are all labial (/^mb^w/, /f^w/, /m^w/, etc), with the exception of /x^w/. To explain this, Campbell suggests that /x^w/ should be analyzed as an allophone or a surface realization of /ɰ/ (Campbell 1987: 37), with /ɰ/ as the fortis /w/ (see §5.2.5 for an introduction to Vamale fortis). This makes sense as it makes the Hmwa(v)eke systems fit into their regional context, as voiceless liquids and glides are widespread in other Northern languages.

³From Leenhardt’s (1946) notes, not used nowadays.

5.2.4 Voiceless nasals

Every nasal except /ŋ/ has a fortis, i.e. voiceless counterpart, e.g. /ᵐu:n/ ‘smoke’ vs /mu:n/ ‘blossom’. Like most of the aspirated plosives, voiceless nasals in Vamale have probably developed from forms that were reduplicated in POc and geminated in PNC, and which were perhaps already devoiced in Proto-North, for instance *nana(q) ‘pus’ → *hnau/hnau-* ‘snot’ (Ozanne-Rivierre 1982: 27).

In Bwato and in Vamale, the phonation of nasals and liquids can be influenced by the fortis status of other consonants in the surrounding syllables. Bwato examples include the following, with the triggering consonants in bold:

- (8) (Rivierre & Ehrhardt 2006: 27)
- a. *fomwa* ~ *fo**h**mwa* ‘village’
 - b. *xhoomu* ~ *x**h**oohmu* ‘old’
 - c. *xhuni* ~ *x**h**uhni* ‘spear sling’
 - d. *x**h**waloo* ~ *x**h**wahloop* ‘be on the belly’

Even though voiceless nasals have a different historical development from voiced nasals, and though they contrast in some minimal pairs, this account is unsure of how to describe them phonetically. The nasal in ⟨hnau-⟩ might be voiceless [ᵐ], pre-aspirated [hn], or both, and it is unclear as of yet which of the allophones is the underlying form. The aspiration, even though it often starts before the nasal is articulated, does not seem to stop before the beginning of the nasal’s production (the result is thus closer to [hᵐãw̃]).

5.2.5 Aspiration

In Vamale, aspirated plosives were for the most part borrowed from neighboring languages, except for /t^h/. For reasons explored below, voiceless nasals and liquids, and aspirated plosives influence each other and have a similar history. Table 5.6 summarizes the distribution of aspirated consonants and nasal vowels, which also correlate, for reasons explored below. Aspiration is widespread in North New Caledonian languages, with the exception of tonal Cèmuhi and Paicì. Aspirated plosives developed from geminates, as did voiceless nasals:

- POc CV.CV reduplication is reduced to geminate CCV, and then to:
 - C^h in the non-tonal northern languages (Ozanne-Rivierre 1982: 27), then ultimately fricatives in Vamale
 - C^ʷ in Cèmuhi and Paicì (Ozanne-Rivierre 1992: 203).

In Vamale, however, this only led to aspirated word-initial plosives in the case of /t^h/: *tt̥, *cc → /t^h/ (Rivierre 1994: 513), which also explains the presence of minimal pairs contrasting nasal and oral vowels after /t^h/ (e.g. *tha* ‘ASS’; *thâ* ‘excrement’). A majority of /p/, /k/, and their aspirated counterparts can be attributed to loans, see Table 5.4 (Rivierre 1994: 516). This is a consequence of extensive language contact and near-universal multilingualism, where speakers would fill gaps in one language’s phoneme inventory with phonemes borrowed from other languages, which was made easier by the continued presence of voiceless plosives in inter-vocalic and word-final positions.

Table 5.4: Loans with aspirated and tenuis plosives, after Rivierre (1994: 516)

Vamale form	Gloss	Origin
<i>pik</i>	‘banded land-rail (bird)’	Pwapwa <i>pik</i>
<i>phom</i>	‘butterfly’	Pwapwa <i>pom</i>
<i>piuk</i>	‘spark’	Haveke <i>piu</i> ‘star’, from Pwaamei <i>piu</i>
<i>kuh(u)a</i>	‘gun’	Southern Mainland
<i>katia</i>	‘(person suffering from) leprosy’	Polynesian
<i>koin</i>	‘finished, end’	e.g. Pije <i>koin</i>

Furthermore, aspiration is, in many cases, not phonemic, but a result of spontaneous assimilation to other fortis consonants, i.e. voiceless nasals and liquids, and other aspirated plosives in the same word (Rivierre 1994: 518). Conversely, an aspirated plosive is sometimes followed by a voiceless nasal or glide as a free variant of the voiced segment usually produced. The same phenomenon is described for Bwato (Rivierre & Ehrhardt 2006: 27). Aspiration of plosives and nasals can occur spontaneously, e.g. /san-an-ea/ [sanaŋẽã] ~ [sanãẽã] ‘content-POSS-3SG.POSS’. Liquids are also affected, e.g. [x^walɔm] ~ [waɭɔm] ‘abcess’ (vamale-170912-dic-5, 1:37). Bwato is analyzed by Rivierre and Ehrhardt as having phonemic contrasts between all voiceless plosives and their aspirated counterparts (2006: 27).

Schooling argues for Yuanga that the aspirated/unaspirated contrast in plosives and nasals might be better described as fortis/lenis (Schooling 1992: 117–119). In Vamale, too, the voiceless nasals and aspirated plosives can be analyzed as fortis counterparts to the voiced nasals and tenuis plosives, which leaves a

5 Phonology

third category of pre-nasalized plosives dating back to Proto-Oceanic (Lynch et al. 2002: 62). As mentioned earlier, the spreading of fortis mentioned for plosives and nasals can also affect liquids, by making them devoiced. Fortis onsets attract stress to their syllables, be they voiceless/pre-aspirated nasals, or aspirated plosives. This fortis/lenis contrast in stress allocation does not extend beyond the nasals and plosives, although all non-prenasalized parts of the consonant phoneme inventory can be analyzed as split along the historical fortis/lenis lines. The fricative /s/, for example, has a historical lenis counterpart in the glide /y/ (see Table 5.5).

Table 5.5: Comparison of Bwato and mountain Voh-Koné reflexes of PNC *k

		Bwato	Hmwaveke	Vamale
POc *k				
PNC *k				
*kulit	‘skin’	ðii	i-	i-
*kuluR	‘breadfruit tree’	ðiŋ		in
*kutu	‘lie (parasite)’	ði	iik	i
*kuRita	‘squid’	ðia	iya	ibwen
*kai ^a	‘tree’	ðee	yee	yee
PNC *kk				
*kuku	‘claw’	θi-	si-	si-
*kau	‘swim’	θoom	soom	soom

^a(Bril 2002: 34)

All aspirated plosives except /t^h/, some borrowings excepted, correlate with subsequent nasal vowels and can thus not be distinguished with minimal pairs from their unaspirated counterparts. This is partly due to historical post-nasals, some of which still exist in Nemi (Ozanne-Rivierre 1982: 19). Origins of postnasals include:

1. Syllabic reduction
2. Nasal infix
3. Onomatopoeia
4. Locative derivation

5. Intervocally (rare): Old compounds (Ozanne-Rivierre 1982: 30):

- *tipme* (*tip-me) ‘go down-DIR.speaker’⁴
- *tikna* (*tik-ŋa) ‘go down-REP’

Of these postnasals, some developed into aspirated plosives through the following processes, described by various authors for Northern languages, most importantly by Ozanne-Rivierre (1982: 28–30). I suggest that this partially explains the development of Vamale [k^h], [c^h], [p^h] and [p^{hw}].

1. Post-nasalized plosives in Proto-North influence following vowels (e.g. *kniik ‘swamp hen’ → *kniik).
2. Post-nasalized plosives in Proto-North become aspirated in Vamale, possibly because the plosives are lengthened (e.g. *k^hnīik). (Campbell 1987: 76)
3. Vowels remain nasalized after the loss of post-nasalization (e.g. *k^hiī).
 - a) Velars being most error-prone concerning velar closure, nasal vowels survive consistently after [k^h], possibly more so than after /k/ because of the aspiration, leaving more time between the velar closure and the vowel.
 - b) Aspirated plosives from the CV.CV→CCV→C^hV sound change can also have phonemic \tilde{V} , as in *tha* ‘Ass’ vs *thâ* ‘excrement’
4. The aspirated velar plosive [k^h] is reanalyzed as tied to nasal vowels.

[k^h] appears before oral vowels only in [k^holɔ:t] ‘red-haired’ and [k^halapa], a variant of [kaɭapa] ‘outrigger canoe’. The latter word is a loan found in most New Caledonian languages, possibly from Polynesian (Hollyman 1959: 364). *Koloot* ‘redhead’ is unaspirated in Pije and Bwato (kolook ‘albino’), and in Vamale, the aspiration is in free variation. Given the hypothesis of Ozanne-Rivierre, a reanalysis of [k^h] as an allophone of /k/ with an extension of [k^h] to all nasalized vowels may have taken place in the past. Hmwaveke has the same phenomenon (Campbell 1987: 13), but not the coastal Voh-Koné languages, where /k^h \tilde{V} / and /k^hV/ both occur. /k^h \tilde{V} / is also common in French. The analysis posited above of allophony (/k/ → [k^h]/#_ \tilde{V}) may have become obsolete now, perhaps under the influence of neighboring languages, since /k/ and /k^h/ are a common phonemic contrast in the area.

⁴Only present in modern Vamale as *tip-wa* ‘fall’ and *te-tip-wa* ‘walk-down-REP?, i.e. unwind’.

5 Phonology

[p^{hw}] nearly always precedes a nasal vowel, e.g. *phwê* ‘moon’, but *fwe* ‘fig tree [guettarda speciosa]’. Exceptions to the correlation with nasal vowels are loanwords, e.g. Pije [p^{hw}a:t] ‘clear, clean’, and [p^{hw}ala:] ‘bread’.⁵

[p^h] also almost only occurs before nasal vowels (e.g. ⟨phâêû⟩ [p^hãẽũ] ‘dry land’ but *fati* ‘language’, *phalik* in Jawe, Haudricourt & Ozanne-Rivierre 1982: 155). Where it precedes oral vowels, the items are (more recent) loans: *phuake* ‘wiggle’, *phom* ‘butterfly’, *phoop* ‘snail’, *photha* ‘sexual taboo’⁶ (Rivierre 1994: 516).

An aspirated palatal plosive /c^h/ was only found in [tɕ^hi] ‘Paicî’, [tɕ^hõ:m] ‘banana stalk’ and [tɕ^hõ:t] ‘product’. In Bwato, /c^h/ is also rare and occurs in the place of Vamale /s/ or /c/. It seems to alternate with the latter (e.g. [tɕ^hop^win] ~ [tɕop^win] ‘bury’, Rivierre & Ehrhardt 2006: 119).

Table 5.6: Distribution of nasal vowels after obstruents

	__ \tilde{V}	__V
p	-	+
p ^h	+	rare
p ^w	-	+
p ^{hw}	+	rare
f	-	+
f ^w	-	+
t	+	+
t ^h	+	+
c	-	+
c ^h	+	-
k	-	+
k ^h	+	rare

Given the distribution of the surviving [p^h] and [p^{hw}], [tɕ^h] and [k^h] summarized in Table 5.6, as well as the historical development of postnasals given above, the aspirated plosives may be former allophones of *p, *p^w, *c and *k. The unaspirated plosives developed into fricatives /v/, /v^w/, /j/ and /ɣ/ sometime during the development of Voh-Koné from Proto-North, and the aspirated plosives preceding oral vowels resulted in the voiceless counterparts of the fricatives mentioned above. In front of nasal vowels, aspirated plosives may have subsisted. Another

⁵From Engl. *flour*, *falawa* in other Caledonian languages.

⁶From Leenhardt’s dictionary who did not transcribe nasalization, not found nowadays Leenhardt.

option is that nasality of vowels remained non-phonemic for a long time, as is the case in Nemi and in all Vamale environments containing a nasal.

5.2.6 Allophones of consonants

Consonants are sometimes realized differently in fast (connected) speech, mostly in ways which simplify the production, e.g. ⟨phw⟩ → [px]. The aspirated plosive [k^h] can be realized as voiceless fricative [x]. This is almost exclusively attested in [xawaxan] ~ [ɣawaxan] ‘dog’ which, etymologically as well as in some people’s speech, is [ɣavwak^hãn], ⟨xa-vwa-khân⟩ ‘NMLZ-make-noise’. In Yuanga, /k/ is realized as [x] intervocalically, according to Schooling (1992: 111). The de-fricativization of /v^w/ to [w] is a sound change also attested for Hmwaveke (Campbell 1987: 120), and is present in most speakers’ speech at least for *vwa* ‘do; EXIST’, though they will insist on /v^w/ when asked. Interestingly, the nasal quality of the vowel in [k^hãn] ‘make noise’ often drops when the aspirated plosive is realized as a fricative [xan], as in *xa-vwa-khân* above. [g] ~ [ɣ] are also interchangeable in fast speech between vowels. [ɣ] does not appear phonemically intervocalically within a morpheme, so all such occurrences are assumed to be lenited /g/. Voiceless nasals and liquids can be voiced in fast speech. Intervocalic voicing of non-fortis consonants is mirrored in Yuanga to some extent, as most unaspirated plosives and fricatives have intervocalic voiced realizations (Schooling 1992: 115).

5.3 Vowels

As shown in Figure 5.1, Vamale features at least seven vowel qualities, like Cèmuhî (Rivierre 1980: 29), and like in Cèmuhî, they do not contrast everywhere. The openness of vowels depends on nasalization,⁷ length, and the syllable’s coda, so that only five qualities are phonemic. Table 5.7 lists minimal pairs for them.

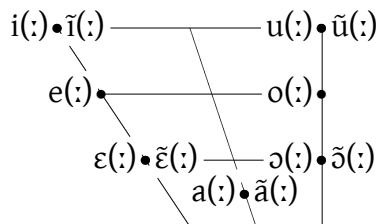

Figure 5.1: Vowel qualities

⁷Half-open and half-closed vowels also collapse in Yuanga (Schooling 1992: 103).

Table 5.7: Minimal pairs for vowels

[t ^h i] ‘shell’	[t ^h i:] ‘pierce’ [wī:] ‘strength’	[tɕuvi] ‘say standing’	[tɕu:vi] ‘string up’
[t ^h e] ‘algae’	[t ^h e:] ‘heavy’	[so] ‘roof pole’	[so:] ‘shoot (bot.)’
[t ^h ɛ̃] ‘limestone’	[t ^h ɛ̃:n] ‘run, fly’	[t ^h ɔ̃a] ‘command’ ^a	
[t ^h a] ‘Ass’	[t ^h a:] ‘tie’		
[t ^h ã] ‘feces’			

^aCompare to /t^ho-a/ ‘call-3SG.OBJ’

Apart from *wîi* ‘strength’ vs alienable *wii* ‘field’, [i] is not attested in minimal pairs, I thus treat it as a marginal vowel phoneme. The status of [û] is even trickier. The nasal closed vowel [û] only appears in complementary distribution to its oral counterparts: after the aspirated consonants *kh*, *phw* etc discussed in §5.2.5, after nasals, and in other nasalizing conditions. There are no long nasal vowels in open syllables at all (except [k^hĩ:], which is still [k^hĩ:k] in closely related Hmwaveke). Whether we analyze /û/ as a phoneme depends on our understanding of [k^h]: If [k^h] is a phoneme, then [û] could be analyzed as an allophone of /u/, conditioned by [k^h]. This description will assume that the distribution of [û] is predictable, but will still transcribe [û] as ⟨û⟩ except after nasals.

5.3.1 Quantity

Vamale features phonemic length in both monosyllabic words, see the examples *thi* ‘shell’ and *thii* ‘pierce’ at the beginning of §5.3 above, and polysyllabic ones.

Consider the following minimal pairs:

- [sa.ṃ^wã] ‘go the other way’ vs [sa:ṃ^wã] ‘banana’
- [fa.ti] ‘language’ vs [fa:ti] ‘glue something’⁸
- [t^ha.ke] ‘throw’ vs [t^ha:ke] ‘drag’

This analysis is contested for Voh-Koné languages: Campbell analyzes long vowels in Hmwaveke polysyllabic words as a feature of the stressed syllable

⁸The latter is morphologically complex: *faat* ‘be sticky’ and *-i* ‘TR’

(Campbell 1987: 56). In cases where a fortis-onset syllable takes the stress despite other factors, like the presence of a long syllable (e.g. [tʰa.ke:ke] ‘stretch out’), or a penultimate syllable (e.g. [ˈxaːn.ja.ke] ‘eat starchy food’), this is argued to be due to extra articulatory energy, but not phonologically stress (Campbell 1987: 59).

In Vamale, however, many polysyllabic words are composed of only short syllables: e.g. *ˈta.na* ‘ripe’, *ˈxa.le.ke* ‘see’, *cu.va.ˈthan.ke* ‘stand apart’, *ˈxa.ba.le* ‘their mat’. Apart from lexical factors, length is conditioned by morphosyntactic factors as well. Possession will lengthen the final vowel of some directly possessed, alienable words:

- [ˈfa.ti] ‘language’ → [fa.ˈti:n] ‘language-3SG.POSS’
- [ˈi:la] ‘cauldron’ → [i.lo:ŋ] ‘my cauldron’
- *fʷa:n.dan* ‘road’ → [fʷan.da.nū:ŋ] ‘my road’

While quantity is phonemic, it is not always realized in everyday speech. Compare *ju* ‘fish kabob’ to *juu* ‘real, sacred; very’. While the first word is only rarely produced nowadays,⁹ the latter is ubiquitous, and often in an unstressed position, or even a compound (see §6.19). Both environments tend to elide stress, and unstressed long syllables are often shortened.

5.3.2 Quality

The mid-open vowels have allophones depending on the syllable structure. Open syllables feature closed vowels. Closed syllables have several variables: closed short syllables feature the more open vowels [ɛ] and [ɔ]. Closed long syllables show both pairs; plosive-final syllables have more open vowels ([sɔ:t] ‘touch’), and nasal-final ones feature comparatively more closed vowels ([sɔ:m] ‘swim’). See Table 5.8 for an illustration. Note that the vowels were rendered here without their nasalization: all vowels preceding nasals are to some degree nasalized, this does not affect with which allophone they are realized.

Possibly because the community is multilingual, there is considerable variation between individuals concerning the expression of nasality. Some nasalize almost all vowels that follow a nasal, which is why Rivierre does not consider nasality of vowels for Bwato, except after oral consonants (2006: 25).

⁹The loanword *brochette* being used to make the analytical *brochette ko-n nyu* ‘kabob with fish’

5 Phonology

Table 5.8: Vowel allophones in their defining contexts (nasalization omitted)

	[o] [ɔ]	[ɛ] [e]
V	[ˈpu:n.dʒo] ‘whale’	[se] ‘one’
V:	[ˈtʃo:lɑm] ‘your part /to eat, to do’	[se:] ‘cry’
VC	[tʃɔp] ‘pass over a ridge’ [ko.'kɔt] ‘common mynah (bird)’ [p ^h ɔm] ‘butterfly’ [xɔŋ] ‘my leg’ [kɔŋ] ‘PROG’	[sɛp] ‘coconut’ [xɛt] ‘warm’ [fe.t ^h ɛm] ‘white spots (skin)’ [bɛŋ] ‘waterfall’ [sɛŋ] ‘poison’
V:N	[mbo:m] ‘shade’ [ɲa.'ko:n] ‘for’ [ko:ŋ] ‘on me’	[ɣe:m] ‘basket’ [xe:n] ‘noise’ [mbe:ŋ] ‘my peer’
V:P	[ɣa.'kɔ:p] ‘wild’ [tɔ:t] ‘grass’, [ɔ:t] ‘rope; vein’	[tɛ:p] ‘flow (liquid)’ [ˈtɛ:t] ‘be lazy’

5.3.3 Vowel sequences

There are no diphthongs; recorded vowel sequences are either disyllabic or contain a glide, see Section 5.3.3. Some variants in fast speech seem to reduce the prominence of a syllable and make it approach an on- or offglide quality: /jo.a.kan/ [ˈnɔ̃ʒõ.kãn] ‘thick’.

5.3.4 Allophones of vowels

Vowel allophony is underdescribed as of yet in Northern languages. Rivierre’s detailed phonological description of Cèmuhi (1980: 32, 35, 40) expands upon Haudricourt’s brief account of the seven phonemic vowels (1968: 373), and considers [ɔ] an allophone of /o/, amongst others. The phonology of the Hienghène languages was studied by Ozanne-Rivierre (1982), but vowel allophones were not mentioned. Yuanga was described in detail by Schooling (1992). There are no phonological descriptions focusing on vowel allophony for Nyelâyû (Ozanne-Rivierre 1998) and Nêlêmwa (Bril 2002).

Table 5.9: Vowel sequences with examples

	Item	Translation
ie	[t ^h i.en]	‘three’
io	[ⁿ ʃi.ɔŋ]	‘my belly’
iu	[pi.uk]	‘star’
ia	[ci.a]	‘he is not there’
ui	[bui.ʃio]	‘type of shell’
ue	[va.tu.e]	‘pick pandanus leaves’
ua	[t ^h u.a]	‘clear bush’
ei	[pej.pa]	‘paper’
eu	[xe.u]	‘burn by neglect’
eo	[ⁿ de.ɔŋ]	‘my spear’
ea	[m ^w e.ap]	‘nest’
oi	[^m b ^w a xo.lɔj]	‘wheel’
oa	[ⁿ ʃo.a.kan]	‘thick’
ai	[t ^h aj]	‘roll up’
ae	[mã.ẽ]	‘fire’
ao	[ha.o]	‘grandfather’
au	[sa.ũn]	‘garment’
uo	*	
oe	*	
ou	*	

5.3.4.1 Nasalization of vowels

Nasal spreading in both directions is described in detail for Hmwaveke (Campbell 1987: 66, 76). Vamale has this, too, and both regressive (e.g. [nĩũ] ‘fish’, (9)) as well as progressive assimilation (e.g. [ãmbu] ‘1DU.EXCL’, see ex. 10) to nasals are so frequent that nasality of vowels is most often not phonemic.

- (9) [fetãmẽ]
fē-ta-me
 take-move.up-DIR.CP
 ‘bring up’

5 Phonology

- (10) [fɛ̃ãmɛ̃]
fe-hân-me
take-move.same.level-DIR.CP
'bring (across the same plain)'

Nasality also spreads from one vowel to another (regressive assimilation), but does not seem to do so across oral consonants, see (9). Spreading of nasality is so prevalent in Hmwaveke that Campbell considers it a word-level feature, and that words with truly phonemic nasal vowels are only those that have, among other factors:

1. no nasal or semi-nasal consonants
2. and a nasal vowel in the stressed syllable (Campbell 1987: 66)

Like nasal vowels, nasalized ones are usually realized more open than their oral counterparts, i.e. /e/ and /o/ are realized as [ɛ̃] and [ɔ̃], respectively.

5.3.4.2 Fronting of /u/

/u/ is frequently, but not always, fronted to [y] or [ɥ] after the front vowel /i/ and its non-syllabic variant [j] (11, 12). When asked to pronounce the word as slowly as possible, some speakers like Jaaun Kalène produced [ʔya:e.ɯ] or something further front, while others, like Elise Oué, would have two syllables [ʔya.ju]. The latter form is likely to be underlying, as the Pije cognate *ka.hyuk* (Haudricourt & Ozanne-Rivierre 1982: 135) suggests that two syllables, with a glide as the second onset, are etymological. While this fronting is not described by Ozanne-Rivierre for Pije, she mentions it for Jawe, as having developed after an intervocalic /v/ was dropped: /xi/ 'blow' (cf. *uvi* in Fwâi and eastern Nemi) (1982: 22).

- (11) [ɲãʔŋ] ~ [ɲãjuŋ]
nyai-ong
child-1SG.POSS
'my child'
- (12) [ʔya:y] ~ [ʔya:jy]
xayu
male
'boy, male'

5.3.4.3 Backing and rounding of /a/

/a/ is often backed and centralized in progressive assimilation to labiovelar approximants, a phenomenon also described for Yuanga (Schooling 1992: 129). This happens most frequently with *vwa* ‘do; exist’, especially where it is part of a compound, e.g. ⟨*vwa wīn*⟩ [wɔ̄ wī:n] ~ [wō wī:n] ‘EXIST strength’ ‘be strong’. This is not found in careful pronunciation, but is a regular allophone in Hmwaveke (Campbell 1987: 16).

5.3.4.4 Interplay between /a/ and *e*= ‘1SG’

Some morphemes ending with /a/ will assimilate to the 1SG subject index *e*= (13). As examples (14) and (15) show, this process can spread over at least one more syllable, though this depends on the speaker.

- (13) (*the bwa han*)
tha=e=bwa hân
 ASS=1SG=IPFV go
 ‘I am leaving’
- (14) (*nyiman cama go vwa*)
nyima-n (ca)ma go=vwa
 want-3SG SUBR 2SG=do
 ‘He wants you to do it.’
- (15) (*nyiman ceme vwa*)
nyima-n cam=e=vwa
 want-3SG SUBR=1SG=do
 ‘He wants me to do it.’

Vamale is the only Voh-Koné language described with this assimilation of /a/ to the first person subject index *e*= . The sequence [ae] appears elsewhere in the language without assimilating (e.g. [ʔa.ṃã.ɛ̃n] ‘tomorrow’); the assimilation is specific to the subject marker. It is also noteworthy that this subject marker only occurs in Vamale within Voh-Koné. While neither Hmwaveke nor Pije (Haudricourt & Ozanne-Rivierre 1982: 246, 247) have subject marker proclitics that differ from the free form, Cèmuhi has a pair /-(wa)eo/ vs. /e/ (Rivierre 1980: 61); Vamale may have borrowed *e*= ‘1SG’ from it. The assimilation, however, is not described for Cèmuhi either.

5.4 Phonotactics/syllable structure

Like its Hienghène and Voh-Koné relatives, Vamale exhibits a (C^(hw))V(VVC) syllable pattern. Pre-nasalized consonants preceded by a vowel (e.g. V#ⁿC, or V.ⁿC) are reanalyzed, and their nasal is assigned to the preceding syllable: /abu/ /am.bu/ ‘1DU.EXCL’. Consonants usually meet at morpheme boundaries, like [wan.ke] ‘change’, /bofwa-n-mwa/ [bo.f^wan.m^wã] ‘door, door-of-house’. The only exception found is the morphologically simple word /x^wat.la/ ‘thunder’, still /x^wa.la.la/ in western varieties.¹⁰

5.5 Reduplication

Reduplication is a common morphological process in many Oceanic languages, but plays a negligible role in Vamale. Historically, most old CVCV reduplications, probably already stripped of their morphological function, developed first into CCV geminates through elision of the first syllable’s vowel, and then into aspirated plosives or voiceless fricatives (see §5.2.5). Since productive derivational processes work with prefixes, the following forms are probably not representative of productive processes.

- *kokoi*, polite negation, loan from Pije (where *koi* is the negation)
- *hahat* ‘nono’, from *hat* ‘strong negation’
- *sisipo*, ‘together’, *nya-sipo-ke* ‘put-together-TR’
- *fwafwa* ‘full of holes’, from *fwa* ‘hole’
- *juuju(u)* ‘truth’, from the root *juu* ‘true’
- *vayavaya* ‘shaky’, from *vaya* ‘move’

5.6 Stress

In Vamale, disyllabic words have penultimate stress, as is typical in Oceanic settings. Trisyllabic, morphologically simple, non-derived nouns take stress on the first syllable, see Table 5.10. These are rare, though loanwords now increase their number.

¹⁰In this case, the second syllable /la/ was likely reduced and the cluster fortised to /l/, before being split into a stop and a glide. Most morphologically simple words have one or two syllables.

Table 5.10: Stress in trisyllabic words

Old words	Loanwords
[a.pu.li] ‘person’	[^m bu.ru.(w)ɛt] ‘wheelbarrow’, from French [bœu.ɛt]
[va.ma.le] ‘vamale’	[^m māŋ.ga.sĩ] ~[maŋ.ga.ʹsĩ/ ‘shop’, from French [magaʹzĩ]
[ⁿ don.dam.ba] ‘flood garbage’	[pu.a.ka] ‘pig’, from Polynesian <i>puaka</i>
[ma.vu.lɛn] ‘flying fox sp.’	[ku.m ^w a.la] ‘sweet potato’, from Polynesian <i>kumala</i>
[ma.t ^h i.la] ‘small bird sp.’	[ⁿ ge.re.nũ] ‘frog’, from French <i>grenouille</i>

Longer words are morphologically complex and have stress on the penultimate stress-bearing unit, which is often a syllable of the root, but not always. While some morphological factors complicate the picture, regular phonological aspects predict most stress positions. A closed syllable will be stressed over an open one, a fortis onset will usually top a tenuis onset, and a long syllable will be stressed above all else. This gives us a hierarchy of factors:

- (16) Long syllable > fortis onset > closed syllable > penultimate syllable

Some monosyllabic morphemes do not count in the stress pattern. One frequent example is the extrametrical suffix *-ke* ‘TR’, whose phonological non-importance makes the third syllable in /f^wan.ʹji.m^wa.ke/ ‘ask something’ the penultimate of the phonological word. Possessive and object-indexing suffixes shift the stress, but not in a simple syllable-counting way, as [^mbwān.ʹɟɛp], [^mbwān.ʹɟɛp.go] ‘hand drum, hand drum-2SG.POSS’ would suggest, i.e. with the stress, all other things being equal, moving to the new penultimate syllable. However, since *bwajep-gavwe* [^mbwān.ʹɟɛp.ga.v^we] ‘hand drum-2PL.POSS’ does not have the stress on the penultimate syllable of the phonological word, [ga], this suggests an analysis of root syllables that is different from that of suffixed morphology. Possessive and object-indexing suffixes count as a single unit in stress assignment, meaning that a two-syllable possessive suffix such as *-gavwe* ‘2PL.POSS’ has the same effect as *-go* ‘2SG.POSS’.

Speech act participant indexes (the proclitics, not the suffixes) are also extrametrical:

5 Phonology

- /'ya.le.ke/ 'to see'
- /le='ya.le-le/ '3PL=see-3PL.OBJ', 'they see them'
- /le=ya.le-'ka.v^we/ 'they see you', also pronounced /le=ya.'le.ka.v^we/

Other syllables attract stress. The nominalizer *xa-* 'AGT.NMLZ' (from *xayu* 'male') always attracts stress (probably due to its etymology, see §9.7.2), but not the nominalizers *hun-* 'manner.NMLZ' nor *ape-* 'place.NMLZ' (from *ape-n* 'trace').

[hun.v^wa] 'way of doing' [a.'pe.ta] 'ladder (place of going.up)'
[hun.'mõ:] 'way of living' [a.pe.'mõ:] 'dwelling'

Semantically bleached function words like /a.'man/ 'thing; object place-holder' are re-analyzed as one foot in compounds:

- [tɕaj.ɲãn] 'know', [tɕaj.'ɲãn.ã.mãn] 'know something'
- [tɕãm.bi] 'smash', [e.tɕãm.'bi.jã.mãn] 'hammer'

The complex word *ape-caihnan-aman-le*, 'NMLZ-know-thing-3PL.POSS' 'their knowledge', is pronounced [a.pe.tɕaj.ɲãn.ã.'mãn.le] by Kaina Fouan, which could be explained by analyzing (*ape-*)*caihnan-aman* '(fact.of-)know-thing' as a compound, *-le* '3PL.POSS' as a suffix, and thus the main stress would fall on the penultimate syllable.

For Hmwaveke, stress is described as being fundamentally penultimate (Campbell 1987: 59), and forms which deviate from this, with few exceptions, are analyzed by Campbell as several phonological words. Campbell analyzes long syllables in plurisyllabic words as resulting from stress (suggesting that, fundamentally, length is a feature of all stressed syllables). For Vamale, though long syllables are stressed, I argue that the relation is reversed: length attracts stress.

In Nêlêmwa, stress is usually on the first syllable of the lexical root *kâ-'yuva* 'how is it? (lit. lying.down-be.thus)' (Bril 2002: 26). This correlation between morphological structure and stress pattern is mirrored in Vamale to a certain extent, in that bound morphemes such as *e-* 'RECP', *-ke* 'TR', and manner prefixes like *mi-* 'do lying down' do not affect the position of the main stress.

6 Word classes

Vamale words can be divided into several groups according to their syntactic behavior: some big, open classes, some small, closed classes, and some with just one member. This chapter will present all of them based on distributional clues. Their names are partly derived from names given to cognate forms in other languages, and in all cases strive to reflect their syntactic function. Verbs, nouns, as well as aspectual markers (here called TAM for “Tense, Aspect, Mood”, presented in §6.11), have dedicated chapters later on. Vamale word classes present some aspects of typological interest. Location relative to nouns (e.g. “on”, “next to”) is expressed by derived nominal forms (see §6.5.2, and not adpositions. There are no adjectives; rather, nominalized verb phrases, or stative verbs. This is discussed in §8.4.6. Numerals are not an own word class either: they are formally verbs (see §9.2.2). Furthermore, as is common in Oceanic languages, verbs and nouns can be derived from each other with little to no morphology and their morphology overlaps in some cases (see §9.2.3 on verbs with nominal morphology).

6.1 What is a word?

Words in Vamale exist on several levels (phonological and grammatical), and in a way similar to the zero derivation which affects the verb-noun distinction, words can be reinterpreted and forged anew. As has already been sketched in §5.6, *g-words*, i.e. words that act as grammatical units, and *p-words*, i.e. units on a prosodic level with one main accent, do not coincide necessarily. One instance of such mismatches are *g-words* that attach to other *g-words* to form a phonological unit (Spencer & Luís 2012: 1), i.e. clitics. Many function words are clitics, e.g. articles. Semantically general *g-words* which are always part of a phrase, but never its head, and which can be stressed (meaning they are also *p-words*), will be called “particles” in this grammar. TAM markers are included in this broad category. The same grammatical element may be a *p-word* in some construction but part of a larger *p-word* in others, e.g. *aman* ‘thing’, and the influence of a word on the stress pattern of its environment can depend on pragmatic factors, such as focus, drawing out a pause to think of something further to add,

etc. Furthermore, the boundary between often-used phrases and compounds, is also a fuzzy one (cf. §6.1.1 for an example). Other examples of fluidity between word status and phrase-status are verb phrases or even complete relative clauses which can function as head of a NP by the use of an article (see §9.7.5 and §14.2.3 respectively), stative verbs whose nominal morphology makes them useful for adjective-like functions (see §9.2.1), and serial verb constructions.

6.1.1 Concerning *vwa*

The verb *vwa* ‘do’ can combine with a number of morphemes to express an action or a state. It can combine with nouns (e.g. *vwa mwa* ‘build a house’) and verbs (*vwa tau* ‘to fish (lit. do hit (the water))’) to form compounds. The compounds that these combinations create are mostly intransitive verbs with often idiosyncratic meanings: *vwa vua* lit. ‘do net’, ‘throw a net’. *Vwa uvu* ‘do yam’, ‘wind yam sprouts around a tutor’, *vwa xhwaeo* ‘do taro’, ‘harvest taro’. Undergoers would be added as oblique arguments with *ko* ‘OBL’, see example (1). Since *vwa* is semantically vague and thus readily used as a filler verb, new compounds are often formed (e.g. *vwa toki* ‘do metal’, ‘make a telephone call’), established compounds can be broken up ad hoc into verb phrases with specific arguments (see example 2) and many remain transparent phrases. With few exceptions, this grammar will thus avoid marking *vwa*-constructions clearly as compounds by connecting *vwa* to its modifier or argument. §9.1 takes a closer look at intransitive verbs.

- (1) *go*_{AGT}=*vwa-vua ko* [*i=vuman nyu*]_{OBL} *nya-xahut*
 2SG=do-net OBL DEF.SG=group fish send-down.there
 ‘You cast-net upon the fish school down there.’
- (2) *go*_{AGT}=*vwa li=xhwaeo_p nya-an*
 2SG=do DEF.PL=taro towards-same.level
 ‘You harvest the taros over there.’

6.1.2 Prosodic words and grammatical words

Vamale’s wealth in different classes of morphemes is mirrored on the phonological level: phonological units overlap or not with syntactic units, and the latter can be derived and re-analyzed relatively easily, compare (3) to (4). Possessive constructions follow a head-first pattern: PSM-POSS PSR. The personal possessive suffixes mirror the construction found with nouns, and are cognate with “indirect” possessive constructions in other languages, where the possessor is expressed as a pronoun, e.g. Pije *thala-n nyan* ‘knife-POSS 3SG’ (Haudricourt &

Ozanne-Rivierre 1982: 248). However, there are some arguments in favor of a suffix analysis:

1. The 1SG form *-eong* and the 3SG form *-ea* are not identical (anymore) with the free pronouns *io* and *ia*.
 2. The syllabification now includes the formerly external possessor markers (i.e. *puakan-ea* [pu.a.'ka.nẽ.ã] ‘pig.POSS-3SG.POSS’)
 3. The stress shift towards the last syllable before the possessive suffix:
[t^ha.la] ‘knife’ → [t^ha.'la.nẽ.ã] ‘knife-3SG.POSS’
- (3) [h̃jĩmãke e'tça:mãn]
hnyimake (eca)=aman
 think.about INDF.SG=thing
 ‘think about something.’
- (4) [i,h̃jĩ.mã'ke.a.mãn]
i=hnyimake-aman
 DEF.SG=think-thing
 ‘the thinking of something’

6.1.3 Affixes and clitics

Vamale morphemes cover much of the spectrum of grammatical wordhood: forms that are units on both syntactic and phonological grounds, some that are either one or the other, and some flexibility depending on the context. This grammar will follow Spencer & Luís (2012) in defining clitics: A clitic is a form of a word which is phonologically attached to another word, its host. Clitics cannot be stressed, there cannot be a pause between them and their host, they have the same functions as g-words, and can attach to various kinds of syntactic units (Spencer & Luís 2012: 1).

1. Verbs, nouns, and adverbs are g-words as well as p-words, because they can move relatively freely and can be stressed.
2. Subject markers and articles are proclitics, tied to a predicate (verbal or nominal), and noun phrase respectively, they cannot be stressed.
3. Aspectual markers are particles because they are phonologically autonomous, but since they are grammatically dependent on predicates, Zúñiga’s term “anti-clitic” may be more precise (Zúñiga 2014).

6.2 The distinction between verbs and nouns

A common problem in Oceanic linguistics concerns the distinction between verbs and nouns, which can be considered blurry. A verb phrase can be nominalized just by putting an article in front of it, after which it functions as an argument. A noun phrase can be used as a predicate, and preceded by aspect and modality markers. As discussed by Creissels et al. (in press: 3), one can distinguish three types of non-verbal predicates: nominal, adjectival, and locative. Vamale has no adjectives, but nominal and locative predicates are well attested. example (5) is an example of a pronominal predicate, (6) shows a predicative locative noun phrase, composed of a prepositional noun *ca* ‘in’ and a common noun, and a nominal predicate is shown in (7).

- (5) *li=bee-m, le=niehni*
 DEF.PL=peer-2SG.POSS 3PL=all.those
 ‘Your friends, they are those over there.’ [X4:14]
- (6) *cahma patron ya tha=a=juu ena a ca i=bureau hihhi*
 TOP boss 3SG ASS=3SG=very DIST 3SG in DEF.SG=office
 ‘The boss however, there he was in his office.’ [KG:515]
- (7) *go=bo i=daahma*
 2SG=IRR DEF.SG=chief
 ‘You would be chief.’

The transitive suffix *-ke* can be found in or at the end of nouns, but only nouns of verbal origin.

- *hnyimake* ‘think, pay attention’, *hnyimake-aman* ‘think something’, *i ape-hnyimake-aman* ‘DEF.SG NMLZ-think-thing’, ‘the thought’
- *vwa-siteke* ‘Sunday, (lit. do-sacred, pray)’
- *e-topweeke-aman* ‘hook, (lit. NMLZ-hang-thing)’

6.2.1 Syntactic criteria

While nouns and verbs share some syntactic slots, and some nouns and verbs may look the same (see §9.2.3), and many of the words surrounding both noun and verb phrases have shared origins, like *ma* ‘SUBR, COM’, *ko* ‘on, OBL’, or *xhwat* ‘a small piece’, ‘a little bit’, there are differences still: nouns cannot take arguments,

they have different modifiers, and if TAM markers are used, they do not mean the same thing. Numerals, for instance, are verbs because they take arguments, e.g. *se-a* ‘the only one, he is one/alone’, *thalo mu mani* ‘the birds are two’, *thien li=ba* ‘the sardines (are) three’. *Nievit* ‘how many’ works the same way: *Nievit sinan xat?* ‘how many sign sun’, ‘what time is it?’.

Within a noun phrase, modifiers are either nominalized verbs that precede the noun, as in (8), possessors, or relative clauses, as in (9). Verbal modifiers are either adverbs or adverbial clauses, or verbs that integrate the verb phrase.

(8) *i=bwaakala a=xhopwen*
 DEF.SG=boat REL=big
 ‘the big boat’

(9) *i=joakan sapwen*
 DEF.SG=thick dress
 ‘the thick dress’

6.2.2 Morphological criteria

Verbs and nouns share some morphology, most notably possessive suffixes. While these suffixes are examined in more detail in §9.2.3 and §9.3.1.2 for verbs, and in §7.2 for nouns, an overview is provided in Table 6.1. Inalienable (I and Ib) and alienable (II) possessive suffixes can thus occur on verbs, either to mark the undergoer-like subject of some stative verbs or the undergoer argument of some active transitive verbs.

Reflexive/reciprocal *e-*, mostly found on verbs, also occurs with nouns in predicate function, as shown in (10–11). This is a relatively rare occurrence and was only attested with a reciprocal meaning.

(10) *lu=e-copain-copine*
 3DU=RECP-boyfriend-girlfriend
 ‘The two are boyfriend and girlfriend.’ [vamale-180809-1:00:15:20]

(11) *calibeen ma le=moo ma li=ehni, e-bee-le*
 sometimes SUBR 3PL=stay COM DEF.PL=DEM.PROX RECP-peer-3PL.POSS
 ‘Sometimes when they stay together with those, they are each other’s cousins.’ [AG1:239]

Some particles and affixes, however, mark the resulting construction as definitely verbal. This includes causative *fa-*, transitive markers *-ke* and *-i*, and manner prefixes (discussed in §9.5.1). For example, *xhaavwa* in (12) has a different stem than *xhavwaleke* in (13), both in vowel quantity and the last syllable *-le*.

Table 6.1: Possessive suffixes, OBJ and -s_p

		I	Ib	II	-s _p	OBJ
SG	1	-ng	-ong	-eong	-ong	-eo
	2	-m	-am	-go	-go	-ko
	3	-n	-an	-ea	-(e)a	-a
DU	1INCL	-ju	-aju	-ju	-gaeu/-gasu	-kaeu
	1EXCL	-bu	-abu	-bu	-gabu	-kabu
	2	-u	-au	-gau	-gau	-kau
	3	-lu	-alu	-lu	-lu	-lu
PL	1INCL	-je	-aje	-je	-gaa	-kaa
	1EXCL	-be	-abe	-be	-abe	-kabe
	2	-vwe	-avwe	-vwe	-gavwe	-kavwe
	3	-le	-ale	-le	-le	-le

(12) *e=xhaavwa*

1SG=wait

‘I’m waiting around.’

(13) *e=xhavwale-ke (aman)*

1SG=wait.for-TR something

‘I’m waiting for something.’

Object markers in general are sure signs of verbhood. §6.5–6.9 below will explore the noun phrase with its members: articles, nouns, demonstrative and personal pronouns (followed by the subject marker proclitics which are historically related), and some case markers.

TAM markers, which, like subject markers, are shared by both predicative nouns as well as verbs, will form the link in this chapter between the two big groups. Verbs will only be sketched here, as they form the most diverse and biggest word class of the language. After introducing adverbs, smaller classes, often with a wider scope, will be introduced.

The suffix *-n* ‘NSPEC, ANA’ warrants an early introduction, as it occurs across word classes, affecting dependent verbs, prepositional nouns and regular inalienable nouns alike. In essence, *-n* has two functions: one is to mark the generic nature of the argument of its verbal host (14), or the generic possessor of its nominal host (15), while the other function is anaphoric or cataphoric. Generic nouns

do not take an article, whereas specific nouns take definite or indefinite articles (see §6.3).

- (14) *ka na naen cipa hmwaka-n habu*
 CNJ DEM NOW NEG be.like-NSPEC long.ago
 ‘But this is today, not like [things were) yesterday.’ [KP:12]
- (15) *kon th=e ra-ta-meebam nyeca-n sohmun*
 then ASS=1SG NMLZ-be.sitting-sleep inside-NSPEC school
 ‘You must know that I kept sleeping on my chair at school.’ [PE1:187]

The suffix *-n* ‘NSPEC, ANA’ is analyzed as one single suffix despite its distribution both on nouns and verbs, as it always marks the head of the phrase and the generic nature of its dependents.

The other function mentioned above is anaphora in the wider sense: relating to something already mentioned (16), mentioned in another clause soon after, or known in general (17). The referent’s specificity is not important in this case.

- (16) *ehni xhwan da, abe=fate gavwe koo-n go*
 PROX little what 1PL.EXCL=share 2PL OBL-ANA then
abe=sate-n, cipa hmai-n, cipa-bu ju-vaa
 1PL.EXCL=be.different-ANA NEG be.many-NSPEC NEG-1DU.EXCL real-too
udu hmwaka-u
 drink like-2DU
 ‘This [wine and beer) is nothing much, we share with you of this, and [as for) us, it’s different, not much, we don’t drink as hard as you do.’ [L2:3]
- (17) *hmwaa-na koo-n!*
 like-DIST on-ANA
 ‘Like that!/Now that’s a proper way of doing it!’

6.2.3 Semantic criteria

As in other Kanak languages (Bril 2002: 89, Rivierre & Ehrhardt 2006: 32), there are few roots exclusively dedicated to one category, and they are mostly nominal roots. Examples include kinship terms, body parts, topographical and meteorological terms, many animals and plants, as well as parts of the house, boats, and tools.

6.3 Articles

Vamale has a fine-tuned system of definiteness, using both definite and indefinite articles for specific reference, and the absence of articles for non-specific (i.e. less transitive) scenarios. This closed word class is called “articles” in this grammar because its members precede nouns and mark them as (in)definite. Vamale makes the wide-spread distinction between singular, dual and plural (see Table 6.2), and what this study considers to be degrees of definiteness rather than specificity (an argument for this analysis follows in §6.3.1). Using a noun phrase without an article makes it non-specific, as seen in (18) and (19).

- (18) *go=han can hnyimake thamo*
 2SG=walk SUBR think woman
 ‘You walk while thinking about a woman.’ [G4:22]
- (19) *go=han can hnyimake i=thamo*
 2SG=walk SUBR think DEF.SG=woman
 ‘You walk while thinking about the woman.’

Table 6.2: Articles in Vamale

	SPEC and DEF	SPEC and INDF
SG	<i>i</i>	<i>(e)ca</i>
DU	<i>mu</i>	<i>muca</i>
PL	<i>li / ni</i>	<i>ca(been)</i>

The article can combine with the stative verb *se* ‘one, same’ and the noun *been* ‘peer’ to mean ‘the/some other’. This is further discussed in §8.4.1.

Vamale speakers can choose between using an article (the noun thus having a specific referent) (see 20), and not using an article (see 21, 22), in which case the noun is generic. In oft-used expressions, the verb forms a compound with the noun.¹

- (20) *e=xaleke i=apuli a=a=xhwi i=puaka*
 1SG=see DEF.SG=man REL=3SG=eat DEF.SG=pig
 ‘I see the man who is biting the pig.’

¹See Ozanne-Rivierre & Rivierre (2004) for a discussion of similar phenomena in other New Caledonian languages.

- (21) *e=xaleke i=apuli a=a=xhwi puaka*
 1SG=see DEF.SG=man REL=3SG=eat pig
 ‘I see the man who is eating pork.’ (not: the/a/some pig)
- (22) *lu=xa-tena apuli*
 3DU=HAB-understand person
 ‘They understand people.’

6.3.1 The question of definiteness

Vamale articles are split, as can be seen in Table 6.2, not only according to their number, but along another axis, definiteness. Consider example (24) from a French-language legend, written by Yvonne Sahilé, and translated by the work-group into Vamale. The example translates ‘il y avait une tribu’ (there was a tribe) using *i* ‘DEF.SG’, making it seem more specific than definite, since the listeners cannot yet be familiar with the tribe. My first suggestion was using an indefinite article *eca* (23), which was refused. Now look at example (24), where the tribe has never been mentioned before, compared to examples (25) and (26), where it has. All sentences use the same article. In (26), *li thamo* ‘the women’ are newly introduced to the narrative but marked with the definite *li*.

- (23) **Habu can vije vwa eca=ape-moo a= pwan jalan*
 long.ago in Tipije EXIST INDF.SG=LOC.NMLZ-stay REL= on side
ehni i=jahoot-ca a= xhopwen.
 DEM.PROX DEF.SG=river-PROX REL= big
 [1, authors’s attempt]
- (24) *Habu Can-Vije vwa i=apemoo a= pwa-n jela i=jahoot*
 long.ago Tipije exist DEF.SG=tribe REL= on-NSPEC side DEF.SG=river
a= xhopwen.
 REL= big
 ‘Long ago in the Tipije valley, there was a tribe on the bank of this great river.’ (following the French original text) [1]
- (25) *Ca i=apemoo-ca le=vacuti ca daahma a= bwa xawe, ka*
 in DEF.SG=tribe-PROX 3PL=erect some chief REL= IPFV young and
yata-n Thêa Xa-vila
 name-3SG.POSS T. NMLZ-dance
 ‘In this tribe they erected a chief who was still young, and his name was Firstborn the Dancer.’ (Thêa is a name commonly given to the firstborn son) [2]

6 Word classes

- (26) *Ca i=apemoo vwa li=xawe thamo*
 in DEF.SG=tribe EXIST DEF.PL=young woman
 ‘In the tribe were young women.’ (indefinite, non-specific in the French original) [3]

This description analyzes *i* ‘DEF.SG’ and *li* ‘DEF.PL’ as definite articles, using Lyons (1999)’s definition. Noun phrases marked with *i* and *li* are identifiable (Lyons 1999: 1), albeit not necessarily familiar (Lyons 1999: 3), see (25) and (26). Familiarity, to Lyons, is not an necessary feature for a construction to be definite (Lyons 1999: 5). As Lyons discusses in the pages following that statement, the uniqueness of a referent, in total or relative to the context (Lyons 1999: 8), or even “the totality of the objects [...] in the context which satisfy the description” (Lyons 1999: 11), can all be grounds for definiteness.

Example (27) describes a woman not previously mentioned, *eca thamo a en maa-n* ‘she who has a beautiful face’: indefinite but specific. Example (28) describes a similar situation: In-Thu is a unique, identifiable character, not previously introduced. However, the relative clause modifying her is defining, and so preceded by *i*, whereas the one in (27) is not, and its modified noun takes *eca*. Example (25) seems to use *ca* in an indefinite way, too, introducing a character who is then further specified and named.

- (27) *tha fe nyamaa-n ca-n dawee-le eca thamo a=*
 ASS.3SG take eye-3SG.POSS in-NSPEC between-3PL.POSS **some** woman REL=
en maa-n. ka a=xhani ma mwada-n. Yata-n
 first face-3SG.POSS and 3SG=choose SUBR wife-3SG.POSS name-3SG.POSS
In Fwe
 skin guettarda.speciosa
 ‘Some woman among them ‘caught his eye’, who was the most beautiful.
 And he chose her as his wife. Her name was Figtree Bark.’ [GC:4-6]

- (28) (Note the *i a yatan* construction, ‘the who name-her’)
le=kiica ka meeka li=been thamo, ma ca-n
 3PL=jealous and all DEF.PL=other woman COM in-INDF
e-dawee-le i=a= yata-n In Thu.
 MID-between-3PL DEF.SG=REL= name-3SG.POSS skin banyan
 ‘All the other women were jealous, with among them all the one who was
 called Banyan Bark.’ [GC:7]

Vamale distinguishes specific from generic participants using articles (except for pronouns and proper names). The articles mark number and definiteness, and,

through their presence, specificity. The criteria for definite noun phrases include identifiability and uniqueness, as shown in (27), where a woman is introduced as one of many, compared to the obligatorily definite introduction of the unique village in (24).

6.3.2 The articles *ca* and *eca* ‘some’

The article *eca* cannot co-occur with any of the definite articles *i*, *mu*, *li*, nor with a demonstrative pronoun in the same phrase.² Table 6.4 also suggests that *ca*-forms are used as articles, with *la* cognates in Hienghène-linkage languages.

- (29) *eca-aman*
 some-thing
 ‘something’
- (30) *eca-se*
 some-one/other
 ‘someone’
- (31) (Vamale Usa)
eca-ve(n) xada
 some-where up.there
 ‘somewhere up there’

While *eca* is used in compounds with singular meaning (29), the distinction between singular and plural indefinite articles is becoming blurry. *Ca* ‘INDF.PL’ is distinguished by older speakers from *eca* ‘INDF.SG’, but not anymore by many younger speakers, where the two forms are in relatively free variation. The extent to which this distinction is still important is illustrated in the examples (32). According to Jeo Kalène (40 years old),³ *eca* is the singular and *ca* the plural indefinite article (32).

- (32) *tha vwa eca=apuli a= a=vwa hmwaena*
 ASS EXIST some.SG=person REL= 3SG=do thus.DIST
 ‘There is a person who does it like this.’

²The adverb *eca-ve* ‘some-where’ probably combines the stative verb *ve* ‘where? (immobile)’ with the article, as does *eca-se* ‘some-one’ (29).

³Recorded on 12.11.2018, see the archive.

6 Word classes

- (33) (*ca* and *a* ‘3SG’ cannot refer to the same participant)

**tha vwa ca=apuli a= a=vwa hmwaena*
 ASS EXIST some.PL=man REL= 3SG=do thus.DIST
 (for: ‘There is a man who does thus.’)

- (34) (*eca* and *le* cannot refer to the same participant.)

**tha vwa eca=apuli a= le=vwa hmwaena*
 ASS EXIST some.SG=man REL= 3PL=do thus.DIST
 (for: ‘There is a/some man who does thus.’)

- (35) *tha vwa ca=apuli a= le=vwa hmwaena*

ASS EXIST some.PL=man REL= 3PL=do thus.DIST
 ‘There are people who do it like this.’

- (36) *e=xaje ca=been*

1SG=eat.juicy INDF.PL=peer

‘I ate some of them.’ [vamale-181127-jp_nelemwa-1: 00:05:02]

Cabeen, probably from *ca been* ‘some others, some of them’, see (36), is for 25-year-old Jean-Philippe Oué the unambiguous plural form of *eca*, whereas *ca* is a free variant of *eca*, but can also be used for the plural. A similar confusion is found in the examples below, which stem from the translated legend (the translators were all around 40–50 years old). The article in (37) could refer to plural or singular entities, but in (38) would more refer signify a single place.

- (37) *ma cika vuki-n ma a=xaahni ca=aman ma*
 SUBR NEG.EXIST reason-POSS SUBR 3SG=look.for INDF.PL=thing SUBR
a=vwa tââ-n
 3SG=make oven-3SG.POSS

‘So that there was no reason for her to seek something to make her oven (with) (i.e. cook).’

- (38) *i=bwaabwen-an a=ja han fwadai ca_i= [ma a=vwa*
 DEF.SG=morning-POSS 3SG=PRF go search.INAN some= SUBR 3SG=do
nyangan-aman la_i]
 garden-something be.here

‘The next day (lit. its morning) she finally went to look for some place to make her field.’

Since number is not marked on nouns, both (37) above and (39) below may actually denote non-singular rather than plural, since both refer to non-singular, possibly uncountable referents.

- (39) *fe ca=xhua-m*
 take ART.INDF.PL=food-2PL.POSS
 ‘Take some food (lit. Take some of your foodstuff).’

6.3.3 Variation: *li* vs *ni*

- (40) *ma le=tha-vwa ni ape-mae*
 SUBR 3PL=strongly-do ni LOC.NMLZ-fire
 ‘And they start fires/make the fire places (not like before, they light too many fires now).’ [0:01:29 of vamale-171129-ecology (Usa)]

6.3.4 Other, related languages

Articles are a widespread feature of Oceanic languages (Lynch et al. 2002: 38). They are also common in Mainland New Caledonian languages, with the exception of Far Northern Nêlêmwa, which uses different verbal suffixes to distinguish specific from non-specific objects, and possibly Nyelâyu, where abbreviated demonstratives can act as articles (Ozanne-Rivierre 1998: 43). All Northern languages use articles, from Jawe (Haudricourt & Ozanne-Rivierre 1982: 255) to Paicî (Rivierre 1983: 177). Interestingly, though language contact and multilingualism were common and encouraged until at least the early 20th century, article systems are not identical. Cèmuhi, for example, distinguishes nouns along personified/neutral and female/non-female axes (Rivierre 1980: 144). The Hienghène systems distinguish definite, definite specific, and indefinite, where Vamale only has a definite/indefinite distinction (see Table 6.3). Bwato is described to have two plurals (but only one dual): an unmarked one, and a “restricted” one, which is used for groups of known or cohesive elements (Rivierre & Ehrhardt 2006: 42), a feature which was not found in Vamale.

The more archaic Vamale variety Usa kept *v-* in its articles, which is found in Pwaamei, Pije as well, and was dropped in Vamale (see Table 6.4). *Muu-hni* ‘DU-PROX, those two’ is frequent, and *mu-ca* ‘DU-INDF’ accepted, following the Pwaamei logic of *vaabu/vaabu-ca* (see Table 6.6). A combination of dual article and demonstrative suffix (in this case, a proximate visible one) is thus possible, and results in a demonstrative pronoun.

The definite articles *i* and *li* can derive relative clauses to nouns (41).

6 Word classes

Table 6.3: The article system in 1970 Hienghène languages (Haudricourt & Ozanne-Rivierre 1982: 255)

Singular			
	DEF	DEF SP	INDF
Pije	<i>vin^a</i>	<i>vi</i>	<i>va</i>
Fwâi	<i>ven</i>	<i>veli</i>	<i>vera</i>
Nemi 1	<i>vin</i>	<i>vi</i>	<i>va</i>
Nemi 2	<i>ven</i>	<i>vi/veli</i>	<i>vera/va</i>
Jawe	<i>nei</i>	<i>di(i)</i>	<i>ya</i>
Dual			
	DEF	DEF SP	INDF
Pije		<i>maali</i>	<i>maala</i>
Fwâi	<i>maan</i>	<i>maali</i>	<i>maara</i>
Nemi 1	<i>maan</i>	<i>maali</i>	<i>maara</i>
Nemi 2	<i>maan</i>	<i>maali</i>	<i>maara</i>
Jawe		<i>deuli</i>	<i>deulixen</i>
Plural			
	DEF	DEF SP	INDF
Pije	<i>ni</i>	<i>li</i>	<i>la</i>
Fwâi	<i>ngen</i>	<i>ngeli/li</i>	<i>ngera</i>
Nemi 1	<i>ni</i>	<i>li</i>	<i>ra</i>
Nemi 2	<i>ngen</i>	<i>ngeli</i>	<i>(nge)ra</i>
Jawe		<i>deeli</i>	<i>deelixen/yaxen</i>

^aThis may be a complex form, with *-n* 'NSPEC'.

Table 6.4: Pwaamei Hnaakâ (1a) / Pwaamei Yaak (1b) / Pwapwâ (2) / Bwato (3) / Usa (4) articles in: (Ozanne-Rivierre n.d.: 94,95) (1–2) and (Rivierre & Ehrhardt 2006: 42) (3), fieldwork 2017 (4).

		DEF			
	1a	1b	2	3	4
SG	<i>ve</i>	<i>vi</i>	<i>de</i>	<i>a / (a)ni</i>	<i>vi(n)</i>
DU	<i>vaabu</i>	<i>vaabu</i>	<i>duuli</i>	?	<i>mu</i>
PL	<i>ni/i</i>	<i>ni/i</i>	<i>i/dili</i>	<i>(le)ni</i>	<i>ni (li)</i>
		INDF			
	1a	1b	2	3	4
SG	<i>veca</i>	<i>vica</i>	<i>deca</i>	?	<i>veca</i>
DU	<i>vaabuca</i>	<i>vaabuca</i>	<i>duulica</i>	?	?
PL	<i>ca</i>	<i>ca</i>	<i>ca</i>	?	?

Table 6.5: Bwato articles

SG	<i>a</i>	<i>(a)ni</i>
DU	<i>(a)lu</i>	<i>luni</i>
restricted PL	<i>(a)le</i>	<i>leni</i>
PL	<i>ni</i>	

Table 6.6: Pwaamei/Pwapwâ articles in Ozanne-Rivierre (n.d.)

		DEF			INDF		
	Pwm Hnaakâ	Yaak	Pwapwâ	Pwm Hnaakâ	Yaak	Pwapwâ	
SG	<i>ve</i>	<i>vi</i>	<i>de</i>	<i>veca</i>	<i>vica</i>	<i>deca</i>	
DU	<i>vaabu</i>	<i>vaabu</i>	<i>duuli</i>	<i>vaabuca</i>	<i>vaabuca</i>	<i>duulica</i>	
PL	<i>ni/i</i>	<i>ni/i</i>	<i>i/dili</i>	<i>ca</i>	<i>ca</i>	<i>ca</i>	

- (41) *le=vwa ma le=thabilo li=a= le=fee-ko*
 3PL=do SUBR 3PL=strike DEF.PL=REL= 3PL=take-2SG.OBJ
 ‘They want to kill those who took you.’ [B1:8]
- (42) *na i=a= vwa wîi-n*
 DEM DEF.SG=REL= EXIST strength-3SG.POSS
 ‘That’s the strong one (among them).’ [JV:11]

6.4 Demonstratives

Demonstrative pronouns have nominal status in the sense that they function syntactically as nouns including case marking, except that they cannot take articles. Vamale demonstratives distinguish proximal and distal (see Table 6.7), making the system somewhat simpler than the regional three-way average (Lynch et al. 2002: 38). They are a closed class of six forms, whose members are only partially transparent. All forms contain a distal or proximal suffix, and the dual forms still carry as a stem the dual article *mu*. The plural forms’ stem *ni* is identical to the plural article in Usa Vamale and other Voh-Koné varieties (Rivierre & Ehrhardt 2006: 42) discussed in §6.3.3, and is accepted by most speakers of Vamale as well. The segment *e-* in the singular forms may derive from the singular article *i* and the plural forms could be composed of plural article *ni* and the singular, already lexicalised form. Demonstrative pronouns can serve both as topic and comment, as in (43).

Table 6.7: Demonstrative pronouns

	Proximal	Distal
SG	<i>e-hni</i>	<i>e-na</i>
DU	<i>muu-hni</i>	<i>muu-na</i>
PL	<i>ni-e-hni</i>	<i>ni-e-na</i>

- (43) *cahma ehni a=mu tua tua i=aman*
 TOP DEM.PROX 3SG=FREQ unwrap unwrap DEF.SG=thing
 ‘But him, he was unwrapping, unwrapping the thing.’ [GS:76]

- (44) *li=thôa koon, li=e=paa vii ehni a=*
 DEF.SG=custom.object OBL-NSPEC DEF.PL=1SG=PRF say DEM.PROX REL=
kon mo cahni
 PROG stay here
 ‘The ceremonial objects I mentioned are these, which are lying here.’
 [ET:1]

The demonstrative pronoun *na* is special, because it can be used as a presentative (“this is Liline”), and to mark the comment of an equational clause (45, 46). Since *hni* does not exist (anymore), *na* is neither proximal nor distal, and functions as a more neutral pronoun.

- (45) *[na]_{NP} [vaang [hapi [[na]_{NP}] [Lilin]_{NP} a [[na=mwa]_{NP} [Liiz]_{NP}]_{clause} a]_{SUBR.clause}]*
 DEM unknown COMP DEM L. or DEM=REP
 L. or
 ‘It’s unclear if it was Liline or if it was Lise or...’ [KG:472.1]

- (46) *Jacob tha juu xa-vee ma hmwaana. na hmwaana, go=xaleke?*
 J. ASS real NMLZ.AGT-fuck SUBR thus DEM thus 2SG=see
 ‘Jacob, it’s bad for him if it’s like this. That’s how it is, you see?’ [KL:122.1]

6.5 Nouns

Vamale nouns are defined in this grammar as syntactic units which can bear articles. Few other properties distinguish nouns from verbs, but nouns can be arguments to verbs, most of them can be possessed (though possessive morphology shows overlaps with some verbal morphology, see §9.2), and though they do take some TAM marking, not all TAM marking is attested for nouns (examples include *bwa balan* ‘IPFV CONT’, *ja* ‘PRF’). Nouns are an open class and are described in detail in Chapter 7. Two noun classes are closed, however: classifiers and relational nouns.

6.5.1 Classifiers

Vamale possesses several types of classifiers, most prominently two types of relational classifiers, one type for food and drink items (*xhua*- ‘protein food’, *ya*- ‘starchy food’, *udoo*- ‘cold drink’, etc.), and one more type for parts of plants. Their occurrence is semantically specified. This class is described in more detail

in §7.3. The descendant of the general possessive classifier POc *na has become a construct suffix *-n* marking alienably possessible nouns. Another morpheme, *ka*, marks alienable, semantically vaguely “dynamic” relations (see §7.3.2). Similar morphemes are called general classifiers by several authors (Lichtenberk 2009, 1985, Lynch 2000). However, because *ka* is syntactically different from typical classifiers (it is not the head of its phrase, it has no clear semantics and it is optional in many cases), I simply call it a linker here (following e.g. Brill 2012): a morpheme part of the head noun’s noun phrase, introducing a modifier noun phrase.

6.5.2 Relational nouns

Relational nouns are the functional equivalent of spatial prepositions in Vamale, meaning they are the head of a phrase. Their modifier/possessor is the location in which the noun phrase or verb phrase’s referent is located (47). The members of this closed class are possessed (mostly inalienably) and cannot take an article. They are included with nouns because of their historical relationship to nouns and their possessive morphology. The members are listed in Table 6.8. They are inalienably possessed, except for *cai-n* ‘behind an animate entity’.

Table 6.8: Relational nouns

<i>xala-n</i>	‘under’
<i>cela-n</i>	‘next to’
<i>pwa-n</i>	‘on top of’
<i>pwan bwa-n</i>	‘on (top of)’
<i>cakebwa-n</i>	‘on the other side’
<i>(can) dawee-n</i>	‘(in-) between’
<i>ca-n</i>	‘in, at’
<i>can hawâ-n</i>	‘facing’
<i>ko-n</i>	‘on’
<i>pathabua-n</i>	‘before (spatial and temporal)’
<i>cai-n</i>	‘behind an animate entity’

Some of the relational nouns are derived from nouns using a devoicing of the first consonant, e.g. *bwa-n* ‘head, top’ → *pwa-n* ‘on top’, *jela-n* ‘side’ → *cela-n* ‘next to’. This phenomenon is also described for Cêmuhi (Rivierre 1980: 37). Inalienably possessed relational nouns like *xala-n* ‘under’ all lose their final *-n* if followed by a specific argument (48).

- (47) *a=xheela-ta pwa-n ye*
 3SG=crawl-go.up on-INDF tree
 ‘He tree-climbs.’
- (48) *a=xheela-ta pwa i=ye*
 3SG=crawl-go.up on DEF.SG=tree
 ‘He climbs the tree/a tree.’

6.6 Independent personal pronouns

Table 6.9: S – free form

	1 (EXCL)	1+ (INCL)	2	3
SG	<i>yo</i>		<i>go</i>	<i>ya</i>
DU	<i>abu</i>	<i>gasu</i>	<i>gau</i>	<i>lu</i>
PL	<i>abe</i>	<i>gase</i>	<i>gavwe</i>	<i>le</i>

Vamale uses the eleven pronominal forms listed in Table 6.9, distinguishing singular, dual, and plural, as well as inclusive and exclusive first persons. The forms are independent pronouns in the sense that they can take up the same slot as a nominal phrase. The difference to subject marker clitics is that the pronouns cannot co-occur with another noun phrase that has the same syntactic function. Subject index clitics are always present (except in imperatives, or in stative verbs with inanimate subjects). This means that, at least following the Uniqueness Condition asking for each grammatical relation to be assigned only once within its clause (after Kroeger 2004: 19), subject indexing clitics (or “bound pronouns”) and free personal pronouns are not allomorphs. Compare to Table 6.10. Pronouns can take subject markers (see example 49), but not articles.

- (49) *e=vii ka yo*
 1SG=say SBJ 1SG
 ‘I say.’

6.7 Subject-indexing bound pronouns

As mentioned in §6.6, Vamale uses proclitics derived from free pronominal forms, in order to index subject NPs on active verbs (see Table 6.10). Note that stative

verbs mark the intransitive subject much like alienable possessums do (compare Table 6.11). The clitics occur before active verbal, or nominal predicates, in the slot left of the TAM markers. The pair *yo ~e=* ‘1SG’ is the same in Cèmuhî (Rivierre 1980: 61), but not in other Voh-Koné languages. The other markers are transparently Voh-Koné, and almost identical with the western varieties: ⟨zha⟩ [ða] ~⟨a⟩ [a] ‘3SG’ is described for Bwato as well (Rivierre & Ehrhardt 2006: 31). The sound correspondence [ð] ~[j] is a regular one between coastal and mountain varieties. Note that while the bound pronouns are mostly very similar to the free pronouns, they can co-occur in the same clause (50), which is a sign that they do not have the same syntactic role: the free forms are true pronouns, whereas the bound pronouns have become grammaticalized to subject indexes on predicates.

Table 6.10: Subject and object markers for active and stative verbs

	Free form	A=/S _A =	-S _P	-P
1SG	<i>io</i>	<i>e</i>	<i>-o(ng)</i>	<i>-o</i>
1DU.INCL	<i>gasu</i>	<i>gasu</i>	<i>-gasu</i>	<i>-kaeu</i>
1PL.INCL	<i>gaa/gase</i>	<i>ga(se)</i>	<i>gaa</i>	<i>-kaa</i>
1DU.EXCL	<i>abu</i>	<i>abu</i>	<i>-abu</i>	<i>-(a)bu</i>
1PL.EXCL	<i>abe</i>	<i>abe</i>	<i>-abe</i>	<i>-(a)be</i>
2SG	<i>go</i>	<i>go</i>	<i>-go</i>	<i>-ko</i>
2DU	<i>gau</i>	<i>gau</i>	<i>-gau</i>	<i>-kau</i>
2PL	<i>gavwe</i>	<i>gavwe</i>	<i>-gavwe</i>	<i>-kavwe</i>
3SG	<i>ia</i>	<i>a</i>	<i>-(e)a</i>	<i>-(e)a</i>
3DU	<i>lu</i>	<i>lu</i>	<i>-lu</i>	<i>-lu</i>
3PL	<i>le</i>	<i>le</i>	<i>-le</i>	<i>-le</i>

- (50) *e=xale-le ka yo*
 1SG=see-3PL.OBJ SBJ 1SG
 ‘I see them.’

6.8 Prepositions

Prepositions are derived from inalienable nominal forms (but do not take articles) and, similarly to relational nouns (see §6.5.2), they can have generic or specific markers. There are only four prepositions: *ko* ‘lit. on’ ‘OBL’, *si* ‘for (human)’ (illustrated in 52), *nya-si* ‘lit. put/place-hand’ ‘for (human)’ (see 51), *nya-ko* ‘lit.

Table 6.11: Possessive suffix paradigms

		inalienable I	inalienable Ib	alienable II
SG	1	-ng	-ong	-eong
	2	-m	-am	-go
	3	-n	-an	-ea
DU	1INCL	-ju	-aju	-gaeu
	1EXCL	-bu	-abu	-abu
	2	-u	-au	-gau
	3	-lu	-alu	-lu
PL	1INCL	-je	-aje	-gaa
	1EXCL	-be	-abe	-abe
	2	-vwe	-avwe	-gavwe
	3	-le	-ale	-le

put/place-on', 'for (all)'. Forms with *ko* are lengthened when generic or anaphoric (i.e. *koo-n*), and not followed by a NP. Since the markers cannot be modified, lack lexical content, and attach to noun phrases, I call them particles. A more detailed description is found in §8.1.2.2.

- (51) *tha lu=mata nyasi i=jamwa-n sohmu-n*
 ASS 3DU=sing for DEF.SG=father-POSS study-NSPEC
 'They sing for the teacher.'

- (52) *a=nya balan-o si li=thamo ka*
 3SG=put piece.of.length-bamboo BEN DEF.PL=woman SBJ
i=xa-vwa-o
 DEF.SG=AGT.NMLZ-do-bamboo
 'The bamboo cutter hands bamboo poles to the women.'

6.9 Subject marker *ka*

The subject marker *ka* marks the subject noun phrase (53). On the grounds that it is part of the noun phrase, but does not attach to any specific word class, that it is phonologically part of its host structure, and that it can itself not be modified or fronted, it is a proclitic. Obligatory for A arguments and optional for S (this

is probably a more recent development), *ka* can also be used to mark a focused possessor, though this is rare. A *ka* marked noun phrase cannot be fronted. This distinguishes *ka* from OBL markers and phrase heads *ko* ‘at, to’, *nyako* ‘at, to, for’, and *nyasi* ‘for’, which are hence considered both p- and g-words, whereas *ka* is not only dependent on a noun phrase, but also on the latter’s unmarked post-predicate position. See §8.1.1 for a detailed description.

- (53) *go=thêên ka=go*
 2SG=run SBJ=2SG
 ‘You run.’

6.10 Relativizer

The relativizer *a* introduces a relative clause subordinated to a noun phrase (54). It is sometimes left out. It is probably related to *a* ‘3SG’.⁴ Relative clauses can be derived to nouns by an article (55).

- (54) *e=thapi i=iila a= a=vwa*
 1SG=break DEF.SG=pot REL= 3SG=do
 ‘I break the pot that he made.’ [G2:37]

- (55) *li=a= le=vwa-sukin*
 DEF.PL=REL= 3PL=do-price
 ‘Those who shop.’ [AG1:81]

As the relativizer and the third person singular are both *a*, they usually merge (56).

- (56) *exaleke iapuli axhwi-puaka* (from the dictionary)
e=xaleke i=apuli a=a=xhwi puaka
 1SG=see DEF.SG=man REL=3SG=eat pig
 ‘I see the man who is eating pork.’

6.11 TAM markers

Vamale has around a dozen morphemes used to situate an event relative to its temporal context (aspect), to the speaker moment (tense), and to reality in general (mood). Most of them are aspectual markers. Although Vamale traditionally

⁴The relativizers in Cèmuhî are related to the plural article *li* and proximal *naa* (Rivierre 1980: 92). The relativizer in Bwato is the same as in Vamale (Rivierre & Ehrhardt 2006: 473, 486).

does not seem to have expressed tense, this is nowadays done with *bwa* ‘IPFV’ and *(b)o* ‘IRR’ for future tense. Most of the morphemes listed here and described in Chapter 12 are used for several functions, and this is the case for all mood functions (e.g. *balan* ‘CONT’ and *bo* ‘IRR’, but also *ja* ‘finally’). Syntactically speaking, all of the TAM markers proper are particles: though they directly precede the predicate (and follow the subject index proclitics), and though most cannot be fronted, they can be stressed. They can combine with other TAM markers to form either transparent or idiosyncratic new meanings (57). Their meaning depends on the word class of the predicate’s head and the aktionsart of the verb.

- (57) *e=bwa kon vii*
 1SG=IPFV PROG say
 ‘I am still saying.’

Their basic members are *bwa(n)* ‘IPFV’, *pa* ‘PRF’, *ja* ‘PRF’, *(b)o* ‘IRR, FUT’, *balan* ‘CONT’, and *mu* ‘FREQ, ITER’. Some combinations are very common, but will be discussed in detail in §12. *Xa-* ‘HAB (most likely from NMLZ.AGT)’, as a prefix, is only semantically related to them.

The phasal negator *ban* ‘not yet’ is a TAM marker as it takes a slot between the subject marker and the verb (58). It only occurs after the negator *cipa*. *Ban* may be related to *bwa* ‘IPFV’, which in negated verb phrases has the allomorph *bwan*. A reviewer suggested to analyze it as an incomplete aspect marker. This would simplify the analysis, but the term is more often used to describe actions which have begun but not been completed (Overall 2017), which is not the case here.

- (58) *cipa go=ban han xaleke*
 NEG 2SG=not.yet go see
 ‘You never went to see.’ [G4 16, 17]

6.12 Verbs

Verbs are by far the biggest word class and so diverse that a more in-depth description is provided in Chapter 9. There are active verbs and stative, the latter often describing more state-like, or patientive events. In Vamale, verbs distinguish themselves from other word classes by their participant indexes, which are proclitics for active verbs and suffixes for stative. While the proclitics will also attach to nominal predicates, they are optional for nouns, whereas verbs require them in non-imperative settings. Contrary to nouns, verbs cannot take articles. Verbs

take derivational morphemes like causative *fa-*, reflexive *e-*, and attenuative *the-*. The animacy of participants influences whether participants are indexed on the verb; inanimate referents do not trigger stative subject suffixes (62) nor object suffixes. Participant indexing on verbs thus displays split-intransitive alignment: active verbs index transitive and intransitive subjects identically while distinguishing objects (59, 60). Stative verbs do not index their invariably intransitive subject like active verbs do (61), nor do their suffixes overlap with undergoer marking on transitive verbs (59). An illustration is given in Figure 6.1.

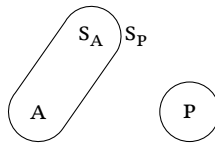

Figure 6.1: Verbal alignment

- (59) *e=xhwii-ko*
1SG=bite-2SG.OBJ
'I bite you.'
- (60) *e=thana*
1SG=wander
'I wander around.'
- (61) *sinu-go*
suffer-2SG
'You are ill, you suffer.'
- (62) *sinu (i=xh-ong)*
suffer (DEF.SG=leg-1SG.POSS)
'(My leg) hurts.'

The main types of verbs are the following.

1. *active transitive*: The subject marker precedes the verb (except in the imperative), and the verb takes an argument (see §9.3.1); *e=xale-ke/ko* 'I see it/you'.
2. *active intransitive*: The subject marker precedes the verb, the verb does not take an argument. *E=moo* 'I stay', *a=yajen* 'it shakes, trembles', *a=temineen* 'it floats'. The productive transitive suffix *-ke* and the older *-i* can often be added to derive a transitive form (see §9.3.1.1).

3. *stative*: stative verbs are directly followed by their subject marker. The latter are bound to the verb stem and cannot choose their host, which is why I analyze them as suffixes rather than clitics; *me-o* ‘I die’. While the proclitic subject markers of active verbs are obligatory for all subjects, the stative subject markers are only obligatory for human arguments. They are almost, but not completely, identical to the object markers found on transitive active verbs with animate objects that are not expressed as noun phrases (see Table 6.10). Stative verbs cover a few semantically defined, closed groups of words.

- numerals (*see-a* ‘be.one-3SG’, *thalo-lu* ‘be.two-3DU’, *thien-le* ‘be.three-3SG’)
- semantically “patientive” verbs like *sinu-ong* ‘suffer-1SG’ ‘I am sick/ I suffer’, *xhwiiti-o koo-n* ‘long.after-1SG OBL-3SG’ ‘I miss it’
- *heeve-o/-go/-a* ‘where-1SG/-2SG/-3SG’ ‘where am I/are you/is s/he’
- verbs with “adjectival meanings” like *vun-go* ‘blue/green-2SG’ ‘you are blue/green’, *xhopwe-* ‘(be) grow(n)’, *mapehno-le* ‘they are few’

4. There is also a group of verbs that cannot occur alone. They are not transitive, nor can they take subject markers, and they occur before or after another, independent, verb. These bound roots (called roots because they take no morphology on their own) are further described in §10.3.2.2.

6.13 Adverbs

Vamale possesses a small class of adverbs. They occur at the end of a clause or phrase, are frequently fronted without a phrase (63), take neither articles nor any kind of possessive or inflectional morphology, and are, if at all, modified by the intensifiers described in §6.19, *juu* ‘real, really, very’. As they modify verb, noun, and prepositional phrases, and as they can be fronted alone, this analysis considers them to be adjuncts. Most members are transparently derived from nouns or prepositional phrases. See §10.4 for examples of their interaction with verb and noun phrases. Example (63) features two cases of fronted adverbs, (64) shows an adverb at the end of a verb phrase, and (65) shows an adverb after noun phrase.

- (63) (Adverbs are in bold, brackets show phrases, the comma separates two clauses)

ka [*jethro*] ***canbwen*** *man* ***bwethalo*** [*le=cuut cahni ka*
 CNJ J. yesterday COM two.days.ago 3PL=stand here SBJ
ni=bee-m-ca], ***cahni*** [*ca-n xhoogo*]
 DEF.PL=peer-2SG.POSS-PROX here in-NSPEC home

‘And Jethro, yesterday and the day before your relatives stood here, here at home.’ [CP1:29]

- (64) *e=ha-mwa* ***canbwen***

1SG=go-REP yesterday

‘I went back yesterday.’ [B2:134]

- (65) *na i=vaaya-n xayu habu ka*

DEM DEF.SG=work-POSS man before DISC

‘This was a man’s work back then, like.’ [AG1:160]

6.13.1 Temporal adverbs

Temporal adverbs are a closed class of words that can occur in a fronted position (66). They cannot take articles. Temporal adverbs were almost all derived from nominals, compare *bwaabwen* ‘morning’ is related to the adverb *bwaabwen-an* ‘in the morning after’. Members include *ca-n-bwen* ‘yesterday (lit. ‘in-NSPEC-night’), *naen* ‘today/now’, *xahmaen* ‘tomorrow’⁵, *jimin* ‘late at night (after having fallen asleep)’, *bwethaloo* ‘two days ago’, *thaloobwen* ‘overmorrow (lit. ‘two nights’), *daboo-n bwen* ‘midnight (‘lit. puddle/lake of the night’)’ *hnyanan* ‘constantly (lit. ‘its breath’), *mati* ‘earlier’, *mu-bwen* ‘early in the morning (lit. ‘little night’), *nyeet* ‘when?’, *ca-li-been* ‘sometimes (lit. ‘among the others’)’.

- (66) *na li=peintures habu*

DEM DEF.PL=paint before

‘It’s the (style of) painting from the old days.’ [KG:21]

6.13.2 Locative adverbs

A closed class of words describes locations. They are mostly derived from movement verbs.⁶ They do not bear articles, can be fronted alone (68), and can mod-

⁵Proto (Southern) Oceanic *marani (Lynch 2004: 314).

⁶*Patemwano* ‘directly next to it’, *ngangeno* ‘close-by’ in Pije (Haudricourt & Ozanne-Rivierre 1982: 170) and *puput* ‘behind (a building or a sizeable entity)’ can be used in the same slots but do not possess the morphological combinatorics shown in Table 6.12.

ify verbs (67) as well as nouns (69). Locative adverbs can be predicates, see (69). Contrary to relational nouns (§6.5.2), locative adverbs do not form possessive relations with nouns, nor do they take generic *-n*. Table 6.12 shows a summary of the forms. For a more thorough account of space (see §9.4.3).

Table 6.12: Locative adverbs

Axis	Verb	Simple location	Close-by	Further away
same-level	<i>han</i>	<i>xa-han</i>	<i>nya-xa-han</i>	<i>nya-an xa-han</i>
downward	<i>hut</i>	<i>xa-hut</i>	<i>nya-xa-hut</i>	<i>nya-ut xa-hut</i>
upward	<i>ta</i>	<i>xa-da</i>	<i>nya-xa-da</i>	<i>nya-da xa-da</i>
downstream	<i>hnuut</i>	<i>xa-hnuut</i>	<i>nya-xa-hnuut</i>	<i>nya-hnut xa-hnuut</i>
upstream	<i>hnuuda</i>	<i>xa-hnuuda</i>	<i>nya-xa-hnuuda</i>	<i>nya-hnuda xa-hnuuda</i>

(67) *go=moo xahut, go=xahut, go=hut xahut*
 2SG=stay below 2SG=below 2SG=go.down below
 ‘You live down there, you’re down there, you go down there.’

(68) *xahut, go=majit mati*
 below 2SG=rest earlier
 ‘Down there, you were sleeping earlier.’

(69) *i=apuli (a=) xahut*
 DEF.SG=man (3SG=) below
 ‘The man is down there.’

6.13.3 *hman* ‘also’

hman ‘also’ modifies verbs (70), nouns (71), and adverbs. Contrary to temporal and locative adverbs, *hman* always comes after the modified word and cannot be fronted on its own. Similarly to *mwa* (§13.4), *hman* is used as a discourse marker as well, with a meaning of ‘however’ (72).

(70) *tha gau=han tha gau tha gase=bo arriver hman*
 ASS 2DU=go ASS 2DU ASS 1PL.INCL=IRR arrive also
 ‘You go (despite the height of the steel beam), you two, we’ll get (to the other side), too.’ [KG:9]

- (71) *li=meeeka i=...li=nyan-mwa ca-n hman*
 DEF.PL=all DEF.SG=...DEF.PL=inside-house in-ANA also
 ‘All the rooms in the house as well.’ [KG: 30-1]
- (72) *thake yavo kavi tha cipa xhwii hman*
 throw fishing.line but ASS NEG bite also
 ‘...threw out the fishing line but it didn’t bite though.’ [GP:73]

6.14 Complementizer *hapi*

Clauses that are complement to verbs of cognition (73), opinion, and perception (74), are introduced by the subordinator *hapi*. Considering Lynch et al. (2002)’s observation that Oceanic languages tend to use a form related or identical to the word ‘to say’ to introduce complement clauses (Lynch et al. 2002: 53), that Voh-Koné languages changed *p-* → *v-*, and that Hienghène languages have *peei* ‘to say’, ‘COMP’ (Haudricourt & Ozanne-Rivierre 1982: 260), postulating *a=vii* ‘s/he says’ as the origin of *hapi* seems plausible.

- (73) *e=caihna-n hapi tha hmwaana*
 1SG=know-NSPEC COMP ASS thus
 ‘I know that it’s like that.’
- (74) *sahnaang-eong hapi tha hmwaana*
 not.understand-1SG COMP ASS thus
 ‘I’m not sure/I doubt that it’s like that.’

6.15 Conjunctions

Vamale distinguishes two groups of conjunctions: those that link noun phrases, and those that link verb phrases as well as clauses. Clauses are defined by the presence of a predicate, which is in most cases a verb phrase. This book calls the conjunctions linking these “verbal”, to distinguish them from nominal ones.

6.15.1 Nominal conjunctions

Nominal conjunctions connect noun (phrases) and form a new constituent containing the connected noun phrases and the conjunction. Members include *ma* ‘and/with’ (75), *ka* ‘on the other hand’ (76), *hai ~a* ‘or’ (77) with its derivative *hai...hai* ‘either...or’ (78), *moko* ‘more than’. *Moko* may be complex and composed

of *moo* ‘rest, reside’ and *ko* ‘on’ (§10.5). It has no Hienghène cognate. The other Voh-Koné varieties share the form, however. Rivierre & Ehrhardt (2006: 215) suggest a makeup of *mo* ‘from’, as in *e ha-me mo Tuo* ‘I come **from** Touho’, and *ko* ‘on’.

- (75) *i=wabatan ma i=xat*
 DEF.SG=north.wind and DEF.SG=sun
 ‘the north wind and the sun’
- (76) *i=wabatan ka i=xat*
 DEF.SG=north.wind and DEF.SG=sun
 ‘the north wind, and (on the other hand) the sun’
- (77) *i=wabatan hai i=xat*
 DEF.SG=north.wind or DEF.SG=sun
 ‘the north wind or the sun’
- (78) *hai i=wabatan hai i=xat*
 or DEF.SG=north.wind or DEF.SG=sun
 ‘either the north wind or the sun’

6.15.2 Verbal conjunctions

The set of verbal conjunctions is small and closed, and groups together some morphemes which only occur in this set, like *kavi* ‘but’, with words also present in other distributional classes. The meaning distinctions between *kavi* ‘but (introducing something in contrast with the former element)’, *ko* ‘but [introducing something unexpected]’, and *ma* ‘but (relaying something related but different)’ are fine and depend on the context. Members include *ka* ‘and’ (79), *kavi* ‘but’ (80), *ma* ‘and, but’ (81), *hai ~ a* ‘or’ (82), *ko* ‘but’, ‘because’, *kona* ‘furthermore’.

- (79) *le=hame ka le=siwa=mwa*
 3PL=come and 3PL=return=REP
 ‘They came and they left again.’
- (80) *le=hame kavi le=siwa-mwa*
 3PL=come but 3PL=return-REP
 ‘They came but they left again.’

6 Word classes

(81) *le=ha-me ma le=siwa-mwa*
3PL=go-DIR.CP and 3PL=return-REP
'They come and/in order to go.'

(82) *le=ha-me hai le=siwa=mwa*
3PL=go-DIR.CP or 3PL=return=REP
'They come or they go.'

Ka is also used colloquially after a clause to ask for confirmation (83) (see §13.2.1.1).

(83) *i=apuli a=xahan ka?*
DEF.SG=person REL=over.there DISC
'The guy over there, like?'

Numbers are verbal, and (*na*)-*bwa* 'plus' (possibly from DEM-'head', 84), and *ko* 'times' (probably from *ko* 'on') are used to construct complex numbers (85).

(84) (*nim a-bwa se*)
nim na-bwa se
5 plus 1
'6'

(85) *nim na-bwa se ko apuli nabwa nim na-bwa se*
5 plus 1 times man/20 plus 5 plus 1
'126'

6.16 Subordinators

Vamale subordinators introduce a subordinated clause. They precede all other elements of said clause, and cannot occur without the clause, moving with it if fronted, see examples (86–91). All those ending on *-a* assimilate to following *e=* '1SG'. They are proclitics. Members include *cala* 'when' *cama* 'if', *ma* 'as/in order to', *ko* 'because', *ko-ma* 'so that', *ecupwa* 'until'.⁷

(86) *cel=e=hame go=pa yahan*
when=1SG=come 2SG=PRF leave
'When I came, you had already left.'

⁷Possibly from *e-cuut-pwa* 'REFL-stand-on'.

- (87) *cala go=hame e=pa yahan*
 when 2SG=come 1SG=PRF leave
 ‘When you came, I had already left.’
- (88) *cem=e hame go=pa yahan*
 if/when=1SG come 2SG=PRF leave
 ‘If I come, you will already have left.’
 ‘Whenever I come, you already have left.’
- (89) *cama go=hame e=pa yahan*
 if/when 2SG=come 1SG=PRF leave
 ‘If you come, I will already have left.’
 ‘Whenever you come, I already have left.’
- (90) *m=e hame go=pa yahan*
 as=1SG come 2SG=PRF leave
 ‘As I come, you’ve already left.’
- (91) *ma le=fe, le=mu=xaahni*
 as 3SG=take, 3PL=FREQ=check
 ‘When they take it, they check it.’

Non-fronted examples, illustrated in (92), are the norm.

- (92) *tha=abe=saavi cama=abe icu-koo-n ko-n marché*
 ASS=1PL.EXCL=dig.up SUBR=1PL.EXCL trade-OBL-ANA on-NSPEC market
 ‘We dig (them) up when we sell them on the market.’ [AG1:22]
- (93) *le=thêên cala le=siwa-mwa*
 3PL=run when.REAL 3PL=return-REP
 ‘They ran when they went back.’
- (94) *le=thêên ma le=yahan*
 3PL=run when.IRR/if 3PL=leave
 ‘(Usually) they run when they leave.’ / ‘They would run if they left.’
- (95) *e=ha-me ma go=bwa=yahan*
 1SG=go-DIR.CP SUBR 2SG=IPFV=leave
 ‘I come as as you leave.’ / ‘I come if you leave.’ / ‘I come so that you leave.’

6.17 Negation markers

The negation markers *cipa* ‘NEG’ and *cipii* ‘PROH’ share their scope over the entire following clause and their left-most position. The negation markers are not identical in their distribution and could, strictly speaking, be classified into two separate classes. Contrary to *cipa* ‘NEG’ (96), *cipii* ‘PROH’ cannot take assertive *tha*, nor *na* ‘FOC’. Furthermore, *cipii* often omits the subject marker, which *cipa* cannot do (98). This grammar will treat *cipa* as a proclitic, because it integrates into the following verb phrase’s stress structure, and assimilates phonologically to it as well (97).

- (96) *(tha) cipa* [go=bwaa=majit]?
 (ASS) NEG 2SG=IPFV=sleep
 ‘Aren’t you still asleep?’
- (97) [ci.pe.mān.jit]
cipa= e= majit
 NEG 1SG= sleep
 ‘I don’t sleep.’
- (98) *cipii xaloo koo-ng hmwaahni (ka go)!*
 PROH gaze OBL-1SG.POSS thus SBJ 2SG
 ‘Don’t look at me like that!’

6.18 Assertive *tha*

The assertive marker *tha* is a proclitic that docks onto the predicates of non-imperative clauses, on the left-most position (99). *Tha* assimilates to *e=* ‘1SG’, like *cipa* ‘NEG’ (100).

- (99) *au lieu ma tha bwa xhavwale i=copain-ea vukin tha=a*
 instead SUBR ASS IPFV wait DEF.SG=friend-3SG.POSS reason ASS=3SG
bo guide-ea
 IRR guide-3SG.POSS
 ‘Instead of waiting for his friend, because he would be his guide!’
 [KG:497]
- (100) *cala th=e vwa-tau*
 when ASS=1SG do-impact
 ‘when I fish’ [B3:3]

6.19 Intensifiers

The two intensifiers *juu* ‘real, very’ and *vaa* ‘(too) much’ (most often preceded by *juu*, but see 102) cannot stand alone, are semantically vague (see Table 6.13), and attach to the head of a phrase (be that a noun, an adverb, or anything else, 101) as closely as possible. Given that they can be stressed, they are analyzed as particles, though “anti-clitic” may be a better term considering the fact that they syntactically depend on a host that can be nominal, verbal, or adverbial in nature. *Juu* is also associated to *bwa* ‘IPFV’, as described in §12.3.2.

- (101) *a=juu hnyimake ka i=juu apuli, juu ca-n-bwen*
 3SG=very think SBJ DEF.SG=real person real in-NSPEC-night
 ‘He thought hard, the real man, just yesterday.’
- (102) *ma go=hmwaani vwasoon, ma go=hmwaani vaa...*
 COND 2SG=like.this impossible COND 2SG=like.this too.much
 ‘If you do it like this, it’s impossible, and if you do it like this, it’s too...’
 [KG:140]

Table 6.13: Meanings of compounds with *juu*

Form	Translation of	
	the 2nd morpheme	the whole
<i>juu han</i>	walk	‘walk barefoot’
<i>juu aman</i>	thing	‘important (adverb)’
<i>juu we</i>	water	‘drinking water’
<i>juu toot</i>	grass	‘thatching grass’
<i>juu o</i>	bamboo	‘building bamboo’
<i>juu mwa</i>	house	‘trad. house’
<i>juu mani</i>	bird	‘notou [ducula goliath]’
<i>juu apuli</i>	person	‘Kanak’
<i>juujuu</i>		‘truth’

The particle *vaa*, depending on the word it modifies, means ‘much (uncountable)’ with non-human nouns (103), intensifies the following verb, e.g. *vaa thêên* ‘strongly run’/‘run fast’, and in combination with *ju* ‘real, true’, it means ‘too much’, as in (104).

- (103) *e-vaa nya-da xa-da*
 MID-INTS towards-up.there LOC.ADV-up
 ‘There are many (feral pigs) up there.’ [J3 16.1]
- (104) *juu va vwasoon ma gase=vwa li=vaaya-n li=xhaohmu*
 real much difficult COMP 1PL.INCL=do DEF.PL=work-POSS DEF.PL=elder
 ‘It’s too hard for us to do the work of the elders.’ [KP:98]

6.20 Repetitive *mwa*

This class only has one member. *Mwa* has rather different, related meanings, depending on the context. *Mwa* can have the repetitive meaning ‘again’ (105), the restitutive ‘back’, as well as ‘also’, ‘even’, ‘on top of that’, or mark the preceding phrase as focused (see §13.4 for a discussion). The deictic use of *mwa* ‘now’ (107), seems to mostly anchor the listener’s attention, similarly to *mwa* ‘even’, onto the noun phrase given, see (108). *Mwa* is a particle that can dock onto any phrase preceding it (see 106).

- (105) *e=xaleke mwa*
 1SG=see REP
 ‘I see again.’, ‘I even see.’
- (106) *e=vatipwe mwa nya-mwa si-m mwa i=mwani mwa*
 1SG=drop REP give-REP hand-2SG.POSS REP DEF.SG=money REP
 ‘I pass on to you too this money as well.’
- (107) *hê na tha vwa li=wii-n. go le=vwa ibi-han*
 yes DEM ASS EXIST DEF.PL=field-POSS.NSPEC then 3PL=do pinch-walk
li=nyamaan go tha le=ve-moo mwa, moo mwa.
 DEF.PL=eye then ASS 3PL=MID-stay REP stay REP
 ‘Yes there were fields of it (macaranga vedeliana). And they’d go pinch the young sprouts. And those stay together now, stay.’ [KL:218-222]
- (108) *ya a=ja vwa mwa li=wee-n a=ta-mwa sibu*
 EXPL 3SG=PRF do REP DEF.PL=water-POSS.NSPEC 3SG=go.up-REP swell
li=sibu mwa. ja yabwat mwa sisuu mwa
 DEF.PL=swell REP PRF dry REP hard DEICT
 ‘And there’s the sap that rises, swells, the swells there. It dries then, gets hard then.’

In (109) and for all other movement verbs, as well as *xhose* ‘do again’, *mwa* is analyzed as a suffix, i.e. as having fused with its host. First, *mwa* assimilates to the root, which it does not do in other contexts.⁸ Compare *hut-mwa* → /hup^wa/ ‘go back down’, to *hut=mwa* ‘go down again’.

- (109) *go=ha-mwa-me*
 2SG=GO=REP=DIR.CP
 ‘You return to me, you come back.’

- (110) *go=ha-me mwa*
 2SG=GO=DIR.CP REP
 ‘You come again.’

The particle also expresses repetition (111), and deictically referring to something close spatially or recently mentioned (which is probably a derived meaning), as in (112). See §13.4 for a more detailed description.

- (111) *e=tena mwa^{REP} i=hun-det*
 1SG=hear REP DEF.SG=NMLZ-sound
 ‘I hear the sound again.’ [JR:17]

- (112) *xhose e=tena mwa^{REP} tha=a=bwa vwa det mwa^{DEICT}*
 again 1SG-feel REP ASS=3SG=IPFV do sound REP
 ‘Again I heard him make said (*mwa*) noise.’ [JR:18]

6.21 Interjections

Interjections do not integrate into clauses or phrases, and though at least *hê* ‘yes’ can be derived to *hêêke* ‘to assent, to say yes’, and *cika* ‘NEG.EXIST’ is a commonly used impersonal verb, exclamations form a group through their uniquely individualistic behavior. Members include *ya* ‘voilà, the result is there’, *ûhû/cika* ‘no’, *hat* ‘strong negation’, *hai* ‘oh! (surprise, discovery)’ and *hê/helong* ‘yes’, as well as a growing class of swearwords.

⁸*Xhosepwa* suggests a dropped *-t* or *-p*. The Pije and Fwâi cognates *khô-peei* ‘?-say’ (Haudricourt & Ozanne-Rivierre 1982: 155) could be a diachronic hint at a morphologically complex, old Vamale form.

6.22 Quantifiers

Quantifiers are a tiny group of particles that are not inflected, directly preceding an (article) noun construction: *mu* ‘little’, *jaa* ‘many’ (113), and *ju-vaa* ‘too much’, which is also attested as an intensifier in verb phrases (114). Quantifiers denote number and are described in §8.4.2. Other words have similar meanings, but are verbs, like *hmai-* ‘many’. One quantifier similarly integrates the noun phrase, but bears possessive suffixes: *meeka-n* ‘all’.

(113) *ja apuli canbwen*
many people yesterday
‘(there were) more people yesterday (than now)’ [B2 31.1]

(114) *ju-vaa apuli*
too.much person
‘too many people’ [B2:32]

7 Nouns

Vamale nouns are defined in this grammar as single words which can bear articles (see §6.3). Few other factors distinguish nouns from verbs, as nouns can be predicates with the same subject index markers as active verbs, see (1). Only nouns, however, can be arguments of verbs, can be counted, can be possessed (though possessive morphology shows overlaps with some verbal morphology (see §9.2 and §9.2.3), and not all nouns can be possessed, e.g. *jati* ‘sea’). Although nouns do take some TAM marking, not all TAM marking is attested for nouns (e.g. *bwa balan* ‘only just (begun)’, *kon* ‘PROG’). Nouns are not inflected for number; this is covered by articles (for specific nouns; generic ones do not have articles).

- (1) *e=juura caacaa*
1SG=almost father
‘I am almost a father (soon).’ [B2:108]
- (2) *xhwat thuang m=e=caacaa*
bit joke SUBR=1SG=father
‘I am almost a father (kind of).’

Vamale nouns can be classified along different dimensions. The animate/inanimate distinction, a semantic, lexically determined trait, affects their index-marking on verbs. While index-marking is treated in §9.3.1, other effects of this distinction are described in §7.1. Some nouns are uncountable (such as water, light, blood, etc.) and are thus not attested with non-singular articles. Finally, possessible nouns can be either alienably or inalienably possessed. This distinction is another typically Oceanic feature (Lynch et al. 2002: 41), though Vamale has added its own innovations (see §7.2). This chapter will briefly introduce these dimensions, but will focus only on possession, as the others are lexically determined. This chapter will also discuss classifiers (§7.3). Vamale does not have many classifiers, and they are mostly relational: they add information about the nature of relationship between the possessor and the possessum. An exception are food classifiers, which, contrary to the possessive classifiers, can appear without the noun they classify. §7.3.4 describes noun classifiers, which are obligatory

in the context of plant species: *mwago* ‘mango’ cannot appear alone; one must specify which part of the plant is meant. Noun classifiers are related to a much larger field of optional noun compound heads. Compound nouns are discussed in §7.4.

7.1 Animacy

Nouns in Vamale are animate or inanimate. While other languages in New Caledonia distinguish human and non-human animate nouns (Cèmuhi even makes a difference between feminine and non-feminine nouns, Rivierre 1980: 175), this is of no importance in Vamale. An exception are some nouns, e.g. *in maan* ‘skin (human)’ vs. *in* ‘skin (non-human, or dead human)’, and oblique markers: *nyasi-* ‘BEN, TOP’ can only be used for humans whereas *nyako-* is more general (see §8.1.2). Animate participants further trigger person marking on stative verbs (3) and must be indexed with suffixes on transitive verbs (4). Both contexts omit any indexing if the relevant noun phrase occurs within the verb phrase (5).

- (3) *ka abe niehni a= thien-abe*
 CNJ 1PL.EXCL DEM.PL REL= three-1PL.EXCL
 ‘And we are those [masters of the rock], who are three (and we are these three masters of the rock).’ [DP:29]
- (4) *na cahni tha xhwan see-a a= thathe-a*
 DEM here ASS a.bit one-3SG REL= kill-3SG.OBJ
 ‘Here there was only one that was killed.’ [HC1:22]
- (5) (*hmwet* is a stative verb)
hmwet i=apuli
 tired DEF.SG=person
 ‘The person is tired.’ [J8:7]

Another context in which animacy makes a difference is deverbal nominalizations, in which case the intransitive subject is only marked for person if the referent is animate: *i hun-moo-a* ‘DEF.SG=NMLZ-be-3SG’ ‘his/her character’, but *i hun-moo* ‘its nature’. This is described in more detail in §9.7.

7.2 Possession

Possessed nouns make a distinction in alienability, i.e. whether they can occur without marking a possessor. This is a widespread Oceanic phenomenon (Ross

2004: 511). Alienable and inalienable nouns follow certain semantic tendencies outlined in Table 7.1, though there are numerous exceptions. Non-possessible nouns include proper names and unique concepts such as the sea or the sun, although poetic contexts may feature counterevidence. Another exception is *la* ‘place’, which can neither be generic (as would be indicated by *-n* on preceding verbs and prepositions), nor take an article, but syntactically behaves like a noun otherwise (i.e. it follows prepositions) (6).

- (6) *suu cahni ca la*
 break here in place
 ‘Break it here at this spot!’ [KG:115]

Table 7.1: Semantic tendencies of possessed nouns

Inalienable	Alienable
Body parts (except blood)	Animals
Things belonging to humans (spirit, colour, appearance, strength)	Plants
Many kinship appellation terms (not the address forms)	Tools

However, while most Oceanic languages distinguish direct (i.e. affixed) possession from indirect constructions using a relational classifier, Vamale has mostly done away with this distinction. Based on prosodic clues, especially stress shift, all possessive morphemes are considered suffixes, as in [‘pu.a.ka] ‘pig’, [pu.a.ka.ne.ɔŋ]/[pu.a.ka.ne.o] ‘my pig’. The only clearly indirect possessive morpheme remaining is the linker *ka-*, discussed in §9.7.6. Possessive forms are not a sure sign of the nounhood of their host, even though nouns represent the vast majority of possessed lexemes. There are verbs with nominal morphology (e.g. *hmana-n* ‘hunger-3SG.POSS, s/he is hungry’), and some stative verbs that have an identical nominal counterpart, e.g. *mulip*, *muliv-ong* ‘life, I am alive’ (see §6.12 and §9.2.3).

There are several paradigms of possessive morphology, summarized in their most basic form in Table 7.2. Paradigm I is mostly used for inalienable nouns, while paradigms Ib and II are used for alienable nouns. Loanwords exclusively take paradigm II forms.

This basic overview given in Table 7.2 shows a distinction especially in the singular forms, where paradigm II has forms reminiscent of the free pronouns

Table 7.2: Possessive suffix paradigms

		I	Ib	II
SG	1	-ng	-ong	-eong
	2	-m	-am	-go
	3	-n	-an	-ea
DU	1INCL	-ju	-aju	-gaeu
	1EXCL	-bu	-abu	-abu
	2	-u	-au	-gau
	3	-lu	-alu	-lu
PL	1INCL	-je	-aje	-gaa
	1EXCL	-be	-abe	-abe
	2	-vwe	-avwe	-gavwe
	3	-le	-ale	-le

mentioned in §6.6, and of the object suffixes discussed in Chapter 9, whereas paradigms I and Ib have forms that are unique. Indeed, paradigm Ib is the exact same as paradigm I, except that it inflects alienable forms, whose stems end in consonants. The similarity of paradigm II forms with pronouns could suggest that paradigms I and Ib have older morphology, and paradigm II was originally a possessive noun phrase, whose possessor NP was later incorporated (e.g. *yee-n yo* ‘tree-POSS 1SG’ → *yee=n-eo* ‘tree=POSS-1SG’). The first person may have assimilated to paradigm I *-(o)ng*.

Contrary to paradigm I suffixes, paradigm II forms can attach to the end of noun phrases and of nominalized verb phrases (see §9.7.6). This difference in freedom of host selection is called “direct” and “indirect” possessive morphology, and many New Caledonian languages still oppose suffixes to free forms. For Vamale, I view *-(e)ong* and the other paradigm II morphemes as suffixes, for at least 1SG and 3SG are different from the free pronominal forms that can be found in other possessive constructions, e.g. *mama-n gau ma yo* ‘the mother of you two, and me’, and the possessive forms are integrated into the stress structure (see §5.6).

Hollyman identifies three main classes of possessed nouns in northern New Caledonian languages (Hollyman 1999: 61–62), listed below. While these are found in Vamale as well (see the examples added to Hollyman’s list), differences emerge in the subclasses. For example, Hollyman (1999) does not mention vowel

lengthening, though this is a phenomenon well described for Nêlemwa (Bril 2002: 29–33). Another possessive noun class not mentioned by Hollyman is that of length shift: *iila*, *il-oong ilaa-m* ‘cauldron, my, your cauldron’. This pattern is described for Bwato (Rivierre & Ehrhardt 2006: 37), though it seems in every case to be restricted to small groups of nouns.

- A. inalienable (see set I in Table 7.2)
- B. alienable, vowel-final
 - B1. -V + suffix: *wata* ‘digging stick’, *wata-m* ‘your digging stick’
 - B2. change of -V + suffix: *da*, ‘spear’ *de-ong* ‘spear-1SG.POSS’
 - B2a. Lengthenings are found as well: *hanu*, ‘picture’ *hanuu-ng* ‘picture-1SG.POSS’
 - B3. -V + other V + suffix: Not seen in Vamale.
- C. alienable, consonant-final
 - C1. -C is dropped, possessive suffix is added to the rest of the stem. *Xeet* ‘basket’, *xee-ng* ‘basket-1SG.POSS’
 - C2. -C is dropped, last vowel of the stem changes, possessive suffix added to it. Not seen in Vamale, though nouns that used to have a final consonant may have dropped it since.
 - C3. -C is replaced by an irregular sequence of another consonant and a vowel: *jiket* ‘arrow’ *jike-l-ong/-an* ‘arrow-1SG.POSS/3SG.POSS’.
 - C4. -C is replaced by an irregular vowel. Not seen in Vamale. However, Hollyman’s Jawe example *jic*, *jie-n* ‘belly’ is still Vamale *jia-n* (Hollyman 1999: 62).
 - C5. a vowel is introduced between the stem-final consonant and the possessive suffix: *fwaadan* ‘road’, *fwaadan-i-le* ‘road-3PL’, but also all forms in set Ib.

Table 7.3 shows several things, most of which only apply to paradigm I. Stems ending in /i/ and /u/ cause a progressive assimilation to /u/ in the first person singular (*si-*, *su-ng* ‘hand, my hand’, *hanu-ung* ‘my picture’), as described in §5.3.4.2. Long vowels in the stems of monosyllabic, paradigm I items assimilate the vowel [ɔ] of *-ong* 1SG (*hnyanaa-ng* ‘my breath’). Long vowels in the stems of alienable, polysyllabic items lose their length in the possessed form, and a vowel of the possessive morpheme is lengthened (*iila*, *il-oong* ‘pot, my pot’, *fwaadan*, *fwadanuung*

Table 7.3: Possessive classes

Inalienable		Alienable			
	-n	C-final stem		V-final	
-V1n/-V2ng	-V:n/-V:ng	ka-n/k-ong	-t/-l-	-V-n-eong/ -go/-ea	irregular -V/-V:-ng
<i>si-n</i> , <i>s-ung</i> 'hand'	<i>hnyanaa-n</i> , <i>hnyanaa-ng</i> 'breath'	<i>vwaseeka-n</i> , <i>vwaseek-ong</i> 'sadness'	<i>fedat</i> , <i>fedal-ong</i> 'blood'	<i>hneeng</i> , <i>hneeng-eong</i> 'law'	<i>jo</i> , <i>jo-n-eong</i> 'chicken'
<i>xha-n</i> , <i>xh-ong</i> 'leg'	<i>wii-n</i> , <i>wii-ng</i> 'strength'	<i>saleka-n</i> , <i>salek-ong</i> 'possession'	<i>wadat</i> , <i>wadal-ong</i> 'gun'	<i>vap</i> , <i>vap-eong</i> 'hunt'	<i>vuki</i> , <i>vuki-n-eong</i> 'reason, fault'
<i>xhapun-an</i> , <i>xhapun-ale</i> 'colour'	<i>waa-n</i> , <i>waa-ng</i> 'root'	<i>vadang</i> , <i>vadang-ong</i> 'cabin, shelter'	<i>vaset</i> , <i>vasel-ale</i> 'swamp clam'	<i>shanyip</i> , <i>shanyip- eong</i> 'dream'	<i>hanu</i> , <i>hanu-ung</i> , <i>hanuu</i> 'picture'
				<i>mwa</i> , <i>mwa-n-eong</i> 'house'	<i>xa</i> , <i>xaa-ng</i> 'tuber cutting for replanting'

‘path, my path’). There are alienable items, again with paradigm I forms, where the stem-final /t/ changes to /l/ in possessive contexts. This is due to a Proto-Oceanic liquid that is preserved intervocally as /l/ in Vamale, but merged with /t/ in coda positions (see §5.2 for more details on finals). The pair *mulip*, *muliv-an* ‘life, s/he is alive’ is not included in this table because it represents a very small class (the only other confirmed case is *vap/vavi* ‘go on a hunt/hunt something’); they probably have a similar background. Alienable forms ending in other consonants add a probably epenthetic *-a-*: *thin* ‘closing’, *thin-an* ‘lid’. Those nouns also use direct forms of the Ib set. Inalienable nouns belong to the following classes: *ka-n*, *-V-ng*, vowel change.

Table 7.4: Possessive suffixes, OBJ and *-s_p*

		I	Ib	II	<i>-s_p</i>	OBJ
SG	1	<i>-ng</i>	<i>-ong</i>	<i>-eong</i>	<i>-ong</i>	<i>-eo</i>
	2	<i>-m</i>	<i>-am</i>	<i>-go</i>	<i>-go</i>	<i>-ko</i>
	3	<i>-n</i>	<i>-an</i>	<i>-ea</i>	<i>-(e)a</i>	<i>-a</i>
DU	1INCL	<i>-ju</i>	<i>-aju</i>	<i>-ju</i>	<i>-gaeu/-gasu</i>	<i>-kaeu</i>
	1EXCL	<i>-bu</i>	<i>-abu</i>	<i>-bu</i>	<i>-gabu</i>	<i>-kabu</i>
	2	<i>-u</i>	<i>-au</i>	<i>-gau</i>	<i>-gau</i>	<i>-kau</i>
	3	<i>-lu</i>	<i>-alu</i>	<i>-lu</i>	<i>-lu</i>	<i>-lu</i>
PL	1INCL	<i>-je</i>	<i>-aje</i>	<i>-je</i>	<i>-gaa</i>	<i>-kaa</i>
	1EXCL	<i>-be</i>	<i>-abe</i>	<i>-be</i>	<i>-abe</i>	<i>-kabe</i>
	2	<i>-vwe</i>	<i>-avwe</i>	<i>-vwe</i>	<i>-gavwe</i>	<i>-kavwe</i>
	3	<i>-le</i>	<i>-ale</i>	<i>-le</i>	<i>-le</i>	<i>-le</i>

Anything that is not usually possessed (*vap* ‘hunt’) or is a loanword (*teeriko*, *teerikoneong* ‘(my) shirt’), is possessed with set II suffixes. An epenthetic *n* appears if following a morpheme-final vowel. Diachronically, it seems likely that this *-n* was a linker morpheme descended from POC **na* (Lynch 2000: 234), probably an independent word (i.e. not a clitic), followed by the possessor pronoun or noun. It would have become a construct suffix over time. The pronouns were incorporated into the possessum later on. This would also explain the forms *-eo(ng)* ‘1SG.POSS’ and *-ea* ‘3SG.POSS’: the free pronouns are /jo/ and /ja/ to this day, and forms like /*yaju*/ ‘male’ can be pronounced /*yaeu*/, which suggests that glides can be realized as more open vowels in some contexts. This means that the epenthetic *-e* found in Ib, OBJ, and *-s_p* suffixes does not seem to be phonologically conditioned like in Caac: ‘*e* ‘IND’ is used when the lexeme it follows ends

with a consonant (18, 19) while *le* ‘IND’ is utilized when the lexeme it follows ends with a vowel (16, 17)’ (Cauchard 2014: 32).

Some words have two possessive paradigms, one with set I suffixes, like *i mulip* ‘the life’/*mulivong* ‘I am alive’, and another with set II forms, i.e. *-eong*, *mulip-eong* ‘my life’. Speakers disagree on whether the latter form is more emphatic and marked, i.e. ‘my life’ vs ‘this life of mine’, or whether there is a meaning difference. This same discussion arises with other nouns as well, e.g. *wat-ong* or *wata-n-eong* ‘the digging stick which is mine (and nobody else’s)’.

7.2.1 Alienable

Alienable nouns form the bulk of Vamale nouns. An open class which seems to be slowly gaining members from the inalienable class, its possessive suffixes are mostly from Set Ib or II. Those nouns inflected with Set Ib forms, usually associated with inalienable nouns, are often semantically close to inalienable nouns, such as certain kinship terms, or things belonging to bodies (spirit, breath, tail). One major difference from inalienable forms is the fact that they never drop their final consonant.

7.2.2 Inalienable

Vamale has a considerable number of nouns which must be possessed. If the possessor is unknown, inalienable nouns take a generic *-n* ‘NSPEC’. Inalienably possessed nouns form a closed class, bearing paradigm I suffixes in Table 7.2. The only seeming exception is the nominalizations bearing *=ka-n*, but note that *=ka-* is a grammatical word which can be omitted from the nominalizing constructions (see §9.7.6), and takes paradigm II suffixes. *Ka-* is inalienable in the sense that the construction it precedes must be possessed. The locative nouns (“prepositions”) mentioned in §6.5.2 are members of this closed class. Inalienable nouns use both *-n* ‘3SG.POSS’ and *-m* ‘2SG.POSS’ for quotation forms. Some inalienable nouns, in compounds where they are not the head, lose their possessive morphology when they do not have a specific referent, e.g. *mwa-n nyama* ‘glasses (in general, nobody’s glasses)’. If possessed, however, it is the second part of the compound that is possessed, i.e. *mwa-n nyamaa-ng* ‘my glasses’. See also *vwa suki(-n)* ‘pay (for something)’, which, nominalized, becomes *xavwasuki* ‘money-spender’, glossed in (7). This is not attested for *e-vwadi ya-n* ‘thumb (lit. NMLZ.INS-peel.with.fingers starchy.food-POSS)’, possibly because a thumb is itself an inalienable concept, whereas glasses are alienable.

- (7) *xa=vwa-suki*
 NMLZ.AGT=do-price
 ‘a money-spender’

Some nouns are inalienable, but cannot be possessed by humans. They thus do not take any personal possessive suffixes, although they otherwise follow classical inalienable morphology, i.e. an alternation between generic *-n* ‘NSPEC’, specific *-n* ‘3SG.POSS’, and a postponed possessor noun phrase. Examples include *maa-n* ‘point, visible side’, *thin-an* ‘lid’ (derived from *thin*, ‘close’), *xhii-n* ‘fin’,¹ and *vaa-n* ‘undergarment, base’, which must be followed by what garment covers it, shoes or pants or a dress. Consider Table 7.5. The nouns listed in the table need a (specified or implicit) bigger context, which is usually postponed as a modifier. They are part of a part-whole relationship that ties specific part-of-a-whole words to their possessor entity, e.g. *bati* ‘long piece of wood that is detached from the tree’, *xada-n* ‘(jagged) detached part of something hard’, while others are more generic, such as *xhula-n* ‘extremity, consequence’.

Table 7.5: Parts of things

<i>thin-an</i>	‘lid’
<i>xhii-n</i>	‘fin’
<i>vaa-n</i>	‘undergarment, base’
<i>bala-n</i>	piece of something long (rope, stick)
<i>hmanya-n</i>	crumbs of wood or stone
<i>xada-n</i>	shard, sharp-edged bit
<i>bati</i>	detached bit of wood
<i>bate</i>	extremity, beginning/end of an entity
<i>xhula-n</i>	consequence, extremity of event
<i>maa-n</i>	‘point, visible side’

¹Animal anatomy terms have probably lost some ground since the culture mostly abandoned sustenance fishing, but even then there are remarkably few animal-specific body terms. *Uba-n* ‘fish scale’, *thaang-an* ‘tentacle’ and *jahlo* ‘rooster’s crest’ are the only other terms recorded in the lexicon. Animal anatomy, like plant anatomy, is described in the same terms as their human equivalent.

7.3 Classifiers

Classifiers are a well-established and rich class in both Nélêmwa (Bril 2002) and Iaai, but not thought to be widespread in Mainland New Caledonian. In Vamale, there is a semantically defined group of nouns that easily and often forms quasi-possessive phrases with other nouns. Most of these nouns are inalienably possessed. They form the head of their phrase; the other noun cannot bear an article (9), and, in the cases discussed here, cannot occur without the head (in the semantic contexts which warrant these constructions). In any case, the nouns discussed here can occur without the modifying noun. Following Aikhenvald (2000), this study will call these nouns classifiers. Words like *saleka-n* ‘possession’, *coola-n* ‘task, part of collective work’, *sana-* ‘content’, *san-fe* (content-take) ‘hunting bounty’, *mwa-n* ‘container’, as well as the items in Table 7.5, work the same way, with the exception that they can be omitted. The latter group thus seems to be frequent compound heads, described as generic-specific constructions (Aikhenvald 2000: 86), rather than classifiers. They are discussed in detail in §7.4.

7.3.1 Relational classifiers: Food

The members of this subgroup are all linked to special verbs (see Table 7.6) and cannot be omitted in favor of the modifying noun (i.e. the substance consumed). They are all inalienably possessed, and the substance they classify is invariably alienably possessed.

- (8) *Na li=vataan xhua-m (juu-mani)*
 DEM DEF.PL=various proteiny.food-2SG.POSS sacred-bird
 ‘These are your various dishes (of wood pigeons).’

- (9) *na li=vataan (*i) juu-mani*
 DEM DEF.PL=various DEF.SG sacred-bird
 ‘These are the various (live, or inedible) wood pigeons.’ (*not*: These are your pigeons to eat)

7.3.2 Relational classifier *ka*

Vamale has a morpheme *ka-* that takes inalienable possessive morphology, is used to mark usually unpossessed nouns as possessed (10), and contains semantic information about the relationship between possessor and possessum. The

Table 7.6: Classifiers, corresponding verbs, and corresponding food item

Classifier	Verb	Food item
<i>xhua-</i>	<i>xhwi</i>	‘(proteiny) food’
<i>fwaa-</i>	<i>fwai</i>	‘chewy food’ (e.g. magnagna root)
<i>xhuta-</i>	<i>xhuti</i>	‘scrunchy food’ (e.g. sugar cane)
<i>u-</i>	<i>xaje</i>	‘juicy food’ (fruit, vegetables)
<i>ya-</i>	<i>xhajake</i>	‘starchy food’ (tubers, rice, bread)
<i>fato-</i>	<i>fato</i>	‘hot drink’
<i>udoo-</i>	<i>udu</i>	‘cold drink’

morpheme is obligatory in certain scenarios but optional in others. I call *ka-* a relational classifier:² *ka* does not specify the nature of either noun phrase in the possessive phrase. However, the semantics of the classifier is somewhat vague and could be described as “relating to the possessor”, a term borrowed from the gloss for the relational classifier *’e* in Boumaa Fijian (Dixon 1988: 135). While Lichtenberk (2009) accepts such aberrant behavior for a classifier on the grounds that languages have unique categories, he mostly uses the term “possessive marker”. Another, perhaps simpler analysis would see *ka-* as a linker, following Brill (2012) among others: linking the head noun to its modifier, *ka* is semantically vague and closer to the head than to the dependent. *ka-* is obligatory for *daahma* ‘chief’ (11), *phwêêdi* ‘youngest child/sibling’, *bifidu* ‘twin’ and a few other nouns possessed through interpersonal relationships. The linker is in some cases part of a lexicalized possessive noun phrase (12, 13). It is also found on:

- *udee* ‘medication’, to introduce the ailment to be cured, e.g. *udee ka-n nyaabu* ‘medicine against mosquitoes’
- *juuju ka-m* ‘your truth, you’re right’
- *xhwata* ‘baldness, bald head’ e.g. *xhwata ka-m* ‘your bald head, you are bald’

Contrary to the relational classifiers in §7.3.1, *ka-* cannot be used anaphorically. Note that this lexically assigned, obligatory linker is distinct from the optional *ka-*

²Following Aikhenvald (2000: 136) and especially Lichtenberk (2009: 399).

7 Nouns

that can be added to any nominalization, which was described in §9.7.6. Apart from the form, the two morphemes share the alternation of the initial *k-* with nasals and non-velar plosives. If the stem ends in these consonants, /k/ is dropped: /kan/ → /an/ / N,p,t,l,c___. Given the similarity in shape and function, I suggest that the two are related.

- (10) *difaadi ka-n*
 echo REL.CLF-NSPEC
 ‘its echo’ [vamale-180727-elicitation-ganadd-1]
- (11) *daahma k-ong*
 chief REL.CLF-1SG.POSS
 ‘my chief’
- (12) *daahma ka-n mani*
 chief REL.CLF-NSPEC bird
 ‘chief of birds [*erythrura psittacea*]
- (13) *i ka-n xavwaxhan*
 louse REL.CLF-NSPEC dog
 ‘flea’

There are a number of irregular forms which show etymological final consonants that have since merged to the plosives *-t*, *-p*, *-k*, *-c* (see §5.2). For example, *fedat* ‘blood’, POc **daaR*, retains the historical liquid in the possessed form *fedal-am* ‘your blood’. The possessive morphology of these irregular forms follows the same laws (compare (12) to (14)) and is a predictable allomorph of *ka-*. In fact *ka-* only follows vowel-final possessums, whereas consonant-final words take *-an*, e.g. *japit/japit-an* ‘travel provisions; salary’. Prosodically, constructions with *ka-* have at least two p-words: the possessed NP, and *ka*, which can hence be analyzed as an anticlitic: not an own grammatical word (g-word), but an own phonological word (p-word) (Zúñiga 2014). However, the consonant-final possessed NPs only have one main stress, and thus count as a single p-word. *Fedalan*, for example, is split [‘feⁿ.da.lan], with the stress on the first syllable (see vamale-181020-01-batis-bonjour-tontons-1, 01:27). We thus have a situation where the same morpheme has a different phonological status depending on its host’s final form. It seems likely that the indirect possessive constructions with the linker *ka-* being an own g-word was the original situation, and that the linker was phonologically incorporated into the host for most contexts: *juujuu ka-m* (truth POSS-2SG.POSS) ‘you’re

right (not ‘your truth’), but *muliv-ong* (life 1SG.POSS) ‘I am alive’. Related to this, at least diachronically, are the possessive morphemes discussed in §9.7.6, though the latter are optional.

- (14) *i=a* *e-fii-kaa* *i=in-maa-n* *apuli ka*
 DEF.SG=REL RECP-sew-1PL.INCL DEF.SG=skin-face-NSPEC person CNJ
i=fedala-n *apuli*
 DEF.SG=blood-NSPEC person
 ‘What ties us together is the human skin and the human blood.’ [2018
 enterrement coutume présentation 1:28]

An ambiguous case is that of *mae* ‘fire, light’. Normally non-possessed, two possessive constructions are employed to talk about *mae* ‘lighter’, probably calqued from a local French term *feu* ‘fire; lighter’ (15). One is that of alienable nouns (e.g. *-n-eong*), and the other uses *ka*. Since there is a choice in the morphology to be used, *mae* is reminiscent of another relational morpheme: the optional, focussed possession marker *ka*, discussed in the following section.

- (15) *mae k-ong*
 fire CLF.POSS-1SG
 ‘my lighter (optional: *my lighter*)’
- (16) *mae-n-eong*
 fire-POSS-1SG
 ‘my lighter, my fire, my light’

7.3.3 Focussed Possession marker *ka*

ka is an optional preposition marking a possessor as focussed, and/or the possessum as especially important.³ Because it does not say anything about the nature of the possessor itself, I do not call it a possessor classifier (Aikhenvald 2000: 125). Instead, it seems more reasonable to call it a linker like the other *ka* forms, as *ka-* applies to alienable nouns and can be replaced by more conventional possessor marking (Aikhenvald 2000: 136). Contrary to the lexically assigned obligatory linker discussed in §7.3.2, this *ka* is optional, i.e. the noun can be marked as possessed by *-n* ‘poss’ instead (17). Furthermore, while the obligatory classifier uses inalienable possessive suffixes, e.g. *daahma ka-n/k-ong* ‘chief POSS-3SG.POSS/POSS-1SG.POSS’, *phwêêdi k-an/k-ong* ‘youngest child’, *ka* ‘FOC.POSS’

³Something similar is described as “close possession” in Hebrew (Berman 1978).

7 Nouns

takes nominal and pronominal possessors. Since the two morphemes are probably related and are identical in form and position, there is inter-speaker variation in their distribution: Jacob Oué maintains *thala k-ong* ‘my knife’ where Jean-Philippe Oué, about 20 years younger, uses *thala ka yo* (2019-08-05 JP ka:33). However, Philippe Gohoupe, born in the 1940s, uses *ka* with the pronoun *gavwe* instead of the suffix *-vwe* in (20), i.e. he uses *ka* ‘FOC.POSS’ like Jean-Philippe Oué.

(17) *thala-n i=xhaohmu*
knife-POSS ART.SG=elder
‘the elder’s knife’

(18) *thala ka i=xhaohmu*
knife FOC.POSS ART.SG=elder
‘the *elder*’s knife’
‘the knife belonging to the elder through his use of it’

Note the ambiguity between the 3rd person possessive *-n* shown in *daahma ka-n* ‘chief CLF.POSS-3SG.POSS’ and the anaphoric *-n* in (19), which I take as grounds to differentiate the two *ka*. *Udee k-ong* ‘medicine POSS-1SG.POSS’ is not attested.

(19) *cip=e-caihna-n hapi udee ka-n i=da hê*
NEG=1SG=know-NSPEC COMP medicine FOC.POSS-ANA DEF.SG=what yes
‘I don’t know what the medicine for it [mosquitoes] is, yeah.’ [AG1:212]

Beneficiaries, but not direct objects, can be focussed on with *ka* ‘FOC.POSS’, because the beneficiary constructions (§8.1.2) derive from *si-* ‘hand’ and *ko-* ‘on’, both taking possessors.

(20) *e=hole-ke nyasi-vwe ka=gavwe*
1SG=thank-TR for-2PL FOC.POSS=2PL
‘I thank you (in particular) [for what you did?].’

7.3.4 Noun classifiers

Noun classifiers, using Aikhenvald’s term and definition (Aikhenvald 2000: 81), are assigned based on semantics. Not every noun in Vamale takes a noun classifier (in fact, only plant species do). A plant species can take different noun classifiers, depending on the meaning intended. Similarly to relational classifiers, they can be used anaphorically, and indeed usually are (Aikhenvald 2000: 87) for a discussion of how typical this is). These noun classifiers are alienably possessed, but

rarely occur without their possessive suffix *-n* for reasons tied to their semantic nature: the possessor tends to be generic. *Yee* ‘tree’, and possibly *doo-n* ‘leaf’ are exceptions to this tendency. *Xhaapwe* ‘fruit’ occurs in the same environments as the noun classifiers shown in Table 7.7, but is not possessed with *-n*.

Table 7.7: Noun classifiers in Vamale

Form	Gloss
<i>doo-n</i>	‘leaf’
<i>i-n</i>	‘bark’
<i>vuki-n</i>	‘stem’
<i>ye(e)-n</i>	‘tree’
<i>muu-n</i>	‘blossom’
<i>si-n</i>	‘living branch’

Words for trees are always formed in the same way: *yee* ‘wood, tree’, followed by the species of the plant, e.g. *yee-n sep* ‘tree-poss coco’. The same goes for fruit (*xhaapwe sep*), leaves (*doo-n sep*), and bark (*i-n sep*). The word for the plant species alone denotes an abstract referent.

7.4 Compound nouns

Compound nouns are nouns with a nominal head and modifier (of verbal or nominal nature). Both noun-on-noun and verb-on-noun compounds may be exocentric, i.e. describing a referent not mentioned in the compound (e.g. *vaci nyu* ‘kernel/nucleus fish’ ‘anchor’), or endocentric, where a clue to the referent is present (e.g. *we jati* ‘water salt/sea’ ‘seawater’). Similar constructions with verbal heads are discussed in §9.6.3.

Other ways of modifying a noun are relative clauses, and possessive constructions. While these also result in a noun phrase which acts as a single constituent (21), compound nouns are single words: they do not tolerate lexical insertions and often have idiosyncratic meanings (e.g. *hmape-thoatit* and *yeen-bwan* in ex. 21). Compound nouns may be exocentric, use metaphors to describe their referent, or harbor other semantic relations not found in noun phrases with a relative clause, e.g. part-of-whole ones. However, in many cases there are no phonological, morphological, or syntactic ways to clearly differentiate compound nouns from unmarked noun - relative clause constructions.

Indeed, stress is no distinguishing indicator, as both the elements of complex nouns as well as those of noun phrases are stressed like single words (e.g. *apuli Teganpaik* [ˈapu.li ˈtʰegãnˈpa:ik] ‘Teganpaik resident’ and *hmape-thoatit* [ˈmãpe ˈtʰɔ.a.tit] ‘cloud’), a phenomenon also attested in Nêlêmwa (Bril 2004c: 204). The prosodic domain above the word-level seems to stress the modifier over the modified, again regardless of the syntactic nature of the construction.

- (21) *a=xaleke* [[[*hmape-thoatit*] *a fiing*] *a kon nyasipoke*] *nya-pwa-n*
 3SG=see flesh-sky REL dark REL PROG gather LOC-ON-NSPEC
yee-n-bwan
 stick-POSS-mountain
 ‘She saw dark clouds gathering on the mountain tops.’ [GC:13]

Many former possessive noun phrases have become lexicalized into compounds and denote a single referent, e.g. *mwa-n nyama* ‘glasses (lit. container-poss eye)’.⁴ Similarly, some noun phrases have been lexicalized that are formed with *ko-n* ‘on-NSPEC’, discussed in §8.4.4. *Ko* is otherwise productive to express part-of-whole relationships: compare established, opaque *bucit kon xhan* ‘joint? on leg’ ‘ankle’ to transparent *fubuun ko-n uvu* ‘heap on-NSPEC yam’ ‘heap of yam’, and newly coined *chambre-â-air ko-n velo* ‘air chamber on-NSPEC bicycle’ ‘bicycle tyre’. Both the constructions with possessive *-n* and those featuring the preposition represent a middle ground between noun phrases and compound nouns, as they are not single words phonologically, and are transparently derived. This grammar arbitrarily calls the complex nouns which still bear possessive morphology “compound nouns” proper, as they constitute the majority of forms, and the ones without such traces, e.g. the ones in Table 7.8, “bare compound nouns”. There does not seem to be a semantic logic behind which words form bare compounds and which bear possessive morphology. While the distribution hinges mostly on the modified noun, there are nouns showing both patterns (e.g. *fwa-n bua-n* ‘hole-poss ?-3SG.POSS’ ‘navel’ but *fwa thâ-n* ‘hole excrement-3SG.POSS’ ‘anus’). Nor is alienability of the head noun a criterion, compare inalienable *nyivwa-n goakan* ‘mouth-poss middle’ ‘window’ to alienable *vaaya-n goakan* ‘movement-poss middle’ ‘see-saw movement, rocking movement’. A tentative explanation would combine:

1. lexically defined distribution (i.e. it depends on the word, e.g. *vaci* ‘hard bit, nucleus’)

⁴Interestingly, *nyamaa-* is inalienable and would usually carry a possessive suffix. It is also shorter in the compound than in its possessed form.

2. avoiding ambiguity with similar-looking words (*we* ‘water’ never takes *-n* in compounds because *wee-n* ‘sap, fluid’ already exists)
3. lexicalization leads in some cases to the loss of *-n* (perhaps *fwa-thâ-n* ‘anus’)

Compound nouns can be classified via several dimensions: semantic properties (endocentric vs exocentric, and the semantic relationship between the components), morphological properties (i.e. whether possessive morphology is present within the compound, as discussed above), possessive strategies (i.e. how a compound is possessed by an outside participant), and word-classes represented.

Possessive morphology docks onto the right border of the compound, except if the first noun is inalienable, and the second part not a noun, e.g. *vabu-ng thamo* ‘grandchild-1SG.POSS woman’ ‘my granddaughter’. Regarding word-classes, the main types are N+N, N+V, and V+N. In some cases, compounds integrate yet another compound, which yields more complex forms, e.g. [*mwa*] [*cabi* [*vai-vun*]] ‘house smash stone-blue/green’ ‘prison’ (colonial prisons employed forced labor). Nominal compounds containing adverbs are present in related languages (Bril 2004c: 200) and have semantic equivalents in Vamale, but are not necessarily compounds, syntactically speaking (see §7.4.2). The intensifier *juu* ‘very, real, sacred’ is a very common part of compounds as well, e.g. *juu mwa* ‘traditional house’, *juu apuli* ‘Kanak’, *juu toot* ‘thatching straw’ etc.

7.4.1 N + N compounds

Noun-on-noun compounds include many examples of a semantically vague head which is followed by a modifying noun with a more precise or specific meaning. Contrary to a possessive construction, the resulting compound cannot dispense with the modifier, and would lose its meaning entirely if the head stood alone. For example, when talking about sewing (*sili*), one could not use *vaci* ‘nucleus, most important part’ and expect people to immediately grasp that one is talking about the thread (*vaci sili*). See Tables 7.8 and 7.9 for lists of compounds affected by this.

Many complex or abstract concepts are described via compounds, and use metaphors for a part of it: *duu-n we* (bone-POSS water) ‘water current’.

7.4.1.1 Endocentric N+N compounds

A special group of endocentric noun-on-noun compounds use modifying nouns like *thamo* ‘woman, female’, *xayu* ‘boy, male’, *xhaohmu* ‘elder, be old’ and *xawe*

7 Nouns

Table 7.8: Compounds with *vaci* ‘nucleus, most important part’

Form	Meaning second morpheme	Meaning of compound
<i>vaci nyu</i>	‘fish’	‘anchor’
<i>vaci nyima-n</i>	‘heart-3SG.POSS’	‘darling’
<i>vaci xayu</i>	‘male’	‘little boy’
<i>vaci uvu</i>	‘yam’	‘yam tuber’
<i>vaci nyivwa-n</i>	‘mouth-3SG.POSS’	‘tooth’
<i>vaci bwa-n</i>	‘head-3SG.POSS’	‘his cranial box (round part)’
<i>vaci sili</i>	‘sew’	‘sewing thread’
<i>vaci mata</i>	‘sing’	‘musical theme’
<i>vaci vua</i>	‘net’	‘net sinker’

Table 7.9: Compounds with *maan* ‘face, tip’

Form	Meaning of	
	other morpheme	compound
<i>maan hmeewan</i>	‘sand’	‘tip of a sandbank’
<i>maan op</i>	‘(high) tide’	‘waves touching the shore, tip of the tide’
<i>maan da</i>	‘spear’	‘spear tip’
<i>cu-pwan maan</i>	‘standing-on’	‘stand in front of something’
<i>fwa-n maan vua</i>	‘hole X net’	‘net mesh’
<i>nyau maan</i>	‘bad’	‘ugly’
<i>se maan</i>	‘one’	‘same, to repeat’
<i>in maan</i>	‘leather, bark’	‘human live skin’

‘youth, be young’. These are often predicates, and (at least the latter two) are also attested as stative verbs, e.g. *mani-thamo* ‘female bird’, or *i thamo-xhaohmu* ‘the old woman’. The same meaning is achieved with a relative clause, e.g. *i thamo a xhaohmu*. A relative clause consisting of a nominal predicate, a stative or intransitive verb, or with an inanimate or generic subject (meaning the relativizer *a* and *a* ‘3SG’ are juxtaposed), may omit the relativizer, especially in fast speech. Some compounds contain elements that are found nowhere else, e.g. *thivaan sin* ‘smallest finger’ (*thivaan* is opaque), *bu-cit ko-n xhan* (? on-NSPEC leg) ‘ankle’, and *bu-vaci xhan* (?-nucleus leg) ‘ankle (bone?)’. Some metaphorical terms for body parts are listed in Table 7.10.

Table 7.10: Body parts described metaphorically by (the head of a) compound

Form	Meaning of	
	other morpheme	of compound
<i>futho kon xha-n</i>	plantain on leg-3SG.POSS	‘calf’
<i>we-n ma iila</i>	water-POSS COM pot	‘part of the sole that does not leave a footprint’
<i>vi-n sep</i>	shell-POSS coconut	‘kneecap’
<i>bet ca-n duu-n</i>	worm in-NSPEC bone-3SG.POSS	‘bone marrow’

7.4.1.2 Exocentric N + N compounds

Exocentric N+N compounds, the smaller of the two noun-on-noun groups, have more or less opaque meanings. They may describe the referent’s appearance:

- *bwa-n ibwen* ‘head-POSS squid’ ‘a species of deadwood mushroom’
- *ot-an-bwa-n thupila* ‘belt-POSS-band-POSS devil’ ‘devil’s headband’, an orange *nyaouli* savannah vine’
- *tha-n mutô* ‘excrement-POSS sheep’ ‘a species of grass’

The compounds may also describe a purpose of the referent:

- *thili thâ* ‘wipe excrement’ ‘a species of grass’
- *dipi maphwên* ‘wrap leftovers’ ‘a species of tree’

7 Nouns

- *fa-mulip* ‘CAUS-life’ *plectranthus parviflorus*, a medical plant’

Table 7.11 lists other terms describing the function, origin, or other association. Not all of them are compounds.

Table 7.11: Concepts described by their function, origin, or other associations (e.g. toxicity).

Form	Meaning of	
	other morpheme	of compound
<i>ye iila</i>	tree pot	‘tree (whose fruit were used as a container)’
<i>xhwaeo pupwaale</i>	taro European	‘dry taro (imported by Europeans)’
<i>dongan thupila</i>	orange corpse	‘ <i>citrus macroptera</i> (toxic when raw)’
<i>mwa-n suhmee</i>	container-POSS spit	‘lung’
<i>mwa-n gila</i>	container-POSS bitter	‘gallbladder’
<i>mwa-n nyai-n</i>	container-POSS child-3SG.POSS	‘uterus’
<i>fwa-thâ-n</i>	hole-excrement-3SG.POSS	‘anus’
<i>xa-funa</i>	AGT.NMLZ-preach	‘middle finger’
<i>ape-tha-xhuuni</i>	NMLZ-throw-spear sling	‘index finger’

7.4.1.3 Compounds with two heads

Additive noun-on-noun compounds, where the sense depends on both, equal elements, are rare, but exist, e.g. *bween phwê* ‘night month’ ‘date (specific day decided upon)’.⁵

7.4.2 The question of Noun + Adverb compounds

While noun-and-adverb compounds were described for other languages of the area (Bril 2004c: 192, 200), this work could not find any which were distinguishable from noun phrases that are modified with an adverb, as the latter’s position is identical in both cases, and prosody is the same in compounds as it is in

⁵ *bwen* ‘night’ is lengthened, a hint at its possessum origin, see *iila*, *iloo-ng* ‘cauldron, my cauldron’ in §7.2.

complex noun phrases. One distinguishing feature of other noun compounds includes the use of words that have otherwise fallen out of use, a lack of possessive morphology, or an unusual word order. None of this was found with adjectives modifying nouns. Furthermore, noun phrases containing an adverb can be modified by a relative clause (22). However, since relative clauses modify single-word nouns as well as noun phrases (to which an adverb can belong), no convincing syntactic arguments seem to posit the existence of said compounds.

- (22) *li=xhaohmu habu^{adv} a vwa wada-le*
 DEF.PL=elder long.ago REL EXIST gun-3PL.POSS
 ‘the elders of yore who had guns’

7.4.3 N + V compounds

A major group of compound nouns featuring verbal elements put the noun first. The noun is then described by the verb, which denotes a property, state, or function of the noun.

- *mwa-n vwa-ila* ‘house-POSS do-pot’ ‘cooking house, i.e. kitchen’
- *mwa-n sohmun* ‘house-POSS study’ ‘school’
- *tii siteke* ‘notch, writing sacred’ ‘the Bible’

Stative verbs in general tend to signify properties or states, and the nominal part of the compound usually refers to the bearer of these properties: *we nyam* ‘water sweet’ ‘sweetwater’. While almost all compounds contain intransitive verbs, I found one exception (23). The verb here has a similar function to the intransitive verbs described above, i.e. it assigns a property to the noun.

- (23) *fwa-n titii-ke*
 hole-POSS be.wet-TR
 ‘moist spot, buried spring’

7.4.4 V + N compounds

While the majority of nominal compounds featuring verbs put the nominal head first, another group put the noun second. Many of these are derived verb phrases, like the endocentric metonymic compound *vun muun* ‘blue/green flower’ (a species name for a blue flower), the exocentric word for humpback, *xhwe duun* ‘twisted back’, or *fun aman* ‘wilt something’ ‘dry season’.

7 Nouns

Others are more opaque, e.g. the metaphor *vun bwān-toot* ‘blue grasstips’ ‘blue hour, briefly before nightfall’. Consider the exocentric compounds naming the days of the week:⁶ Monday to Thursday count the days passed since Sunday (see Table 7.12). The word for Friday, *fa-siit*, is likely derived from the Christian taboo of eating meat on that day: the causative prefix *fa-* docks into *siit*, likely related to *sitoo* ‘taboo’ and *siteke* ‘sacred, forbidden’.

Table 7.12: Days of the week

Sunday	<i>vwa siteke</i>	‘do sacred, pray’
Monday	<i>se vwa-siteke</i>	‘one [day after] Sunday’
Tuesday	<i>thalloo vwa-siteke</i>	‘two Sunday’
Wednesday	<i>thiien vwa-siteke</i>	‘three Sunday’
Thursday	<i>fava vwa-siteke</i>	‘four Sunday’
Friday	<i>fa-siit</i>	‘CAUS-?’
Saturday	<i>savato</i>	(from <i>sabbat</i>)

Other exocentric nominal compounds also include *vwa* ‘do; EXIST’:

- *vwa det* ‘make rustling sound’ ‘dead coral bits on a beach, or as a floor covering’
- *vwa jinun* ‘EXIST magical power’ ‘sorcerer, magician’
- *vwa wii-an* ‘EXIST field-3SG.POSS’ ‘shaved head’

This chapter has covered simple nouns, their syntactically relevant semantic features and how possession works. After discussing complex nouns, many of which stem from noun phrases, the account shall now move on to noun phrases proper.

⁶The week is called *da(wee)n vwa siteke* ‘between prayers’, itself an exocentric compound derived from a prepositional phrase.

8 Noun phrases

Vamale noun phrases, like verb phrases, are head-initial. Thus, noun phrases are composed in the following way: ART=PSM ART=PSR, optionally with relative clauses following each noun. Clitics flag noun phrases that are not object arguments, or unmarked intransitive subjects. Noun phrases display nominative-accusative alignment. This is typical of canonic Oceanic languages (Ross 2004: 495). Free pronouns can be flagged, like nouns, for the roles of transitive subject and intransitive subject, both obligatorily with *ka* ‘SBJ’, while nouns can omit *ka* in intransitive scenarios, see (1). Personal pronouns can be flagged as oblique, but they cannot be used as undergoer arguments, contrary to nouns and demonstrative pronouns, e.g. *ena* and *nienaen*. Flagging is discussed in §8.1.

- (1) (No *ka* before *hmape-thoatit* ‘cloud’)

cama vi hapi a=moo a=sibu ta-me ka i=jati
 SUBR say COMP 3SG=stay 3SG=swell go.up-DIR.CP SBJ DEF.SG=sea
nya-xahut hai cama hu-pe ca=hmape-thoatit a=
 towards-down.there or if come.down-DIR.CP INDF.SG=flesh-sky REL=
xada
 up.there

‘If one said (=let’s imagine) that the sea down there should swell and rise, or that some cloud up there should come down [and shatter us, we shall still do custom]...’ [CP2:7]

In unmarked scenarios, *p* and *s* are marked the same way, meaning that both undergoer and intransitive subject noun phrases follow the verb without flagging, as shown in (2, 3). Transitive subject noun phrases (A), by contrast, are obligatorily marked by *ka* ‘SBJ’ (4). This yields a tripartite alignment for nominal flagging, see Figure 8.1. The particle *ka*, however, may also occur optionally with *s_A* and *s_p* (hence the gloss ‘SBJ’). Note that this optional focusing use is not described for other languages in the area, suggesting it might be a relatively recent development.

- (2) [*a=han* [*i=xhaohmu*]]
 3SG=walk DEF.SG=elder
 ‘[The elder] walks.’

8 Noun phrases

- (3) [$a_i=xaleke$ [$i=xhaohmu$] $_{ii}$]
3SG=see DEF.SG=elder
‘[S/he] $_i$ [sees [the elder] $_{ii}$].’
- (4) $a=xaleke$ $i=xhaohmu$ $ka=ya$
3SG=see DEF.SG=old SBJ=3SG
‘He sees the elder.’

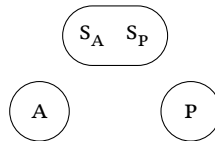

Figure 8.1: Alignment of noun phrase flagging

Noun phrases can be formed by nouns, which were discussed in the previous Chapter 7, but also by personal and demonstrative pronouns, which are described in §8.2. Apart from possessive constructions, discussed in the previous chapter (§7.2), nouns are chiefly modified by verbs and relative clauses. §8.4 explores the morphemes within a noun phrase that modify the head, including adjective-like derivations (§8.4.6). Noun phrases can be coordinated and form a new constituent. Vamale distinguishes at least three: the comitative *ma*, the additive coordinator *ka* ‘also, on top of that’, and *hai* ~ *a* ‘or’. They are all described in §8.5.

8.1 Case marking

Case in this grammar refers to the marking of syntactic roles by morphemes. Vamale, like most Oceanic languages (Lynch et al. 2002: 37, Ross 2004: 496), does not mark syntactic roles on nouns with affixes. There are, however, prepositions that “flag” the subject (*ka*) and optional, oblique arguments (*(nya)ko*). The choice of the morphemes is influenced by semantic and pragmatic factors: transitive subject noun phrases must be preposed by *ka* (further discussed in §8.1.1), whereas intransitive subject nouns may take *ka* in focused contexts. Oblique markers distinguish beneficiary and goal arguments from more generically patientive ones (see §8.1.2), and are sensitive to the animacy of the argument.

8.1.1 Agentive marker *ka*

This *ka* is a subject marker (6).¹ Its allomorph *a* is conditioned by a final consonant on the preceding word. It is obligatory before nouns and pronouns that agree with the verb in an A function, probably because unmarked transitive subjects can occur at the very end of long VOS sentences, and directly after an object noun phrase:

- (5) V (VV...) O *ka* A.

A clitic *ka* is optional for S_{A/P}, probably in an extension of the first scenario. In principle, Vamale participant flagging is a tripartite flagging system, since it disambiguates A, which must take *ka*, from S, which may take *ka*, from O, which may not take *ka* (see Figure 8.1).

- (6) [*e=xaleke* *i=jili* *i=bwaakala*] *ka* *yo*
 [1SG=see DEF.SG=[build_with_wood DEF.SG=canoe]] SBJ 1SG
 ‘I see the building of the canoe.’

Contrary to A arguments, which have to be marked with *ka* unless fronted and thus not part of the clause anymore (e.g. *yo, e=xale-a* ‘me, I see them’, see §8.3), S arguments do not have to be marked with *ka* (7).

- (7) *a=hup-wa* (*ka*) *i=jati*
 3SG=go.down-REP (SBJ) DEF.SG=sea
 ‘The tide goes down again.’
- (8) *sinu* (*ka*) *mu=xho-ng*
 suffer (SBJ) DEF.DU=leg-1SG.POSS
 ‘My legs hurt.’ (no index on *sinu* because it is a stative verb)

In nominalizations as well, *ka* ‘SBJ’ obligatorily occurs to mark A (9, 12). P may take a different *ka* ‘LINK’ when it is the only participant present in the construction (10). If several participants co-occur, this option disappears, as the clause would otherwise become confusing. As this *ka* only marks S and P, I gloss it subsequently as absolutive (see §9.7.6).

- (9) *i=hun-saxhuti* *i=jaxhut* *nyanya-n-eong* *ka*
 DEF.SG=NMLZ-narrate DEF.SG=story mother-POSS-1SG.POSS SBJ
caacaa-n-eong
 father-POSS-1SG.POSS
 ‘my father’s way of telling my mother’s story’

¹The Pije cognate to the agentive marker is *lu*.

8 Noun phrases

- (10) *i=hun-vii* (*ka*) *i=jaxhut*
DEF.SG=NMLZ-say LINK DEF.SG=story
'the way to say the story'
- (11) *i=hun-moo* (*ka*) *i=mwa*
DEF.SG=NMLZ-be LINK DEF.SG=house
'the nature of the house'
- (12) *i=hun-xale-a* *ka yo*
DEF.SG=NMLZ-see-3OBJ SBJ 1SG
'my way of seeing him (lit. the way of seeing him by me)'

The construction in (13) is a more colloquial way of asking for the agent of an action and skips the usual pronoun *kai* 'who?'.

- (13) *na a=nya ka?*
DEM 3SG=put SBJ
'This, who put it there?' [J8:35]

8.1.2 Oblique markers

Vamale, like most canonic Oceanic languages (Ross 2004: 510), has no ditransitive verbs. Benefactive scenarios are expressed either with verb phrases or with the prepositions already mentioned in §6.8. Four forms add a noun phrase to a verb phrase: *nya* 'Beneficiary, Goal' (from the verb 'put, send, give'), *si-* 'Recipient (human), Topic (human), Experiencer (animate), Goal (animate)' (from the noun *si-* 'hand'), *ko-* 'Ground, Theme, Stimulus' (from the preposition 'on'), and the combined forms *nyasi-* and *nyako-* 'give, for' discussed in more detail in §8.1.2.2. In all cases, the added NP can be omitted, as in *e (ila-ke) xaxhi/haxhi (nyakoo-n)* 'I (demand-TR) forgiveness (for X)'. I thus argue that there are no indirect arguments in Vamale. Every NP introduced with *nyako/nyasi*, *ko* or *nya* can be omitted without violating the verb's valency. This grammar will speak of oblique and (core) arguments.

8.1.2.1 Benefactive *nya*

Most *nya* forms are verbs and head a phrase themselves (14). However, *nya* may also act as an oblique marker and introduce a noun phrase. Since no non-contiguous serial verb construction (s)VoVo is otherwise attested in the language, (16) is analyzed as a verb phrase *vwa ena* 'do this' and the animate beneficiary

marker *nya*, which introduces the pronoun *kai* ‘who’. *Nya* is also used as a spatial preposition meaning ‘towards’ (§10.4.1).

- (14) *nya-a-me!*
 send-move.same.level-DIR.CP
 ‘Give it to me!’
- (15) *a=nya li=sale=ka-n (nya)si li=apuli*
 3SG=put DEF.PL=possession=POSS-3SG.POSS BEN DEF.PL=person
 ‘He gives his goods to the people.’
- (16) *go=vwa ena nya kai?*
 2SG=do DEM.DIST give who
 ‘For whom do you do that?’

8.1.2.2 Oblique markers *nyako-*, *nyasi-*

The prepositions *nya-si* ‘Recipient (human), Topic (human), Experiencer (animate)’, *nya-ko* ‘Recipient, Topic, Experiencer’ are composed of the other three oblique markers *nya* ‘put, BEN’, *ko-* ‘on, OBL’ and *si-* ‘hand, BEN’. They are derived from inalienable nominal forms (but do not take articles) and, similarly to locative nouns (see §6.5.2), can have generic (-*n*) or specific possessive markers (e.g. -*ng* ‘1SG’, -*m* ‘2SG’).

There are two main differences between *nyasi* and *nyako*. *Nyasi* is restricted to animate participants, even human ones for some meanings, and suggests a less direct involvement of the marked NP: questions, demands (17) and gifts (18) are the main contexts in which it appears. The main difference between *si* and *nyasi* seems to be that *si* marks the beneficiary of an already benefactive action (19), whereas *nyasi* can add a beneficiary argument to any verb, see (20).

- (17) *e=ila-ke nyasi-m i=vai*
 1SG=make.request-TR BEN-2SG.POSS DEF.SG=stone
 ‘I (politely) ask you for the stone (lit. I request the stone from you).’
 [B2:100]
- (18) *a=nya li=saleka-n si li=apuli*
 3SG=give DEF.PL=property-3SG.POSS BEN DEF.PL=person
 ‘He gives his things away to the people.’ [J7:14]

8 Noun phrases

- (19) *go ha-me saaguu-be see-me si-je mwa ca thôa*
 CNJ GO-DIR.CP support-1PL.EXCL same-all BEN-1PL.INCL DEICT in work
koo-n

OBL-ANA

‘Now, come join to help us (EXCL) to the benefit of us all (INCL) in this customary labour.’ [Bw:35]

- (20) *ta-xhavwaleke ma gase=bo vwa nyasi-le*
 sitting-wait SUBR 1PL.INCL=IRR do BEN-3PL

‘(They) sit around waiting for us to do it for them.’ [GB:17]

Similar in functions, *nyako* is generally more common, as it marks human and non-human participants alike. Similarly to *ko*, *nyako* can introduce a Stimulus (23). *Nyasi* is also only attested once for the function of topic marker, and was in a fronted position: *nyasi Leenhardt, cip=e xa-xale-a* ‘concerning Leenhardt, I never saw him’ (48). *Nyako* is an unmarked particle to introduce a topic (22).

- (21) *tha lu=mata nyasi i=jamwa-n sohmu-n*
 ASS=3DU sing for DEF.SG=father-POSS study-NSPEC

‘They sing for the teacher.’

- (22) *tha lu=mata nyako i=jamwa-n sohmu-n*
 ASS=3DU sing OBL DEF.SG=father-POSS study-NSPEC

‘They sing about/to the teacher.’

- (23) *e=vwa xaleke nyako li=mwani-n-eong*
 1SG=do buy for DEF.PL=money-POSS-1SG.POSS

‘I do (buy) according to my means.’ [vamale-181107-jpnelemwa-06_LR
 0:12:24-0:12:26]

8.1.2.3 Oblique marker *ko-*

The preposition *ko-* introduces mainly instruments to the verb phrase (see (24) and (25)), as well as other oblique noun phrases: Stimulus (26, 28), Themes (31) and Ground (e.g. *bitake ko-n koltaa* ‘turn around on the street’²). They are called oblique here, because the verb phrase remains grammatical without the noun phrase introduced by *ko-*. A nominal modifier construction with *ko-* is described in §8.4.4.

²*bitake* ‘rotate on a flat Ground’ takes a *ko-*marked oblique noun phrase when the Ground is specified.

- (24) *e=kon udu ko-n bia*
 1SG=PROG drink.cold OBL-NSPEC beer
 ‘I am getting drunk with beer.’ [2019-07-25 JP *grammaire*:16]
- (25) *a=vi nyakoo-be nyima-n ma yaai ko-n thala*
 3SG=say OBL-1PL.EXCL will-3SG.POSS SUBR saw OBL-NSPEC knife
 ‘He told us that he wants to cut it by knife.’ [GP:78]
- (26) *e-sinu-o koo-n*
 MID-suffer-1SG OBL-ANA
 ‘I suffer from it.’ [G5:51]
- (27) *yo hmwet-eo ko i=vaya-ca*
 1SG tired-1SG OBL DEF.SG=work-PROX
 ‘I am fed up with/tired of this work.’ (in local French: *je suis fatigué de ce travail*) [X9:25]
- (28) *Abe=holeke nya-koo-m au Nyaanya ko li=vaaya a=*
 1PL.EXCL=thank.for put-on-2SG oh Mummy OBL SPEC.PL=work REL=
go=vwa cahni Bako
 2SG=do here Bako
 ‘We thank you, oh Mommy, for the works you did here in Bako.’
 [2017-07-21 *Chant de deuil*:8-9]
- (29) *go=see ko i=da?*
 2SG=cry OBL DEF.SG=what
 ‘Why do you cry?’

While there are adjuncts introduced by *ko*, notably causes (19) and locations (30), the ones I call oblique are semantically specified by the verb. For some verbs, noun phrases introduced by *ko* have become core arguments and are not omisable without changing the meaning (e.g. (*vwa*) *icu* ‘barter (intransitive)’, *icu-ko* ‘sell’ in (30)). This scenario is discussed in more detail in §9.3.1.3. This inalienable *ko-* is not to be confused with the conjunctions *ko* ‘but’ and *kon* ‘and then’ (30), the progressive particle *kon* (24), nor with the subordinator *ko* ‘because’, discussed in §14.1.5.

- (30) *kon tha=abe=saavi cama=be icu-koo-n ko-n marché*
 CNJ ASS=1PL.EXCL=dig.up if=1PL.EXCL barter-OBL-ANA ON-NSPEC market
 ‘And then we dig them up whenever we sell them at the market.’ [AG1:22]

- (31) *ko na kai a=eca-kau ko niena-aen*
 but DEM who REL.3SG=learn-2DU OBL DEM.PL-DIST
 ‘But who taught you all this? (lit. but this who that teach you about this)’
 [GC:81]

8.2 Pronouns

There are three types of openly expressed arguments. The free form, called “pronoun” here, can be fronted, take the agentive marker *ka* and the beneficiary *nya*, is used to call people, for topicalization, and often occurs in imperatives. This group includes personal pronouns (§8.2.1, listed in Table 8.1), demonstrative pronouns (§8.2.2), and stand-in question words *kai* ‘who’ and *da* ‘what’ (32). The latter can take a singular article in marked scenarios, see (33).

Table 8.1: Free pronouns

	1 (EXCL)	1+ (INCL)	2	3
SG	<i>yo</i>		<i>go</i>	<i>ya</i>
DU	<i>abu</i>	<i>gasu</i>	<i>gau</i>	<i>lu</i>
PL	<i>abe</i>	<i>gaa</i>	<i>gavwe</i>	<i>le</i>

- (32) *ko go=vii da?*
 CNJ 2SG=say what
 ‘But what are you saying?’ [X1:1]
- (33) *gaa tha gase=juu tena go tha gase=thii mae ka*
 1PL.INCL ASS 1PL.INCL=real listen then ASS 1PL.INCL=light fire CNJ
a=bo xahnang i=da?
 3SG=IRR good DEF.SG=what
 ‘We’d listen well, and we’d light fires [anyway] and what’s supposed to be good then?’ [RP:14]

The other forms are bound (Table 8.2). s_A participants are indexed on the predicate by proclitic particles called “bound pronouns”. s_P participants are indexed on stative verbs via suffixes, as are undergoers. They will be further treated in Chapter 9.

Table 8.2: Subject and object markers for active and stative verbs

	Free form	A=/S _A =	-S _P	-P
1SG	<i>io</i>	<i>e</i>	<i>-o(ng)</i>	<i>-o</i>
1DU.INCL	<i>gasu</i>	<i>gasu</i>	<i>-gasu</i>	<i>-kaeu</i>
1PL.INCL	<i>gaa/gase</i>	<i>ga(se)</i>	<i>gaa</i>	<i>-kaa</i>
1DU.EXCL	<i>abu</i>	<i>abu</i>	<i>-abu</i>	<i>-(a)bu</i>
1PL.EXCL	<i>abe</i>	<i>abe</i>	<i>-abe</i>	<i>-(a)be</i>
2SG	<i>go</i>	<i>go</i>	<i>-go</i>	<i>-ko</i>
2DU	<i>gau</i>	<i>gau</i>	<i>-gau</i>	<i>-kau</i>
2PL	<i>gavwe</i>	<i>gavwe</i>	<i>-gavwe</i>	<i>-kavwe</i>
3SG	<i>ia</i>	<i>a</i>	<i>-(e)a</i>	<i>-(e)a</i>
3DU	<i>lu</i>	<i>lu</i>	<i>-lu</i>	<i>-lu</i>
3PL	<i>le</i>	<i>le</i>	<i>-le</i>	<i>-le</i>

There is a difference in marking between s_p , s_A/A , and p , leading to a tripartite split S alignment in the marking of participants on the predicate. The undergoer markers are also bound pronouns, because they are in complementary distribution with undergoer NPs, meaning that either the object of the verb is expressed openly (34), in which case the verb may bear a transitivity marker, or the object is expressed by the suffix (35), in which case no open object NP may follow (36).

(34) *a=xaleke i=pupwaale*
 3SG=see DEF=European
 ‘He sees the European.’

(35) *a=xale-a*
 3SG=see-3SG
 ‘He sees him.’

(36) **a=xale-a i=pupwaale*
 3SG=see-3SG DEF=European
 (‘He sees the European.’)

Following Kroeger, a syntactic function is unique to one argument (Kroeger 2004: 20). Since free pronouns are noun phrases, they cannot coexist with the noun with which they would share a referent in the same clause.

8.2.1 Personal pronouns

The “subject markers”, as they are called in the literature on New Caledonian languages, are obligatory and not in complementary distribution with open noun phrases possessing the same referent. This may be due to the basic word order VOS, where the object follows the verb immediately, but the subject may need a “reminder” at the beginning. This means that they are not pronouns in the traditional sense. They occur before aspect markers, and are proclitics which attach to predicates. They are listed in Table 8.2.

Dual personal pronouns, as well as dual articles, are used for polite speech: while *gau* 2DU is used to politely address a single person, thus augmenting their importance, *muca* INDF.DU is used in offering things, to diminish the size of the offer, as in (37).

- (37) *fe muca=nyu!*
 take INDF.DU=fish
 ‘Take some fish! (more than two)’

Dual pronouns, and plural pronouns, are used differently than in European languages when including someone with the addressee, i.e. ‘with whom did you go?’ or ‘you and your uncle’s village’ (38).

- (38) *i=bwanpu-n-abu ma vwoon-ong*
 DEF.SG=COUNTRY-POSS-1DU.EXCL COM uncle-1SG.POSS
 ‘my and my maternal uncle’s village’ [vamale-181107-jp_nelemwa-06:
 00:12:56-00:12:58]

8.2.2 Demonstrative pronouns

Demonstrative pronouns in Vamale distinguish number: those prefixed with *e-* are the singular forms,³ those with *ni-* the plural, and with *mu-* the dual forms. The dual forms are rare. The forms are listed in Table 8.3. Note that the plural forms feature two transparent morphemes: the plural *ni-* and the proximal/distal suffixes *-hni* and *-na* which are also found in the verb *hmwa-ehni* ‘be.like-this’ and *hmwa-ena* ‘be.like-that’. The third part of the plural pronouns is a non-transparent *-e-*. This may be a former singular prefix, as is still featured by the singular forms, onto which a plural morpheme would have been prefixed without replacing it, possibly meaning that *niehni* was formed much later. On the

³Possibly derived from the singular article *i*. Both *vi* ‘DEF.SG’ and *ve-hni* ‘DEM.PROX’ are attested in older speakers.

other hand, *ehni* is still pronounced *vehni* by elders, and the singular article is still *vi* in comparatively archaic Vamale Usa, but *nivehni* is not attested anywhere. A simple epenthetic function seems unlikely given that the dual forms lack it.

Table 8.3: Demonstrative pronouns

	proximal	distal
SG	<i>e-hni</i>	<i>e-na</i>
DU	<i>muu-hni</i>	<i>muu-na</i>
PL	<i>ni-e-hni</i>	<i>ni-e-na</i>

The suffix *-hni* has the stative verb cognate *hni-* ‘proximal’ in Bwato (Rivierre & Ehrhardt 2006: 43). Rivierre calls demonstratives verbs (Rivierre & Ehrhardt 2006: 42), which makes sense given that they can take stative subject suffixes: *ehni-o* ‘here I am’. Its distal counterpart *-na* does not seem cognate to Bwato *hanaa-* ‘be here’, but could be cognate to *nai-* ‘recently mentioned’ (Rivierre & Ehrhardt 2006: 43). The latter verb *nai-* ‘recently mentioned’ is a possible hint at the real function of *-hni* and *-na*: the suffixes being able to distinguish between recently mentioned information and some that was mentioned longer ago, or not at all (but is general knowledge).⁴

(39) (Bwato)

go vwa ni ma-nai-a

2SG do DEF.PL NMLZ-recently.mentioned-3SG

‘Do these things!’ (Rivierre & Ehrhardt 2006: 43)

(40) (Vamale)

go=vwa li=aman-ca

2SG=do DEF.PL=thing-PROX

‘Do the things there.’

The pronouns are mostly used as topics or comments in equative constructions (41), though *ena* is also used to express agreement, like in English ‘exactly’. The latter use is also attested with *hmwaana* ‘be like that’. *Hmwaani* ‘be like this’ cannot be used to comment on a previous utterance. *-Na* and *-hni* may thus be more of an engagement-distinguishing pair than really about distance, i.e. mark

⁴Bwato furthermore has the stative verb *huta-* ‘below’ which does not find an exact counterpart in Vamale (see example 39) (Rivierre & Ehrhardt 2006: 43).

8 Noun phrases

whether something is close to the speakers' attention. The demonstrative suffixes *-ca* and *-aen* can take a similar function.

- (41) *tha pa i=hun-moo-o ve-hni*
 ASS PRF DEF.SG=NMLZ-be-1SG DEM-PROX
 'This is my (elder's) way.' (*pa* conveys that his life has come to this)
 [HC19:61]

niena 'DIST.PL' is the only form attested as *nienae*n with an additional *-aen* 'dist' suffix, which usually only applies to nouns, and has the idiosyncratic meaning 'all that', see (42). There is no equivalent *niena-ca* form using the nominal proximal suffix, which is reminiscent of the *ena/hmwaana* cases only using the more distal form for abstract functions.

- (42) *cahma niehni abe cabeen xhaohmu-n-go ja cip-abe yajooke*
 TOP DIST.PL 1PL.EXCL INDF.PL elder-POSS-2SG PRF NEG-1PL.EXCL attain
mwa nien-aen
 now DIST.PL-DIST
 'When it comes to these (works of our ancestors), we elders of yours
 already don't attain all of that anymore.' [CP1:49]

The prefix *me* 'all' is attested as a prefix to the demonstrative pronoun *ehni* (43), but no other nominal element. The related pre-verb *me* is discussed in §10.3.2.1.2.

- (43) *nyeet ca-n fava-vwasiteke na ca i=thuatit a=*
 when in-NSPEC four-pray DEM in DEF.SG=day REL=
le=fe-kaa ka me-ehni cahni pala-je
 3PL=take-1PL.INCL.OBJ SBJ all-DEM.PROX here home-1PL.INCL.POSS
 'When, on Thursday, it was on that day that those all came to fetch us
 here in our home.' [GP:2-3]

Related to *ena*, there is another, very common, form, *na*, which can only be used as the topic of a clause. Whether that clause is an equative construction involving only nominal phrases (including the demonstrative pronouns *ena* and *ehni*), or one with a verbal predicate, *na* comes first. The pronoun cannot be used for subjects in the traditional VOS word order, nor take flagging.

- (44) *tu vois, na tha cipa ca=aman a= le=thên thên ca-n*
 you see DEM ASS NEG INDF.SG=thing REL= 3PL=run run in-NSPEC

magasî. na le=vwa-suki lait.

shop DEM 3PL=do-price rice

‘You see, it’s not something they’d run run to the shop [for], they’d pay for rice...’ [KP:82]

The demonstrative *na* has a form used only in insistent scenarios, often associated with repetition: *ha*.

(45) *xa-vuki vai ko-n thexhwaade ha li=kalen*

AGT.NMLZ-stem rock at-NSPEC T. DEM DEF.PL=k.

‘The guardians of the Thexhwaade rock are the Kalens.’ [DP:12]

8.3 Fronting

The subject is often fronted, but may then still occur after the verb, indicating that a fronted subject is not a constituent of the clause.⁵ Fronting can be used to focus on any constituent, a resumptive morpheme remaining in the matrix clause. The topic markers *cahma* and *nyasi* may precede the fronted constituent (46, 48).

With most speakers, the particle is pronounced [tɕamã], but since two older speakers, Mrs. Madeleine Bonu Fouan and Mr. Philippe Dego Gohoupe (e.g. in (46)), pronounce it with an audibly voiceless nasal [tɕa^hɱa], I distinguish this word from *cama* ‘if, when.IRR’, which introduces subordinate and in subordinate clauses, but never a fronted noun phrase.

(46) *ka cahma yo, tha gavwe=paa hmaa-ko-ong naen gavwe bwa*

CNJ TOP 1SG ASS 2PL=PRF arrive-on-1SG now 2PL IPFV

hmaa-ko-ong ka pala

arrive-on-1SG CNJ talk

‘But me, you have found me now, you found me and [we] spoke.’

[HC19:59]

(47) *ca i=wadan-aen, cahma Xa-xhwi Apuli, [...] a=kon*

in DEF.SG=time-DEM TOP AGT.NMLZ-eat person 3SG=PROG

e-hnyimake ma a=xhwii-le hai ma a=cee-le ma le=han.

REFL-think SUBR 3SG=eat-3PL CNJ SUBR 3SG=leave-3PL SUBR 3PL=go

‘At this moment, Maneater wondered whether he was going to eat them or let them go.’ [GC:107]

⁵Prosodically, too, the fronted subject has an own contour, which yields two intonation units: the fronted subject, and the clause.

8 Noun phrases

- (48) *nyasi Leenhardt, cip=e xa-xale-a*
TOP L. NEG=1SG AGT.NMLZ-see-3SG.OBJ
'Concerning Leenhardt, I never saw him.' [HC1:36]

8.4 Modifying a noun

Noun phrases feature various words that modify their head: particles can be preposed to the noun, see *se* and *been* 'other' (§8.4.1), as well as the quantifying particles discussed in §8.4.2. Two forms, *vataan* 'each' and *me* 'all' are used (see §10.3.2.1), but also attested in noun phrases (*me* is restricted to pronouns) (49). A small sub-class of verbs is described in §9.2.1 that integrate the noun phrase. Nouns can be modified by other nouns and by relative clauses (§14.2.3), whose subordinating particle is introduced in §8.4.3. The prepositional noun *ko-* 'on' (§8.4.4) coordinates nouns into a possessive-like construction. Possessors are discussed in the chapter on nouns (§7.2). Finally, demonstrative suffixes, while not words, dock onto nouns and pronouns alike, and add information about the saliency or proximity of the word (§8.4.5).

- (49) *tha lu=tena nyasi li=vatan xhaohmu*
ASS 3DU=OBL DEF.PL=each elder
'They heard about the different/various ancestors.' [GT:6]

8.4.1 Particles *se*, *been* 'other'

Vamale features two function words that can both occur between the article and the noun, and act as a placeholder for the noun after the article. One is *se* 'other' (50). It is derived from the stative verb *se-* 'one, be one/the same' which can be used predicatively as well as attributively (51). *Se-* is also a preverb (see §10.3.2.1.1). *Se* is attested in two cases preceding definite noun phrases without *i* or *li/ni* (53, 54), but this use was not further investigated and must be left to future research. The other function word is *been*, derived from the noun *bee-n* 'peer-3SG.POSS' (52). Like *se*, it is not inflected. Both *se* and *been* are attested with indefinite articles as well (55). We thus find *i/eca se* 'the/some other', *li/mu/muca/ca been* 'the/some others'. Both *been* and *se* have a different meaning than the nominal and verbal forms, and can be used as placeholders for the modified noun (55, 56). The co-occurrence of the particles with nouns (50) excludes an analysis as pronouns.

- (50) *i=se apuli*
DEF.SG=one person
'the other person'

- (51) *i=apuli a= se-a*
 DEF.SG=person REL= one-3SG
 ‘the person who is alone’
- (52) *li=bee-n apuli*
 DEF.PL=peer-POSS.NSPEC person
 ‘the other people’
- (53) *lu=moo ca se mwa-n-lu*
 3DU=stay in one house-POSS-3DU.POSS
 ‘They stay in the same house. (lit. they stay in one house of theirs)’ [J5:58]
- (54) *i=that cipa xa-sivu ca la a= se la*
 DEF.SG=wind NEG AGT.NMLZ-blow in location REL= one location
 ‘The wind does not always blow in the same place.’ (lit. ‘the wind is not a constant blower in a place that is one/the same place’) [J4:14]
- (55) (Note that *ecase* ‘someone’ is a pronoun (see §6.3.2))
na cip=e tena ca a= vi ka ca see
 DEM NEG=1SG hear SG.INDF REL= say SBJ SG.INDF one
 ‘I haven’t heard anything said by anyone.’ [KL:171]
- (56) *Tha faphâke nyako wîi ca been*
 ASS believe OBL strength PL.INDF other
 ‘We hope for the strength of others.’ [KL:171]

8.4.2 Quantification

Nouns are mostly quantified with verbs. Numbers are expressed through verbs, as are forms like *hmai-n* ‘many’ in (57) and the derived middle form *e-hmai-n* ‘more and more (countable)’ (see §11.2.2). Non-verbal quantifiers include *jaa* ‘much’, *mu* ‘few (uncountable)’ as well as *meeka-n*, all signifying uncountable and thus generic masses: *jaa apuli* ‘too many people’, *mu mwani* ‘little money’, *meeka li=apuli* ‘all the people’.

- (57) *go cahma naen mwa xada hê ja mu e-xhopwe mwa*
 CNJ TOP now REP differently yes PRF ITER MID-grow REP
i=hun-moo-gaa hmain-ga mwa
 DEF.SG=NMLZ-stay-1PL.INCL many-1PL.INCL REP
 ‘But today it’s nevertheless... yeah, it’s ended up growing more and more, our way of life, we’re numerous now.’ [KP:77]

8 Noun phrases

One form has been attested so far with a quantifying meaning, but able to take alienable possessive morphology: *meeka-n* ‘all’. *Meeka-n* cannot take articles, and precedes the noun phrase (58).

- (58) *le=kiica ka meeka li=been thamo, ma ca-n*
3PL=jealous SBJ all DEF.PL=other woman while in-NSPEC
e-dawee-le i=a= yata-n In Thu.
MID-between-3PL DEF.SG=REL= name-3SG.POSS Skin Banyan
‘All the women were jealous, but among them was the one whose name was Banyan Bark.’ [GC:6]

- (59) *cipa goon m=e saxhuti nyaako-m meeka i=jaxhut*
NEG enough SUBR=1SG tell to-2SG.POSS all DEF.SG=story
‘I can’t tell you the entire story (lit. everything of the story).’ [X9:31]

meeka-n ‘all’ can be used after a noun as well, in which case it carries an anaphoric suffix *-n* (60).

- (60) *le=hame ka li=thamo meeka-n*
3PL=go-DIR.CP SBJ DEF.PL=woman all-ANA
‘All the women come.’ [vamale-181127-jp_nelemwa-1: 00:01:03-00:01:05]

8.4.3 Relativizer *a*

The relativizer *a* subordinating the modifying clause (61) to the modified noun phrase is often omitted if the subordinated clause is short, same-subject, or stative (in the case of verbal predicates). Relative clauses are discussed in §14.2.3.

- (61) *go=xaahni eca=paatelo a= xa-xahnang*
2SG=see INDF.SG=trousers REL= AGT.NMLZ-good
‘You see some nice pants.’ [KL:66]
- (62) *yo th=e=bwa xaleke li=xhaohmu a= le=mu vap ko-n*
1SG ASS=1SG=IPFV see DEF.PL=old REL= 3PL=FREQ hunt OBL-NSPEC
da
spear
‘Me, I still used to see the elders who’d hunt with a spear.’ [KL:162]

8.4.4 Noun phrase subordinator *ko-*

Especially for new concepts, a construction is used which is reminiscent of the French one $N + de + N$, e.g. *voiture_i de service_{ii}* ‘work_{ii} car_i’. The modified noun comes first, with a noun phrase subordinated by the preposition *ko-* following it: *watuut ko-n vaya* ‘work car’ (lit. ‘car on-NSPEC work’). This prepositional noun *ko-* ‘on; OBL’ described in §8.1.2.3, usually takes a generic noun phrase (63), but specific ones are also attested (64). The resulting construction looks like a possessive one, but is analyzed here as a prepositional phrase nested in a noun phrase.

- (63) *bwa sauver-ong ka ehni a=vi, chambre-à-air ko-n velo*
 IPFV save-1SG.OBJ SBJ DEM 3SG=say air.chamber on-NSPEC bike
 ‘What he said saved me, “bike air chambers” [to train my broken arm].’
 [KG:175]

- (64) *bee-lu ko i=moo*
 peer-3DU OBL DEF.SG=stay
 ‘roommates’ [JN1:174]

ko is derived from the prepositional noun meaning ‘on’, and is a member of a polyvalent group of *ko* forms, including an oblique marker (§8.1.2.3), subordinators (§14.2.7 and §14.1.5), and, though it lexicalizes the non-specific marker *-n*, the progressive marker *ko(o)n* (§12.4).

8.4.5 Demonstrative suffixes

Vamale features demonstrative pronouns, discussed in §8.2.2. One of the latter, *niena* ‘DEM.PL.DIST’, and common nouns, are the only words able to take demonstrative suffixes. The suffixes in question are *-ca* ‘PROX.(DIR.CP)’, which can denote visible or otherwise salient entities, and *-aen* ‘DIST’, which marks more generally distant ones. A saliency or spatial distinction appears in Bwato0 only with the forms *-hni* and *-hanaa* (Rivierre & Ehrhardt 2006: 43) discussed in §8.2.2, but neither Bwato0 nor other West Coast dialects seem to feature *-ca* and *-aen*. Hienghène languages make the proximal/distal distinction as well, with a third degree (close but not to the speaker) in eastern Nemi (Haudricourt & Ozanne-Rivierre 1982: 255), again without the *-ca* and *-aen* forms. Cèmuhi, however, has *-cè* ‘PROX’ and *-nè* ‘DIST’ (Rivierre 1980: 92).

Apart from distinguishing different degrees of spatial distance, the suffixes can express saliency degrees in discourse, with proximal *-ca* denoting recently mentioned entities, and *-aen* less recently mentioned ones (65, 66). A temporal use is attested with *jo-ca* ‘this year’ *jo-aen* ‘next year’.

8 Noun phrases

- (65) *cahma li=xhwaawe-ca ha-me naen, cipa le=caihna-n*
TOP DEF.PL=children-PROX go-DIR.CP now NEG 3PL=know-NSPEC
niena-aen
DEM-PROX
'Whereas these kids (*hame*: that have come about) nowadays, they don't
know all that.' [KL:112]
- (66) *tha vwa i i=ye a= thaa tha i=e-vwa-ka*
ASS EXIST DEF.SG DEF.SG=tree REL= ASS ASS DEF.SG=INS.NMLZ-do-LINK
i=aman-aen
DEF.SG=thing-DIST
'There is a tree that's used for said thing.' [KL:215]

8.4.6 Dependent verbs in modified noun phrases

This analysis claims that Vamale has no adjectives. Though this word class is common in Oceanic (Ross 2004: 497), it is not seen in Northern New Caledonian languages (Bril 2002: 106, Ozanne-Rivierre 1998: 47). Vamale nouns are modified via relative clauses (67), or in compounds with postposed modifiers, see (68) and §7.4. One emerging phenomenon warrants discussion: the inclusion of stative verbs into the noun phrase.

- (67) *i=thamo (a) xhaohmu*
DEF.SG=woman (REL) old
'the old woman'
- (68) *i=yee-thamo*
DEF.SG=tree-woman
'the female tree'

The stative verbs *xhopwen* 'big, grow' and *xhwatin* 'small' can take a subject, as shown in §9.2.1, and a noun phrase is derived from the resulting verb phrase, as evidenced by the article on the very left of the construction, and the option to coordinate modifiers: ART=[V- n_{NSPEC} N $_{\text{NSPEC}}$]. See Figure 8.2 for an example.

Common noun compounds using *xhopwe-n* are attested for weather phenomena and swearwords (69, 72), where the first item is not the head. Given that this is not a productive pattern (71), these constructions are analyzed as lexicalized, and not relevant to this discussion of the wordclass of *xhopwen*. Their established use may have contributed to the productive forming of the construction in Figure 8.2.

- (69) *xhopwen uta*
big rain
'monsoon'
- (70) *xhopwen that*
big wind
'cyclone'
- (71) **xhopwen goon*
big body
- (72) *xhopwe-n vwa-m!*
size-POSS penis-2SG.POSS
'The size of your penis!' (insult referring to uncircumcised, i.e. immature members)

A special case of phrase-internal modification is *joakan* 'thick', which may be a loan and cognate to *goo-n* 'body', which is *joo-n* in Pije, or *joa-n* 'totality, all of it' in western Voh-Koné varieties (73). Like *xhopwen*, *joakan* cannot take an article without being followed by a noun. It is not attested as a predicate, however, which makes an analysis as a dependent noun plausible. The example in (74) thus seems to be the result of two reanalyses: the verb phrase *xhopwen juu-sapwen* is reanalyzed as a noun phrase, and the modifier *joakan* is coordinated with the other modifier *xhopwen*.

- (73) [...] *a= thawi-a ca i=juu joakan sapwen*
REL= wrap-3SG in DEF.SG=very thick clothing
'[...] wrapped in a thick coat' [excerpt from 'The North Wind and the Sun']
- (74) *i=juu joakan ma juu xhopwen juu-sapwen-eong*
DEF.SG=real thick COM real big real-dress-1SG.POSS
'my very thick and very big dress'

In conclusion, some words appear as modifiers in a noun phrase and have verbal or nominal origins. The modified nouns are the heads of following relative clauses (*i xhopwen apuli [a=xahan]* 'the big man [REL=over.there]'), which is remarkable since Vamale's head-initial order is otherwise highly consistent. These constructions seem to be relatively new, as the loss of functional *-n* in stative dependent verbs is still underway.

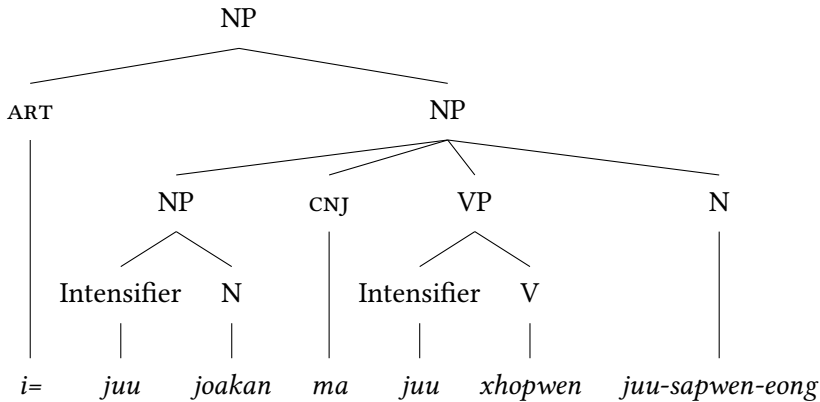

Figure 8.2: A syntax tree illustrating a noun phrase with preposed modifiers (see ex. 74).

8.5 Coordination of noun phrases

Noun phrases are coordinated using similar morphemes as those discussed in §10.5. This includes *ma* ‘and (similarly)’, *ka* ‘and, (on the other hand)’, and *hai/a* ‘or’. Contrary to verb phrases, the result is a single constituent, which is why I discuss coordination here instead of in Chapter 14.

For an equative meaning as in (76), two noun phrases can be connected by *hmwaka-* ‘be like’, which is a possessible verb. The result is not a new clause, however, but an adjunct. *Hmwaka-* can be preceded by a verb phrase, but is always followed by a noun phrase as in (75), or an adverb, as in (77).

- (75) *gavwe bo vwa sohmu-n hmwaka li=nyai-je ko*
 2PL IRR do study-NSPEC be.like DEF.PL=child-1PLINCL.POSS OBL
ni=fati-je
 DEF.PL=language-1PL.INCL.POSS
 ‘You will study our languages like our children.’ [HC19:72]

- (76) *gaa cipa hmwaka li=xhaohmu*
 1PL.INCL NEG like DEF.PL=old
 ‘We are not like the elders.’ [KP:83]

- (77) *cahma naen tha cipa hmwaka-n habu*
 TOP now ASS NEG like-NSPEC before
 ‘But nowadays, it’s not like before.’ [KP:56]

8.5.1 Comitative *ma* ‘with’

The comitative *ma* includes the following NP into the action or the state happening, as in (78). It is probably not related to the subordinator *ma*, which is *ne* in Hienghène languages (Haudricourt & Ozanne-Rivierre 1982: 258), whereas the comitative is *ma(a)* (Haudricourt & Ozanne-Rivierre 1982: 259). This coordinator is used to link clauses as well (§14.1.1).

- (78) *kon i=mur séparer i=mwa-n vwa-ila ma*
 because DEF.SG=wall separate DEF.SG=house-POSS cook COM
i=tha i=mwa habu xaleke?
 DEF.SG=ASS DEF.SG=house long.ago see
 ‘Because the wall separates the kitchen and the ... the pre-existing house, see?’ [KG:53]

ma serves to form inclusory constructions: to ask with whom one did something, the pronoun including both the addressee and the presumed other person(s) is used, followed by *ma*: *gau ma* ‘you and whom?’ (2 people, (80)), *gavwe ma* ‘you and whom?’ (more than 2 people), *le/lu ma* ‘they with/and whom?’ (3rd person). This syndetic (i.e. using a conjunction) interrogative inclusory construction is common in Austronesian languages (Bril 2011: 244–257).

- (79) *e=bo jili wâng ma Dui*
 1SG=FUT build.with.wood boat COM D.
 ‘I will build a boat with Dui.’

- (80) *gau ma?*
 2DU COM
 ‘You and who?’ [B2:41]

Asyndetic constructions also exist, as in (81). In this “verb-marking strategy”, a singular article introduces a noun phrase modified by a relative clause with a dual subject (Bril 2011: 244–245).

- (81) *i-se a= lu=mee hup-e ya a=bwa ta xale*
 DEF.SG-other REL= 3DU=all go.down-DIR.CP 3SG 3SG=IPFV go.up look
 ‘The other who came with (lit. the other that the two came down together) went up [in the gas station] to look around.’ [KG:471]
- (82) *ma i=xhwaawe xayu lu e-copain-copine*
 COM DEF.SG=child male 3DU RECP-boyfriend-girlfriend
 ‘With the boy, she becomes a couple.’ [AG1:299]

8 Noun phrases

- (83) *ko cama lu=moo mwa ma i=thamo, a=bwa sila xawe*
because if 3DU=stay DEICT COM DEF.SG=woman 3SG=IPFV raise youth
mwa
DEICT
'Because when they stay together, the woman and him, she will raise
children.' [AG1:406-407]

8.5.2 Additive *ka* 'also, too'

Ka is a conjunction used to introduce new actions and different subjects. It is used to coordinate verb phrases, noun phrases (84), as well as clauses, and can take the meaning 'but'.

- (84) *a= moo ko i=yeen ma fe yata li=ye ka*
REL= stay on DEF.SG=island SUBR take name DEF.PL=tree CNJ
li=i-n thii ka hê
DEF.PL=skin-POSS shell CNJ yes
'[...] that live on the island to take the names of the trees and of the clam
shells and yes.' [GP:17]
- (85) *cahma naen buco puakan han pala-je: cahni ka tiwade ka wanas*
TOP now full pig go home-1PL.POSS here CNJ T. CNJ W.
ka theganpaik, cama le=vwa bordel ...
CNJ T. if 3PL=do mess
'But now it's full of [feral] pigs running about the homeland, here [We
Hava] and in Tiouandé, and Ouanache, and Téganpaik, [and] when they
make a mess [in the fields] ...' [KL:4]

8.5.3 Alternative *hai* 'or'

Hai can be used in several different ways: an emotive interjection of surprise when alone, a modal discourse marker expressing insecurity ('the red one maybe, *hai?*?'), or to contrast two choices. In order to mark the first choice, *hai* can precede it (86), whereas the second *hai* is obligatory. As shown in (87), a non-comitative list of noun phrases is usually articulated by the less marked allomorph *a*.

- (86) *hai go hai yo?*
CNTR 2SG CNTR 1SG
'You or me?'

- (87) *go=bwa fa-pidanke mwa li=hao-n-go a*
 2SG=IPFV CAUS-separate DEICT DEF.PL=grandfather-POSS-2SG.POSS or
li=papa-n-go a li=bee-m mwa a
 DEF.PL=father-POSS-2SG.POSS or DEF.PL=sibling-2SG.POSS even or
 ‘You share this [custom] now with your grandparents, your parents, or
 even your siblings, or...’ [CP1:42]

9 Verbs

Verbs are the biggest word class in Vamale after nouns. They make up over a third of the recorded lexicon (1314/3627), with nouns numbering 1844 (counting proper nouns and common deverbal nominalizations). In Vamale, apart from predication, verbs may modify nouns (covered in §8.4) and verbs alike (§9.6.3, §10.3.1, and §10.3.2.2), though adverbs exist as well (§10.4). Intransitive verbs can form clauses on their own. Verbs can be divided into three main classes, according to their subject-indexing morphology. Active verbs, which bear subject-indexing on their left (see §9.3), mark transitive subjects like agent-like intransitive subjects, compare examples (2) and (3) (Figure 9.1). Stative verbs, described in §9.2, take suffixes for subject-indexing (4) and use morphemes distinct from undergoer-indexing suffixes, shown in Table 9.1. Verbs usually index the subject, except in imperative constructions, in serial verb constructions if they are not the first verb, and, for stative verbs, if the subject is inanimate. The argument markers can be omitted for pragmatic reasons, most prominently in lists of things happening, or when it is otherwise clear to whom something happens, as in (1).

- (1) *ka cahma yo, tha gavwe=paa hmaa-koo-ng naen, gavwe=bwa*
CNJ TOP 1SG ASS 2PL=PRF hit-on-1SG now 2PL=IPFV
hmaa-koo-ng, ka pala
hit-on-1SG CNJ talk
'But me, you have found me now, you found me and [we] spoke.'
[HC19:59]

Another type is impersonal verbs, which take a subordinate clause as their sole argument, and cannot take a subject (§9.1). One type of verb is described in Chapter 10 instead of here: manner verbs are bound intransitive verbs that only occur as elements modifying the head verb (§10.3.2.2).

- (2) *le=soom*
3PL=swim
'They swim.'

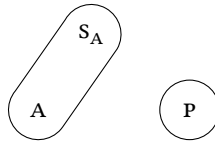

Figure 9.1: Alignment for active verbs

- (3) *le=caihna li=apuli*
 3PL=know DEF.PL=person
 ‘They know the people.’
- (4) *sinu-le*
 suffer-3PL
 ‘They suffer.’

A small class of stative verbs are formally indistinguishable from directly possessed nouns, except in that they don’t take articles (§9.2.3). Examples include *mulip* ‘life’ *muliv-am* ‘you are alive’, *hman-an* ‘be hungry’.

Table 9.1: Subject and object markers for active and stative verbs

	Free form	A=/S _A =	-S _P	-P
1SG	<i>io</i>	<i>e</i>	<i>-o(ng)</i>	<i>-o</i>
1DU.INCL	<i>gasu</i>	<i>gasu</i>	<i>-gasu</i>	<i>-kaeu</i>
1PL.INCL	<i>gaa/gase</i>	<i>ga(se)</i>	<i>gaa</i>	<i>-kaa</i>
1DU.EXCL	<i>abu</i>	<i>abu</i>	<i>-abu</i>	<i>-(a)bu</i>
1PL.EXCL	<i>abe</i>	<i>abe</i>	<i>-abe</i>	<i>-(a)be</i>
2SG	<i>go</i>	<i>go</i>	<i>-go</i>	<i>-ko</i>
2DU	<i>gau</i>	<i>gau</i>	<i>-gau</i>	<i>-kau</i>
2PL	<i>gavwe</i>	<i>gavwe</i>	<i>-gavwe</i>	<i>-kavwe</i>
3SG	<i>ia</i>	<i>a</i>	<i>-(e)a</i>	<i>-(e)a</i>
3DU	<i>lu</i>	<i>lu</i>	<i>-lu</i>	<i>-lu</i>
3PL	<i>le</i>	<i>le</i>	<i>-le</i>	<i>-le</i>

9.1 Impersonal verbs

Impersonal verbs, a term used by Rivierre (1980: 70) for Cèmuhî, do not take argument indices and cannot occur in the imperative mood, but like other verbs

they can form complete clauses by themselves and can either occur with an argument or without it. One subset of impersonal verbs, the affirmative existential *vwa* and the negative existential *cika*, can only take a noun phrase as an argument, but these are not the subject, as evidenced by their inability to take *ka* ‘SBJ’. This excludes pronouns. Since Vamale does not have a word for ‘to have’, having or not having something is expressed with possessive constructions, as in (5): e.g. ‘there is for me’, calqued into local French: *Il y a une femme pour toi?* ‘Is there a wife for you?’ meaning ‘Do you have a wife?’ *Cika* ‘NEG.EXIST’ only takes inanimate and non-specific animate arguments, while *cia-* is open to arguments of any animacy, and generic inanimates. *Vwa* ‘EXIST’ may exceptionally take free pronouns and specific animate arguments in marked scenarios (persons will usually be localized with *la* ‘be here’ and demonstratives).

- (5) *hê tha vwa li=xhaohmu vwa wadala-le*
 YES ASS EXIST DEF.PL=old EXIST gun-3PL.POSS
 ‘Yes, there were elders who had guns.’ [KL:141]

Another subset of impersonal verbs takes a complement clause as their sole argument (6), but can also stand alone (7). They form a small, closed class, partly derived from nouns. *Goon ma* ‘allowed, possible to’, *vwasoon ma* ‘impossible to’,¹ *siteke ma* ‘forbidden to’ work like this (see Figure 9.2). Most members of this class have other meanings when used as nouns or verbs in other contexts, e.g. *goon* ‘body, enough’ but *goon, ma...* ‘possible, feasible, allowed to...’

- (6) *vwasoon ma go=suu*
 impossible COMP 2SG=break
 ‘You cannot break it.’ [AG1:71]
- (7) *ju-vaa vwasoon*
 very-too.much impossible
 ‘It’s too difficult.’ [KG:135]

Uta ‘rain’, *mapeke* ‘be day’, *bwen* ‘night’ and other members of the lexical field of weather phenomena, sea tide, etc. exist as article-bearing nouns as well, do not take arguments, but can form clauses and take certain adverbs. This third group is called verbs on the basis of constructions where the members cannot behave like typical nouns (8), and following analyses of cognates in other languages, where the forms can be derived to take arguments: *bwen-i-eg* ‘It becomes night

¹Maybe from *vwa-s(it)oon* ‘EXIST-taboo’.

around me’ (Rivierre 1980: 302). This argument-taking is not attested in Vamale (anymore), but oblique constructions still exist.

- (8) (*i) *uta nyako-ong*
 DEF.SG rain OBL-1SG.POSS
 ‘It rains on me.’

- (9) *thapoke mapeke*
 begin bright
 ‘It is (starting to) dawn.’

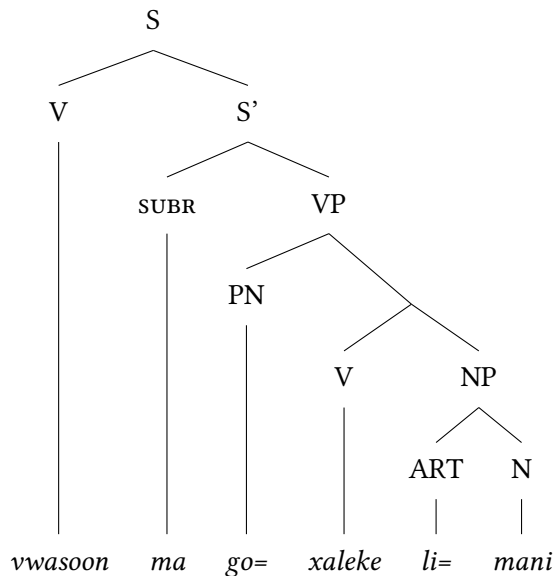

Figure 9.2: Tree-diagram of the sentence structure of *vwasoon ma go xaleke li mani* ‘You cannot see the birds’

9.2 Stative verbs

“Stative verbs” are a classic feature in New Caledonian languages, already described in Haudricourt (1948), and descend from Proto-Oceanic (Lynch et al. 2002: 63).² They are inflected with morphemes that closely resemble postponed free

²Lynch et al. distinguish stative and dynamic verbs, while the French tradition, and this study, call the latter “active” verbs.

forms, as in Table 9.2. Like the undergoers of transitive verbs, the animacy of the referent decides whether the subject of a stative verb is marked: inanimate participants are not indexed on the verb.

Table 9.2: Inflection of *hmet-* ‘sated’

SG	1	<i>hmet-eo</i>
	2	<i>hmet-go</i>
	3	<i>hmet-ea</i>
DU	1INCL	<i>hmet-gasu</i>
	1EXCL	<i>hmet-abu</i>
	2	<i>hmet-au</i>
	3	<i>hmet-lu</i>
PL	1INCL	<i>hmet-gaa</i>
	1EXCL	<i>hmet-abe</i>
	2	<i>hmet-gavwe</i>
	3	<i>hmet-le</i>

Stative verbs are a closed class, semantically vaguely characterized by a patientive S (though many active verbs also have a patientive S, e.g. *weke* ‘to be angry’, or *khûda* ‘to stink’). The argument is marked in the same position as transitive undergoers, and shares the latter’s form, except in the first and second persons, where P arguments have a devoiced form, i.e. *-ko* ‘2SG’, *-kaa* ‘1PL.INCL’ etc. This means that S is marked in two ways: S and A are marked the same for active verbs, and stative verb S subjects are either marked the same as P, or slightly differently, depending on the speaker and the verb. We thus have a tripartite system, though stative S and P are merged by many younger speakers, yielding a split-intransitive system like in western Voh-Koné. Diachronically, stative S and P participants were probably expressed as free pronouns following the predicate (V PN),³ which became incorporated into the verb (e.g. *hmwet ia* ‘tired 3SG’ → *hmwet-ea*). Indirect possession underwent a similar process (*thala-n ia* ‘knife-POSS 3SG’ → *thala n-ea*). The stative verb *hmana-n* ‘be hungry’ (not a noun because it cannot take an article) has the paradigm of a directly possessed noun, and shares this property with *muliva-n* ‘be alive’ (see §9.2.3).

³This may be linked to a Proto-Oceanic VSO or VOS word order (Lynch et al. 2002: 86, 87), though nowadays SVO is more widespread and considered canonic (Lynch et al. 2002: 49). Note that this would not explain the indexing found on active verbs.

9.2.1 Dependent stative verbs

Some verbs, active as well as stative ones, show nominal inflection. This grammar will use the term DEPENDENT VERB found in some New Caledonian descriptions (Ozanne-Rivierre 1976: 207) for these verbs that can index a non-specific argument with a generic *-n* (similarly to inalienably possessed nouns, called DEPENDENT NOUNS in the French tradition, which also cannot omit marking their modifier). Active verbs with nominal morphology work rather differently and are discussed in §9.3.1.2. The verbs described here take different subject-indexing suffixes depending on animacy and specificity of the subject, as shown in Table 9.3. There are few still productive verbs in this category, but they are frequently used. Common members include *xhopwe-n* ‘grow/be big’, *xhwati-n* ‘be small’, *hmai-n* ‘be many’, *sate-n* ‘be different’, *yape-n* ‘be old (inanimate)’.

Animate subjects are indexed on stative verbs with personal suffixes (*-eo* ‘1SG’, *-go* ‘2SG’ etc.) when they are not present as a noun phrase (10). Inanimate subjects take *-n* ‘ANA’ in these cases (11).

(10) *sate-o*
 different-1SG
 ‘I am different.’

(11) *sate-n* (*koo-n*)
 different-ANA (OBL-ANA)
 ‘It is different (from it).’

Generic subjects are always marked with *-n* ‘NSPEC’ (12). These rules begin to be less rigidly enforced in Voh-Koné languages in general (Rivierre & Ehrhardt 2006: 51), and *-n* now often appears before noun phrases regardless of their animacy and specificity (14). This may have contributed to the development of noun phrase internal modifying verbs (see §8.4.6).

(12) *e=vi hapi na naen xadaa sate-n*
 1SG=say COMP DEM now on.the.other.hand different-NSPEC
 ‘I’m saying that now things have changed.’ [KL:243]

Some stative verbs have split into two forms with different meanings, e.g. *hmwaka-n*, *hmwaka-o* ‘be like it, be like me’, but *hmwakan* ‘maybe’. Verbs with nominal morphology can also be found in Cèmuhi (Rivierre 1980: 179, 183) and Nyelâyu (Ozanne-Rivierre 1998: 48). They are not described as an open class in these grammars. Though most verbs with nominal morphology in Vamale are stative, there are also active ones. A prominent example is *caihna-n* ‘to know’

(discussed in more detail §9.3.1.2). Some stative verbs with *-n* can be derived with *-ke* ‘TR’, compare *xhwatii-n* ‘be small’ and *xhwatii-ke* ‘do softly’.

Table 9.3: Meanings of *xhopwe-* ‘grow’

1SG	<i>xhopwe-o</i>	‘I grow’
2SG	<i>xhopwe-go</i>	‘You grow’
3SG	<i>xhopwe-a</i>	‘S/He grows’
NSPEC	<i>xhopwe-n</i>	‘It is big’
overt NP	<i>xhopwe</i>	‘It is bigger than X/before’

For *xhopwe-n* ‘big’, there is a meaning distinction along an animacy axis: without *-n*, it expresses either a development ‘big’ → ‘get bigger’, through time in comparison with an earlier state (‘grow’), or synchronically in comparison with others (‘be bigger than’, see example 13). A table summarizes the forms (Table 9.3). *xhopwe-* means ‘to be bigger’ for animate subjects (13) and ‘to be big’ for inanimates (14, 15).

- (13) *i=apuli a= xhopwe-a (koo-le)*
 DEF.SG=man REL= big-3SG.S_p (OBL-3PL)
 ‘the bigger man (in years, status, size) (than them)’

- (14) *xhopwe(n) i=goon*
 big DEF.SG=body
 ‘the big body (height, corpulence)’

A construction frequently seen with animate subjects is shown in (15). The unmarked use of *xhopwe*, as explained above, is as a predicate with comparative meaning (16). In a relative clause, *xhopwe* is ungrammatical without a resumptive subject-indexing suffix (17), e.g. *-a*, or an anaphoric suffix *-n* (18). In example (15), however, the meaning of *xhopwen* is not comparative. This construction seems to be a strategy to avoid the incremental/comparative meaning of certain stative verbs, and may be related to the de-grammaticalization of *-n* mentioned for *xhopwen* in Table 9.3.

- (15) *i=apuli a= xhopwe-n*
 DEF.SG=man REL= big-ANA
 ‘the fat/old/important man’

- (16) *xhopwe i=apuli-aen*
 grow DEF.SG=man-DEM
 ‘This man is bigger/taller/ more important.’
- (17) * *i=apuli a= xhopwe*
 DEF.SG=man REL= big
 (for: ‘the man who is big’)
- (18) *i=apuli a= xhopwe-n ca-n dawee-lu*
 DEF.SG=man REL= big-ANA in-NSPEC between-3DU.POSS
 ‘the fatter man of the two’

9.2.2 Numerals

Numerals in Vamale are stative verbs that can take subject suffixes, as Table 9.4 shows. Some are derived from nouns, notably 5 from ‘hand’⁴ and 20 from ‘person’, the bases of the system. Complex numerals used to be formed like clauses, made of coordinated verb phrases.

Table 9.4: The first six cardinal numerals and their verbal form

Number	Gloss	Suffixed form	Gloss
<i>se</i>	‘1’	<i>see-a</i>	‘s/he is one, s/he is alone’
<i>thalo(o)</i>	‘2’	<i>thaloo-lu</i>	‘they are two’
<i>thi(i)en</i>	‘3’	<i>thien-le</i>	‘they are three’
<i>fava</i>	‘4’	<i>fava-le</i>	‘they are four’
<i>nim</i>	‘5’	<i>nim-le</i>	‘they are five’
<i>nim a bwa se</i>	‘6’	<i>nim a bwa see-le</i>	‘they are six’

(N)a-bwa was only recorded with complex numerals, some of which are shown in Table 9.5. The initial nasal only occurs if the preceding element ends in an open syllable. Bwatoos has *bwa* as ‘+’ (Rivierre & Ehrhardt 2006: 45), maybe related to *pwa* ‘on’ or *bwa-* ‘head’. Leenhardt translates *vajilu ka bwa nim ka bwa se* ‘16’, then with *ka* instead of *na*, as ‘ten and the right hand raised and open, and the thumb sticking out of the fist’, but no modern Vamale word would tie *bwa* to either palm (*yataan*), fist (*daamuun*) nor the right hand (*juu sin*) (Leenhardt

⁴From *si-* ‘hand’, showing the tendency to rather speak of 2SG or 1PL.INCL than an indefinite 3SG.

1946: 166). The element having replaced the coordinator *ka* is another puzzle. The demonstrative pronoun *na* often means ‘It is X (who did/is Y)’, and may have replaced the former coordinator *ka* (Leenhardt 1946: 166) in a sense of ‘five, this on top of two’ for ‘7’ (19). This grammar writes the coordinator *na-bwa* joined by a hyphen to account for its single stress contour.

- (19) *nim (a)-bwa thaloo*
 5 plus 2
 ‘7’

Table 9.5: Complex numerals

<i>vajilu na-bwa nim a-bwa se</i>	‘16’
<i>thaloo vajilu</i>	‘20’
<i>se apuli na-bwa nim a-bwa se</i>	‘26’ ^a
<i>se apuli na-bwa vajilu</i>	‘30’
<i>thaloo apuli</i>	‘40’ (arch.) ^b
<i>nim apuli</i>	‘100’
<i>apuli ko apuli</i>	‘400’

^a*se apuli* lit. ‘one person’

^bThis is never given spontaneously. People are mentally in a ten-based system now (see the word for 20).

Vajilu ‘10’ could be etymologically composed as in (20). The last syllable is likely *-lu* marking 3DU.POSS on nouns. The system being 5-and 20-based as is typical of the region (Haudricourt & Ozanne-Rivierre 1982: 261), and finally *Iaai* saying ‘two hands’ for 10, maybe the etymology of this word is something like in (20), but this is purely speculative.

- (20) *vwa si-lu*
 EXIST hand-3DU.POSS
 ‘They have hands/there are their hands.’

According to Rivierre & Ehrhardt (2006: 45), and also Dego Philippe Gohoupe, another word for 100 is *se apuli* ‘one person’. This confusing polysemy makes more sense considering that the Pacific Franc used to have a 100 Franc bill with a man on it (see Figure 9.3), was a salient thing, and spoken about much more often than groups of twenty. Nowadays, saying *se apuli* normally means ‘100’, but *se*

apuli na bwa se is ‘21’, whereas *nim apuli* is ‘100’ if it is part of a complex numeral. Leenhardt notes *nilu apuli* for ‘100’ without glossing it (Leenhardt 1946: 166). Whether *nim apuli* is interpreted as 500 or 100 is difficult to ascertain, since most speakers are unsure. Vamale numerals are rarely used beyond 5 in the language, while French loans are taking over due to school, money, hours of the day, and a decay of counting contributions in customary ceremonies. Multiplying based on 20 is attested in *Langues et Dialectes de l’Austro-Mélanésie* for most languages, amongst which is Hmwaveke with *sec apulip ko apulip* for 400, literally ‘one person on people, or ‘20 on 20’’, which suggests, along with *nim apuli* ‘100 (lit. 5 20)’, that the multiplication base comes last, and the multiplier first (Leenhardt 1946).

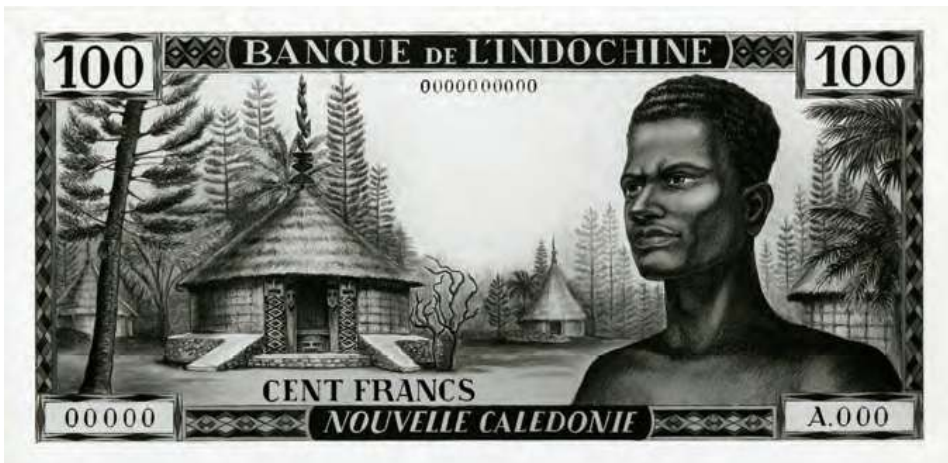

Figure 9.3: A 100 CFP bill from 1964 (IEOM 2014: 24)

9.2.2.1 Ordinals

Ordinals are formed with e^{-5} and $(k)a-n$ ‘CLF.POSS-NSPEC’,⁶ yielding the forms listed in Table 9.6. Leenhardt (1946) recorded irregular forms which have now disappeared, *i a vathabun* ‘the first (lit. s/he who is in front)’,⁷ now regular *i e-se=kan* ‘the first’, and *i ethice nawe*,⁸ now *i e-thien=an*. They, too, are rarely used beyond 5.

⁵ *be-* in Cèmuhì, used only with ordinals (Rivierre 1980: 271).

⁶ The Cèmuhì cognate [hê] is analyzed as a possessive morpheme by Rivierre (Rivierre 1980: 271) and otherwise only present in part-of-whole compounds.

⁷ Leenhardt’s *vathabun* is *pa(a)thabun* nowadays.

⁸ Since the clitic $=(k)a-n$ is used for possessum classifying purposes elsewhere, Leenhardt’s form could have been *i e-thicen=a-vwe*, with *-vwe* ‘2PL.POSS’.

Table 9.6: Ordinals

<i>(i) e-se kan</i>	‘(the) first’
<i>i e-thalo kan</i>	‘the second’
<i>i e-thien an</i>	‘the third’
<i>i e-fava kan</i>	‘the fourth’
<i>i e-nim an</i>	‘the fifth’
<i>i e-vajilu na bwa nim na bwa se kan</i>	‘the sixteenth’
<i>i e-koin an</i>	‘the last’

Ordinal numbers seem to have lexicalized *ka-n* ‘CLF.POSS-NSPEC’, since it cannot be omitted. Onto it, another *ka* can be added (but does not necessarily have to be) in order to make it possessible by the noun *en* ‘moment’ (21, 22).

- (21) *ja i=[e-thalo-kan ka-n en] a tipwa*
 PRF DEF.SG=ORD-TWO-LINK CLF.POSS-NSPEC moment REL.3SG fall
 ‘It is the second time that it falls.’ [JN1:21]

- (22) *ja i=e-koin-an ka-n en a= e=xale-ko*
 PRF DEF.SG=ORD-END-LINK CLF.POSS-NSPEC moment REL= 1SG=see-2SG.OBJ
 ‘It is the last time that I saw you.’ [JN1:36]

9.2.2.2 Multiplicative *o*

The multiplicative prefix *o-* (‘X times’) only occurs with numerals. The resulting word is derived to an adverb (23). Hence, multiplicatives cannot be predicates in a matrix clause, but do occur in adjunct clauses. Exceptions are interjections like the work call *o-see!* ‘do at once, in one hard pull’. *O* ‘X times’ is analyzed as a prefix as well in Nêlêmwa (Bril 2002: 39) and Bwato (where it is *we-*) (Rivierre & Ehrhardt 2006: 46). In (24), however, the adverb is possessed by a third person. I analyze this as a zero derivation.

- (23) *a=tho nyakoo-m o-thiien*
 3SG=call OBL-2SG.POSS times-three
 ‘S/he called you three times.’ [2019-08-05 JP ka 42.1]
- (24) *pa ja o-thien-n-ea ko i=(hun-) mata*
 PRF PRF times-three-POSS-3SG.POSS OBL DEF.SG=NMLZ- sing
 ‘This is the third time that he sings.’ [vamale-181127-jp_nelemwa-1:
 00:11:51-00:11:52]

9.2.3 Possessible verbs

“Possessible verbs” are distinguished here from “verbs with *-n*”, though they both carry a morpheme *-n* in the third person, because the latter inflect using stative subject indexing suffixes (including *-n* ‘NSPEC’), and the former take possessive morphology (including *-n* ‘3SG.POSS’, see Table 7.3). There are two subsets of stative possessible verbs, one with alienable and one with inalienable possessive morphology. Inalienably possessed intransitive verbs, such as the ones below (25), are not transparently derived from nouns (26), with the exception of *nyima* ‘heart’ ~ ‘to want’. Nouns can be derived from some of them using typical deverbal constructions (27).

- (a) *hman-ong* ‘I am hungry’, *hmana-n* ‘s/he is hungry’
- (b) *bwaa-ng*, *bwaa-n*, *bwaa-ju* ‘if only’. This has an interjection counterpart *bwaa-m* ‘poor/darling you!’. Since this item cannot take an article and can stand as clause, it is analyzed as a verb.
- (c) *holoo-m*, *holoo-u*, *holoo-vwe* ‘goodbye (you, you two, you all)’
- (d) *nyim-ong* ‘I want, like’
- (e) *vwaseek-ong* ‘I am sad’
- (25) *hman-ong*
hungry-1SG.POSS
‘I am hungry.’
- (26) **i=hman-an* (for: ‘his/her hunger’)
- (27) *paa juu va xhopwen i=hun-hman-ong*
already really too big DEF.SG-NMLZ-hungry-1SG(.POSS)
‘I am more and more hungry.’ (lit. ‘My hungering has become really big’)

There are few alienably possessed intransitive verbs. They include *yamaan-eong*, *yamaan-ea*, *yamaan-gasu* ‘be unwilling to do for lack of motivation, be fed up with something’, and *saxhwe-ong*, *saxhwe-a* ‘refuse to do’,⁹ as well as *yathô-ong*, *yathô-a* ‘be in a hurry’. *Sinu-ong*, ‘be sick, be suffering; die’ also exists as a noun meaning ‘illness’. Possessible verbs, mostly verbs with an Undergoer argument, take possessive morphology usually found on nouns, but cannot bear

⁹This possibly contains the morpheme *xhwe* ‘be across’.

an article. They are intransitive, like all stative verbs. The second subset, with alienable possessive morphology, could be derived from the very similar stative paradigm, and in many cases the subject-indexing suffixes differ between speakers: *sino-ong* ~ *sinu-o* ‘ill-1SG’, *saxhwe-ong* ~ *saxhwe-o* ‘refuse-1SG’.

9.3 Active verbs

Active verbs, the biggest group of verbs, have transitive and intransitive members, and many of them are ambitransitive, meaning they can take an object, but do not have to. As is common in Oceanic languages (Ross 2004: 510), there are no ditransitive verbs in Vamale. This section will first introduce transitive verbs, with their suffixes *-i* and *-ke*, then describe transitive verbs with nominal inflection (called “dependent” transitive verbs), before addressing transitive verbs that require a preposition *ko-* ‘on’.

Active intransitive verbs are formally not distinct from transitive verbs, except in that they do not take object suffixes. This is in line with Proto-Oceanic (Lynch et al. 2002: 81). Both transitive (e.g. *vavi* ‘hunt something’) and ambitransitive verbs (e.g. *xaahni* ‘check, stare (at)’) can occur without an argument, before other (ad)verbal elements of the verb phrase, or with a generic argument, and will still carry transitive suffixes *-i* or *-ke*, discussed below. Purely intransitive ones usually do not end in *-i* or *-ke*, see (28). All active verbs take subject marking bound pronouns, as in examples (29) and (30). Table 9.1 lists the bound pronouns.

- (28) *tabo tabo li=xho thamo, thên thên li=xho xayu*
 sit sit DEF.PL=cicada female fly fly DEF.PL=cicada male
 ‘Sit sit oh female cicadas [full of eggs], fly fly (away) oh male cicadas.’
 (children’s song, female cicadas bear eggs and are tastier) [children’s song]

- (29) *e=han-mwa ko-m=e vwa ma=a thuup ka*
 1SG=go-REP because-SUBR=1SG do COMP=3SG bathe SBJ
i=jamw-ong
 DEF.SG=father-1SG.POSS
 ‘I’m going back to make my father take a bath.’ [PQ 10.1]

- (30) *tha=abe=vataan fai li=ya-be. cahma*
 ASS=1PL.EXCL=each cook DEF.PL=starchy.food-1PL.EXCL concerning
li=mama-n-abe, non. tha=le fwi-kabe
 DEF.PL=mother-POSS-1PL.EXCL no ASS=3PL pinch-1PL.EXCL.OBJ

ma=abe=mu *bwa e-nyoot*
 SUBR=1PL.EXCL=FREQ IPFV REFL-wake.up

‘We’d cook our own lunch. Our mothers however, no. They’d pinch us so that we’d wake up.’ [PE2:50]

9.3.1 Transitive verbs

Transitive verbs mark the subject at the beginning and the undergoer object (if animate, but this condition is disappearing) at the end (31).¹⁰ There are no ditransitive verbs; non-core arguments such as recipients, goals, experiencers and stimuli (depending, of course, on the verb) are marked with the oblique markers *nyasi-* and *nyako-* (see §8.1.2). The transitive verb *holeke* ‘thank, receive’, for example, has the Theme as a direct object and the Recipient is added through *nyako-* or *nyasi-* (32). *nyasi-* is more polite and can only be used with humans. Transitive verbs almost invariably appear with the now lexicalized transitive suffix *-i*, possibly descended from Proto-Oceanic **-i* (Ross 2004: 507), or with the still productive *-ke*, possibly descended from **-akin(i)* (Ross 2004: 507). §9.3.1.1 describes this in more detail. Transitive verbs without these suffixes are e.g. *tua* ‘detach’, *tuu* ‘take something out of somewhere’, *sivu* ‘blow; smoke’.

- (31) (*a=*) *ha-me wati-ko ko go=imwi i=nyai-n*
 3SG= go-DIR.CP chase-2SG.OBJ because 2SG=grab DEF.SG=child-3SG.POSS
 ‘It comes to chase you because you took its pup.’ [B2:36]

- (32) *gaa=se-me holeke nyasi bofukaje i=thoatit-ca a=*
 1PL.INCL=together thank OBL god DEF.SG=day-DEM.PROX REL=
tha=a=bwa nya si-je
 ASS=3SG=IPFV put BEN-1PL.INCL
 ‘We all thank God together for this day that he gave us.’ [Adèle Gohoupe’s Song “Hole Nyasi Daahma”:1]

9.3.1.1 Transitive suffixes *-ke* and *-i*

The transitive suffix *-ke* is the only productive transitive suffix in Vamale. This grammar calls *-ke* a transitive rather than applicative suffix because it does not routinely turn obliques into direct objects, but can derive transitive from intransitive verbs, or even transitive verbs from complex verbs and nouns. Furthermore,

¹⁰In example (31), the subject marker was omitted. This may be due to the elicitation context, where there no referent for the chaser was established.

and perhaps most importantly, the suffix is in complementary distribution with an object marker: *-ke* appears if the animate object is not overt, as in examples (33) and (34). This distinguishes *-ke* from *-i*, which is part of the stem and cannot be replaced.¹¹ Note that both *-ke* and *-i* (described further down) likely have Proto-Oceanic origins, **-akin(i)* and **-i*, respectively (Ross 2004: 507), though the latter are reconstructed as applicative suffixes.

(33) *le=xhiile-a*
 3PL=flog-3SG.OBJ
 ‘They flog him/her.’

(34) *le=xhiile-ke i=apuli*
 3PL=flog-TR DEF.SG=person
 ‘They flog the person.’

Most verbs that take *-ke* and (still) have a counterpart without the suffix, are active verbs, as Table 9.7 shows. For example, the verb *xaleke* ‘to look at something, to see something’ has two sisters that also relate to visual intake: *xale* ‘to look without clear purpose’ is either intransitive and means ‘to look around’, or means ‘to visit’ and takes animate undergoers (35).

(35) *i=se* *a= lu=mee hup-e* *ya a=bwa ta xale*
 DEF.SG=other REL= 3DU=all go.down-DIR.CP 3SG 3SG=IPFV go.up look
 ‘The other who came with (lit. the other that the two came down together) went up [in the gas station] to look around.’ [KG:471]

Xalo koo-n ‘gaze (at something, with no implication of understanding or recognition)’ illustrates another way of expressing transitivity: with *ko* ‘OBL’ (see §8.1.2.3). *Xhaavwa koo-n* ‘wait around for it’ is the less transitive counterpart to *xhavwaleke* ‘await’, possibly because *xhavwale* would look like a transitive 3PL object verb. Another possibility would be an older form *xhwaavwat* that eventually dropped the last plosive to yield modern *xhaavwa*. This would be similar to *sesaat* ‘sneak’, *sesaaleke* ‘stalk’. The suffix *-ke* is not reserved for animate objects, as *feanake* ‘to show’ illustrates in example (36): if the animate undergoer is present as a noun phrase, *-ke* remains, otherwise the undergoer is indexed via a suffix (37).

¹¹Contrary to the Vamale form *-ke*, the Cèmuhî cognate [-hî] can derive stative and impersonal verbs such as [titi] ‘wet’ (Vam. *titi*) ‘to be likely to wet something’ and [ütē] ‘rain’ (Vam. *uta*) to [ütē-hî] ‘to be rained upon’ (Rivierre 1980: 255).

9 Verbs

- (36) *feana-ke i=si-m, feana-ke i=thamo!*
 show-TR DEF.SG=hand-2SG.POSS show-TR DEF.SG=woman
 ‘Show your hand, show the woman [e.g. to me]!’
- (37) *feana-a!*
 show-3SG.OBJ
 ‘Show him/her!’

Table 9.7: Pairs with and without *-ke*

Verb	With overt anim. P	With pronoun	With overt inan. P
<i>xale</i> ‘visit, look around’	<i>xale i apuli</i> ‘go see the person’	* <i>xale yo, xale go</i>	* <i>xale i mwa</i>
<i>xaleke</i> ‘see’	<i>xaleke i apuli</i> ‘see the man’	<i>xale-o, xale-ko</i> ‘see me, see you’	<i>xaleke i mwa</i> ‘see the house’
<i>cade</i> ‘admire’	<i>cade i apuli</i> ‘admire the man’	* <i>cade-go</i>	* <i>cade i mwa</i>
<i>cadeke</i> ‘admire’	<i>cadeke i apuli</i> ‘admire the man’	<i>cade-ko</i> ‘admire you’	<i>cadeke i mwa</i> ‘admire the house’
<i>vathân</i> ‘do separately’	is a preverb (see Section 10.3.2.1)		
<i>vathânke</i> ‘separate’	<i>vathânke li=apuli</i> ‘separate the men’	<i>vathân-le</i> ‘scatter them’	<i>vathânke i we</i> ‘part the water’

-ke is also used with the stative verb *xhwatii-n* ‘be small’, yielding *xhwatiike* ‘do softly’, as in (38). Note that *xhwatiike*, despite the translation given here, is not a transitive verb, nor indeed an independent one, but a manner verb postponed to the main verb describing the action, e.g. *jili xhwatiike* ‘build slowly’, or *hmata xhwatiike* ‘sing softly’. Another stative verb is *tada(a)* ‘to be surprised’ (39), where *tadake* means ‘to surprise someone’ (40).

- (38) *cama sinu tha go tha go=vwa xhwatiike*
 when suffer ASS 2SG ASS 2SG=do do.slowly
 ‘When it hurts, you, you do it slowly.’ [KG:176-177]

- (39) *cuut hmwaana kavi a=tadaa cala a=xaleke hapi na tha*
 stand like.that, but 3SG=surprise when.REAL 3SG=see COMP DEM ASS
juu buuke thaloo palet
 real destroy two pallet
 ‘He simply stood there but was surprised when he saw that two pallets
 were destroyed.’
- (40) *après yo m=e=cuut hmwaani, tada-ong ko i=camion*
 then 1SG SUBR=1SG=stand like.this, surprise-1SG because DEF.SG=truck
khû, xaleke
 make.noise see
 ‘Then, me, as I’m standing like this, I get jump-scared because of the
 truck going “bang”, see?’ [KG:475]

Another, much more common, suffix is *-i*. Contrary to *-ke*, *-i* is not used to increase the transitivity of a verb, or to derive it. However, it must have been in the past, as numerous pairs attest. Consider a few in Table 9.8. Other examples include *thati* ‘beat’, *wati* ‘chase’ and *titabwi* ‘welcome’, which do not have a counterpart lacking *-i*.

Table 9.8: Transitivity with *-i*

<i>vwa cuut</i>	‘to make stand’	<i>vacuti</i>	‘to erect’
<i>thaut</i>	‘fire fan’	<i>thauli</i>	‘to fan’
<i>cicaat</i>	‘be taut’	<i>cicaai</i>	‘to stretch’
<i>faat</i>	‘glue; be sticky’	<i>faati</i>	‘to glue’
<i>vap</i>	‘hunt (n), go hunting’	<i>vavi</i>	‘hunt something’

Far Northern Nelêmwa, lacking articles, has a system of verb suffixes to make transitivity and animacy distinctions. The language uses a basic intransitive form and two more or less transitive ones, which distinguish non-human (*-a/-u*), and non-specific human *-e* arguments from specific human ones *-i* (Bril 2002: 44). *-i* in Vamale has lost its transparent function and has become lexicalized. *-a* and *-e* are also still present in Vamale, though they form an even smaller set of transitive/intransitive pairs: some verbs ending with *-a* form pairs with others ending with *-e*, the latter being transitive, the former not. In the case of *fwada-i* ‘to look for something’, a transitivity of **fwada* seems to have taken place. The attested Vamale pairs with *-a/-e* are:

- (a) *vila/vile* ‘dance/dodge’
 (b) *buna/bune* ‘thieve/steal’
 (c) *fwada-i/fwade* ‘search (inanim)/search (anim)’
 (d) *tipwa/tipwe* ‘fall, drop’ (the latter only preserved in *vwa-tipwe* ‘drop’)

9.3.1.2 Dependent transitive verbs

Nominal inflection on verbs is mostly seen in stative verbs, as described in §9.2.1. For certain transitive verbs, however, generic objects and complement verbs (e.g. *caihna-n* [*tena-n*]_{COMP} in (45)) are marked with the generic suffix *-n*. Examples are listed in Table 9.9. This section does not discuss verbal compounds containing a possessible noun (V + N-POSS), where the undergoer is marked via possessive morphology, e.g. *wai-nyoo-n* ‘tie-neck-3SG.POSS’ ‘hang him(self)’, or *caa-pala-n* ‘step.on-talk-3SG.POSS’ ‘answer’.

Table 9.9: Dependent transitive verbs

Takes animate object	
<i>caihna-n</i>	‘know’
Does not take animate object	
<i>vunuu-n</i>	‘finish’
<i>sohmu-n</i>	‘study, to study in general’
<i>thaxhwae-n</i>	‘attempt’
<i>thafwa-n</i>	‘carry on back’
<i>thaboo-n</i>	‘extinguish’
<i>vacia-n</i>	‘lose’
<i>thalepwa-n</i>	‘topple’

The morphology of dependent transitive verbs reacts to animacy, as Table 9.10 and to the co-occurrence of the undergoer in the same clause.

This makes dependent transitive verbs similar to dependent stative verbs, verbs ending in *-ke*, and prepositions: verbs with animate undergoers can omit the undergoer-indexing person suffix (e.g. *-o* ‘1SG.OBJ’) in favor of taking a generic *-n* only if the undergoer is indeed generic (41a): *V-n* OBJ_{NSPEC}. This probably includes anaphoric use, but is not attested in the corpus so far. If the animate undergoer is specific and does not appear in the same clause, the dependent verb,

Table 9.10: Some forms of the paradigm of transitive *caihnan* ‘to know’

<i>a caihna-o</i>	‘s/he knows me’
<i>a caihna-ko</i>	‘s/he knows you’
<i>a caihna-a</i>	‘s/he knows him/her’
<i>a caihna-kau</i>	‘s/he knows you (2DU)’
<i>a caihna-n</i>	‘s/he knows (it)’
<i>a caihna-n apuli</i>	‘s/he knows people (NSPEC)’
<i>a caihna i apuli</i>	‘s/he knows the person (SPEC)’

like all other transitive verbs, must index it (41b): V-OBJ (*[ART OBJ_{SPEC}]). If the undergoer is specific and appears as an NP in the same clause, regardless of animacy, the verb takes no suffix, personal or generic (42), (44): V [ART OBJ].

- (41) a. *e=caihna-n thamo*
 1SG=know-NSPEC woman
 ‘I know (about) women.’ [J4:13]
- b. (Using *caihna-n* with a free pronoun is not attested, because free pronouns cannot be used in the undergoer position.)
go=caihna-a
 2SG=know-3SG
 ‘You know her.’
- (42) *e=caihna i=thamo-aen*
 1SG=know DEF.SG=woman-DIST
 ‘I know that woman.’ [J4:12]

Verbs with inanimate undergoers distinguish two scenarios: either the undergoer is specific and follows the verb, or not. They will drop the generic undergoer index *-n* only if a specific undergoer NP follows the verb: V ART OBJ_{SPEC}. One example is (44). Note that *-n* is used anaphorically for inanimate undergoers, as in (43), regardless of their specificity.

- (43) *gase=vi li=a= gase=caihna-n, cipii pala xhayu*
 1PL.INCL=say DEF.PL=REL= 1PL.INCL=know-NSPEC, PROH talk random
ko gase=bo gat
 because 1PL.INCL=IRR lie
 ‘We say that which we know, don’t talk randomly, for then we’d lie.’
 [GD:5]

- (44) [...] *koma bwa caihna li=yee*
 [...] PURP IPFV know DEF.PL=tree
 ‘in order to know the trees’ [GP2:16]

Rivierre mentions several cognate forms for Bwato (Rivierre & Ehrhardt 2006: 51) and Cèmuhi (Rivierre 1980: 179, 180) which are either lexicalized in Vamale, or do not carry the same morphology at all (Table 9.11). A possible exception is *tena* ‘hear’, but example (45) was its only unelicited occurrence.

Table 9.11: Bwato verbs with nominal morphology and Vamale cognates

Bwato	Vamale	Gloss
<i>tete-a/n</i>	<i>tena-a/n</i>	‘hear’
<i>thabwii-a/n</i>	<i>tha(v)wi-a</i>	‘wrap’
<i>caxhvae-a/n</i>	<i>thaxhwaen</i>	Bw. ‘imitate’; V. ‘try’
<i>tatamwi-a/n</i>	<i>titabwi-a</i>	‘welcome’

- (45) *na tena jela-n habu ma cipa go=va caihna-n*
 DEM hear side-3SG.POSS before SUBR NEG 2SG=much know-NSPEC
tena-n thuan ca=aman
 hear-ANA well some=thing
 ‘That [what I was doing] was hearing the version of old, when you don’t know how to listen too well to something.’ [DT:4]

There are constructions that are, at least diachronically, active or stative V+N compounds (see Table 9.12, and example (46)). This means that arguments are marked by nominal possessive morphology. This study does not count these lexicalized former verb phrases (with possessive suffixes) as identical to the dependent transitive verbs in Table 9.9, which use object suffixes. This view is shared with Rivierre on Bwato (Rivierre & Ehrhardt 2006: 50).

- (46) *ca i=wadan a= e-thaloo-ka-n tha see-ma*
 in DEF.SG=time REL= ORD-2-CLF.POSS-NSPEC ASS one-face
i=a=a=vi
 DEF.SG=REL=3SG=say
 ‘The second time she said the same thing.’ [GC 100.1]

Table 9.12: Verb+Noun compounds

Form	Morphological makeup	Gloss
<i>wai-nyoo-n</i>	twist-neck-3SG.POSS	‘to strangle/commit suicide’
<i>fe-bomaa-n</i>	take-scent-3SG.POSS	‘to smell something’
<i>fe-maa-n</i>	take-face-3SG.POSS	‘to disguise as’
<i>fe-nyamaa-n</i>	take-eye-3SG.POSS	‘catch someone’s eye’
<i>fa-xhopwe-n</i>	CAUS-big-3SG.POSS	‘glorify it’
<i>tha-fa-bee-n</i>	strongly-CAUS-peer-3SG.POSS	‘to approach something’
stative: <i>see-maa-n</i>	one-face-3SG.POSS	‘be the same’

9.3.1.3 Verbs with *ko*- Arguments

The latter scenario likely affects verbs that were intransitive and whose oblique addition became so common that the form lexicalized, creating a pair. An example of this is *nyima*- ‘to want’, and *nyima-ko*- ‘to like, love’. For a number of verbs (some of which are illustrated in Table 9.13), this hypothetical development left the *ko*-less form behind, and the verb phrase now needs *ko* to be grammatical. This grammar does not analyze *ko* as a suffix, incorporated into the verb, because *ko*- is a p-word, and because the possessor marked on *ko*- is an undergoer argument. Indeed, all of these *ko*-needing verbs are transitive.

Table 9.13: Verbs with *ko*

<i>soot ko(o)-n</i>	‘touch’
<i>xalo ko(o)-n</i>	‘gaze upon’
<i>soxhaa koon</i>	‘waste’
<i>vwa-khû koon</i>	‘force someone’

9.3.2 Benefactive nouns

“Benefactive nouns” are constructions which can be formed with only a few lexical items. The forms available for this construction are ambiguous as to their nominal or verbal status. They take an alienable possessive pronoun which marks a beneficiary argument. The few attested examples suggest a de-nominal derivation, where a possessive construction is verbalized by adding a subject index. Note that the two spontaneously produced constructions in examples (47) and (49) used nouns which have identical verbal counterparts.

9 Verbs

- (47) *a=vaaya-n gaa*
3SG=work-POSS 1PL.INCL.POSS
'He does our work. (He works in our stead)' [2019-07-25 JP *grammaire*]
- (48) *a=vaaya nyakoo-je*
3SG=work for-1PL.INCL.POSS
'He works for us. (He does work for our benefit)' [2019-07-25 JP *grammaire*]
- (49) *vwa-ila-hn-ea, go ni=nyai-le, nya, tha le=moo*
do-pot-POSS-3SG.POSS then DEF.PL=child-3PL.POSS put ASS 3PL=stay
xahut pedaa
down P.
'...cook for him, and their children, well, they stayed down in Pindache.'
[vamale-171129-ecology: 0:01:29 (Vamale Usa)]

9.4 Space

Spatial deixis is ubiquitous in Vamale discourse; using a geocentric orientation system since the Proto-Oceanic stage (François 2004), the language is infused with references to various axes and cosmologically relevant points. Since moving through space is chiefly expressed verbally, this section of mostly lexical interest is placed in Chapter 9, though deverbal derivations are also discussed.

9.4.1 Up/down

Hut 'move down' has several meanings derived from Kanak worldview: following an Oceanic tradition, going down also means moving towards the sea. Since sailing to other islands is done at sea, *hut* also means moving out into the world (e.g. the Loyalty Islands, or France). Related to this is the sense of leaving the house (traditionally built on a mound due to floods). A third sense of *hut* is following the tradewinds, north-east along the coast. In contrast to this, *ta* 'move up' is used spatially for moving towards the mountains, up and deeper into a house or the land, and south-west, i.e. having to laboriously sail against the prevailing winds. In combination with other motion verbs, *ta*, *han* 'move on the same level' and *hut* have allomorphs that assimilate to the previous verb, and to the directional suffixes *-me* 'DIR.CP' and *-le* 'DIR.CF'. *Hma* 'arrive' forms the following compounds:

1. *hma-han-me* → *hmasame* ‘arrive here (moving on the same level)’
2. *hma-hut-me* → *hmasupe* ‘arrive here (moving down)’
3. *hma-ta-me* → *hmacame* ‘arrive here (moving up)’
4. *hma-han-le* → *hmasade* ‘arrive there (moving on the same level)’
5. *hma-hut-le* → *hmasute* ‘arrive there (moving down)’
6. *hma-ta-le* → *hmacale* ‘arrive there (moving up)’

Note that /l/ → /t/ after /t/, and /m/ → /p/ in the same context. /ta/ is affricated to /ca/, and /h/ → /s/. This last sound change is unique to the compounds discussed above.

9.4.2 Upstream/dowstream

Hnuut ‘move downstream’ and *hnuda* ‘move upstream’¹² have cognates across the archipelago, except in the riverless Loyalty islands (Bearune 2012: 232). Interestingly, this axis is also used for southward (*hnuda* ‘move upstream’) and northward movement along a limited part of the coast, between Cem¹³ and Lid-eraalik, see Figure 9.4. The northern limit of this area depends on the speakers’ home, between Pedaac and Koulnoué, but the southern limit is Cem, about 10 km along the coast south of the bridge over the Tipije. This area corresponds roughly to the valleys of Wanaa and We Hava, whose defining creeks Kaciabwec and We Hava flow southeast-northwest, i.e. parallel to the coast. Beyond this area, *hut* ‘move northwards’ and *ta* ‘move southwards’ are used (see §9.4.1).

9.4.3 Spatial adverbs

Vamale derives spatial adverbs from the verbs *hut* ‘go down’, *ta* ‘go up’, and *han* ‘move on the same level, go’. The adverbs in question, prefixed with *xa-*, *xa-hut* ‘down there’, *xa-da* ‘up there’, and *xa-han* ‘over there’, form the basis of this system and are unrelated to the demonstratives in §8.2.2. They are described in more detail in §10.4.1, but an overview is given in Table 9.14. Spatial words can be combined with other words (*hoot xahut* ‘far down.there’) or with each other (*nyaut xahut* ‘just down there (but too far to reach)’).

¹²This is not the same as *saxhuti* ‘follow the course of a river/road/coastline; tell a story’.

¹³‘Landing point’ in Cèmuhi.

9 Verbs



Figure 9.4: The “realm” of *hnuut*. Relevant rivers marked in yellow.

Table 9.14: The main motion verbs and their associated locative adverbs

Form	Gloss	Word class
<i>cahni</i>	‘here’	adverb
<i>la</i>	‘be.here’	verb
<i>ta</i>	‘move up’	verb
<i>hut</i>	‘move down’	verb
<i>han</i>	‘go (same level)’	verb
<i>hnu-ut</i>	‘move downstream’	verb
<i>hnu-da</i>	‘move upstream’	verb
<i>xa-da</i>	‘up there’	adverb
<i>xa-hut</i>	‘down there’	adverb
<i>xa-han</i>	‘over there’	adverb
<i>xa-hnu-ut</i>	‘over there (downstream)’	adverb
<i>xa-hnu-da</i>	‘over there (upstream)’	adverb

9.4.4 *Nya* ‘around, towards, inside’

(H)*nya* ‘put, give, send’ is a multi-purpose morpheme, especially in the context of space. One function of *nya* is to combine with prepositions to form new prepositions, locating the theme as contained by or very close to the prepositioned location: *ca-* ‘at’ → *nye-ca-* ‘inside’ (50), *pwa-* ‘on top of’, → *nya-pwa-* ‘upon’, *ko* ‘on (touching a part of it)’, *nya-ko* ‘immediately on; apply on’ (51). In this function, *nya* also appears as a prefix in spatial adverbs (see §10.4.1), to form a proximal form (*nya-ut* ‘(put) down, down there at an arm’s length’). *Nya* often displays a phonologically conditioned allomorph *nye* when preceding the article *i* ‘DEF.SG’, and palatal /c/, as in (50).

- (50) *le=vwa-vaci li=apuli nye-ca i nye-ca i=mwa-n*
 3PL=do-kernel DEF.PL=people LOC-in DEF.SG LOC-in DEF.SG=house-POSS
daahma
 chief
 ‘The people were quarrelling in, in the chief’s house.’ [DT:10.3]

- (51) *bitake nya-ko i=yee*
 wrap LOC-on DEF.SG=tree
 ‘wrap around the tree’ [X9:20]

Nya can also mean ‘toward’, a meaning that is related to ‘send’. In combination with spatial adverbs, *nya* forms two paradigms: the series *nya-xahut/nya-xada/nya-xahan* is almost equivalent in meaning to *xahan* ‘over there’ etc. It means ‘in the vicinity of X’, whereas *xahan* etc. designate a more precise location. In (52) and (53), *nya* is used to express a vague area. The other paradigm combines *nya-an/nya-ut/nya-da* ‘send, put there/down/up’ with the basic adverbial form, which yields a comparatively farther meaning, e.g. *nya-an (mwa) xahan* ‘(even) further away in this general direction’ (see §9.4.3).

- (52) *In-Fwe hapi “In-Fwe ka e=hu-pe nya nya-da xa-da” kavi*
 F. COMP F. CNJ 1SG=come-DIR.CP from send-up LOC-up but
cipa a=vi i=goakan
 NEG 3SG=say DEF.SG=place
 ‘Figtree-Bark said that “[my name is] Figtree-Bark and I come from somewhere a little further up” but she didn’t say the place.’ [GC:53.2]

- (53) *ka a=cuut cahni go a=cuut cai-n ka*
 CNJ 3SG=stand here CNJ 3SG=stand behind-NSPEC SBJ
i=xa-thake i=bool. hmwakan nya-xahan a=cuut
 DEF.SG=AGT.NMLZ-throw DEF.SG=ball maybe over-there 3SG=stand
xahan ka i=see
 over.there SBJ DEF.SG=one
 ‘And she stands here, and behind her stands the cricket pitcher. Maybe
 around there stands the other [player].’ [PJ:29]

Nya is frequently used to locate something in a named place, especially vil-
 lages, as in (54). This may be a strategy to avoid having to use more specific
 terms such as *xahut* ‘down there’, but no clear pattern was identified.

- (54) *vwa nya theganpaik*
 EXIST around T.
 ‘It will be in Téganpaik.’ [AG1:66]

9.4.5 Same-level axis

Volitional displacement on the same level is expressed with the active verb *han*
 or the derived adverb *xahan* ‘over there on the same level’. The movement of an
 object, e.g. in the wind, is called *va(a)ya* ‘movement, work’. Depending on the
 context, *han* can mean ‘go’, e.g. *ha-de-ha-me* ‘go-DIR.CF-go-DIR.CP’ ‘to and fro’,
 and ‘walk’, e.g. *han-maa* ‘walk on the reef at low tide to gather sea-food’. There
 is an increase of the use of *han* among less fluent speakers, which may be due to
 French influence.

Nowadays, *han* means ‘to walk’ and *thêên* ‘to run, to fly’, but the manner prefix
t(h)e- ‘to do while walking’ is probably derived from *thêên*. Since this is the case
 for both Hienghène languages (*hen* ‘walk’ in Pije, but *te-* ‘while walking’) and
 Voh-Koné ones, the split must be an old one.

9.4.6 Centripetal/-fugal axis *-me*, *-le*

There are two main suffixes used to express motion to and from the utterance’s
 point of reference. While this center is usually the speaker, stories may set the
 center somewhere else more or less explicitly,¹⁴ and hypothetical or past situ-
 ations can also feature these suffixes. The movement verbs assimilate the final
 consonant’s place of articulation to *-me* ‘DIR.CP’: *ta* ‘go up’ + *-me* → *tame* ‘come
 up’, *hut* ‘go down’ + *-me* → *hupe* ‘come down’, *han* ‘go’ + *-me* → *hame* ‘come’.

¹⁴This was described for Caac as well (Cauchard 2014: 176).

The other suffix *-le* ‘DIR.CP’ assimilates to the verb’s final consonant: *ta-le* ‘leave upwards’, *hut-e* ‘leave downwards’, and *han-de* ‘go away’. The latter is another example of the relationship between alveolar plosives and liquids mentioned in §7.3.2.

Motion verbs can be added to a verb phrase if a centripetal or centrifugal meaning is needed, as other verbs cannot take *-me* or *-le*, as in (55).

- (55) *kona sili sahmwa ha-me sili sahmwa ha-me*
 then pierce other.way go-DIR.CP pierce other.way go-DIR.CP
 ‘Then he backs [the truck] up, backs it up.’ [KG:466]

9.4.7 Origin of motion

In order to express the origin of a motion, *moo* ‘stay’ is preposed to the source, and postposed to the motion verb, as in (56).

- (56) *na tha go=saat moo cahni*
 DEM ASS 2SG=wade from here
 ‘You wade in the water from here.’ [RP:6]

9.4.8 Others

This section has not made a complete description of spatial expressions in Vamale, a daunting task that has become a PhD thesis in its own right for both Nengone (Bearune 2012) and Caac (Cauchard 2014). The chapter mostly focused on the main axes of motion, proximity,¹⁵ and centripetal/centrifugal motion, but there is a lexical field of prepositions (e.g. *pwa-* ‘on’, *xala-* ‘under’, *cela-* ‘beside’, *patemwano* ‘right next to’, *ca-* ‘at’) (see §6.5.2), manner verbs (e.g. *falogavi* ‘move across diagonally’), and verbs describing motion more specifically, e.g. *cop* ‘go over a mountain, go to the other coast; surpass someone’ or *saat*¹⁶ ‘walk through water, ford a river’. The next section leaves the lexical domain of space and addresses productive prefixes denoting posture and ways of doing things.

9.5 Prefixes

The following derivational prefixes are distinct from TAM markers in that they are not independent words, although they express similar meanings, and are partly sensitive to aktionsart. Table 9.16 lists them with examples. Prefixes of

¹⁵Proximal and distal demonstratives are discussed in §8.2.2.

¹⁶There are also *sesaat* ‘walk slowly, sneak’, and *sesaaleke* ‘stalk’ which could be related.

manner are all derived from verbs and in many cases lexicalized, though some still appear productive. *The-* is a polysemous prefix, as it not only contributes its expected ‘do while walking/running’ meaning to verbs, but also takes more aspectual meanings, depending on the verb and its context (see §9.5.2). Prefixes are presented here in Chapter 9 while aspectual markers, which are own words, are described in Chapter 12, and anything that is exclusive to the verb phrase but not part of the verb, in Chapter 10.

9.5.1 Prefixes of manner

Manner prefixes can be added to roots to express how something is done, and have in many cases become lexicalized, i.e. are not added to new words, but can be identified as bearing meaning in several verbs. For example, Rivierre & Ehrhardt analyze some words as complex (e.g. *tha-bilo-ke* ‘to kill’, 2006: 61), which are not attested without their manner prefix, or indeed with another prefix, in Vamale. Bound verbal forms which are still attested in the dictionary include:

1. *-bii* ‘crack’ from POC **piti(k)* ‘crack’ (Ross et al. 1998: 276),
 - a) *cu-bi(i)* ‘break bread’
 - b) *cu-bite* ‘be squashed by a crowd’
 - c) *caa-bite* ‘harvest’
 - d) *ca-bi* ‘smash something brittle by hand or blunt tool’
2. *-bwane* ‘split’ from POC **p^walaq* ‘split’ (Ross et al. 1998: 265), e.g. *tha-bwane vai* ‘split stone’, ‘Téganpaik (a village name)’
3. *-bali* ‘drive in’, e.g. *tha-bali* ‘to nail’, *coo-bahli* ‘push someone away with the hand’
4. *-theeke* ‘push’
 - a) *pitheeke* ‘to push someone away’
 - b) *caatheeke* ‘push away with a stick’
 - c) *sibatheeke* ‘push someone in a direction’
 - d) *tha-theeke* ‘kill with a spear’
 - e) possibly *theeke* ‘blow on food’

Note that in the first three examples listed for *-theeke*, the preceding parts are transparent.

Manner prefixes have been described in “Verbal Compounds and Lexical Prefixes in the Languages of New Caledonia”, called “classificatory prefixes” there (Ozanne-Rivierre & Rivierre 2004: 349), and are typical of New Caledonian languages, albeit more frequent in Southern languages than in Northern ones. It is possible that a compound consisting of a shortened transitive manner verb and an action verb was already a feature of Proto-Mainland (Ozanne-Rivierre & Rivierre 2004: 354), as these prefixes appear throughout the main island, but have diversified clearly within the two groups North and South. Having a variety of verbs for striking with different tools is an old feature of Oceanic. Table 9.15 (page 194) gives a short selection of Proto-Oceanic verbs.¹⁷ The posture prefixes *cu-* ‘do standing’, *ta-* ‘do sitting’, see (57), and *mi-* ‘do lying down’, are unique to Northern languages (Ozanne-Rivierre & Rivierre 2004: 356). Note that Ozanne-Rivierre and Rivierre call verbs prefixed by the morphemes described here “compound verbs”, whereas I use the term exclusively for verbs where all components are also attested as single head verbs.

- (57) *bo tha xa-vaaya-n-eo* *i= m=e=ta-meebam aa*
 IRR ASS AGT.NMLZ-work-POSS-1SG.POSS DEF.SG SUBR=1SG=sit-sleep uuh
ca-n sohmun
 in-NSPEC study
 ‘That would be my habit, the...if I slept sitting in school.’ [2017-10-30
 Pauty Ecole et punition:10]

9.5.2 *the-*

The prefix *the-* is halfway between a prefix of manner and an aspect marker. It likely comes from *thêên* ‘run, fly’ and still exists as a manner prefix, as illustrated in the words *the-thagavi* ‘take a shortcut’ and *the-yathô* ‘walk-stress; walk in a hurry’. It seems, however, that this use has become lexicalized.

The productive, non-manner prefix *t(h)e-* has two meanings, depending on the aktionsart of the verb. With punctual verbs, it means ‘do quickly, a bit’. With durative ones, it means ‘do continually since earlier’, often with reference to another event, e.g. *the-xaleke* ‘look at constantly’, and (59). This is likely due to its putative origin *thêên* ‘run, fly’. In imperatives, *the-* always asks for immediate action: ‘do this now’. While *the-*prefixed verbs, when preceded by TAM markers, often do not take on idiosyncratic meanings, some combinations are interesting. Frequentative *mu*, habitual *xa*, and imperfective/future *bwa* do not change the

¹⁷The form *sasa is given by (Grace 1969).

Table 9.15: Proto-Oceanic verbs for hitting (Ross et al. 1998: 267)

POc	Meaning
*sasa	'hunt, thrash, a whip'
*punu(q), *punuq-i-	'hit, strike, fight, kill'
*qubu, *qubWi-	'hit with fist or with a weapon'
*rapu(t), *raput-i-	'hit with hand or stick, slash'
*tutuk, *tuki[-]	'pound, mash by pounding, hammer, crack by hammering'
*putu(k) and *butu(k), *butuk-i-	'repeatedly knock, pound, beat'
*qatu(1), *qatu-J-i-	'strike from above, pound'
*babak, *baki[-]	'strike one against another, knock'
*tupu, *tupu-i-	'knock against, knock over, stub (toe), stumble against'
*pwasa(r,R), *pwasa(r,R)-i	'slap, hit'

Table 9.16: Manner prefixes, their likely origins, with examples.

Form	Meaning	Origin	Example	Meaning
<i>ca-</i>	hit with hand		<i>cabi</i>	'smash something brittle'
<i>caa-</i>	set down foot	<i>caa</i>	<i>caa-gati</i> <i>caa-thiho</i>	'crush something soft' 'limp'
<i>co-</i>	with hand		<i>co-gavi</i> <i>co-bahli</i>	'break by pulling' 'push off by hand'
<i>ta-</i>	sitting	<i>tabo</i>	<i>ta-meebam</i>	'sit-sleep; sleep in a sitting position'
<i>cu-</i>	standing	<i>cuut</i>	<i>cu-vathan-ke</i>	'stand-each-TR; stand apart from e. o.'
<i>mi-</i>	lying	<i>majit</i>	<i>mi-xaleke</i>	'lay-see; have a vision'
<i>tha-</i>	forcefully	<i>thake</i>	<i>tha-biloke</i> <i>tha-gavi</i>	'strongly-kill; kill with a strike' 'strongly-cut; cut with one strike'
<i>so-</i>	touch	<i>soot</i>	<i>so-teet</i>	'touch-lazy; do carelessly'
<i>fa-</i>	speak	<i>fati</i>	<i>fa-xhopwen</i>	'talk big, boast'
<i>t(h)e-</i>	do walking	<i>thêên</i>	<i>t(h)e-thagavi</i>	'walk-cut; take a short-cut'

meaning, but *pa* ‘PRF’ excludes an interpretation of the event as quickly done; the yielded meaning focuses on the time spent on it (“it took me a long time to do it”). This effect is even stronger with *pa ja* ‘PRF.PRF’. With progressive *kon*, *the-* means ‘right now, immediately’. With durative verbs, *the-* takes on a durative, imperfective meaning, and is similar in function to the adverb *hnyana* ‘constantly’.¹⁸ Compare the pair of examples (58) and (59) for said similar meanings, but see examples (60) and (61) for the differences.

- (58) *ceme o vaya tha xalo ko-n tele hnyana*
 SUBR.1SG IRR work ASS gaze OBL-NSPEC TV constantly
 ‘Whenever/If ever I work, he’ll watch TV (while and as long as I work).
 [Jean-Philippe, 11.7.2019, p.20]’
- (59) *ceme o vaya tha the-xalo kon tele*
 SUBR.1SG IRR work ASS THEDUR-gaze OBL-NSPEC TV
 ‘Whenever/If ever I work, he’ll watch TV (while and as long as I work).’

When describing a situation that is unique and limited in time, *the-* and *hnyana* are interchangeable. However, more general, or abstract, situations, *the-* ‘THEDUR’ takes a meaning similar to *the-* ‘THE_{PUNCT}’, see examples (60) and (61). This is reminiscent of *mwa* ‘again, now, however’ in §6.20.

- (60) *tha go=the-xaleke*
 ASS 2SG=THEDUR-see
 ‘You see now.’
- (61) *tha go=xaleke hnyana*
 ASS 2SG=see constantly
 ‘You often see.’

The- can be used with imperative verbs, where it asks for immediate action: ‘do this now, do this quickly’. Another prefix, *xhaa-* ‘ATT’, only appears in the imperative mood and acts as an attenuative prefix, ‘do a bit’ (62). In some scenarios, the two have similar meanings.

- (62) *xhaa-thagavi ye-mwago ma go=xaleke i=vaaya koo-n*
 ATT-cut tree-mango SUBR 2SG=see DEF.SG=work OBL-NSPEC
 ‘Just (try to) cut a mango tree and you’ll see the work it is.’ [example sentence provided for the dictionary entry on *xhaa*]

¹⁸See *hnyana*- ‘breath’, from which it is probably derived.

The attenuative meaning of *xhaa-* is found with imperative *the-* when the latter is used to suggest that the action asked for will be quick. The difference, however, is that *the-* suggests a quickly done task, whereas *xhaa-* means you do something for a short while, without necessarily finishing what you started. *The-* and *xha(a)-* can be combined (63). When combined, their meaning depends on the verb's aktionsart: 'quickly do now (PUNC)', 'do a non-committally big or small bit of it (DUR)'.

- (63) *xhaa-the-thagavi cahni*
 ATT-THE_{PUNCT}-cut here
 'Just cut it here real quick.'

9.5.3 *da* 'do first', *ra-* 'do afterwards'

Two morphemes can be used to sort an action with respect to other actions: *da(a)* 'do first' (64), and *ra-* 'do afterwards' (65). Note that the latter is the only phonemic example of /r/, and was only encountered in elicitation sessions. A similar *ra-* 'continue to (while others have stopped)' in Bwatoo is perhaps cognate (Rivierre & Ehrhardt 2006: 56).

- (64) *da bale ca i=xhoogo-n-go, ka go=bo vwa thuan*
 do.first broom in DEF.SG=home-POSS-2SG.POSS CNJ 2SG=IRR do do.well
nya pala li=been
 in home DEF.PL=peer
 'First clean up your home, then you (may) go clean up other homes.'
 [Proverb]

- (65) *go=bo ra-ha-me*
 2SG=IRR later-go-DIR.CP
 'You'll come afterwards.' [21.07.2019 p.42]

da 'to do first, in advance' is more common than *ra-*, and contrary to the latter, can take stress (66). It does not head phrases, however. It will hence be analyzed as a pre-verb.

- (66) [e ⁿda: vi: nākō:m]
e=da vii nyakoo-m
 1SG=in.advantage tell OBL-2SG
 'I am warning you.' [D3:79]

- (67) *gase=da* *xhwi-aman kon gase=bwa* *vwa coutume*
 1PL.INCL=in.advance eat-thing then 1PL.INCL=IPFV do custom
 ‘We’ll eat first, then we’ll conduct the ceremony.’ [L1:31]

9.5.4 Pluractional *e-*

A pluractional prefix *e-* occurs in various constructions where several entities perform the same action at the same time, but not to each other, e.g. (69) and (70). The prefix is reconstructed to be a reflex of POC *paRi-, which otherwise has reflexive, reciprocal, and middle functions. If *e-* were left out, the pluractional meaning would be lost, and the participants would be engaged in their activities in a more individual manner: compare examples (68) and (69) to *le han cai-n* ‘They follow him’ and *le han cai-le* ‘They follow them’. Note that in constructions such as (69), the meaning is somewhat in between reciprocal (they follow each other), further described in §11.1, and pluractional (they each follow a different person). This is called “chaining” by Brill, and widely attested throughout the archipelago (Brill 2005: 32, 47).

- (68) *le=e-han* *cai-n*
 3PL=MID-go behind-3SG
 ‘They *all* follow him/her.’ [07.11.18 p.93]
- (69) 3PL=MID-go behind-3PL
 ‘They walk one after the other (single file).’ [07.11.18 p.93]
- (70) *le=e-tipwa* *pu* *ka li=xhaapwe sep*
 3PL=MID-fall be.on.the.ground SBJ DEF.PL=fruit coco
 ‘The coconuts fell all together.’
 [vamale-181107-jpnelemwa-04: 00:01:19-00:01:24]
- (71) *le=tipwa hut* *hato* *ka li=xhaapwe sep*
 3PL=fall go.down do.alone SBJ DEF.PL=fruit coco
 ‘The coconuts fell by themselves (without known cause).’
 [vamale-181107.jpnelemwa-04: 00:00:30- 00:00:32]

A difference between reference and occurrence, i.e. whether several things happen at once, or the same action several times, is made analytically, by adding *sisipo* ‘together’ at the end of the verb phrase, or *vataan* ‘each, individually’ as a preverb.

In (72), similarly to contexts of *mee* ‘all’ described in §10.3.2.1.1, the action is performed by several people together. However, while *mee* usually merely implies that out of a group, everyone participates, (*v*)*e*- here adds a semantic trait of indistinguishability (Kemmer 1993: 66–73). The participants sit together and form an indistinct group, whose members do not participate in the sitting separately.

- (72) *go tha le=ve-moo mwa moo mwa*
 well ASS 3PL=MID-stay REP stay REP
 ‘Well and then they all stay together, stay.’ [KL:220]

- (73) *th=abe xa-e-hut ca-n jigo*
 ASS=IPL.EXCL NMLZ.AGT-MID-go.down in-NSPEC mangrove
 ‘We all used to go down to the mangrove (to play).’ [PE1:107]

9.6 Complex verbs

This section introduces three ways in which Vamale forms complex verbs. Following an ancient Oceanic tradition, some verbs are reduplicated. Though not very prevalent in Vamale, some examples are discussed in §9.6.1. Verbs and other verbs may join to form compounds, and verbs and nouns are also frequent partners in the creation of new words.

9.6.1 Reduplication

True reduplication in Vamale is rare. Cases abound where a verb is repeated, to express the length, urgency, intensity etc. of a notion: most frequent is the context of a serial verb construction (described in §10.3.1), but verbs are also repeated in a poetic context such as in (74), or in a playful one (75). These verbs usually have their own prosodic environment and the whole construction is lexically transparent.

- (74) (Cicada-hunting children’s song)
tabo tabo li=xho thamo thên thên li=xho xayu
 sit sit DEF.PL=cicada female fly fly DEF.PL=cicada male
 ‘Sit sit oh female cicadas [full of eggs], fly fly (away) oh male cicadas.’
 [vamale-181121-xho_thamo]

- (75) (Stone-skipping call)
jaaaavelo-velo-velo-velo
 ricochet
 ‘ricochet-chet-chet-chet’

The attested cases in which a word is repeated and forms a new word are the following: *fwa-fwa* ‘hole-hole’ ‘full of holes’, *vaya-vaya* ‘move-move’ ‘wobbly’, and *xhasaat-xhasaat* ‘jump-jump’ ‘hobble, jump around on one foot or to get warm’. While the consultant said that there were many other cases, I found none.

9.6.2 Compound verbs

Compound verbs are composed of a verb, which determines the resulting construction’s word-class and often plays a dominant role in its semantics, and another element. The interesting case of the verb *hnya* ‘put, send’ and spatial adverbs such as *xahan* ‘over there’, which combine to (*h*)*nya-xahan* ‘in this direction’, is an exception. These combined words are adverbs (see §9.4.4), as evidenced by verb phrases like *hnya hnya-xada* ‘put over there’, and will not be discussed further here.

An important group of compound verbs are composed of the vague verb *vwa* ‘do’, and a specifying verb, e.g. *vwa-suu* ‘do break’ ‘pay someone’, *vwa tau* ‘do impact’ ‘fish’,¹⁹ or *vwa-thiho* ‘do-stumble’ ‘do by accident’. Another group, small but very often used, are the lexicalized serial verb constructions (SVCs) with *fe* ‘take’ and motion verbs, e.g. (76). Other verb compounds also seem to be lexicalized SVCs, e.g. *saahma-cuut* ‘rise-be.standing’ ‘to stand up’, and *ha-de-ha-me* ‘go-DIR.CF-go-DIR.CP’ ‘move to and fro’.

- (76) *fe-(h)a(n)-me*
 take-go-DIR.CP
 ‘bring’

¹⁹This is almost certainly a taboo avoidance strategy. Hunters never use *vap* ‘to hunt’ if they go out, instead they say *balan thaap* ‘length nyaouli [a savannah tree species]’ when describing their plans, to avoid bad luck. *Vwa tau* would have replaced the marked word. Word avoidance taboos are commonplace in this region of the world. Perhaps the word for ‘wound’, *ape aman* ‘trace/track of something’ is kept vague on purpose.

9.6.3 Incorporated object constructions

On top of combining verbs with other verbs, Vamale also forms grammatical words from verbs and non-specific arguments: this includes everyday activities incorporating the most common undergoer, e.g. *xhajake-lait* ‘eat.starchy-rice’ ‘eat rice’, *xhwi-aman* ‘eat.proteiny-something’ ‘eat something’, *vai-xam* ‘weave mats’. This is called “incorporated object construction” by Ozanne-Rivierre & Rivierre (2004: 357). There are numerous verbs formed with *vwa* ‘do’, e.g. *vwa-vaci* ‘do-pit, hard part’ ‘to argue’, *vwa-ikin* ‘do-meaty.side-dish’ ‘to eat tubers with meat’, *vwa-khêt* ‘do-quarz, blade’ ‘to shave’. All the verbs mentioned form a single stress-contour and cannot be split without losing their overall meaning. Some nominalized forms can contain complex verbs including a noun, such as *xa-thêen-fe-fati* ‘AGT.NMLZ-run-take-word’ ‘messenger’ and *xa-fe-ta-me-mapeke* ‘AGT.NMLZ-take-go.up-DIR.CP-bright’ ‘morning star’.

9.7 Nominal derivation

Vamale derives nouns from verbs either by using nominalizing prefixes or simply by stripping the verb from its subject indices (be they proclitics or suffixes), and preposing an article. The nominalizers (e.g. *e-*, *xa*, *hun-*) are analyzed here as prefixes because they directly attach to the root, the article, e.g. *i=* ‘DEF.SG’ can only occur before it (*i=xa-xaleke*, **xa=i=xaleke*). The resulting nominalized construction can be used as an argument with a verb or a preposition and can be possessed by another nominal phrase. The possessor is not, however, understood to be the agent of the action, as in English (e.g. ‘my seeing the brother’), except for intransitive verbs. Instead, the possessor denotes the undergoer. Whether a given verb is nominalized via prefixation or stripping is lexically determined, since nominalizing via stripping is not accepted for some verbs (e.g. **i thapoke* ‘the beginning’, or **i hmanan* ‘his/her hunger’). Another example is *hun-vwa kan* ‘manner-do it; the style of doing it, the act of doing it’ which cannot be **vwa kan* or even **vwa*. Both stripped and prefixed nominalizations may include arguments, as in (77), but not TAM markers. Stripped nominalizations, contrary to the other de-verbal constructions detailed below, do not express a subject through possessive means, but keep the same strategy as normal verb phrases, i.e. using a noun phrase flagged with *ka* ‘sbj’: *ka li=apuli* ‘SBJ DEF.PL=person’ in (77). There are two relatively neutral prefixes, *ape-X* meaning ‘fact of doing X’, and *hun-* ‘manner of doing X’, though *hun-* was the only one readily used by speakers for novel constructions.

- (77) *e=xaleke i=jili i=bwaakala ka li=apuli_{SBJ}*
 1SG=see ART.SG=build.with.wood ART.SG=pirogue SBJ ART.PL=people
 ‘I see the building of the pirogue by the men.’

9.7.1 *e-*

The instrumental nominalizer *e-* has *fe-* and *ve-* cognates in related Northern languages. It is likely that *v-* was only recently dropped, as the word for ‘spoon’ was only coined in the last 150 years, and is *vetupi* from *tuuvi* ‘scoop up from liquid’ (though a loan from a more archaic dialect is not excluded). The word for ‘learning’ *eca* is still listed as *veca* by Leenhardt (1946) and pronounced that way by Chief Luc. In Nelêmwa, a similar morpheme *-ve-* or *-vi-* depending on animacy (Bril 2004b: 194), comes from *fhe* ‘take’ in Nêlêmwa (*fe* in Vamale), though it is not a nominalizer (*baa-*, Bril 2002: 74). Our nominalizer *e-* might have a similar background to Nelêmwa *-ve-*, being derived from *fe* ‘to take’. Cèmuhi and Paicî use *be-* ‘INS.NMLZ’ (Rivierre 1980: 257, 1983: 42), versus the reciprocal/middle *pi-* (Rivierre 1980: 257, 1983: 363).

1. *e-vwa-tiike* ‘pen’ (lit. ‘INS.NMLZ-make-write’)
2. *e-xadae-ke* ‘blessing’ (lit. ‘INS.NMLZ-up.there-TR’)
3. *e-vwadi-ya-n* ‘thumb’ (lit. ‘INS.NMLZ-peel-starchy.food-3SG.POSS’)
4. *e-xhwali-aman* ‘fork’ (lit. ‘INS.NMLZ-stab-thing’)
5. *e-ja* ‘scales’ (lit. ‘INS.NMLZ-measure, weigh’)

Other items look like nominalizations, but the meaning of the presumed base form is lost: *e-xhaat* ‘paddle’, *e-thadala* ‘fruit-picking rod’.

9.7.2 *xa-*

Xa- ‘AGT.NMLZ’, an agentive nominalizer, is probably derived from *xayu* ‘male’. Since in Vamale, modifiers usually follow the modified, and possessors the possessum, *xa-* may be an old phrase head, now incorporated into the former modifying phrase. The nominalizer may have developed from a noun phrase with an optionally marked relative clause (78), which was gradually reduced to *xay(u) vwa-tau*, and finally to *xa-vwa-tau* ‘fisherman’.

- (78) *xayu (a=a=) vwa-tau*
 male (REL=3SG) make-impact
 ‘the man who fishes’ (the relativizer *a* is often omitted)

The morpheme means ‘one who does regularly, one whose job is X’, the former meaning being used with a habitual meaning on verbs. It can also attach to stative verbs like *xahnang*, but in this case it is a habitual marker (and not a nominalizer), since the verbs can still take subject index marking: *xa-xahnang-go* ‘you are beautiful, you are a good person’.

- *xa-vabun* ‘thief’
- *xa-moo xada Wanaa* ‘an inhabitant of Wanaa’
- *xa-vap* ‘hunter’
- *xa-vwa suki* ‘buyer’
- *xa-fe-ta-me-mapeke* ‘morning star, light-bringer (lit. AGT.NMLZ-take-go.up-DIR.CP-be.bright)’

The habitual meaning can be extended to express whether something has occurred in general, as in (79).

- (79) *go=pa xa-ha-me*
 2SG=PRF AGT.NMLZ-go-DIR.CP
 ‘You’ve been here before (lit. you’re already a comer).’ [21.07.2019 p.42]

A prefix *xa-* is also used in reciprocal kinship terms. They are listed in Table 9.17, and will be mentioned again in Table 11.2. For many terms, an (re-)analysis of *xa-* as the agentive prefix makes sense, but cognates in other Northern languages suggest a different origin. Note that *mwaan* probably actually means ‘child-in-law of the opposite sex’. By analogy, ‘father-in-law and his daughter-in-law’ may have been *xa-mwaan xayu*, though this word is lost nowadays.

9.7.3 *hun-*

This nominalizer expresses a manner of doing something. Cognates are *u-* in Nelêmwa and *kae-* or *hun-* in Pije (Haudricourt & Ozanne-Rivierre 1982: 253). No etymology is reconstructed yet for either. It often associates with the linker *ka-n* ‘LINK-NSPEC’. For a description of *-ka-n* ‘-LINK-NSPEC’ see §9.7.6.

Table 9.17: Reciprocal kinship terms

Complex form	Gloss of Morphemes	Meaning
<i>xa-bate</i>	<i>xa-tip</i>	‘brothers’
<i>xa-betha</i>		‘sisters’
<i>xaa-vap-an</i>	<i>xa-hunt?-POSS</i>	‘siblings’
<i>xa-fa-thau-n</i>	<i>xa-CAUS-wealth-POSS</i>	‘brother-in-law and sister-in-law’
<i>xa-nya-pwan-an</i>	<i>xa-put-on-POSS</i>	‘paternal aunts’
<i>xa-e-vwona-n</i>	<i>xa-RECP-maternal.uncle- POSS</i>	‘maternal uncle and niece/nephew’
<i>xa-vabu-n</i>	<i>xa-grandchild-POSS</i>	‘grandfather and grandchildren’
<i>xaa-maci</i>	<i>xa-?</i>	‘father and child’
<i>xa-e-bee-n</i>	<i>xa-RECP-brother, cousin, peer-POSS</i>	‘cousins’
<i>xa-ive-n</i>	<i>xa-sister.in.law-POSS</i>	‘sisters-in-law’
<i>xa-xayaa-n</i>	<i>xa-‘stranger, guest’-POSS</i>	‘husband and his brother-in-law’
<i>xa-mwaa-n thamo</i>	<i>xa-daughter-in-law-POSS woman</i>	‘mother-in-law and her son-in-law’

- *hun-moo ka-n* ‘NMLZ-be LINK-NSPEC’ ‘way of life, nature’
- *hun-tiike ka-n* ‘NMLZ-write LINK-NSPEC’ ‘orthography’
- *hun-thêên ka-n* ‘NMLZ-run LINK-NSPEC’ ‘driving style’

As with other derivations, whether *hun-* means ‘style’ or ‘tradition’, or something more idiosyncratic, can depend on the verb. Compare examples (80–83): *moo* ‘to stay’ keeps the same meaning for inanimate and animate subjects (80, 81). However, the derivation of *vii* ‘to say’ takes on an idiosyncratic meaning with inanimate subjects, ‘its meaning’ (82) and it keeps a transparent one with an animate subject: ‘his/her way of saying’ (83).

- (80) *hun-moo ka-n*
NMLZ-be LINK-NSPEC
‘its nature’

9 Verbs

- (81) *hun-moo-a*
NMLZ-stay-3SG
'her/his character'
- (82) *hun-vii ka-n*
NMLZ-say LINK-NSPEC
'(its) meaning'
- (83) *hun-vii-a*
NMLZ-say-3SG
'his/her way of saying it'

Compared to the other nominalizing prefixes, *hun-* is the most neutral one, which casts doubt on the 'manner' meaning postulated above. See example (84), where a nominalization is used because *goon* 'enough' only bears this meaning if it does not subordinate *pala* 'talk'. Otherwise, *goon, ma...* would mean 'permitted, to...', as in (85). The first example does not mention style, only the bare fact of talking.

- (84) *cipa goon hun-pala*
NEG enough NMLZ-talk
'She didn't speak enough.' [vamale-181127-jp_nelemwa-1: 00:02:07]
- (85) *cipa goon ma a=pala*
NEG permitted SUBR 3SG=talk
'She is not allowed to speak.'

9.7.4 *ape-*

The noun *ape-n* 'trace-POSS' seems a probable origin of the locative nominalizer *ape-*. As can be seen in Table 9.18, most of the forms seem to support a locative interpretation, though some are a bit more abstract. Like with other nominalizers, the transitive suffix *-ke*, auxiliary verbs like *vwa*, and other verbal characteristics, do not disappear upon derivation. *Ape-* is also used for the fact of doing something (e.g. *ape-hnyimake-aman* 'fact-think-something, i.e. thought').

9.7.5 Nominalized verb phrases

As well as deriving verbs, Vamale can derive whole verb phrases, the resulting construction being internally a verb phrase with identifiable referents, and externally a noun phrase, that can function as an argument. Consider the Bwa-too example in example (86). Speakers confirmed the acceptability of its Vamale

Table 9.18: Examples of *ape-*

Form	Morphemic Gloss	Translation
<i>ape aman</i>	<i>ape</i> something	wound
<i>ape caaji kan</i>	<i>ape</i> turn LINK-NSPEC	road bend
<i>ape fai mae</i>	<i>ape</i> light fire	fireplace
<i>ape hmwa-goon</i>	<i>ape</i> like-body	half of a length
<i>ape hnyi</i>	<i>ape</i> slip	landslide
<i>ape tabo</i>	<i>ape</i> sit	seat
<i>ape tha xhuuni</i>	<i>ape</i> strike spear-sling	index finger
<i>ape vwa tii</i>	<i>ape</i> there.is mark	writing
<i>ape tuvi</i>	<i>ape</i> draw.liquid	well
<i>ape-n</i>	trace-POSS	its track
<i>ape ta</i>	<i>ape</i> go.up	mountain pass
<i>ape caihnan aman</i>	<i>ape</i> know something	intelligence
<i>ape tahmangke</i>	<i>ape</i> master	expertise

equivalent in (87). In both cases, a ditransitive verb phrase is derived to a noun by dropping the subject marker and adding an article *i=* (or *ani*, in Bwato). This is one way to derive a verb phrase, though the nominalizing prefix *hun-* is also commonly used.

- (86) Bwato (Rivierre & Ehrhardt 2006: 32)
ma-hapi watin ani vetipwaan nya-thii-le ani bwee-xaman
 when done the give to-them the gift

- (87) *(ca)ma koin i=vwatipwe nya-sii-le i=bween-aman...*
 COND end DEF.SG=drop put-hand-3PL DEF=exchange-thing
 ‘When giving the gift to them is done,...’

Another, more lexicalized approach to nominalizing verb phrases, can be found for established nouns with transparent meanings. Contrary to the constructions discussed above, where the nominalized verb phrase’s arguments are nouns with referents, words like *e-topweeke-aman* ‘hook, lit. NMLZ.INS-hang.up-something’, and *e-xhuli-aman* ‘medicinal plants, lit. NMLZ.INS-spittle-something’ use *aman* ‘thing’, a semantically vague incorporated noun which is also found in *xhwi-aman* ‘eat, lit. bite-something’. Note that *aman* changes the stress pattern

of the whole construction as would a phonologically integrated morpheme (see §5.6), which is why it is hyphenated to the verb here.

9.7.6 Nominalization with *ka-n*

Deverbal nominalizations may carry the linker *ka-*, with *-n* ‘NSPEC, ANA’ in generic and anaphoric contexts. *Ka(-n)* follows the nominalized verb to link semantically S/O noun phrases (88).²⁰ It is optional with overt specific noun phrases, see (89). The distribution of *ka* reflects the animacy of the participants: animate S or O cannot take *ka* if expressed covertly (i.e. through affixes), but may take it optionally if overtly present (i.e. as noun phrases), as in (91). In contrast to this, *ka* is obligatory with covert inanimate, implicit participants (92), and *-n* refers to the participant (90).

(88) *i=hun-vii ka i=jaxhut*
 ART=NMLZ-say LINK ART=story
 ‘the story’s meaning/moral’

(89) *i=hun-vii i=jaxhut*
 ART=NMLZ-say ART=story
 ‘the story’s meaning/moral’

(90) *i=[hun-[saxhuti] ka-n]-eong*
 ART;SG=NMLZ-explain LINK-NSPEC-1SG;POSS
 ‘my way of explaining it’

(91) *e=xaleke i=hun-thapi-bwa- i=apuli canbwen*
 1SG=see ART=NMLZ-bash-head- ART=man yesterday
 ‘I saw the murder of the man yesterday.’ (*thapi bwan* is a fixed expression for ‘killing humans’)

(92) **i hun-saxhuti-n*
 ART NMLZ-tell-NSPEC
 (for: ‘its telling, the way to tell it’)

²⁰The Pije cognate is *-a-n*, the Cèmuhî one [tè]- (Rivierre 1980: 273). Note that the optional possessive classifier *ka-* described in §7.3.2 has the Cèmuhî cognate [hè] (Rivierre 1980: 271), but may have merged with this linker in Vamale.

9.7.6.1 Position of *ka-n*

Ka can either appear directly after the nominalized verb: **V *ka* Obj** or, resumptively, after the VP: **V Obj *ka-n* Possessor** (93), illustrated as a tree in Figure 9.5. In this tree, *ka* is shown to be ‘moved’ after the argument before the possessor, like in (93), but it hosts a resumptive morpheme then: *-n* ‘ANA’. This anaphoric use of *-n* also occurs on dependent verbs (§9.3.1.2) and prepositions (§6.5.2). This means that *ka* is not a suffix, since it tolerates a whole noun phrase in between it and the verb root. It also means that *ka*, although likely related to the *s_p/s_A*-marker, is distinct from the latter, since the *s_p/s_A*-marker cannot be used resumptively. As Figure 9.6 shows, the argument expressed with *ka-n* in a possessed nominalization tends to be repeated as a noun phrase afterwards, maybe for better comprehensibility (short-term memory).

- (93) *i=hun-[saxhuti i=jaxhut] ka-n-eong*
 DEF.SG=NMLZ-narrate DEF.SG=story LINK-NSPEC-1SG.POSS
 ‘my way of telling the story’ (lit. the way.of-telling the story of-it-mine)

A related, though distinct function *ka-* is that of semantically unspecified, focused possession (see §7.3.3 on the possessor classifier). The important distinction lies in the classifier’s marked use, whereas the former *ka-* ‘LINK’ is non-marked, though also optional. Both morphemes can function as stand-ins for known or implicit (i.e. non-overt) participants. *Ka* ‘LINK’ is also sensitive to animacy, and can be used resumptively, contrary to the more possessive linker *ka* described in §7.3.2.

9.7.6.2 The role of animacy in *ka-n* nominalizations

In deverbal nominalizations, inanimate S and O are optionally flagged by *ka* ‘LINK’. Animate S and O can only take *ka* as overt NPs, however.

- (94) *e=xaleke i=hun-thapi-bwa- i=apuli canbwen*
 1SG=see ART=NMLZ-bash-head- ART=man yesterday
 ‘I saw the murder of the man yesterday.’ (*thapi bwana* is a fixed expression for ‘killing humans’)

Ambitransitive verbs like *thapoke* ‘to begin (something)’ show that the co-occurrence of *ka-* ‘LINK’ and *ka* ‘SBJ’ is avoided, and only the most agentive participant is marked: derived transitive verbs with both participants present as noun phrases only mark the agent (95), and *ka* ‘LINK’ is seen in nominalizations of intransitive verbs (96) and transitive ones without an overt agent (97). An overview of this distribution is given in Table 9.19, with examples below (95–106).

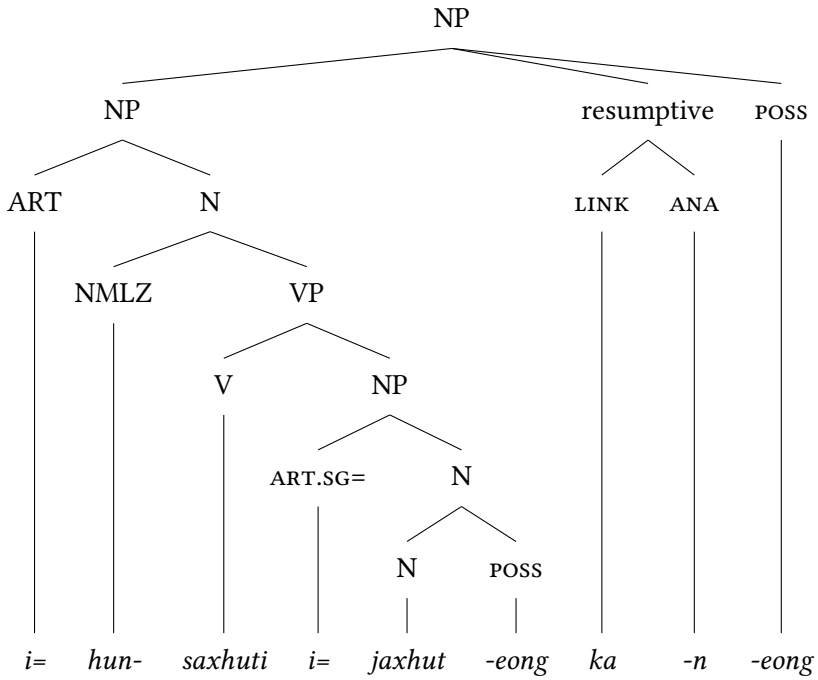

Figure 9.5: Linker *ka* with resumptive *-n*

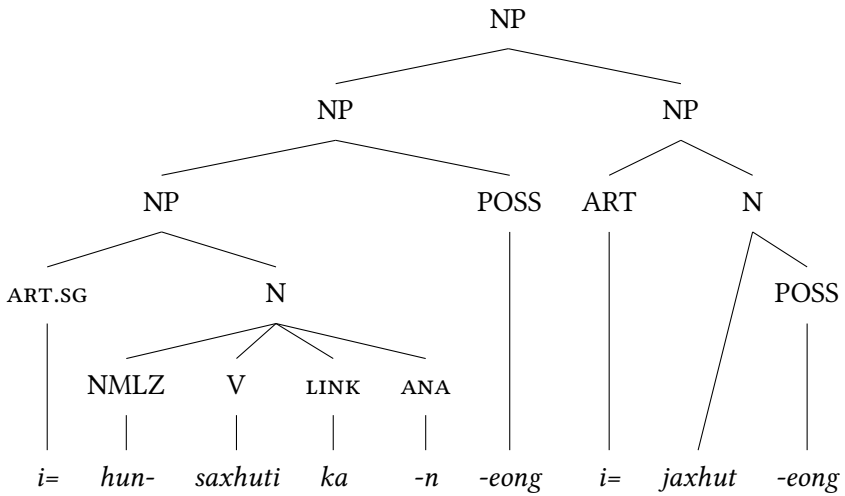

Figure 9.6: Cataphoric *ka-n*

9.7.6.3 Overview of the distribution of *ka* and *ka-n*

- (95) *le=xaleke i=hun-thapoke i=vaa ka li=apuli*
 3PL=see ART=NMLZ-begin ART=war SBJ ART=person
 ‘They saw how the war was begun by the people.’
- (96) *le=xaleke i=hun-thapoke ka i=vaa*
 3PL=see ART=NMLZ-begin LINK ART=war
 ‘They saw the start of the war.’
- (97) *thapoke ka-n vaaya*
 begin LINK-NSPEC work
 ‘the beginning of work in general’

Table 9.19: Distribution of *ka*

Tr.V, covert ARG	inanim. O	<i>hun-V ka-n</i> (sem. A, synt. PSR)	(98)
	anim. O	<i>hun-V-o/ko/a</i> _{OBJ} (<i>ka</i> A)	(99)
Tr. V, overt ARG	inanim. O	<i>hun-V (ka)</i> ARG (<i>ka</i> A)	(100)
	anim. O	<i>hun-V</i> ARG (<i>ka</i> A)	(101)
Itr. V, covert ARG	inanim. S	<i>hun-V ka-n</i>	(102)
	anim. S	<i>hun-V-o/go/a</i> _{Sp}	(103), (104)
Intr. V, overt ARG	inanim. S	<i>hun-V (ka)</i> ARG	(105)
	anim. S	<i>hun-V ka</i> ARG	(106)

- (98) *i=hun-saxhuti ka-n*
 ART.SG=NMLZ-narrate LINK-NSPEC
 ‘the [traditional/proper] way of telling it; its explanation’
- (99) *i=hun-saxhuti-ong*
 DEF.SG=NMLZ-narrate-1SG.POSS/OBJ
 ‘my explanation’ (lit. the way.of-telling-my, no natural occurrence identified)
- (100) *i=hun-saxhuti (ka) i=jaxhut-eong*
 DEF.SG=NMLZ-narrate LINK DEF.SG=story-1SG.POSS
 ‘the way of telling my story’ (the way.of-telling the story-my)

9 Verbs

- (101) *a=vwa ka i=hun-moo ka i=apuli*
 3SG=do SBJ DEF.SG=NMLZ-stay LINK DEF.SG=human
 ‘It’s because of the nature of man.’ [KP:79]
- (102) *na juu e-wanke ka-n*
 DEM real NMLZ-change LINK-NSPEC
 ‘It’s a real change.’ [AG1:486]
- (103) *juu vataan holeeke mwa hun-hma-gavwe*
 real each thank REP NMLZ-arrive-2PL.POSS
 ‘I thank you each again for your coming.’ [L3:6]
- (104) *e=vi tha i=hun-moo i=apuli*
 1SG=say ASS DEF.SG=NMLZ-stay DEF.SG=human
 ‘I’m saying that this is how people are.’
 [2017-08-06 coutumes-maisons-pauvreté:82]
- (105) *i=hun-saxhuti ka-n-eong i=jaxhut-eong*
 DEF.SG=NMLZ-narrate LINK-NSPEC-1SG.POSS DEF.SG=story-1SG.POSS
 ‘my way of telling my story’ (lit. the way.of-telling of-it-mine the
 story-my)
- (106) *a=e-imwi i=hun-see ka In-Fwe ko a=caihna-mwa*
 3SG=REFL-catch DEF.SG=NMLZ-cry LINK F. OBL 3SG=know-REP
li=bee-n
 DEF.PL=peer-3SG.POSS
 ‘[When she arrived at the village] Figtree-Bark restrained her crying
 because she recognized her family.’ [GC:148]

10 Verb phrases

This chapter describes verb phrases. After exploring what constitutes a verb phrase in Vamale (§10.1), various possible parts of the verb phrase are explored. This omits the head verb, which is discussed in Chapter 9. Verbs are mostly modified through analytical means, i.e. by adding words in the same phrase. Prefixes and suffixes that modify a verb, somewhat more rare, are treated under §9.5. This chapter will instead focus on negation (§10.2), serial verb constructions (§10.3.1), bound verbal parts of the VP, and adverbs (§10.4). The last section of this chapter explores comparisons between verb phrases, because the coordinator is derived from a verb (*moo ko* ‘rest on’) (§10.5).

10.1 What is a verb phrase?

A verb phrase in Vamale will be defined as the syntactic unit depending on a verb, i.e. which moves with the verb, disappears if the verb is replaced by a light verb like *vwa* ‘do’ or *hmwaana* ‘do like this’ (1). The verb phrase includes the head verb, its subject and other arguments, and other verbs that stand in a more or less integrated relationship to the head verb, but are neither coordinated nor subordinated verb phrases. Whether TAM markers, subject indexes and other particles should count as part of the verb phrase may be debated, because they still occur with placeholder morphemes, but since the latter were treated under Chapter 9 and the former are described in Chapter 12, we shall concentrate on the elements to the right of the verb. A verb phrase has the following slots available:

ASS TAM NEG SBJ= TAM Pre-V.
↪ Verb (Verb) Manner-V. OBJ SBJ OBL Adv-S

Example (1) shows a complex verb phrase, where *vwa-suki-n* ‘do-price-NSPEC’ ‘to buy’ is the main verb from which depends *xaleke* ‘to see, according to’ with its oblique argument *i mwani-n-eong* ‘my money’. Example (2) shows the same sentence with the placeholder verb *vwa* ‘do’.

10 Verb phrases

- (1) *e=vwa-suki-n xaleke nyako i=mwani-n-eong*
1SG=do-price-NSPEC look OBL DEF.SG=money-POSS-1SG.POSS
'I buy according to my means.'
[vamale-181107-jpnelemwa-06_LR 00:12:24-0:12:26]
- (2) (The main verb is replaced by *vwa*.)
e=vwa xaleke nyako i=mwani-n-eong
1SG=do look OBL DEF.SG=money-POSS-1SG.POSS
'I do it according to my means.'
[vamale-181107-jpnelemwa-06_LR 0:12:26-0:12:28]

10.2 Negation

Negation in the narrow sense, i.e. the process which negates a predicate, uses the particle *cipa*. The existence of something can be negated with the existential negation *cika*, and absence has a dedicated stative verb *ci(e)-a-n*. Disappearing is expressed with the related verb *cii-*, e.g. *cii-le* 'they disappear'. Whether the active verb *ciba* 'refuse to take' is to be counted in this group of negating morphemes is unclear. Note that all of these forms, as well as the prohibitive *cipii*, start with *ci-*, from POc **tikai* 'not exist' (Lynch et al. 2002: 88), and ultimately PMP *(*q*)*ati* (Lynch et al. 2002: 88). A table presenting the most important words is presented below, see Table 10.1.

10.2.1 Verbal negation *cipa*

The negating particle *cipa* is the most common negator. It negates predicates in general, both nominal and verbal ones. This also applies to the other negative forms mentioned above, with the exception of the verb *ci(e)-a-n* 'be absent'. The negating particles occur at the very left of the clause, second only to the assertive *tha* (3).

- (3) *tha cipa=le-caihnan*
ASS NEG=3PL=know
'They don't know.'

Contrary to other Voh-Koné varieties, Vamale assimilates the last vowel in *cipa* to [e] in *e=* '1SG', yielding *cip=e=* 'I don't', as it does with *cala* 'when', *ma* 'SUBR', and the assertive *tha*: there is cross-boundary progressive assimilation, hinting at a proclitical status of *cipa* that *cika* does not have.

Table 10.1: Negative paradigms

Number	Person	<i>cipa</i> 'not do'	<i>ci-</i> 'be absent'	<i>cika</i> 'NEG.EXIST'
SG	1	<i>cipe</i>	<i>ci-e(o)</i>	<i>cika</i>
	2	<i>cipa=go</i>	<i>cia-ko</i>	<i>cika</i>
	3	<i>cipa=a</i>	<i>cia-a</i>	<i>cika</i>
DU	1 INCL	<i>cipa=gasu</i>	<i>cia-gasu</i>	<i>cika</i>
	1 EXCL	<i>cip=abu</i>	<i>cia-bu</i>	<i>cika</i>
	2	<i>cipa=gau</i>	<i>cia-gau</i>	<i>cika</i>
	3	<i>cipa=lu</i>	<i>cia-lu</i>	<i>cika</i>
PL	1 INCL	<i>cipa=gase</i>	<i>cia-gaa</i>	<i>cika</i>
	1 EXCL	<i>cipa=be</i>	<i>cia-be</i>	<i>cika</i>
	2	<i>cipa=gavwe</i>	<i>cia-vwe</i>	<i>cika</i>
	3	<i>cipa=le</i>	<i>cie-le</i>	<i>cika</i>

10.2.2 Existential negation *cika*

The negative existential *cika* is used to express that something does not exist (4). It is the opposite of *vwa* 'exist'. There is no word for 'to have' in Vamale; this is expressed with a EXIST X-POSS construction, i.e. by possessing an NP (5). *cika* is also used as a more formal, or more marked, equivalent of *ûhû* 'no'.

- (4) *cika* *we*
 NEG.EXIST water
 'There is no water.'

- (5) *cika* *nyamaa-n*
 NEG.EXIST eye-POSS
 'He is blind (there are no eyes of his).'

10.2.3 Other negative expressions and lexical items

cika is also used to express a "negative comitative" for inanimate nouns, using *ko-* 'on' i.e. 'I don't have it on me', see (6). A dedicated stative verb expresses absence: *ci-eo/cia-ko/ci-ea*. Like the dependent verbs discussed in §9.2.1, *ci-* is able to take generic *-n*, for non-specific and recently mentioned inanimate participants, see

10 Verb phrases

(7). This latter form is also part of *vacian* ‘lose’ which I assume was formerly complex: *va(-)cia-n* ‘lose (lit. make absent)’. While there are a few other forms that can be decomposed into *va-* and a verb, e.g. *va-tipwe* ‘drop (lit. make-fall.TR)’ and *va-cut-i* ‘raise (lit. make-stand-TR)’, this is not a productive word-formation process any more.

- (6) *cika ca=mwani ko-ong*
NEG.EXIST INDF.SG=money on-1SG
‘I have no money with me.’

- (7) *li=xhaohmu habu cipa gase=mu vwa mwa ja mu*
DEF.PL=elder long.ago NEG 1PL.INCL=FREQ do house PRF ITER
cia-n mwa
absent-NSPEC REP
‘The elders back in the day, we don’t build houses anymore, this has progressively been lost, now.’ (lit. ‘this is absent, now’) [KL:80]

Focused negation, used to negate one element rather than another (‘not *sticks* but *rocks*’), is achieved by fronting (8), like other focusing strategies in Vamale: *tha cipa sukaa kavi tapang* ‘ASS NEG sugar but tobacco’ ‘this is not sugar but tobacco’.

- (8) *cipa sinu kavi cika wii-n xaleke*
NEG suffer but NEG.EXIST strength-3SG.POSS see
‘It doesn’t hurt but there’s no strength in it, you see.’ [KG:101]

10.3 Verbal elements of the verb phrase

A verb phrase is composed of the head verb and its arguments, possibly other head verbs in the case of serial verb constructions, subordinate verbs, and adverbs (which are discussed in §10.4). Among complex verbs, two groups are distinguished by this analysis: serial verb constructions, where several main verbs co-exist in the same phrase, and asymmetrical verb strings, where a head verb is modified by dependent verbs. While there is considerable functional overlap between the two groups, only serial verb constructions describe a complex event by naming the simultaneous or consecutive actions, while verb strings are restricted to modifying a verb as an adverb would. A third group called “complex verb strings” posited for Nêlêmwa was not found in Vamale.

Serial verb constructions (SVC) in Vamale are a common way to describe a complex event or to modify a verb. Serial verb constructions are defined by Brill (2004b: 169) as:

- constituting a single predication/clause
- constituting a single prosodic entity
- sharing syntactic arguments, a single set of pronouns and arguments
- sharing TAM markers
- sharing illocutionary force
- sharing polarity
- referring to aspects of a single event

To this, Brill adds a criterion of contiguity for Nêlêmwa, with directionals such as in (9) counting as the only valid disruption of the verb chain (Brill 2004b: 169). This may be present in Vamale, but could not be distinguished safely from primed calques in elicitation contexts, and was not (to the knowledge of the author) found in unprompted speech.

- (9) *I u â kuut mwadu axi axamalileny ebai nu*
 3SG PRF leave stand down.there see these2.DIST then coconut
malileny.
 these2.DIST
 ‘He leaves, stands down there, sees these two coconuts.’

There are three types of serial verb constructions common in Oceanic languages: *nuclear*, *core*, and *adjunct* serialization (Brill 2004b: 168).

Nuclear serialization features contiguous verbs (sVVo) and are the most common type in New Caledonian languages. *Core-layer serialization* has non-contiguous verbs, either with the same subject, or with switch-subject constructions: sV sV(o) (I run I catch [him]) or sVo (s)V (I strike him [he] dies) (Brill 2004a: 4). These meanings would be expressed in two clauses in Nêlêmwa, “serial verb constructions have one single prime argument and one single patient [sVV(V)(o)]; [sV sV] patterns would constitute two independent clauses with a pause inbetween, not a serial construction.” (Brill 2004b: 168) They are not attested in Vamale either. In *adjunct serialization*, a head verb has a second, adjunct verb. These adjunct verbs cannot head a verb phrase on their own. In this grammar, they are called “manner verbs” and described in §10.3.2.2, as part of asymmetric verb strings.

10 Verb phrases

- (10) *a=siva taeke i=oot*
3SG=attach do.badly DEF.SG=rope
'He attached the rope badly.'
[vamale-181107-jpnelemwa-05: 00:01:06-00:01:07]
- (11) (Possibly a word play on the previous example)
a=siva vee-ke i=oot
3SG=attach fuck-TR DEF.SG=rope
'He attached the rope badly (by messing around).'
[vamale-181107-jpnelemwa-05: 00:01:11-00:01:12]

Another type of verb phrase including various verbs are asymmetric strings, called “complex predicates”¹ elsewhere (Bril 2004b: 168). These can include a head and an adjunct as in (10) (manner verbs are adjuncts), a head and a modal verb, e.g. *thapoke mapeke* ‘begin bright’, ‘it is beginning to dawn’ (preverbs are modal verbs), or a compound whose meaning is different from the meanings of its components (Bril 2004b: 168). A Vamale example of the latter would be *moo han* ‘stay go’ ‘be a nomad’, or *han thêên* ‘walk run’ ‘chase after’, see §9.6.2. In any case, where serial verb constructions feature several main verbs, an asymmetric verb string is characterized by a head verb and a dependent one. Two classes of these are the preverbs and manner verbs discussed under §10.3.2.1 and §10.3.2.2, respectively.

10.3.1 Serial verb constructions

Serial verb constructions in Vamale are commonly used to link a motion to a purpose (12), with the motion verb always first, e.g. *han moo* ‘go stay’ ‘go to stay somewhere’. Most SVCs combine two verbs, but there are longer ones, e.g. (13) and (14). Both the motion and purpose are carried out by the same subject.

- (12) *ta contrôler li=carton ko-n jo, contrôler*
go.up check DEF.PL=BOX OBL-NSPEC chicken check
meeke-n han han na bwaa ...
everything-NSPEC go go DEM IPFV
'She went up to check the boxes of frozen chicken, check everything bit
by bit/check everything while walking through it, it's still ...'
[KG:473-747]

¹As predicates can be formed with other word classes as well, I use a more explicitly verb-focused term.

- (13) ...*ma le=bwa hup-e wati thapi-bwa-le,*
 ...SUBR 3PL=IPFV go.down-DIR.CP chase.after smash-head-3PL.POSS,
watii-le koma bwa vwa ca=le=vwa-suki-aman
 chase.after-3PL to IPFV do INDF.PL=3PL=do-price-thing
 ‘When they came north, chased and slew them, chased them to them [lit.
 do something that they would pay the price punish].’ [DT:12]
- (14) *kona e=ta-me ta-me thaloot hup-wa sohmun*
 CNJ 1SG=go.up-DIR.CP go.up-DIR.CP appear go.down-REP study
 ‘Then I would go up, up, come out (on top of the hill), walk down again
 (on the other side) to study.’ [PE2:16]

A motion verb *han* ‘go’, *hut* ‘go down’, *ta* ‘go up’, *hnuut* ‘move upstream’ etc. may also be introduced because it can host a centripetal suffix *-me* (15), unlike non-motion verbs. This allows the construction to have a centripetal suffix. In (16), *hame* ‘come’ means that the drinks are aligned in such a way that the tastes change as one moves along them. Crucially, the movement does happen, meaning the motion verb is a full verb and not grammaticalized (for which see §10.3.2.3).

- (15) *kona sili sahmwa ha-me sili sahmwa ha-me*
 CNJ sew the.other.way go-DIR.CP sew the.other.way go-DIR.CP
 ‘And then he backs up, backs up.’ [KG:467]
- (16) *thapoke cuut aligner li=parfum ha-me hmwaani, tulem li,*
 begin stand align DEF.PL=flavor go-DIR.CP like.this tulem DEF.PL
aligner ha-me li=oro li=joakan aman
 align go-DIR.CP DEF.PL=ORO DEF.PL=big thing
 ‘(So I) start and stand there and align the flavors while coming (out of the
 container), the *tulem* sodas, the...align the *oro* sodas, the big ones.’
 [KG:277-279]

Motion verbs can also co-occur in an SVC, to describe the path of the subject more precisely. In (17), the motion is first specified as aimless and slow (strolling), then a Ground is linked to it (beach) with a precise motion verb (follow). In (14), however, the speaker describes in detail a long journey to school, with studying as a purpose in the end.

- (17) *a e-thana saxhuti hmeewan*
 3SG MID-stroll follow sand
 ‘She goes for a stroll along the beach.’ [181107 p.96]

10 Verb phrases

Another use of SVCs is to link an action not to its direction, as described above, but to its manner. In (18), a rather abstract action is done while considering the available funds.

- (18) *e=vwa xaleke nyako li=mwani-n-eong*
1SG=do look for DEF.PL=money-POSS-1SG.POSS
'I do (buy) according to my means.'
[vamale-181107-jpnelemwa-06_LR 00:12:24-0:12:26]

Other serial verb constructions are in muddy waters between true, clear SVCs and grammaticalized constructions (which would make the concerned construction an asymmetric verb string). Compare *han sate-n* 'go,leave be.different-NSPEC' 'leave separately' and *saten han* 'leave afterwards'.² While the first meaning is rather transparent, the second is more lexicalized. However, many common SVCs accumulate connotations, while retaining an ambiguity with the literal meaning.

10.3.2 Asymmetrical verb strings

The following section will first introduce so-called preverbs, bound verbs that modify the head verb by preceding it, amongst which a prominent example is *se-me* 'all together (lit. same-all)'. Other bound parts of the verb phrase may include manner verbs, which are bound like the pre-verbs, but follow the head verb. TAM particles precede the predicate, not the verb phrase, and are discussed under Chapter 12.

10.3.2.1 Preverbs

Vamale has a series of elements which cannot nowadays be the head of a verb phrase. Some have nominal origins, like the ones in Table 10.2, while others have free verbal counterparts, often with a transitive meaning e.g. *vataan* 'each', *vathanke* 'do separately, separate'. Preverbs occur directly before the verb root. The commonly used members include *vataan* 'each' (19), *xadaa* 'on the other hand' (21), *daa* 'do first' (23), *xhose* 'repeat' (20), *xhwat* 'a little bit'³ (24), *xhopwe* 'on top of that', *balan* 'just' (25). In addition to having different word-class status, some preverbs have homophonous equivalents with a different distribution, e.g. *vataan*, which also occurs before nouns, and *balan* exists as an aspect marker (§12.6). The two preverbs *mee* 'all' and its complex form *se-me* 'all together' are discussed in the two sections to come, as examples of this multi-functionality.

²vamale-181107-jpnelemwa-06: 00:05:11- 00:05:46

³Compare *xhwat apuli* 'little man', *xhwatin* 'be small', *xhwatiike* 'do slowly'.

Table 10.2: Preverbs and their free counterparts

Form	Free form meaning	Preverb meaning
<i>xhwat</i>	‘small piece’	‘do a bit’
<i>balan</i>	‘part of long object’	‘just do; do anyway’
<i>xadaa</i>	‘turn to do something’	‘on the other hand, do unexpectedly’

- (19) [*hmwaka li=buke*] [*tha=abe=[vataan [vwa buke]]*]
 like DEF.PL=flower ASS=1PL.EXCL=each do flower
 [*tha=abe=vataan cami*]
 ASS=1PL.EXCL=each plant
 ‘Like the flowers, we each grow flowers, we each plant them.’ [AG1:68]
- (20) *xhose vii!*
 repeat say
 ‘Say (that) again!’ [GL:41]
- (21) *xadaa-go ma go=saxhuti eca=se*
 turn-2SG SUBR 2SG=narrate INDF.SG=other
 ‘It’s your turn to tell another [story].’ [traditional end of a story]
- (22) *ko go=[[xadaa siva] nya-xada] go xadaa hmwaani*
 CNJ 2SG=otherwise attach towards-up.there then otherwise like.this
 ‘Then you attach it one way, and then, another way, you do like this.’
 [KG:162]
- (23) *go=bwa juu [[da [tabe i=se carton]] [hnya-ut pu]]*
 2SG=IPFV real first lift DEF.SG=one box PROX-move.down ground
go=bwa fe i- aaa cana
 2SG=IPFV take DEF.SG EXPL vagina
 ‘You just start by lifting one box from the ground, then you take the
 (next), aah shit...’ [KG:285]
- (24) *lu=vwa ma lu=xhwat cu-vathan-ke li=see vuman nyu*
 3DU=do SUBR 3DU=a.bit stand-individually-TR DEF.PL=same group fish
nyala ka muu-hni
 there SBJ DEM.DU-PROX
 ‘The two did so that they quickly surrounded the same school of fish
 there.’ [GP:57]

10 Verb phrases

- (25) *na i=s-ung tha balan hmwaani*
 DEM DEF.SG=hand-1SG.POSS ASS continue like.this
 ‘It’s my hand, it stayed [stiff] like this.’ [V]

10.3.2.1.1 *se-me(e)* ‘together’

The stative verb *se* ‘be one/same’ has two meanings, depending on the context. One is the verbal form, predicatively used, meaning ‘be alone, be one’. This is a comparatively rare function, shown in (26).

- (26) *i=apuli a= se-a*
 DEF.SG=person REL= one-3SG
 ‘the person who is alone’

When following a singular article, it means ‘the other’ or ‘another’, see (27). This is discussed in more detail in §8.4.1.

- (27) *hê vwa li=been xada a= mu moo ma ca-se*
 yes EXIST DEF.PL=peer up.there REL= ITER stay COM INDF.SG-other
thamo lu=moo ma ca-se xayu
 woman 3DU=stay COM INDF.SG-other man
 ‘Yes there are some, up there, he’ll stay with some other woman, she’ll stay with some other man.’ [AG1:339]

The last meaning of *se* is ‘be one/same’. It is used either as a verbal predicate, with singular nouns (28) as well as plural ones (29). It can also be used before definite nouns to mean ‘the same’, as in (30) and (31).

- (28) *meeke li=yavo, a=taemwi ka i=apuli a= se*
 all DEF.PL=fishing.line 3SG=grab SBJ DEF.SG=man REL= same
 ‘All the fishing rods are held by a single man.’ (lit. ‘All the fishing rods, a single man holds (them).’) [J5:70]

- (29) *lu=xhajake li=uvu a= see*
 3DU=eat.starchy DEF.PL=yam REL= one
 ‘They eat the same yams.’ [J5:62]

- (30) *lu=moo ca se mwa-n-lu*
 3DU=stay in one house-POSS-3DU.POSS
 ‘They stay in the same house.’ (lit. ‘They stay in one house of theirs.’)
 [J5:58]

- (31) *i=that cipa xa-sivu ca la a= se la*
 DEF.SG=wind NEG HAB-blow in location REL= one location
 ‘The wind does not always blow in the same place.’ (lit. The wind is not a constant blower in a place that is one/the same place) [J4:14]

Finally, *se* can form a compound with the preverb *me(e)* ‘be all’; the result is both a pre-verb meaning ‘do something all together’ and a “pre-noun” meaning ‘all of X’ (32–34). Note that the former function is only attested for the compound *se-me*, and only with free pronouns.

- (32) *see-me gaa, gase=see-me vwa ka see-me gaa*
 same-all 1PL.INCL 1PL.INCL=same-all do SBJ same-all 1PL.INCL
 ‘All together, we all do this together.’ [J6:1]
- (33) *m=abe=bwa vwa nettoyage h=abe thai*
 SUBR=1PL.EXCL=IPFV do cleaning TOP.REP=1PL.EXCL pick.up
li=vaisselle-ea, ya, ja me abe mwa
 DEF.PL=dish-3SG.POSS EXCL PRF all 1PL.EXCL REP
 ‘When we do the clean up we’ll pick up her dishes, well - we all as well.’
 [AG1:428]
- (34) *le=ha-me ka (*mee le) meeka le*
 3PL=go-DIR.CP SBJ all 3PL all 3PL
 ‘They all come.’ [vamale-181127-jp_nelemwa-1: 00:01:11-00:01:17]

10.3.2.1.2 *mee* ‘all’

The morpheme *me(e)* ‘all’ is likely the origin of the derived form *mee-ka-n* ‘everything, everywhere’⁴ suggests it was originally a free verb (see §10.4.2 on the adverb and §8.4.2 on the quantifier). However, *me(e)* is not attested as a head verb in Vamale, and western Voh-Koné languages only feature the nominalized form *meeka-n* ~ *meena-n* (Rivierre & Ehrhardt 2006: 211); no independent verb *me* is attested in the language family today. *me(e)* is mostly used preverbally, see (35) and (36), but it is also attested before a prepositional phrase, as in (36). Interestingly, *me* does not only add a meaning of ‘to all do’, but can also, at least when the subject is singular, signify implicit plural referents “all-ness”, i.e. that all members of the referred-to group of referents are concerned (37, 38). This was only attested

⁴ *meeka-n* was probably structured *mee ka-n*, with the s/p-marking clitic *ka* ‘ABS’ found in nominalizations, further discussed under §9.7.6.

10 Verb phrases

twice. As a prefix, it occurs in combinations with demonstrative pronouns, as for *me-ehni* ‘all those’ (§8.2.2). This double occurrence as a pre-verb and a prefix on pronouns is unique in the language. This grammar distinguishes the pre-verb and the prefix *me(e)*, and hypothesizes a verbal origin based on the derived form *meeka-n*’s morphology.

- (35) *i=se a= lu=mee hup-e ya a=bwa ta xale*
 DEF.SG=other REL= 3DU=all go.down-DIR.CP 3SG 3SG=IPFV go.up look
 ‘The other who came with (lit. the other that the two came down together) went up [in the gas station] to look around.’ [KG:471]
- (36) *gaa=me ca i=mwani mwani mwani, cama li=xhaohmu*
 1PL.INCL=all in DEF.SG=money money money when DEF.PL=elder
habu, le, tha cika mwani-n-le
 long.ago 3PL ASS NEG.EXIST money-POSS-3PL.POSS
 ‘We all are about money, money, money, but the elders back then, they didn’t have money.’ [KP:102]
- (37) *go=mee vwa ko na yamaan-go juu en-go, go, hê*
 2SG=all do because DEM unmotivated-2SG real fine-2SG 2SG yes
 ‘You did all that [punishments] because you were fed up [with school], you’re a real fine one, yes.’ [PE2:30]
- (38) *ma gavwe vwa ehni a me vi*
 SUBR 2PL do DEM REL.3SG all say
 ‘May you do all he says.’ (lit. May you do this, that he will all say) [HC19:7]

10.3.2.2 Manner verbs

“Manner verbs” are, so to speak, halfway between full verbs and more bound morphemes like the prefixes described in §9.5.1. They can neither occur alone, nor can they occur in the first position of the verb phrase, or be fronted there. They cannot take arguments or subjects, and modify the head verb. They cannot add arguments to a verb phrase either. Members include *thuan* ‘do well’ (39), *tatu* ‘do quickly’, *sisipo* ‘do together’,⁵ *xhwatiike* ‘do quietly, softly’.

- (39) *e=holeke thuan i=vaaya a= gavwe=vwa sisipo*
 1SG=thank do.well DEF.SG=work REL= 2PL=do do.together
 ‘I thank you for the work you did together.’

⁵Diachronically related: *nya-sipo-ke* ‘put-together-TR’.

10.3.2.3 Grammaticalized motion verbs

A motion verb can come after verbs describing another action, but the former then has other functions than to contribute its lexical meaning. The motion verb may serve to express a spatial boundary as in (40) (compare this to (41), where a similar role is played by *seen* ‘border’), or to express a temporal boundary, such as in (42), where *ha-me* ‘go-DIR.CP’ ‘come’ means ‘until now, up to now’. Since nothing actually moves and the motion verb has no subject, the semantically idiosyncratic sequence of a main verb and a motion verb that modifies the former is an asymmetric verb string. Koch calls this function “associated motion” (Koch 2021).

- (40) *moo cahni gase=xaleke hma-ca-mwa xahan ko i=jahoot*
rest here 1PL.INCL=see arrive-go.up-REP over.there on DEF.SG=river
‘From here we can see up to the river (and beyond).’ [181107 p.96]
- (41) *moo cahni gase=xaleke seen xahan ko i=jahoot*
rest here 1PL.INCL=see border over.there on DEF.SG=river
‘From here we can see until the river (but not beyond).’ [181107 p.96]
- (42) *xethoo na la la, ha-mwa-me naen bwa vwa*
landing.net DEM be.here be.here go-REP-DIR.CP now IPFV EXIST
épuisettes
landing.net
‘Landing nets, it’s a recent thing, it has come about now that there are landing nets.’ [KL:188]

10.3.2.4 Iterative *han*

han is used to express iterativity, and can be used before, see (43) and (44), or after the other verbs (45). This is a rather grammaticalized function and although it latches onto serial verb constructions, the resulting whole qualifies as an asymmetric verb string (composed of an SVC and a modal verb).

- (43) *gaa=vwa ma fa-pupwaale, gavwe=han pala thuan*
1PL.INCL=do SUBR speak.language-European 2PL=go talk do.well
‘...we busy ourselves with speaking French, you have come to speak it well.’ [HC19:42]
- (44) *ko tha=ga=han pa xaleke naen*
CNJ ASS=1PL.INCL=go PFV see now
‘And we see by now,...’ [HC19:40-42]

- (45) *e=bwa mu tena ha-mwa*
 1SG=IPFV ITER hear go-REP
 ‘I heard about it all along.’ [Tipije]

10.4 Adverbs

Vamale does not productively derive adverbs from verbs, and instead commonly forms adverbial clauses with *ca-n* ‘in-NSPEC’ (see §14.2.2). Some of these have become established expressions, e.g. *can hawân* ‘vis-à-vis (lit. in its possession/visible dependency)’. Similarly to manner verbs, adverbs can modify a verb and are optional. Adverbs can also modify nouns, as well as occur alone at the edge of the clause, see (46), where *naen* ‘now(adays)’ is used at the end of the first clause, and after the conjunction, at the beginning of the following clause.

- (46) *cipa hmwakan naen, ko naen a=xaahni eca=lit a...*
 NEG like-NSPEC now CNJ now 3SG=look.for INDF.SG=bed CNJ
eca=matelas a
 INDF.SG=mattress CNJ
 ‘It’s not like now, because now he looks for some bed or some mattress (instead of sleeping on a pandanus mat).’ [KP:40]

Semantically, most adverbs situate the action in time and space. They constitute a relatively small class. Among the temporal adverbs are *naen* ‘recently, now, later today’, *xahmaen* ‘tomorrow’, and *can-bwen* ‘yesterday (lit. at-night)’ as well as *mati* ‘earlier today’ and *jimin* ‘last night past bedtime’. Vamale has no dedicated words for ‘always’, ‘often’, ‘sometimes’, or ‘rarely’. These meanings are expressed using the frequentative particle, the habitual prefix, and other forms (47). For occasional occurrences, no matter the frequency, *calibeen* ‘sometimes, not always’ is used.

- (47) *xa-pala hnyana kavi pa cipa=a pala*
 HAB-talk constantly but PFV NEG=3SG talk
 ‘He talks all the time but now he doesn’t.’ [B2:145]

Spatial adverbs are as numerous as movement verbs, as they form with the locative prefix *xa-*, or *hnya-* ‘towards’ on a movement verb. Compare *xa-hut* ‘LOC.ADV-go.down (below)’ and *hnya-ut nya-xa-hut* ‘down towards the general area down there’. There are also spatial adverbs not derived from verbs, such as *xala-n* ‘under’ or *paathabu-n* ‘before, in front of’. There are other spatial adverbs

derived from verbs that do not denote movement. One prominent example is *meeka-n* ‘everywhere’, ultimately derived from the stative verb *mee* ‘all’ (further discussed in §10.4.2).

10.4.1 Spatial adverbs and proximity

Vamale distinguishes three main degrees of proximity via adverbs, which are unrelated to the demonstratives in §8.2.2. The adverbs *xa-hut* ‘down there’, *xa-da* ‘up there’, and *xa-han* ‘over there’ form the basis of this system, and do not by themselves specify the distance of the referent.

The closest ring, *nya-ut/nya-da/nya-an* ‘just there’, is composed of (*h*)*nya* ‘put, give’ and a (sandhied) form of a motion verb. It is often accompanied by *la* ‘be.here’, i.e. *nya-ut la* ‘right here (below me)’. Things in this ring are at a hand’s reach or figuratively so. *nya-an xa-han* ‘farther than over there’ is farther than either simple *nya-an* or anything previously qualified as *xa-han*. The last ring contains a repetitive morpheme *mwa* ‘REP’: *nya-a-mwa xa-han* ‘even further over there’.

10.4.2 *meekan* ‘everywhere’

A related form of *mee* ‘all’ described above (§10.3.2.1.2) is the adverb *meekan* ‘everywhere’. It appears at the fringes of constituents: ex. (48) stands between a verb and its adjunct *can mwa* ‘in the house’, and in (49) it modifies a prepositional phrase. Unlike the quantifier *meeka-n* (§8.4.2), *meekan* does not shed its *-n* before specific noun phrases.

(48) *vwa meekan ca i=mwa*
 EXIST everywhere in DEF.SG=house
 ‘It was everywhere in the house.’ [KG:26]

(49) *na wanke mae can mwa meekan*
 DEM change light in house everywhere
 ‘The lights had changed everywhere in the house.’ [KG:84]

10.5 Comparison

Verb phrases can be coordinated for comparative purposes using *moo ko*, literally ‘rest on’, see (50).

10 Verb phrases

- (50) *gase=xadaa han-mwa can saten* 1PL.INCL=however walk-REP
moo-ko i=hun-moo-gaa
 ADV.SUBR differently
 CPR DEF.SG=manner.NMLZ-stay-1PL.INCL.POSS
 ‘We, however, walk yet differently from our [real] culture.’ [RP:48]

moo-ko also means ‘to come from’, as in (51) (further discussed in §9.4.7). Another construction yet is prefaced by *thalloo* ‘two’ and means ‘be of two sorts’, as in (52) and (53). Note that *moo* ‘stay’ takes on a meaning of ‘be’ in the common nominalized form *hun-moo* ‘manner.NMLZ-stay’ ‘culture, nature’.

- (51) *hmwakan cama thamo ha-me hoot, na le=o enseigner ma api*
 perhaps if woman go-DIR.CP be.far DEM 3PL=IRR teach if COMP
a=ha-me moo hoot
 3SG=go-DIR.CP stay be.far
 ‘Perhaps if a woman comes from afar, they [the local women] will teach her, if she comes from afar.’ [AG1:429-430]

- (52) (Proverb)
vi ka vwa, tha juu e-thalloo moo koo-n
 say CNJ do ASS really MID-two stay ON-NSPEC
 ‘Saying and doing are two different things.’

- (53) *hê ena thalloo moo koo-n*
 yes DEM two stay ON-NSPEC
 ‘Yes exactly, there are two kinds [of bees].’ [KM:29]

11 Voice

“Voice” in this grammar refers to various kinds of mapping semantic relations onto grammatical relations. Phenomena discussed in this chapter include reflexive, reciprocal, and middle constructions, all marked by the prefix *(v)e-*, discussed in §11.1, and the causative constructions prefixed by *fa-* (§11.3). A brief section on agent-omitting constructions is added for completion.

11.1 Reflexive and reciprocal

Vamale prefixes verbs and nouns with *e-*, a morpheme that can have reflexive, reciprocal, and middle functions. It is a reflex of POc *pa(R)i- (Pawley 1973: 151–152). The reconstructed meaning of *pa(R)i-...-i is that of “mutual interaction between the entities denoted by the subject of the verb” and refers to “unified or conjoined action by a plural subject, or repeated action by a singular subject, or unification of objects” (Pawley 1973: 151–152). These reconstructed functions did not include reflexive. The reflexes of *pa(R)i- described today did not retain all of the meanings reconstructed for the Proto-Oceanic form. See Table 11.1 for an overview of the reconstructed functions, which ones were retained in Vamale, and where in the chapter the retained functions are discussed.

11.1.1 Reflexive

Reflexive constructions function in two ways. Either the subject marker and the object marker denote the same referent, as in example (1).¹ This is the most common way of forming a reflexive construction.

- (1) *e=vwa-khêt-eo*
1SG=do-blade-1SG.OBJ
'I shave myself.'

¹*khêt* originally meant ‘quartz’. Knives were also made from shells (mangrove oysters (*thala*) gave their name to today’s steel knives, though the word may have come from a Polynesian word for knife (*h)ele*, Hollyman 1959), or reed and bamboo shards called *xadan o* ‘shard of bamboo’.

11 Voice

The other possibility is with the prefix *e-* ‘REFL’, formerly *ve-* (Leenhardt 1946: 585),² see (2). This *e-* is distinct from the instrumental *e-* (§9.7.1), e.g. *e-vwadi yan* ‘thumb (lit. NMLZ.INS-peel.with.fingers starchy.food-POSS)’. Nêlêmwa cognates are *ve-* ‘NMLZ.INS’ and *pe-* ‘RECP’ respectively (Bril 2002: 171). Note that Nêlêmwa does not use *pe-* with a reflexive meaning (Bril 2005: 24), nor is Proto-Oceanic **paRi-* reconstructed to have had a reflexive function.

Table 11.1: Functions of Proto-Oceanic retained in Vamale, after Bril 2005: 28

Function and morph. makeup	Vamale example	Section
Collective actors (<i>paRi</i> , <i>paRi-...-i</i>)	<i>e-moo</i> ‘all stay’	§9.5.4
Collective entities, grouping (<i>paRi</i> , <i>paRi</i> +root reduplication)	<i>e-tipwa</i> ‘all fall (not strictly at the same time)’	§11.2.3
Reciprocal actors (<i>paRi</i> , <i>paRi-...-i</i>)	<i>e-thaut</i> ‘have a fight’	§11.1.2
Comparison (<i>paRi</i>)	<i>e-hmwakan</i> ‘be the same’	§11.1.2.1
Iterative actions (<i>paRi</i> , <i>paRi-...-i</i>)	<i>e-hmain</i> ‘more and more’	§11.2.2
<i>Not retained:</i>		
Intransitivizing, depatientive function (<i>paRi</i> , <i>paRi-...-i</i>)		
Reciprocal or associated OBJ (<i>paRi</i>)		
Reference to states and properties (<i>paRi</i> and reduplication)		
Root reduplication in general was not retained		

- (2) *go=e-vwa-khêt*
 2SG=REFL-do-blade
 ‘You shave yourself.’

Self-directed actions in Bwatoö are only marked with *e-* for a few verbs of grooming or cognition, and still use coreferential arguments, i.e. object suffixes (Bril 2005: 34). This is not the case in Vamale, where cognition verbs do not need object suffixes, e.g. *go e-hnyimake* ‘2SG REFL-think’ ‘you think to yourself’ and *e-fwajimwake* ‘REFL-ask’ ‘to ask oneself’. Grooming verbs may take it or not. The

²Chief Luc Katelia Oué still uses *veca* ‘learn’, where most younger speakers use *eca*. Usa Vamale, Temala Hmwaveke, and Fa Tiéta (still) tend to use *vi* ‘DEF.SG’ where Coastal Vamale has *i*.

reflexive is productive, but has become lexicalized in certain forms as well, e.g. *wago* ‘encourage’ → *e-wago* ‘persevere’.

11.1.2 Reciprocal

The reflexive *e-* can also express reciprocity and middle functions. Interestingly, the reflexive function developed from the reciprocal marker (Bril 2005: 26). Dixon describes the Fijian reflex *vei-* as more collective than reciprocal (Dixon 1988: 256). The prefix follows the subject marker, but *e-* and the object markers are mutually exclusive in a reflexive context (a possible, poorly understood exception are grooming verbs). They can (and actually do) however cooccur in a reciprocal reading. The construction in (3) without the object suffix (*lu=e-xaleke*) means ‘they see themselves’. Reciprocal prefixes are also found on nouns (5).

Examples of lexicalized forms are *e-thuang* ‘tease each other’ which contrasts with *thuang* ‘joke’, and *e-canim* ‘play hide-and-seek’, from *canim* ‘hide oneself from someone’.

- (3) *lu=e-xale-lu*
 3DU=RECP-see-3DU.OBJ
 ‘They see each other.’ [After 07.11.18 p.93]

- (4) *lu=xale-lu*
 3DU=see-3DU.OBJ
 ‘They see them.’

- (5) *lu=e-copain-copine*
 3DU=RECP-boyfriend-girlfriend
 ‘They are boyfriend-girlfriend.’ [AG1:299]

11.1.2.1 Comparison and symmetry

The middle prefix, for certain words, expresses symmetry between two or more entities. This meaning of ‘same’ expressed with *e-* ‘MID’ rather than *se* ‘one, same’ appears reliably on verbs and their derivatives, such as *e-hmwakan* ‘MID-same’ ‘be the same’ and *e-hmwa-goon* ‘MID-same-body’, ‘be of same length’ (6), whereas nouns differ. Compare *se fedala-lu* ‘They have the same blood (same blood-3DU.POSS)’ and *e-wada-lu* ‘They have the same age’ (7).

- (6) *e-hmwaa-go-lu*
 RECP-like-body-3PL.POSS
 ‘They are equally long.’ [example for the dictionary]

11 Voice

(7) *e-wada-lu*

RECP-time-2DU.POSS

‘They(2) have the same age.’ (but: *nievit joo-n?* ‘how.many year-3SG.POSS’
‘how old is s/he?’) [07.11.18 p.95]

11.1.2.2 Reciprocal relationships

The prefix *e-* also occurs on possessed nominals to express a reciprocal relationship outside of the family (5) and (8). Reciprocal relationship nouns for family members (“symmetrical kinship and dyadic relationship”, Bril 2005: 48) are an own lexical field, prefixed with *xa-*.³ A non-exhaustive list is found in Table 11.2. These reciprocal relations do not extend beyond the lexical fields of kinship and marriage.

Several terms are missing from my data: ‘wife and her sister-in-law’, ‘wife and her co-wife’, ‘aunt and niece’, ‘grand-mother and her grand-children’, among other things. Some terms may be gender-neutral, e.g. ‘grand-mother and her grand-children’ may also be *xa-vabun*.

(8) *calibeen ma le=moo ma li=ehni e-bee-le*

sometimes if 3PL=stay COM DEF.PL=DEM.PROX RECP-peer-3PL.POSS

‘Sometimes when they stay together with those, they are each other’s
cousins.’ [AG1:239]

These reciprocal relations do not seem to extend beyond the lexical fields of kinship and marriage, possibly because the prefix *xa-* ‘AGT.NMLZ’ is ambiguous in connection with other roots.

11.2 Middle

The reflexive/reciprocal prefix *e-* is used for other functions as well where an intransitive action is somehow enhanced. While there are identifiable patterns, the meaning of *e-* is lexically determined, yielding in some cases completely idiosyncratic meanings (Table 11.3).

Since the meanings associated with *e-* are so diverse, and since the conventional analysis of it differs from verb to verb, additional words may be added to disambiguate: *sisipo* ‘together’, *xhayu* ‘randomly’, *hato* ‘alone’ etc.

³This is likely not related to the agentive nominalizer, as the cognates for both in other Northern languages are different. For example, in Pije, *kee-* is the reciprocal prefix and the agentive one is *ka-*.

Table 11.2: Reciprocal kinship terms

Complex form	Gloss of Morphemes	Meaning
<i>xa-bate</i>	<i>xa</i> -tip	‘brothers’
<i>xa-betha</i>		‘sisters’
<i>xaa-vap-an</i>	<i>xa</i> -hunt?-POSS	‘siblings’
<i>xa-fa-thau-n</i>	<i>xa</i> -CAUS-wealth-POSS	‘brother-in-law and sister-in-law’
<i>xa-nya-pwan-an</i>	<i>xa</i> -put-on-POSS	‘paternal aunts’
<i>xa-e-vwona-n</i>	<i>xa</i> -RECP-maternal.uncle-POSS	‘maternal uncle and niece/nephew’
<i>xa-vabu-n</i>	<i>xa</i> -grandchild-POSS	‘grandfather and grandchildren’
<i>xaa-maci</i>		‘father and child’
<i>xa-e-bee-n^a</i>	<i>bee-n</i> ‘brother, cousin, peer’	‘cousins’
<i>xa-ive-n</i>	<i>iven</i> ‘sister-in-law’	‘sisters-in-law’
<i>xa-xayaa-n</i>	<i>xaya</i> ‘stranger, guest’	‘husband and his brother-in-law’
<i>xa-mwaa-n thamo</i>	<i>mwaa-n</i> ‘daughter-in-law’	‘mother-in-law and her son-in-law’ ^b

^aWe also found a term *xa-ve-bee-n* ‘cross-cousins’, but it is doubtful that this is a true distinction given the allomorphy of *e-* and *ve-*.

^bProbably actually ‘child-in-law of the opposite sex’. By analogy, ‘father-in-law and his daughter-in-law’ may be *xa-mwaa-n xayuu*.

Table 11.3: Base and middle forms

Base form and meaning	Middle form and meaning
<i>wesidedo</i> ‘mirror (noun)’	<i>e-sidedo</i> ‘look at oneself in a mirror’
<i>sunixhiit</i> ‘?-pain’	<i>e-suni</i> ‘to restrain oneself, to suffer’
<i>siiwa</i> ‘go back’	<i>e-siiwa</i> ‘give a counter-gift’
<i>vadanke</i> ‘forget’	<i>e-vadanke</i> ‘forgive someone’
<i>vwa nyako-</i> ‘do; EXIST for’	<i>e-vwa nyako-</i> ‘to seem’
<i>xhwatiin nyima-</i> ‘small heart’	<i>e-xhwatiin nyima-</i> ‘be sad’

11.2.1 Lack of volitional agent

A function of *e-* to mark events initiated by forced of nature or other unintentional causes is well attested in Oceanic (Bril 2005: 33). While this is described for Bwato *ve-* (Rivierre & Ehrhardt 2006: 310), it could not be found in Vamale: a true lack of initiator. This is expressed with a manner verb *hato* ‘to do X alone’. The absence of this function otherwise present in New Caledonia may be due to attrition. There are only two possible candidates that this research project found for Vamale: *e-vwa nyakoo-* ‘MID-EXIST for-’ ‘take note of something, become aware’ (9), and *e-vaaya ko-* ‘MID-move on’ ‘shake, move on one’s own’ (10). The first uses a non-volitional verb anyway, *vwa* ‘there is’, which casts doubt upon an analysis of *e-* as marking a lack of initiator.

- (9) *cahma In-Fwe cipa a=e-vwa nyakoo-n*
 TOP Bark-guettarda_speciosa NEG 3SG=MID-EXIST for-ANA
 ‘But Figtree-Bark did not suspect anything.’ [GC:16]

- (10) *e-vaaya ko-n ka i=that*
 MID-move on-NSPEC SBJ DEF.SG=wind
 ‘The wind shakes [the leaves].’ [X4:13]

11.2.2 Lack of endpoint

Verbs can acquire an unbounded meaning with *e-*: while e.g. the active verb *thana* ‘to wander’ becomes *e-thana* ‘to go for a stroll, to aimlessly amble’, stative verbs like *gere* ‘fat; be fat’ and *hmain* ‘be numerous’ change from describing mere states, to describing developments: *e-gere* ‘to grow fat’, *e-hmain* ‘more and more numerous’.

11.2.3 Mode of grouping

A rare function, which is described also for other Northern languages (Bril 2005: 46), changes the meaning of a numeral verb to a grouping one: *nya e-thaloo* ‘put two by two’; *e-thaloo moo koon* ‘there are two kinds, they stay on this as two’. The word *e-see* ‘be rare’ shown in (11) is derived from *se* ‘be alone, be one’.

- (11) *xaleke, go, cahma wadat, tha e-see*
 see well concerning gun ASS MID-be.one
 ‘You see, and well, guns were rare.’ [KL:140]

11.2.4 Symmetrical point

While *can dawee-* ‘inbetween’ can be used to describe a member of a group, as in (12), a derived form *can e-dawee-* ‘among’ also exists, see (13). There is not enough data yet to precisely pinpoint the difference, though the indistinguishability of the group members may be a nuance introduced by *e-*, given that this is a function of *e-* attested in other contexts (see §9.5.4). Other languages in the area use the middle prefix with a “symmetrical point or space between some landmarks” (Bril 2005: 50), but Vamale speakers were content with either form and only one unprompted occurrence of *can e-dawee-* is attested.

- (12) *lu=e-vi hapi na kai eca=a= nya wi- vwa*
 3DU=RECP-say COMP TOP who INDF.SG=REL= give strength EXIST
wi-n can dawee- can dawee-lu
 strength-3SG.POSS in between in between-3DU
 ‘They discussed who was the stronger between the two of them.’ [JV:4]

- (13) *ma can e-dawee-le i=a= yata-n*
 CNJ in-NSPEC MID-between-3PL DEF.SG=REL= name-3SG.POSS
In-Thu
 Bark-Banyan
 ‘And among them was the one called Banyan Bark.’ [GC:6]

11.3 Causatives

The causative prefix *fa-* is probably a reflex of Proto-Oceanic **pa-* ‘CAUS’ (Ross 2004: 510). It can be applied to active (14), stative (15), and possessible verbs (16) alike. The Vamale causative is prototypical in Zúñiga & Kittilä’s sense, as it increases the base verb’s valency by one, and introduces a new agent, which acts as the new subject of the clause, and is “formally coded on the predicate complex” (Zúñiga & Kittilä 2019: 15–16).

- (14) *ya a=fa-thuat i=apuli*
 3SG 3SG=CAUS-go.out DEF.SG=person
 ‘He had the man released.’ [Hc1:35]
- (15) *a=fa-xhopwen*
 3SG=CAUS-big
 ‘S/he is conceited.’

11 Voice

- (16) *go=fa-mu-nyima-n*
2SG=CAUS-?-heart-3SG.POSS
'You scare him/her.'

Possible verbs which are subject to a causative derivation mark the demoted S exactly the same as it was for the base verb, adding the agentive argument in the beginning (17).

- (17) *mu-nyima-n*
DEF.DU?-heart-3SG.POSS
'S/he is afraid.'
- (18) *go=fa-mu-nyima-n*
2SG=CAUS-?-heart-3SG.POSS
'You scare him/her.'

s_A -indexed verbs can be transitive or intransitive. Intransitive verbs, as expected of a prototypical causative construction, are derived to a transitive one, and the former S subject is demoted to the object, in bold in example (19). Base transitive verbs are more interesting: the participant made to perform the action by the causer receives the Recipient or Experiencer marker *nyako-* 'OBL; put on'⁴ (20), since Vamale has no ditransitive verbs and cannot demote the causee to a core argument.

- (19) *ya a=fa-thuat i=apuli*
3SG 3SG=CAUS-go.out DEF.SG=person
'He had the man released.' [Hc1:35]
- (20) *a=fa-tena nyakoo-n meeka-n li=aman*
3SG=CAUS-hear OBL-3SG all-NSPEC DEF.PL=thing
'He let him know everything (that was going on).' [GC:129]

The subordinating construction *vwa, ma ...* 'do, so that' is a more common way to express a cause than with *fa-* 'CAUS' in (21) and (22), but does not change the verb's valency. Other constructions use a transitive main verb, and a purposive subordinate clause (23). Note that the verbs in (14) and (20) do not have completely transparent meanings. Most verbs prefixed with *fa-* that were recorded had idiosyncratic meanings, such as (24), which may be a hint that use of the prefix is in decline.

⁴See §8.1.2.2.

- (21) *a=vwa ma vwa i=siya-n-ea*
 3SG=do SUBR do DEF.SG=field-POSS-3SG.POSS
 ‘She makes him till his/her field.’ [07.11.2018 p.97]
- (22) *Jean, a vwa ma a fe-an-de (i)= fatii-n (nya)si*
 J. 3SG_i do SUBR 3SG_{ii} take-go-DIR.CF DEF.SG= word-3SG_i.POSS BEN
 Vaina
 V.
 ‘Jean made him carry his letter to Vaina.’ [07.11.2018 p.97]
- (23) *Jean a nya si Pierre i=fatii-n ma nya si*
 J. 3SG_i give BEN P. DEF.SG=word-3SG_i.POSS SUBR.3SG_{ii} give BEN
 Vaina
 V.
 ‘Jean made Pierre carry his letter to Vaina.’
 [vamale-181107-jpnelemwa-06:00:19:33-00:19:37]
- (24) *a=fa-xhopwen*
 3SG=CAUS-big
 ‘S/he is conceited.’

11.4 “Passive”

Vamale has no passive, i.e. no construction that adds a dedicated morpheme to the verb to alter the syntactic mapping of the participants, without changing their semantic nature (i.e. by demoting the agent and promoting the undergoer). Verbs whose agents are unidentified may take *le* ‘3PL’, as in (25), or may not be marked for subject at all, see (26). In subject-less scenarios, the undergoer may be additionally marked with *ka* (27), which is reminiscent of absolutive *ka* (§9.7.6). Since this is the only example with *ka* attested so far, more research is needed in the future to reach a conclusion as to this *ka*’s meaning: ‘LINK’ or ‘SBJ’, seen in other verb phrases.

- (25) *mwa (a=) le=vwa ko i=doop-ea*
 house REL= 3PL=do OBL DEF.SG=soil-3SG.POSS
 ‘a house made of his earth’ [vamale-181127-jp_nelemwa-1: 00:13:24-30]
- (26) *bwa xada thathee mwa maahma ca i=dingan xahan thêêdo*
 IPFV up.there kill REP big.brother in DEF.SG=creek over.there T.
 ‘Up there, the chief was killed, in the creek over in Tendo.’ [HC1:9]

11 Voice

- (27) *buuke ka i=aman nya-ko-n i=vin thi*
destroy LINK? DEF.SG=thing put-on-ANA DEF.SG=shell clam
'Destroyed was the thing on which there is the [Shell Oil] clam shell.'
[KG:545]

12 Aspect and mood

Vamale uses short function words before predicates to situate them in the temporal context. Irrealis *bo* and realis *balan* also have modal functions, and many aspect particles also carry non-aspectual meanings relating to the core function: e.g. continuative *balan* can also mark adversative situations, and frequentative *mu* on nouns means ‘also, too’. A few particles carry temporal connotations: *pa* ‘*alr*’ implies that the event lies in the past, and both *bo* ‘*irr*’ and *bwa* ‘*ipfv*’ can set the even in the future. Finally, *kon* ‘*prog*’ puts the predicate in the same moment as its surrounding context. Around a dozen of the particles exist including idiosyncratic combinations; Table 12.6 summarizes the lone forms, an overview of combinations is given in Table 12.7. These particles do not necessarily mark the predicate as verbal. As in other Kanak languages too (see Nêlêmwa, Bril 2002: 89), predicates can be nominal as well as verbal, and since it is the predicate rather than the verb that takes modal, aspectual, and other particles, the latter’s presence says nothing conclusive about the word class of the lexemes following them. Two of them, perfective *pa* (*ja*) and imperfective *bwa*, can occur in the left-most position of a negated clause, with a difference in scope (see §12.7).

Most of the aspectual morphemes’ effects depend on the verb phrase’s aktionsart. Compare *bo* ‘*IRR*’ in (1) and *bwa* ‘*IPFV*’ in (2): the atelic verb triggers an imperfective meaning of *bwa* (which otherwise means certain future for telic verbs), and an ambiguous irrealis/future meaning for *bo*.

(1) *e=bo xaleke*
1SG=*IRR* see
‘I will/would see.’

(2) *e=bwa xaleke*
1SG=*IPFV* see
‘I am still looking.’

xa- ‘*HAB*’ is a prefix that usually functions a deverbal nominalizer (see §9.7.2) but is also used to express habitual action. Since this prefix has a different morphosyntactic status than the aspectual particles, and since it is not sensitive to aktionsart, I will not further discuss it in this chapter.

12.1 Aktionsart

A central part of Vamale aspect is aktionsart, or verbal aspect. Almost all aspect markers have different meanings depending on the modified predicate's aktionsart. Predicates can be divided into two broad groups: punctual (i.e. that cannot last, e.g. 'to kill'), or telic (with an intrinsic end to the action, e.g. 'to close'), and durative, or atelic. The latter group includes nominal predicates. While telicity and durativity share only some traits, most atelic verbs are also durative, and most punctual verbs are also telic. In many cases, the meanings available to an aspect marker - verb combination split along a single axis and do not distinguish between telicity and durativity. Some verbs can have different aktionsarten, depending on the context, e.g. *han* 'to go somewhere (telic and durative), to leave (telic and punctual), to walk (atelic and durative)'. Which semantic trait is more important depends on the aspect particle: telicity is more important than durativity for *balan* 'keep doing sth atelic (despite obstacles), begin something atelic, end something telic', and *mu* 'FREQ, ITER', and makes no difference for *bo* 'IRR', *pa* 'PRF' and *ja* 'PRF'. The meaning of *bwa* however reacts to durativity and punctuality.

12.2 Irrealis *bo*

Modality, in Vamale, is mostly expressed lexically (e.g. *xahnang ma ...* 'good if ...' see §13.3), but there are two dedicated morphemes. Apart from the epistemic modal particle (*bo*) 'IRR', which behaves syntactically much like the aspect markers described in the rest of this chapter, an epistemic modality marker *tha* 'ASS' is frequently preposed to matrix, and certain subordinate clauses (mostly complement and relative ones). A particle *ko* 'REAL' is described for western Voh-Koné languages (Rivierre & Ehrhardt 2006: 55) but is not attested for Vamale (nor recognized by speakers in elicitations). A more detailed discussion of *tha* 'ASS' takes place in §13.3.1. The assertive particle is not included in this chapter because contrary to (*bo*), it does not share the same syntactic slot as the aspectual particles discussed below.

There are also verbs and nouns that express deontic categories such as possibility (*goon, ma* 'enough, SUBR', or *xahnang, ma* 'good, SUBR'), impossibility (*vwasoon* 'impossible', *siteke* 'taboo, forbidden'), and epistemic ones like doubt (e.g. *sahnaang* 'be uncertain (knowledge-wise)', *cacahniing* 'be dubious') and certainty. Since all of these constructions are lexical ones with idiosyncratic meanings, they are briefly discussed in different sections such as §9.1 and §13.3.1, and in more detail in §14.2.1.1.

The irrealis/future particle *bo* ~ *o*, probably cognate with Nelêmwa *o* ‘virtual’ and Bwatoó’s eponymous *bwatoo* ‘irrealis’, expresses a state removed from reality, be it because it is yet to happen (3), hypothetical (5), or otherwise unreal.

- (3) *tha gau han tha gau tha gase bo arriver hman*
 ASS 2DU go ASS 2DU ASS 1PL.INCL IRR arrive too
 ‘You go (first), you, and we’ll arrive as well.’ [KG:9]
- (4) *vaaya, a=bo thapoke pwecake i=marie*
 work 3SG=IRR begin after DEF.SG=wedding
 ‘Work, it will start after the wedding.’ [AG1:394]

The purely irrealis function, without marking tense, is less frequently encountered (5), though the exact meaning of *bo* may be left ambiguous in some contexts.

- (5) *tha cika eca=o fa-siit hapi na tha i=xayu hato*
 ASS there.is.not some=IRR CAUS-sacred that DEM ASS DEF.SG=man alone
a=cami
 3SG=plant
 ‘There is nothing that would impose that it’s only the man who plants it.’
 [vamale-17116-calendrier_femme 00:00:46-00:00:50]

Whereas usually, (*b*)*o* ‘IRR’ and *tha* ‘ASS’ are not seen together, one exception was recorded: when stating a past situation when something then still unreal was already asserted by somebody, this is expressed with *tha go bo vwa* ‘you would surely do it’, as in (6).

- (6) *e=caihnan hapi tha go=bo vwa*
 1SG=know COMP ASS 2SG=IRR do
 ‘I knew that you would do it.’ [D6:10]

12.3 Imperfective and future *bwa*

The aspect marker *bwa* has two main meanings depending on aktionsart and context. Atelic verbs with *bwa* express events that include the starting point of the action *t*^o in a progressive way (i.e. ‘it has begun and is still going on’), see (7). The event has a border, which is the main difference with *kon* ‘PROG’. Telic verbs with *bwa* are set in the certain future. *bwa* readily combines with other aspect particles, for example to attenuate the predicate, and it can even modify an

12 Aspect and mood

entire clause, outside the usual post-subject marker environment. This last case concerns negated predicates, but *bwa* is also attested as an attenuating discourse marker (see §13.2.1.3).

- (7) *koin a_i=kon a_{ii}=bwa tena-a_i ka i=ibwen_{ii}*
afterwards 3SG=PROG 3SG=IPFV hear-3SG.OBJ SBJ DEF.SG=squid
'During this, he was heard (all along) by the squid.' [HC2:16]
- (8) *a=bwa pala*
3SG=IPFV speak
'He is still speaking.' [X10:53]

12.3.1 Imperfective *bwa*

Predicates denoting states or ongoing events, if preceded by *bwa*, usually have an imperfective meaning, i.e. with a starting point in the past, and no implicit border in the future (9). Note that while verbal predicates tolerate *bwa* to the left of a (negated) subject index (10), nominal ones do not (compare (11) and (12)).

- (9) *tha bwa nyau*
ASS IPFV bad
'It's still bad.'
- (10) *bwa cip=e caihnan*
IPFV NEG=1SG know
'I still don't know.' [J4:10]
- (11) *le=bwa xhwaawe li=a= le=cuut xahan*
3PL=IPFV child DEF.PL=REL= 3PL=stand over.there
'They who stand over there are still children.'
- (12) **bwa le=xhwaawe li=a= le=cuut xahan*
IPFV 3PL=child DEF.PL=REL= 3PL=stand over.there

12.3.2 Attenuating *bwa ju*

The imperfective meaning described for *bwa* can also, apart from meaning 'still', signify a brief impermanent state, as in 'I am just, quickly, for a moment, doing X', a function which can be attenuating. In (13) below, the action of reading is interrupted for now ('I am impermanently stopping reading the book').

- (13) *e bwa koin fine i=tii*
 1SG IPFV finish read DEF.SG=book
 ‘I am interrupting my reading (lit. I am briefly stopping reading the book).’

bwa ju ‘IPFV real’ is a common expression, meaning ‘really just’ or ‘simply’. While *bwa* and *juu* also combine as individual particles (14), they can form a morpheme in its own right. This is possibly the only such combination between an aspect marker and an intensifier. The abbreviated form of *juu* used in combination with *bwa* may be a hint at the former’s decategorized status; although the two particles do not form a single p-word.

- (14) *na tha bwa ju*
 DEM ASS IPFV really
 ‘It’s still really...’ [KL:102]
- (15) *go=bwa ju tho*
 2SG=IPFV really call
 ‘You will simply call out [when a car comes].’ [KG:273]

Apart from the attenuative meaning and the ones conveyed by the two particles individually (‘still really’), a third, more aspectual function is also attested: in example (16), the telic verb *hma* ‘arrive’ is not set in the future, and the intensifier *ju* means ‘only, just’. *bwa ju* with a telic verb can thus have a very immediate meaning.¹

- (16) *a=bwa ju (ra) hma*
 3SG=IPFV real HAB arrive
 ‘S/he only just arrived.’ (*ra* increases the immediacy) [G5:59]

12.3.3 Prospective *bwa*

Telic verbs have a prospective meaning with *bwa*. The event has not yet occurred, though it is often immediately about to happen: the marker expresses a certain future meaning, as in (17), where the sea is sure to go down again, and (18), where it is actually already happening. Note that in (18), the first, prospective, verb is atelic.

¹Note that as *ra* ‘to do afterwards’ would not fit with the meaning, the free variant of *xa*- ‘HAB’ is posited as the gloss of *ra*, but this is speculative.

12 Aspect and mood

- (17) *a=bwa hupwa ka i=jati*
 3SG=IPFV go.down-REP SBJ DEF.SG=sea
 ‘The sea [tide] is about to go down/is going down.’ [X10:69]
- (18) *e=bwa pala ka e=bwa caeke*
 1SG=IPFV speak and 1SG=IPFV hope
 ‘I am going to hold a speech and I just hope..’
- (19) *e=bwa vi nyakoo-n*
 1SG=IPFV say OBL-3SG.POSS
 ‘I will tell him.’ [X10:49]

Note that (18) and (8) (*a bwa pala* ‘he is still speaking’), though containing the same (atelic) verb, differ: one is prospective, while the other is imperfective. Context is thus also a factor. In (19), *vii* ‘to say’ is a telic verb and thus interacts with *bwa* as such.

While *bwa* ‘IPFV’ can also mark future states, the difference is not volition of the participants or how long it will last, but includes the modified predicate’s aktionsart and how immediate the starting point is: *bwa* has a future meaning with punctual verbs, and an imperfective one with durative verbs. An immediate starting point may however also confer a future meaning to a durative predicate, in the sense of ‘I’m (practically) already doing it’. Compared to (*b*)*o* ‘IRR’, a rough distribution can be posited, as illustrated in Table 12.1.

- (20) *bo me-o naen*
 IRR die-1SG soon
 ‘I will/could die later (today).’
- (21) *bwa me-o ca eca thoatit*
 IPFV die-1SG LOC some day
 ‘I will die some day (certainly).’

Table 12.1: *bo* and *bwa* combined with different aktionsarten

	<i>bo</i>	<i>bwa</i>
atelic	IRR	IPFV
telic	IRR (uncertain, volitional)	FUT (certain, non-volitional)

12.3.4 Negated *bwa(n)*

The allomorph of *bwa* ‘IPFV’, when negated by *cipa*, is *bwan*, see (22), which consequently never occurs without the negator. This is the only case in Vamale of a grammatically conditioned allomorph. While *cipa bwa* also exists (23), it does not mean ‘not yet’, but rather negates a predicate that was attenuated by *bwa* ‘not just’, a function that was described in §12.3.1.

(22) *na cipa bwan koin*

DEM NEG IPFV end

‘It’s not yet over.’ [CP:7]

(23) *cana ehni ya tha bwa vo cipa bwa cipa bwa tha juu cipa bwa*

fuck PROX 3SG ASS IPFV fill.up NEG IPFV NEG IPFV ASS real NEG IPFV

reculer hman

back.up also

‘Fuck, this one was still filling up, he didn’t, didn’t, he really didn’t simply back up like.’ [KG:465]

12.4 Progressive *kon*

The progressive marker *kon*, probably derived from *ko-n* ‘on-NSPEC’ is fairly straightforward: it marks ongoing situations (24). This means it can only combine with aspect markers that encode realis situations which include *t*^o, such as *bwa* ‘IPFV’. Strictly speaking, telic verbs cannot take *kon*.

(24) *e=kon hmata*

1SG=PROG sing

‘I am singing right now.’ [B1:20]

(25) *a=kon vi hapi na gasu enregistrer koin gase=bo*

3SG=PROG say that DEM 1DU.INCL=record while 1PL.INCL IRR

pala

talk

‘He is saying that we will record while we speak.’ [HC1:1]

12.5 Combination of *kon* with *bwa*

The aspectual markers *kon* ‘PROG’ and *bwa(a)* ‘IPFV’ can combine. If *kon* is first, a progressive imperfective *kon bwaa* is the result: ‘is doing still’ (26). However, when *bwa* is in the first position, the focus is on the imperfective rather than the progressive meaning: ‘still doing’.

Tense is not marked in Vamale, though the particles discussed in this chapter often carry exclude certain interpretations (*bo* ‘IRR’ cannot mark a past situation, *pa* ‘already’ cannot mark a future one etc.). In some cases, such as (27), a close future is understood from imperfective *bwa*, progressive *kon*, and a durative, atelic verb.

(26) *e=kon bwaa jili*
 1SG=PROG IPFV build.from.wood
 ‘I am still building.’ [2017-10-04 p.133]

(27) *e=bwa kon jili*
 1SG=IPFV PROG build.from.wood
 ‘I am almost done building (lit. I still am building).’ [2017-10-04 p.133]

In contrast to this, example (28) has a transparent, and (29) an idiosyncratic meaning. Both *hmata* ‘sing’ and *jili* ‘build with wood, woodworking’ are durative. The difference in which meaning is assigned to which combination may hinge on the telicity of the verb: *hmata* is atelic, while *jili* implies a result, or at least a possible end.

(28) *a=bwa kon hmata*
 3SG=IPFV PROG sing
 ‘He sings since earlier.’ [2017-10-04]

(29) *a=kon bwa hmata*
 3SG=PROG IPFV sing
 ‘He just started singing.’ [2017-10-04]

12.6 Continuative and realis *balan*

The particle *balan*, similarly to *mu* described below, has more ambiguities than aktionsart can account for. Its interpretation depends on the context as well. The described event either:

- continues to happen (in some cases, despite an obstacle),
- has just (unfortunately or finally) taken place or begun,
- or will certainly and immediately happen.

The following section will first introduce *balan* alone, with its two main meanings, continuative and realis, before addressing the common combinations with other aspect markers, as well as the less common ones. The section closes with a summary.

balan may be a recent addition to the set of aspect markers, as speakers do not agree on the grammaticality of some of its uses, notably the combination with *bo* (see Table 12.2). One universally accepted use is that of *bala-n* as a noun meaning ‘piece of long object-NSPEC’, as in *balan o* ‘piece of bamboo’ and *balan oot* ‘length of string’ (30). This ‘bit’ meaning allows a use of *balan* as an attenuative particle, similar to *xhwan/xhwat* in (31) and (32).

(30) *e=bo fe balan mwano-aen a=bo man nyako-ong*
 1SG=IRR take piece.length custom.cloth 3SG=IRR rot on-1SG.POSS
 ‘I’ll take this piece of *manou* [that you have given me as a greeting custom] and [will keep it forever so that] it will rot on me.’ [HC19:63]

(31) *a=bo balan pala*
 3SG=IRR REAL/bit speak
 ‘He will finally/a bit speak.’ [X10:55]

(32) *a=bo xhwan pala*
 3SG=IRR bit speak
 ‘He will speak a bit.’ [X10:56]

Used as an aspect marker, *balan* is more frequent in combination with other particles than alone, and *balan* always comes second. A form combined with the progressive marker, *kon balan*, and one with the irrealis one, *bo balan* unambiguously mean ‘has recently happened’ and ‘is just about to happen’ respectively, though both are used rarely and judged ungrammatical by some speakers (especially *kon balan*, perhaps because *balan* expresses an immediate change of state, which contradicts *kon*’s progressive meaning). Other aspectual particles precede *balan* to add a sense of ‘finally’ (*bwa balan*) or ‘despite obstacles’ (*ja balan*).

Aktionsart also matters: durative verbs with *balan* are either about to begin or have begun, but continue. Punctual verbs have either happened or are about to

happen. Without context, certain verbs seem to have preferred interpretations. If the context suggests it, *balan* can take an adversative function (33). This example was elicited on the basis of a Nêlêmwa sentence with the same meaning using *bara* (Bril 2002: 238) and though the meaning ‘unfortunately’ was never found in free speech, speakers accepted it in an elicitation context.

- (33) *balan xhali sau-ng pwa-n yee*
 alas tear dress-1SG.POSS ON-NSPEC tree
 ‘Unfortunately, my dress tore on a tree.’
 [181016-jpgramm1, 00:12:56-00:12:58]

12.6.1 Continuative *balan*

Probably derived from the length-associated nominal meaning, is the aspectual use as a continuative. Used with atelic verbs, *balan* can imply that the action happens despite a (potential) obstacle (34), but may also refer to a lasting state (35). This interpretation is only available with realis contexts, meaning that *ja* ‘PRF’, *pa* ‘PRF’, and controversial *kon* ‘PROG’ are the only aspect markers that can combine with this continuative *balan*. Example (36) combines *balan*’s implication of an obstacle, with the resultative meaning of *ja* to imply an expected hurdle. This is discussed in more detail in §12.6.3. *balan* is also found in the verb *fe balan* ‘to continue (lit. take length)’, and as an adverb meaning ‘ever since’, see (37).

- (34) *e=balan han*
 1SG=CONT walk
 ‘I keep walking (despite e.g. your calling me).’ [J2:39]
- (35) *na i=s-ung tha balan hmwaani*
 DEM DEF.SG=hand-1SG.POSS ASS CONT like.this
 ‘It’s my arm, it stays like this.’ [KG:139]
- (36) *e=ja balan jili wâng*
 1SG=PRF CONT build boat
 ‘Despite an expected holdup, I keep boat-building.’ [J2:43]
- (37) *balan cel=e=xale-ko*
 since when.REAL=1SG=see-2SG.OBJ
 ‘ever since I saw you’ [example sentence for the dictionary]

12.6.2 Realis *balan*

In irrealis situations, with punctual or telic verbs, and with atelic ones in the appropriate pragmatic context, *balan* means something completely different: the realization of a situation.² The continuative meaning discussed above maintains a situation, whereas this realis sense is concerned with change. With meanings ranging from ‘this has just begun/come to happen’ to ‘finally’, the common denominator of non-continuative *balan* is that the resulting construction is a realis one, or is so close to becoming one that it might as well already be. This is the reason why *bo balan* is contested (see §12.6.6); it seems to be more widely accepted by younger speakers. *bwa balan* ambiguously means either ‘has recently begun and is still underway’ and ‘has practically begun’, probably both using the ambiguity of *bwa* as both a realis and irrealis marker (12.3), and at least originally coming from hyperbole (‘I’m so close to doing it that I’ve practically begun’). However, neither of these explanations would work with *bo*, which is explicitly irrealis and thus unlikely to be used here for hyperbole, as well as being unavailable for combinations with realis markers. The use of *bo* with *balan*, shown with its ambiguous meanings in (38), may point at a development of *balan* towards a more flexible meaning. Interestingly, the ambiguity that *balan* can express with regard to conceptual limits is shared by *xhwan* ‘almost, hardly’, and not unknown in other languages of the area (e.g. *(k)u* ‘PRF’, Bril 2002: 206, 207).

Table 12.2: Overview of aspect marker combinations with *balan*

<i>balan</i>	subject marker= <i>b.</i> = verb			
	<i>ja b.</i>	<i>bwa b.</i>	<i>kon b.</i>	<i>bo b.</i>
just done/about to do, continue to do, do despite	finally do, do despite constraints	finally do (but not <i>despite</i>)	just begun/about to do	about to do

- (38) *gase=bo balan hmasan!*
 1PL.INCL=IRR REAL bit arrive
 ‘We will finally arrive!’ [X10:54]

²Durative verbs do not carry the meaning ‘just done’, but rather ‘recently started and continuing’.

- (39) *a=bo balan pala*
 3SG=FUT REAL/PRF speak
 ‘He will finally/a bit speak.’ [X10:55]

12.6.3 Finally, continuative: *ja balan*

The combination of *ja* ‘PRF’ and *balan* shows the oft-encountered temporal immediacy due to *balan*, but *ja*’s contribution is less clear. In examples (40) and (41), the meaning ‘finally’ is derived from *ja*. In (44), *balan* marks perseverance despite an obstacle, and *ja* seems to mark that the obstacle is one that was known beforehand, perhaps relating to single *ja*’s meaning of ‘finally, after an observed period of becoming’.

- (40) *a=ja balan pala*
 3SG=PRF CONT speak
 ‘He continues to speak, he will finally speak.’

- (41) *e=ja balan fine i=tii*
 1SG=PRF CONT read DEF.SG=book
 ‘You (will) finally begin to read the book.’

- (42) *gase=ja balan hmasan!*
 1PL.INCL=PRF CONT arrive
 ‘We are finally about to arrive, we have just arrived!’

An adversative meaning is not only achieved with *balan* alone (33), but also in combination with *ja* ‘PRF’ (36). The meaning added to the simple adversative is one of foresight: the obstacle against which the predicate takes place is an expected one.

- (43) *e=ja balan han*
 1SG=PRF b. go
 ‘I went on [despite my scheduled meeting].’
- (44) *e=ja balan jili wâng*
 1SG=PRF b. build boat
 ‘I continue building my boat despite X.’ [J2:43]

12.6.4 Finally: *bwa balan*

bwa balan marks an immediate temporal limit. For punctual verbs, this means either a recent end (45) or a recent beginning (46). For durative verbs, *bwa balan* implies ongoing action (47). This is by far the most frequent form with *balan*. Table 12.3 summarizes the meanings with different verbs.

Table 12.3: *bwa balan*

Aktionsart	verb	future meaning	past/progressive meaning
punctual	arrive		recently done
	finish		recently done
durative	speak	about to	recently begun, <i>still happening</i>
	walk	about to	recently begun, <i>still happening</i>
	read		recently begun, <i>still happening</i>
	build		recently begun, <i>still happening</i>

- (45) *gase=bwa balan hmasan!*
 1PL.INCL=IPFV bit arrive
 ‘We finally arrived recently; we are about to finally arrive (this is so sure and immediate that we might as well have already arrived)!’
- (46) *e=bwa balan han*
 1SG=IPFV b. go
 ‘I am (finally about to be) leaving.’
- (47) *e=bwa balan fine i=tii*
 1SG=IPFV b. read DEF.SG=book
 ‘I have finally begun reading.’

While some verbs have a conventional interpretation, such as telic (46) and atelic (47), ambiguous, context-dependent cases are common (48), possibly because *bwa* has many possible interpretations.

- (48) *e=bwa balan jili wâng*
 1SG=IPFV b. build boat
 ‘I will begin building the boat (this is so sure that I have practically begun); I have begun.’

12 Aspect and mood

- (49) *a=bwa balan pala*
 3SG=IPFV b. speak
 ‘He has just spoken; he has begun to speak.’ [X10:51]

12.6.5 *kon balan* ‘about to, recently started’

Few speakers accept this form without context. If one needs to make clear that something has begun and is going on, this may be possible (51). Punctual verbs are even more contested, likely because of the progressive *kon*.

Table 12.4: *kon balan*

Aktionsart	Gloss of form		
PUNC	arrive		recently done
	speak	<i>finally</i> about to	
DUR	walk	<i>finally</i> about to	
	read		recently begun
	build		recently begun

- (50) *e=kon balan jili wâng*
 1SG=PROG REAL build boat
 ‘I have begun building the boat.’
- (51) *e=kon balan fine i=tii*
 1SG=PROG CONT read DEF.SG=book
 ‘(rare) I continue reading the book (it has just begun).’

12.6.6 *bo balan* ‘about to’

The combination of *bo* with *balan* is not accepted by many older speakers, and is mostly used to unambiguously state on which side of the temporal border we are: the event is about to happen (52, 53). One speaker translated an example with a realis meaning (54), but none were produced spontaneously.

- (52) [am.bom.ba.lan.’pa.la]
a=bo balan pala
 3SG=IRR bit speak
 ‘He will finally speak.’ [X10:55]

- (53) *gase=bo balan hma-san!*
 1PL.INCL=IRR PRF arrive-same.level
 ‘We will finally arrive!’ [X10:54]
- (54) *e=bo balan jili wâng*
 1SG=IRR REAL build boat
 ‘I begin building.’ [J2:44]

12.6.7 Summary: Combinations with *balan*

While the chapter features a summarizing table at the end (Table 12.7), the following examples summarize the various functions of *balan*. The data below were elicited explicitly as minimal examples and may present an over-simplified view.

- (55) *e=fine i=tii*
 1SG=read DEF.SG=book
 ‘I read the book.’
- (56) *e=balan fine i=tii*
 1SG=REAL read DEF.SG=book
 ‘I just started reading a book, I am still reading it.’
- (57) *e=kon balan fine i=tii*
 1SG=PROG CONT read DEF.SG=book
 ‘(rare) I continue reading the book (it has just begun).’
- (58) *e=bwa balan koin fine i=tii*
 1SG=IPFV REAL finish read DEF.SG=book
 ‘I have finished reading the book (just now).’
- (59) *e=bo balan koin fine i=tii*
 1SG=IRR REAL finish read DEF.SG=book
 ‘I am about to finish reading the book.’

Missing from this collection of examples is *ja balan* ‘finally *balan*’, because the pragmatic context is so important that a representative example is impossible.

12.7 Perfective *pa* (*ja*)

The perfective marker *pa*, marks the predicate as completed by the moment of speech (60), or the relative temporal reference point, e.g. in stories.

- (60) *cama=a=vi hapi a=pa xhwi-aman*
 if=3SG=say COMP 3SG=PRF eat-thing
 ‘If he says that he’s already eaten [stop trying to feed him].’ [D3:78]

Contrary to most other aspectual markers, *pa* is indifferent to aktionsart. *pa* with an atelic verb means that this has already begun or finished depending on the context, and with a telic verb, that it has taken place. It is commonly translated as *déjà* ‘already’ in French and stylistically often used in this sense.

Associating *pa* with *ja* ‘PRF’ (see §12.8) adds the information that the completion took some time, or was long awaited, as in (61), or that whatever is marked has happened some time ago, as in (62). This is by far the most common combination with *pa*.

- (61) *le=ja vatipwe-mwa kon ya tha pa ja me-a go tha le=ja*
 3PL=PRF drop-REP because 3SG ASS PRF PRF die-3SG then ASS 3PL=PRF
thuat-mwa moo ka li=xhaomu ja tha le=ja ha-mwa-me
 emerge-REP stay SBJ DEF.PL=elder PRF ASS 3PL=PRF go-REP-DIR.CP
 ‘They were released [again] because he was already dead, and they came out of prison [again] and came back.’ [HC1:32]

- (62) *ma le=ta ma le=xale-a koma le=fe-a ma le=ta*
 COM 3PL=go.up COM 3PL=see-3SG so.that 3PL=take-3SG COM 3PL=go.up
ma le=fe-a, ya pa ja me-a
 SUBR 3PL=take-3SG 3SG PRF PRF die-3SG
 ‘And they went up, saw him, in order to catch him, they went up to catch him, he (however) was already dead.’ [HC1:29]

As illustrated in (63), *pa* (with its frequent companion *ja*) can precede the subject index, though this is rare. This is also attested for *bwa* ‘IPFV’; both are only found in negated contexts. The semantic difference achieved, like with *bwa*, is that *cipe pa ja jili bwaakala* ‘I don’t already build boats’ does not clarify whether the subject ever built boats, whereas *pa ja* in the first position adds a sense of achievement to the statement ‘I don’t build boats’, i.e. ‘my building days are done’.

- (63) *pa ja cip=e jili bwaakala*
 PRF PRF NEG=1SG build.with.wood outrigger.canoe
 ‘I already don’t build boats anymore.’ [B2:144]

12.8 Perfect *ja* ‘finally’

The Bwato cognate of this form, *je*, is glossed as “accomplished” (Rivierre & Ehrhardt 2006: 56). For atelic verbs, *ja* expresses the expected, or long-awaited beginning of the action, as in (64), (65), and (66). Note the verb *jake* ‘measure, weigh’, which may be related.

- (64) ...*hê a=ja han tabo pwan bwa-n, koin a=ja*
 yes 3SG=PRF go sit on head-3SG.POSS then 3SG=PRF
fe-ta-mwa-me-a
 take-go.up-REP-DIR.CP-3SG.OBJ
 ‘Yes, he_i eagerly climbs to sit on his_{ii} head, then he_{ii} takes him_i home.’
 [HC2:26] (see Appendix A)
- (65) *go cama i=ibwen a=ja hup- a=kon ja*
 then concerning DEF.SG=squid 3SG=PRF go.down 3SG=PROG PRF
hup-wa-e can we...
 go.down-REP-DIR.CF in water
 ‘Then, when the squid finally goes down back into the water...’
 ‘Then, once the squid had gone back into the water [and the rat thought himself at a safe distance to mock him]...’ [HC2:29]
- (66) *siibwi tha pa me-a. tha=a=pa ja sea-da*
 rat ASS PRF die-3SG ASS=3SG=PRF PRF gaze-up
 ‘The rat is dead. He ended up gazing upwards.’ [HC2:40]
- (67) *cama ibwen tha=a=ja hup-wa, tha ja koin mwa*
 concerning squid ASS=3SG=PRF go.down-REP ASS PRF end REP
 ‘And the squid, he went back down. This is the end.’
 ‘The squid has gone down, thus it has ended.’ [HC2:39-40]

With telic verbs, *ja* marks that something finally happens, be it that it was actively anticipated (*tha jaa koin* ‘it’s finally over’) or (68), or that it was expected and inevitable like one’s own departure from a social situation: *e bwaa ja han* ‘I’m about to finally leave’. The latter function likens it to *pa* (§12.7), with which it often associates. Whereas *pa* only marks that the action is completed by the temporal point of reference, *ja* adds a sense of ‘finally’, similar to Comrie’s “perfect of result” (Comrie 1981: 58). This also applies to the result of a natural process: *bwaam, tha jaa xhopwe-go!* ‘My, you’ve grown!’. Stylistically, *ja* may be used to close a scene, see (67) and Swamp Hen’s takeoff (69, 70), where *ja* marks the

final leave of the swamp hen; we do not see her again. It cannot be used to describe the death of a person, as this would suggest that their death was expected. Given that *ja* expresses the result of an observed process and introduces a situation that is relevant for the time of reference (the present in direct situations, the narrative time in stories), *ja* will be labelled as “perfect”.

(68) ...go a=*ja* vwa mwa me ka i=*siibwi*.
 then 3SG=PRF do REP die SBJ DEF.SG=rat
 ‘Then he killed him.’ [HC2:38]

(69) go tha=*a=ja* ta-mwa-me
 then ASS=3SG=PRF go.up-REP-DIR.CP
 ‘And then it went home.’ [HC2:12]

(70) ya tha ja thêên thêên ta-mwa-me
 3SG ASS PRF fly fly go.up-REP-DIR.CP
 ‘Flew home right away.’ [HC2:13]

12.9 Present perfective *kon ja*

In combination with *kon* ‘PROG’, *ja* expresses something that is done by the moment which *kon* designates (71).

(71) putain yo m=*e* th=*e=kon* ja vwa i=*signe*
 fuck 1SG SUBR=1SG ASS=1SG=PROG PRF do DEF.SG=sign
 ‘Rats, I should have given [him] a sign by then.’ [KG:492]

12.10 Frequentative and iterative *mu*

mu is a versatile particle, and can mean ‘as well; all along, during a certain time; at selected moments over a long period of time’. Depending on the aktionsart and the aspectual context of the verb, *mu* can take on frequentative functions (72): this concerns telic verbs in general (72 and 73), and countable, finished events (74 and 75).

(72) m=*e* xa-vwa hmwata i=*bee-ng* a=*mu*
 IRR=1SG HAB-make starchy.cake DEF=brother-1SG.POSS 3SG=FREQ
xhajake
 eat.starchy
 ‘Whenever I make a yam cake, my brother eats it.’ [X10:40]

- (73) *calibeen goakan e=mu taemwi li=nyu*
 sometimes moment 1SG=FREQ catch DEF.PL=fish
 ‘I catch fish every time.’ [X10:42]
- (74) *e=bwa mu majit*
 1SG=IPFV FREQ rest
 ‘I sleep from time to time.’ [J4:31]
- (75) *ca i=nyan-mwa xahan le=mu sivu sika*
 in DEF.SG=inside-house over.there 3PL=FREQ blow cigarette
 ‘They have the habit of smoking in this room over there.’ [X10:44]

Another function is iterative, with durative verbs (76). There is a difference in meaning with past and present situations, i.e. an ongoing action with *mu* is yet incomplete and evolving bit by bit (76), whereas a past action happened several times or bit by bit (77). With a stative verb (78), it may mean a development, as with *e-* ‘MID’ (§11.2.2).

- (76) *a=mu hnuut*
 3SG=ITER go.downstream
 ‘He is (still) going down.’ [J4:27]
- (77) *e=bwa mu tena ha-mwa*
 1SG=IPFV ITER hear go-REP
 ‘I heard about it all along.’ [Tipije]
- (78) *a=mu xhwatin*
 3SG=ITER small
 ‘It is shrinking.’

However, *mu* can also have additive meanings (for states, as in (79)). Note that this is only attested in combination with *pa* ‘already’.

- (79) *tha pa mu hman-ong*
 ASS already ADD hungry-1SG
 ‘I, too, am hungry already.’ [J4:30]
- (80) *e=paa mu majit*
 1SG=PRF ADD rest
 ‘I, too, am already asleep.’ [J4:32]

Some uses are ambiguous, with durative, atelic verbs that can be understood as countable events (81). The meanings of *mu* are summarized in Table 12.5.

12 Aspect and mood

- (81) *e=mu se*
 1SG=ITER/FREQ cry
 ‘I cry (often; still).’ [X10:92]

Table 12.5: Shades of *mu*

	<i>mu</i>	<i>bwa mu</i>	<i>pa mu</i>
atelic	still, every time (75, 81)	several times over time (opt. with <i>hamwa</i>) (74, 77)	also (79)
telic	every time (72)		

12.11 Combinations

Vamale aspect markers can be combined to create more complex, and sometimes altogether different meanings. See Table 12.7 for an overview of combinations. Combinations are in some cases preferred to the lone form (especially with *ja* ‘PRF’ and *balan* ‘CONT’), and may change the overall meaning significantly.

Table 12.6: Overview of aspectual markers and their meanings

Form	Gloss	Atelic example <i>majit</i> ‘to lie down’	Telic example <i>hma</i> ‘arrive’
<i>balan</i>	CONT	a b. <i>majit</i> ‘s/he keeps sleeping’	a b. <i>hma</i> ‘s/he will immediately/has just arrived’
<i>bo</i>	IRR/FUT	a b. <i>majit</i> ‘he will sleep’	a b. <i>hma</i> ‘s/he will arrive’
<i>bwa</i>	IPFV	a b. <i>majit</i> ‘he still sleeps’	a b. <i>hma</i> ‘s/he will arrive (certain)’
<i>ja</i>	finally	a j. <i>majit</i> ‘s/he finally sleeps’	a j. <i>hma</i> ‘s/he has finally arrived’
<i>kon</i>	PROG	a k. <i>majit</i> ‘s/he is sleeping’	*
<i>mu</i>	ITER, FREQ	a m. <i>majit</i> ‘s/he sleeps regularly/little by little’	a m. <i>hma</i> ‘s/he arrives (every time)’
<i>pa</i>	PRF	a p. <i>majit</i> ‘s/he has (already) slept’	a p. <i>hma</i> ‘s/he has (already) arrived’

Combinations are not possible between all markers. For instance, perfective *pa* ‘PRF’ and imperfective *bwa* cannot be combined, nor *bo* ‘IRR’ and the realis *bwa* ‘IPFV’. Reversing the order of the markers is rarely possible, though when it is, it always affects the meaning. Several combinations are more frequent than each of their components, especially with *balan* ‘CONT’ (see §12.6). The reason for these differences in aspect marker behavior may have historical reasons.

Table 12.7: Aspect marker combinations

First form	Gloss	Second form					
		<i>bo</i>	<i>bwa</i>	<i>kon</i>	<i>balan</i>	<i>ja</i>	<i>mu</i>
<i>bo</i>	FUT, IRR		*	*	about to happen	will/would finally	will/would from time to time
<i>bwa</i>	IPFV	*		still X-ing since before	finally about to	finally X-ing (in general, not necessarily right now)	still X-ing from time to time
<i>kon</i>	PROG	*	still X-ing right now		has just happened	X-ing at last	X-ing little by little
<i>balan</i>	CONT, REAL	*	*		*	*	*
<i>pa</i>	PRF	*	*	*		finally completed after a known period	*
<i>ja</i>	PRF	*	*	finally X-ing	finally completed after a known period	*	finally from time to time
<i>mu</i>	FREQ, ADD, ITER	*	*	*	*	*	

13 Simple clauses

This chapter treats simple clauses and the elements they contain, and describes how a matrix clause is formed. As this is the first chapter to discuss matrix clauses and the elements that appear outside of verb and noun phrases, particles such as assertive *tha* (§13.3.1) and the repetitive marker *mwa* (§13.4) are described here, as well as the discourse markers *go* (§13.2.1.2) and *ka* (§13.2.1.1). Word order is also explicitly mentioned here for the first time (§13.1), as this is the first chapter to look at the domain of the clause. Simple clauses have one main predicate, one subject, one TAM contour, and share a single polarity. A simple clause may contain several verbs, in the case of serial verb constructions (§10.3.1). The main clause types are declarative (§13.2.1), interrogative (§13.2.3), imperative and prohibitive clauses (§13.2.4). A brief section addresses equative clauses, which in absence of a copula juxtapose two nouns (§13.2.2). As the assertive *tha* is discussed in this chapter, other modal particles and constructions are mentioned as well (§13.3). Most of them involve subordination, which is described separately again in §14.2.1.1. A typical sentence looks as follows:

PN= TAM= root -OBJ/-*ke* (ART=) OBJ (*ka*= (ART=) NP_{subject})

Noun phrases do not necessarily take articles, and argument expression through noun phrases is optional, as indexing on the verb already carries this information.

13.1 Word order

Word order in Vamale does not change across clause types. Vamale is head-first and usually VOS, though fronted, bi-clausal constructions are common: S, VO. The verb always precedes the object, and the traditionally non-marked order expects the subject after the noun. Oblique arguments tend to follow objects (1), but pragmatic choices can invert the unmarked order (2). In general, the earlier a constituent is introduced, the more marked it is.

- (1) *e=holeke* [sika^{obj}] [nyasi i=apuli a= xhwata^{obl}]
1SG=thank.for cigarette BEN DEF.SG=man REL= bald
'I thank the bald man for the cigarette.'

13 Simple clauses

- (2) *e=holeke nyasi-m li=fati a= go=vi*
1SG=thank.for BEN-2SG.POSS DEF.PL=word REL= 2SG=say
'I thank you for the words.' [B2:94]

The basic word order VOS is generally more common with older speakers, while younger generations often front the subject. Stative verbs, especially with inanimate arguments such as in (3), seem to be exempt from the fronting mentioned above, regardless of the speaker demographic. With animate arguments, fronting is especially common, especially when the agent is stressed. Strategies to make the subject less salient to the listener include using the VOS order, as well as not mentioning the subject, and fronting the object, as in (4).

- (3) *sinu i=xho-ng*
ill DEF.SG=leg-1SG.POSS
'My leg hurts.'

- (4) *go, e=xale-ko*
2SG 1SG=see-2SG
'You, I see you.'

- (5) *e=xale-ko*
1SG=see-2SG.OBJ
'I see you.'

13.2 Clause types

Main clauses in this grammar are those who routinely appear alone and cannot be governed by another clause without subordinating morphology. This includes declarative clauses both with verbs and equative ones with nouns, as well as interrogative, imperative, and prohibitive clauses. The morphosyntax of main (or matrix) clauses is the same as that of most subordinate ones, a topic discussed in further detail in Chapter 14. Exceptions to this are imperative clauses, which do not index the subject on the verb.

13.2.1 Declarative clauses

Declarative clauses are the most common ones in Vamale. They usually contain a subject, either present as a proclitic subject marker, for active verbs and nominal predicates, or as a suffix, for stative verbs with an animate subject, and which

can always be expressed as a free noun phrase after the verb phrase, flagged with *ka* ‘SBJ’, or fronted (in which case it is its own clause, prosodically distinct and syntactically not integrated). Exceptions which do not need a subject are impersonal verbs like *vwasoon* ‘impossible’ (discussed in §9.1), and imperative clauses.

13.2.1.1 Discourse marker *ka*

Putting *ka* at the end of a sentence is a question to the listener: do you follow? This *ka* (6) is probably related to *ka* ‘CNJ’.

- (6) *jaa nyu ka*
 many fish DISC
 ‘way too many fish, like’ [KL:249]
- (7) *e=vii abe li=juu apuli ka*
 1SG=say 1PL.EXCL DEF.PL=real human DISC
 ‘I mean us Kanaks, like.’ [KP:73]

13.2.1.2 Discourse marker *go*

One of the most common morphemes found on a clausal level is *go* ‘well, now, and then’. It cannot be used to coordinate noun phrases nor verb phrases, and occurs before coordinators, assertive *tha*, and other left-most boundaries of clauses (8). It is a frequent filler, stretched out to prolong the thinking time of the speaker (*gooooo...* ‘weeell’). Its meaning does not carry information about the relationship of the surrounding clauses: while in many cases, the clause following *go* ‘and then, furthermore’ does semantically follow the previous ones (9), *go* ‘now, on the other hand’ can also mark a change of subject.

- (8) *go tha le=vwa goo i=coutume a= tha le=vwa*
 DISC ASS 3PL=do enough DEF.SG=custom REL= ASS 3PL=do
 ‘Well, they kept the ceremonies that they did, moderate.’ [KP:6]
- (9) *go ka e=ilake hapi gavwe wago*
 DISC CNJ 1SG=ask COMP 2PL brave
 ‘Well, and I ask you to be brave.’ [HC19:20]

13 Simple clauses

13.2.1.3 Discourse marker *bwa*

Similarly to *go*, *bwa* is frequently used at the beginning of a clause. It contributes an attenuating meaning to the clause: ‘just, first, quickly’ (10), but is also used like *go* to keep the speaker role (11).

- (10) *bwa the-balan=wan-ea ka i=yata-n Manu*
DISC THEPUNCT-REAL=change-3SG.OBJ CNJ DEF.SG=name-3SG.POSS M.
ka
DISC
‘First thing that was done, he was quickly and suddenly replaced by the one called Manu, you know.’ [KG:146]
- (11) *ha-go bwaa, tha bwa devoilé Wawa mwa ka Jon xaleke*
EXCM-2SG DISC ASS IPFV unmasked W. DEICT SBJ J. see
‘Man, well, that’s when Wawa was unmasked by John, see.’ [KG:256-257]

13.2.2 Verbless clauses

Vamale has no copula, and thus juxtaposes two nouns do form an equative construction, where the first is the topic, and the second the comment. The example given in (12) is in Usa Vamale.

- (12) *cahma yo ven papa-n ven apuli-ca ko vin apuli*
TOP 1SG DEF.SG father-POSS DEF.SG person-PROX because DEF.SG person
cahni nyae-ung
here child-1SG.POSS
‘[My sister married a man from Poindimié] and me, [I married] the father of the man here, for the man here is my son.’
[vamale-171129-consent-life:0:04:12-0:04:16]

The nominal predicate can also be marked with a third person proclitic *a* (14) and be followed by a subject NP flagged with *ka* ‘SBJ’ (13).

- (13) *ehni i=a= xa-vee ka ya*
DEM DEF.SG=REL= AGT.NMLZ-fuck SBJ 3SG
‘It’s him who is an unpleasant individual, him (not me).’ [KG:496]
- (14) *jacob tha=a=juu xa-vee ma hmwaana*
J. ASS=3SG=really AGT.NMLZ-fuck when like.this
‘Jacob, he’s there like a fool when it’s like this (if there is no bed for him).’
[KL:121]

13.2.3 Interrogative clauses

Interrogative clauses are not marked by a special word order. Polar question clauses usually carry the assertive *tha*, which content question ones do not. Pitch plays an important role in marking the clauses as interrogative: it rises towards the end, being highest on the stressed syllable of the predicate's main word.

13.2.3.1 Polar questions

Polar questions are mostly marked with pitch, either a rising pitch towards the end or with a high pitch on the word demanding confirmation (*tha gavwe xaleke?* 'do you see?').¹ The assertive *tha* is almost always present.

- (15) *tha go=xa-xhwi pimwa?*
 ASS 2SG=AGT.NMLZ-eat chili
 'Do you eat chili?' [G11:2]

13.2.3.2 Content questions

Content questions replace the missing information with a question word, though examples where the missing information is at the end, and just left out, are also attested. The question words are listed in Table 13.1. The pronoun *kai* 'who', maybe from *ka i* 'and the', does not have cognates in neighboring languages.² The noun *da* 'what', used to be considered a impolite, threat-like form, because of its homophony with *da* 'spear' (20). *hmwaeke* 'how?' is preferred, as in (19). The adverb *hmwa-eke* 'how' is related to the verbs *hmwa-ena/hmwa-ehni* 'thus', the noun *hmwa-goon* 'half' (probably composed of *hmwa-* and *goo-n* 'body, sum'), as well as the adverb *hmwa-ka-n* 'like X'. *nyet* 'when' is an adverb (16).

- (16) *go=ta-mwa-me nyet?*
 2SG=go.up-REP-DIR.CP when
 'When did/will you come back?'

The stative verbs *heeve* 'where (mobile)' (17) and *ve* 'where (immobile)' (18) can be combined with *nya* 'towards' and *eca* 'INDF.PL' to form adverbs.

- (17) *go=han heeve?*
 2SG=go where
 'Where are you going?'

¹A relevant description of pitch in a North New Caledonian language is Schooling's (1992) "The phonology of Yuanga: A language of New Caledonia".

²Voh-Koné (Rivierre & Ehrhardt 2006: 125) as well as Cèmuhî (Rivierre 1980: 215) use *de*.

13 Simple clauses

Table 13.1: Question words

<i>kai</i>	‘who’
<i>da</i>	‘what’
<i>hmwaeke</i>	‘how’
<i>gau ma</i>	‘with whom’ (§8.5.1)
<i>heeve</i>	‘where (mobile)’
<i>ve</i>	‘where (immobile)’

- (18) *go=ha-me moo ve?*
 2SG=go-DIR.CP stay where
 ‘Where are you coming from?’
- (19) *sahnaang-eo ma le=vwa ko hmwaeke*
 not.understand-1SG SUBR 3PL=do because be.how
 ‘I’m not sure why they do this (lit. I’m not sure that they do it because of what).’ [D6:11]
- (20) *i=bol gase=vwa ko i=da?*
 DEF.SG=ball 1PL.INCL=do OBL DEF.SG=what
 ‘The (cricket) ball, what did we make them with?’ [KL:126]

13.2.4 Imperative and prohibitive clauses

Orders take two forms: The simple form, used in intimate settings and with younger people, in situations of emotional affect etc, is the same as the quotation form of verbs, and consists in the stem (21). The person meant by the imperative can be marked by adding a noun phrase *ka* ‘SBJ’ + pronoun after the verb (subject indexing is still dropped) (22).

- (21) *se!*
 cry
 ‘Cry!’
- (22) *xale-ke ka go!*
 look-TR SBJ 2SG
 ‘Look!’

The other, more polite form is an (in)subordinated clause (23), which may be joined by a main clause expressing the speaker's attitude towards the order: *xahnang* 'good', *juu aman* 'important', *goon* 'possible, permitted', etc. This is discussed in further detail in §14.3. This construction is the most commonly used for stative verbs, which rarely occur in imperative settings.

- (23) (*xahnang*) *ma go=soom...*
 (good) SUBR 2SG=swim
 'You could swim (that would be good)'

Prohibitive clauses, contrary to the imperative, admit person marking (25), though this is rare; *ka* + PN constructions are preferred. Every prohibitive predicate is preceded by a dedicated particle *cipii* (24).³ Bwatoos uses *cipa* for both negating and prohibitive functions (Rivierre & Ehrhardt 2006: 58). The Hienghène languages except Pije have similar negating and prohibitive particles as well (Haudricourt & Ozanne-Rivierre 1982: 250), but closely-related Cèmuhi does not.⁴ While *cipa* 'NEG' precedes the subject marker, this is not the case for *cipii* 'PROH', suggesting a different status, possibly more akin to a preverb (§10.3.2.1). The data on prohibitive clauses with person indexing is too sparse yet to draw a conclusion.

- (24) *cipii see*
 PROH cry
 'Don't cry!'
- (25) *go=cipii weke*
 2SG=PROH rage
 'Don't be angry.' [B2:8]

13.3 Modality

Modality is marked on the clause level, i.e. the particle *tha* and the modal subordinating constructions do not depend on any part of the commented clause. Modality is expressed in two ways: one employs modal words in a subordinating

³The prohibitive particle contains the negative prefix *ci-* (PMP *(q)ati, Lynch et al. 2002: 88) also present in *cika* 'NEG.EXIST' (from POc *tikai, Lynch et al. 2002: 88), in *cia-* 'be absent', and the neutral negator *cipa*.

⁴Cèmuhi has *tíme* 'NEG' (Rivierre 1980: 184), *tíé* 'be absent' (Rivierre 1980: 111), and *tíc(i)é* 'NEG.EXIST' (Rivierre 1980: 302), but the prohibitive is *nèmwó* (Rivierre 1980: 223).

13 Simple clauses

construction, to which the commented clause is a complement (see §14.2.1.1). The other uses dedicated particles and constructions, some transparently decategorized from verbs and phrases still used with non-modal meaning. This section will first discuss *tha* (§13.3.1) and describe modal constructions in general, first epistemic, then deontic constructions.

13.3.1 Assertive *tha*

The assertive *tha* is a frequent particle on the far-left border of the predicate. Preceded, in subordinate clauses, by the subordinator (e.g. *a* ‘REL’, *cama* ‘SUBR’), and in equative constructions by the topic, *tha* is analyzed as belonging to the predicate both syntactically and phonologically. The particle expresses that the speaker is invested in the content, i.e. that they believe the thing to be true, and is thus in complementary distribution with (*bo*) ‘IRR’. A notable exception, already discussed in §12.2: if a formerly irrealis situation has been realized, the past situation can be marked as irrealis via *bo* and still spoken of with confidence (26).

- (26) *e=caihnan hapi tha go=bo vwa*
1SG=KNOW COMP ASS 2SG=IRR do
‘I knew that you would do it.’ [D6:10]

The vowel in *tha*= [t^ha], as is the case for the negation *cipa* and most subordinators, assimilates to *e* ([e]) ‘1SG’, forming *th=e* [t^he], effectively forming a proclitic-host construction.

13.3.2 Epistemic modality

Apart from *tha*, Vamale uses a variety fixed expressions to express speaker certainty concerning the discussed information. Doubt is expressed by using *cama* ‘if, when (IRR)’ (27), *bo* ‘IRR’, or with verbs like *cacahniing-* ‘be unsure’ and *sahnaang-* ‘be confused, not know’. Certainty, a part from *tha*, is expressed by using realis TAM markers *pa* ‘PRF’ and *ja* ‘PRF’ (28). The particle for generally known truth *ko* described for western varieties (Rivierre & Ehrhardt 2006: 55) is not attested in Vamale; instead *vwa hâwan nyakoo-n* ‘there is a visible manifestation of it’ is used (29).

- (27) *cama fine nya-koo-n*
if count put-on-3SG
‘It is doubtful.’ (lit. ‘Whether one counts on it’)

(28) *th=e ja fine nya-koo-n*
 ASS=1SG count SUBR put-on-3SG
 ‘I am sure of it/him/her.’

(29) *vwa hâwân nya-ko hapi a=welo*
 EXIST spirit put-on SUBR 3SG=crazy
 ‘It is apparent that he is drunk [he is slow, slurred speech etc].’ [XL2:16]

13.3.3 Deontic modality

Vamale expresses deontic modality through subordinating constructions with *ma* ‘SUBR’ (30), further discussed in §14.2.1.1. The matrix clause is a single modal word and the subordinate one contains the Comment. Important constructions are *goon ma...* ‘enough SUBR’ ‘it is possible/allowed to...’, *siteke ma* ‘taboo SUBR’ ‘it is forbidden to...’, *vwasoon ma* ‘impossible SUBR’ ‘it is difficult/impossible to...’, *xahnang ma* ‘good SUBR’ ‘it is good to...’. The constructions may use *cama* ‘if, when (IRR)’ instead of *ma* to express more hypothetical scenarios.

(30) *vwasoon ma le=fe-ta-ong ko-n salle*
 impossible SUBR 3PL=take-go.up-1SG.OBJ OBL-NSPEC operation.room
vukin da
 reason why
 ‘They couldn’t take me to the hospital because of what?’ [KG:191]

13.4 Repetitive and deictic *mwa*

The particle *mwa*, already mentioned in §6.20, versatile and docks onto verb and noun phrases alike, as well as adverbs. This chapter takes it into closer consideration now rather than in previous parts, because *mwa* cannot be attributed to one particular word class more than to another. It takes different, related meanings depending on the context (31).

(31) *i=daahma mwa*
 DEF.SG=chief REP
 ‘the chief again/too/even’

13.4.1 Repetition

The most common function is repetition, and its close cousin, restitutive ‘back’. Other meanings conveyed by *mwa* include ‘also’, ‘even’, ‘on top of that’, but *mwa*

13 Simple clauses

can also mark the preceding phrase as focused (see §13.4 for a discussion). *mwa* ‘now’, appears to mostly anchor the listener’s attention, similarly to *mwa* ‘even’, onto the noun phrase given (32).

- (32) *hâ gaa mwa naen hmwa-ena*
 yes 1PL.INCL REP now be.like-DIST
 ‘Yes, we (however) are like that now.’ [KP:101]

Consider (33), which was already shown in §6.20 to illustrate that *mwa* can dock onto verb and noun phrases alike. This example shall also serve to show how *mwa*’s scope works: while *nya si-m* ‘put hand-2SG.POSS’ is the unmarked construction meaning ‘to give to you’, [*nya mwa*] *si-m* means that the object is handed down from a previous interaction (not with the present recipient): ‘give again, to you’. However, *nya si-m mwa* means that something is given, as other things were given before, to the same recipient: ‘give to you this as well’. This *mwa* can also mean that something is given here, now, even, etc. And finally, [[*nya mwa*] *si-m mwa*] can have several meanings: either something is handed back and forth between Source and Recipient several times ‘give back to you again’, or only once (and the last *mwa* has a deictic function) ‘give back to you now, give back to you as well’, or several Themes take the same (possibly reciprocal) Path: ‘give this, too, to you’ (22.07.2019, p.76). All of the above-mentioned constructions are attested, especially in customary exchange speeches.

- (33) *e=vatipwe mwa nya mwa si-m mwa i=mwani mwa*
 1SG=drop REP put REP hand-2SG.POSS REP DEF.SG=money REP
 ‘I pass on to you too this money as well.’ [22.07.2019, p.76]

In (34) and for all other movement verbs, as well as *xhose* ‘do again’, *mwa* is analyzed as suffix, i.e. as having fused phonologically with its host. Apart from integrating the host’s stress contour, which *mwa* does with other words as well, *mwa* assimilates to the root, which it does not do in other contexts.⁵ Compare *hut-mwa* → /hup^wa/ ‘go back down’, to *hut=mwa* ‘go down again’.

- (34) *go=ha-mwa-me*
 2SG=go-REP-DIR.CP
 ‘You return to me.’/‘You come back.’

⁵*xhosepwa* suggests a dropped *-t* or *-p*. The Pije and Fwâi cognates *khô-peei* ‘?-say’ (Haudricourt & Ozanne-Rivierre 1982: 155) could be a diachronic hint at a morphologically complex, old Vamale form.

- (35) *go=ha-me mwa*
 2SG=go-DIR.CP REP
 ‘You come again.’

Repetition and deixis are the two most frequent functions of *mwa*. Examples (36) show different contexts in which *mwa* is a repetitive particle.

- (36) *e=tena mwa^{REP} i=hun-det*
 1SG=hear REP DEF.SG=NMLZ-sound
 ‘I hear the sound again.’ [JR:17]
- (37) *e=thake i=vai nyako i=siibwi e=thawatap ka e=thake*
 1SG=throw DEF.SG=stone OBL DEF.SG=rat 1SG=miss CNTR 1SG=throw
mwa i=e-thalo-ka-n
 REP DEF.SG=ORD-two-clf.POSS-NSPEC
 ‘I throw the stone at the rat, I miss and I throw again a second [time].’
 [JR:26]
- (38) *cipa=be=bo xale-ko mwa^{REP} hmakoo-n habu mwa^{REP}*
 NEG=1PL.EXCL=IRR see-2SG REP find-NSPEC long.ago REP
 ‘We will never see you again.’ [CD:14]

13.4.2 Deixis

Apart from repetition, *mwa* is chiefly used for spatial and temporal deixis. As such, *mwa* marks temporal and spatial immediacy to the speaker or the spoken-of event: in example (39), *mwa* is used to connect the events tightly together, expressing how quickly things followed each other. In (40), the noise referred to is already known to the speaker, because it was recently mentioned. In (41), *mwa* clarifies which event had happened by which moment in the narration: he had already died by the time they found him. Concerning spatial deixis in (42), the area in question is visible from the speaker’s chair. The semantic closeness to the deictic constructions discussed above is apparent: in both cases, *mwa* designates something known to the speaker and to the hearer.

- (39) *a cana ka th e=bwa vee mwa vwaseekan mwa ko*
 EXPL vagina CNJ ASS=1SG IPFV fuck DEICT sad DEICT because
vukin-eong mwa
 cause-1SG.POSS DEICT
 ‘Ah shit, I’ve just messed up right now, I sorry [for them] now because this right here is because of me.’ [KG:491]

13 Simple clauses

- (40) *xhose e=tena mwa^{REP} tha a bwa vwa det mwa^{DEICT}*
 again 1SG=feel REP ASS=3SG IPFV do sound DEICT
 ‘Again I heard him make said (*mwa*) noise.’ [JR:18]
- (41) *go le=ja thathe-a mwa^{temp. deix} go le=nya siwa mwa^{REP}*
 then 3PL=PRF kill-3PL DEICT then 3PL=towards return REP
 ‘And they had finally killed him then, and then they went back.’ [HC1:14]
- (42) *na i=bee i=papa-n ena xahnuut pwanbaut*
 DEM DEF.SG=brother DEF.SG=father-POSS DIST downstream P.
mwa^{spat. deix}
 DEICT
 ‘[The one who was killed] is the brother of the father of those down in P.
 there.’ [HC1:22]

In (41), *mwa* could indicate that the death is already known to the speaker. In (43) and (44), it may refer (back) to the speaker’s group (i.e. his generation), and in (45) mark that the life he speaks about was mentioned before. Note that Mr. Fouan does not use *-kaa* ‘1PL.INCL.OBJ’, but *-gaa*, which looks more like (stative) subject-indexing pronouns.

- (43) *i=ape-caihnan aman-le tha seen-le pas tout le monde.*
 DEF.SG=LOC-know something-3PL ASS limit-3PL.POSS not.everyone
go cama gaa mwa vwa li=bebe-n-le le=hnyaa-mwa
 then TOP 1PL.INCL REP EXIST DEF.PL=baby-POSS-3PL 3PL=send-DEICT
la la
 PROX PROX
 ‘Their knowledge is limited to them, not everyone. And, concerning us,
 there were their babies that they sent there [to school].’ [KM:61]
- (44) *hnya-mwa-ga can mwa-n-sohmun-ea*
 send-DEICT-1PL.INCL in-NSPEC house-POSS-study-3SG.POSS
le=ecaa-gaa mwa ko ca=aman a= saten
 3PL=learn-1PL.INCL DEICT OBL INDF.PL=thing REL= different
 ‘They₁ sent us to his school, they₂ taught us other things.’ [KM:62]
- (45) *tha se mulip mwa, go a ga ca-n naen*
 ASS other life DEICT DISC CNJ 1PL.INCL in-NSPEC now
 ‘It was another life then, and now here we are.’ [KM:64]

In local French, *encore* ‘again’ is used as ‘even, on top of that’. This may be a calque from Kanak languages, as e.g. *mwa* is used exactly like that in Vamale (46). Another way of expressing ‘on top of that’ is *xhopwe*, but the information in its scope is less surprising to the hearer.

- (46) *ka lu e-bee-lu mwa!*
 CNJ 3DU RECP-peer-3DU even
 ‘And on top of that, they’re related!’

14 Complex clauses

This chapter describes complex clauses in Vamale: coordinated and subordinated clauses, including relative clauses. This excludes fronting, which is discussed in §8.3, as it mostly concerns noun phrases. Subordination is a central part of Vamale syntax, since virtually every modification of a verb's argument happens through a subordinated clause, as does much verbal modification. Relative clauses are discussed in §14.2.3. Like most Oceanic languages, Vamale does not have a pivot function of the subject; instead it marks the subject in all coordinated and subordinated clauses, whether the subordinate subject is the same as the one in the matrix clause or not. The object of a matrix clause cannot be the implicit subject of a subordinate clause (e.g. *I_i saw the man who _i walked past.*), nor does the subject of one coordinated clause automatically have the same referent as the omitted subject of the other coordinated clause (e.g. *I_i come to _i work.*). Usually, a subject is present in every clause, with the exception of adverbial clauses (§14.2.2).

Some morphemes have both subordinating and coordinating functions, e.g. *ma* (§14.2.1.1, §14.2.5), and the presence of insubordination, usually with adhortative or optative function, confronts us with matrix and subordinate clauses that look the same. Insubordinate clauses are structurally identical to subordinate clauses, with the exception that they do not depend on a matrix clause (§14.3). Apart from complement clauses, which are unambiguous, there are cases of two subordinate clauses coordinated by a conjunction, showing that they do not occupy the same slot (ex. 27 in §14.2.1.2). Furthermore, coordinate clauses cannot be fronted (though a coordinating conjunction may be the first element of a clause), whereas some subordinate ones can.

Since most coordinators, subordinators, and the relativizer all end in /a/, the 3SG subject index *a* is not pronounced separately. All other subject indices do occur, albeit often in a fused form with the preceding morpheme, e.g. *m=ase* for *ma gase* 'SUBR 1PL.INCL', or *m=e* for *ma e* 'SUBR 1SG'.

Coordination reduction constructions, in the sense that subjects are omitted from consecutive coordinated clauses if they are the same, exist in Vamale (4), contrary to the typical Oceanic pattern (Ross 2004: 517). The same is the case for subordinate clauses, though an absence of subject means a more immediate

14 Complex clauses

sequence: compare (1), where killing is the underlying purpose of the matrix verb, to (2), where raising children is a more general and long-term goal not immediately tied to going into the house.

- (1) *le=hma wati-le ma xaa-le hnuuda-me cahni*
3PL=arrive chase-3OBJ SUBR beat-3PL.OBJ upstream-DIR.CP here
'They came to hunt them in order to strike them coming here up the river.' [HC1:7]

- (2) *ma le=hma-san a=feanake si-le joakan juu-mwa, vwa can*
when 3PL=arrive-go 3SG=show BEN-3PL big real-house do ADV.SUBR
vi "In Fwe ta ca i=juu-mwa-ca ma go=silaa
say Bark Figtree go.up in DEF.SG=real-house-PROX SUBR 2SG=raise
mu=nyai-m."

DEF.DU=child-2SG.POSS

'When they arrived, he showed them a big house, and said while doing so "Figtree-Bark, go up into the house, so as to raise your children."' [GC 57.1]

To give an overview of a complex sentence, (3) shows a clause containing an equative clause, a relative clause, a verb phrase with an argument, and a second relative clause modifying the argument.

- (3) *tha le li=a= le=xhwat xhwi li=nyu a= xhopwen ka*
ASS 3PL DEF.PL=REL= 3PL=almost eat DEF.PL=fish REL= big SBJ
li=apuli-aen

DEF.PL=person-DEM.DIST

'These people are the ones who almost eat/ate the big fish.'

14.1 Coordination

Coordination of clauses in Vamale holds no deep secrets. The string of clauses is articulated via elements which, in many cases, also appear in the coordination of noun and verb phrases. Both clauses maintain the same word order as single clauses. Coordination reduction constructions which would remove subject marking, are rare. One case of this is (4) below.

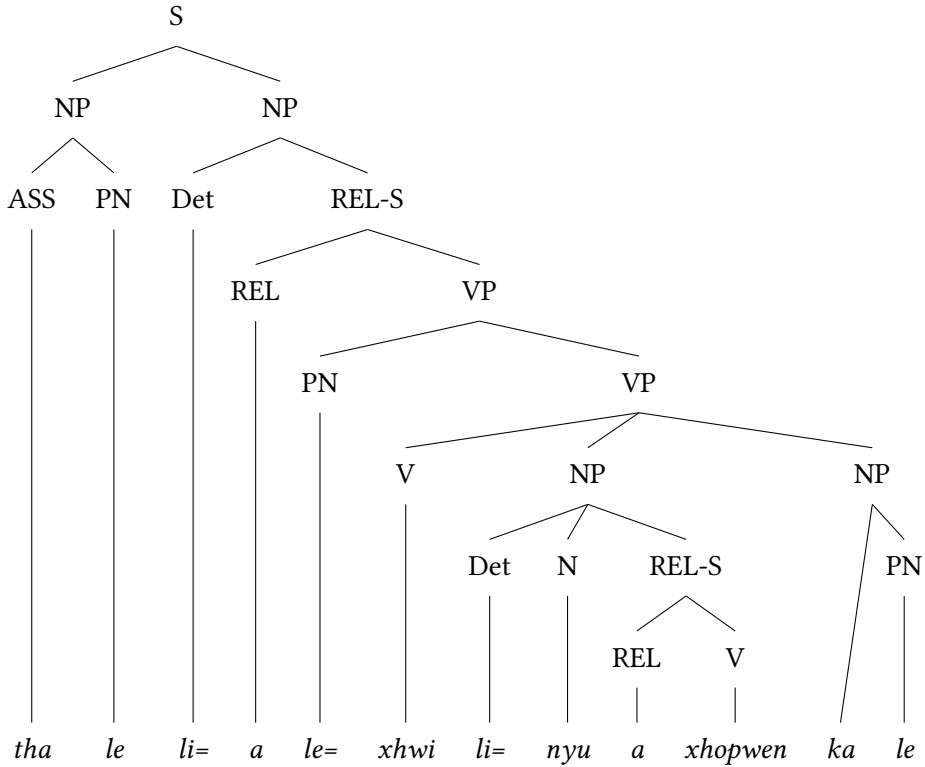

Figure 14.1: Tree-diagram of the sentence structure of example (3), with *le* '3PL' instead of *li apuli-aen* 'these people'

14.1.1 Comitative *ma*

Contrary to most other coordinators, *ma* is not attested linking complete clauses, both with their own subject marking, TAM contour, etc. Instead, *ma* is a common coordinator for noun phrases, and is found with verb phrases as well. As for noun phrases, the clauses linked must be semantically part of the same group (4). I mention *ma* here because *ma vwa-tau* is a coordination reduction construction: as the subject and the TAM contour are the same, indeed the verbs are semantically close (hunt and fish), *vwa-tau* 'fish' does not need any of the usual particles surrounding it.

14 Complex clauses

- (4) *go=caihnan naen goon ma abu=ja vap ma vwa-tau, pa ja*
2SG=know now enough SUBR 1DU.EXCL=PRF hunt CNJ do-impact PRF PRF
tehnang li=si-bu
sharp DEF.PL=hand-1DU.EXCL.POSS
'You know, now we can hunt and fish, our hands have become deft.'
[GC:89]

14.1.2 *kona, kon* 'then'

The classic coordinators *kona* (5) and *kon* (6) both mean 'so, and then', though *ko na* 'and/but DEM' also exists, identical in syntactic distribution and phonological shape. *kona* and *kon* are semantically close and present a similar form, and may in fact be allomorphs or free variants.

- (5) *kona tho-vi nyako i se Ngeein ka i se Cada*
CNJ call-say OBL DEF.SG=other N. CNJ DEF.SG=other C.
'And he called the one of them Sound and the other Beat.' [GC:551]
- (6) *kon abe=kon xaahni ca=piece-abe ma*
CNJ 1PL.EXCL=PROG watch INDF.PL=coin-1PL.EXCL SUBR
abe=thake-bigo
1PL.EXCL=throw-bingo
'And we're saving some money for ourselves to play bingo.' [AG1:67]

14.1.3 *hai* 'or'

The coordinator *hai* is used in three contexts: to coordinate two noun phrases or clauses (introduced in §8.5.3), to close a clause, implying that a list of possibilities goes on (7), and to begin a clause that is in direct contrast with the preceding one (8). In most unmarked scenarios, *hai* is realised [a]. The *hai* form cannot be substituted by *a* when contrasting two noun phrases *hai X hai Y?* 'X or Y?' (see §8.5.3), but is otherwise an allomorph of *a*. Note that in (9), *hai* coordinates two subordinate clauses introduced by *ma*.

- (7) *naen mwa a xahmaen mwa a*
now REP CNJ tomorrow REP CNJ
'See you later, or tomorrow, or...'

- (8) *xhaohmu tha juu the-profiter tha juu facturé mu=palette*
 old ASS real THE_{PUNCT}-profit ASS real write.up DEF.DU=palette
agglo yayo. a i=camion choc, ya tha choc
 cement.brick EXPL CNJ DEF.SG=truck good 3SG ASS good
 ‘The old man, he really made a quick profit, he made them pay for the
 two cement brick palettes, damn. The truck was fine however, it was fine.’
 [KG:535-536]

- (9) *ca i=wadan-aen cahma Xa-xhwi Apuli, a=nyawân aman ka*
 in DEF.SG=time-DEM TOP AGT.NMLZ-eat person 3SG=spirit thing CNJ
apuli, ma jeena-n meekan ka a=tena i=a=
 person COM ear-3SG.POSS everywhere CNJ 3SG=hear DEF.SG=REL=
le=kon e-vi nya pwa i=bwan, a=kon e-hnyimake
 3PL=PROG RECP-say put on DEF.SG=mountain 3SG=PROG REFL-think
ma a=xhwii-le hai ma a=cee-le ma le=han.
 SUBR 3SG=eat-3PL CNJ SUBR 3SG=leave-3PL SUBR 3PL=go
 ‘At this moment, Maneater, who was half man, half spirit and had ears
 everywhere, and had heard what was said on the mountain, wondered
 whether he was going to eat them or let them go.’ [GC:107]

14.1.4 Contrastive *ka*

Like for noun phrases, a clause introduced in contrast to the preceding one is usually coordinated with *ka*.

- (10) *tha le=thagavi yee ko-n gi gi ka thala a= xhopwen ka*
 ASS 3PL=cut tree OBL-NSPEC axe axe CNJ knife REL= big CNJ
gaa naen vwa meekan nyasi-je vwa tronçonneuse
 1SG.INCL now EXIST everything for-1INCL.POSS EXIST chainsaw
 ‘They cut trees by axe, axe and machete, but we now, we have everything,
 we have chainsaws.’ [KP:103]

14.1.5 *ko* ‘but’

ko ‘on’ is one of the most versatile particles in the language, i.e. *ko* appears with many different functions. Apart from a preposition ‘on’, and an oblique marker, *ko* is also used on an interclausal level, ranging from the coordinating ‘and, but’ (11) and (12), to the subordinating, adjunct-adding ‘because’ (13).

14 Complex clauses

- (11) *ko na kai a= eca-kau ko nien-aen?*
 CNJ DEM who REL= teach-2DU.OBJ OBL DEM.PL-DIST
 ‘But who is it that taught you two about all this?’ [GC:81]
- (12) *ko le, li=xhaohmu, tha xahnang-le*
 CNJ 3PL DEF.PL=old ASS good-3PL
 ‘But they, the elders, they were fine.’ [RP:16]
- (13) *e=vi ko e=bwa xaleke*
 1SG=say because 1SG=IPFV see
 ‘I’m saying this because I still got to see it.’ [KL:114]

14.1.6 *koin* ‘then’

The coordinator *koin* ‘then’ derives from the word *koin* ‘end’, which exists as a noun and as a verb (14).

- (14) *koin hut pwan maa hma-cu xahut ka cama*
 end go.down on reef arrive-stand down.there CNTR TOP
i=khîi a=han moo ko-n maa
 DEF.SG=swamp.hen 3SG=walk stay on-3SG.POSS reef
 ‘When the tide had well receded, the swamp hen went walking [fishing]
 on the reef.’ [HC2:1]
- (15) *a=vi maman Henri ma maama-le-mwa lu=tua*
 3SG=say mother H. COM mother-3PL.POSS-DEICT 3DU=take.out
a=fe i=dipi ka i=see koin a=fe sanan ka
 3SG=take DEF.SG=cover SBJ DEF.SG=other finish 3SG=take content SBJ
i=see
 DEF.SG=other
 ‘That is, Henri’s mother and the mother of the others, the two
 unwrapped it and one took the cover [of the War Money], then the other
 took the content.’ [HC1:17]
- (16) *vwa i=fwa koo-n. koin i=mapu le=mu ta can*
 EXIST DEF.SG=hole on-3SG.POSS after.that DEF.SG=bee 3PL=FREQ go.up in
 ‘There is a hole in [the tree]. And the bee, they will go up in there.’
 [KM:2-3]

If *koin* occurs before a VP, it seems to mean “while”, as in (17).

- (17) *a=kon vi hapi na gasu=enregistrer koin gase=bo pala*
 3SG=PROG say that DEM 1DU.INCL=record while 1PL.INCL=IRR say
 ‘He is saying that we will record while we will be speaking.’ [Tipije:1]

14.1.7 Contrastive *kavi*

kavi ‘but’ introduces a coordinate clause that contrasts strongly with the preceding one (18). While it most often coordinates two clauses, *kavi* is also attested at the beginning of an utterance, to contrast it with statements made immediately before in the conversation (19).

- (18) *cip=abe=vwa-taeke kavi abe=vwa*
 NEG=1PL.EXCL=do-badly but 1PL.EXCL=do
 ‘We’re not doing [custom] badly, we’re (simply) doing [the work].’
 [CP1:23]
- (19) *kavi th=abe vwa nyeca i=teete*
 but ASS=1PL.EXCL do in DEF.SG=aunty
 ‘But we’re doing [the funerary work] with the [deceased] Aunty in mind.’
 [CP1:24]

14.2 Subordination

Most subordinate clauses, apart from complement and relative ones, are introduced by the neutral verbal subordinator *ma*, as in (20), or by a complex form containing it, e.g. *cama* ‘if (IRR)’ and *ko-ma* ‘so that (lit. because-SUBR)’, see (21).

- (20) *ju-vaa vwasoon ma gase=vwa li=vaaya-n li=xhaohmu*
 too.much impossible SUBR 1PL.INCL=do DEF.PL=work-POSS DEF.PL=old
 ‘We cannot do the works of the elders.’ [KP:98]
- (21) *udu li=fati li=xhaohmu ko-ma e-vwa ka-n*
 drink DEF.PL=word DEF.PL=old because-SUBR INS.NMLZ-do ABS-NSPEC
nyakoo-m ca i=thoatit a= bwa la
 for-2SG.POSS in DEF.SG=day REL= IPFV be.here
 ‘Drink the words of the elders so that they be tools for you in the day that will come.’ [GD:2]

14.2.1 Complementation

Complement clauses are introduced with *hapi* (*na*) for verbs of perception and locution (e.g. *vii* ‘say’, *tena* ‘hear’), and with *ma* for modal verbs.

14.2.1.1 Modal complementizer *ma*

Modal constructions in Vamale are to a large extent formed in the same way: a matrix clause consisting of a modal word, and the proposition modified by the modal word, i.e. a complement clause. While the complement clause usually takes subject index marking, the 3SG form *a* merges with the subordinator *ma* and is used in contexts where the subject is unknown. In (22), the modal word is the stative verb *xahnang* ‘good’, which introduces the desirable proposition (‘if I knew what you are talking about’).

- (22) *xahnang m=e bo caihna-n hapi go=pala ko i=da*
 good COMP=1SG IRR KNOW-ANA COMP 2SG=speak OBL DEF.SG=what
 ‘It would be good if I knew what you are talking about.’

Modal words include in fact only two non-verbs: the deontic modal word *goon* ‘enough’ → *goon ma* V... ‘it is possible, it is allowed’, and *xhwan* ‘bite, bit’ → *xhwan ma* V... ‘barely, almost’ (23). The other members are verbs. Some verbs are decategorialized and also exist as stative verbs with predicative function, e.g. *xahnang* ‘good’ and *nyau* ‘bad’, see *xahnang-eo* ‘I am good’.

Other modal verbs, especially impersonal ones, always have a modal function, and always take a complement. This includes the deontic verbs *vwasoon* ‘impossible’ and *siteke* ‘taboo’, as well as epistemic *vaang* ‘unknown’. Like other epistemic modal verbs, *vaang* may take the complementizer *hapi* as well as *ma*. A subset of these modal verbs inflects for person: *nyima-n ma* ‘s/he wants, that...’, *saxhwe-a ma* ‘to not want, that’, *sahnaang-ea ma* ‘to not understand if’, *cacahniing-ea ma* ‘to be unsure if’.

- (23) *yo, xhwan e-goakan se m=e=bwa xhwi nyu*
 1SG hardly MID-time one SUBR=1SG=IPFV eat fish
 ‘I rarely eat fish (Hardly is there a time when I eat fish).’ [X10:24]

14.2.1.2 Complementizer *hapi*

The complementizer *hapi* is used to introduce the argument of verbs of “locution or perception” (Lynch et al. 2002: 53), e.g. *vii* ‘say’, *hnyimake* ‘think’, etc. Coupled

with *na* ‘DEM’, *hapi* can also introduce quoted speech as in *a vi hapi na* ‘s/he says that’.

- (24) *In-Fwe hapi* “*In-Fwe ka e=hu-pe nya hnya-da*
 F. COMP F. CNJ 1SG=come-DIR.CP from PROX-move.up
xa-da” *kavi cipa a=vi i=goakan.*
 LOC.ADV-move.up but NEG 3SG=say DEF.SG=place
 ‘Figtree-Bark said that “[my name is] Figtree-Bark and I come from
 somewhere a little further up” but she didn’t say the place.’ [GC:53.2]

However, *na* can be omitted (24), as can even *hapi*, in a context where the clause boundaries are otherwise clarified (25). In the latter example, the main verb is *fwajimwa-ke* ‘ask-TR’, which is transitive but demands an Experiencer argument (the person asked). The other clause cannot be added with *hapi*, as the latter is governed by a semantically defined group of verbs, which does not include *fwajimwake*. Hence we have two clauses: matrix clause *efwajimwako* and matrix clause *kai a i vukin-ea. i vukin-ea*, a nominalized form of the stative verb *vukin-* ‘to be the cause’, is the predicate of the equative clause with *kai*, which is itself an content of the question *fwajimwa-ko*, but cannot be added to the main verb. The two clauses are distinguishable by prosody, as *kai* marks the beginning of a new pitch contour. Note that *kai* is fronted here, as it is the focussed element of the question; the unmarked order would be *i vukin-ea kai?*.

- (25) *e=fwajimwa-ko: “kai a i=vuki-n-ea”*
 1SG=ask-2SG who 3SG DEF=cause-POSS-3SG.S_p
 ‘I ask you who the culprit [of this] is.’ [D3:110]

The complementizer *hapi* is not necessarily the only morpheme to subordinate a clause. In (27), the speaker is more certain of the content of the irrealis subordinate clause than in the unmarked example (26).

- (26) *e=caihnan hapi a=bo vwa*
 1SG=know COMP 3SG=IRR do
 ‘I know that he will do it.’
- (27) *e=caihnan hapi ma a=bo vwa*
 1SG=know COMP SUBR 3SG=IRR do
 ‘I know with certainty that he will do it.’

14.2.2 Adverbial clauses with *can*

Adverbial clauses are introduced with *can*, derived from *ca-n* ‘in-NSPEC’ and are indistinguishable from matrix clauses, except that the former’s verb does not take subject marking (28). Since the adverbial clause’s subject must be the same as that of the matrix, the subject index proclitic is omitted. Aspect markers are rarely used, as the TAM contour is the same as the matrix clause’s, but *bwa* ‘IPFV’ was overheard. Stative verbs that retain their subject marking are not attested. This weak desententialization is somewhat unusual for Oceanic languages, which canonically do not desententialize their adverbial clauses at all (Ross 2004: 519).

- (28) *gase=xadaa ha-mwa ca-n sate-n moko*
 1SG.INCL=on.the.other.hand go-DEICT in-NSPEC be.different-NSPEC CPR
i=hun-moo-gaa
 DEF.SG=NMLZ-be-1SG.INCL
 ‘We however walk now differently from our traditional ways.’
 [2017-08-48.1]

- (29) *go=han ca-n hnyimake thamo*
 2SG=go in-NSPEC think.about woman
 ‘You’re walking while thinking of women.’ [G4 22.1]

If an adverbial clause comes after a verb’s argument, especially if the resulting construction is long, a resumptive *vwa* ‘do’ may be introduced as an anaphoric host to the adverbial clause (30).

- (30) *ma le=hma-san a=feanake si-le joakan juu-mwa, vwa can*
 when 3PL=arrive-go 3SG=show BEN-3PL big real-house do ADV.SUBR
vi “In Fwe ta ca i=juu-mwa-ca ma go=silaa
 say Bark Figtree go.up in DEF.SG=real-house-PROX SUBR 2SG=raise
mu=nyai-m.”
 DEF.DU=child-2SG.POSS
 ‘When they arrived, he showed them a big house, and said while doing so
 “Figtree-Bark, go up into the house, so as to raise your children.” [GC
 57.1]

14.2.3 Relative clauses

Relative clauses in Vamale are typical of Oceanic languages, in that they are introduced by a morpheme that looks like a pronoun (Ross 2004: 516). In our case,

a ‘REL’ is formally identical to *a* ‘3SG.S_A’. Relative clauses feature resumptive morphemes which allow the language to relativize a noun phrase in any position on the Accessibility Hierarchy. All NPs can be represented by a resumptive morpheme, but this is not obligatory for the subject.

- (31) *e=xaleke i=xawakhan a= tana*
 1SG=see DEF.SG=dog REL= red
 ‘I see the red dog.’ (lit. ‘I see the dog that red.’)
- (32) *le=vwa ma le=thabilo li=a= le=fee-ko*
 3SG=do SUBR 3SG=kill DEF.PL=REL= 3PL=take-2SG.OBJ
 ‘They will kill those who took you.’ [B1:8]

If the relativized, inanimate noun phrase was already mentioned, it does not get mentioned again (34), unlike in Bwato (33), where it reappears in the slot of its new syntactic function.

- (33) ⟨*zho tahmake ani meata a go thaxhuti-a*⟩ (Bwato)
ǰo taṃake anī mēāta a ʷgo θaxuti-a
 1SG know DEF story REL 2SG tell-3SG.OBJ
 ‘I know the story that you are telling.’ (Rivierre & Ehrhardt 2006: 71)
- (34) *e=holeke nya-si-m li=fati a= go=vi*
 1SG=thank put-hand-2SG.POSS DEF.PL=word REL= 2SG=say
 ‘I thank you for the words you said.’ [B2:94]

A relativized subject noun phrase which is the subject in the relative clause as well, is most often indexed on the subordinated verb, but the relativizer itself is commonly skipped (35).

- (35) *tha vwa li=personnes le=caihnan tuu mapu*
 ASS there.is DEF.PL=person 3SG=know pull bee
 ‘There are people who know how to pull bees [= harvest honey].’ [KM:13]

Several relative clauses may follow one another, modifying the same noun phrase (36), but this was not attested outside elicitations.

- (36) *e=holeke nya-si-m i=xawakhan [a= siim-ea] [a=*
 1SG=thank put-hand-2SG.POSS DEF=dog REL= mange-3SG REL=
go=nya-a]
 2SG=give-3SG.OBJ
 ‘I thank you for the mangy dog you gave [me].’ (lit. ‘I give.thank.for to-you the dog that mangy-he that you-give-it’)

14.2.4 Purposive function of *ma*

A very common function of *ma* is to subordinate a purposive clause (37). This can be used with causative meanings, like in *vwa, ma ...* ‘do, so that...’ (see §11.3), or alone.

- (37) *a=nya s-ung m=e nya si-m*
 3SG=give BEN-1SG.POSS SUBR=1SG give BEN-2SG.POSS
 ‘He gave it to me so that I would give it to you.’

14.2.5 Conditional *ma, cama* ‘if’

When preceding a matrix clause, *ma* and its derived form *cama* introduce a hypothetical situation (38, 40). As can be seen in (41), *ma* and *cama* can be used interchangeably in some contexts. As far as a difference could be made out between *ma* and *cama*, *cama* seems to precede more markedly irrealis situations (42), whereas *ma* is also used to refer to traditions (39). This *ma* is probably the base form from which the insubordinator *ma* was derived (see §14.3).

- (38) *gase=cahu ma bwa vwa wadan ma le=tho*
 1PL.INCL=answer while IPFV EXIST time when 3PL=call
nyakoo-je ka li=xhaohmu
 for-1PL.INCL.POSS SBJ DEF.PL=elder
 ‘We answer while there is still time, when(ever) the elders call on us.’
 [GS:1-2]
- (39) *m=abe bwa vwa nettoyage h=abe thai*
 SUBR=1PL.EXCL IPFV do cleaning TOP.REP=1PL.EXCL pick.up
li=vaisselle-ea
 DEF.PL=dish-3SG.POSS
 ‘When we do the clean up [at a wedding] we pick up [the bride’s] dishes.’
 [AG1:428]
- (40) *Ma tha vwa eca=loto-n-gaa ma gase=ta can Wanaa*
 COND ASS exist INDF=car-POSS-1PL SUBR 1PL.INCL=go.up in W.
 ‘If we had a car we would go up to Wanaa.’ [D3:90]

- (41) *cama ha-mwa-me ka i=khî ma*
 when go-REP-DIR.CP SBJ DEF.SG=swamp.hen when
hma-ca-mwa-me paa cika mwa wâng
 arrive-go.up-REP-DIR.CP PRF NEG.EXIST REP boat
 ‘When the swamp hen went back and arrived, there was no boat anymore
 [because the rat had eaten it].’ [HC2:5]
- (42) *ju hole ko calibeen gase=vwa cama vwa cama cika*
 really thank because sometimes 1PL.INCL=do SUBR EXIST SUBR NEG.EXIST
 ‘Thank you very much, for it is our habit that we do [custom] whether
 we have [ceremonial goods] or not.’ [JU:7]

14.2.6 Realis ‘while’

Cala is syntactically identical to *cama* and *ma* (43). Semantically, *cala* is used only to introduce past situations firmly rooted in reality, and *cama* for everything else.

- (43) *ju vaa m=e juu saxhuti i=thuatit-abe cala*
 real too SUBR=1SG real narrate DEF.SG=day-1PL.EXCL.POSS when
abe=hut ko-n yeen nyeet
 1PL.EXCL=go.down on-NSPEC island when
 ‘It’s too much for me to properly tell the story of how when we went
 down the island the other day.’ [GP2:1]

14.2.7 *ko* ‘because, thanks to’

Subordinate clauses can also be linked to a matrix clause of which they are the cause. The subordinators used for this are *ko* ‘because’ described in §14.1.5, as well as *vuki-n* ‘cause, stem’. The latter word acts both as a stative verb, when the reason is a participant themselves (44), or as a subordinating particle, when the reason is an entire clause (45).

- (44) *kavi tha hmwaka-je, wanke mwa i=hun-moo ka i=bwanpu,*
 CNJ ASS like-1PL.INCL change DEICT DEF.SG=NMLZ-stay ABS DEF.SG=land
hai vukin-gaa ko ko gase=juu vaaya xhayu a...
 CNJ reason-1PL.INCL because because 1PL.INCL=real work random or
 ‘But it’s like us, changed the nature of the land or, we’re the reason,
 because we just work at random [without custom], or...’ [RP:9]

14 Complex clauses

- (45) *e=caihna-n vuki-n go=vi nyako-ong*
1SG=know-ANA cause-NSPEC 2SG=say OBL-1SG.POSS
'I know because you told me.' [X9:3]

14.3 Insubordination

In order to mark a clause as adhortative (46, 47), as a wish (48), a regret (49), or to diminish the speaker's assertiveness, the complementizer *ma* can be put at the very beginning of a clause without a preceding matrix clause.

- (46) *ma gase=e-saam ko li=vaaya-n-gaa*
SUBR 1INCL=RECP-help OBL DEF.PL=work-POSS-1INCL.POSS
'May we help each other in our works.' [GB:5]
- (47) *ma gavwe=xaleke, ka caihna-n*
SUBR 2PL=see CNJ know-ANA
'May you look [at this custom] and know (acknowledge) it.'
- (48) *ma tha xa-vwa-wiin m=e sam koo-m, ma*
COND ASS NMLZ-EXIST-strength SUBR=1SG help OBL-2SG SUBR
gasu=vacuti i=juu.mwa-go
1DU.INCL=erect DEF.SG=hut-2SG.POSS
'If only I were strong (enough) to I would help you, (so that) we build your house.' [D3:91]
- (49) *putain, yo, m=e th=e=koon ja vwa i=signe*
fuck 1SG SUBR=1SG ASS=1SG=PROG PRF do DEF.SG=sign
'Dammit, I should have given [him] a sign by then.' [KG:492]

Insubordination is important in deontic contexts, as it frames the predicate as something wished for by the speaker, or as their duty (see §14.2.1.1). There are no verbs meaning 'must', 'may', 'should' etc.

15 Conclusion

This concludes our description of Vamale. The grammar wanted to give an overview over every major aspect of the language, pass on some of the author's love for the speaker culture, contextualize the language in space and time, and thus had many fires to tend. Hopefully, the book contributes information about the interplay of fortis onsets and nasalization of vowels in Northern languages. Alignment patterns in clausal and nominalized contexts are particularly interesting in Vamale. The middle prefix *e-* with its various uses is another delight the language has to offer. The crucial role of language contact in Vamale's language history, with influence on all aspects of its system, is a typical feature of Oceanic languages, if not indeed all tongues spoken in high density areas. That Vamale has kept a uniqueness to it despite powerful neighbours an hour's walk away, is probably due to a cultural trait of Melanesian civilizations. To what extent the system really is unique will depend on the work that will be done on its neighbours.

However, many aspects of the language deserve closer scrutiny. For example, stress was not completely understood and prosody remains a black box, and some coordinators remain only hazily described. The middle prefix *e-* was a research focus only late into the project, and aspects of it were certainly missed. Furthermore, women did not act as consultants as much as they should have, which deprived the research of valuable data. Though there is no genderlect *per se*, the author is likely to have missed important information, given that women form the majority of speakers nowadays, especially among young speakers. Ethnopoetics and other aspects of oral literature are highly endangered and a very important source of archaic constructions, rare words, and stylistic figures which may inform us further about the language's place in its area. The work ahead is promising, and must be done. In the words of Baptiste Ucian:

- (1) *cama vi hapi* [...] *a=sibu ta-me ka i=jati nyaxahut*
if say COMP [...] 3SG=swell go.up-DIR.CP SBJ DEF.SG=sea down.there
hai cama hup-e ca=hmape-thoatit a xada cama thên-fe
or if go.down-DIR.CP INDF.PL=flesh-sky REL up.there if run-take

15 Conclusion

ni=kapwa-ca naen a cahni ...

DEF.PL=steel.sheet-PROX now or here

‘If, say, the sea down there should swell and come up (upon us), or if some clouds up there should come down, or (a wind) strip away the ribbed roofing, (we need to do the work)...’ [CP2:7]

Indeed, the language is a fascinating link between Hienghène languages, the western coast, and Cèmuhî, and it is the author’s hope that more will be known about their contact history in years to come. As Vamale, Haeke, Pije, and other languages of the area are highly endangered, it is not only a time-sensitive question to describe and document them at all, but there is also the factor of attrition. Languages that undergo drastic changes in transmission are at risk of losing vocabulary, the transparency of certain constructions, and other facets that make them unique and rich windows unto the world. Old ladies mourn the times when men would woo them with poems likening them to mountain flowers, missionaries had the chief’s sister burn her father Nea Gale’s notebook where he’d written down his magic and history, and few youths know how to make a good ceremonial speech. This researcher was given only three traditional songs, but Haudricourt recorded a love song as well as a clanic song, and I was told of war songs, pilou songs, work songs, all of which have been left unsung for so long that no one dared try sing them again. There was but one traditional story (“The Squid”), but Mr. Kalène remembers that there were stories about the Raven and the Wood Pigeon (the former is thrifty and the latter follows it around hoping for food), the Fruitbat and the Goliath Pigeon (struggling for dominance of the forest, Fruitbat claims superiority because it is eaten whole while the other is plucked, but the other retorts that Fruitbat must be singed to be eaten, whereas itself is spared such treatment), there are stories of Eel and Lizard, of fireballs in which sorcerers travel (*doki*), ghost villages in the Pamale valley, war ships forever lost at sea, ... The forest is burned and the soil washed out by the rain into the sea, leaving bare rocks. Nevertheless, the author encourages other researchers to pick up the digging stick and the adze, as some seeds may have clung on, and the garden may yet grow back!

ka na ja koin. xadaago ma go saxhuti eca se!

‘And this is the end. It’s your turn to tell another one!’



Figure 15.1: Mr. Pei and Mr. Kalène looking across the Gaheny creek unto Wanaa. Thehwaade is in the distance, and Seejanit in the blue mists beyond that.

Appendix A: The Rat, the Swamp Hen, and the Squid (Philippe Gohoupe)

This story is known all over New Caledonia, and originally from Tiga in the Loyalty Islands. The underlying information of this story, that squids hate rats, and that rats make excellent bait to catch squids, is known beyond the New Caledonian archipelago.

- (1) *Koin hut pwa-n maa a=hma-sut xahut ka cahma*
 end go.down on-NSPEC reef 3SG=arrive-go.down below CNJ TOP
i=khîi a=han moo ko-n maa
 DEF.SG=swamp.hen 3SG=go stay on-NSPEC reef
 ‘When the receding tide was low, the Swamp Hen went to stay on the reef [to fish]’
- (2) *ka cahma i=siibwi koon moo ca i=wang*
 CNJ TOP DEF.SG=rat PROG stay in DEF.SG=boat
 ‘and the Rat stayed in the boat.’
- (3) *Ca i=wanga-lu a= lu=vwa wanga-lu*
 in DEF.SG=boat-3DU.POSS REL= 3DU=do boat-3DU.POSS
 ‘In their boat that they made for themselves...’
- (4) *Ko i=ujep ma a=moo ka=i=siibwi*
 OBL DEF.SG=sugar.cane SUBR 3SG=stay SBJ=DEF.SG=rat
a xhuti
 3SG=scrunch.(sugarcane)
 ‘...from sugar cane. When the Rat stayed like this, it ate it.’
- (5) *Cama han-mwa-me ka=khîi, ma=a=hma-ca-mwa-me*
 when go-REP-DIR.CP SBJ=swamp.hen when=3SG=arrive-go.up-REP-DIR.CP
paa cika mwa wang
 PRF NEG.EXIST REP boat
 ‘When Swamp Hen came back, when she came back, the boat was already gone.’

A *The Rat, the Swamp Hen, and the Squid (Philippe Gohoupe)*

- (6) *I=wang sin ujep wang lu ma siibwi paa*
 DEF.SG=boat arm sugar.cane boat 3DU SUBR rat PFV
xhuti meekan a siibwi
 scrunch.(sugarcane) all SBJ rat
 ‘The boat [of] sugar cane branches, their boat, but Rat had already eaten everything.’
- (7) *A=mwa fwajimwake ka vi hapi*
 3SG=DEICT ask and say COMP
 ‘She asked him and he said that...’
- (8) *A=moo a=hmana-n a=paa xhuti*
 3SG=stay 3SG=hungry-3SG 3SG=PRF scrunch.(sugarcane)
 ‘...he stayed, he was hungry, and he ate...’
- (9) *xhuti i=wang*
 scrunch.(sugarcane) DEF.SG=boat
 ‘...ate the boat.’
- (10) *Go a=vi nyakoo-n a=khû*
 DISC 3SG=say for-3SG.POSS SBJ=swamp.hen
 ‘Then Swamp Hen told him:’
- (11) *Bwa e-vaang go go cika eca=hun-ta-mwa*
 IPFV MID-unknown 2SG 2SG NEG.EXIST INDF.SG=NMLZ-move.up-REP
ko yo vwa li=vwun s-ung
 because 1SG do DEF.PL=hair arm-1SG.POSS
 ‘‘Well I don’t know about you, you don’t have any means to go back up, whereas I have my wings.’’
- (12) *Go tha a=ja ta-mwa-me*
 then ASS 3SG=PRF move.up-REP-DIR.CP
 ‘And she went back up to the land.’
- (13) *Ya tha ja thêên thêên ta-mwa-me*
 3SG ASS PRF run run move.up-REP-DIR.CP
 ‘She, she flew up fast to go home.’
- (14) *Cama i=siibwi a=balan tabo koon se*
 if DEF.SG=rat 3SG=finally sit PROG cry
 ‘But the Rat, he just sat there crying.’

- (15) *Ko i=vai a= fovwat koon tabo xahut pwan bwan-maa*
 on DEF.SG=stone REL= white PROG sit below on top-reef
 ‘on the white [coral] rock, he was sitting down there on the reef.’
- (16) *Koin a=kon a=bwa tena-a ka i=ibwen*
 stop 3SG=PROG 3SG=IPFV hear-3SG.OBJ SBJ DEF.SG=squid
 ‘Then he was - the Squid heard him.’
- (17) *Go a=hame a=hma-ca-me koo-n a=mwa*
 2SG 3SG=come 3SG=arrive-go.up-DIR.CP because-PSM 3SG=DEICT
fwajimwa “go=kon se ko hmwaeke?”
 ask 2SG=PROG cry because how
 ‘Then he came he came there to him, he was like “why do you cry?”’
- (18) *Ka a=vi hapi a=se-a moo a=hman-ong*
 and 3SG=say COMP 3SG=one-3SG stay 3SG=hungry-1SG.POSS
 ‘And he said that he was alone and “I was hungry”.’
- (19) *A=xhuti i=wanga-ju*
 3SG=scrunch.(sugarcane) DEF.SG=boat.POSS-3DU.POSS
 ‘He ate our boat.’
- (20) *Paa ja paa cika mwa ca=wang-abu m=abu*
 PFV PRF PFV NEG.EXIST REP INDF.SG=boat-1DU.EXCL SUBR=1DU.EXCL
ta-mwa ka=bu
 move.up-REP SBJ=1DU.EXCL
 ‘And now there is no more, no more boat of ours with which we could go back up.’
- (21) *Go ya a=vi hapi go tha vaang go yo thêên tamwa*
 DISC 3SG 3SG=say COMP 2SG ASS inconnu 2SG 1SG run go.back.up
ko vwa li=vwun s-ung
 because EXIST DEF.PL=hair arm-1SG.POSS
 ‘And she said “I don’t know about you, I’m leaving because I have wings.”’
- (22) *Ko cahma siibwi koon tabo koon se se se a=tena ka ibwen*
 CNJ TOP rat PROG sit PROG cry cry cry 3SG=hear SBJ squid
a=ha-me
 3SG=go-DIR.CP
 ‘And Rat, he sits, he cries, cries, cries, Squid hears and comes.’

A *The Rat, the Swamp Hen, and the Squid* (Philippe Gohoupe)

- (23) *A=fwajimwake ha go siibwi go=se se ko hmwaeke*
 3SG=ask EXPL 2SG rat 2SG=cry cry OBL how
 ‘He asks “Hey you, Rat, why do you cry, cry?”’
- (24) *E=se ko e=xhuti*
 1SG=cry because 1SG=scrunch.(sugarcane)
i=wang-abe *abe=hup-e*
 DEF.SG=boat-1PL.EXCL.POSS1PL.EXCL=go.down-DIR.CP SUBR
ma khii kon ya tha paa ta-mwa
 swamp.hen CNJ 3SG ASS PRF go.up-REP
 ‘‘I cry because I ate our boat, we came down with Swamp Hen, and she already went back up.’’
- (25) *Go ka go=ha-me ko e=bo fe-ta-mwa-ko*
 2SG SBJ 2SG=go-DIR.CP because 1SG=IRR take-move.up REP-2SG
 ‘‘You, come, because I will take you back up.’’
- (26) *Hê a=ja han tabo pwa-n bwa-n kona a=ja*
 yes 3SG=PRF go sit on-NSPEC head-3SG.POSS CNJ 3SG=PRF
fe-ta-mwa-me-a
 take-move.up-REP-DIR.CP-3SG.OBJ
 ‘Yes, he goes to sit on his head and he takes him back up.’
- (27) *Lu=hma-ca-mwa-me ca-n hmeewan*
 3DU=arrive-go.up-REP-DIR.CP on-NSPEC sand
 ‘The two arrive up at the beach.’
- (28) *Ma xhasaat nya-da-mwa siibwi phêêû*
 SUBR jump towards-up-DEICT rat dry.land
 ‘so that Rat [can] jump up back onto dry land.’
- (29) *Go cahma i=ibwen a=ja hut a=koon ja*
 2SG TOP DEF.SG=squid 3SG=PRF move.down 3SG=PROG PRF
hup-wa-le ca-n we
 go.down-REP-DIR.CF in-NSPEC water
 ‘And the Squid, he goes back down, he is going back away into the water.’

- (30) *A=cuut mwa ka siibwi mwa a=e-mwadi-a*
 3SG=stand DEICT SBJ rat DEICT 3SG=REFL-laugh-3SG.OBJ
a=e-mwadi-a a=mwadi-ke i=ape-xhwata ca-n
 3SG=REFL-laugh-3SG.OBJ 3SG=-laugh-TR DEF.SG=LOC.NMLZ-bald in-NSPEC
bwa-n
 head-3SG.POSS
 ‘Rat stands now and laughs to himself, laughs about the bald spot on his head.’
- (31) *I=bwa-n ibwen a= xhwata*
 DEF.SG=head-NSPEC squid REL= bald
 ‘The bald squid head.’
- (32) *A=e-mwadi-a kona a-tena-a ka i=ibwen*
 3SG=REFL-laugh-3SG.OBJ then hear SBJ DEF.SG=squid
 ‘He laughed to himself, then he was heard by the Squid.’
- (33) *Ha go go=mwadi-ke i=da*
 EXPL 2SG 2SG=laugh-TR DEF.SG=what
 ‘“Hey you! What are you laughing about?”’
- (34) *E=mwadi-ke xhwata ka-m*
 1SG=laugh-TR bald CLF.POSS-2SG.POSS
 ‘“I laugh of your baldness.”’
- (35) *Go go=thuang-o ta-me na yo*
 2SG 2SG=joke-1SG.OBJ move.up-DIR.CP DEM 1SG
e=fe-ta-me-ko can,
 1SG=take-move.up-DIR.CP-2SG.OBJ in
 ‘“You, you laugh of me walking up [to dry land], it is me who brought you up here!”’
- (36) *A=thake nya-da-me i=thaangan koo-n*
 3SG=throw send-go.up-DIR.CP DEF.SG=tentacle on-3SG
a=thake-a
 3SG=throw-3SG.OBJ
 ‘Then he threw his tentacle and then hit him.’

A *The Rat, the Swamp Hen, and the Squid* (Philippe Gohoupe)

- (37) *Thake-a thake-a hut ca-n we go*
 throw-3SG.OBJ throw-3SG.OBJ move.down in water then
a=yabilo-a
 3SG=kill-3SG.OBJ
 ‘Threw him, threw him down into the water, then he killed him.’
- (38) *Go=e-thuang-o e=nya-ut-ko ca-n we ma*
 2SG=REFL-joke-1SG.OBJ 1SG=put-go.down-2SG.OBL in-NSPEC water SUBR
bup hnyanaa-m
 thunder.strike breath-2SG.POSS
 ‘‘You laugh about me, I’ll drag you down into the water to burst your
 breath.’’
- (39) *Go a=ja vwa ma me ka=i=siibwi*
 then 3SG=PRF do SUBR die SBJ=DEF.SG=rat
 ‘And he made the Rat die.’
- (40) *Cahma ibwen tha ja hup-wa*
 TOP squid ASS PRF go.down-REP
 ‘And the Squid, it went back down.’
- (41) *Tha ja koin mwa siibwi tha pa me-a tha=a=pa ja*
 ASS PRF stop REP rat ASS already die-3SG.OBJ ASS=3SG=PFV PRF
sea-da
 look-go.up
 ‘This is the end now, Rat is dead, he looks upwards now.’

Appendix B: The 1917 Tipije War (Philippe Gohoupe)

This is a version of what happened in the Tipije valley as Mr. Gohoupe's parents experienced it. The storytelling lapses back and forth at certain moments, and most of the participants are not formally introduced. This is due, apart from Mr. Gohoupe's age, to the audience: they all grew up in the area and know the story. Briefly summarized, first Kafeyat Cidopwaan, chief of Ouen Kout/Wan Kuut, was blamed for the attacks on settler households (see Chapter 4), and when the European soldiers stationed in Dewanwe conducted punitive expeditions, he was shot in the back near Tendo; he died in a creek there. All men were assembled and either killed in the process or sent to Nouméa to be questioned. The women were sent to Houailou. At the same time, the colonial authorities looked for the chiefs responsible for the war, and as the mother of chief Kafeyat could show a black shell money, used to broker war alliances, and as she said that the chief of Hienghène, Bwaarat, had sent it to call his allies to war, the blame shifted onto Bwaarat. He hanged himself when he heard that a ship had come to take him to the guillotine. The men and women were then released from prison.

B.1 Introduction

Asked by Nigai Kalène:

- (1) *A=kon vi hapi na gasu=enregistrer koin gase=bo=pala*
3SG=PROG say that DEM 1DU.INCL=record finish 1PL.INCL=IRR=say
'He is saying that we two will [press] record, then we all will talk.'
- (2) *Hêê da... cama nyima-m ma go=enregistrer ce-ma go=bo pala*
yes what if/IRR will-2SG.POSS SUBR 2SG=record if/IRR 2SG=IRR speak
ma bo fainake koin cama nyima-m ma go=xaahni ma
SUBR IRR show finish if will-2SG.POSS SUBR 2SG=keep with
i=e-vwa-kan nyakoo-m.
DEF.SG=NMLZ.INS-do-NMLZ for-2SG.POSS
'Yes, uh, if you want to record, when you will talk to explain, then you can keep it as a tool for yourself.'

B The 1917 Tipije War (Philippe Gohoupe)

- (3) *ma xaani nyakoo... ya a=vi canbwen*
SUBR keep for 3SG 3SG=say yesterday
'And keep for... he said it yesterday.'
- (4) *Evwakan nyako li=mwa-n-somun gase=bo=bwaa=pala*
tool for DEF.PL=house-LINK-lesson 1PL.INCL=IRR=IPFV=speak
koon cama goon ca aman... thapoke fwajimwake
OBL-3SG if enough in? something begin ask
'Preserve it for the schools, we'll talk about it. If we may, something...
start asking.'
- (5) *E-nyima-n ma caihna-n i=hun-moo-kan*
REFL-will-3SG.POSS SUBR know-NSPEC DEF.SG=NMLZ-stay-NMLZ
cala le=fe ka=li=popwaale ce veandan vwa vaa. hê
when.REAL 3PL=fetch SBJ=DEF.PL=European in time EXIST war yes
ko i=va.
about DEF.SG=war
'He wants to know about the time when they were taken by the
Europeans, in the time when there was a war. Yes, about the war.'

B.2 Story

- (6) *Kona li=pupwaale tha le=pa fe cahni ko-nya seen hnya*
well DEF.PL=European ASS 3PL=PRF take here on-toward border toward
hnut-te
downstream-DIR.CF
'The Europeans had taken it, here until the border towards down there.'
- (7) *Le=hmasa-me ka li=pupwaale kon cahni li=apuli*
3PL=arrive-DIR.CP SBJ DEF.PL-Europeans CNJ? here DEF.PL=person
li=xhaohmu moo seen xahnut ca-n la la
DEF.PL=elder stay border downstream in-ANA here here
li=xhwaapwê
DEF.PL=colonnary.pine
'The Europeans came, and here the people, the ancestors stayed, till the
border down there here where the araucaria pines are.'

- (8) *Kone le=hma wati-le nya cahni hma xaa-le*
 when 3PL=arrive chase-3PL from here until¹hit-3PL 3PL=begin
le=thapoke cahni na tha i=seen nya-an-de
 here DEM ASS DEF.SG=border further-go-DIR.CF
 ‘When they arrived here while chasing them, they began here and this is the limit [of their movement] over there (visible).’
- (9) *Li=apuli li=xhaohmu kona... li=pupwaale kona... tha*
 DEF.PL=person DEF.PL=elder and? DEF.PL=European and? ASS
i=seen hnya hnut-te
 DEF.SG=border towards downstream-DIR.CF
 ‘The people, the ancestors, well... the Europeans, well... this is the border down there.’
- (10) *Koin le=hma wati-le ma xaa-le hnuuda-me cahni*
 then 3PL=arrive chase-3OBJ SUBR beat-3OBJ upstream-DIR.CP here
 ‘Then they came chasing them to strike them, coming up here.’
- (11) *Koin le=bwa hân hân cop xada koin le=hup-wa*
 while 3PL=IPFV go go go.over up.there finish 3PL=go.down-REP
xahan xahut le seejanit
 over.there down.there 3PL T.
 ‘Then they [the Kanak] went from there and walked, walked, crossed [the mountain] up there and then went back down over there, they were in Tiendanite.’
- (12) *Bwa xada thathee mwa maahma ca i=dingan xahan*
 IPFV up.there kill REP elder.brother in DEF.SG=creek over.there
thêêdo
 T.
 ‘Up there was killed the chief [Kafeyat Cidopwaan of Wan Kuut], in the creek over there in Tendo.’
- (13) *Go le=fwade-a nya-mwa-la ko ya mwa si-n*
 then 3PL=seek.ANIM towards-REP-PROX because 3SG DEICT BEN-3SGPOSS
i=mwa-n hmat ko i=vaa
 DEF.SG=container-POSS customary.money for SG.DEF=war
a=hnyada-me ka=thêama
 3SG=send-DIR.CP SBJ=chief
 ‘Well, they looked for him around that time, because it was him now, to him that the great chief [Bwarhat of Hienghène] had sent the war money.’

¹lit. ‘until’

B The 1917 Tipije War (Philippe Gohoupe)

- (14) *I=se mwa-n solda a=moo xahnut pwanvai*
 DEF.SG=other house-POSS soldier 3SG=stay downstream.there P.
ka i=se a=moo xahut dewanwe
 CNTR DEF.SG=other 3SG=stay down.there T.
 ‘One barracks was in Pwanvai and one in Dewanwe [the coast of Tiouandé].’
- (15) *Cipa gase=va caihnan mwa nya la hun-moo ka*
 NEG 1PL.INCL=strongly know REP put here NMLZ-stay LINK
i=vaa
 DEF.SG=war
 ‘We don’t know too well anymore what put the war here.’
- (16) *Ko na a=nyadaa-me ka bwaaxat tha*
 but DEM 3SG=send-DIR.CP SBJ B. ASS
i=hmat-aen
 DEF.SG=customary.money-DEM
 ‘But that which Bwaaxat sent, was that [war] shell money.’
- (17) *Go le=ja thathe-a mwa go le=nya siwa-mwa*
 DISC 3PL=PRF kill-3PL REP then 3PL=send return-REP
 ‘And they had already slayed him then, and [the women and tribespeople] went back (home).’
- (18) *Cama hma-ca-me ka i=mwa-n hmat*
 when arrive-go.up-DIR.CP SBJ DEF.SG=container-POSS customary.money
ka lu=tua lu ma ya lu ma
 CNTR 3DU=take.out 3DU COM 3SG 3DU COM
 ‘When the shell money arrived, the two [mothers took] it out.’
- (19) *A=vi maman Henri ma mama-le mwa lu=tua a=fe*
 3SG=say mother H. COM mother-3PLPOSS REP 3DU=take.out 3SG=take
i=dipi ka i=see koin a=fe i=sanan ka
 DEF.SG=cover SBJ DEF.SG=other while 3SG=take DEF.SG=content SBJ
i=see
 DEF.SG=other
 ‘That means Henri’s mother and the mother of the others, the two took [the shell money] out and one took the wrap, then the other took the content.’

- (20) *Ma le=han ma ja han thathe-a mwa kon le=ja siwa-mwa*
 SUBR 3PL=go SUBR PRF go kill-3SG REP then 3PL=PRF return-REP
 ‘When [the mothers] fled, when he had died, then [the survivors] returned.’
- (21) *Ma le=ja hmaca-mwa Noumea le=ja fee-le mwa jevwan*
 IRR 3PL=PRF arrive-REP N. 3PL=PRF take-3PL DEICT l’ensemble
mwa acan ka li=xhaomu mwa le=moo cahni
 REP among SBJ DEF.PL=elder REP 3PL=stay here
 ‘When they arrived in Noumea, they took them then, the whole lot, among them the ancestors as well who lived here.’
- (22) *Acan ka i=hao-nea tha u vwa mwa*
 among SBJ DEF.SG=grandfather-3SG.POSS ASS ? EXIST also
li=been
 DEF.PL=brothers
 ‘Among them was the [chief’s] grandfather, there were also the others.’
- (23) *Na cahni tha xhwan see-a a thathe-a cahni.*
 DEM here ASS a.bit one-3SG REL kill-3SG here
 ‘Here, there was only one who was slain.’
- (24) *I=a thathe-a na i=bee i=papa-n ena*
 DEF.SG=REL kill-3SG DEM DEF.SG=brother DEF.SG=father-POSS DIST
xahnuut pwanbaut mwa
 downstream P. REP
 ‘He who was killed was the brother of the father of those downstream in Pwanbaut there.’
- (25) *Kavi i=bee-n i=papa-n-le yata-n*
 but DEF.SG=brother-POSS DEF.SG=father-3PLPOSS name-3PLPOSS
bwaungan
 B.
 ‘By the way, their father’s brother’s name was Bwaungan.’
- (26) *Thathe-a nya xahan waneut ma le=siwa-mwa*
 kill-3SG PROX over.there O.-K. IRR? 3PL=return-REP
 ‘He died all the way over there in Ouen Kout when they came back.’

B The 1917 Tipije War (Philippe Gohoupe)

- (27) *Ka le=ja fwadai-mwa ka li=pupwaale a=ja ha thaloot*
 CNTR 3PL=PRF find.INAN-REP SBJ DEF.PL=European 3SG=PRF ? come.out
ka bwaaxat a=e-vwa-koo-n ka bwaaxat li=apuli-nea
 SBJ B. 3SG=REFL-do-OBL-3SG SBJ B. DEF.PL=man-3SG.POSS
 ‘The Europeans were looking for [the reason] and Bwaarat emerged. It turned out it was Bwaarat and his men.’

B.3 Death of Bwaxat

- (28) *Fe-ta ma le=hup-e thai-le ma le=ta*
 take-go.up SUBR 3PL=go.down-DIR.CP? attach-3PL SUBR 3PL=go.up
mwa-n suki aman
 house-POSS pay something
 ‘Brought up to come down and gather them so that they would go up to prison’

- (29) *Hê fwandai ca=wuukin, hapi na wukin Bwaxat.*
 yes seek.INAN some=reason COMP DEM reason B.
 ‘Yes, looked for some reason [for the war], that it was Bwaarat’s fault.’

- (30) *Xhu-pwa-mee i=wang le=bwa vii hapi na “ya ya thapoke*
 go.down-REP-DIR.CP DEF.SG=boat 3PL=IPFV say that DEM 3SG 3SG begin
i=vaa”
 DEF.SG=war
 ‘The boat came down. They said that “he, he started the war”’

- (31) *A=ja hu-pwa-mee umwang, hu-pwa-me fe-a, ce*
 3SG=PRF go.down-REP-DIR.CP boat go.down-REP-DIR.CP take-3SG in
i=wadan thangavi nyôô-n apuli
 DEF.SG=time chop neck-POSS person
 ‘The boat came down, came down north to take him, in the time when they would cut people’s necks.’

- (32) *Ce i=wadan a=hma-cuut ka i=umwang, ka*
 in DEF.SG=time 3SG=arrive-stand SBJ DEF.SG=ship CNTR
le=fe-ta, koma le=fe-a, ka i=wang
 3PL=take-go.up-3SG in.order.to 3PL=take-3SG CNTR DEF.PL=boat

B.4 Black Money and the Return of the People

a=ha-me hma-cuut, ya, a=ta wainyô nyece
 3SG=go-DIR.CP arrive-stand 3SG 3SG=go.up tie.neck in(building)
i=juu-mwa
 DEF.SG=real-house

‘At this moment when the boat arrived, and they brought it north to catch him, and the boat had arrived at the shore, him, he had hanged himself in the house.’

- (33) *Ma le=ta, ma le=xale-a, ko-ma le=fe-a, ma*
 COM 3PL=go.up SUBR 3PL=see-3SG because-SUBR 3PL=take-3SG COM
le=ta ma le=fe-a, ya, a=pa ja me-a ma
 3PL=go.up SUBR 3PL=take-3SG 3SG 3SG=PRF PRF die-3SG when
le=hmasa-mwa xada ma le=ja fwandai ta-mwa
 3PL=arrive-REP up.there when 3PL=PRF seek.INAN go.up-REP
 ‘When they went up, to see him, to take him, when they went up to take him, him, he was already dead when they arrived up there, when they searched coming back up north.’

B.4 Black Money and the Return of the People

- (34) *Go a=ja ta mwa ka i=thamo i=mama-n*
 then 3SG=PRF go.up DEICT SBJ DEF.SG=woman DEF.SG=mother-POSS
maama ma
 chief²SUBR
 ‘Then she went south, the woman, the mother of the chief [Kafeyat], to...’
- (35) *A=fainake i=mwa-n hmat a=nya ka ena*
 3SG=show DEF.SG=container-POSS customary.money 3SG=give SBJ DIST
na ehni xaaci civije
 DEM PROX strike T.
 ‘...show the sheath of shell money that he had sent, him who struck Tipije.’
- (36) *Le=ja vatipwe-mwa, kon ya tha pa ja me-a. go, tha le=ja*
 3PL=PRF drop-REP because 3SG ASS PFV PRF die-3SG then ASS 3PL=PRF

²lit. ‘elder brother’

B The 1917 Tipije War (Philippe Gohoupe)

thuat-mwa moo, ka li=xhaomu, ja, tha le=ja ha-mwa-me
 emerge-REP stay SBJ DEF.PL=elder PRF ASS 3PL=PRF go-REP-DIR.CP
 ‘They were released, because he was already dead. Well, they came back
 out [of prison], the ancestors, yeah, they came back.’

- (37) *Go, cahma li=xayu, le=thai-le hnya-da-le*
 and concerning DEF.PL=male 3PL=pick.up-3PL send-move.south-3PL
wailu
 H.

‘And, the men, they gathered them and sent them south to Houailou.
 [this is probably a mistake of the speaker]’

- (38) *Can goakan-aen, le=hma-cup-wa-me ka li=xayu,*
 in moment-DEM 3PL=arrive-down.there-REP-DIR.CP SBJ DEF.PL=woman
ma le=hup-wa-me, ka li=thamo, le=moo wailu
 COM 3PL=go.down-REP-DIR.CP SBJ DEF.PL=woman 3PL=stay H.

‘At this moment, the men came back, when they came back, and the
 women, they stayed in Houailou.’

- (39) *A=vi ka Leenhardt hapi i=apuli a=vwa ka i=thamo,*
 3SG=say SBJ L. that DEF.SG=man 3SG₁=do SBJ DEF.SG=woman₁
go, ya a=fa-thuati i=apuli
 then 3SG 3SG=CAUS-come.out.TR DEF.SG=man

‘Leenhardt said that the man is there thanks to the woman, well, he had
 the man [=the women?] freed.’

- (40) *Nyasi Leenhardt, e=bwa ju tena i=yata-n, cip=e*
 TOP L. 1SG=IPFV truly hear DEF.SG=name-3SG.POSS NEG=1SG
xa-xale-a
 HAB-see-3SG

‘Concerning Leenhardt, I did hear his name, but I never saw him.’

Appendix C: The Story of the Dance Beat (Yvonne Sahilé)

This is a legend written by Yvonne Sahilé, a writer and culture activist living in Tiouandé. She drew on traditional motifs, e.g. the Cannibal of Tipije, the knowledge transmitted by bloodlines (the dance is recognized by the father), and everyday details. Mrs. Sahilé wrote this story in French, and it was translated into Vamale by André Kalen, Jacob Oué and Christophe Pei. Her names for the protagonists are in Pije, and were kept that way in the translations.

- (1) *Habu Can-Vije vwa i=apemoo a=pwa-n jela i=jahoot*
 long.ago Tipije EXIST DEF.SG=tribe REL=on-NSPEC side DEF.SG=river
a=xhopwen.
 REL=big

‘Long ago in the Tipije valley, there was a tribe on the bank of this great river.’ (following the French original text)

- (2) *Ca i=apemoo-ca le=vacuti ca daahma a=bwa xawe ka*
 in DEF.SG=tribe-PROX 3PL=erect some chief REL=IPFV young and
yata-n Thêa Xa-vila.
 name-3SG.POSS T. NMLZ-dance

‘In this tribe they erected some chief who was still young, and his name was Firstborn the Dancer.’

- (3) *Ca i=apemoo vwa li=xawe thamo.*
 in DEF.SG=tribe EXIST DEF.PL=young woman

‘In the tribe were young women.’ (indefinite, non-specific in the French original)

- (4) *Tha fe nyamaa-n can dawee-le eca thamo a=en*
 ASS.3SG take eye-3SG.POSS in between-3PL.POSS some woman REL=first
maa-n.
 face-3SG.POSS

‘The most beautiful woman between them “took his eye”.’

C The Story of the Dance Beat (Yvonne Sahilé)

- (5) *Ka a=xhani ma mwada-n. Yata-n In*
 and 3SG=choose SUBR wife-3SG.POSS name-3SG.POSS skin
Fwe.
 guettarda.speciosa
 ‘And he chose her as his wife. Her name was Figtree Bark.’
- (6) (Note the *ia yatan* construction, ‘she who name-her’)
Le=kiica ka meeka li-been thamo, ma can
 3PL=jealous and all DEF.PL-peer woman COM in.NSPEC
e-dawee-le i=a=yata-n I-n Thu.
 REFL-between-3PL DEF.SG=REL= name-3SG.POSS skin banyan
 ‘All the other women were jealous, with among them all the one who was called Banyan Bark.’
- (7) *A=vwa hmwakan cama bee-n.*
 3SG=do like SUBR peer-3SG.POSS
 ‘She pretends to be her friend.’
- (8) *Ena a=mu saxhut cai-n ca li=ape-hân-ea,*
 DEM REL=FREQ follow behind-ANA in DEF.PL=LOC.NMLZ-go-3SG.POSS
koma nya i=ya-n ma udoo-n, na
 SUBR give DEF.SG=starchy.food-3SG.POSS COM cold.drink-3SG.POSS DEM
i=a=vi nya-thuan nyasi-n.
 DEF.SG=REL=say put-do.well for-3SG
 ‘The one who follows her everywhere, waits on her with food and water, her confidante as well.’
- (9) *Ca i=se thoatit In Fwe a=vi nyako In Thu hapi*
 in DEF.SG=other day skin figtree 3SG=say to skin banyan COMP
ya xhaapwe-jii-a, kona a=ja nya-bee i=kiica-a koo-n.
 3SG fruit-belly-3SG CNJ 3SG=PRF give-peer DEF.SG=jealous-3SG on-ANA
 ‘One day, Ciin Fwe announces to Ciin Thilic that she is pregnant, which adds to the latter’s jealousy.’
- (10) *Jahnga li=phwê pwecake-n a=mu sibu i=xhaapwe*
 all.along DEF.PL=month after-ANA 3SG=ITER DEF.SG=fruit swell
jia In Fwe, ka a=mu vwa wanyima In Thu.
 belly skin figtree CNJ 3SG=ITER do angry skin banyan
 ‘During the months after, Ciin Fwe’s belly grows, which makes Ciin Thilic angry.’

- (11) *Fine thoatit pwecake goon-xat In Thu xa-hân ma In Fwe*
 every day after enough-sun skin banyan NMLZ-go COM skin figtree
a=hut thuup can jaahoot, ka a=naami i=jia
 3SG=go.down bathe in river CNJ 3SG=message DEF.SG=belly
i=se.
 DEF.SG=other
 ‘Every day in the afternoon Ciin Thilic goes down with Ciin Fwe to bathe
 in the river, and massage her belly.’

C.1 The Flood

- (12) *Ehni a=ja hma-sa-me ko e-nim na-bwa fava ka-n*
 DEM 3SG=PRF arrive-go-DIR.CP on ORD-five and four CLF.POSS-NSPEC
phwêê-n.
 month-ANA
 ‘There arrived the ninth month.’
- (13) *Cama a=xaleke pwa-n bwan can un jaahoot a=xaleke*
 when 3SG=look on-NSPEC mountain in bottom valley 3SG=see
hmape-thoatit a=fiing a=kon nyasipoke nya-pwan yee-n
 flesh-sky REL=dark 3SG=PROG gather put-on tree-LINK
bwan.
 mountain
 ‘Looking at the mountains upriver, she saw dark clouds gathering on the
 summits.’
- (14) *a=vwa yathôa ma a=vi nyako In Fwe.*
 3SG=do be.hurried SUBR 3SG=say to skin figtree
 ‘She hurried to tell Ciin Fwe.’
- (15) *“In Fwe goon ma go=hut takee-ko ca-n jaahoot*
 skin figtree enough SUBR 2SG=go.down stretch-2SG.OBJ in-NSPEC river
ko xhwat-thuang ma go=tipwa xawe.”
 because almost SUBR 2SG=drop young
 ‘“Ciin Fwe you must go relax in the river, because you will soon give
 birth.”’

C The Story of the Dance Beat (Yvonne Sahilé)

- (16) *Cahma In Fwe cipa a=e-vwa-nyakoo-n, a=vwa ma*
 whereas skin figtree NEG 3SG=REFL-EXIST-for-3SG 3SG=do SUBR
yathôa hut cai-n ca-n jahoot.
 be.hurried go.down behind-ANA in-NSPEC river
 ‘But Ciin Fwe did not suspect anything (in the original version: did not know of jealousy) and hurriedly followed her down to the river.’
- (17) *Cama lu=hma-cut pwa-n jalan we a=vi nyako*
 when 3DU=arrive-go.down on-NSPEC side-LINK water 3SG=say to
In Fwe “Hut ca-n we.”
 skin figtree go.down in-NSPEC water
 ‘When the two arrived on the riverbank she told Ciin Fwe “Go into the water.”’
- (18) *In Fwe a=hut can we seen we ko li=bucila*
 skin figtree 3SG=go.down in water border water on DEF.PL=main.joint
xha-n.
 leg-3SG.POSS
 ‘Ciin Fwe goes into the water until her knees.’
- (19) *A=vi mwa “Xhose hut.”*
 3SG=say again again go.down
 ‘She tells her “Go in even further.”’
- (20) *In Fwe a=hut seen we ko i=goo-n.*
 skin figtree 3SG=go.down border water on DEF.SG=waist-3SG.POSS
 ‘Ciin Fwe goes into the water until her waist.’
- (21) *In Thu a=vi “xhwan vaa hup-wa, ko-ma naami*
 skin banyan 3SG=say bit much go.down-REP because-SUBR massage
i=jia-m ma i=duu-n we.”
 DEF.SG=belly-2SG.POSS COM DEF.SG=bone-LINK water
 ‘Ciin Thilic says “A bit more, because the current needs to massage your belly.”’
- (22) *In Fwe vaa hup-wa seen we ko-n bwaangan, vaa*
 skin figtree much go.down-REP border water on-NSPEC chest much
hân ca-n nya-n we.
 go in-NSPEC inside-LINK water
 ‘Ciin Fwe goes into the water until her chest, goes on into the middle of the water.’

- (23) *Cama ca i=wadan-aen, xada can un vwa*
 when in DEF.SG=time-DEM up.there in-NSPEC bottom EXIST
i=wîin uta ka a=vwa thêên java ca li=si-n dingan
 DEF.SG=strength rain CNJ 3SG=do flow flood in DEF.PL=arm-LINK creek
a=le=mu hut thaloot ca-n jahoot.
 REL=3PL=FREQ go.down appear in-NSPEC river
 ‘But during that time, up there in the background a heavy rain fell and overflowed the little creeks which flow into the river.’
- (24) *In Thu a=caihna-n hapi la ca la a=la ka*
 skin banyan 3SG=know-ANA COMP be.here in be.here 3SG=be.here SBJ
i=xhoogo, cama xahnang i=thoatit ma cala la
 DEF.SG=home when good DEF.SG=sky SUBR when be.here
li=yee-n bwan xahnuuda ca-n un
 DEF.PL=tree-LINK mountain downstream.there in-NSPEC bottom
le=coopwi ka li=hmape-thoatit, tha sinan hapi vwa java.
 3PL=bury SBJ DEF.PL=flesh-sky ASS sign COMP EXIST flood
 ‘Ciin Thilic knew that where the tribe was, if the weather is nice and the mountains in the back are covered with clouds, there will be a flood.’
- (25) *A=hmwaan bune can a=vi nyako In Fwe:*
 3SG=laugh steal SUBR 3SG=say to skin figtree
 ‘While laughing to herself she said to Ciin Fwe:’
- (26) *“Tha go=caihnan, cipa goon go=hu-pwa, ma ta seen*
 ASS 2SG=know NEG enough 2SG=go.down-REP SUBR go.up border
ko-n nyoo-m”
 on-LINK neck-2SG.POSS
 “You know, that’s not enough. Come in again, we have to get the water up to your neck.”
- (27) *In Fwe a=uhut seen we ko-n nyoo-n*
 skin figtree 3SG=enter.water border water on-NSPEC neck-3SG.POSS
cahma i=java a=ja gun hu-pe thaloot.
 whereas DEF.SG=flood 3SG=PRF loud.noise go.down-DIR.CP appear
 ‘Ciin Fwe was entering the water up to the neck, whereas the flood suddenly crashed down on them.’

C The Story of the Dance Beat (Yvonne Sahilé)

- (28) *In Fwe a=ja cie-a ca i=java.*
 skin figtree 3SG=PRF disappear-3SG in DEF.SG=flood
 ‘Ciin Fwe disappeared in the flood.’
- (29) *Xahnang nyima In Thu ma siiwa mwa ca xhoogo ma*
 good heart skin banyan SUBR return REP in home SUBR
a=ta vi nyako i=xatoo-n hapi i=see paa
 3SG=go.up say for DEF.SG=husband-3SG.POSS COMP DEF.SG=other PRF
cie-a.
 disappear-3SG
 ‘Ciin Thilic is delighted to return to the tribe to break the bad news to her husband.’
- (30) *Thêa Xa-vila a=faphâke nyako i=a= vi ka bwa*
 firstborn NMLZ-dance 3SG=believe for DEF.SG=REL= say CNJ IPFV
taaduaa jahnga-n li=wadan a=goon.
 mourn length-ANA DEF.PL=time REL=enough
 ‘Téin Kapila believed what she said and went into mourning for the necessary time.’
- (31) *Koin jahnga i=wadan-aen In Thu a=vwa meekan ma*
 while length DEF.SG=time-DEM skin banyan 3SG=do all SUBR
e-xahnang-ea nyasi Thêa Xa-vila, koma a=vaadan In Fwe.
 REFL-good-3SG for firstborn NMLZ-dance SUBR 3SG=forget skin figtree
 ‘During all this time Ciin Thilic was doing everything to please Téin Kapila and make him forget Ciin Fwe.’
- (32) *Ka a=ja moo ma mwada-n.*
 CNJ 3SG=PRF stay SUBR wife-3SG.POSS
 ‘And she ends up becoming his wife.’

C.2 The Cannibal

- (33) *Cipa a=caihnan ko cipa hoot ko mu=si-n bwan,*
 NEG 3SG=know OBL NEG be.far OBL DEF.DU=arm-LINK mountain
a=mu moo la ka i=apuli a=yata-n
 3SG=ITER stay be.here SBJ DEF.SG=person REL=name-3SG.POSS
Xa-xhwi Apuli ko i=Vai Ta-gulo,
 AGT.NMLZ-eat person on DEF.SG=rock cut?-umbilical.cord
 ‘Without knowing that not far from there after two mountain bells there used to live a man who was a cannibal and called Cauri Kayuk o Paik Tegulo.’

- (34) *vwa i=mwa-n-ea patemwano i=jaahoot*
 EXIST DEF.SG=house-LINK-3SG.POSS next.to DEF.SG=river
 ‘who had his house not far from the river.’
- (35) *La ca la ka i=jahoot a=mu ta-me nyasipoke nya*
 be.here in be.here SBJ DEF.SG=river 3SG=FREQ go.up-DIR.CP gather put
pwan jalan si-n ye, vukin ye, xhaapwe ye, doon ye ka
 on side arm-LINK tree trunk-LINK tree fruit tree leaf tree CNJ
apuli hman.
 person also
 ‘There where the river brings up on the edge all that it charms: branches,
 trunks, fruits, and plants or men.’
- (36) *Kavi pwa i=jelan we vwa i=yavi*
 but on DEF.SG=side water EXIST DEF.SG=syzygium.malaccense
a=mu vwa sinan aman nyakoo-n.
 3SG=FREQ do sign thing for-3SG.POSS
 ‘But where the edge of this water hole was, there was a mountain apple
 stalk which served as an alarm.’
- (37) *In Fwe a=cavi-a ka i=java a=ja titoot*
 skin figtree REL=carry.away-3SG.OBJ SBJ DEF.SG=flood 3SG=PRF latch.onto
ko i=vuki ye ma vatipwe-a xala i=vuki
 OBL DEF.SG=stem tree SUBR drop-3SG.OBJ under DEF.SG=stem
yavi.
 syzygium.malaccense
 ‘Ciin Fwe who had been carried away managed to grab hold of a trunk
 which deposited it under the mountain apple tree.’
- (38) *A=ja fe mwa li=wîi-n ka a=ja xaleke hapi*
 3SG=PRF take REP DEF.PL=strength-3SG.POSS CNJ 3SG=PRF see COMP
tana li=xhaapwe yavi.
 ripe DEF.PL=fruit syzygium.malaccense
 ‘While regaining her strength, she saw that the fruits of the mountain
 apple were ripe.’
- (39) *A=e-wago ma a=cuut ka a=tabwe thien xhaapwe*
 3SG=REFL-encourage SUBR 3SG=stand CNJ 3SG=pick.fruit three fruit
yavi tana.
 syzygium.malaccense ripe
 ‘She got to her feet as best she could and picked up three very ripe fruits.’

C The Story of the Dance Beat (Yvonne Sahilé)

- (40) *Xa-xhwi Apuli ko i=Vai Tegulo a=kon majit can*
 AGT.NMLZ-eat person OBL DEF.SG=rock T 3SG=PROG rest in
mwa-n-ea a=tada nyoot ka a=vi :
 house-LINK-3SG.POSS 3SG=be.startled wake.up CNJ 3SG=say
 ‘Kawi Kayuk o Paitegulo who was sleeping in his hut woke up with a start saying:’
- (41) “*Thien li=apuli a=le=xala i=vuki yavi.*”
 three DEF.PL=person REL=3PL=under DEF.SG=stem syzygium.malaccense
 “Three people are at the foot of the mountain apple.”
- (42) “*E=caihnan i=xhe i=wee li=xhapwe*
 1SG=know DEF.SG=sound DEF.SG=water DEF.PL=fruit
yavi ma le=tipwa pu, e=hut xaleke.”
 syzygium.malaccense SUBR 3PL=fall ground 1SG=go.down see
 “I recognize by the noise made by the sap of the three fruits falling to the ground, I will see.”
- (43) *Ca i=wadan-aen In Fwe a=hnyame-ke li=thien xhaapwe*
 in DEF.SG=time-DIST skin figtree 3SG=swallow-TR DEF.PL=three fruit
yavi ka a=ja vwa ma tipwa xawe.
 syzygium.malaccense CNJ 3SG=PRF do SUBR drop young
 ‘During this time Ciin Fwe swallowing the three fruit triggered her childbirth.’
- (44) *Cama ja hma-san ca i=goakan ka Xa-whi Apuli ko*
 when PRF arrive-go in DEF.SG=place SBJ AGT.NMLZ-eat person OBL
Vai Tegulo a=hmaako i=thamo ma mu=xhwaawe
 DEF.SG=rock T 3SG=find DEF.SG=woman COM DEF.DU=child
xa-xahnang maa-lu lu=kon mi-xala-da
 AGT.NMLZ-bien face-3DU.POSS 3DU=PROG lying-look-go.up
 ‘Arriving at the place Kawi Kayuk o Paitegulo found a woman with two beautiful babies.’
- (45) *A=fwajimwe-a “na go=kai, thamo, ma go=ha-me muja-ke*
 3SG=ask-3SG.OBJ DEM 2SG=who woman SUBR 2SG=go-DIR.CP vomit-TR
mu=nyai-m nye-cahni ka go=hma-sa-me tabwe
 DEF.DU=child-2SG.POSS put-here CNJ 2SG=arrive-go-DIR.CP pick.fruit

li=xhaapwe yee-n-eong?”

DEF.PL=fruit tree-LINK-1SG.POSS

‘And he asked her “Who are you woman to come and vomit your children here and that you to collect my fruit?”’

- (46) *A=vi nyakoon can taemwi ca-n si-n*
 3SG=say for-3SG while catch in-NSPEC arm-3SG.POSS
mu=nyai-n:
 DEF.DU=child-3SG.POSS

‘Holding her children in her arms she said to him:’

- (47) *“E=bwadut nyakoo-m ko go=apuli a= xhopwen ko cipa*
 1SG=bow for-3SG because 2SG=man REL= big because NEG
goon me tabwe li=xhaapwe yeeca me xaje,
 enough SUBR=1SG pick.fruit DEF.PL=fruit tree-PROX SUBR=1SG eat.juicy
 “I lower myself before you great man because I am not worthy to collect
 these fruit and to eat them,’

- (48) *kavi vukin, a=cavi-o ka i=java ka*
 but reason-ANA 3SG=sweep.away-1SG SBJ DEF.SG=flood CNJ
e=ta-me vatipwe mu=xawe-ca xala
 1SG=go.up-DIR.CP drop DEF.DU=young-PROX under
i=yee-n-go.
 DEF.SG=tree-LINK-2SG.POSS

‘...but here I am carried away by the flood and that I am come to give birth to these two children at the foot of your tree.’

- (49) *Cama xahnang nyasi-m ce-o m=e silaa*
 when good for-2SG leave-1SG.OBJ SUBR=1SG raise
mu=nyae-ung nya-cahni ma abe=vwa thuan mwa
 DEF.DU=child-1SG.POSS put-here SUBR 1PL.EXCL=do good REP
i=a abe=vwa nyako i=yee-n-go, kona
 DEF.SG=REL= 1PL.EXCL=do for DEF.SG=tree-LINK-2SG.POSS CNJ
mu=xhwaawe-ca xayu.
 DEF.DU=child-PROX boy

‘If it’s okay with you let me raise my children here and fix what we did to your tree because those two children are boys.’

C The Story of the Dance Beat (Yvonne Sahilé)

- (50) *Abe=bo yabwen-go ka mu=nyae-ung lu=bo*
 1PL.EXCL=IRR subject-2SG.POSS CNJ DEF.DU=child-1SG.POSS 3DU=IRR
xa-vwa-vaa-n-go.
 AGT.NMLZ-do-war-LINK-2SG.POSS
 ‘We will serve you and my children will be your warriors.’
- (51) *A=fe nyakoo-n ma xhwatin li=fatii In Fwe, Xa-xhwi*
 3SG=take for-3SG SUBR small DEF.PL=word skin figtree AGT.NMLZ-eat
Apuli ko Vai Thegulu a=thagavi li=buloo mu=bifidu
 person on rock T 3SG=cut DEF.PL=umbilical.cord DEF.DU=twins
ka coopwi xala i=yavi cela i=vai,
 CNJ bury under DEF.SG=syzygium.malaccense next.to DEF.SG=rock
 ‘Softened by Ciin Fwe’s words, Kawi Kayuk o Paitegulo cut the umbilical
 cords of the twins there and buried them under the mountain apple next
 to a rock.’
- (52) *ka bwa i=goakan-aen a=bwa yata-n Vai Tehnang.*
 CNJ IPFV DEF.SG=place-DIST REL=IPFV name-3SG.POSS rock sharp
 ‘...this place will be Pai-tea.’
- (53) *Ka a=fwajimwake nyako i=inya-lu “Hmwaeke*
 CNJ 3SG=ask for DEF.SG=mother-3DU.POSS how
i=yata-m?”
 DEF.SG=name-2SG.POSS
 ‘And he says to the mother “What’s your name?”’
- (54) *ka a=sabe nyasi-n ka In Fwe hapi “In Fwe ka*
 CNJ 3SG=answer for-3SG.POSS SBJ skin figtree COMP skin figtree CNJ
e=hupe nya hnya-da xada” kavi cipa a=vi
 1SG=go.down-DIR.CP in.direction send-up up.there but NEG 3SG=say
i=goakan.
 DEF.SG=place
 ‘And she answers him “Ciin Fwe and I come from a little higher” without
 specifying the place to him.’
- (55) *Ka a=vi ka i=apuli “go=bo thovii hmwaeke nyakoo-lu, ma*
 CNJ 3SG=say SBJ DEF.SG=man 2SG=IRR call how for-3DU.POSS SUBR
cipa boje-lu.”
 NEG deaf-3DU
 ‘And the man tells her “What are you going to give them as a name so
 that they are not deaf?”’

- (56) *Ka a=sabe nyasi-n "ca=ape-hnyimake-aman-go"*
 CNJ 3SG=answer for-3SG.POSS INDF.SG=LOC.NMLZ-think-thing-2SG.POSS
 'And she answers "Whatever you think".'
- (57) *Kona thovi nyako i=see Ngeein ka i=se Cada*
 CNJ call for DEF.SG=other cycas.rattle CNJ DEF.SG=other beat
 'so he gave one the first name of Neen (Seed Rattle) and the other Cada (Bark Clapper Beat).'
- (58) *Ka a=vi nyako i=inya-lu ma a=fee-lu*
 CNJ 3SG=say for DEF.SG=mother-3DU.POSS SUBR 3SG=take-3DU.OBJ
ma le=hân cai-n pala-n.
 SUBR 3PL=go behind-3SG.POSS home-3SG.POSS
 'And he told their mother to take them and follow him home.'
- (59) *Ma le=hma-san a=feanake si-le joakan juu mwa,*
 SUBR 3PL=arrive-go 3SG=show for-3PL big real house
 'When he arrived he would designate a large hut for her.'
- (60) *vwa can vi "In Fwe ta ca i=juu mwa-ca ma*
 do while say skin figtree go.up in DEF.SG=real house-PROX SUBR
go=silaa mu=nyai-m."
 2SG=raise DEF.DU=child-2SG.POSS
 '...saying "Ciin Fwe enter this hut and bring up your children."'
- (61) *a=vi nyakoo-n "hole ka ma bo vwa xahnang nyasi-m meekan"*
 3SG=say for-3SG thanks CNJ SUBR IRR do good for-2SG all
 'She says "Thank you and that everything be returned to you."'
- (62) *Fine bwaabwen pathaabua i=juu mwa a=mu hmaa-ko*
 every morning before DEF.SG=real house 3SG=FREQ arrive-on
xeen uvu, xeen xhwaeo, nyu ma juu-mani.
 basket yam basket taro fish COM real-bird
 'Every morning, in front of her house, she finds baskets of yam and taro, fish and goliath imperial pigeons.'
- (63) *Ma cika vukin ma a=xaahni ca aman ma a=vwa*
 SUBR NEG.EXIST reason SUBR 3SG=search some thing SUBR 3SG=do
tââ-n
 oven-3SG.POSS
 'So that she didn't have to worry about what she put in her oven.'

C.3 The Boys Grow Up

- (64) *Le=ha-me ka li=jo, mu=xayu ja xhopwe-lu mwa, ja*
 3PL=go-DIR.CP SBJ DEF.PL=year DEF.DU=boy PRF be.big-3DU DEICT PRF
bwahliia-lu mwa, na a=ja tha-xaleke ka Xa-xhwi Apuli.
 be.long-3DU DEICT DEM 3SG=PRF strongly-see SBJ AGT.NMLZ-eat person
 ‘Years have passed, the boys are growing up, gaining height, which has not escaped Kawi Kayuk.’
- (65) *Ca i=se thoatit a=vi nyako In Fwe “In Fwe ta-me*
 in DEF.SG=other day 3SG=say for skin figtree skin figtree go-DIR.CP
xaleke, ta-me cuut cel-ong pwa i=vai-ca”.
 see go-DIR.CP stand next-1SG.POSS on DEF.SG=stone-PROX
 ‘One day he said to Ciin Fwe: “Ciin Fwe come and see, come and stand next to me on this rock.”’
- (66) *A=ja vwa ka In Fwe.*
 3SG=PRF do SBJ skin figtree
 ‘This Ciin Fwe does.’
- (67) *A=vi nyakoo-n “xaleke pathabuaa-m, meekan*
 3SG=say for-3SG.POSS see before-2SG.POSS all
i=pal-ong”
 DEF.SG=home-1SG.POSS
 ‘He says to her “Look before you, this is my territory.’
- (68) *Xaahni cama go=vwa nya-la*
 watch.with.purpose if 2SG=do put-be.here
i=nyangan-aman-go.
 DEF.SG=garden-thing-2SG.POSS
 ‘Choose where you want to do your field.’
- (69) *a=sabe nyasi-n “vwasoon m=e hân ca-n*
 3SG=answer for-3SG.POSS impossible SUBR=1SG go in-NSPEC
nyangan-aman ko mu=xhwaawe bwa cika wîi-lu”
 garden-thing because DEF.DU=child IPFV NEG.EXIST strength-3DU.POSS
 ‘She answers “But I cannot go to the field because the children are not strong enough!”’

- (70) *A=vi nyakoo-n hapi "hân, e=bo xaahni-lu."*
 3SG=say for-3SG.POSS COMP go 1SG=IRR watch.with.purpose-3DU.OBJ
 'He tells her "Go. I will take care of them"'
- (71) *I=bwaabwenan a=ja hân fwadai ca=ma a=vwa*
 DEF.SG=next.day 3SG=PRF go look.for INDF.SG=SUBR 3SG=do
nyangan-aman la.
 garden-thing be.here
 'The next day she left to see where she will do the field.'
- (72) *Ka a=siiwa can batebwen*
 CNJ 3SG=return in evening
 'And she returns in the evening.'
- (73) *Cama a=ta ca i=juu mwa a=tadake ma a=tena*
 SUBR 3SG=go.up in DEF.SG=real house 3SG=be.surprised SUBR 3SG=hear
mu=nyain a=lu=kon pala.
 DEF.DU=child-3SG REL=DU=PROG talk
 'As she enters the hut she is surprised to hear her children speak.'
- (74) *A=fwajimwa-lu "a=ecaa-kau ko-n pala ka=kai?"*
 3SG=ask-3DU 3SG=teach-2DU OBL-NSPEC talk SBJ=who
 'She asks them "Who taught you to speak?"'
- (75) *Lu=sabe nyasi-n "ko na Xa-xhwi Apuli"*
 3DU=answer for-3SG CNJ DEM AGT.NMLZ-eat person
 'They reply "It was Kawi Kayuk"'
- (76) *Ca i=se thoatit a=ja=hnyimake ma hân sanya.*
 in DEF.SG=other day 3SG=PRF=think SUBR go clear.yam.field
 'One day she decides to go and prepare the yam field.'
- (77) *A=fwajimwa Xa-xhwi Apuli "goon m=e=hân can*
 3SG=ask AGT.NMLZ-eat person enough SUBR=1SG=go in
nyangan-aman?"
 garden-something
 'She asks Kawi Kayuk "Can I go and do the field?"'
- (78) *A=vi nyakoo-n "Hân go=bwa=ha-mwa-me cama go=bwa=koin."*
 3SG=say to-3SG go 2SG=IPFV=go-REP-DIR.CP when 2SG=IPFV=finish
 'He says to her "Go and come back when you are done."'

C The Story of the Dance Beat (Yvonne Sahilé)

- (79) *Koin a=ta can nyangan-aman Xa-xhwi Apuli a=ecaa*
 while 3SG=go.up in garden-something AGT.NMLZ-eat person 3SG=learn
mu=xawe ko li=yata li=phwê ma i=wadan
 DEF.DU=young OBL DEF.PL=name DEF.PL=moon COM DEF.SG=time
a=go=vwa i=siya
 REL=2SG=do DEF.SG=yam.field
 ‘While she goes to the field, Kawi Kayuk teaches the children the names
 of the months and the seasons, the yam calendar.’
- (80) *Can bate-bwen a=ja=siiwa mwa ka i=nyanyanlu,*
 in tip-night 3SG=PRF=return REP SBJ DEF.SG=mother-3DU.POSS
mu=nyai-n, lu=vi nyakoo-n:
 DEF.DU=child-3SG.POSS 3DU=say to-3SG.POSS
 ‘In the evening when the mother comes home the children tell her:’
- (81) “*Nyanya tabo la ma go=tena*”
 mom sit be.here SUBR 2SG=hear
 “‘Mom sit down and listen to this!’”
- (82) *ka lu=thapoke saxhuti li=a= lu=ecaa jahnga i=thoatit*
 CNJ 3DU=begin tell.story DEF.PL=REL= 3DU=learn length DEF.SG=day
 ‘And they start to tell her what they learned during the day.’
- (83) *i=jo, li=wadan, li=thoatit ma li=phwê.*
 DEF.SG=year DEF.PL=time DEF.PL=day COM DEF.PL=moon
 ‘the yam calendar, the seasons, the days and the months.’
- (84) “*Ko na kai a=ecaa-kau ko nien-aen?*” *a=fwajimwa-lu ka*
 CNJ DEM who REL=learn-2DU.OBJ OBL DEF.PL-PROX 3SG=ask-3DU.OBJ SBJ
In Fwe.
 skin figtree
 “‘But who was it that taught you all this?’ Ciin Fwe asks her boys.’
- (85) “*Na Xa-xhwi Apuli !*”
 DEM AGT.NMLZ-eat person
 “‘It was Kawi Kayuk’”
- (86) *A=vi nyakoo-lu “mu=xayu-n-eong, vwa juu xahnang*
 3SG=say to-3DU DEF.DU=male-LINK-1SG.POSS EXIST real good
nyim-ong koo-u!”
 heart-1SG.POSS OBL-2DU
 ‘She tells them “My boys, I am very proud of you!’”

- (87) *Hâ-mwa-me i=wadan ma a=hâ-mwa saavi i=hnea-n.*
 go-REP-DIR.CP DEF.SG=time SUBR 3SG=go-REP visit DEF.SG=field-3SG.POSS
 ‘There comes the time when she must go and visit her field.’
- (88) *A=ce mu=xayu pala i=Xa-xhwi Apuli.*
 3SG=leave DEF.DU=boy at.home DEF.SG=AGT.NMLZ-eat person
 ‘She entrusts her boys to Kawi Kayuk.’
- (89) *Cala ha-mwa ca-n batebwen a=hmaa-ko mu=nyai-n*
 when go-REP in-NSPEC night 3SG=arrive-on DEF.DU=child-3SG.POSS
lu=kon=jala.
 3DU=PROG=play
 ‘When she comes home in the evening, she finds her children playing
 [skill] games.’
- (90) *A=tadake “gau=kon=vwa da?”*
 3SG=be.surprised 2DU=PROG=do what
 ‘She wonders, “What are you doing?”’
- (91) *Lu=vi nyakoo-n: “go=caihna-n naen goon ma=abu=*
 3DU=say to-3SG 2SG=know-NSPEC now enough SUBR
ja=vap ma vwa-tau, pa=ja=tehnang
 1DU.EXCL=PRF=hunt COM make-impact PRF=PRF=sharp
li=si-bu”
 DEF.PL=arm-1DU.INCL.POSS
 ‘They say to her “You know, now we can go hunting and fishing, we are
 now skillful.”’
- (92) *Kona a-vi nyakoo-lu “xahmaen gase=bo ta ca-n siya*
 CNJ 3SG=say for-3DU tomorrow 1PL.INCL=IRR go.up in-NSPEC field
ma gau=bo=balan-thaap”
 SUBR 2DU=IRR=walk-nyaouli
 ‘So she says to them “Tomorrow we will go to the field so that you can
 hunt (lit. walk around among the nyaouli trees).”’
- (93) *I=bwaabwenan le=saahma mu-bwen-nyoot, lu=fe*
 DEF.SG=next.day 3PL=rise little-night-emerge 3DU=take
li=daa-lu ma li=jikela-lu,
 DEF.PL=spear-3DU.POSS COM DEF.PL=arrow-3DU.POSS
 ‘The next day, getting up early, they took their spears and arrows’

C The Story of the Dance Beat (Yvonne Sahilé)

- (94) *ka cahma i=nyanya a=fe i=xee-n*
 CNJ SUBR DEF.SG=mom 3SG=take DEF.SG=basket-LINK
japita-le
 provision-3PL.POSS
 ‘...and as to the mom, she takes her basket of provisions.’
- (95) *Lu=ce i=inya-lu ca-n siya ma lu=hân vap*
 3DU=leave DEF.SG=mother-3DU.POSS in-NSPEC field SUBR 3DU=go hunt
pwan bwan fwadai li=juu-mani hman masoo.
 on-NSPEC mountain look.for DEF.PL=real-bird also fruitbat
 ‘Leaving their mother in the field they go hunting in the heights to find
 goliath doves and fruitbats.’
- (96) *Cala lu=hma-san vwa i=ape-mapeke*
 when 3DU=arrive-move.same.level EXIST DEF.SG=LOC.NMLZ-bright
lu=tabo ma lu=bwaa=hmwet
 3DU=sit SUBR 3DU=IPFV=tired
 ‘Once they arrive in a clearing the two sit down to rest.’
- (97) *Ngein a=vi nyako i=been Cada, xaleke, moo cahni*
 N. 3SG=say for DEF.SG=brother-3SG.POSS C. see stay here
gasu=xaleke i=jati
 1DU.INCL=see DEF.SG=sea
 ‘Neen tells his brother “Cada. Look, from here we see the sea.”’
- (98) *A=vi ka Cada “Ma cai-ju gasu=xaleke*
 3SG=say SBJ C SUBR behind-1DU.INCL 1DU.INCL=see
i=yeen-bwan
 DEF.SG=tree-mountain
 ‘Cada says “Whereas behind us we see the mountain top.”’
- (99) *“Kavi tha=go=xaleke i_{SPEC}=[e kon xaleke] na hmuun mae!”*
 but ASS=2SG=see DEF.SG=REL.1SG PROG see DEM smoke fire
 ‘“But do you see what I’m seeing, that’s smoke!”’
- (100) *“Hmwakan vwa apuli_{NSPEC} xada, gasu=bo=fwajimwa nyaanya”*
 maybe EXIST person up.there 1DU.INCL=FUT=ask mum
 ‘“Maybe there are people up there, we’ll ask Mum.”’

- (101) *Cala lu=fwajimwe-a, a=vwa e-vwaseekan ka In Fwe ko*
 when 3DU=ask-3SG 3SG=do INS-sad SBJ skin figtree because
a=caihnan hapi na la i_{SPEC}=xhoogo-nea.
 3SG=know.INAN COMP DEM be.here DEF.SG=home-3SG.POSS
 ‘When they ask her, Fig Bark is sad because she knows that this is her home.’
- (102) *Ka a=sabe nya.sii-lu “hmwakan vwa apuli_{NSPEC}*
 and 3SG=lift.to.mouth give.hand-3DU maybe EXIST people
xada.”
 up.there
 ‘And she answers them “Maybe there are people up there.”’
- (103) *Ca i=wadan a=e-thaloo-kan tha see ma i=a*
 in.SPEC DEF.SG=time REL=ORD-two-ORD ASS.3SG cry COM DEF.SG=REL.3SG
vi,
 say,
 ‘The second time she cries about what he said...’
- (104) *kavi a=vi nyakolu hapi “ca eca se wadan gase=bo ta*
 CNJ 3SG=say to-3DU that in some other time 1PL.INCL=FUT go.up
xaleke i=hmuu-n mae-aen.”
 see DEF.SG=smoke-LINK fire-DEM
 ‘...but she tells them that “Some other time (singular) we’ll go up and/to look at that smoke.”’

C.4 Mathila

- (105) *Ko i=si-n thu cipa le=xaleke eca mani a=xhwatiin*
 on DEF.SG=arm-LINK banyan NEG 3PL=see some bird REL=small
yata-n mathila
 name-3SG.POSS M.
 ‘They didn’t see some small bird on the banyan branch called Mathila [streaked fantail]...’
- (106) *ko a=kon fwajimwake hapi na kai ni-ehni a=le=kon*
 but 3SG=PROG ask that DEM who DEF.PL-PROX REL=3PL=PROG
bwaa hma.
 IPFV arrive
 ‘...but it was wondering who these people were who had just arrived.’

C The Story of the Dance Beat (Yvonne Sahilé)

- (107) *I=mani-ca, fine li=thoatit pwecake-n goon-xat,*
 DEF.SG=bird-PROX COUNT DEF.PL=day-NSPEC after enough-sun
thapoke i=wadan a=cavi-a ka In-Fwe, a=mu
 begin DEF.SG=time REL=carry.away-3SG.OBJ SBJ I. 3SG=FREQ
ha-me xhaavwa koo-n a=xaahni i=hun-siiwa
 go-DIR.CP wait.around OBL-ANA 3SG=see DEF.SG=NMLZ-return
ka-n.
 LINK-ANA
 ‘This bird, every day at noon, since the time that In Fwe was swept
 away, it waited for when it would see her return.’
- (108) *I=mani-aen, i=xa-vuki-n i=daahma*
 DEF.SG=bird-DIST DEF.SG=AGT.NMLZ-stem-3SG.POSS DEF.SG=chief
Thêa Xa-vila
 Firstborn AGT.NMLZ-dance
 ‘This bird, its owner was the chief Firstborn Dancer...’
- (109) *a=fa-tena nyakoo-n meekan li=aman le=mu hmaa*
 3SG=CAUS-hear for-3SG.POSS all DEF.PL=thing 3PL=ITER arrive
koo-le nya-ca i=ape-moo.
 in-3PL.POSS inside-LOC DEF.SG=LOC.NMLZ-stay
 ‘... it let him know all the things which would happen to them in the
 tribe’
- (110) *a=hân tatu vii nyako i=daahma hapi le=hma ka*
 3SG=go do.quickly say for DEF.SG=chief COMP 3PL=arrive SBJ
li=xaaya ca i=ape-moo.
 DEF.PL=stranger in DEF.SG=LOC.NMLZ-stay
 ‘It quickly goes to tell the chief that strangers had arrived in the tribe.’
- (111) *I=daahma a=vi nyakoo-n “hân xaleke go bwa ha-me vi*
 DEF.SG=chief 3SG=say for-3SG go see then IPFV go-DIR.CP say
hapi le=kon vwa da, nievit jevwa-le”
 COMP 3PL=PROG do what how.many number-3PL.POSS
 ‘The chief, he tells it “Go see, then return to tell me what they are doing,
 and how many they are.”’
- (112) *A=sabe nyasi-n “thaloo apuli ma thamo”*
 3SG=pick.up for-3SG two man COM woman
 ‘It answers him “Two men and a woman.”’

- (113) *“Hân xhaavwa koo-le!”*
 go wait OBL-3PL
 ‘Go wait for them!’
- (114) *I=bwaabwenan pwecaken goon-xat a=hu-pwa*
 DEF.SG=next.day after enough-sun 3SG=go.down-REP
 ‘The next day after noon it goes down.’
- (115) *A=xaleke hapi tehnang si-lu ko i=vwa tau ma*
 3SG=see COMP sharp hand-3DU.POSS OBL DEF.SG=do impact COM
i=vap, juu vaa vwa wî-lu
 DEF.SG=hunt real much EXIST strength-3DU
 ‘It sees that their hands are deft at fishing and hunting, that they are very strong.’
- (116) *Tha lu=xaleke i=mani*
 ASS 3DU=see DEF.SG=bird
 ‘They see the bird.’
- (117) *A=fwajiwa-lu “tha gau=xale-o?” Lu=vi hapi “hê”*
 3SG=ask-3DU ASS 2DU=see-1SG 3DU=say COMP yes
 ‘It asks them “Can you see me?” They say “Yes”.’
- (118) *“Ka gau=tena-o?” Lu=vi hapi “hê”*
 CNJ 2DU=hear-1SG 3DU=say COMP yes
 ‘“And can you hear me?” They say “Yes”.’
- (119) *i=mani a=fwajimwa-lu “kavi gau=kai ka gau=hân heeve?”*
 DEF.SG=bird 3SG=ask-3DU but 2DU=who CNJ 2DU=go where.mobile
Gau=hâ-me moo ve?”
 2DU=go-DIR.CP stay where.immobile
 ‘The bird asks them “But who are you, where are you going? Where do you come from?”’
- (120) *lu=saxhut i=jaxhut ko i=inya-lu*
 3DU=tell DEF.SG=story on DEF.SG=mother-3DU.POSS
 ‘They tell the story of their mother.’
- (121) *i=mani a=fwajimwa-lu “ka heeve i=inya-u?”*
 DEF.SG=bird 3SG=ask-3DU CNJ where DEF.SG=mother-2DU.POSS
 ‘The bird asks them “And where is your mother?”’

C The Story of the Dance Beat (Yvonne Sahilé)

- (122) *a=vi ka In fwe hapi “na yo”*
 3SG=say SBJ skin figtree COMP DEM 1SG
 ‘Figtree Bark says “That’s me”’
- (123) *In Fwe tha a=pa mu wanke ko li=jo tha pa hân*
 skin figtree ASS 3SG=PRF FREQ change because DEF.PL=year ASS PRF go
 ‘Figtree Bark has changed because years have passed.’
- (124) *a=vi ka i=mani hapi “e=bo hân vi nyako i=daahma*
 3SG=say SBJ DEF.SG=bird COMP 1SG=IRR go say for DEF.SG=chief
li=aman a=gavwe saxhuti”
 DEF.PL=thing 3SG=2PL tell.story
 ‘The bird says “I will go tell the chief what you told me.”’
- (125) *a=vi nyako i=daahma ka i=mani kavi saxhwe-a ka*
 3SG=say for DEF.SG=chief SBJ DEF.SG=bird but refuse-3SG SBJ
i=see ma faphâke
 DEF.SG=other SUBR believe
 ‘It tells the chief but the other refuses to believe the bird...’
- (126) *ko i=mani kona a=hnyimake hapi me-a ka In Fwe ca*
 OBL DEF.SG=bird CNJ 3SG=think COMP die-3SG SBJ skin figtree in
i=java.
 DEF.SG=flood
 ‘...since he thinks that Figtree Bark died in the flood.’
- (127) *a=vi nyako i=mani “fê-â-me-le m=e faphâke*
 3SG=say for DEF.SG=bird take-go-DIR.CP-3PL.OBJ SUBR=1SG believe
nyakoo-m”
 for-2SG.POSS
 ‘He tells the bird “Bring them here so that I may believe you.”’
- (128) *Koin i=mani a=siiwa hut ca i=jahoot, a=nyasipoke*
 while DEF.SG=bird 3SG=return go.down in DEF.SG=river 3SG=gather
meeka li=apuli ca i=ape-moo ka i=daahma ka
 all DEF.PL=person in DEF.SG=LOC.NMLZ-stay SBJ DEF.SG=chief CNJ
le=xhavwaleke ma le=fe-â-me li=apuli-ca.
 3PL=wait SUBR 3PL=take-go-DIR.CP DEF.PL=person-PROX
 ‘After the bird returns to the river, the chief meets all the people in
 village and they wait for them to bring these people to them.’

C.5 Going Home

- (129) *Cala a=hma-san ca i=ape-moo a=e-imwi*
 when 3SG=arrive-go in DEF.SG=LOC.NMLZ-stay 3SG=REFL-hold
i=hun-see ka In Fwe ko a=caihna mwa
 DEF.SG=NMLZ-cry SBJ skin figtree because 3SG=know REP
li=bee-n.
 DEF.PL=peer-3SG.POSS
 ‘When she arrives in the village, Figtree Bark holds back her tears, for she recognizes her family.’
- (130) *i=daahma a=hnya-le can hâwân.*
 DEF.SG=chief 3SG=send-3PL in front
 ‘The chief sends them before him.’
- (131) *a=fwajimwa-le na kai niehni.*
 3SG=ask-3PL DEM who DEM.PL
 ‘He asks them who they are.’
- (132) *lu=sabe nyasi-n “yo Ngeein ka yo Cada, ka cahma*
 3DU=answer for-3SG 1SG cycas.rattle CNJ 1SG beat CNJ whereas
i=thamo-ca na i=inya-bu In Fwe”
 DEF.SG=woman-PROX DEM DEF.SG=mother-1DU.EXCL.POSS skin figtree
 ‘They answer him “I am Cycas Rattle and I am Beat, and as to this woman, that is our mother Figtree Bark.”’
- (133) *a=vi nyakoo-le “ûhû! Me-a ka In Fwe paa hmain li=jo,*
 3SG=say for-3PL no die-3SG SBJ skin figtree PRF many DEF.PL=year
a=thêên fe-a ka i=we”
 3SG=run take-3SG.OBJ SBJ DEF.SG=water
 ‘He tells them “No! Figtree Bark died many years ago, the water rushed her away.”’
- (134) *goon ma gase=fêanake hmwaeke i=juuju?*
 enough SUBR 1PL.EXCL=show how DEF.SG=truth
 ‘“How can we show you the truth?”’
- (135) *a=vi nyakoo-lu hapi*
 3SG=say for-3DU COMP
 ‘He tells them that ...’

C The Story of the Dance Beat (Yvonne Sahilé)

- (136) “*gau=fêanake s-ung hapi tehnang li=si-u ko*
 2DU=show BEN-1SG.POSS COMP sharp DEF.PL=hand-2DU.POSS OBL
i=vwa tau ma vap vwa can fê-a-mwa-me le=ilake
 DEF.SG=do impact COM hunt do while take-go-REP-DIR.CP 3PL=ask
si-u”
 BEN-2DU

“You show me that your hands are deft in fishing and hunting by bringing something they ask of you.”

- (137) *a=ilake juu-mani nyasi Ngeein ka veena nyasi Cada*
 3SG=ask real-bird for rattle CNJ eel for beat

‘He asks a goliath imperial pigeon of Rattle and an eel of Beat.’

- (138) *Ka lu=the-hân ka lu=siiwa fe mwa li=aman*
 CNJ 3DU=do.running-go CNJ 3DU=return take REP DEF.PL=thing
a=a=ilake
 REL=3SG=demand

‘And they rush off and they bring back the things he demanded.’

- (139) *a=vi nyakoolu hapi*
 3SG=say for-3DU.OBJ COMP

‘He tells them that..’

- (140) “*naen gau=fêanake s-ung hapi vwa li=nyamaa-u ma*
 now 2DU=show BEN-1SG COMP EXIST DEF.PL=eye-2DU.POSS SUBR
gau=xaleke ka li=jenau ma gau=tena
 2DU=see CNJ DEF.PL=ear-2DU.POSS SUBR 2DU=hear
i=xa-thêên-fe-fati-n-eong mathila,...”

DEF.SG=AGT.NMLZ-run-take-speech-LINK-1SG.POSS streaked.fantail

“Now you two show me that you have the eyes to see and the ears to hear my messenger Mathila...”

- (141) “*ko i=mani-ca cipa le=xaleke ka meekan apuli*”
 because DEF.SG=bird-PROX NEG 3PL=see SBJ all person

“..., for this bird is not seen by all people.”

- (142) *cahma i=mani a=hân tabo ko i=sin yee a=hoot*
 whereas DEF.SG=bird 3SG=go sit on DEF.SG=branch tree REL=far
a=cuut nyeca i=xhoogo ka a=fwajimwa-ke “yo kai ka
 REL=stand inside DEF.SG=home CNJ 3SG=ask-TR 1SG who CNJ

heeve-o"

where-1SG

'As for the bird, it goes to sit on a tree branch far away, and stands in the village and asks "Who am I, and where?"'

- (143) *lu=sabe* "go=*tabo pwa i=sin* *yee a=mwa* *hoot ka*
3DU=pick.up 2SG=sit on DEF.SG=branch tree REL.3SG=DEICT far CNJ
go=i=mathila."

2SG=DEF.SG=streaked.fantail

'They answer "You sit on the tree branch that is far, and you are the streaked fantail."'

- (144) *a=vi ka matila hapi* "thake *bwajep m=e vila*"
3SG=say SBJ M. COMP throw bark.clapper SUBR=1SG dance

'Mathila says "Beat the bark clappers so that I may dance."'

- (145) *Cala lu=thake bwajep i=jamwa-lu a=tena*
when 3DU=strike bark.clapper DEF.SG=father-3DU.POSS 3SG=hear
i=xheen ma i=geen a=fa-hnyimake nyako
DEF.SG=sound COM DEF.SG=voice 3SG=CAUS-think for

li=hun-vila ka-n habu
DEF.PL=NMLZ-dance LINK-NSPEC long.ago

'When the two beat the bark clappers, [the chief] hears the sound and the voice that reminds him of the dances of yore.'

- (146) *ka a=vi hapi* "na Ngeein *ma Cada, mu=nyae-ung!*"
CNJ 3SG=say COMP DEM rattle COM beat DEF.DU=child-1SG.POSS
'...and he says "They are Rattle and Beat, my sons!"'

- (147) *Le=e-imwi-le ka le=e-see ma i=inya-lu*
3PL=RECP-grasp-3PL CNJ 3PL=RECP-one COM DEF.SG=mother-3DU.POSS
'They embrace each other and they unite with their mother.'

- (148) *A=fwajimwake nyasi In Fwe ma a=saxhuti*
3SG=ask for skin figtree COM 3SG=tell.story
i=jaxhut-ea ca i=ape-thapoke-ka-n
DEF.SG=story-3SG.POSS in DEF.SG=LOC.NMLZ-begin LINK-NSPEC
'He asks Figtree Bark to tell her story at the beginning.'

C.6 Conclusion

- (149) *Cala koin i=jaxhut-ea i=daahma a=tho nyako In*
 when finish DEF.SG=story-3SG.POSS DEF.SG=chief 3SG=call for skin
Thu ma a=vi nyakoo-n ma a=uti
 banyan COM 3SG=say for-3SG.POSS SUBR 3SG=take.off
li=naamuu-n, ka In Fwe hman.
 DEF.PL=clothing-3SG.POSS CNJ skin figtree also
 ‘Once she finishes her story the chief calls Banyan Bark to tell her to take off her clothes, and to Figtree Bark as well.’
- (150) *A=ilake nyasi li=been apuli ma le=vacuti yeen-xhwâi, ma*
 3SG=ask for DEF.PL=other person SUBR 3PL=raise tree-dance SUBR
le=siiva In Thu hnya-an koo-n.
 3PL=tie skin banyan put-go on-ANA
 ‘He asks the others to raise the dancing pole, to tie Banyan Bark to it.’
- (151) *A=ilake nyasi li=apuli-n-ea ma le=hnya*
 3SG=ask for DEF.PL=person-LINK-3SG.POSS SUBR 3PL=put
li=naamuu-n In Thu nyasi In Fwe.
 DEF.PL=clothing-LINK skin banyan for skin figtree
 ‘He asks his people to put Banyan Bark’s clothes on Figtree Bark.’
- (152) *Ca i=wadan cahma In Fwe a=hnya li=mween a=*
 in DEF.SG=time whereas skin figtree 3SG=send DEF.PL=clothing REL=
xahngang koo-n ka a=tabo cela i=daahma,
 good on-3SG CNJ 3SG=sit next.to DEF.SG=chief
 ‘At that moment, Figtree Bark put on the good clothes and sat next to the chief, ...’
- (153) *a=ilake nyasi li=apuli ma le=cini In Thu, ma a=vwa*
 3SG=ask for DEF.PL=person SUBR 3PL=burn skin banyan SUBR 3SG=do
suki li=gat-ea.
 price DEF.PL=lies-3SG.POSS
 ‘...who asked the people to burn Banyan Bark, so that she may pay for her lies.’
- (154) *Cala In Thu a=kon e-sunixhiit, a=ilake ka i=daahma*
 when skin banyan 3SG=PROG MID-suffer 3SG=ask SBJ DEF.SG=chief
nyasi mu=xhwaawe ma lu=fe li=sau
 for DEF.DU=child SUBR 3DU=take DEF.PL=clothing

i=inya-lu *ma lu=thake nya-koo-n ma lu=vila*
 DEF.SG=mother-3DU.POSS SUBR throw put-on-3SG SUBR 3DU=dance
bitake i=yee-n *vila.*
 go.around DEF.SG=tree-LINK dance

‘While Banyan Bark is suffering, the chief asks the two children to fetch their mother’s dress, to dress her and to dance around the dancing pole.’

- (155) *Ka jahngan i=bwen,* *meeke li=apuli* *le=vila*
 CNJ length DEF.SG=night all DEF.PL=person 3SG=dance
i=ngeein *ma i=cada* *bitake* *i=yee-n* *vila*
 DEF.SG=rattle COM DEF.SG=beat go.around DEF.SG=tree-LINK dance
hma-san ca i=wadan *a=me* *ka In Thu.*
 arrive-go in DEF.SG=time REL=dance SBJ skin banyan
 ‘And all night long, all the people danced the Rattle and the Beat around the dancing pole until Banyan Bark had died.’

References

- Aikhenvald, Alexandra Y. 2000. *Classifiers: A typology of noun categorization devices* (Oxford Studies in Typology and Linguistic Theory). New York: Oxford University Press.
- Bearune, Suzie. 2012. *L'expression linguistique de l'espace en nengone (Nouvelle-Calédonie)*. Paris: INALCO. (Doctoral dissertation).
- Bensa, Alban. 2008. 1917: Circulation de la parole de guerre et déplacement des populations suite à la répression. *Mwà Vée: Revue culturelle kanak* 62. 6–7.
- Bensa, Alban & Antoine Goromido. 1997. The political order and corporal coercion in Kanak societies of the past (New Caledonia). *Oceania* 68(2). 84–106.
- Bensa, Alban, Adrian Muckle & Yvon Goromoédo Kacué. 2015. *Les Sanglots de l'aigle pêcheur – Nouvelle-Calédonie : La Guerre Kanak de 1917*. Toulouse: Anarcharis.
- Berman, Ruth. 1978. *Modern Hebrew structure*. Tel Aviv: University Publishing Projects.
- Boubin-Boyer, Sylvette. 2015. *La Nouvelle-Calédonie durant la Première Guerre mondiale*. Intervention prononcée lors du stage « Construire des situations d'apprentissage formatrices pour enseigner la Première Guerre mondiale » effectué le jeudi 30 avril 2015 au Musée de la Ville de Nouméa.
- Bril, Isabelle. 2002. *Le Nêlêmwa (Nouvelle Calédonie). Analyse syntaxique et sémantique* (Langues et Cultures du Pacifique 16). Paris: Peeters.
- Bril, Isabelle. 2004a. Complex nuclei in Oceanic languages: Contribution to an areal typology. In Isabelle Bril & Françoise Ozanne-Rivierre (eds.), *Complex predicates in Oceanic languages: Studies in the dynamics of binding and boundness* (Empirical Approaches to Linguistic Typology 29), 1–48. Berlin, New York: Mouton De Gruyter.
- Bril, Isabelle. 2004b. Complex verbs and dependency strategies in Nêlêmwa (New Caledonia). In Isabelle Bril & Françoise Ozanne-Rivierre (eds.), *Complex predicates in Oceanic languages: Studies in the dynamics of binding and boundness* (Empirical Approaches to Linguistic Typology 29), 167–198. Berlin, New York: Mouton De Gruyter.

References

- Bril, Isabelle. 2004c. Noms composés en nêlêmwa. In Pierre Arnaud (ed.), *Le nom composé: Données sur 16 langues*, 185–220. Lyon: Presses Universitaires de Lyon.
- Bril, Isabelle. 2005. Semantic and functional diversification of reciprocal and middle prefixes in New Caledonian and other Austronesian languages. *Linguistic Typology* 9(1). 22–75.
- Bril, Isabelle. 2011. Noun-phrase conjunction in Austronesian languages: Additive, inclusory and comitative strategies. In Claire Moyse-Faurie & Joachim Sabel (eds.), *Topics in Oceanic morphosyntax* (Trends in Linguistics 239), 235–286. Berlin: De Gruyter Mouton.
- Bril, Isabelle. 2012. Ownership, part-whole, and other possessive-associative relations in Nêlêmwa (New Caledonia). In Alexandra Y. Aikhenvald & R. M. W. Dixon (eds.), *Possession and ownership*, 65–89. Oxford: Oxford University Press. DOI: 10.1093/acprof:oso/9780199660223.003.0002.
- Campbell, Maryline Ebeth. 1987. *The phenomenon of spreading in Fa Tiéta, a language of New Caledonia*. Arlington: The University of Texas at Arlington. (Master's thesis).
- Cauchard, Aurélie. 2014. *A study of space in Caac, an Oceanic language spoken in the North of New Caledonia*. Manchester: University of Manchester. (Doctoral dissertation).
- Clifford, James. 1982. *Person and myth: Maurice Leenhardt in the Melanesian world*. Berkeley and Los Angeles: California University Press.
- Comrie, Bernard. 1981. *Aspect: An introduction to the study of verbal aspect and related problems*. 3rd edn. (Cambridge Textbooks in Linguistics 2). Cambridge; New York: Cambridge University Press.
- Couhia, Pascal Kalewaik & Bernard Kalene Maepas. 2008. Pascal Kalewaik Couhia, de Tiendanite. *Mwà Vée: Revue culturelle kanak* 62. 61–63.
- Creissels, Denis, Pier Marco Bertinetto & Luca Ciucci. in press. Non-verbal predication in the world's languages: An overview. In *Non-verbal predication in the world's languages* (Comparative Handbooks of Linguistics). Mouton De Gruyter.
- Demmer, Christine. 2003. Nationalisme kanak et génération : une approche du changement social en Nouvelle-Calédonie. http://www.recherches-nouvelle-caledonie.org/IMG/pdf/Nationalisme_kanak_et_generation.pdf (17 May, 2016).
- Dixon, Robert M. W. 1988. *A grammar of Boumaa Fijian*. Chicago: University of Chicago Press.

- Doumenge, Jean-Pierre. 1982. Du terroir... à la ville: Les Mélanésien et leurs espaces en Nouvelle-Calédonie. *Travaux et Documents de Géographie Tropicale* 46.
- Dryer, Matthew S. & Martin Haspelmath (eds.). 2013. *The World Atlas of Language Structures Online*. Leipzig, Germany: Max Planck Institute for Evolutionary Anthropology. <https://wals.info/>.
- Eberhard, David M., Gary F. Simons & Charles D. Fennig (eds.). 2020. *Ethnologue: Languages of the world*. 23rd edn. Dallas, Texas: SIL International. <http://www.ethnologue.com/>.
- Epps, Patience. 2008. *A grammar of Hup*. Berlin: Mouton de Gruyter.
- François, Alexandre. 2004. Reconstructing the geocentric system of Proto-Oceanic. *Oceanic Linguistics* 43(1). 1–31. DOI: 10.1353/ol.2004.0009.
- Gohoup, Noël Tuai. 2008. La guerre kanak de 1917. *Mwà Vée: Revue culturelle kanak* 62. 57–60.
- Gouvernement de la Nouvelle-Calédonie. 2019. *Explorateur Géographique Géorep.Nc*. <https://dtsi-sgt.maps.arcgis.com/apps/webappviewer/index.html?id=da224a6ff1c24c029de4024d7ae8af26> (10 October, 2019).
- Grace, George William. 1969. *A Proto-Oceanic finder list* (Working Papers in Linguistics 2). Honolulu: Department of Linguistics, University of Hawaii.
- Guiart, Jean. 1954. L'Organisation sociale et coutumière de la population autochtone de Nouvelle-Calédonie. *South Pacific Commission Technical Paper* 87. 17–43.
- Guiart, Jean. 1963. *La Chefferie en Mélanésie du Sud*. Paris: Institut d'Ethnologie.
- Guiart, Jean. 1970. Les événements de 1917 en Nouvelle-Calédonie. *Journal de la Société des Océanistes* 26(29). 265–282.
- Guiart, Jean. 1981. Clans Autochtones: Situation pré-coloniale. In Gilles Sautier (ed.), *Atlas de la Nouvelle-Calédonie et Dépendances*, 69–71. Paris: Éditions de l'Office de la Recherche Scientifique et Technique Outre-Mer.
- Guiart, Jean. 1984. Données ethnologiques comparées, région de Touho, Nouvelle Calédonie. *Journal de la Société des Océanistes* 40(78). 81–102.
- Guiart, Jean. 1992. L'aire linguistique Paicî et ses marges. In *La chefferie en Mélanésie*. Paris: Institut d'Ethnologie.
- Hammarström, Harald, Robert Forkel, Martin Haspelmath & Sebastian Bank. 2020. Mainland New Caledonian. In *Glottolog*. Jena: Max Planck Institute for the Science of Human History. <https://glottolog.org/resource/language/id/main1286.bigmap.html%5C#9/-21.0742/165.3305>.
- Haudricourt, André-Georges. 1948. Les langues du nord de la Nouvelle-Calédonie et la grammaire comparée. *Journal de la Société des Océanistes* 4. 159–162. DOI: 10.3406/jso.1948.1612.

References

- Haudricourt, André-Georges. 1961. Richesse en phonèmes et richesse en locuteurs. *L'Homme* 1(1). 5–10.
- Haudricourt, André-Georges. 1968. La langue de Gomen et la langue de Touho en Nouvelle-Calédonie. *Bulletin de la Société de Linguistique de Paris* (63). 218–235.
- Haudricourt, André-Georges. 1972. New Caledonia and the Loyalty Islands. *Current Trends in Linguistics* 8. 359–396.
- Haudricourt, André-Georges & Françoise Ozanne-Rivierre. 1982. *Dictionnaire thématique des langues de la région de Hienghène (Nouvelle-Calédonie) - Pije - Fwâi - Nemi - Jawe* (SELAF 212). Paris: Peeters.
- Heim, Arnold. 1921. *Station metzdorf, pamale nord-ost koné*. DOI: 10.3932/ethz-a-000025831.
- Hollyman, Jim. 1959. Polynesian influence in New Caledonia. *The Journal of the Polynesian Society* 68(4). 357–389.
- Hollyman, Jim. 1999. *Etudes sur les langues du Nord de la Nouvelle-Calédonie* (SELAF 377). Leuven: Peeters.
- IEOM. 2014. *L'Histoire Du Franc Pacifique*. Tech. rep.
- Kemmer, Suzanne. 1993. *The middle voice* (Typological Studies in Language 23). Amsterdam: John Benjamins.
- Koch, Harold. 2021. Associated motion in the Pama-Nyungan languages of Australia. In Antoine Guillaume & Harold Koch (eds.), *Associated motion* (Empirical Approaches to Linguistic Typology 64), 231–324. Berlin/Boston: De Gruyter Mouton.
- Kroeger, Paul R. 2004. *Analyzing syntax: A lexical-functional approach*. Cambridge; New York: Cambridge University Press.
- Leenhardt, Maurice. 1946. *Langues et dialectes de l'Austro-Mélanésie* (Travaux et Mémoires de l'Institut d'Ethnologie XLVI). Paris: Institut d'Ethnologie.
- Leenhardt, Maurice. 1978a. Les événements de 1917 en Nouvelle-Calédonie: Géographie des tribus et des chefs. *Journal de la Société des Océanistes* 34(58). 19–22. DOI: 10.3406/jso.1978.2962. (27 March, 2018).
- Leenhardt, Raymond H. 1978b. Figures mélanésiennes : Le grand chef Amane des Poyes de 1898 à 1917. *Journal de la Société des Océanistes* 34(58-59). 23–59. DOI: 10.3406/jso.1978.2963.
- Lichtenberk, Frantisek. 1985. Possessive constructions in Oceanic and in Proto-Oceanic. In Andrew Pawley & Louis Carrington (eds.), *Austronesian Linguistics at the 15th Pacific Science Congress* (Pacific Linguistics 88), 93–140. Canberra: Australian National University.
- Lichtenberk, Frantisek. 2009. Oceanic possessive classifiers. *Oceanic Linguistics* 48(2). 379–402.

- Lynch, John. 1999. Southern Oceanic linguistic history. In Jean-Christophe Galipaud & Ian Lilley (eds.), *Le pacifique de 5000 at 2000 supplements a l'histoire d'une colonisation*, 423–449. Paris: Institut de Recherche pour le Développement.
- Lynch, John. 2000. Historical overview of central Pacific possessive markers. *Sprachtypologie und Universalienforschung* 53(3-4). 233–242.
- Lynch, John. 2004. The Efate-Erromango problem in Vanuatu subgrouping. *Oceanic Linguistics* 43(2). 311–338. <https://www.jstor.org/stable/3623361>.
- Lynch, John, Malcolm Ross & Terry Crowley. 2002. *The Oceanic languages*. Psychology Press.
- Lyons, Christopher. 1999. *Definiteness* (Cambridge Textbooks in Linguistics). Cambridge: Cambridge University Press.
- Moran, Steven & Daniel McCloy (eds.). 2019. *Phoible 2.0*. Jena, Germany: Max Planck Institute for the Science of Human History. <https://phoible.org/>.
- Muckle, Adrian. 2010. Troublesome chiefs and disorderly subjects: The Indigénat and the internment of Kanak in New Caledonia (1887–1928). *French Colonial History* 11. 131–160.
- Nea, Gale. 1963. *Poésie en vamaalé*. https://archives.crem-cnrs.fr/archives/items/CNRSMH_I_1964_003_001_03/. Teganpaik.
- Overall, Simon. 2017. A typology of frustrative marking in Amazonian languages. In Alexandra Y. Aikhenvald & Robert M. W. Dixon (eds.), *The Cambridge handbook of linguistic typology*. Cambridge: Cambridge University Press.
- Ozanne-Rivierre, Françoise. 1976. *Le iaai: langue mélanésienne d'Ouvéa, Nouvelle-Calédonie: Phonologie, morphologie, esquisse syntaxique* (Langues et Civilisations à Tradition Orale 20). Paris: SELAF. 10–64.
- Ozanne-Rivierre, Françoise. 1982. Phonologie comparée des langues de Hienghène et du proto-océanien. In André-Georges Haudricourt & Françoise Ozanne-Rivierre (eds.), *Dictionnaire Thématique Des Langues de La Région de Hienghène*. Paris: SELAF.
- Ozanne-Rivierre, Françoise. 1992. The Proto-Oceanic consonantal system and the Languages of New Caledonia. *Oceanic Linguistics* 31(2). 191–207. DOI: 10.2307/3623014.
- Ozanne-Rivierre, Françoise. 1995. Structural changes in the languages of Northern New Caledonia. *Oceanic Linguistics* 34(1). 44–72.
- Ozanne-Rivierre, Françoise. 1998. *Le Nyelâyu de Balade (Nouvelle-Calédonie)* (Langues et Cultures Du Pacifique 12). Peeters.
- Ozanne-Rivierre, Françoise. N.d. Dictionnaire thématique des langues pwaamei hnaakâ, pwaamei yaak et pwapwâ (Nouvelle-Calédonie). unpublished.

References

- Ozanne-Rivierre, Françoise & Jean-Claude Rivierre. 2004. Verbal compounds and lexical prefixes in the languages of New Caledonia. In Isabelle Brill & Françoise Ozanne-Rivierre (eds.), *Complex predicates in Oceanic languages: Studies in the dynamics of binding and boundness*, 347–372. Berlin: Mouton de Gruyter.
- Pawley, Andrew. 1973. Some problems in Proto-Oceanic grammar. *Oceanic Linguistics* 12(1/2). 103–188.
- Philcat, Alex. 1989. *La révolte des Poyes en Nouvelle-Calédonie*. Nanterre: Académie Européenne du livre.
- Rivierre, Jean-Claude. 1980. *La langue de Touho: Phonologie et grammaire du cè-muhî*, vol. 38 (Langues et Civilisations à Tradition Orale). Paris: SELAF.
- Rivierre, Jean-Claude. 1983. *Dictionnaire paicî-français, suivi d'un lexique français-paicî* (Langues et Cultures Du Pacifique 4). Peeters.
- Rivierre, Jean-Claude. 1993. Tonogenesis in New Caledonia. *Oceanic Linguistics Special Publications* 24. 153–173.
- Rivierre, Jean-Claude. 1994. Contact-induced phonological complexification in New Caledonia. In *Language contact and change in the Austronesian world*, 497–522. De Gruyter Mouton.
- Rivierre, Jean-Claude. N.d. *Projet de dictionnaire thématique en langue de Tyéta (Hmwaveke)*.
- Rivierre, Jean-Claude & Sabine Ehrhardt. 2006. *Le bwatoo et les dialectes de la région de Koné (Nouvelle-Calédonie)* (SELAF 435). Paris: Peeters.
- Ross, Malcolm. 2004. The morphosyntactic typology of Oceanic languages. *Language and Linguistics* 2(5). 491–541.
- Ross, Malcolm, Andrew Pawley & Meredith Osmond (eds.). 1998. *The lexicon of Proto Oceanic: The culture and environment of ancestral Oceanic society*, vol. 1: Material culture (Pacific Linguistics). Canberra: The Australian National University.
- Salaün, Marie. 2005. La francophonie en contexte post-colonial: L'exemple de la Nouvelle-Calédonie. In Washington, DC.
- Sallabank, Julia. 2015. Language ideologies, practices and policies in Kanaky/New Caledonia. In Mari C. Jones (ed.), *Policy and planning for endangered languages*, 31–47. Cambridge: Cambridge University Press.
- Salomon, Christine. 2000. Hommes et femmes: Harmonie d'ensemble ou antagonisme sourd? In Alban Bensa & Isabelle Leblic (eds.), *En pays kanak: Ethnologie, linguistique, archéologie, histoire de la Nouvelle Calédonie* (Ethnologie de La France 14), 311–338. Paris: Éditions de la Maison des sciences de l'homme, Ministère de la Culture.

- Sand, Christophe. 2012. "Certainly the most technically complex pondfield irrigation within Melanesia": Wet taro field systems of New Caledonia. *Senri Ethnological Studies* 78(1). 167–188.
- Sand, Christophe, Jacques Bole & André Ouetcho. 2007. What were the real numbers? The question of pre-contact population densities in New Caledonia. In Patrick Vinton Kirch & Jean-Louis Rallu (eds.), *The growth and collapse of Pacific Island societies*. Honolulu: University of Hawai'i Press.
- Sand, Christophe & André Ouetcho. 2001. *Tiouandé: Archéologie d'un massif de karst du Nord-Est de la Grande-terre (Nouvelle-Calédonie)* (Les Cahiers de l'Archéologie 12). Nouméa, New Caledonia: Service territorial des musées et du patrimoine - Département archéologie.
- Saussol, Alain. 1979. *L'héritage: Essai sur le problème foncier mélanésien en Nouvelle-Calédonie*. Paris: Société des Océanistes.
- Schooling, Stephen J. 1992. The phonology of Yuanga: A language of New Caledonia. *Pacific Linguistics Series A: Occasional Papers* 82. 97–146.
- Spencer, Andrew & Ana R. Luís. 2012. *Clitics: An introduction*. Cambridge; New York: Cambridge University Press.
- Stern, Jacques. 1943. *Les colonies françaises: Passé et avenir*. New York: Brentano's.
- Zúñiga, Fernando. 2014. (Anti-)cliticization in Mapudungun. *Morphology* 24(3). 161–175.
- Zúñiga, Fernando & Seppo Kittilä. 2019. *Grammatical voice* (Cambridge Textbooks in Linguistics). Cambridge; New York: Cambridge University Press.

Name index

- Aikhenvald, Alexandra Y., 130, 131, 133, 134
- Bearune, Suzie, 189, 193
- Bensa, Alban, 23, 24, 54, 56, 57, 59
- Berman, Ruth, 133
- Boubin-Boyer, Sylvette, 57
- Bril, Isabelle, 66, 72, 78, 84, 91, 102, 125, 130, 131, 136, 137, 140, 160, 163, 177, 183, 199, 203, 217, 218, 230–232, 234, 235, 239, 248, 249
- Campbell, Maryline Ebeth, 65, 69, 73, 75–77, 79–81, 84
- Cauchard, Aurélie, 128, 192, 193
- Clifford, James, 57
- Comrie, Bernard, 255
- Couhia, Pascal Kalewaik, 34, 43
- Creissels, Denis, 88
- Demmer, Christine, 23, 56, 61
- Dixon, Robert M. W., 131, 231
- Doumenge, Jean-Pierre, 61
- Eberhard, David M., 27
- Ehrhardt, Sabine, 40, 43, 45, 49, 68, 70, 71, 74, 91, 97, 99, 100, 104, 106, 113, 125, 153, 159, 172, 174, 175, 177, 186, 194, 198, 207, 223, 234, 240, 255, 265, 267, 268, 285
- Epps, Patience, 20
- François, Alexandre, 188
- Gohoup, Noël Tuai, 53
- Goromido, Antoine, 23, 24, 59
- Gouvernement de la Nouvelle-Calédonie, 30, 46
- Grace, George William, 195
- Guiart, Jean, 22, 23, 43, 49, 53, 55–57, 60
- Hammarström, Harald, 39
- Haudricourt, André-Georges, 30, 32, 40, 43, 47, 74, 80, 81, 86, 97, 98, 110, 112, 119, 159, 163, 170, 175, 204, 267, 270
- Heim, Arnold, 58
- Hollyman, Jim, 73, 124, 125, 229
- IEOM, 176
- Kemmer, Suzanne, 200
- Kittilä, Seppo, 235, 236
- Koch, Harold, 225
- Kroeger, Paul R., 103, 151
- Leenhardt, Maurice, 16, 24, 42–44, 46, 53–55, 58, 59, 69, 74, 174–176, 230
- Leenhardt, Raymond H., 53, 55–57, 59
- Lichtenberk, Frantisek, 102, 131
- Luis, Ana R., 85, 87
- Lynch, John, 23, 29, 34–36, 72, 97, 100, 102, 110, 112, 121, 127,

Name index

- 144, 170, 171, 179, 214, 267,
282
- Lyons, Christopher, 94
- Maepas, Bernard Kalene, 34, 43
- McCloy, Daniel, 63
- Moran, Steven, 63
- Muckle, Adrian, 57
- Nea, Gale, 49
- Ouetcho, André, 53
- Overall, Simon, 107
- Ozanne-Rivierre, Françoise, 32, 36,
39–41, 43, 63, 65, 68, 70, 72–
74, 78, 80, 81, 86, 92, 97–99,
110, 112, 119, 159, 160, 163,
172, 175, 195, 202, 204, 267,
270
- Pawley, Andrew, 229
- Philcat, Alex, 55, 56
- Rivierre, Jean-Claude, 40, 43, 45, 49,
68–71, 74, 75, 81, 91, 92, 97,
99, 100, 102, 104, 106, 113,
122, 125, 153, 159, 168, 170,
172, 174–177, 181, 186, 194,
195, 198, 202, 203, 207, 208,
223, 234, 240, 255, 265, 267,
268, 285
- Ross, Malcolm, 1, 122, 143, 144, 146,
160, 179–181, 194, 196, 235,
275, 284
- Salaün, Marie, 61
- Sallabank, Julia, 23, 24
- Salomon, Christine, 22
- Sand, Christophe, 29, 43, 53, 61
- Saussol, Alain, 56
- Schooling, Stephen J., 71, 75, 78, 81,
265
- Spencer, Andrew, 85, 87
- Stern, Jacques, 61
- Zúñiga, Fernando, 87, 132, 235, 236

Subject index

- Adoption, 22
- Adverbs, 109, 226
 - Adverbial clause, 284
- Affair of Poyes, 55
- Alignment, 108, 143
 - Noun phrases, 143
- Allomorph
 - Grammatically conditioned, 245
- Anaphoric *-n*, 91
- Animacy, 122, 209
 - Active verbs with *-n*, 184
- Articles, 92
- Aspect, 239
 - balan*, 246
 - Attenuating, 247
 - Continuative, 248, 250
 - Realis, 249–252
 - bwa*, 241
 - Attenuating, 242
 - Imperfective, 242
 - Prospective, 243
 - ja* ‘finally’, 255
 - Additive *mu*, 257
 - Aktionsart, 240
 - Frequentative *mu*, 256
 - Iterative *mu*, 257
 - Progressive *ko(o)n*, 245
- Assertive *tha*, 116, 268
- Case, 144
 - Agentive, 105, 145
 - Beneficiary, 146
 - Oblique, 147, 148
- Causative, 235
- Chiefdom, 21, 23
- Classifiers, 130
 - Noun classifiers, 134
 - Relational classifiers, 130
- Clause types, 262
- Clauses
 - Declarative clause, 262
 - Imperative clauses, 197, 266
 - Interrogative clause, 265
 - Polar questions, 265
 - Prohibitive clauses, 267
 - Simple clauses, 261
 - Verbless clause, 264
 - Word order, 261
- Code-switching, 47
- Complementation, 282
 - Complementizer *ma*, 282, 288
- Consonants, 65
 - Allophones, 75
 - Aspiration, 70
 - Fortis and lenis, 71
 - Labio-velarized consonants, 69
 - Voiceless nasals, 70
- Coordination, 276
 - Coordinator *hai*, 278
 - Coordinator *kavi*, 281
 - Coordinator *ka*, 279
 - Coordinator *koin*, 280

Subject index

- Coordinator *kon(a)*, 278
- Coordinator *ko*, 279
- Coordinator *ma*, 277
- Numeral coordinators, 114
- Verbal conjunctions, 113
- Cèmuhî, 48
- Demonstratives
 - Topical demonstrative *na*, 154
- Discourse markers
 - Discourse marker *go*, 263
 - Discourse marker *ka*, 263
- Exogamy, 22
- Fronting, 155
 - Topic marker *cahma*, 155
- Fwâi, 48
- Gerontocracy, 22
- Haeke, 48
- Insubordination, 288
- Intensifiers, 117
- Interjections, 119
- Irrealis, 240
- ka
 - ka*, 133
 - ka*, 130
 - ka*, 208
 - ka*, 237
- Language and land, 23, 24
- Language contact, 45
- Linker *ka*
 - Animacy, 209
- Marginal phonemes
 - [k^h], 68, 73
- [p^h], 68, 73
- [ŋ̊], 66
- [r], 66
- Metzdorf, Charles, 57
- Modality, 267
 - Deontic modality, 269
 - Epistemic modality, 268
- Morphology, 89
- Negation, 82, 116, 214
 - Existential negation, 215
 - Verbal negation, 214
- Nominalization, 202
 - Agentive nominalizer, 203
 - Instrumental nominalizer, 203
 - Linker *ka*, 208
 - Locative nominalizer, 206
 - Manner nominalizer, 204
 - Nominalized verb phrase, 206
- Noun Phrase, 143
 - Contrastive, 164
- Noun phrase
 - Quantifiers, 120
- Nouns, 101, 121
 - Benefactive nouns, 187
 - Classifiers, 101
 - Compound Nouns, 135
 - Compounds with two heads, 140
 - Noun on noun, 137
 - Noun on verb, 141
 - Verb on noun, 141
 - Reciprocal relations, 232
- Numerals, 174
 - Multiplicative, 177
- Ordinals, 176
- Particle

- been* ‘other’, 156
 - se* ‘other’, 156
- Pije, 47
- Pluractional *e-*, 199
- Possession, 122
 - Alienable, 128
 - Inalienable, 128
- Prepositions, 104
 - Relational nouns, 102
- Pronouns, 150
 - Demonstrative pronouns, 100, 152
 - Personal pronouns, 103
- Questions
 - Content questions, 265
 - Polar questions, 265
 - Question words, 265
- Reciprocal, 231
- Reduplication, 82, 200
- Reflexive, 229
- Relative clause, 284
 - Relativizer, 106
- Repetitive *mwa*, 118, 269
 - Deixis, 271
- Space, 188
 - nya* ‘around, towards, inside’, 191
 - Centripetal/-fugal, 192
 - Origin of motion *moo*, 193
 - Proximity, 227
 - Same-level axis, 192
 - Spatial adverbs, 227
- Specificity
 - n*, 90
 - Generic *-n*, 91, 128
- Stress, 82
 - Complicating factors, 83
 - Extrametrical morphemes, 83
- Subject indexes, 103
- Subordination, 281
 - ko* ‘because’, 287
 - Adverbial clause, 284
 - Complementation, 112, 282
 - Conditional *ma*, 286
 - Purposive *ma*, 286
 - Realis *cala* ‘while’, 287
- Syllable structure, 82
- TAM markers, 106
- Tipije War, 57, 58
- Transcription, 63
- Transitivity
 - Transitive *-i*, 180, 183
 - Transitive *-ke*, 180
- Verb phrase, 213
 - Asymmetrical verb string, 220
 - Comparison, 227
 - Iterative *han*, 225
 - Manner verbs, 224
 - Preverbs, 220
 - TAM markers, 106
- Verbs, 107, 167
 - Active verbs, 179
 - Active verbs with *-n*, 184
 - Complex verbs, 200
 - Compound verbs, 201
 - Dependent transitive verbs, 184
 - Impersonal verbs, 168, 240, 282
 - Incorporated object construction, 202
 - Manner verbs, 224
 - Nominalization, 202
 - Numerals, 174
 - Ordinals, 176

Subject index

- Possessible verbs, 178
- Prefixes, 193
 - da* 'do first', 198
 - the-* 'quickly, a bit; while walking', 195
 - Manner, 192, 194
 - Pluri-actional, 199
- Reduplication, 200
- Serial verb construction, 218
- Stative verbs, 170
 - Dependent stative verbs, 172
- Voice, 229
 - Causative, 235
 - Middle, 232
 - Grouping, 235
 - Lack of endpoint, 234
 - Lack of volitional agent, 234
 - Sameness, 231
 - Spatial Symmetry, 235
 - "Passive", 237
 - Reciprocal, 231
 - Reciprocal kinship terms, 232
 - Reflexive, 229
- Vowels, 75
 - Allophones, 78
 - Diphthongs, 78
 - Nasal vowels, 63
 - Nasalized vowels, 79
 - Quality, 77
 - Quantity, 76
- Word avoidance taboo, 201
- Word order, 261
- Wordhood, 85
 - vwa*, 86
 - Affixes, 87
 - Clitics, 87
 - Verbs vs nouns, 88

A grammar of Vamale

Vamale is an endangered South Oceanic > Northern New Caledonian language, spoken by around 180 people on the northeastern coast of Grande Terre. This grammar was written as a PhD dissertation, on the basis of 11 months of fieldwork funded by ELDP. The data consists both of elicitation and relatively free interviews, as well as recordings of ceremonial speeches and casual conversations. ELAR contains open-access archive of all recordings and a dictionary, as well as a FLEx database in which many examples can be found in context. The appendix includes three texts, an oral history account of the 1917 colonial war, a traditional fable, and a longer modern retelling of a legend. The grammar intends to give a general overview of Vamale to a general linguistics audience. Its focus on syntax, and comparison with related languages should particularly interest Oceanists and areal typologists. With a dedicated chapter on the community's history and cultural information throughout the book, this account hopes to show the beauty and wealth of both the Vamale language and culture.