

RESEARCH ARTICLE

Controlling the elution order of insulin and its analogs in sub-/supercritical fluid chromatography using methanesulfonic acid and 18-crown-6 as mobile phase additives

Jonas Neumann^{1,2}  | Sebastian Schmidtsdorff^{1,2} | Alexander H. Schmidt²  | Maria K. Parr¹ 

¹Department of Biology, Chemistry, and Pharmacy, Institute of Pharmacy, Freie Universität Berlin, Berlin, Germany

²Chromicent GmbH, Berlin, Germany

Correspondence

Jonas Neumann, Chromicent GmbH, Johann-Hittorf-Str. 8, 12489 Berlin, Germany.

Email: jonas.neumann@posteo.net

The purity analysis of therapeutic peptides can often be challenging, demanding the application of more than a single analytical technique. Supercritical fluid chromatography nowadays is a promising alternative to reversed-phase liquid chromatography, providing orthogonal and complementary information. This study investigated its applicability for the separation of human insulin, its analogs and degradation products. A previously published method development protocol for peptides up to 2000 Da was successfully applied to the higher molecular weight insulins (6 kDa). A single gradient method was optimized for all insulins using a Torus DEA column (100 × 3.0 mm, 1.7 μm), carbon dioxide and a modifier consisting of methanol/acetonitrile/water/methanesulfonic acid (65:35:2:0.1, v/v/v/v). Consecutively, the crown ether 18-crown-6, which is well known to complex charged lysine sidechains and other amino functionalities, was added to the modifier to evaluate its impact on selectivity. A decreased retention and a shift in the elution order for the insulins were observed. An inverse effect on retention was found when combined with a neutral stationary phase chemistry (Viridis BEH).

KEYWORDS

crown ether, design of experiments, insulin

List of Abbreviations: 18C6, 18-crown-6; AA, amino acid; ACN, acetonitrile; ASP, aspart; CrE, crown ether; DEG, degludec; DET, detemir; DoE, Design of Experiments; GLA, glargine; GLU, glulisine; HUM, human insulin; LIS, lispro; Lys, lysine; MeOH, methanol; MSA, methanesulfonic acid; RP-LC, reverse-phase liquid chromatography; RT, retention time; SFC, sub-/supercritical fluid chromatography; SP, stationary phase.

This is an open access article under the terms of the [Creative Commons Attribution-NonCommercial](https://creativecommons.org/licenses/by-nc/4.0/) License, which permits use, distribution and reproduction in any medium, provided the original work is properly cited and is not used for commercial purposes.

© 2023 The Authors. *Journal of Separation Science* published by Wiley-VCH GmbH.

1 | INTRODUCTION

The rise of peptides and proteins used as pharmaceuticals over the last decade [1, 2] came along with growing regulatory needs to ensure their quality. Biosimilars were introduced into the EU market in 2006 after the first originator patent expired. With Abasglar, the first biosimilar of the insulin analog Lantus (insulin glargine

[GLA]) was introduced in 2014, followed by a biosimilar of insulin lispro (LIS) in 2017. Today, several biosimilars of insulin aspart (ASP), GLA, and LIS are available. Specific guidelines were released, for example, by the European Medicines Agency dealing with the quality aspects of biosimilars in general [3] or insulins in specific, respecting “Quality, safety and efficacy to the reference medicinal product” [4]. The impurity profile is an essential characteristic of pharmaceutical substances and products to be controlled. Therefore, a comprehensive and extensive analysis applying a combination of orthogonal and state-of-the-art techniques is required to quantify and qualify the impurities of a biosimilar [3]. Intermediates and byproducts arising from production or degradants formed over the shelf-life must be monitored according to the International Council for Harmonisation of Technical Requirements for Pharmaceuticals for Human Use guidelines Q5C [5] and Q6B [6]. These requirements apply to drug substances and products, as well as to originator and biosimilar products.

Often, reverse-phase liquid chromatography (RP-LC), size-exclusion chromatography, and ion-exchange chromatography are the dominant techniques used to analyze peptides and proteins, allowing the determination of mono- and multimeric impurities. However, the comprehensive evaluation of monomeric impurities is often challenging due to the high chemical similarity of the main compound and its impurities [7]. A comparability study on the originator and biosimilars of insulin glargine showed several compounds coeluting with the main peak [8]. As in this case, non-volatile buffer salts are often used to ensure chromatographic performance. Mass spectrometry is often coupled to LC for characterization purposes but is obstructed by these buffers and requires substitution for TFA or formic acid. As a drawback, these often result in worse chromatographic performance regarding resolved peaks [9]. Alternatively, online or offline 2D-LC can remove non-volatile buffers before characterization through LC-MS [10].

Supercritical fluid chromatography (SFC) recently gained growing attention [11] in analytical [12–17] and preparative [18, 19] peptide separation. The broad polarity range accessible by applying a single gradient is highly beneficial, for example, in vitamin analysis or metabolomics studies [20, 21]. In addition, the new concept of a dual gradient mode was investigated by adding a second high water content gradient through dynamic mixing of the modifier, which further increased the polarity range of capable analytes [22, 23]. This now allows the elution of monomeric amino acids (AAs) and small peptides up to proteins in a single run and will assist in generating comprehensive knowledge about the

impurity profile of pharmaceuticals, especially during research and development phases. The orthogonality of SFC to RP-LC [13–15, 17] also makes it an exciting perspective as an on- or offline coupling technique for 2D chromatographic separations, even if today's interface designs require further optimization [24, 25]. This proves that SFC is a state-of-the-art technique that should be considered an alternative to RP-LC. It should be noted that the supercritical state often is not maintained under the conditions used. Thus, “supercritical” is not accurate, and “unified chromatography” [14, 16, 26] found growing usage to account for this discussion. Nevertheless, SFC is used in this work for sub- and supercritical.

However, the general knowledge based on the publications dealing with SFC separations of peptides and proteins is still limited. Additional research is necessary to push the boundaries of what is possible in this application field. In this work, we use human insulin (HUM) and its analogs to investigate the potential of SFC, on the one hand, to separate all insulins from each other and, on the other hand, to separate each insulin from byproducts or impurities. The method development protocol proposed in our previous work [12] for peptides up to 2000 Da is successfully applied to the higher molecular weight insulins (6 kDa), supported by a Design of Experiments (DoE) approach. Consecutively, the crown ether (CrE) 18-crown-6 (18C6), which so far found little application as a mobile phase additive in SFC, is found to provide interesting elution properties based on the column chemistry used.

2 | MATERIALS AND METHODS

2.1 | Chemicals and reagents

HUM and LIS from Lilly Deutschland GmbH, detemir (DET), degludec (DEG), and ASP from Novo Nordisk Pharma GmbH, GLA and glulisine (GLU) from Sanofi-Aventis Deutschland GmbH were used (all 100 I.U./ml), either as refill cartridges or ready-to-use pens. All were end-of-shelf-life batches, stored at room temperature for at least six months and were expected to contain relevant degradants. The AA sequence of all insulins is shown in Figure 1. Methanol (MeOH) and acetonitrile (ACN) in LC gradient grade were bought from VWR. Milli-Q water was prepared freshly before use by a Merck Milli-Q system and carbon dioxide (99.995%) was acquired from Air Liquide. Methanesulfonic acid ($\geq 99.0\%$) and 18C6 ($\geq 99.0\%$) were purchased from Sigma Aldrich, and aqueous ammonia solution (25%) was supplied by Merck.

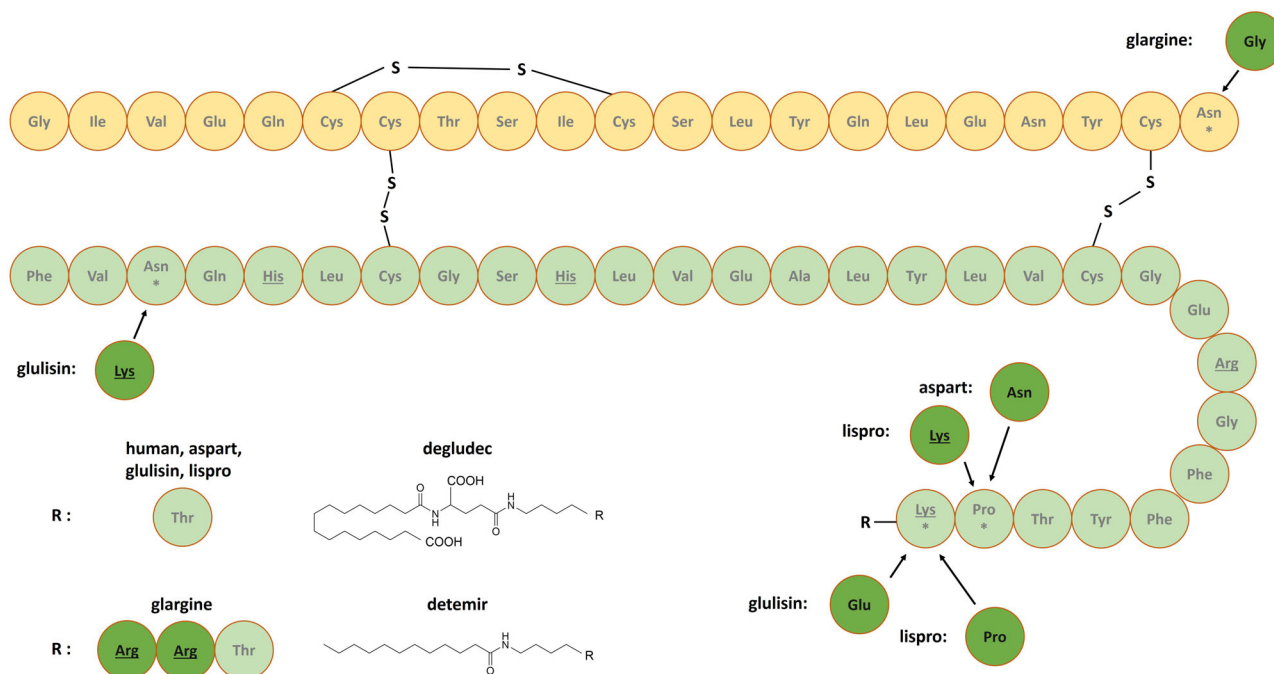

FIGURE 1 Amino acid sequences of insulin human and its analogs. The positions modified in the analogs (dark) are marked (*), and basic sidechains are underlined.

2.2 | Instrumentation and software

The chromatographic experiments were performed using an Acquity UPC² SFC system (Waters) equipped with a binary pump, a 4-port column manager with active eluent pre-heaters, an Acquity UPC² photodiode array detector (UV), and an Acquity UPC² convergence manager (backpressure regulator). Empower 3 was used for system control, data acquisition, and processing. Fusion QbD from S-Matrix (Eureka) was used to prepare and visualize the DoEs. The 2D graphs were calculated via Microsoft Excel. The following stationary phases (SPs) were utilized for the experiments: Torus Diol, Torus DEA, Torus 1-AA, and Viridis BEH, all from Waters. All columns' dimensions were 3.0 × 100 mm; particle size 1.7 μm.

2.3 | Method development

We adopted the method development workflow proposed in our previous work [12] for the higher molecular weight insulins. Due to mixing incompatibility, all insulin solutions had to be injected (1.5 μl) separately. A generic gradient from 30 to 95% modifier (B) was run in 20 min, applying a flow rate of 0.6 ml/min. Methanol/water (100:2, v:v) plus 0.1% methanesulfonic acid (MSA) (v:v) as the modifier was tested in combination with four SPs (Section 2.2). The column temperature was set to 50°C and

backpressure to 1500 psi (approx. 100 bar). The best combination was kept for further experiments: the DEA column and a modifier consisting of MeOH/water/MSA (100:2:0.1, v:v:v). Consecutively, two DoEs were performed as described in chapter 3.2.

2.4 | Final method

The final method utilized a Torus DEA column (2.1 × 100 mm, 1.7 μm). The column temperature was set to 55°C and the backpressure to 1500 psi at a flow rate of 0.6 ml/min running a segmented gradient: 0–5 min: 30–62% B, 5–20 min: 62–75% B with the modifier (B) consisting of MeOH/ACN/water/MSA (65:35:2:0.1, v:v:v:v). All chromatograms were recorded at 210 nm.

3 | RESULTS AND DISCUSSION

3.1 | Screening of additives and column chemistries

The elution order of all insulins was similar for the neutral (Diol and BEH) and the amino-derivatized (1-AA and DEA) SPs but differed for both groups (Figure 2). Glargine, modified by adding two basic arginines to HUM, eluted the last on the neutral columns. That is in line with the results

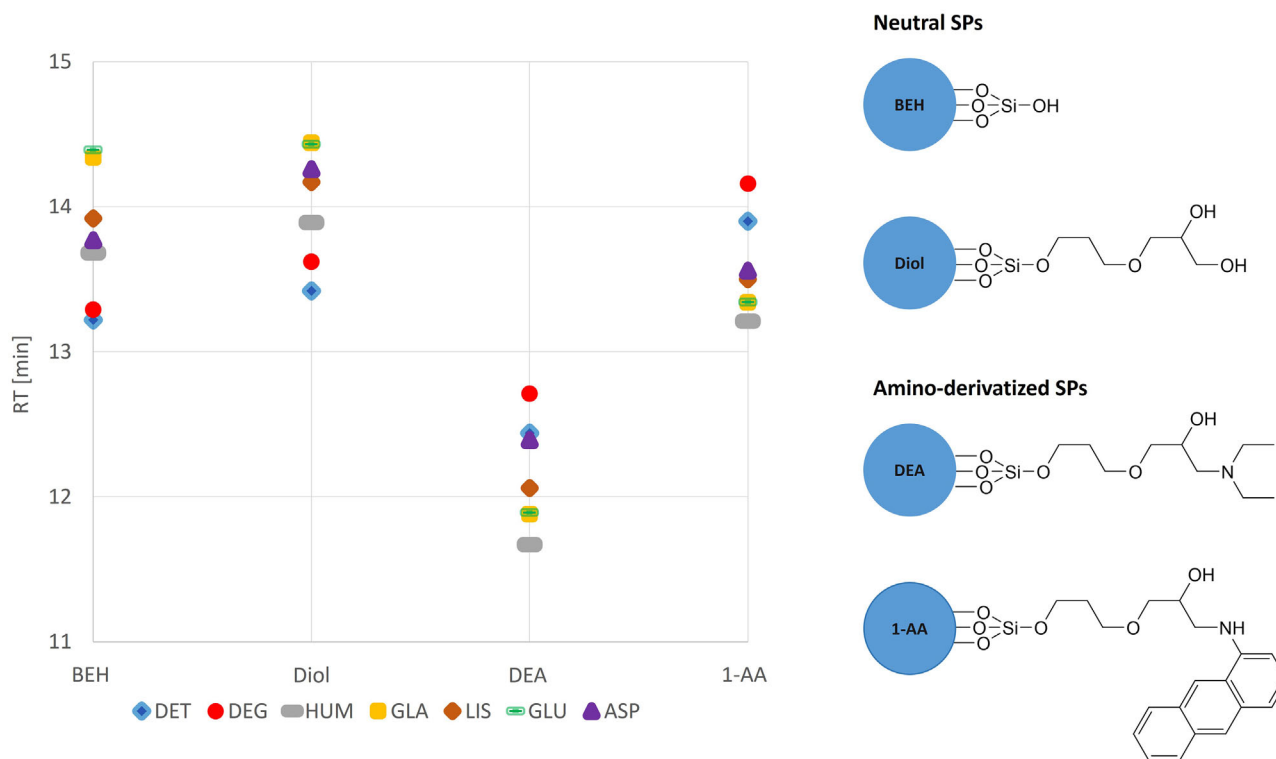

FIGURE 2 Elution order of the insulins observed during the screening on various column chemistries as shown on the right.

of previous studies, which reported that the presence and number of basic sidechains is a major factor determining the retention of peptides in SFC [12, 15, 17, 27, 28]. The addition of MSA provides acidic conditions resulting in protonated amino functionalities and ion-pair formation with MSA. In the case of DEA, repulsion effects between the protonated amino functionalities of the SP and the analytes also need to be considered [17, 26]. The higher number of basic functionalities in GLA then translates into an earlier elution within the group of non-esterified insulins due to the repulsion. The same peak order was detected using DEA and 1-AA, even if the low basicity of 1-aminoanthracene probably will not result in a charged state of the amino functionality. Detemir and DEG, carrying fatty acid esterifications, eluted earlier than the other insulins on the neutral SP. That can be explained through steric shielding provided by the lipophilic derivatization, resulting in weaker interactions with the SP. DEG contains an additional free carboxy functionality and a glutamate acid linker. The higher polarity compared to the myristic acid moiety present in DET may explain the later elution of DEG than DET. Interestingly, both eluted later than all other insulins on the amino-derivatized SPs. Stronger lipophilic interactions between the ion-pair of the protonated amino functionality of the SP and the lipophilic tail of DEG and DET or the shielding of the repulsion effects are potential explanations. Notably, a weaker retention of all insulins on the DEA was found. Again, this

may be explained by the repulsion effect. Overall, BEH and DEA performed equally, considering the peak shape and number of smaller peaks. Both performed superior in comparison to the Diol and the 1-AA column. The much earlier elution of the insulins and more prominent shoulders eluting before the main peak, especially for DEG, made the DEA the column of choice for the optimization.

Ammonia was also tested as an additive in combination with the BEH column. Based on previous works [15, 17, 27], a stronger overall retention due to the size of insulin was expected. The lack of MSA as an ion-pairing reagent and the additional deprotonation of the carboxylic functionalities under the usage of ammonia should further increase the retention. Effectively, broader peaks combined with fewer impurities peaks set in a later elution window at the end of the gradient were found for all insulins using ammonia. Thus, this combination was excluded from further evaluation.

Chromatograms and retention time (RT) data of the screening runs are provided in the Supporting Information (see Figure S1, Figure S2 and Table S1).

3.2 | Method optimization

Adding ACN up to 70% to MeOH as the modifier significantly improved the resolution of the fingerprint for smaller peptides (1200 to 1900 Da) caused by a reduced

elution strength in our previous work [12]. Due to the higher molecular weight of insulin, 60% ACN was set as the maximum for the method optimization. Since the future method shall be applicable to all insulins, DEG was chosen as the suitable candidate to reduce the number of optimization runs. It was considered representative for all insulins due to the highest retention and the most dominant shoulder eluting before the main peak. Consecutively, two DoEs were performed (see Table S2).

A linear gradient was run using varying modifier compositions (MeOH/ACN: 100/0, 80/20, 60/40, and 40/60). The column temperature was simultaneously varied (40/50/60°C) to account for a DoE-based workflow. The ranges were set to stay within the instrument's pressure range and the SP's recommended temperature range. A full-factorial approach was applied, resulting in twelve experiments. As observed in our previous study, the addition of ACN resulted in a notable increase in resolution. The range from 20% to 40% ACN in MeOH was most beneficial to improve the resolution of the fingerprint (Figure 3A). As expected from our previous work [12], a lower proportion of ACN was applicable due to the higher chain lengths of the insulins. At higher percentages, peak deformation and weak resolving power were found. The maximization of the number of peaks and the separation of the characteristic impurities via the peak-to-valley ratio (p/v) were chosen as the goals for data evaluation and visualization. An overlay of the contour plots of each response is shown in Figure 3B. Conditions not meeting the goals, as indicated in the individual boxes, are marked as colored areas in the plot. Thus, the white area represents the combination of parameter settings that fulfill the goals. As indicated ("T"), a composition of MeOH/ACN 65/35 and a column temperature of 55°C was the best combination to continue the optimization.

In the second full-factorial DoE, the start%B of the gradient step (X: with experiments at 55/60/65/70%) was varied in combination with the gradient time (Y: 15/25 min), resulting in eight runs. In our previous work [12], the insertion of a gradient step was found to shorten the runtime while maintaining resolution. Thus, the following gradient was prepared: 0–5 min: 30–X% B, 5–Y min: X–80% B. DEG and HUM, the most and least retained insulins within the set of drugs, were used for these experiments to ensure that the final gradient provides a sufficient retention window for all insulins. The improvement in the fingerprints' resolution of DEG and HUM was set as the goal (Figure 3C) via the p/v ratios of characteristic peaks (Figure 3D). The final gradient was defined as 0–5 min: 30%–62% B, 5–20 min: 62%–75% B.

The optimized method was then applied to all insulins (Figure 4). The number of peaks in all samples increased notably compared to the chromatograms obtained during

the screening. The method development protocol proposed in our previous work was successfully applied to the higher molecular weight insulins. Again, the combination of ACN and MeOH in the modifier proved to be highly beneficial in increasing the resolution of the fingerprint, resulting in a single method for all samples.

3.3 | Addition of a CrE

Crown ethers (Figure 5A), macrocyclic oligomers of ethylene oxide, are known for their characteristics as complexing agents for cations, such as charged amino groups (Figure 5B). Used as mobile phase additives, they increased the retention of amino compounds [29–34] and peptides or proteins [35, 36] in RP-LC, with 18C6 being the most popular. The affinity of a CrE to a specific molecule highly depends on its ring size. For example, 18C6 and dicyclohexyl-18C6 are reported to favor different molecules [29, 33]. An inverse effect on retention was observed under SFC conditions when combined with ethanesulfonic acid to analyze AAs [27]. Nevertheless, extensive studies on the application in peptide separations by SFC are missing until now.

After optimizing the chromatographic parameters, the potential of 18C6 to affect the selectivity of the insulins was tested. A reduction of retention was desirable while maintaining the resolution. This may also allow for the accessibility of larger peptides in SFC analysis. The addition of MSA was considered necessary to generate an acidic environment in the eluent [17], which provides protonated amino functionalities of the analyte and enables coordination by the CrE. Thus, the concentration of MSA was maintained. First, the chromatographic impact of the addition of 18C6 on the individual insulin and its degradants was evaluated. A distinct reduction in the retention with an increasing concentration of 18C6 (0 to 4 mM) was found for all analytes. These findings are in line with the results reported for the elution of AAs in SFC [27]. The charged amino functionalities of the analyte are better masked by the CrE than by pure MSA, causing a reduction of the interaction with the SP. An inferior separation was obtained for each insulin and its impurities, as shown in the case of GLU. Solely a slight improvement was achieved for ASP, where adding 2 mM 18C6 increased the separation of a peak pair eluting before the main peak (Figure 6). However, most analytes are impacted equally by the CrE, and lower retention translates into a worse separation.

The elution order of insulin and its analogs can be modified by adding 18C6 from HUM < LIS < GLA < DET < ASP < DEG < GLU over HUM = LIS < ASP < GLA < DET < DEG < GLU to LIS < HUM < ASP < GLA < DET < DEG < GLU

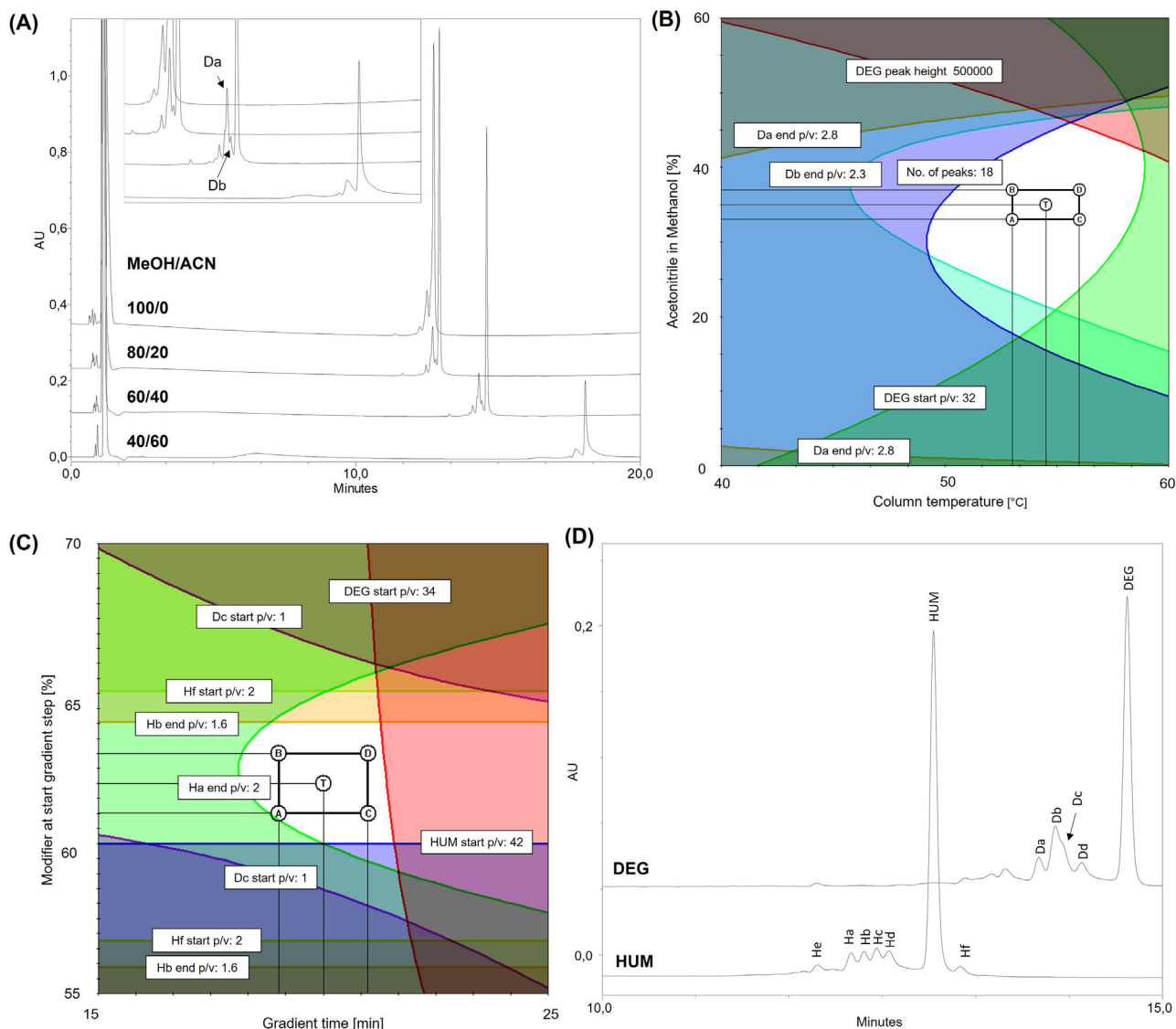

FIGURE 3 Overlay chromatogram applying varying modifier compositions of MeOH/ACN (v/v) to separate insulin degludec (column temperature: 50°C). A zoomed chromatogram is added in the box indicating relevant peaks for the separation (A). Visualization of the impact of the column temperature and modifier composition (B) and gradient “Y” time and start%B at gradient step “X” (C) on the separation of critical peaks. Colored areas indicate conditions under which the defined goals were not achieved (note that mixed colors are possible). Therefore, white areas indicate conditions for achieving the best overall separation. The black box indicates conditions used for further optimization. Exemplary overlay chromatogram of insulin degludec and human insulin combining 60% modifier “X” and 25 min gradient time “Y” (D).

on the DEA column (Figure 7). Lispro and ASP are shifting relatively to the others. In LIS, the AA sequence of HUM is modified by exchanging the Lys positions and the adjacent proline. Lys is preferred in the guest-host complex with 18C6. A shift of its position and binding to 18C6 likely impacts the molecule’s conformation in the mobile phase, causing the change of selectivity. In the case of ASP, no modifications of Lys are involved, but the adjacent proline, which is well known for its impact on the secondary structure of peptides and proteins [37]. The actual conformation of the molecules under SFC

conditions is unknown, but it can be concluded that the conformation might impact the accessibility of Lys. However, GLU, which also involves the shift of the position of a Lys, does not change in elution order. The arginine-rich GLA also remains unaffected, proving 18C6’s affinity for Lys sidechains over arginine. That is in line with other studies showing a higher binding affinity to Lys than to arginine or histidine either as a single AA or in a peptide sequence under MS conditions used in peptidomics [38, 39]. The same was found for the liquid state in RP-LC [35].

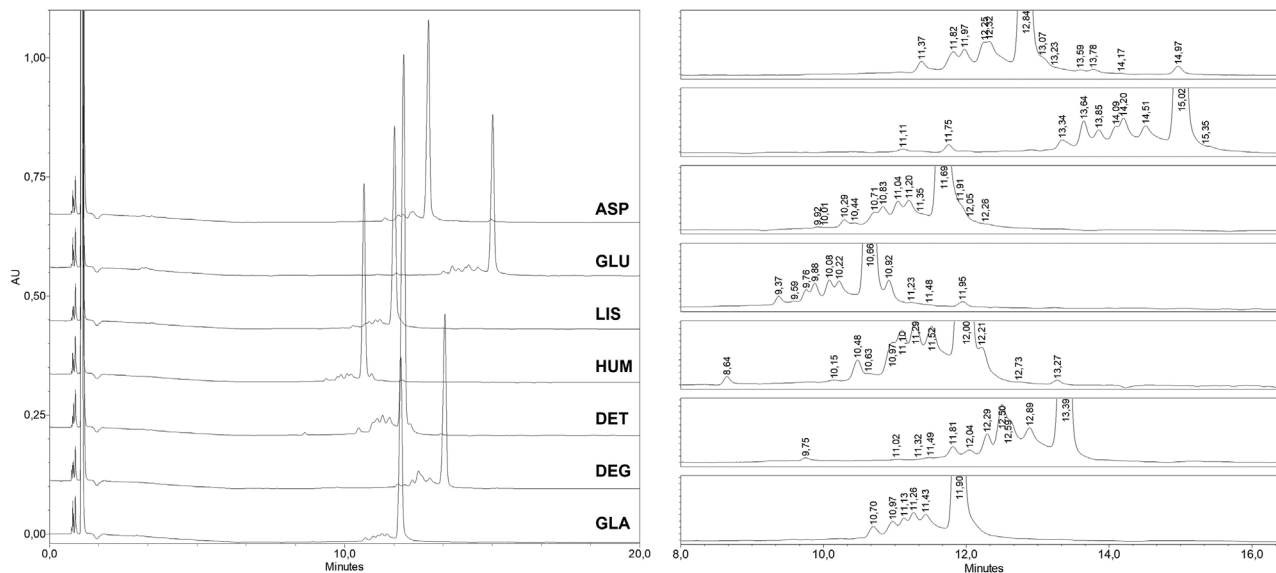

FIGURE 4 Overlay chromatogram of each insulin separated via the optimized method using a DEA column. A zoomed chromatogram is shown on the right.

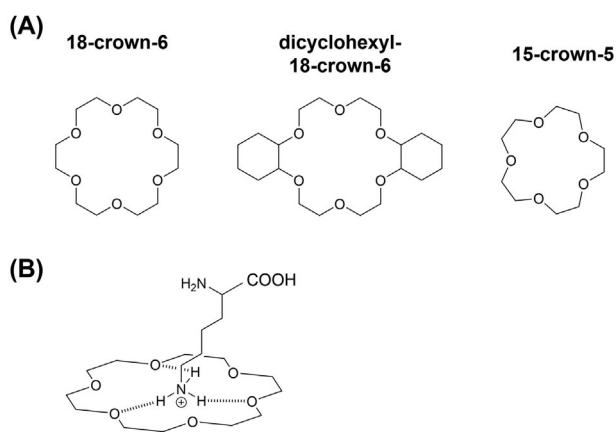

FIGURE 5 Crown ethers (A) and a guest-host complex of lysine with a charged sidechain and 18-crown-6 (B).

The experiment was repeated by applying the same chromatographic conditions, using the BEH column to investigate the effect of the CrE further. Interestingly, the RTs of all insulins were increased, but no change in the elution order was observed by adding 18C6 (Figure 7). Similar results were described before for a normal phase separation of oxindoles and isatins after adding 15-crown-5 [40]. The formation of hydrogen bonds between the residual silanols of the SP and the ether's oxygens was hypothesized. As a result, the cavity of the ether is still accessible to the analyte, but the complex is also bound to the SP, causing higher retention. The inverse effects, either increased or decreased retention based on the type of complex formed, were also described in RP-LC [41]. The formation of three hydrogen bonds between the Lys

sidechain and the cavity of the CrE was explained in the gas phase during gas chromatography analysis [39], allowing free electron pairs of the CrE's oxygens to form additional hydrogen bonds to the SP. In the case of the DEA column, complexes of the analyte (A) + 18C6 or SP + 18C6, and for the BEH column, a complex of 18C6 + SP + A, may be formed, as displayed in Figure 8. The fact that the elution order was not changed on the BEH column can be explained via steric effects. If the complex of 18C6 + SP + A is formed at the N-terminus of the peptide, other AA positions are not accessible and thus do not affect the relative elution. As a result, the retention is increased equally for all insulins.

In conclusion, using 18C6 as an additive in SFC in combination with an amino-derivatized column is a valuable tool to control the selectivity and elution order of different peptides when Lys modifications are present. Our findings may also add value to the separation of synthetic peptides and intermediates. A protected amino function should not be affected by the CrE compared to an unprotected one. In addition, the increase in retention by combining CrE with the BEH column might be helpful for the separation of smaller peptides.

4 | CONCLUDING REMARKS

We successfully applied our method development approach using DoE principles to HUM and six analogs with molecular weights up to 6 kDa. SFC provided sufficient resolution to be applicable as a potential alternative or complementary method for the determination of

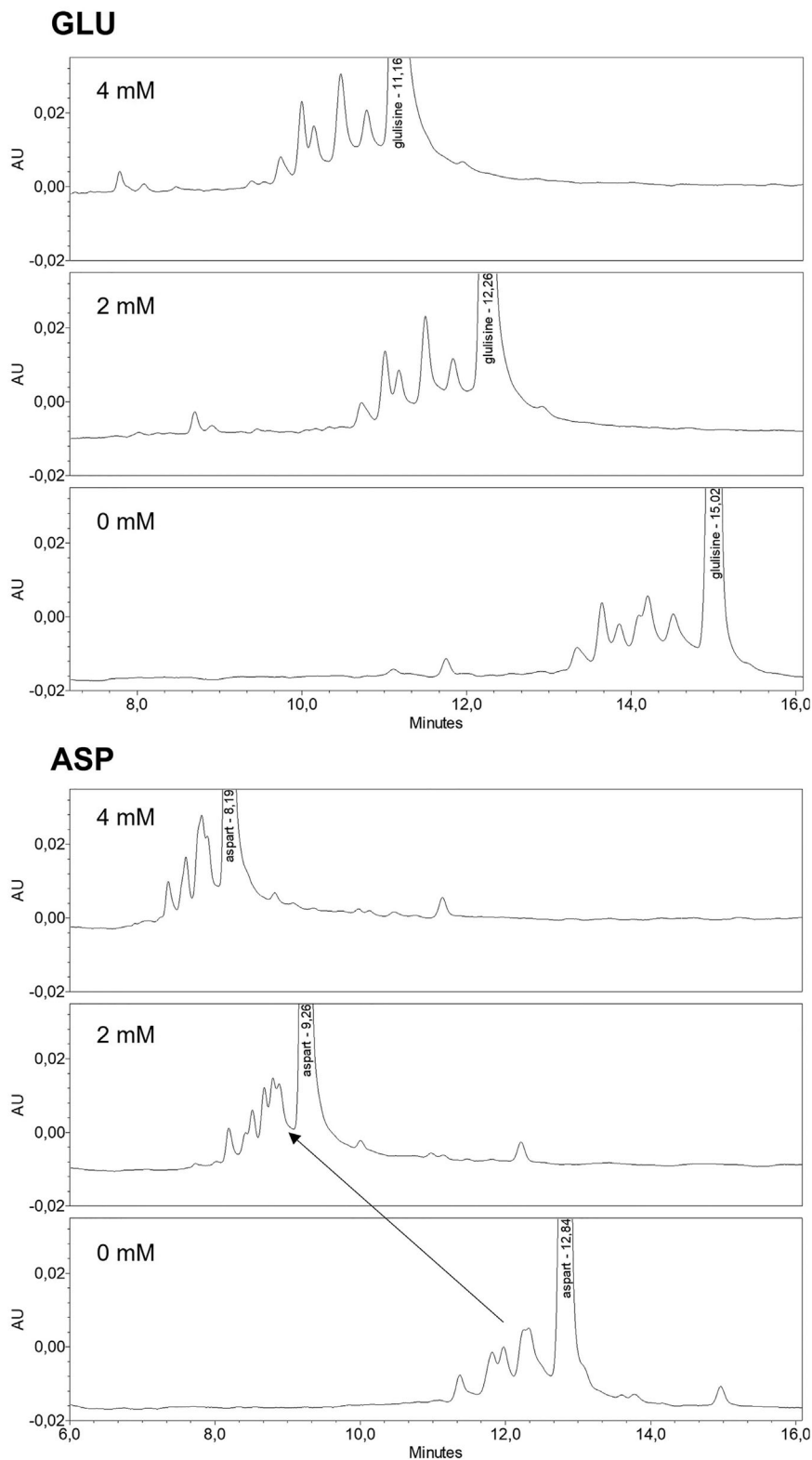

FIGURE 6 Shift in the fingerprint of insulin glulisine and aspart caused by adding 18-crown-6 using a DEA column.

impurities at this mass range. Again, a composition of ACN and MeOH proved beneficial for the separation of peptides in SFC. Additionally, the combination of MSA and 18C6 as additives and an amino-derivatized SP were found to be a suitable tool to control the elution order of the different insulins depending on the position of

Lys. However, from the perspective of purity testing, it did not increase the separation of the main peak and the impurities. When combining 18C6 with a neutral column chemistry, higher retention was achieved, which might be beneficial for smaller peptides showing overall less retention. Our findings will help further understand

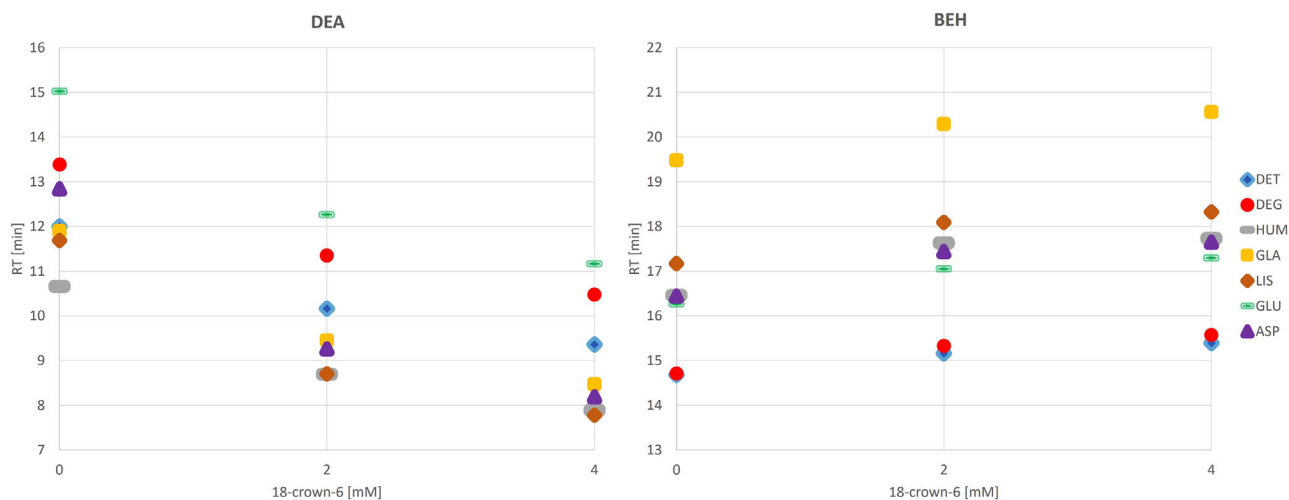

FIGURE 7 Impact of increasing crown ether concentrations on the selectivity for the insulins using a DEA (left) or BEH (right) column.

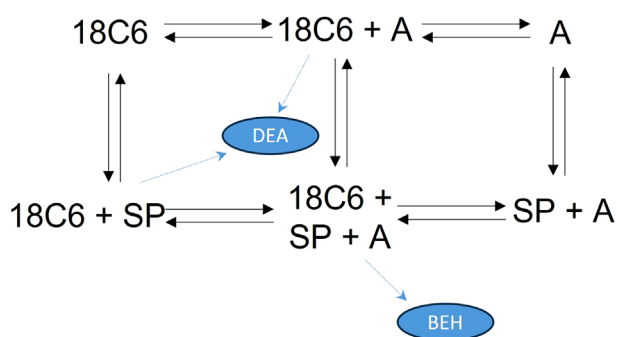

FIGURE 8 Possible complexes between the analyte (A), stationary phase (SP), and 18-crown-6 (18C6) adapted from [41].

the potential SFC as a state-of-the-art technique for the separation of peptide therapeutics.

AUTHOR CONTRIBUTIONS

Jonas Neumann: Conceptualization; methodology; investigation; formal analysis; visualization; writing—original draft. Sebastian Schmidtsdorff: Conceptualization; writing—review & editing. Alexander H. Schmidt: Resources; writing—review & editing. Maria K. Parr: Conceptualization; supervision; writing—review & editing.

ACKNOWLEDGMENTS

Open access funding enabled and organized by Projekt DEAL.

CONFLICT OF INTEREST STATEMENT

The authors declare no conflict of interest.

DATA AVAILABILITY STATEMENT

The data that support the findings of this study are available from the corresponding author upon reasonable request.

ORCID

Jonas Neumann <https://orcid.org/0000-0001-5414-2942>

Alexander H. Schmidt <https://orcid.org/0000-0002-4526-7820>

Maria K. Parr <https://orcid.org/0000-0001-7407-8300>

REFERENCES

- Henninot A, Collins JC, Nuss JM. The current state of peptide drug discovery: back to the future? *J Med Chem*. 2018;61:1382–414.
- Zhang H, Chen S. Cyclic peptide drugs approved in the last two decades (2001–2021). *RSC Chem Biol*. 2022;3:18–31.
- EMA. Guideline on comparability of medicinal products containing biotechnology-derived proteins as active substance—quality issues (revision 1). EMA/CHMP/BWP/247713/2012. 2014. https://www.ema.europa.eu/en/documents/scientific-guideline/guideline-similar-biological-medicinal-products-containing-biotechnology-derived-proteins-active_en-0.pdf
- EMA. Guideline on non-clinical and clinical development of similar biological medicinal products containing recombinant human insulin and insulin analogues. EMA/CHMP/BMWP/32775/2005. 2015. https://www.ema.europa.eu/en/documents/scientific-guideline/guideline-non-clinical-clinical-development-similar-biological-medicinal-products-containing_en-0.pdf
- International Conference on Harmonization. Harmonised tripartite guideline. Quality of biotechnological products: stability testing of biotechnological/biological products. Q5C. 1995. <https://database.ich.org/sites/default/files/Q5C%20Guideline.pdf>
- International Conference on Harmonization. Harmonised tripartite guideline. Specifications: Test procedures and acceptance

- criteria for biotechnological/biological products. Q6B. 1999. <https://database.ich.org/sites/default/files/Q6B%20Guideline.pdf>
- D'Hondt M, Bracke N, Taevernier L, Gevaert B, Verbeke F, Wynendaele E, et al. Related impurities in peptide medicines. *J Pharm Biomed Anal.* 2014;101:2–30.
 - Owens DR, Landgraf W, Schmidt A, Bretzel RG, Kuhlmann MK. The emergence of biosimilar insulin preparations—a cause for concern? *Diabetes Technol Ther.* 2012;14:989–96.
 - Cheung MY, Bruce J, Euerby MR, Field JK, Petersson P. Investigation into reversed-phase chromatography peptide separation systems part V: Establishment of a screening strategy for development of methods for assessment of pharmaceutical peptides' purity. *J Chromatogr A.* 2022;1668:462888.
 - Petersson P, Haselmann K, Buckenmaier S. Multiple heart-cutting two dimensional liquid chromatography mass spectrometry: towards real time determination of related impurities of bio-pharmaceuticals in salt based separation methods. *J Chromatogr A.* 2016;1468:95–101.
 - Molineau J, Hideux M, West C. Chromatographic analysis of biomolecules with pressurized carbon dioxide mobile phases—A review. *J Pharm Biomed Anal.* 2021;193:113736.
 - Neumann J, Schmidtsdorff S, Schmidt AH, Parr MK. Ternary eluent compositions in supercritical fluid chromatography improved fingerprinting of therapeutic peptides. *J Sep Sci.* 2023;46:e2201007.
 - Neumann J, Schmidtsdorff S, Schmidt AH, Parr MK. Application of sub-/supercritical fluid chromatography for the fingerprinting of a complex therapeutic peptide. *J Sep Sci.* 2022;45:3095–104.
 - Molineau J, Hideux M, Hennig P, Bertin S, Mauge F, Lesellier E, et al. Analysis of short-chain bioactive peptides by unified chromatography-electrospray ionization mass spectrometry. Part II. Comparison to reversed-phase ultra-high performance liquid chromatography. *J Chromatogr A.* 2022;1663:462771.
 - Deidda R, Losacco GL, Schelling C, Regalado EL, Veuthey J-L, Guillarme D. Sub/supercritical fluid chromatography versus liquid chromatography for peptide analysis. *J Chromatogr A.* 2022;1676:463282.
 - Molineau J, Hamel Y, Hideux M, Hennig P, Bertin S, Mauge F, et al. Analysis of short-chain bioactive peptides by unified chromatography-electrospray ionization mass spectrometry. Part I. Method development. *J Chromatogr A.* 2021;1658:462631.
 - Losacco GL, DaSilva JO, Liu J, Regalado EL, Veuthey J-L, Guillarme D. Expanding the range of sub/supercritical fluid chromatography: advantageous use of methanesulfonic acid in water-rich modifiers for peptide analysis. *J Chromatogr A.* 2021;1642:462048.
 - Govender K, Naicker T, Baijnath S, Kruger HG, Govender T. The development of a sub/supercritical fluid chromatography based purification method for peptides. *J Pharm Biomed Anal.* 2020;190:113539.
 - Govender K, Naicker T, Baijnath S, Chuturgoon AA, Abdul NS, Docrat T, et al. Sub/supercritical fluid chromatography employing water-rich modifier enables the purification of biosynthesized human insulin. *J Chromatogr B.* 2020;1155:122126.
 - Taguchi K, Fukusaki E, Bamba T. Simultaneous analysis for water- and fat-soluble vitamins by a novel single chromatography technique unifying supercritical fluid chromatography and liquid chromatography. *J Chromatogr A.* 2014;1362:270–77.
 - Antonelli M, Holčapek M, Wolrab D. Ultrahigh-performance supercritical fluid chromatography—mass spectrometry for the qualitative analysis of metabolites covering a large polarity range. *J Chromatogr A.* 2022;1665:462832.
 - Si-Hung L, Izumi Y, Bamba T. First proof-of-concept of UC/HILIC for extending the versatility of the current art of supercritical fluid separation. *Anal Chim Acta.* 2023;1240:340741.
 - Losacco GL, Bennett R, Ahmad IAH, Barrientos RC, DaSilva JO, Dong Y, et al. Dual-gradient unified chromatography: a new paradigm for versatility in simultaneous multicomponent analysis. *Angew Chem Int Ed Engl.* 2022;61(45):e202208854.
 - Kaplitz AS, Mostafa ME, Calvez SA, Edwards JL, Grinias JP. Two-dimensional separation techniques using supercritical fluid chromatography. *J Sep Sci.* 2021;44:426–37.
 - Burlet-Parandel M, Faure K. Opportunities and challenges of liquid chromatography coupled to supercritical fluid chromatography. *Trends Anal Chem.* 2021;144:116422.
 - Raimbault A, Noireau A, West C. Analysis of free amino acids with unified chromatography-mass spectrometry-application to food supplements. *J Chromatogr A.* 2020;1616:460772.
 - Spelling V, Stefansson M. Evaluation of chromatographic parameters in supercritical fluid chromatography of amino acids as model polar analytes and extended to polypeptide separations. *J Chromatogr A.* 2020;1633:461646.
 - Ventura M. Advantageous use of SFC for separation of crude therapeutic peptides and peptide libraries. *J Pharm Biomed Anal.* 2020;185:113227.
 - Nakagawa T, Mizunuma H, Shibukawa A, Uno T. Liquid chromatography with crown ether-containing mobile phases: I. Capacity factors of amino compounds on a hydrophobic stationary phase. *J Chromatogr A.* 1981;211:1–13.
 - Nakagawa T, Shibukawa A, Uno T. Liquid chromatography with crown ether-containing mobile phases: II. Retention behaviour of β -lactam antibiotics in reversed-phase high-performance liquid chromatography. *J Chromatogr A.* 1982;239:695–706.
 - Nakagawa T, Shibukawa A, Uno T. Liquid chromatography with crown ether-containing mobile phases: III. Retention of catecholamines and related compounds in reversed-phase high-performance liquid chromatography. *J Chromatogr A.* 1983;254:27–34.
 - Nakagawa T, Shibukawa A, Murata H. Liquid chromatography with crown ether-containing mobile phases: IV. Role of pH, alkali metal ion and pairing anion in retention of guest substances in reversed-phase high-performance liquid chromatography. *J Chromatogr A.* 1983;280:31–42.
 - Nakagawa T, Murata H, Shibukawa A, Murakami K, Tanaka H. Liquid chromatography with crown ether-containing mobile phases: V. Effect of hydrophobicity and cavity size of the crown ether on retention of amino compounds in reversed-phase high-performance liquid chromatography. *J Chromatogr A.* 1985;330:43–53.
 - Shibukawa A, Nakagawa T, Kaihara A, Yagi K, Tanaka H. Reversed-phase high-performance liquid chromatography of

- substituted anilines utilizing molecular-recognizing ability of crown ether: comparison with ion-pair chromatography. *Anal Chem.* 2002;59:2496–501.
35. Nakagawa T, Shibukawa A, Kaihara A, Itamochi T, Tanaka H. Liquid chromatography with crown ether-containing mobile phases: VI. Molecular recognition of amino acids and peptides. *J Chromatogr A.* 1986;353:399–408.
36. Sheng Q, Wang C, Li X, Qin H, Ye M, Xiong Y, et al. highly efficient separation of methylated peptides utilizing selective complexation between lysine and 18-crown-6. *Anal Chem.* 2020;92:15663–70.
37. MacArthur MW, Thornton JM. Influence of proline residues on protein conformation. *J Mol Biol.* 1991;218:397–412.
38. Chen Y, Rodgers MT. Structural and energetic effects in the molecular recognition of amino acids by 18-crown-6. *J Am Chem Soc.* 2012;134:5863–75.
39. Chen Y, Rodgers MT. Structural and energetic effects in the molecular recognition of protonated peptidomimetic bases by 18-crown-6. *J Am Chem Soc.* 2012;134:2313–24.
40. Colgan ST, Pollard EB. Normal phase separations of substituted oxindoles and isatins with mobile phases containing crown ethers. *J Chromatogr Sci.* 1991;29:433–37.
41. Kartsova LA, Markova OV, Amel'chenko AI. Effect of 18-crown-6 on the separation selectivity of organic compounds by reversed-phase high-performance liquid chromatography. *J Anal Chem.* 2001;56:272–77.

How to cite this article: Neumann J, Schmidtsdorff S, Schmidt AH, Parr MK. Controlling the elution order of insulin and its analogs in sub-/supercritical fluid chromatography using methanesulfonic acid and 18-crown-6 as mobile phase additives. *J Sep Sci.* 2023;46:2300520. <https://doi.org/10.1002/jssc.202300520>