

Russian verbal prefixation

A frame semantic analysis

Yulia Zinova

Empirically Oriented Theoretical
Morphology and Syntax 8



Empirically Oriented Theoretical Morphology and Syntax

Chief Editor: Stefan Müller

Consulting Editors: Berthold Crysmann, Laura Kallmeyer

In this series:

1. Lichte, Timm. Syntax und Valenz: Zur Modellierung kohärenter und elliptischer Strukturen mit Baumadjunktionsgrammatiken.
2. Bîlbîie, Gabriela. Grammaire des constructions elliptiques: Une étude comparative des phrases sans verbe en roumain et en français.
3. Bowern, Claire, Laurence Horn & Raffaella Zanuttini (eds.). On looking into words (and beyond): Structures, Relations, Analyses.
4. Bonami, Olivier, Gilles Boyé, Georgette Dal, Hélène Giraudo & Fiammetta Namer. The lexeme in descriptive and theoretical morphology.
5. Guzmán Naranjo, Matías. Analogical classification in formal grammar.
6. Flick, Johanna. Die Entwicklung des Definitartikels im Althochdeutschen: Eine kognitiv-linguistische Korpusuntersuchung.
7. Crysmann, Berthold & Manfred Sailer (eds.). One-to-many relations in morphology, syntax, and semantics.
8. Zinova, Yulia. Russian verbal prefixation: A frame semantic analysis.

Russian verbal prefixation

A frame semantic analysis

Yulia Zinova



Zinova, Yulia. 2021. *Russian verbal prefixation: A frame semantic analysis* (Empirically Oriented Theoretical Morphology and Syntax 8). Berlin: Language Science Press.

This title can be downloaded at:

<http://langsci-press.org/catalog/book/150>

© 2021, Yulia Zinova

Published under the Creative Commons Attribution 4.0 Licence (CC BY 4.0):

<http://creativecommons.org/licenses/by/4.0/> 

ISBN: 978-3-96110-298-3 (Digital)

978-3-96110-299-0 (Hardcover)

ISSN: 2366-3529

DOI: 10.5281/zenodo.4446717

Source code available from www.github.com/langsci/150

Collaborative reading: paperhive.org/documents/remote?type=langsci&id=150

Cover and concept of design: Ulrike Harbort

Typesetting: Yulia Zinova, Felix Kopecky

Proofreading: Adriana Sabatino, Agnes Kim, Amir Ghorbanpour, Amy Lam,

Ana Afonso, Andreas Hölzl, Andrew J. Spencer, Geoffrey R. Sampson, Jean

Nitzke, Jeroen van de Weijer, Tania Avgustinova, Teodora Mihoc, Tom Bossuyt

Fonts: Libertinus, Arimo, DejaVu Sans Mono

Typesetting software: Xe_{La}T_EX

Language Science Press

xHain

Grünberger Str. 16

10243 Berlin, Germany

langsci-press.org

Storage and cataloging done by FU Berlin

Freie Universität  Berlin

Contents

Acknowledgements	v
Abbreviations	vii
1 Introduction	1
2 A novel approach to the analysis of Russian complex verbs	9
2.1 The Russian aspectual system and biaspectual verbs	9
2.1.1 Basic facts	10
2.1.2 Data	12
2.1.3 Predictions of the existing approaches	18
2.1.4 Diagnostics for aspectual classes	22
2.1.5 A positive test for perfectivity	25
2.1.6 Applying the test	34
2.2 Derivational graph	36
2.2.1 Introduction	36
2.2.2 Definitions	36
2.2.3 Motivation	39
2.2.4 Predicting the aspect of the derived verb	42
2.3 Prefixation and perfectivity	46
2.3.1 Introduction	46
2.3.2 Prefixation of borrowed biaspectual verbs	47
2.3.3 Prefixation of imperfective verbs with a borrowed root	57
2.3.4 Prefixation of native biaspectual verbs	59
2.3.5 Borrowed prefixes	62
2.3.6 Prefixed verbs of motion	64
2.4 Prefixation and telicity	71
2.5 Summary	75
3 Lexical and superlexical prefixes?	77
3.1 Main properties	77
3.2 Classification ambiguity	82

Contents

3.3	Semantics of the derived verb	84
3.4	Secondary imperfectivisation	85
3.5	Argument structure	87
3.6	Position in the stem	91
3.7	Subclasses of superlexical prefixes	92
3.7.1	Intermediate prefixes	92
3.7.2	A three-way distinction	94
3.8	Conclusion	101
4	Semantics of individual prefixes	103
4.1	Semantic approach to verbal prefixation	103
4.2	Scales	106
4.3	<i>za-</i>	111
4.3.1	Semantic contribution	111
4.3.2	Restrictions on the attachment	111
4.3.3	Secondary imperfective	123
4.3.4	Summary	127
4.4	<i>na-</i>	128
4.4.1	Semantic contribution	128
4.4.2	Restrictions on attachment	131
4.4.3	Subsequent imperfectivisation	134
4.4.4	Summary	138
4.5	<i>po-</i>	139
4.5.1	Semantic contribution	139
4.5.2	Restrictions on attachment	144
4.5.3	Subsequent imperfectivisation of a verb with the discussed prefix	148
4.5.4	Summary	153
4.6	<i>pere-</i>	154
4.6.1	Semantic contribution	154
4.6.2	Restrictions on attachment	167
4.6.3	Subsequent imperfectivisation of a verb with the discussed prefix	170
4.6.4	Summary	172
4.7	<i>do-</i>	173
4.7.1	Semantic contribution	173
4.7.2	Restrictions on attachment	177
4.7.3	Subsequent imperfectivisation of a verb with the <i>do-</i> prefix	185
4.7.4	Summary	186

4.8	Secondary imperfective	187
4.9	Summary	188
5	Pragmatics	191
5.1	Previous approaches	192
5.1.1	Inferences associated with the perfective aspect	192
5.1.2	Prefixes: The completive <i>do-</i> and iterative <i>pere-</i>	199
5.2	Evidence against a presuppositional approach	200
5.2.1	Projection out of the antecedents of conditionals	201
5.2.2	Defeasibility	202
5.2.3	“Hey, wait a minute!”	203
5.2.4	Summary	205
5.3	Proposal: Scalar implicature	205
5.3.1	Perfective accomplishments	205
5.3.2	The completive prefix <i>do-</i> and the iterative prefix <i>pere-</i>	206
5.3.3	Testing the scalar properties	208
5.3.4	The empirical study	210
5.3.5	Conclusion	213
5.4	The overall pragmatic picture	214
5.5	Summary	222
6	Frame semantics for prefixes	223
6.1	LTAG and frame semantics	224
6.1.1	TAG	224
6.1.2	Frame semantics	229
6.1.3	Combining TAG and frame semantics	232
6.1.4	Type hierarchy	233
6.2	Frame semantics for the prefix <i>za-</i>	235
6.3	Frame semantics for the prefix <i>na-</i>	244
6.4	Frame semantics for the prefix <i>po-</i>	258
6.5	Frame semantics for the prefix <i>pere-</i>	264
6.5.1	Distributive, crossing and waiting interpretations	264
6.5.2	Excessive interpretation	268
6.5.3	Iterative interpretation	279
6.6	Frame semantics for the prefix <i>do-</i>	283
6.7	Summary	288
7	Implementation of the analysis using XMG	291
7.1	Type hierarchy and constraints	293

Contents

7.2	Lexical anchors	294
7.3	Prefixes	300
7.4	Imperfective suffix	303
7.5	Assembling the parts	303
7.6	Output	310
7.7	Result evaluation and comparison	314
8	Conclusions, remarks and further questions	321
	Appendix A: Frame representations	323
A.1	Constraints	323
A.2	Prefixes	323
A.3	Verbs	326
A.4	Nouns	327
A.5	Measure phrases	328
A.6	Constructors	328
	Appendix B: XMG Implementation	331
B.1	Current analysis	331
B.2	Analysis proposed by Tatevosov (2009)	348
	References	357
	Index	373
	Name index	373
	Subject index	377

Acknowledgements

This book has a long history and I would like to thank all the people that made it possible. It all started with my teacher of Russian language and literature in the mathematics class of Moscow's 57th school, Sergei Vladimirovich Volkov. My decision to study at the linguistics department is due to him and to the organizers of the traditional linguistics competition in Moscow.

During my first year of graduate studies I was lucky to attend a special course on formal semantics by Igor Yanovich that was complemented by a course on presuppositions given by Philipp Schlenker at the summer school in St. Petersburg, organized by John Bailyn. That was the time when I fell in love with formal semantics. Later I was lucky to attend lectures and seminars by Barbara Partee, who provided students in Moscow with knowledge that would not be accessible otherwise. I remember very well the great amount of attention, patience, and respect that always accompanied Barbara's classes.

My passion for formal semantics is complemented by a love of logic, compact formalizations, formal languages and programming. In this respect I would like to specially thank Vladimir Andreevich Uspenskij, for his aim was not only to teach mathematics, but to enhance his students' common sense and cultural background. Apart from the invaluable personal interaction, I learned from him to take responsibility for the clarity of my explanations and to not be afraid of acknowledging my mistakes.

Shortly before finishing my masters studies at Moscow State University I received an email from Barbara Partee advertising a PhD position at Heinrich Heine University in Düsseldorf under the supervision of Laura Kallmeyer. Thank you, Barbara, for playing a special role in my life and thank you, Laura, for taking the risk of accepting a student from Russia.

The last five and a half years that I have dedicated to this work were full of wonderful people. My advisers, Laura Kallmeyer and Hana Filip, guided me through the writing process with patience, encouragement, and valuable advice. I have been extremely lucky to collaborate with two people that are experts in computational and theoretical linguistics, as this work belongs to both domains. I am proud of not giving up either part and this is due to my advisers.

Acknowledgements

I would also like to thank my colleagues at the University of Düsseldorf, especially Daniel Altshuler, Zsofia Gyarmathy, Timm Lichte, Rainer Osswald, Simon Petitjean, and Guillaume Thomas. I am also profoundly grateful to a number of people I met during these years at summer schools, conferences, and colloquiums, as well as to all the anonymous reviewers of the abstracts and papers this work builds upon. I would like to especially thank Lucas Champollion, Emmanuel Chemla, Judith Degen, Michael Frank, Michael Franke, Hans Kamp, Olga Kagan, Daniel Lassiter, Fred Landman, Fabienne Martin, Antje Rossdeutscher, Susan Rothstein, Philipp Schlenker, Gregory Scontras, and Matthijs Westera.

I separately thank my family and especially my son Maxim for their patience during the hard writing periods.

Last, but not least, I thank the German Research Foundation for funding SFB 991 where I have worked for more than four years.

Abbreviations

Glosses

ACC	accusative	INF	infinitive	PASS	passive voice
ACT	active voice	INST	instrumental	PF	perfective
COMP	comparative	IPF	imperfective	PL	plural
CVB	converb	M	masculine	PREP	prepositional
DAT	dative	N	neutral	PRES	non-past tense
F	feminine	NOM	nominative	PST	past tense
GEN	genitive	PART	participle	SG	singular

Glosses (morphemes)

dim	diminutive suffix
imp	imperfective suffix
na, za, pere	prefixes are glossed with their transliterations
refl	reflexive postfix
sem	semelfactive suffix

Subscripts

<i>det</i>	determinate motion verb
<i>indet</i>	indeterminate motion verb
<i>intrans</i>	intransitive
<i>trans</i>	transitive

Acceptability judgements

*	syntactic problem
#	semantic problem
??	discourse problem

1 Introduction

Imagine Anna who studies Russian language and history. She reads a book *Ros-sija, krov'ju umytaja* by Artëm Vesëlyj and comes across the sentence (1).

- (1) Okolo pravlenija, po predloženiju Bantyša,
near administration.SG.GEN along proposal.SG.DAT Bantyš.GEN
dovybirali členu rady.
do.vy.take.imp.PST.PL member rada.GEN

‘Near the administration building, following the proposal by Bantyš, a rada member was being elected.’

Anna looks in her Russian dictionary and does not find the verb *dovybirat'* ‘to finish electing/to elect in addition’ there. What she can find is the verb *vybrat'* ‘to select’ that has one prefix and one suffix less and is perfective. Anna knows that the semantic contribution of the prefix *do-* is similar to ‘finish’, but what she does not know is the aspect of the verb she encountered in (1).

Anna remembers from her Russian classes that one can form perfective verbs by prefixation and imperfective verbs by attaching the imperfective suffix. This case, however, is different, as the verb contains two prefixes and the imperfective suffix. There are, thus, two possibilities for the order of affix attachment: first two prefixes and then the suffix, or one prefix, the suffix, and the other prefix. These two possibilities are, however, associated with different aspects of the derived verb. The questions “What does this verb mean?” and “What is its aspect?” remain unanswered. If *dovybirali* is perfective, it must refer to a completed event of electing. If it is imperfective, it could refer to the process of finishing the elections (which it, in fact, does), or to a repeated event of electing.

Surprisingly, neither Russian grammar and dictionaries, nor the linguistic literature provides a full answer to these questions. For example, the proposals by Svenonius (2004b) and Tatevosov (2007) predict different internal structure and aspect of the verb *dovybirat'*: according to Svenonius (2004b), the prefix *do-* is attached last and the verb is perfective, and according to Tatevosov (2007), both steps of prefixation precede the suffixation, so the verb is imperfective.

1 Introduction

As the predictions of the two proposals do not coincide, it seems an easy task to find out which one is wrong: one has to apply tests that are used to determine the aspect of the verb and check which prediction is correct. These tests are based on the ability of imperfective verbs to receive a progressive interpretation in non-past tense, a habitual interpretation in past tense, and to be combined with the auxiliary verb *budet* ‘will’. All these properties, however, allow to identify perfective verbs only in terms of the absence of imperfective characteristics. The problem is the existence of biaspectual verbs: verbs that, depending on the context, can be used either as perfective or as imperfective. This means that standard tests in principle fail to identify biaspectual verbs, as they pattern together with imperfective verbs.

In Chapter 2 I develop a possible positive test for perfectivity and show that in the case of verbs like *dovybirat* both Svenonius (2004b) and Tatevosov (2007) are to some extent right and wrong at the same time: both derivations (and thus aspects) are possible, but each theory fails to predict their coexistence. Learning from this, in Chapter 2 I not only present new data that is problematic for the existent analyses, but also develop a systematic approach that allows to collect and analyse data independently from the theoretical view on the structure of complex verbs in Russian. I then show that, if this approach is adopted, it provides evidence for structural ambiguity in some cases where no aspectual ambiguity is present, so the class of verbs that require reanalysis with respect to the established syntactic approaches to prefixation is broadened.¹

Another puzzling issue arises in situations where the predictions of different analyses (e.g., Svenonius 2004b and Tatevosov 2007) agree but depend on the interpretation of the prefix. This happens, for example, if the verb contains the imperfective suffix and two prefixes, where the leftmost prefix is *pere-*, as in the verb *perevybirat* ‘to be reelecting/to elect all of’. How can one find out which interpretations are available for the given verb?

Traditional descriptive approaches, adopted in grammars and dictionaries such as Švedova (1982), provide information about the range of interpretations a given prefix may receive, but do not indicate which interpretation applies in which situation, unless the derived verb is itself present in the dictionary. The most extensive and detailed analysis of prefix semantics in formal terms is proposed in the recent book by Kagan (2015). The goal of the study by Kagan (2015) is to unify prefix representations on two levels: first, all prefixes receive scalar semantic analysis and second, each prefix is assigned a common core meaning from which different interpretations can be derived.

¹Parts of Chapter 2 have been published as Zinova & Filip 2013 and Zinova & Osswald 2016.

Kagan (2015), however, does not aim to distinguish between the situations where different submeanings arise, nor to explain prefix combinatorics and interaction with the imperfective suffix. This means that, despite the unified representation, one still cannot derive the exact meaning of the prefixed verb in a given sentence, as this would require more details about how the context influences the interpretation of the verb.

In this work, I provide representations that allow to derive both the aspect and the semantics of a given verb. I also aim to predict which combinations of affixes are possible and to formulate the rules that govern complex verb formation in Russian. According to Švedova (1982), there are 23 productive prefixes in Russian. They can stack and at some point of the derivation process the imperfective suffix can be attached. So, in principle, for each verbal stem there can be more than 20 thousand derived verbs, not taking into account the polysemy of individual prefixes. However, from the point of view of a native speaker, the number of possible derivations seems much more restricted. The primary means of explaining this restriction in the recent proposals is the division of all prefixes into *lexical* and *superlexical*. It originates from the proposal of Isačenko (1960) and is advocated in such contemporary works on Russian prefixation as Ramchand (2004), Svenonius (2004b), Romanova (2006), and Tatevosov (2007; 2009).

The main idea of the division is to assign all verbal prefixes to either lexical or superlexical class. Prefixes that belong to different classes are then associated with distinct structural positions. This allows to significantly limit the number of possible derived verbs. Surprisingly, various authors who agree that dividing prefixes into two classes is crucial for understanding Russian prefixation system do not agree on how to perform this division, a fact already noted by Tatevosov (2009). It turns out that the assignment itself is controversial, because the criteria that are used to identify which class a given prefix belongs to are vague. In Chapter 3, I discuss all of the properties that are typically assigned to verbs of either class and show that no pair among them is true of the same set of prefixes or prefix usages. Based on this, I argue that, despite the differences between the properties of certain prefixes, the view of a strict distinction is problematic and needs to be revised, probably in favour of a continuum between two extremes instead of a discrete classification.

An implicit movement away from a bipartite distinction is, in fact, already present in papers that advocate the lexical/superlexical split: Svenonius (2004b) allows different structural positions for various prefixes of the superlexical class, Tatevosov (2007) argues for an additional class of intermediate prefixes, and Tatevosov (2009) introduces a three-way classification among the superlexical prefixes. However, explicit rejection of the bipartite distinction leads to a radical

1 Introduction

change as it forces us to abandon the hypothesis of distinct structural positions for different prefixes. This hypothesis, in turn, serves as a main limiting force in the syntactic accounts of verbal prefixation in Russian: it allows us to provide a structure of a given complex verb and predict which affix combinations are impossible.

Instead of the criticised syntactic explanation of prefix combinatorics, I propose a formal semantic account that allows to make predictions and block derivations when semantic conflicts occur. In Chapter 4, I prepare the ground for this formalisation: I discuss relevant properties of some of the usages of prefixes *za-*, *na-*, *po-*, *pere-*, and *do-*. The analysis I develop is based on the scalar approach to verbal prefixation, proposed by Filip (2008) and further elaborated by Kagan (2012; 2015). In Chapter 4, though, I mostly discuss data and provide generalisations based on it in order to do the formal modelling in Chapter 6.

Working out the semantic contribution of prefixes makes it necessary to also account for pragmatic meaning components. The literature is inconclusive in this respect: Padučeva (1996) and Romanova (2006) claim that all perfective verbs carry presuppositions, while Kagan (2015) attributes this property only to the prefixes *do-* and *pere-*. In Chapter 5 I discuss these hypotheses. I apply standard tests for presuppositions and show that perfective verbs in general are clearly not associated with a presupposition, as has been already noticed by Grønn (2004).²

Test results, however, do not provide a clear answer with respect to whether the prefixes *do-* and *pere-* carry presuppositions. To find out more, I collected data from native speakers of Russian using a special questionnaire. This questionnaire is based on the results of recent experimental work by Chemla (2009). After doing a statistical analysis of the results, I arrive at the conclusion that the idea of a presuppositional component carried by the prefixes has to be discarded. I then propose to model the observed inferences as entailments in positive contexts and (scalar) implicatures in negative contexts.³

In the same chapter, I discuss another pragmatic issue: the competition of prefixed verbs derived from the same base. I show how, by using underspecified semantics and basic pragmatic principles, one can obtain distinct interpretations of the same prefix depending on the derivational base. Such interpretation variability is traditionally described as polysemy, and the problem of finding which submeaning applies in the particular case has been not accounted for earlier. This part, however, remains at the level of a preliminary proposal and I hope to return to implementing it in future work.

²This is joint work with Hana Filip and published as Zinova & Filip 2015a.

³This is joint work with Hana Filip and published as Zinova & Filip 2014.

After the data analysis conducted in Chapter 4 and Chapter 5, I propose formal semantic representations of the five Russian verbal prefixes in Chapter 6. I show how they combine with the representations of the derivational bases and how the direct object contributes to the interpretation of the verbal phrase. I use a combination of frame semantics and Lexicalised Tree Adjoining Grammars as defined in Kallmeyer & Osswald 2013. The choice of this formal framework is motivated by its flexibility as well as its potential to express semantic restrictions. Another important factor of the framework selection is the possibility to provide an implementation of the analysis.

The idea that drives frame semantics (Löbner 2014) is that frames in the sense of Barsalou (1992) constitute the universal format of representation of concepts. They are recursive attribute-value structures with functional attributes that can also be represented as directed graphs. Let me show the two graphs that emerge from my analysis for the verb *dovybirat'* that Anna could not find in the dictionary.

The first graph, shown in Figure 1.1, represents the semantics of the verb *dovybirat'*^{PF} 'to finish electing' derived from first suffixing the verb *vybrat'*^{PF} 'to elect' and then prefixing it with *do-*. The central node of the frame is of the type *bounded event* and is marked with a double circle. This event is a segment of the bounded event that is denoted by the verb *vybrat'*^{PF} 'to elect'. This is shown by a relation between the two nodes: a thicker arrow in the top part of the figure. These two events share the final stage (finattribute) but have different initial stages (initattribute). The final stage is at the same time the maximum of the event, and the initial point of the derived event does not have to be the minimum of the event. This is interpreted as 'to finish electing'. The frame also contains information related to the arguments and manner of the verb *vybrat'*^{PF} 'to elect', that I have taken from the FrameNet project⁴: manner *choosing*, a set of possibilities, a cogniser, and a chosen that I represent as an attribute of the final stage of the event.

The second frame, shown in Figure 1.2, shares a lot with the first one. However, the crucial difference can be immediately seen: the central node (marked with the double border of the circle) is now of the type *progression*, which provides an indication that the verb is imperfective. This is the case when the imperfective suffix is attached in the last step of the derivation. The derived verb, thus, denotes a partial event of electing that is, in turn, a segment of the whole electing event that contains its final stage. The attributes of the core electing event remain the same.

⁴<https://framenet.icsi.berkeley.edu/findrupal/>

1 Introduction

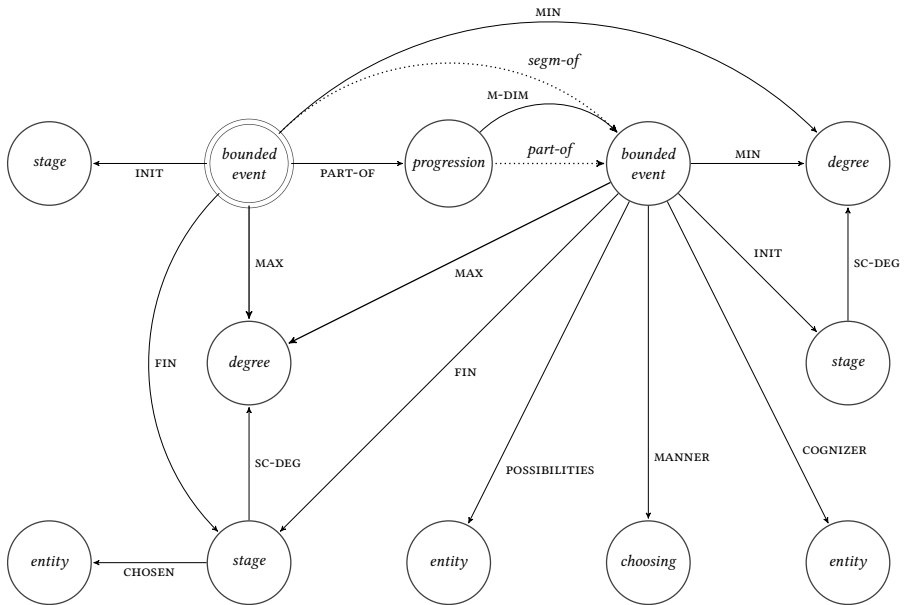

Figure 1.1: Graph representation of the verb *dovybirat*^{2PF} 'to finish electing'

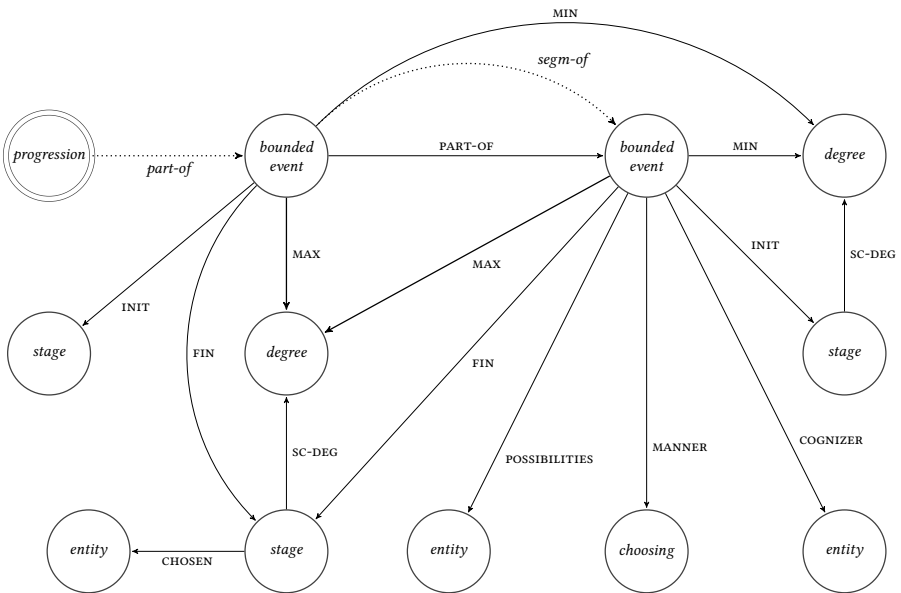

Figure 1.2: Graph representation of the verb *dovybirat*^{1PF} 'to be finishing electing'

The frame semantic analysis of the Russian prefixation system that I develop in Chapter 6 illustrates the power and flexibility of the formalism: with basic and easily readable semantics I manage to not only provide the exact interpretation of a given prefixed verb in context, but also block unwanted derivations of complex verbs, as well as prevent combinations of verbs with inappropriate direct objects and measure phrases.

I then implement the proposal using XMG 2 (Petitjean et al. 2016). In Chapter 7, I show parts of the implementation and discuss the technical details. Due to the current restrictions with respect to the tools available for parsing, I only implement a small fragment that consists of six prefix usages, one verbal base, the imperfective suffix, and one noun that can serve as a direct object, supplying two different scales. The output of the compiler consists of verb models that include various affixes. Each model is accompanied by a tree that shows its internal structure, a set of syntactic properties (including aspect), and a frame that represents the semantics of the verbal phrase. This allows to check the predictions of the account I propose without the risk of overlooking an unwanted derivation or of making a mistake during the derivation of the representation of a complex verb. This is extremely important if one wants to explore verbs that contain three or more derivational affixes.

In order to see how well my analysis does with respect to predicting the (non-) existence of certain affix combinations, I compare the output of my analysis with the proposal by Tatevosov (2009). For this, I implement the syntactic restrictions for prefix attachment for the same grammar fragment. I then analyse all the models produced by the two implementations and calculate precision and recall. The comparison shows that both approaches describe situations with one or two affixes rather accurately, but both precision and recall of the model built following the proposal of Tatevosov (2009) get low values due to the incorrect predictions of the existence of more complex verbs. As for the implementation of the approach I propose, it continues to deliver accurate predictions beyond two affix situations. In addition, the pragmatic reasoning I propose fine-tunes the system and allows to explain the non-existence of extra models produced by the implementation. From this it follows that, with the three component analysis of Russian prefixation that I advocate in this thesis, one can achieve full precision and recall in predicting the existence of complex verbs that are not listed in the dictionaries.

In sum, in this thesis I develop a complex system that allows us to explain Russian prefixation and predict the existence, aspectual properties, and semantics of complex verbs. The crucial idea of the analysis is the interaction between syntax, semantics, and pragmatics. While all the components are kept simple, their combination allows to explain subtle distinctions and cases that seem exceptional

1 Introduction

when all the work is assigned to one linguistic module. An important property of the analysis is the possibility to implement it, which is partially performed in this work.

2 A novel approach to the analysis of Russian complex verbs

This chapter is dedicated to establishing the basis for the rest of the work. I consider the careful accumulation of data to be an essential starting step for any theoretical work. After a brief introduction to Russian aspect, in Section 2.1¹ I show that this step has not been done properly so far. As a consequence, an important bit of data has been missed in the earlier studies on Russian prefixation. Unfortunately, some commonly assumed features of the existing analyses do not allow for this data to be accommodated, and a global revision is required.

To avoid such problems in the future, I start with the data collection methodology. In Section 2.2, I discuss the derivational graph as a structure that allows to find and store the data relevant for the Russian verbal prefixation system. I also show how the derivational graph can be used to identify the aspect of any verb in the graph on the basis of the structure of the incoming edges. As a continuation of this topic, in the third part of the chapter, Section 2.3, I discuss different cases that challenge the common claim that prefixation as the last step of the derivation leads to the perfective aspect of the derived verb. On this basis I update the procedure of determining the aspect of the verb in the graph.

The last topic to be discussed in this chapter is the connection between verbal prefixation, aspect, and telicity, which will be done in Section 2.4.

2.1 The Russian aspectual system and biaspectual verbs

This section is organised as follows. In the first part, Section 2.1.1, I provide basic information about aspect in Russian. In Section 2.1.2 I present new data: a class of prefixed biaspectual verbs constructed according to a productive pattern. Next, in Section 2.1.3, I provide an overview of how such verbs are treated by current theories of Russian prefixation. Afterwards, in Section 2.1.4, I discuss the standard tests used in the literature to determine the aspect of a given verb and show that

¹The data I present in this section and the new test for perfectivity are also published as Zinova & Filip 2013; 2015b.

all of them fail to distinguish between imperfective and biaspectual verbs. In Section 2.1.5 I suggest a new positive test for perfectivity and in Section 2.1.6, this new test is applied to the problematic class of verbs.

2.1.1 Basic facts

Aspectual distinctions are referred to by various names: boundedness (Avilova 1976; Jakobson 1957; Padučeva 1996; Talmy 2000), totality (Forsyth 1970; Bondarko 1971; Comrie 1976; Dickey 2000; Maslov 1965), closure (Timberlake 1982), closed vs. open aspect (Janda 2007), among other names. Traditionally, the term “aspect” (in Russian, *vid*) in Slavic linguistics is used to refer to a grammatical category with two values: perfective and imperfective. In a basic case perfective verbs denote complete situations while imperfective verbs are used to refer to partial situations, habitual events, and states. This said, imperfective verbs can also be used to describe complete events in the past, e.g., when used in “historical present”.

The category of grammatical aspect is related to the morphological structure of the verb. Perfective verbs are assumed to be derived from imperfective ones by means of prefixation, as illustrated in the example (1). This assumption is based on the fact that most morphologically basic verbs in Russian are imperfective (see, e.g., Isačenko 1960; Forsyth 1970). However, a small amount of unaffixed verbs are perfective (Isačenko 1960 lists about 30 of them). Some examples are given in (2).

- (1) pisat'^{IPF} - napisat'^{PF}
'write' - 'write'
- (2) brosit'^{PF}, kupit'^{PF}, dat'^{PF}
'throw' 'buy' 'give'

Perfective verbs can also be derived by other morphological means than prefixation: for example, semelfactive perfective verbs such as those listed in (3) are formed by the attachment of the suffix *-nu-* to the respective imperfective base verbs *prygat'* 'to jump', *morgat'* 'to blink', and *stučat'* 'to knock'.

- (3) прыгнут'^{PF}, моргнут'^{PF}, стукнут'^{PF}
'jump (once)' 'blink (once)' 'knock/hit (once)'

Although prefix attachment is related to a change of the aspect of the verb, it also often leads to a shift in the lexical meaning. When there seems to be no (obvious) shift, the perfective and the imperfective verbs are said to form an *aspectual pair*.

2.1 The Russian aspectual system and biaspectual verbs

In Rosenthal & Telenkova (1976) the following definition of an aspectual pair is given (my translation from Russian):

Definition 1. *An aspectual pair is a pair formed by an imperfective verb and a perfective verb that are lexical-semantically identical.*

An aspectual pair can be formed in the following ways:

1. by suffixation with possible alternations in the verbal stem (ex. (4a));
 2. by prefixation (ex. (4b));
 3. by an alternation of the thematic vowel (possibly with a consonant alternation in the verbal stem, ex. (4c));
 4. stress shift (ex. (4d));
 5. formation from different stems (suppletive aspectual pairs, ex. (4e)).
- (4)
- a. perepisat'^{PF} - perepisyvat'^{IPF}
rewrite - rewrite
 - b. delat'^{IPF} - sdelat'^{PF}
do - do
 - c. vstretit'^{PF} - vstrečat'^{IPF}
meet - meet
 - d. nasýpat'^{PF} - nasypát'^{IPF}
meet - meet
 - e. brat'^{IPF} - vzjat'^{PF}
take - take

From Definition 1 follows that when one member of an aspectual pair substitutes the other, this should not lead to any change in the semantics of the sentence, as is shown in ex. (5).

- (5)
- a. Vasya delal^{IPF} domašneje zadanije.
Vasya didx homework
'Vasya was doing/did his homework.'
 - b. Vasya sdelal^{PF} domašneje zadanije.
Vasya did homework
'Vasya did his homework.'

The pair model view of Russian verbal prefixation leaves those prefixed verbs that are not part of a pair outside of the system. Together with Janda (2007), who argues for a cluster model of Russian verbs, I find the aspectual pair approach

problematic. Instead of talking about pairs, I would use the term *neutral perfective* for the perfective members of traditional aspectual pairs plus some other verbs (verbs that denote an action that terminated after some time, more details provided in Chapter 5). In Chapters 4 and 5 I will show that the Russian prefixation system cannot be described in terms of aspectual pairs, as in order to obtain the interpretation of a given verb one needs to pay attention to other verbs derived from the same base. This (non)-existence of various prefixed verbs also influences whether a particular prefix (e.g., *s-* or *na-*) attachment would lead to the formation of a neutral perfective.

For the moment, however, let us concentrate on the verbs that can be viewed as an extreme case of an aspectual pair: biaspectual verbs. Such verbs can be used both as perfective and imperfective, so they provide a possibility of aspect change with neither semantic change nor formal change.

2.1.2 Data

In this subsection we are going to investigate biaspectual verbs. If one opens a book about Russian verbal aspect, one will most probably read that there are two classes of biaspectual verbs. The first class is a relatively small group of verbs with historically Slavic roots, such as *ženit*^{PF/IPF} ‘to marry (off)’ or *kaznit*^{PF/IPF} ‘to execute,’ *ranit*^{PF/IPF} ‘to wound’. Examples of the usage of the verb *ženit*^{PF/IPF} ‘to marry (off)’ in different aspects are provided in (6). The second class of biaspectual verbs are loaned verbs ending in *-ovat*, such as *arestovat*^{PF/IPF} ‘to arrest’ or *reformirovat*^{PF/IPF} ‘to reform’. The biaspectual nature of the verb *reformirovat*^{PF/IPF} is revealed in the example (7).

- (6) a. Kažetsja, kogda ix ženili^{IPF}, Xalima byla očen’,
 seems when they.ACC marry.PST.PL Xalima be.PST.SG.F very
 očen’ krasivaja.
 very beautiful.SG.F.NOM
 ‘It seems that when they were getting married, Xalima was very, very
 beautiful.’ Andrej Volos, *Sirijskie rozy* (1999)
- b. “Devočki” povydavali doček замуž,
 “girl.PL.NOM” po.vy.give.imp.PST.PL daughter.PL.ACC marry
 ženili^{PF} synovej, stali babuškami.
 marry.PST.PL son.PL.ACC become.PST.PL grandmother.PL.INST
 “Girls” married off their daughters, married off their sons, became
 grandmothers.’ Bella Ezerskaja, *Odessa, Literaturnyj muzej* (2003)

2.1 The Russian aspectual system and biaspectual verbs

- (7) a. Stranno, 10 let reformirovali^{IPF}, i opjat' v
 strange 10 year.PL.GEN reform.PST.PL and again in
 načale?
 beginning.SG.PREP
 'It's strange, they have reformed it for 10 years and are again in the
 beginning of this process?'
<https://iz.ru/news/260299>, accessed on 21.07.21
- b. My reformirovali^{PF} sistemu gosudarstvennoj služby,
 we reform.PST.PL system.SG.ACC public service,
 proveli pensionnuju reformu.
 conduct.PST.PL pensionary.SG.F.ACC reform.SG.ACC
 'We have reformed the public service system, conducted a pensionary
 reform.'
<https://iz.ru/news/268085>, accessed on 21.07.21

Russian morphological tradition treats biaspectual verbs as verbs with syncretic paradigms. According to Galton (1976), Rosenthal & Telenkova (1976), Švedova (1982), Čertkova (1996), Zaliznjak & Šmelëv (2000), and Janda (2007), among others, these verbs can be used as perfective and imperfective verbs, depending in the context. In the case of biaspectual verbs, context and information structure are crucial for aspect determination, as illustrated in the example (8). In the case of sentence (8a), the default reading (with unmarked intonation) is that of an unfolding event (imperfective). As for the second sentence (8b), the default reading is that of a completed event. (In both cases the other aspect is available if the intonation pattern is changed.)

- (8) a. Na central'noj ploščadi kaznili^{IPF} prestupnika.
 on central square hang.PST.PL criminal.SG.ACC
 'On the central square they were hanging a criminal.'
- b. Prestupnika kaznili^{PF} na central'noj ploščadi.
 criminal.SG.ACC hang.PST.PL on central square
 'The criminal was hanged on the central square.'

For more details about the specific properties of both native and loaned biaspectual verbs see, e.g. Isačenko (1960), Avilova (1968), Skott (1979), Gladney (1982), Čertkova & Čang (1998), Jászay (1999), Anderson (2002), Timberlake (2004), and Janda (2007).

To provide some background, let me mention two studies investigating the frequency of native biaspectual verbs relative to loaned ones. According to a statistical study by Čertkova & Čang (1998), borrowed biaspectual verbs constitute

more than 90% of all the biaspectual verbs in Russian. This result is obtained on the basis of the data collected from the Ožegov (1990) dictionary. According to another study, Anderson (2002), completed on the data from the Zaliznjak (1977) dictionary, the percentage of borrowed biaspectual verbs with respect to all biaspectual verbs is even higher, about 95%. It is important to note that these studies are concerned almost exclusively with nonprefixed biaspectual verbs (as these are listed in the dictionaries). So these numbers indicate only how many biaspectual verbs of each type exist in the language as documented by the dictionaries, but not how often each of the two types is used or how productive they are in the derivational morphology system.

What is not included in the above-mentioned studies are prefixed (and suffixed) biaspectual verbs. As is evident from a corpus-based study by Janssen & Borik (2012), such verbs do exist. They do not seem to be very common: in the data that is included in the Open Source Lexical Information Network (OSLIN) for Russian, only 0.25% of the prefixed verbs are biaspectual. However, the database is constructed on the basis of the dictionary data from two explanatory dictionaries: Ušakov (1935–1940) and Ožegov & Švedova (1992), so it is far from exhaustive for the purpose of studying prefixed verbs. Dictionaries cover a range of verbs with a single prefix, but almost never include more complex verbs with stacked prefixes.

Some more information about prefixed biaspectual verbs can be found in the Russian Grammar by Švedova (1982), where it is stated that biaspectual verbs that contain a prefix can be formed by loaned prefixes *de-*, *dis-*, and *re-*, or can be contained among the verbs with other prefixes. As examples Švedova (1982) provides such verbs as *dooborudyvat*^{'IPF/PF} 'to finish equipping,' *nedoispolzovat*^{'IPF/PF} 'to not use to the full extent,' and *pererasxodovat*^{'IPF/PF} 'to spend more than was allowed,' also stating that their quantity is marginal.

I claim that prefixed biaspectual verbs constitute an open class of lexical items, as they can be constructed along productive patterns. Let us for the moment examine one such group², namely, the biaspectual verbs that are formed with the suffix *-iva-/-yva-* and two or more prefixes, where the outermost is the completive:

(9) do-PREF⁺-ROOT-yva-t'

Here are some illustrative examples of the verbs that are constructed following the pattern in (9):

²More groups of biaspectual verbs are provided in Section 2.3.

2.1 The Russian aspectual system and biaspectual verbs

- (10) a. *do-pere-za-pis-yva-t'* 'to finish/be finishing writing down again',
 b. *do-pere-stra-iva-t'* 'to finish/be finishing rebuilding',
 c. *do-vy-š-iva-t'* 'to finish/be finishing embroidering',
 d. *do-za-pis-yva-t'* 'to finish/be finishing writing down',
 e. *do-pere-pis-yva-t'* 'to finish/be finishing rewriting/copying',
 f. *do-za-kaz-yva-t'* 'to finish/be finishing ordering'.

All the components in Scheme (9) are crucial for obtaining a biaspectual verb. First, verbs that contain *do-* as the outermost prefix, but do not contain the imperfective suffix, as in (11), are clearly perfective. Second, verbs where there is no other prefix between the prefix *do-* and the root, as in (12), are imperfective.

- (11) do-PREF⁺-ROOT-t'
 a. *do-pere-pis-a-t'*^{PF} 'to finish writing again',
 b. *do-pere-stro-i-t'*^{PF} 'to finish rebuilding',
 c. *do-za-kaz-a-t'*^{PF} 'to finish ordering'.
- (12) do-ROOT-yva-t'
 a. *do-pis-yva-t'*^{IPF} 'to finish/be finishing writing',
 b. *do-straj-iva-t'*^{IPF} 'to finish/be finishing building',
 c. *do-kaz-yva-t'*^{IPF} 'to prove/be proving'.

Depending in the context, the verbs in (10) are assigned to either the imperfective aspect (examples (13a) and (14a)) or the perfective aspect (examples (13b) and (14b)).

- (13) a. V dannyj moment doperezapisyvaju ešče 2 pesni.
 in given moment do.pere.za.write.imp.1.SG also 2 songs
 'I'm currently finishing rerecording two more songs.' <http://metaruss.ru/forum/index.php?topic=1362.0>, accessed on 24.08.2021
- b. Doperevela "Talisman" Šandmaulej i
 do.translate.PST.F.SG "Talisman" Šandmaul.GEN and
 doperezapisyvala sobstvennye pesni.
 do.pere.za.write.imp.PST.F.SG own songs.
 'I finished translating "Talisman" by the group "Šandmaul" and finished rerecording my own songs.'

In (13a) the verb *doperezapisyvaju* 'I am finishing rewriting' behaves like an imperfective verb, because it has a progressive interpretation triggered by the adverbial *v dannyj moment* 'currently' (standard tests for determining the verbal

aspect are discussed in Section 2.1.4). Another form of the same verb, *dopereza-pisyvala* ‘I finished rerecording’, behaves like a perfective verb in (13b). This is revealed by the conjunction with the perfective verb *doperevela* ‘finished translating’ (see the more detailed explanation in Section 2.1.5).

- (14) a. Ja skol’ko ni doperestraival, ljudi v itoge tratili
I how.much ever do.pere.build.imp.PST.SG.M, people in total spent
bol’she, čem na novuju postrojku.
more than on new bulding.
‘Every time I was rebuilding something, in the end the clients spent more than they would have paid for the new building.’ <https://www.kharkovforum.com/showthread.php?t=1227045>, accessed on 21.07.21
- b. Vot tol’ko traktir doperestraivaju, proekt
here only tavern do.pere.build.imp.PRES.1.SG, project
sdam, diplom poluču...
hand.in.PRES.1.SG, diploma receive.PRES.1.SG
‘I will just first finish rebuilding the tavern, then hand in the project and receive the diploma..’

Elena Berezovskaja, *Traktir pod “znakom kačestva”* (2013)

In (14a) the verb *doperestraival* ‘was finishing rebuilding’ is used as an imperfective verb with an iterative meaning and in (14b) the same verb *doperestraivaju* ‘I will finish rebuilding’ can only be assigned to the perfective aspect because it has future reference in the nonpast tense.

We can also see that verbs with the structure following Scheme (9) behave differently with respect to what is traditionally considered to be a telicity test than verbs that contain either a single prefix and an imperfective suffix or only prefixes (for example, the verbs in (11) and (12)). Verbs with just one prefix and the imperfective suffix like *dopisyvat’* ‘to finish/be finishing writing’, that are clearly imperfective, are incompatible with a prepositional time measure phrase *za α časov* ‘in α hours’ ((15a) is ungrammatical).³ Verbs that do not have the imperfective suffix in their structure and are clearly perfective, as *dozapisat’* ‘to finish writing down/recording’ are not compatible with accusative time measure phrases (see (16)). In contrast to this, verbs like *dozapisyvat’* ‘to finish/be finishing writing down/recording’, that have the structure given in (9), are perfectly

³As pointed out by an anonymous reviewer, in a special context the verb can acquire a planned future interpretation which would allow for a *za*-headed time measure phrase as describing the expected completion time. There is still an asymmetry between (15a) and (17a).

2.1 The Russian aspectual system and biaspectual verbs

acceptable with either accusative or prepositional time measure phrases (both (17a) and (17b) are fine).

- (15) a. *Ja dopisyvaju pesnju za dva časa.
I do.write.imp.PRES.1.SG song in two hours
b. Ja dopisyvaju pesnju uže dva časa.
I do.write.imp.PRES.1.SG song already two hours
'I'm finishing writing the song for two hours already.'
- (16) a. Ja dozapišu pesnju za dva časa.
I do.za.write.PRES.1.SG song in two hours
'I will finish recording the song in two hours.'
b. *Ja dozapišu pesnju uže dva časa.
I do.za.write.PRES.1.SG song already two hours
- (17) a. Ja dozapisyvaju pesnju za dva časa.
I do.za.write.imp.PRES.1.SG song in two hours
'I will finish recording the song in two hours.'
b. Ja dozapisyvaju pesnju uže dva časa.
I do.za.write.imp.PRES.1.SG song already two hours
'I'm finishing recording the song for two hours already.'

I have to note that the variability of the perfective and imperfective uses of bi-aspectual verbs is a matter of some disagreement. Not all the speakers can access both the perfective and the imperfective variant of the verbs in (10). For instance, according to some of the speakers I have consulted with, *dozapisyvat'* 'to be finishing/finish writing down' cannot be used as a perfective verb, i.e., it is not biaspectual. However, such speakers would also agree that the structurally similar verb *dovyšivat'* 'to be finishing/finish embroidering' can, indeed, be used as a perfective verb in contexts like (18).

- (18) Planiruju pristupit' k rabote čerez dve nedeli, kak tol'ko
plan.PRES.1.SG start.inf to work over two weeks, as only
dovyšivaju "Lesnuju zarju".
do.vy.sew.imp.PRES.1.SG "Forest dawn"
'I plan to start the work in two weeks' time; as soon as I will have finished
embroidering "Dawn in the forest"?' eva.ru/R1kYL, accessed on 21.07.21

2.1.3 Predictions of the existing approaches

Let me show how contemporary syntactic accounts of Russian verbal prefixation determine the aspect of the verbs in (10). First I will provide a brief overview of the analyses proposed in the literature (Ramchand 2004; Svenonius 2004a,b; Romanova 2006; Tatevosov 2007; 2009). The key idea that drives syntactic approaches to Russian prefixation is the division of the prefix usages into lexical/internal and superlexical/external. An extensive discussion of this distinction and a detailed overview of the proposals will follow in Chapter 3. What matters now is that superlexical prefixes are claimed (see, e.g., Svenonius 2004b: 229) to not allow the formation of secondary imperfectives, occasionally stack outside (never inside) lexical prefixes, and select for imperfective stems.

In syntactic approaches to Russian prefixation the internal structure of complex verbs is represented by means of syntactic trees. In these trees lexical and superlexical prefixes occupy different positions, and the aspect of the verb is determined by the properties of the highest affix in the structure. For example, according to Svenonius 2004b (see also the summary in Svenonius 2012), complex verbs have the following structure: lexical prefixes originate inside vP ; superlexical prefixes originate outside vP ; lexical and superlexical prefixes that disallow secondary imperfectivisation are separated by Asp in the syntactic structure; and some exceptional superlexical prefixes are merged (sometimes) below the Asp .

Concerning the way the aspect of a complex verb is determined, the following rules, given in Borer (2015), implicitly emerge from Ramchand (2004), Romanova (2004), and Svenonius (2004b):

- (19)
- a. $V \rightarrow \text{imperfective}^4$
 - b. $\text{Prefix} + V \rightarrow \text{perfective}$
 - c. $V + \text{Semelfactive} \rightarrow \text{perfective}$
 - d. $\text{Prefix} + V + \text{S-imperfective/Hab} \rightarrow \text{imperfective}$
 - e. $\text{Prefix} + (\text{Prefix} + V + \text{S-imperfective/Hab}) \rightarrow \text{perfective}$

So it is generally assumed (see (a)) that basic nonaffixed verbs are imperfective (with a closed list of exceptions). When prefixed (b), these verbs become perfective. They also become perfective if a semelfactive suffix is added (c). If a prefixed perfective verb (output of (b)) is suffixed with the imperfective suffix, the aspect of the verb changes to imperfective (d). If a second prefix is added to such a verb, the output is perfective (e).

In further developments we see a shift of focus from the bipartite distinction to the split of the whole class of prefixes into more than just two main classes.

⁴In addition to listed biaspectual and perfective simplex verbs.

Tatevosov (2007), for example, proposes a three-way classification of verbal prefixes, arguing for the existence of intermediate prefixes, in addition to lexical and superlexical ones. The group of the intermediate prefixes is constituted by completive *do-* and repetitive *pere-*. In a later work, Tatevosov (2009) returns to a bipartite distinction between lexical and superlexical prefixes, but subdivides the superlexical class into three groups: selectionally limited prefixes (delimitative *po-*, cumulative *na-*, distributive *pere-*, inchoative *za-*), positionally limited prefixes (completive *do-*, repetitive *pere-*, and attenuative *pod-*), and the left periphery prefix (distributive *po-*).

If we take into account the proposals by Tatevosov (2007; 2009), the schema in (19) is completed with the following rule (f), where (f) must be applied instead of (e) in cases when the outermost prefix is either *intermediate* (Tatevosov 2007) or *positionally limited* (Tatevosov 2009):

- f. (PosLim/ItmPrefix + Prefix* + V) + S-imperfective/Hab →
imperfective

Examples (20) illustrate the application of the corresponding rules in (19).

- | | | | | |
|------|----|---|----|--|
| (20) | a. | pisat' ^{IPF}
write.INF
'to write' | d. | zapisyvat' ^{IPF}
za.write.imp.INF
'to be writing down/to write down' |
| | b. | zapisat' ^{PF}
za.write.INF
'to write down' | e. | nazapisyvat' ^{PF}
na.za.write.imp.INF
'to write down a lot' |
| | c. | prygnut' ^{PF}
jump.semelf.INF
'to jump once' | f. | perezapisyvat' ^{IPF}
pere.za.write.imp.INF
'to be rewriting/to rewrite' |

The summary provided by the rules in (19) reveals the fact that all the existing syntactic approaches predict any given single verb token with a given interpretation to be assigned one aspect (either perfective or imperfective). This comes as a consequence of the fact that the position of each prefix in the syntactic structure is fixed.⁵

To illustrate this point, which is crucial for my purposes, let us take as an example the biaspectual verb *dozapisyvat'* 'to finish writing/to be finishing writing',

⁵The impossibility of having a syntactic ambiguity for a given verb with a fixed interpretation should not be confused with the situation in which the verb has two meanings, i.e., the case of a genuine lexical ambiguity. In such case, all the approaches discussed predict that each meaning is associated with a different syntactic tree.

that follows the pattern (9). Given the predictions of the syntactic accounts of Russian prefixation, summarised under (19), it is clear that these accounts would assign this verb one aspect. At the same time this is exactly the case where different approaches end up with distinct predictions. For such verbs as *dozapisyvat'* 'to finish writing/to be finishing writing,' depending in the theory, either the rule (e) or the rule (f) must be applied.

The verb *dozapisyvat'* 'to finish writing/to be finishing writing' contains the following derivational morphemes: the superlexical prefix *do-* with the completive meaning (see, e.g., Svenonius 2004a for classification), the lexical prefix *za-* with non-compositional semantic contribution, the stem *-pis-* and the imperfective suffix *-yva-*.

Following Svenonius (2004b) and rule (e) in schema (19), we obtain the tree shown on Figure 2.1 for the verb *dozapisyvat'* 'to finish writing/to be finishing writing'. The completive prefix *do-* scopes over the imperfective suffix, so the verb must be assigned the perfective aspect. Note that Svenonius (2004b) does not explicitly discuss the characteristics of the prefix *do-*. However, in Svenonius (2004a) this prefix is classified as being superlexical and Svenonius (2004b) makes general statements about the properties of the class of superlexical prefixes. In sum, this allows us to conclude that the verb *dozapisyvat'* 'to finish writing/to be finishing writing' should be analyzed in the way illustrated by Figure 2.1. The analysis by Ramchand (2004: 357) makes essentially the same predictions.

Contrary to both Svenonius (2004b) and Ramchand (2004), Tatevosov (2007) arrives at a different aspectual classification of the same verb. This is because according to Tatevosov (2007), *do-* occupies a special projection for intermediate prefixes so that the resulting syntactic structure is as on Figure 2.2. As we see, the imperfective suffix is in the highest position and the aspect of the whole verb must be imperfective.

As is shown by the examples above, approaches such as Svenonius (2004b), Ramchand (2004), Romanova (2006), and Tatevosov (2007) predict exactly one syntactic structure for the verb *dozapisyvat'*, as well as for any other verb. This holds even for the most detailed account by Tatevosov (2009). Here the existence of an exceptional group of superlexical prefix uses is postulated. This group is the group of selectionally limited prefixes and includes delimitative *po-*, cumulative *na-*, distributional *pere-* and inchoative *za-*. These prefixes, according to Tatevosov (2009), can take a position "above" or "below" the imperfective suffix as long as the source verb is imperfective (which is not allowed in other approaches). However, this fact does not affect the overall prediction that there is a unique syntactic structure assigned to each given complex verb (with fixed interpretation) due to the selectional restriction.

2.1 The Russian aspectual system and biaspectual verbs

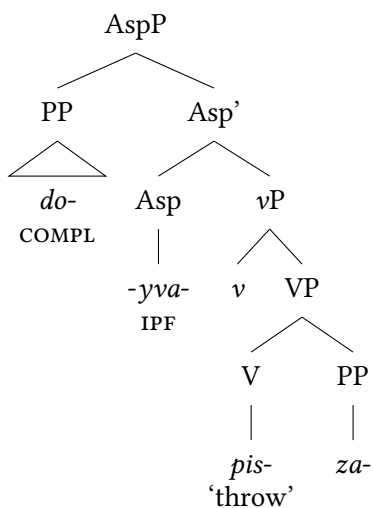

Figure 2.1: Tree for *dozapisyvat'* 'to (be) finish(ing) writing' according to the proposal in Svenonius (2004b)

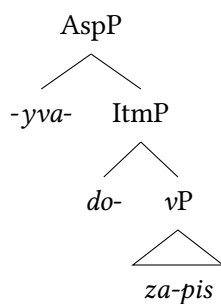

Figure 2.2: Tree for *dozapisyvat'* 'to (be) finish(ing) writing' according to the proposal in Tatevosov (2007)

This conclusion is not immediately obvious, so let us consider an example. Verbs that follow the Scheme (9) contain the imperfective suffix and two prefixes, the outermost of which, *do-*, is, according to Tatevosov (2009), selectionally limited (can only be attached to a formally imperfective verb). As selectionally limited prefixes can appear either higher or lower than the imperfective suffix, there seems to be a potential for the structural ambiguity. Examples of such verbs are *zazapisyvat'* 'to start writing down/recording' and *nazapisyvat'* 'to write down/record a lot'. It turns out that for such verbs there is a unique order of affix attachment possible, as the second prefix cannot be attached earlier than the imperfective suffix because of the selectional restriction.

One exception to the rule "one verb – one structure" is a modification of Tatevosov (2009) sketched in Tatevosov (2013b) that seems to implicitly react to problematic examples first mentioned in Zinova (2012). Tatevosov (2013b) proposes that the completive prefix *do-* (for a certain group of Russian speakers) does not have any restrictions on its attachment. If, however, such modification is adopted without further restrictions, the predicted class of biaspectual verbs ends up being too large. This problem may be solvable, but, as no solution is offered by the author, I will not discuss this proposal further.

In sum, the notion of a structural position is helpful in motivating at least certain facts about the formation of complex verbs (as shown by example (20)). For this reason syntactic approaches were a necessary step in the process of understanding Russian prefixation system. However, the problematic part of these approaches is that, as I have shown, they exclude the existence of biaspectual affixed verbs. The reason for this is that the postulated structural assumptions force a given complex verb to be assigned exactly one structure. This structure, in turn, determines the aspect of the verb independently of any other factors. An attempt to overcome the "one verb – one structure" restriction without subdividing the class of superlexical prefixes even further (Tatevosov 2013b) leads to massive overgeneration. The problem, in my view, lies in the assumption of a strict distinction between lexical and superlexical prefixes. In Chapter 3 we will discuss in detail properties that are assigned to each class and I will show that there is no evidence for a strict classification, as each property is true of a different set of prefix usages.

2.1.4 Diagnostics for aspectual classes

Several tests are commonly used to establish the aspect of a given verb in Russian. Surprisingly, all of them are designed to exclude the possibility that it is perfective. Hence, they focus on the negative formal properties of perfective verbs. The following test set is provided by Schoorlemmer (1995):

2.1 The Russian aspectual system and biaspectual verbs

- (21) (i) perfective verbs *do not* get an “ongoing” interpretation in nonpast tense;
(ii) perfective verbs *cannot* be used as complements of phasal verbs (e.g., *načat* ‘to begin’);
(iii) perfective verbs *cannot* form present participles.

2.1.4.1 Non-past tense reading test

This test is concerned with the interpretation possibilities for verbs with present tense morphology. Perfective verbs, as illustrated by (22b), cannot receive present progressive interpretation, as opposed to imperfectives (22a).

- (22) a. Vasja pišet^{IPF} pis'mo.
Vasja write.PRES.3.SG letter
‘Vasja is writing a letter.’
b. Vasja napišet^{PF} pis'mo.
Vasja na.write.PRES.3.SG letter
‘Vasja will write a letter.’

2.1.4.2 Phase verbs

There is a group of verbs that can take either nominals or infinitives as their complements. These verbs are called *phase verbs*. In Borik (2002) the following list of such verbs is provided:

- *načinat* ‘begin’
- *prodolžat* ‘continue’
- *zakančivat* ‘finish’
- *končat* ‘finish’
- *perestavat* ‘stop’

The test uses the fact that only imperfective verbs can be complements of the phase verbs, as illustrated by (23).

- (23) a. Vasja načal pisat'^{IPF}/*napisat'^{PF} pis'mo.
Vasja began write.INF letter
Vasja began writing a letter
b. Maša zakončila čitat'^{IPF}/*pročitat'^{PF} knigu.
Masha finished read.INF book
Masha finished reading the book

2.1.4.3 Present participles

Borik (2002) offers a test for perfectivity based on the fact that present participles can only be derived from imperfective verbs. There are four kinds of participles in Russian, as shown on Table 2.1. They are characterised by two properties: tense (present or past) and voice (active or passive).

Table 2.1: Verbal participles in Russian

	active	passive
present	čit-a-jušč-ij ‘reading’	čit-a-em-yj ‘being read’
past	čit-a-vš-ij ‘reading’ (past); pro-čit-a-vš-ij ‘having read’	čit-a-nn-yj ‘being read’ (past); pro-čit-a-nn-yj ‘having been read’

Present active participles (PAPs) are more common than present passive participles, so they are more convenient to use for aspect testing. As they denote ongoing progressive events, they can only be formed from imperfective stems. Examples (24) and (25) illustrate how the test can be applied: (24a) shows the formation of a present active participle of the imperfective verb *čitat* ‘to read’. Example (24b) shows that in case of the perfective verb *pročitat* ‘to read through’ such formation is not possible.⁶ Example (25) illustrates the same distribution for the verbs *pisat*^{’IPF} ‘to write’ and *napisat*^{’PF} ‘to write down’.

- (24) a. čit-a-jušč-ij
 read^{’IPF}.PAP.SG.M
 reading
 b. *pro-čit-a-jušč-ij
 pro.read^{’PF}.PAP.SG.M

⁶There are, however, some participles that are formed from perfective verbs and are widely accepted (although not included in the literary norm), such as *zainteresujuščij* ‘that will interest you’ as evidenced by (i).

(i) vy možete samostojatel’no zapisat’ sja i poseščat’ zainteresujuščij
 you.NOM can on your own za.write.INF.REFL and visit.INF za.interest.PAP.SG.M
 vas kurs
 you.ACC course.ACC
 ‘you can on your own inscribe and visit a course that you will find interesting’
<https://www.nstu.ru/entrance/answers/view?num=39005>, accessed on 21.07.21

- (25) a. piš-ušč-ij
 write^{IPF}.PAP.SG.M
 writing
 b. *na-piš-ušč-ij
 write^{PF}.PAP.SG.M

2.1.5 A positive test for perfectivity

As we have just seen, perfective verbs are commonly distinguished from imperfectives by tests that specify the properties that perfectives fail to have. While these tests delimit perfective verbs, they cannot distinguish between imperfective and biaspectual verbs. Based on the previous aspect research, there seem to be two more possible candidate tests for perfectivity: one relies on past passive participle formation and the other makes use of the properties of the narrative sequence.

According to the first potential test, past passive participles (PPPs) can only be formed from perfective verbs. For example, in the pairs of verbs shown in (26) while the perfective member sanctions the derivation of a PPP (27b), the imperfective one is not supposed to do so (27a).

- (26) gruzit'^{IPF} → zagruzit'^{PF}
 'to load' 'to load completely'
 (27) a. gruzit'^{IPF} ↗ *gružennyj
 'to load'
 b. zagruzit'^{PF} → gružennyj
 'to load' 'loaded'

However, matters are not as simple as that. As has been pointed out by Schoorlemmer (1995), this test is applicable only to transitive and aspectually paired verbs. Specifically, according to Schoorlemmer, no perfective verbs with superlexical prefixes form aspectual pairs, which makes the test of little help for our purposes. Second, Romanova (2006) provides a number of counterexamples of past passive participles derived from imperfective verbs, among others (28).

- (28) kolonna avtomašin, gružennyx bumažnymi
 column.NOM car.PL.GEN loaded.PART.PASS.PST.PL.GEN paper.PL.INST
 paketami
 bags.INST
 'a string of cars, loaded with paper bags' = ex. (9c) in Romanova (2006: 5)

2 A novel approach to the analysis of Russian complex verbs

As a consequence, the PPP formation test appears to be neither reliable nor general enough.

The second possible positive test is connected to the phenomenon of aspectual pairs and to the contribution of the verbal aspect to the narrative sequence. Both are evoked in connection with what is referred to as the *Maslov criterion*, which first appears in the following formulation (Maslov 2004: 76–77):

“Pri perevide povestvovanija iz ploskosti prošedšego vremeni v ploskost’ istoričeskogo nastojaščego vse glagoly kak SV, tak i NSV, okazyvajutsja uravennymi v formax nastojaščego vremeni NSV.” [When the narrative is transformed from the past into the historical present, all the verbs, both perfective and imperfective, result in present tense forms of imperfective verbs.]

However, the specific reference to Maslov’s work is typically not given when the criterion is applied. Here is a citation from Mikaeljan et al. (2007: 1), who provide one of the clearest formulations:

“A perfective and an imperfective verb can be considered an aspectual pair if and only if the imperfective verb can be substituted for the perfective verb in situations (such as descriptions of reiterated events or narration in historical present) where the latter is not allowed.”

Mikaeljan et al. (2007) illustrate the above with the following contrast:

- (29) a. Prišel^{PF}, uvidel^{PF}, pobedil.^{PF}
come.PAST.SG.M, see.PST.SG.M, conquer.PST.SG.M
‘I came, I saw, I conquered.’
- b. Prixožu^{IPF}, vižu^{IPF}, pobeždaju.^{IPF}
come.PRES.1.SG, see.PRES.1.SG, conquer.PRES.1.SG
‘I come, I see, I conquer.’

The sentence (29a) describes a sequence of events in the past, suggesting that each event was completed before the next started. Now, if the speaker wants to represent the same state of affairs in the historical present or as a habitual situation (their “reiterated event”), due to independently motivated constraints on the Russian aspectual system, only the corresponding⁷ imperfective verbs can be used, as in (29b).

⁷“Corresponding” is understood as the imperfective verb that constitutes the aspectual pair in the traditional sense with the original perfective verb.

2.1 The Russian aspectual system and biaspectual verbs

It is plausible to approach biaspectual verbs by considering them as a kind of a covert aspectual pair and then apply the Maslov criterion in order to find them. One of the verbs that are often cited as a paradigm example of a native biaspectual verb is *kaznit'* 'to execute'. If the verbs in (30a) and (30b) can be thought of as constituting an aspectual pair, then the verb *kaznit'* 'to execute' in two different aspects in (30c) might be thought of along the same lines, but of course in (30c) the alleged members of the aspectual pair just happen to be not phonologically differentiated.

- (30) a. *pisat'*^{IPF} → *napisat'*^{PF}
 'to write' 'to write'
 b. *zapisat'*^{IPF} → *zapisyvat'*^{PF}
 'to write down' 'to write/be writig down'
 c. *kaznit'*^{IPF} → *kaznit'*^{PF}
 'to execute' 'to execute'

When one applies the test, illustrated by (29), to *kaznit'* 'to execute', one can see that it can be used in the narrative sequence (31a). This seems to suggest that it behaves like a perfective verb. The same verb can be used in the historical present or the habitual situation context, strongly suggesting that in (31b) *kaznit'* 'to execute' behaves like an imperfective verb.

- (31) a. *Prišel*^{PF}, *uvidel*^{PF}, *pobedil*^{PF}, *kaznil*^{PF}
 come.PST.SG.M, see.PST.SG.M, conquer.PST.SG.M, execute.PST.SG.M
 vragov.
 enemies
 'I came, I saw, I conquered, I executed the enemies.'
 b. *Prixožu*^{IPF}, *vižu*^{IPF}, *pobeždaju*^{IPF}, *kaznju*^{IPF}
 come.PRES.1.SG, see.PRES.1.SG, conquer.PRES.1.SG, execute.PRES.1.SG
 vragov.
 enemies
 'I come, I see, I conquer, I execute the enemies.'

This would seem to be in compliance with the Maslov criterion, as formulated by Mikaeljan et al. (2007). Therefore, (31) seems to indicate that biaspectual verbs like *kaznit'* 'to execute' could be treated as covert aspectual pairs: in (31a) the verb is perfective, while in (31b) it is imperfective.

However, in the same contexts (narrative sequence and historical present/habitual situation) it is also possible to use imperfective verbs like *dumat'* 'to think', as illustrated by the examples (32a) and (32b).

2 A novel approach to the analysis of Russian complex verbs

- (32) a. Prišel^{PF}, uvidel^{PF}, pobedil^{PF}, dumal^{IPF}
 come.PST.SG.M, see.PST.SG.M, conquer.PST.SG.M, think.PST.SG.M
 o buduščem.
 about future
 ‘I came, I saw, I conquered, I thought about the future.’
- b. Prixožu^{IPF}, vižu^{IPF}, pobeždaju^{IPF}, dumaju^{IPF}
 come.PRES.1.SG, see.PRES.1.SG, conquer.PRES.1.SG, execute.PRES.1.SG
 o buduščem.
 about future
 ‘I come, I see, I conquer, I think about the future.’

This shows that such contexts cannot be used as diagnostics for perfectivity and imperfectivity. The Maslov criterion requires a perfective verb as an input condition, so it is also negative for perfectivity. It allows to delimit the class of exclusively perfective verbs, but does not allow to distinguish between biaspectual and imperfective verbs. In (31) the same verb is used in both sentences due to its biaspectual nature. At the same time the possibility of using the same verb in both sentences in (32) is explained by the imperfective aspect of *dumal* ‘thought’ in the first sentence. Moreover, there are other conceptual problems related to the application of the Maslov criterion.⁸

The crucial point to be made here is that no reliable positive test for perfectivity has been proposed so far.⁹ Figure 2.3 schematically represents the aspectual classes of Russian verbs. The standard tests listed in (21) are negative for perfectivity. They merely exclude the possibility that a given verb form is a member of Set 1. To separate the subset of biaspectual verbs (Set 3) from true imperfective verbs (Set 2), we need a positive test for perfectivity (Set 1). In combination with the standard tests, we can then identify the class of the biaspectual verbs.

The new positive test for perfectivity proposed in Zinova & Filip (2013) capitalises on the notion of the *Narration relation*, defined by Lascarides & Asher (1993) as follows:

⁸Mikaeljan et al. (2007: 2) write that “rather than a tool for establishing aspectual pairs, the Maslov criterion should be taken as a definition and *raison d’être* of the aspectual correlation.”

⁹A new proposal to overcome this problem has been recently offered by Piperski (2016). The author suggests using gerund forms to identify the aspect of the verb, as each verb that is not biaspectual has exactly one gerund form, “which denotes simultaneity for imperfective verbs and precedence for perfective verbs” (p. 5). Moreover, the imperfective and perfective gerunds are formally distinguishable, as the former one is marked by the *-a/-ja* suffix, whereas the latter uses the *-v/-vši* suffix. It turns out that biaspectual verbs can form the gerund in both ways, which allows us to identify them. The only drawback of this test is that, as the author notes himself, it does not work for all verbs, but only for those that contain the suffix *-ova-* or the suffix *-a-* (and does not work with verbs whose stems end in *-e-* and *-i-*).

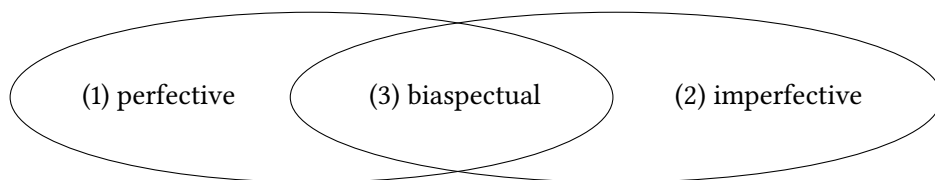

Figure 2.3: Aspectual classes

Narration(α , β): The event described in β is a consequence of (but not strictly speaking caused by) the event described in α . If *Narration* (α , β) holds, and α and β describe eventualities e_1 and e_2 , respectively, then e_1 occurs before e_2 .

The *Narration* relation can be illustrated by (33):

- (33) Max woke up. He opened the window.

In English, it is natural to use telic verb phrases in non-progressive tense in the *Narration* relation. A parallel Russian example (34) contains two perfective verbs. It is well-known in the literature on aspect and discourse structure that the main line of a narrative is constituted by sequences of perfective verb forms which move narrative time forward (for Russian, see in particular Padučeva 1996; 2004).

- (34) Maksim prosnulsja^{PF}. On otkryl^{PF} okno.
 Maksim woke.up.PST.SG.M.refl he open.PST.SG.M window.SG.ACC
 ‘Maksim woke up. He opened the window.’

The property the test relies on is that if the *Narration* relation holds and the second verb is perfective, the aspect of the first verb must be perfective as well. Example (35) demonstrates that the combination of an imperfective and a perfective verb is uninterpretable. Under the most normal assumptions about how situations in the world take place, people do not open the windows while sleeping, nor is the event of opening a window normally interpreted as result or a continuation of the waking up event. Given that, the only possible relation between the two events (waking up and opening the window) is *Narration*.

- (35) ??Maksim prosypalsja^{IPF}. On otkryl^{PF} okno.
 Maksim woke.up.imp.PST.SG.M.refl he open.PST.SG.M window.SG.ACC
 ‘Maksim was waking up. He opened the window.’¹⁰

¹⁰The English translation of this discourse seems to be much better than the Russian original. This effect is probably due to the different range of possible interpretations of the verbs *prosy-pat'sja* ‘to wake up’ and *to wake up*. The Russian verb *prosypat'sja* ‘to wake up’ can only refer to the period before getting out of bed.

2 A novel approach to the analysis of Russian complex verbs

Table 2.2: Verbal aspect and the *Narration* relation

Verbal combination		Acceptability judgment
perfective verb	<i>i</i> 'and' perfective verb	ok
imperfective verb	<i>i</i> 'and' perfective verb	?? ^a
biaspectual verb	<i>i</i> 'and' perfective verb	ok

^aI use this sign to indicate a problem on the discourse level.

The idea of the test is summarised in Table 2.2. Zinova & Filip (2013) propose to use as test contexts sentences like (36) and (37). The task is to enforce the *Narration* relation between the two clauses (see more details below). In this case if the verb in the second clause is perfective, the first verb must be perfective as well. Example (36) is in the non-past, whereas (37) – in the past tense. This shows that tense is not relevant for the purpose of the test. Note that this is not to deny that the *Narration* relation may also hold in sequences with imperfective verbs only, as in (38).

- (36) a. Ja s^{em}em^{PF} zavtrak i pojdu^{PF} na rabotu.
 I s.eat.PRES.1.SG breakfast and po.go.PRES.1.SG on work
 'I will finish my breakfast and go to work.'
- b. ??Ja em^{IPF} zavtrak i pojdu^{PF} na rabotu.
 I eat.PRES.1.SG breakfast and po.go.PRES.1.SG to work
- (37) a. Ja s^{el}el^{PF} zavtrak i pošel^{PF} na rabotu.
 I s.eat.PST.SG.M breakfast and po.go.PST.SG.M on work
 'I finished my breakfast and went to work.'
- b. ??Ja el^{IPF} zavtrak i pošel^{PF} na rabotu.
 I eat.PST.SG.M breakfast and po.go.PST.SG.M to work
- (38) Uže 8:00. Ja em^{IPF} zavtrak i idu^{IPF} na rabotu.
 already 8:00. I eat.PRES.1.SG breakfast and go.PRES.1.SG to work
 'It is already 8:00. I eat breakfast and go to work.'

Examples (36a) and (37a) illustrate the first line of the table, (36b) and (37b) – the second line of the table. (36b) and (37b) are not interpretable, because neither the *Narration* relation nor any other coordinating relation, e.g., a *Background* relation, can be construed.

Examples (39) illustrate the third line of the table above, which is crucial in case of biaspectual verbs. In a given context, *kaznit'* 'to execute' can behave ei-

2.1 The Russian aspectual system and biaspectual verbs

ther as a perfective or as an imperfective verb. Given that in the test context imperfective verbs are odd, biaspectual verbs pattern together with perfective verbs. Thus, the proposed test context allows us to distinguish between biaspectual and imperfective verbs.

- (39) a. Palač kaznit prestupnika i pojdět^{PF}
 hangman execute.PRES.3.SG criminal and po.go.PRES.3.SG
 domoj.
 home
 ‘The hangman will execute the criminal and will go home.’
- b. Palač kaznil prestupnika i pošel^{PF} domoj.
 hangman execute.PST.SG.M criminal and po.go.PST.SG.M home
 ‘The hangman executed the criminal and went home.’

Now that the basic workings of the test are explained, let me address the precise conditions under which it works as a positive test for perfectivity. To enforce the *Narration* relation, the following conditions are required to be met:

1. The main lexical verb in the second clause must have a temporal extent.
2. The event denoted by the main lexical verb in the second clause must not be caused or considered a continuation of the event denoted by the main lexical verb in the first clause.
3. The clauses must be conjoined using plain conjunction *i* ‘and’ without any temporal or modal (epistemic) adverbial.

The conditions above reveal the workings of the test. When the clauses headed by two verbs, where the second one is perfective, are conjoined with *i* ‘and’ (condition 3), several coordinating discourse relations can be established between them. Conditions 1 and 2 ensure that such coordinating relations as Background or Cause are excluded. After this the only possible relation between the two clauses is Narration. If the Narration relation cannot be established, the discourse is infelicitous, as in (36b) and (37b).

The reason for the first condition is that verbs denoting punctual events could be construed as describing events that are temporally located within the time span of the first event. In such a case, it is not the Narration (but the Background) relation that holds between the two clauses, and thus the rule expressed in the last line of the table above (Table 2.2) is not applicable, as illustrated by (40). This condition is relevant if the test is applied in the past tense.

2 A novel approach to the analysis of Russian complex verbs

- (40) Ona igrala^{IPF} v futbol i slomala^{PF} nogu.
 she play.PST.SG.F in football and break.PST.SG.F leg
 ‘While she was playing football, she broke her leg.’
- (41) Ona xorošo igrala^{IPF} i zarabotala^{PF} nagradu.
 she well play.PST.SG.F and za.work.PST.SG.F reward
 ‘She was playing well and earned a reward.’

Examples like (41) show the importance of the second condition: if the events denoted by the two main verbs are connected, the discourse relation is not one of Narration. According to Txurruka (2003), the natural language conjunction ‘and’ marks a coordinating relation, which means is a relation of Narration, Background, Result, Continuation, Parallel or Contrast (Asher & Vieu 2005). To ensure a proper application of the test, one has to establish a context where the Narration relation is the only possible one between the two events.

On the basis of the observation by Txurruka (2003) that Narration is marked by *then*, I propose to use the substitution of *potom* ‘then’ instead of *i* ‘and’ to check whether it is in fact Narration that connects the two coordinated clauses. If it is, then the meaning of the two sentences is (nearly) identical (compare (36) with (42a)). If it is not, the meaning changes significantly after such a substitution. To see this, compare (40) with (42b) and (41) with (42c): the sentences in (42b) and (42c) suggest that the second event is not caused or explained by the first one. These examples also illustrate why *potom* ‘then’ cannot be used for the purposes of the test directly: it establishes the Narration relation even in case of the different aspects of the main verbs in the two clauses.

- (42) a. Ja s”em^{PF} zavtrak, potom pojdu^{PF} na rabotu.
 I s.eat.PRES.1.SG breakfast then po.go.PRES.1.SG on work
 ‘I will finish my breakfast, then I will go to work.’
- b. Ona igrala^{IPF} v futbol, potom slomala^{PF} nogu.
 she play.PST.SG.F in football then break.PST.SG.F leg
 ‘She was playing football, then she broke her leg.’
- c. Ona xorošo igrala^{IPF}, potom zarabotala^{PF} nagradu.
 she well play.PST.SG.F then za.work.PST.SG.F reward
 ‘She was playing well, then she earned a reward.’
- (43) a. Ja em^{IPF} zavtrak. Pojdu^{PF} na rabotu.
 I eat.PRES.1.SG breakfast po.go.PRES.1.SG to work
 ‘I’m eating breakfast. I will go to work.’

2.1 The Russian aspectual system and biaspectual verbs

- b. ?Ja em^{IPF} zavtrak i potom pojdu^{PF} na
 I eat.PRES.1.SG breakfast and afterwards po.go.PRES.1.SG to
 rabotu.
 work
 ‘I’m eating breakfast and will go to work afterwards.’
- c. ?Ja em^{IPF} zavtrak i objazatel’no pojdu^{PF} na
 I eat.PRES.1.SG breakfast and necessarily po.go.PRES.1.SG to
 rabotu.
 work
 ‘I’m eating breakfast and I of course will go to work.’
- d. Ja em^{IPF} zavtrak. Potom pojdu^{PF} na rabotu.
 I eat.PRES.1.SG breakfast afterwards po.go.PRES.1.SG to work
 ‘I’m eating breakfast. I will go to work afterwards.’

Examples under (43) demonstrate why the second condition is important: a sequence of two sentences without a conjunction or any explicit adverbial indicating their connection, as (43a), is acceptable in an appropriate context (for example if someone is asked about his plans; a pause will be present between the two sentences in such a case). Sentences (43b) and (43c) are at least much better than (36b) and (37b). The last sentence, (43d), is completely natural. In these cases the Narration relation between the two clauses holds. In (43b) and (43d) it is explicit due to the presence of *potom* ‘then’ which, as mentioned above, is a marker of the Narration relation. As the idea of the test is to exclude all the coordinating relations (the coordinating requirement is imposed by *i* ‘and’, so it must be present) except for Narration and see whether this relation can be established given that the verb in the second clause is perfective, it is important to not include an explicit marker of this relation in the test context and, because that would force its application. Substituting *i* ‘and’ with *potom* ‘then’ destroys the test context, as the Narration relation is enforced independently from the aspect of the verbs heading the clauses, as is evidenced by (44).

- (44) Ja em^{IPF} zavtrak, potom pojdu^{PF} na rabotu.
 I eat.PRES.1.SG breakfast afterwards po.go.PRES.1.SG to work
 ‘I’m eating breakfast, afterwards I will go to work.’

A similar situation is observed in the past tense: (45a) is perfectly acceptable in a context in which the speaker remembers what he or she did on a given occasion, but only if there is a distinct pause between the two sentences; for (45b), there do not seem to be any clear judgments; and (45c) is a plausible discourse.

2 A novel approach to the analysis of Russian complex verbs

- (45) a. Ja eI^{IPF} zavtrak. Pošel^{PF} na rabotu.
 I eat.PST.SG.M breakfast. po.go.PST.SG.M to work
 ‘I was eating breakfast. I went to work.’
- b. ?Ja eI^{IPF} zavtrak i potom pošel^{PF} na rabotu.
 I eat.PST.SG.M breakfast and afterwards po.go.PST.SG.M to work
 ‘I was eating breakfast and went to work afterwards.’
- c. Ja eI^{IPF} zavtrak. Potom pošel^{PF} na rabotu.
 I eat.PST.SG.M breakfast. Afterwards po.go.PST.SG.M to work
 ‘I was eating breakfast. I went to work afterwards.’

Such examples should suffice to illustrate the basic intuition behind the test. The main idea of the test is the generalisation given by Jespersen (1924) that, if the verb is imperfective, it does not trigger narrative progression (in our case it is the verb in the first clause). Theoretically speaking, the relevant background for the workings of the test is best outlined in Altshuler (2012). His account of the discourse properties of the Russian imperfective relies on a multi-coordinate approach to aspect. He proposes interpretations for the NARR operator and for the aspectual operators and explains why only perfective verbs are acceptable in (46a) (ex. (73-a) in Altshuler 2012), which is an example similar to our test context.

- (46) a. Lev ko mne ^{OK}priexal^{PF} / #priezžal^{IPF}
 Lev to me pri.arrive.PST.3.SG / pri.arrive.imp.PST.3.SG
- b. i srazu pošel^{PF} kušat’.
 and right.away po.go.PST.3.SG eat
 ‘Lev arrived at my place and went to eat right away.’
 (73-a) in Altshuler (2012)

2.1.6 Applying the test

Now let us apply the test to the verbs *dopisyvat’* ‘to finish/be finishing writing’ and *dozapisyvat’* ‘to finish/be finishing recording’. According to the syntactic theories, one aspect is always assigned to both verbs: either perfective (Ramchand 2004; Romanova 2004; Svenonius 2004b) or imperfective (Tatevosov 2007; 2009). However, as examples (47) and (48) show, these two verbs pattern differently with respect to the narration relation test. If the verb *dopisyvat’* ‘to finish/be finishing writing’ is inserted in the test context in the non-past tense, as in (47a), or in the past tense, as in (48a), both sentences are infelicitous. When the same contexts are populated with the verb *dozapisyvat’* ‘to finish/be finishing recording’, both resulting sentences are non-problematic.

2.1 The Russian aspectual system and biaspectual verbs

- (47) a. ??Ja dopisyvaju tekst i pojdu^{PF} domoj.
 I do.write.imp.PRES.1SG text and po.go.PRES.1SG home
- b. Ja dozapisyvaju disk i pojdu^{PF} domoj.
 I do.za.write.imp.PRES.1SG CD and po.go.PRES.1SG home
 ‘I will finish recording the CD and go home.’
- (48) a. ??Ja dopisyval tekst i pošel^{PF} domoj.
 I do.write.imp.PST.SG.M tekst and po.go.PST.SG.M home
- b. Ja dozapisyval disk i pošel^{PF} domoj.
 I do.za.write.imp.PST.SG.M CD and go.PST.SG.M home
 ‘I finished recording the CD and went home.’

Examples (49b) and (50b) show that the same results as for *dozapisyvati* are obtained for other verbs formed following the same pattern for biaspectual verbs (9). A good example is the verb *dovyšivat* ‘to finish embroidering’. Notice that a verb with the same root but without the inner prefix *vy-*, namely, *došivat*, ‘to finish/be finishing sewing’, is not acceptable in the test context, as shown by examples (49a) and (50a).

- (49) a. ??Ja došivala platje i podarila^{PF} ego sestre.
 I do.sew.imp.PST.SG.F dress and po.present.PST.SG.F it sister
 ??‘I was finishing sewing this dress and I presented it to my sister.’
- b. Ja dovyšivala kartinu i povasila^{PF} eë.
 I do.embroid.imp.PST.SG.F picture and po.hang.PST.SG.F it
 ‘I finished embroidering the picture and hung it (on the wall).’
- (50) a. ??Ja došivaju platje i podarju^{PF} ego sestre.
 I do.sew.imp.PRES.1SG dress and po.present.PRES.1SG it sister
 ??‘I am finishing sewing this dress and I will present it to my sister.’
- b. Ja dovyšivala kartinu i povasila^{PF} eë.
 I do.embroid.imp.PST.SG.F picture and po.hang.PST.SG.F it
 ‘I finished embroidering the picture and hung it (on the wall).’

To summarise, I have shown that the verbs formed according to the pattern in (9), e.g., *dozapisyvati* ‘to finish/be finishing recording’, behave like verbs that are traditionally considered biaspectual (e.g., *kaznit* ‘to execute’) and are intractable in the syntactic approaches.

2.2 Derivational graph

2.2.1 Introduction

As we have seen in the previous section, the existing approaches to Russian prefixation do not account for the full range of prefixed verbs data. Moreover, they often do not agree on the data or some important datapoint is missing or disregarded. This section is dedicated to the description of a structure that allows to reach an agreement on the prefixation data and easily check the proposed generalisations, if a database, organised according to the definition provided here, is implemented. Material presented in this section is partially covered in Zinova & Filip (2015b).

In the last part of this section, Section 2.2.4, I will show how the aspect of the verb can be easily predicted if we have the derivational graph, which is proposed here, at hand. In most cases such prediction is possible for a verb that is stored in the graph node exclusively on the basis of the information about the incoming edges. The cases where additional information (such as the aspect of the verb in the parent node) may be needed are discussed in Section 2.3.

2.2.2 Definitions

As we have seen in the previous chapter, some prefixed verbs can be derived in various ways. I propose to observe these possibilities carefully before excluding some of them that, at first glance, do not fit neatly into the common model of verbal prefixation.

The notion of a “derivational chain” used here is inspired by Karcevski (1927) who proposed that “[1]a valeur aspective d’un verbe dépend de la place qu’il occupe dans la chaîne de la dérivation déverbative” [the aspectual value of a verb depends on its place in the chain of verbal derivation].

In the spirit of Karcevski (1927), the basic idea I pursue here is to infer the aspectual value (perfective or imperfective) of a given verb form from the derivational chain,¹¹ rather than from the pure syntactic structure, as it is done in contemporary syntactic analyses. I also want to put forward the idea that the derivational chain does not have to be unique for a given verb. To formalise Karcevski’s (1927) suggestions about what constitutes a derivational chain, I propose the following definition:

Definition 2. *A verb V_2 is derived from a verb V_1 if and only if*

1. *both V_1 and V_2 are attested in the language;*

¹¹In Zinova & Filip (2015b) we call it *derivational history*.

2. there is a morphological operation (the extensive list of such operations is provided by Švedova 1982) such that it takes as an input the verb V_1 and provides as an output the verb V_2 ;
3. the meaning of V_2 can be monotonically (possibly not entirely compositionally) derived from the meaning of V_1 ;
4. there is no other verb V_3 such that V_3 is derived from V_1 and V_2 is derived from V_3 .

To illustrate the above definition of a derivational chain, let us consider the verbs *kupit*^{PF} and *pokupat*^{IPF} ‘to buy’. There are three possible ways in which these verbs might be related, shown in (51).

- (51)
- a. *kup-i-t*^{PF} → **po-kup-i-t* → *po-kup-a-t*^{IPF}
to buy → ... → to buy/to be buying
 - b. *kup-i-t*^{PF} → *po-kup-a-t*^{IPF}
to buy → to buy/to be buying
 - c. *kup-i-t*^{PF} *→ *kup-a-t*^{IPF} *→ *po-kup-a-t*^{IPF}
to buy *→ to bathe *→ to buy/to be buying

The derivation in (51a) is excluded, because **pokupit*’ does not exist (violation of the first condition). The derivation in (51b) is fine with respect to the first and the second conditions, so what we have to check for is the third condition. I.e., that there is no other verb such that it is derived from *kupit*^{PF} ‘to buy’. A candidate verb, formally speaking, would be *kupat*^{IPF}, but it has an unrelated meaning ‘to bathe someone’ (violation of the third condition). This also means that (51c) cannot be considered to constitute a derivational chain.

As we have just seen, the second chain, (51b), is a valid derivational chain, according to the three conditions above. However, it includes simultaneous (happening at one derivational step) attachment of two morphemes (the prefix *po-* and the suffix *-a-*). In this work I will not deal with such derivations that include a simultaneous addition of two or more morphemes (including cases of prefixation accompanied by the addition of the postfix) or discontinuous morphemes. I will limit myself to providing a computational account of verbal derivational morphology only for derivations that include an attachment of a single morpheme at each derivational step.

To provide an extension to the example (51), let us also consider the candidate derivational chains for the verb *napokupat*’ ‘to buy a lot’, presented in (52). The first candidate chain, (52a), demonstrates a violation of the third condition: there exists another verb (*pokupat*’ ‘to buy/be buying’) such that it is derived from the verb *kupit*’ ‘to buy’ and serves as a derivational base for obtaining the verb

2 A novel approach to the analysis of Russian complex verbs

napokupat ‘to buy a lot’. So, despite the fact that the verb *napokupat* ‘to buy a lot’ is (indirectly) derived from the verb *kupit* ‘to buy’, the derivation in (52a) is not a valid derivational chain. On the other hand, the chain in (52b) is a derivational chain, according to the definition above, although only the second step of it will receive an analysis in this work.

- (52) a. $\text{kup-i-t}^{\text{PF}} \rightarrow \text{na-po-kup-a-t}^{\text{PF}}$
to buy → to buy a lot
- b. $\text{kup-i-t}^{\text{PF}} \rightarrow \text{po-kup-a-t}^{\text{IPF}} \rightarrow \text{na-po-kup-a-t}^{\text{PF}}$
to buy → to buy/to be buying → to buy a lot

There is also another way to represent and store the information carried by the derivational chains, that is useful for computational purposes: a graph. Let us consider the following directed graph D :

Definition 3. $D = (V, A)$, where V is a set of nodes labeled with verbs that are attested in the language and A is a set of ordered pairs of nodes. $\forall x, y \in V, (x, y) \in A$ iff the verb that labels the node y can be derived from the verb that labels the node x (according to the Definition 2).

In what follows, I will call such graph D a *derivational graph*. Paths in this graph are derivational chains that are defined by Definition 2. The number of connected components of the graph D equals the number of verbal stems in the object language.

There exists a graph that is similar to the derivational graph described here. It represents derivational relations between Russian verbs and is a part of the OSLIN database¹², described in Janssen & Borik (2012). The problem with this graph is that it is far from being complete, as the lexical items included are taken from dictionaries and, as we have already discussed, this covers a relatively small amount of prefixed verbs and almost none of the multiply prefixed verbs.

Let me also mention another database of Russian prefixed verbs¹³ provided by the CLEAR (Cognitive Linguistics: Empirical Approaches to Russian) group at the University of Tromsø. According to the description on the website, “[t]his database contains information on 1,981 imperfective verbs in Russian that form aspectual pairs via prefixation”, aggregating entries from Evgen’eva (1999), Ožegov & Švedova (2001), and Cubberly (1982) that were approved by a panel of native speakers. This database, however, was constructed for the purpose of exploring the “empty” prefixes and thus is not a full derivational graph as it contains only verbs that form aspectual pairs (imperfective and perfective verbs with the same lexical meaning) via prefixation.

¹² Open source lexical information network, available online at

¹³ Available at <http://emptyprefixes.uit.no/>

2.2.3 Motivation

Let me provide some motivation for the decisions made with respect to the (non) inclusion of the certain types of potential edges in the graph. The notion of a derivation graph can be understood in different ways. For the broader picture, one may want to have a full graph with all the possible connections. Such a graph will include edges connecting the nodes occupied by the verbs that are possibly semantically related but the relation is not evident for a native speaker (removing the third condition). Another option is a graph with all the connections as long as the verbs are semantically connected. If no restriction on the complexity and the direction of morphological transitions is imposed, forms that are not directly derived from each other will be connected, and the resulting structure will be a collection of “nests”, not “chains” (removing the fourth condition). Such a structure, for example, is discussed in Janda 2010. A more restricted graph can also be useful: for example, a graph where only the most transparent relations are marked (those where semantic transitions are compositional).

Another graph is extracted from the dictionary data by Janda (2007) for her analysis of the structure of aspectual clusters (for a restricted list of verbs). For each source verb, Janda lists not all the derived verbs but only one or two for each of the categories she distinguishes (Natural, Specialised, Complex Act, and Single Act Perfectives), thus reducing the complexity of the graph. In addition, the graph can be either directed or non-directed.

The graph I propose to use is one with “chain” structures, which means that only direct connections are present and the nodes that can be reached through the transitive relations are not additionally directly connected. The second important point is that these chains will later be used to learn the rules of aspectual changes that happen at one derivational step. That is why it is good to include more relations, even those with non-compositional semantic steps. On the other hand, it does not make sense to include those transitions where the semantic relation between the verbs is not transparent at all: as this is not a regular process, such verbs are listed in the dictionaries and do not allow for generalisations.

I have decided to include also the derivations with simultaneous attachment of multiple affixes. They are not analysed here, but among such derivations there are cases that must be taken into consideration in future work. For instance, it is claimed that some prefixes are attached simultaneously with postfixes. An example of such prefix is the cumulative *na-*: if it is attached to the verb *jest* ‘to eat’, two verbs can be derived: *najest’sja* ‘to eat until becoming full’ and *najest* ‘to gain fat in some part of the body as the result of eating’ (colloquial). The semantics of the first verb cannot be monotonically derived from the semantics of

2 A novel approach to the analysis of Russian complex verbs

the second one, as the component of gaining fat would have to be absent in the derived verb ((53a) is not a derivational chain). So we have to accept that the verb *najest'sja* 'to eat until becoming full' is derived directly from the verb *jest* 'to eat' by simultaneous attachment of the prefix and the postfix, as illustrated by the chain (53b). Such verbs are not studied in this work, so I propose to include them in the derivational graph, but set them aside for the moment.

- (53) a. $es-t^{IPF} \rightarrow na-es-t^{PF} \xrightarrow{*} na-es-t'-sja^{PF}$
to eat \rightarrow to gain fat $\xrightarrow{*}$ to eat until becoming full
- b. $es-t^{PF} \rightarrow na-es-t'-sja^{PF}$
to eat \rightarrow to eat until becoming full

The derivational graph, built in accordance with Definition 3, would be a perfect starting point for the investigation of the individual prefixes, as one could use derivational chains for making generalisations. For example, it would be easy to check whether a certain prefix allows a subsequent imperfectivisation or can be attached on top of the other prefix: would only have to check the properties of the verbs that are connected with the edges labeled with the prefix in question in the derivational graph.

Consider the verb *pisat* 'to write' and the verb *dopisyvat* 'to finish writing'. There is only one possible path from the verb *pisat* 'to write' to the verb *dopisyvat* 'to finish writing' in the derivational graph fragment illustrated by Figure 2.4. This path is written as a derivational chain under (54a). Although the nodes for another way, shown in (54b), are present in the derivational graph, one of the edges (between the verb *pisat* 'to write occasionally' and the verb *dopisyvat* 'to finish/be finishing writing') is missing because of the semantic restriction (third condition in Definition 2).

- (54) a. $pisat^{IPF} \rightarrow dopisat^{PF} \rightarrow dopisyvat^{IPF}$
to write \rightarrow to finish writing \rightarrow to finish/be finishing writing
- b. $pisat^{IPF} \rightarrow pisyvat^{IPF} \rightarrow dopisyvat$
to write \rightarrow to write occasionally \rightarrow to finish/be finishing writing

The fragment of the derivational graph, presented on Figure 2.4, provides evidence for the hypothesis that, if a verb contains both the prefix *do-* and the imperfective suffix, it is imperfective. However, this hypothesis is quickly rejected on the basis of the other part of the graph: if one searches through the paths from the verb *pisat* 'to write' to the verb *dozapisyvat* 'to finish/be finishing writing down/recording', one finds two different derivational chains in the derivational graph, as shown in Figure 2.5. The first derivational chain, linearised in (55a),

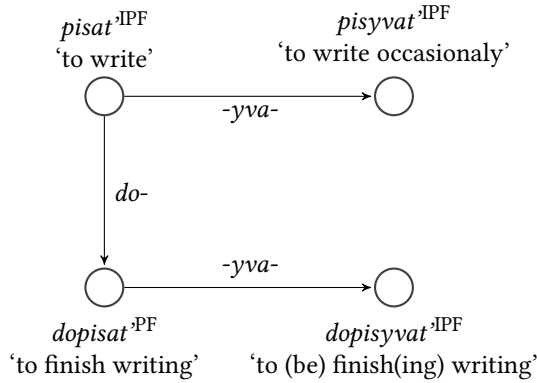

Figure 2.4: A fragment of the derivational graph: *pisat* 'to write'

provides evidence against the proposed hypothesis, as the verb at the end of this chain is perfective and contains both the imperfective suffix and the prefix *do-*.

- (55) a. $pisat^{IPF} \rightarrow zapisat^{PF} \rightarrow zapisyvat^{IPF} \rightarrow dozapisyvat^{PF}$
 to write \rightarrow to record \rightarrow to (be) record(ing) \rightarrow to finish recording
- b. $pisat^{IPF} \rightarrow zapisat^{PF} \rightarrow dozapisat^{PF} \rightarrow$
 to write \rightarrow to record \rightarrow to finish recording \rightarrow
 $dozapisyvat^{IPF}$
 to (be) finish(ing) recording

The example above is just one illustration of how a derivational graph defined by Definition 3 can be used to check possible generalisations about the properties of Russian prefixed verbs. Such a graph, however, does not exist in the form of a human-created resource¹⁴ and some researchers doubt even the possibility of writing it down in an overt form. For example, Janda (2007: 625) claims that “exhaustive listings of verbs would be unwieldy, and, given the ad-hoc open-class nature of Specialised Perfectives and Complex Acts, such lists could never be definitive”. Janda (2007: 626) also regards most of the verbs that are not listed in the dictionaries and constructed spontaneously by the speakers not to be a core part of the verbal cluster.

I do not agree with the claim about the marginal status of such verbs and consider them one of the core components of the Russian verbal system. Moreover, I claim that there is a way to construct a derivational graph defined above. To do

¹⁴The graph itself exists by definition, so what I mean here is some resource that stores this graph and allows to extract information from it.

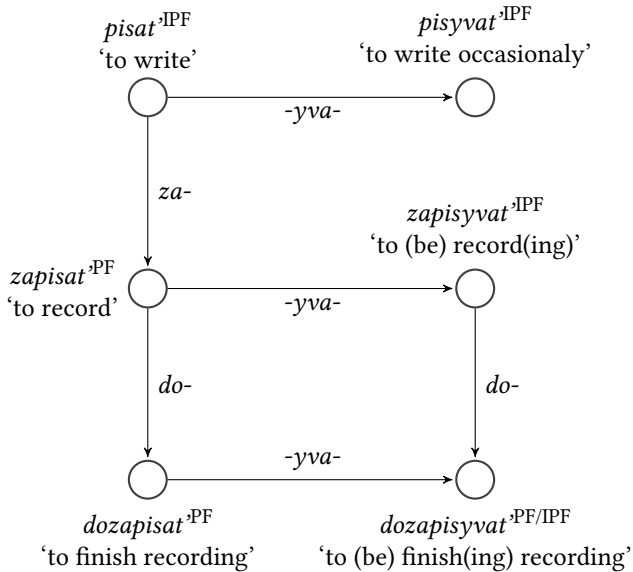

Figure 2.5: A fragment of the derivational graph: *pisat* ‘to write’ and *dozapisyvat* ‘to (be) finish(ing) recording’

this, I propose to take the following approach: I base the generalisations in this and the following chapters on the data about parts of this graph that are built using introspection and corpora/search engine data. Afterwards, in Chapters 6 and 7, I propose a formal account that is capable of predicting which vertices and edges, apart from those already included on the basis of dictionary data, should be added to the derivational graph (at the moment only with respect to the five prefixes I analyse in this work). I also check these predictions at least partially against corpora and search engine data. The output of the computational system I propose can later be used to build a larger version of the derivational graph. An implemented database that is constructed on the basis of the dictionary data, such as OSLIN, can serve as a starting point for the proposed construction.

2.2.4 Predicting the aspect of the derived verb

As discussed in Section 2.1.3, the property that drives the analysis proposed here and is implicitly rejected by the syntactic theories of Russian prefixation is that a given verb does not need to be associated with a unique derivational chain. For example, the biaspectual verb *dozapisyvat* ‘to (be) finish(ing) recording/writing

down' appears as the last node of two derivational chains given in (55), where one of them motivates the perfective aspect of the whole verb (55a), while the other motivates the imperfective aspect of the same verb (55b).

For a verb to have two derivational chains implies that it may be ambiguous with respect to grammatical aspect: each derivational chain yields exactly one grammatical aspect for the derived verb, either perfective or imperfective. The context then presumably selects one of the derivational chains, and consequently, either the perfective or imperfective aspect of the verb, contrary to the syntactic approaches (in their existing form), which can only provide one derivational chain for any given complex verb form due to formal restrictions on the positions of different affixes.

This is desirable given that, judging from the data, the verb *dozapisyvat* 'to (be) finish(ing) recording/writing down' is genuinely ambiguous with respect to the perfective/imperfective distinction, and it is the context that enforces one or the other grammatical aspect assignment. Note that the two derivational chains in (55a) and (55b), discussed above, straightforwardly follow from the two general patterns that are widely accepted as governing the formation of Russian verbs, although there are also some exceptions to them that will be discussed in Section 2.3:

1. the output of a prefixation is perfective;
2. adding the imperfective suffix to a verb yields an imperfective verb.

The root verb in (55a) and (55b) is the primary imperfective verb *pisat* 'to write/to be writing'. Adding the prefix *za-* to it yields a perfective verb, in compliance with (1), and the attachment of the imperfective suffix *-yva-* yields a secondary imperfective verb, following (2). This verb in turn serves as the basis for the prefixation with the completive prefix *do-*. The result is the perfective verb *dozapisyvat* 'to finish recording/writing down', in compliance with (1). In (55b), the second and the third steps are reversed, leading to the imperfective category assignment to the derived verb *dozapisyvat* 'to finish/be finishing recording/writing down'.

Let me explain why the approach outlined here leads to different predictions than the syntactic accounts despite the fact that in both cases it is the final step of the derivation that determines the aspect of the whole complex verb. The crucial assumption of the syntactic approaches to prefixation in Russian is that each prefix (with fixed interpretation) occupies a particular position in the syntactic tree. From this it follows that structural properties of the verbs that have the same

2 A novel approach to the analysis of Russian complex verbs

outermost prefixes are always the same. For example, the verbs that we have just considered, *dopisyvat*^{IPF} ‘to (be) finish(ing) writing’ and *dozapisyvat*^{IPF/PF} ‘to finish/be finishing recording/writing down’, are either both perfective or both imperfective on any existing syntactic prefixation account, as they contain the same outermost prefix *do-* and its position in the tree determines the aspect of the whole verb. On the account advocated here, there is an evident difference between these verbs, as the order of the derivational steps is determined based on all possible derivational chains that are constructed in compliance with Definition 2. While the verb *dozapisyvat*^{IPF/PF} ‘to (be) finish(ing) writing down/recording’ has two derivational chains, as has been shown by (55a) and (55b), which motivates its biaspectual nature, the imperfective verb *dopisyvat*^{IPF} ‘to finish/be finishing writing’ has only one, as has been shown by (54), so it can be only assigned the imperfective aspect.

Another example, already mentioned in Section 2.1.6, is the verb *dovyšivat* ‘to finish embroidering’. It contains the same type of affixes as the verb *dozapisyvat* ‘to finish recording/writing down’. Namely, a completive prefix *do-*, one more prefix commonly characterised as a lexical prefix, and the imperfective suffix. The verbs *dovyšivat* ‘to finish embroidering’ and *dozapisyvat* ‘to finish recording/writing down’ are morphologically alike and thus there is no structural difference between them on any existing syntactic account of Russian verbal prefixation, as the structure of the verb and the order of the affix attachment is determined only on the basis of the syntactic properties of the affixes (with fixed interpretation).

It turns out that these verbs are clearly different for most native speakers: while the perfective uses of the verb *dozapisyvat* ‘to finish recording/writing down’ may be judged odd by some speakers (as claimed by Sergei Tatevosov, personal communication¹⁵), all the native speakers that I have consulted with agree that the verb *dovyšivat* ‘to finish embroidering’ can be used as a perfective verb. Moreover, most of these speakers do not accept *dovyšivat* ‘to finish embroidering’ as an imperfective verb. The same group of people rejects the existence of the verb [?]*dovyšit*^{PF} ‘to finish embroidering’. This behaviour is easily explained

¹⁵Note that such behaviour can be explained on the account proposed here by assuming that these speakers use a stronger version of a general pragmatic principle that is used to account for the non-existence of a range of verbs (more information in Chapters 4 and 5). This principle says that a more complex morphological form cannot be used to express the same meaning that a less marked form has. As a default, the domain of available alternatives is restricted to the verbs belonging to one derivational chain (where the complexity is directly connected to the place in the chain). In the stronger version, however, one can widen the domain to all the chains that start from the same source node. This modification will allow to account for the variation in the acceptability of various verbs.

by means of the relevant part of the derivational graph, presented on Figure 2.6. For the group of speakers who reject the existence of the verb *vyšít*^{PF} ‘to finish embroidering’, the derivation in (56b) is not available, as it requires the verb *vyšít*^{PF} ‘to finish embroidering’ to be attested. Thus the verb *dovyšivat* ‘to finish embroidering’ cannot be assigned the imperfective aspect. On the other hand, at least some of the speakers that accept the verb *vyšít*^{PF} ‘to finish embroidering’ also have access to the imperfective aspect of the verb *dovyšivat* ‘to finish embroidering’.

- (56) a. *šít*^{IPF} → *vy-šít*^{PF} → *vy-š-iva-t*^{IPF} →
 to sew → to embroider → to embroider/be embroidering →
do-vy-š-iva-t^{PF}
 to finish embroidering
- b. *šít*^{IPF} → *vy-šít*^{PF} → *do-vy-šít*^{PF} →
 to sew → to embroider → to finish embroidering →
do-vy-š-iva-t^{IPF}
 to finish/be finishing embroidering

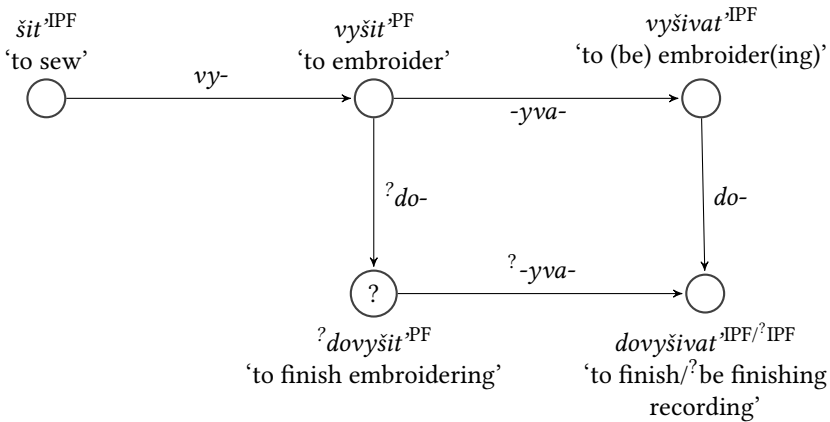

Figure 2.6: A fragment of the derivational graph: *šít* ‘to sew’ and *dovyšivat* ‘to finish embroidering’

I would like to also point out another question that naturally arises in connection with the possible paths in the derivational graph. One may ask whether there are prefixes that can be considered perfectivity markers. The first step towards answering this question would be to look for a prefix such that whenever

a verb contains it, there are no outgoing edges from the node corresponding to this verb in the derivational graph. Although this is a reformulation of one of the classical characteristics of the superlexical prefixes,¹⁶ Tatevosov (2007; 2009) provides numerous counterexamples to such a constraint. In the account proposed in Tatevosov 2009, the main constraints on the attachment of the superlexical prefixes are formulated in different terms: they must be attached either before the imperfective suffix or to a formally imperfective verb. Only the distributive prefix *po-* that, according to Tatevosov (2009), occupies the left periphery of the verb, is then a prefix of such a type that the verb that contains it is necessarily perfective and no other morpheme can be attached higher than it. I will further investigate the ability of the individual prefixes discussed here to constitute a part of an imperfective verb in Chapter 4.¹⁷

2.3 Prefixation and perfectivity

2.3.1 Introduction

It is generally assumed in Russian morphology that, if the last step of the verbal derivation is prefixation, the verb comes out perfective. This fact does not depend on the point where the perfectivity comes in: in both aspect-low (Verkuyl 1995; Piñón 2001; Ramchand 2004: among others) and aspect-high (Paslawska & von Stechow 2003; Grønn & von Stechow 2010; Tatevosov 2011) theories, prefixes carry some property that either immediately or later leads to the perfective aspect of the verb. In this section we will discuss cases that seem to provide exceptions to this pattern.

In the first part, Section 2.3.2, we will look at the prefixation of borrowed bi-aspectual verbs with native prefixes. Then, in Section 2.3.3, we will examine what happens if an imperfective verb derived from a borrowed root gets prefixed. Next, in Section 2.3.4, we will discuss the case of native biaspectual verbs and their prefixation. The discussion will be followed by some information on borrowed prefixes, as they do not affect the aspect of the verb they are attached to (Section 2.3.5). We will then close with considering the problem of motion verbs that are often said to resist perfectivisation when prefixed (Section 2.3.6, also published as Zinova & Osswald 2016).

¹⁶See, e.g. Ramchand (2004), Svenonius (2004a), and Romanova (2006), who assume that superlexical prefixes occupy the highest position in the verbal structure.

¹⁷Note that even if we find such prefixes that can be encountered only on the last derivational step, they are not necessarily perfectivity markers, as there may be other reasons (e.g. semantic, pragmatic, phonological) why further derivational steps are not possible.

2.3.2 Prefixation of borrowed biaspectual verbs

Consider the verbs *perezapisat*^{'PF} 'to rerecord' and *zapisyvat*^{'IPF} 'to record/be recording'. Both verbs are attested and commonly used by native speakers. Intuitively, the verb *perezapisyvat* 'to rerecord/be rerecording' can be formed from either of them: one can add the imperfective suffix to the verb *perezapisat*^{'PF} 'to rerecord' or the repetitive prefix *pere-* to the verb *zapisyvat*^{'IPF} 'to (be) record(ing)'. This is schematically shown in (57).

- (57) a. *pisat*^{'IPF} → *zapisat*^{'PF} → *perezapisat*^{'PF} →
 'to write' 'to record' 'to rerecord'
perezapisyvat^{'IPF}
 'to rerecord/be rerecording'
- b. *pisat*^{'IPF} → *zapisat*^{'PF} → *zapisyvat*^{'IPF} →
 'to write' 'to record' 'to record/be recording'
perezapisyvat^{'IPF}
 'to rerecord/be rerecording'

The derivational chain in (57b) is excluded under all accounts for verbal prefixation, since it violates the assumption that adding a prefix as a last derivational step makes the derived verb perfective. However, on the intuitive level, the derivation in (57b) is acceptable. This leads us to question the hypothesis of a uniform perfectivising function of all the verbal prefixes in Russian. In order to address this question, we have to look at some derivations where there is no potential for switching the order of the derivational steps.

A case in point are borrowed biaspectual verbs. Consider the biaspectual verb *kvalificirovat* 'to qualify/to classify'. It is formed with the native verbal suffix *-irova-*, which instantiates one of the systematic patterns of formation of borrowed verbs. This verb can be prefixed with the repetitive prefix *pere-*. The result of such a prefixation is the verb *perekvalificirovat* 'to requalify/to recategorise', which is, in turn, also biaspectual.

In order to show that in this case prefixation does not lead to the perfective aspect of the verb, I have to prove two things: (1) that the verb *perekvalificirovat* 'to requalify/to recategorise' is indeed biaspectual and (2) that there is no other way to derive the verb *perekvalificirovat* 'to requalify/to recategorise' than by attaching the prefix *pere-* to the verb *kvalificirovat* 'to qualify/to classify'.

To show that the prefixed verb *perekvalificirovat* 'to requalify/to reclassify' is biaspectual, let me provide evidence of its usage both as a perfective and as an imperfective verb. Example (58a) illustrates the usage of the verb *perekvalificirovat* 'to requalify/to reclassify' in the perfective aspect and the constructed sentence

2 A novel approach to the analysis of Russian complex verbs

(58b) shows that perfective aspect is available according to the test offered in Section 2.1.5.

- (58) a. Krome togo, vynosja prigovor, sud'ja
 apart this, vy.carry.PART.PRES sentence.SG.ACC judge.SG.NOM
 perekvalificiroval^{PF} obvinenie i snizil s
 pere.classify.PST.SG.M accusation.SG.ACC and lower.PST.SG.M from
 "osobo krupnogo" na "krupnyj" objem nefti, v
 "particularly large" on "large" volume.SG.ACC oil.GEN in
 xiščenii kotoroj obvinjajutsja podsudimye.
 theft.SG.PREP which.F.SG.PRP accuse.PRES.3.PL.refl defendant.PL.NOM
 'Apart from this, when pronouncing the sentence, the judge reclassified the accusation, changing the amount of oil that the defendants are accused of stealing from "particularly large" into "large".'
<https://www.vesti.ru/article/2093393>, accessed on 03.08.2021
- b. Sud'ja perekvalificiroval^{PF} delo i pošël
 judge.SG.NOM pere.classify.PST.SG.M case.SG.ACC and po.go.PST.SG.M
 domoj.
 home
 'The judge reclassified the case and went home.'

To show that the verb *perekvalificirovat'* 'to requalify/to reclassify' can also be used as an imperfective verb, I apply to it the four common tests that delimit imperfective verbs. It turns out that in an appropriate context the verb *perekvalificirovat'* 'to requalify/to reclassify' can have a progressive interpretation, as shown by example (59a), it can be used as a complement of a phasal verb, as in (59b), form periphrastic future, as in the sentence (59c), and form a present participle, as in (59d).

- (59) a. V dannyj moment on perekvalificiruet^{IPF} svoju "Armiju Maxdi"
 in given moment he pere.qualify.PRES.3.SG his "Armija Maxdi"
 v političeskoe dviženie.
 in political movement
 'Right now he is re-categorising his "Armija Maxdi" into a political movement.'
<https://www.km.ru/glavnoe/2005/06/14/politika/rossiiskii-posol-v-irake-vstretilsya-s-muktadoi-sadrom>, accessed on 03.08.2021
- b. Sejčas advokaty načnut perekvalificirovat'^{IPF} delo v
 now advocates start.PRES.3.PL iter.qualify.INF case in

političeskoje.

political

‘Now the advocates will start to re-classify this case as a political one.’

https://pikabu.ru/story/v_polshe_zaderzhali_prokurora_ignatenko_396297/author, accessed on 03.08.2021

- c. Policejskix budut perekvalificirovat^{IPF} v buxgalterov.

policemen will.be pere.qualify.INF in accountant.PL.ACC

‘Policemen will be re-trained and become accountants.’

https://pikabu.ru/story/politseyskikh_budut_perekvalifitsirovat_v_bukhgalterov_169505, accessed on 03.08.2021

- d. Ne pozvoljaetsja smotret’ na perekvalificiruemye sdelki

not allow look on pere.qualify.PART.PRES.PL.ACC deals

s pozicii togo, čto nalogoplatel’ščik mog sdelat’ v

from position that, that tax.payer can.PST.SG.M s.do.INF in

tex uslovijax.

that conditions

‘We cannot view the deals which are subject to reclassification on the basis of what a tax-payer would have done under the same circumstances.’

<http://lesregion.ru/main/1455-osobennosti-rascheta-summy-nds-iznutri-summy-sdelki-pri-ee-nalogovoy-perekvalifikacii.html>, accessed on 03.08.2021

Now let us examine other potential ways of deriving the verb *perekvalificirovat* ‘to requalify/to reclassify’ such that prefixation is not the last derivational step. The first idea is to allow the possibility of the suffix *-ova-* to be attached after the prefix *pere-*. This is not possible, since there is no verb **kvalificirit* (i.e., *kvalificirovat* without the suffix *-ova-*) and also no verb **perekvalificirit* that can be imperfectivised by the addition of the imperfective suffix.

Another possibility that must be considered is illustrated by (60). In this potential derivational chain, the verb *kvalificirovat* ‘to qualify/to classify’ is first turned into the noun *kvalifikacija* ‘qualification/classification’, then the noun is prefixed with the prefix *pere-* to obtain the noun *perekvalifikacija* ‘requalification/reclassification’ (example (61) illustrates its usage) and then the verb *perekvalificirovat* ‘to requalify/to reclassify’ is derived from this noun.

- (60) kvalificirovat^{PF/IPF} → kvalifikacija → perekvalifikacija →
 ‘to qualify’ ‘qualification’ ‘requalification’
 perekvalificirovat^{PF/IPF}
 ‘to requalify’

2 A novel approach to the analysis of Russian complex verbs

- (61) Process trudoustrojstva možet uprostit'
 process.SG.ACC placement.SG. GEN can.PRES.3.SG simplify.INF
 perekvalifikacija.
 pere.qualification.SG.NOM
 'The re-training can simplify the process of placement.' <http://worldofscience.ru/menedzhment.html?start=120>, accessed on 03.08.2021

The chain in (60) should be compared with (62), where the prefixed noun is derived from the prefixed verb, and not vice versa, but requires us to assume a non-perfectivising usage of the prefix *pere-*.

- (62) kvalificirovat'^{PF/IPF} → perekvalificirovat'^{PF/IPF} → perekvalifikacija
 'to qualify' 'to requalify' 'requalification'

Each of the steps of the proposed derivation in (60) is attested in the Russian derivational morphology. The noun *kvalifikacija* 'qualification/classification' is no doubt derived from the verb *kvalificirovat'* 'to qualify/to classify'. Švedova (1982) writes in this respect that nouns with the suffix *-acija* are motivated mostly by the borrowed verbs with the stem ending in *-irovat'*. Examples (taken from Švedova 1982: 159) include the following pairs: *simulirovat'* 'to feign' – *simuljacija* 'simulation', *idealizirovat'* 'to idealise' – *idealizacija* 'idealization', *abstragirovat'* 'to abstract' – *abstrakcija* 'abstraction'.

The second step, prefixation of the noun *kvalifikacija* 'qualification/classification' with the prefix *pere-*, is also allowed by the Russian morphological system: Švedova (1982: 226) writes that nouns that formed with the prefix *pere-* "nazyvajut povtornost' dejstvija ili javlenija, nazvannogo motivirujuščim slovom" [name the repetition of an action or a phenomenon that is named by the motivating word].

The third step, derivation of a verb ending in *-irovat'* from the noun, is also a possible morphological operation in Russian. For example, in the pair *sklad* 'warehouse' – *skladirovat'*^{PF/IPF} 'to store' the verb is obtained by suffixation of the noun and it is biaspectual.

So far it seems that the derivation in (60) is a possible one. To test this hypothesis further, let us consider the completive prefix *do-*. Analogously to the noun *perekvalifikacija* 'requalification/reclassification' and the verb *perekvalificirovat'* 'to requalify/to reclassify', there exist a noun *dokvalifikacija* 'qualification improvement', as in (63), and a verb *dokvalificirovat'* 'to improve qualification'. If the derivation in (60) is a valid derivation, so must be the one in (64).

- (63) Avtoservis primet na rabotu avtoelektrika. V
 auto.service take.PRES.3.SG on work auto.electrician.SG.ACC in
 perspektive vozmožna dokkvalifikacija.
 perspective possible do.qualification.SG.NOM
 ‘Auto service is hiring an auto electrician. Future additional training possible.’ <https://forum.novgorod.ru/q92686.html>, accessed on 03.08.2021
- (64) kvalificirovat’^{PF/IPF} → kvalifikacija → dokkvalifikacija →
 ‘to qualify’ ‘qualification’ ‘qualification improvement’
 dokkvalificirovat’^{PF/IPF}
 ‘to improve qualification’

It is obvious that the verb *dokkvalificirovat’* ‘to improve qualification’ can be used as a perfective verb, as in (65). The surprising part is that some speakers accept it also as an imperfective verb. Examples of the imperfective usage of this verb are found on the internet: the verb *dokkvalificirovat’* ‘to improve qualification’ can have a progressive interpretation (66a) and form a present participle (66b) and periphrastic future (66c).

- (65) Ja okončil Veterinarnuju akademiju, a armija
 I finish.PST.SG.M veterinary.F.SG.ACC academy.SG.ACC, but army.SG.NOM
 dokkvalificirovala menja do normal’nogo medika.
 do.qualify.PST.SG.F me.ACC to normal.M.SG.GEN physician.SG.GEN
 ‘I graduated from the veterinary academy and in the army I improved my qualification enough to become a physician.’
<https://www.kommersant.ru/doc/2288059>, accessed on 03.08.2021
- (66) a. My vsë vremja učim, pereobučaem naši
 we all time teach.PRES.3.SG, retrain.PRES.3.SG our
 kadry, dokkvalificiruem, perekvalificiruem.
 personnel.PL.ACC, do.qualify.PRES.3.SG, retrain.PRES.3.SG
 ‘We always teach and retrain our personnel, train them to the new levels, re-train them.’ <http://rus-yaz.niv.ru/doc/gallism-dictionary/fc/slovar-202-15.htm>, accessed on 03.08.2021
- b. Pri ètom kak nastavnikam novoprinjatyx
 with this as mentor.PL.DAT new.accepted.PL.GEN
 kolleg, tak i dokkvalificiruemyx
 colleague.PL.GEN, so and do.qualify.PART.PASS.PRES.PL.GEN
 proizvoditsja premial’naja oplata za
 make.PRES.3.SG.refl premium payment.SG.NOM behind

2 A novel approach to the analysis of Russian complex verbs

rabočee vremja, posvjaščennoe
work.SG.N.ACC time.SG.ACC, dedicate.PART.PASS.PST.SG.N.NOM
obučeniju.
education.DAT

‘Wherein both mentors of the new recruits as well as mentors of those workers that are being given extra-trained are paid additionally for the working time they spend on educational purposes.’

<https://kurs.znate.ru/docs/index-170298.html?page=5>, accessed on 03.08.2021

- c. Kto budet dokvalificirovat’ kadry?
Who will do.qualify.INF personnel.

‘Who will train the personnel to the new level?’

<https://twitter.com/hashtag/smartcitykazan>, last accessed in 2016

As there are few examples like these in (66) on the internet, I have run a mini-survey, asking native speakers of Russian if the sentences in (66) are acceptable for them. Out of 11 respondents, 4 accepted *dokvalificirovat’* ‘to improve qualification’ as an imperfective verb, while 7 did not.

What some speakers suggested was to attach the imperfective suffix to the verb *dokvalificirovat’* ‘to improve qualification’, which they consider exclusively perfective, and derive the imperfective verb *dokvalificirovyvat’* ‘to improve qualification’, as in (67)).

- (67) Vodil nado dokvalificirovyvat’ v vyšibal, čtob oni
driver.PL.ACC need do.qualify.imp.INF in doorman.PL.ACC, that they
prinimali v takix slučajax kardinal’nye mery.
take.PST.PL in such case.PL.PRP drastic measure.PL.ACC
‘Drivers should be re-trained as bouncers, so that they could take drastic
measures.’ journals.ru, last accessed in 2016

The derived verb is not very natural from a phonological point of view and hardly used. Švedova (1982: 590) writes that suffixation with *-iva-* is possible for the verbs with the *-ova-/-irova-* suffix only if the last syllable of the suffix is stressed.¹⁸ In sum, it seems that imperfectivisation with the suffix *-iva-* is allowed from a morphological point of view, but blocked for phonological reasons.

¹⁸Švedova (1982: 590): “pribavlenie morfa *-iva-* možno tol’ko v tom slučae, kogda udarenie padaet na vtoroj slog suf. *-ova-/-irova-*” [the addition of the *-iva-* morpheme is possible only if the second syllable of the *-ova-/-irova-* suffix is stressed], but from the examples that follow it is clear the she means either the second syllable of the *-ova-* suffix or the last syllable of the *-irova-* suffix.

A behaviour similar to the one of *do-* is observed for the prefix *pod-*. Consider, for example, the borrowed biaspectual verb *amortizirovat'* 'to cushion'. The verb *podamortizirovat'* 'to cushion slightly' can be grammatically perfective verb, as in (68a), or, in some cases like (68b), imperfective. Again, there exists a noun *podamortizacija* 'slight cushioning', as in (69), that could serve as a source of derivation of the prefixed verb, but is accepted only by some native speakers of Russian.

- (68) a. ...krome togo, možno ešče snizu porolončikom žestkim
 ...aside that, possible also below foam rubber hard
podamortizirovat'^{PF}
 pod.cushion.INF
 'it is also possible to put some hard foam rubber below as a cushion'
<https://guitarplayer.ru/equipment-others/kreplenie-zvukosnimatelya-243681/>, accessed on 24.08.2021
- b. Čto tolku podamortizirovat'^{IPF} perednee koleso, esli zadnie
 what sense pod.cushion.INF front wheel if back
 žestko sidjat na rame.
 hardly sit.PRES.PL on frame
 'What's the point to cushion the front wheel when the back ones are sitting hard on the frame?'
<https://pnevmohod.ru/forum/index.php?topic=739.20>, accessed on 24.08.2021
- (69) Ili, skažem, v BTR-ax suščestvuet podamortizacija
 Or, say.PRES.1.PL, in BTR.PL.PREP exist.PRES.3.SG pod.cushioning.SG.NOM
 sidenij: dlja togo, čtoby v slučae naezda na minu desantnika ne
 seat.PL.GEN: for that, that in case hitting on bomb paratrooper not
 tak sil'no trjaxnulo.
 as strongly shake.PST.SG.N
 'Or, say, BTRs have a slight seat cushioning: so if it drives over a bomb the paratrooper won't be shaken so much.'
<https://www.liveinternet.ru/users/657082/post340646018/>, accessed on 24.08.2021

It might seem that for some speakers biaspectual borrowed verbs ending in *-irova* lack aspect and remain underspecified in this respect when prefixed with any prefix. This is not the case, as apart from the three prefixes discussed above, bi-aspectual verbs become perfective after prefixation.

2 A novel approach to the analysis of Russian complex verbs

As an example, let us consider the verb *otkvalificirovat'* 'to finish classifying'. It is formed by prefixing the verb *kvalificirovat'* 'to qualify/to classify' with the terminative prefix *ot-*. This verb can be only used as a perfective verb, as illustrated by (70). Interestingly, in this case there is no noun **otkvalifikacija*, so a chain like the ones in (60) and (64) cannot be constructed.

- (70) Ja liš otkvalificiroval na osnovanii tipičnyx voprosov.
I only ot.qualify.PST.SG.M on basis typical question.PL.GEN
'I only got re-qualified on the basis of the typical questions.' <https://forum.nag.ru/index.php2/topic/18454-cisco-d-link/>, accessed on 24.08.2021

It also has to be mentioned that, besides borrowed biaspectual verbs with the *-irova* suffix, there are also borrowed biaspectual verbs with the suffix *-ova-*, such as *organizovat'* 'to organise' in (71).

- (71) Pervyj kanal organizoval^{PF} v Tule grandioznyj prazdnik
first channel organise.PST.SG.M in Tula.PRP colossal celebration
dlja detej.
for children.GEN
'Channel 1 organised a colossal celebration for children in Tula.'
<https://www.1tv.ru/actions/stan-pervym/pervyy-kanal-organizoval-v-tule-grandioznyj-prazdnik-dlya-detey>, accessed on 24.08.2021

The verb *organizovat'* 'to organise' does not fall under the phonological restriction on the attachment of the imperfective suffix, so an imperfective verb *organizovyvat'*^{IPF} 'to organise/to be organising' does exist. Due to the presence of an unambiguously imperfective verb, *organizovat'* 'to organise' seems to be partially losing its biaspectuality, as I could find no examples of uttering *organizovat'* 'to organise' as an imperfective verb in the past tense. However, in the non-past tense imperfective usages of the verb *organizovat'* 'to organise' are natural and common (see example (72)).

- (72) Kak ja organizuju^{IPF} informaciju pri prodviženii
how I organise.PRES.1.SG information.ACC at promotion.SG.PRP
sajtov.
website.PL.GEN
'How do I organise information when promoting a website.' <https://shakin.ru/seo/how-i-organize-seo-data.html>, accessed on 24.08.2021

This asymmetry may be due to the different ways of constructing the tensed forms of the verbs. In the past tense, the personal forms of the verbs *organizov-*

vat ‘to organise’ and *organizovyvat*^{IPF} ‘to organise/to be organising’ differ by one syllable (*organizoval* ‘he organised’ vs. *organizovyval* ‘he organised/was organising’). In the non-past tense, the phonological and morphological distance is bigger: personal forms of the secondary imperfective verb (e.g., *organizovyvaju* ‘I organise/am organising’) are two syllables and two morphemes longer than the respective personal forms of the source verb (e.g., *organizuju* ‘I organise’). Due to this, the cost of using the suffixed and not the original biaspectual verb (in a context that requires the imperfective aspect) is less for the past tense.

Both biaspectual and imperfective verbs can be prefixed with the repetitive prefix *pere-*, producing the biaspectual verb *pereorganizovat* ‘to reorganise/be reorganising’ and the imperfective verb *pereorganizovyvat* ‘to reorganise/be reorganising’. Potential derivational chains for the imperfective verb *pereorganizovyvat* ‘to reorganise/be reorganising’ are shown in (73).

- (73) a. *organizovat*^{PF/IPF} → *pereorganizovat*^{PF/IPF} →
 ‘to organise’ ‘to reorganise’
pereorganizovyvat^{IPF}
 ‘to reorganise/be reorganising’
- b. *organizovat*^{PF/IPF} → *organizovyvat*^{IPF} →
 ‘to organise’ ‘to organise/be organising’
pereorganizovyvat^{IPF}
 ‘to reorganise/be reorganising’

When the completive prefix *do-* is attached to the same verbs, the verb *doorganizovat* ‘to finish organising’ is clearly perfective and the verb *doorganizovyvat* ‘to finish/be finishing organising’ is biaspectual, as evidenced by the examples in (74).

- (74) a. *sam budu doorganizovyvat*^{IPF} *obučenie*
 myself will do.organise.imp.INF education.ACC
 ‘I will finish organising the education process myself’
 deco-house.ru, last accessed in 2016
- b. *Ja daže svoju gil’diju do six por ne*
 I also my guild.SG.ACC until this time not
doorganizovyval^{PF}, *ne to, čto celoe kom’juniti*
do.organise.imp.PST.SG.M, not that, that whole community
 ‘I still have not finished organising my guild, let alone the whole community.’ <https://forum.tera-online.ru/topic/706/?page=2?>, accessed on 24.08.2021

2 A novel approach to the analysis of Russian complex verbs

- (75) a. organizovat^{'PF/IPF} → doorganizovat^{'PF} →
 'to organise' 'to finish organising'
 doorganizovyvat^{'IPF}
 'to finish organising/be finishing organising'
- b. organizovat^{'PF/IPF} → organizovyvat^{'IPF} →
 'to organise' 'to organise/be organising'
 doorganizovyvat^{'PF}
 'to finish organising/be finishing organising'

If one compares the derivational chains in (73) and (75), the difference between the behaviour of the prefix *do-* and the behaviour of the prefix *pere-* becomes evident: verbs containing the respective prefixes and not containing the extra imperfective suffix have different aspectual characteristics. One may again try to adopt the path offered in (60): assume that biaspectual prefixed verb is formed on the basis of the prefixed noun (76).

- (76) organizovat^{'PF/IPF} → organizacija → pereorganizacija →
 'to organise' 'organisation' 'reorganisation'
 pereorganizovat^{'PF/IPF}
 'to reorganise'

It turns out that this hypothesis must be rejected. If (76) is a valid derivational chain, so must be (77). In the latter case, however, the last verb in the chain, which is by hypothesis derived from the noun, lacks imperfective aspect.

- (77) organizovat^{'PF/IPF} → organizacija → doorganizacija *→
 'to organise' 'organization' 'final stage of organization'
 doorganizovat^{'PF/*IPF}
 'to finish organising'

From this we have to conclude that the derivations (60) and (64) do not seem to be empirically motivated and another explanation is needed.

In sum, in this section I have shown that loaned biaspectual verbs exhibit unexpected behaviour when they are prefixed with one of the prefixes *do-*, *pere-*, and *pod-*: they may remain biaspectual. This is especially prominent in the case of the prefix *pere-* (with repetitive interpretation) and less so in case of the prefixes *do-* and *pod-*. The non-perfectivising behaviour of the prefix *pere-* will be further discussed in Section 4.6. The cases where verbs prefixed with *do-* remain biaspectual must be explained separately. Detailed investigation of this phenomena remains outside the scope of this book.¹⁹

¹⁹My primary hypothesis would be based on phonological considerations. I think that in these

2.3.3 Prefixation of imperfective verbs with a borrowed root

Let us now consider the verb *planirovat'* 'to plan/be planning'. It is an imperfective verb derived from the noun *plan* 'plan'. It turns out that the verb *pereplanirovat'* 'to replan/be replanning' is biaspectual. The perfective usage is exemplified in (78) and the diagnostic cases for the imperfective usage are shown in (79): one can use it to form periphrastic future (examples (79a) and (79b)), it can be combined with a phasal verb (79c), it can receive progressive interpretation (79d), and there exists a present participle formed from it (79e).

- (78) Odnako vposledstvii arendator samovol'no
 nevertheless later tenant.SG.NOM without permit
 pereplaniroval^{PF} pomeščeniye v proizvodstvennye cexa.
 pere.plan.PST.SG.M room.PL.ACC in production hall.PL.ACC
 'The tenant nevertheless later replanned the space without permission into a production hall.' <https://www.uralinform.ru/news/crime/94439-v-ekaterinburge-glava-mebelnoi-phirmy-otvetit-za-gibel-12-chelovek/>, accessed on 24.08.2021
- (79) a. A poka budu pereplanirovat'^{IPF} učastok pod buduščuju
 but now will pere.plan.INF garden plot under future
 posadku.
 planting
 'In the meanwhile I will replan the garden plot for future planting.'
<https://forum.vinograd.info/archive/index.php?t-1935-p-3.html>, accessed on 24.08.2021
- b. Budu pereplanirovat' maršrut s učetom ostanovok i
 will pere.plan.INF route with accounting stop.PL.GEN and
 vylazok s mesta dislokacii po radiusu.
 outing.PL.GEN with place location.SG.GEN on radius
 'I will replan the route, taking into account the stops and radial outings from our location.' <https://forum.awd.ru/viewtopic.php?f=1081&t=202383&start=20>, accessed on 24.08.2021
- c. Soglasilsja. Načal pereplanirovat' svoi dela na
 agree.PST.SG.M.REFL start.PST.SG.M pere.plan.INF my affairs on

cases the formation of the secondary imperfective from the prefixed borrowed biaspectual verb is possible from the point of view of both syntax and semantics. However, such forms are blocked for phonological reasons. One can hypothesise that in this case the less complex form (originally perfective) acquires the role of the blocked derivative (imperfective). I suppose that this is only possible when the suffix *-ova-* marking borrowed verbs, that resembles the imperfective suffix, is present.

2 A novel approach to the analysis of Russian complex verbs

vyxodnye.

weekend

'I agreed. I started replanning my weekend activities.' <https://market.yandex.ru/user/1h3d4n5av25qe6tq1bh7jzx5zg/reviews>, accessed on 24.08.2021

- d. Imeetsja kvartira (5 komnat), kotoruju v dannyj have.PRES.3.SG.REFL flat.SG.NOM (5 room.PL.GEN) that in given moment pereplanirujut i pereformljajut, kak 2 i 3. moment pere.plan.PRES.3.PL and pere.register.PRES.3.PL as 2 and 3 'There is a flat (5 rooms) that is now being replanned and reregistered, as one 2-room and one 3-room flat.' m.disput.az, last accessed in 2016
- e. Tol'ko ja svoju pereplanirovku sdala v only I my pere.planning.glbsg.acc s.give.PST.SG.F in èkspluataciju v 2004 godu i polučila pravo operation in 2004 year and receive.PST.SG.F right sobstvennosti na pereplaniruemyj ob'ekt. property on pere.plan.PART.PASS.PRES.SG.M.ACC object 'But my replanning was put into operation in 2004 and I received the right of property for the replanned site.' <https://www.zonazakona.ru/forum/topic/59929-kakova-summa-shtrafa-za-nezakonnuyu-pereplanirovku/>, accessed on 24.08.2021

From the biaspectual verb *pereplanirovat'* 'to replan/be replanning', a deverbal noun *pereplanirovanie* 'replanning' can be derived by means of the suffix *-anij-*. An example from the internet that includes this noun is provided in (80).

- (80) Èksperty pristupili k pereplanirovaniju territorij
expert.PL.NOM start.PST.PL to pere.planning.SG.DAT territory.PL.GEN
ob"edinennogo stoličnogo regiona.
joint capital region
'Experts started to replan the area of the joint capital region.'<https://txt.newsru.com/realty/13Jul2011/drops.html>, accessed on 24.08.2021

In contrast to the case of loaned biaspectual verbs, native biaspectual verbs such as *splanirovat'* 'to plan', *naplanirovat'* 'to plan a lot of', and *doplanirovat'* 'to finish planning' that undergo prefixation by means of prefixes other than the repetitive *pere-*, are perfective only. Even speakers that accept imperfective usages of the verb *dokvalificirovat'* 'to improve qualification' do not accept imperfective usages

of the verb *doplanirovat* ‘to finish planning’. In particular, all native speakers of Russian that were exposed to the sentence (81), where the verb *doplanirovat* ‘to finish planning’ has to get an ongoing interpretation, marked it as ungrammatical.

- (81) *Ja seččas sižu na turističeskix sajtax i
 I now seat.PRES.1.SG on touristic website.PL.PREP and
 doplaniruju našu poezdku.
 do.plan.PRES.1.SG our trip
 ‘I am now browsing through tourist websites and finishing planning our trip.’

These observations point again towards the special status (the absence of the perfectivisation effect) of the prefix *pere-* with respect to the aspect of the derived verb.

2.3.4 Prefixation of native biaspectual verbs

Another category of verbs that should be examined are native biaspectual verbs. The question is how prefixation with the repetitive prefix *pere-* affects the aspect of such verbs. The first group of native biaspectual verbs are verbs ending in *-it*: *ženit* ‘to marry off’, *kaznit* ‘to execute’, *ranit* ‘to wound’. Whenever one searches for the verbs *pereženit*, *perekaznit* or *pereranit*, the prefix *pere-* appears to acquire a distributive interpretation and the verbs mean ‘marry off all of’, ‘execute all of’ and ‘wound all of’, respectively. As for the repetitive interpretation of the prefix, it is hardly compatible with the semantics of the verbs listed above. This is due to the fact that repetition has to be bound to cancelling the outcome of the first event (this is the requirement of the prefix *pere-* that we will discuss in Chapter 4). For the events of executing and wounding it would mean that the death and the wounds must be cancelled, which is not compatible with world knowledge. In case of an event of marriage, its repetition has to be a marriage between the same persons because the first ritual was in some sense unsuccessful, which is possible, so let us consider the verb *ženit* ‘to marry off’ in more detail.

Examples (82a) and (82b) illustrate the biaspectual nature of this verb (along with the examples in (6) provided earlier in this chapter). Despite the most natural interpretation of the *pere-*prefixed native biaspectual verbs being distributive, we will now try to prefix the verb *ženit* ‘to marry off’ with the prefix *pere-* with repetitive interpretation. With some ingenuity, one can think about a situation in which a couple was married but, for example, the ritual was wrong and they

2 A novel approach to the analysis of Russian complex verbs

have to be married again. Then a sentence like (82c) can be successfully uttered (this is a constructed example). The imperfective usage of the same verb in the same situation is not allowed (see sentence in (82d) with enforced progressive interpretation of the verb). However, some speakers find it possible to imperfectivise the verb *pereženit'* 'to marry off anew' and derive the verb *pereženivat'* 'to marry/be marrying off anew.' An example is provided in (83).

- (82) a. V dannyj moment sotrudnik ženil^{IPF} nemoloduju paru.
in given moment employee marry.off.PST.SG.M not young pair
'At the moment, the employee was conducting the marriage of a mature couple.'
- b. Zavtra ego ženjat^{PF} na neljubimoj ženščine
tomorrow he.ACC marry.off.PRES.3.PL on non-loved woman.PRP
i on, navernoje, sop'ětsja.
and he probably become.drunkard.PRES.3.SG
'Tomorrow he will be married off to a woman he does not love and most probably he will become a drunkard.'
- c. Zavtra ix pereženjat^{PF} v sootvetstvii s
tomorrow they.ACC pere.marry.off.PRES.3.PL in accordance with
mestnymi tradicijami.
local.PL.INST tradition.PL.INST
'Tomorrow they will be married again according to the local traditions.'
- d. *V dannyj moment ix pereženjat^{*IPF} v sootvetstvii
in given moment they.ACC pere.marry.off.PRES.3.PL in accordance
s mestnymi tradicijami.
with local.PL.INST tradition.PL.INST
- (83) Esli troix detej net, nasil'no brak rastorgat' i
if three child.PL.GEN no by.force marriage cancel.INF and
pereženivat'.
pere.marry.off.INF
'If a couple does not have three children, cancel their marriage by force and marry them off again.' <https://forum.guns.ru/forummessage/37/189635.html>, accessed on 24.08.2021

From this we can conclude that native biaspectual verbs ending in *-it'* become perfective when prefixed with the repetitive prefix *pere-*, if such prefixation is possible at all. This is reflected in the derivational chain (84).

- (84) $\text{ženit}^{\text{IPF/PF}}$ → $\text{pereženit}^{\text{PF}}$ →
 ‘to marry/be marrying off’ ‘to marry off anew’
 ? $\text{pereženivat}^{\text{IPF}}$
 ‘to marry/be marrying off anew’

Another neat example involving a verb belonging to the same group ($\text{krestit}^{\text{IPF/PF}}$ ‘to baptise’) is given in (85). The derivation of the verb $\text{perekreščivat}^{\text{IPF/PF}}$ ‘to rebaptise/be rebaptising’ is shown in (86).

- (85) $\text{Potrebuem perekreščivat' vsech mladencev i po.demand.PRES.1.PL pere.baptise.imp.INF all infant.PL.GEN and pereotpevat' vsech pokojnikov? Perevenčivat' i pere.ot.sing.imp.INF all deceased.PL.GEN pere.baptise.imp.INF and pereispovedovat'?$
 pere.profess.INF
 ‘Will we demand that they rebaptise all the infants and reread the burial service for all the deceased? Rebaptise and reprofess?’
<http://www.dobroeslovo.ru/viewtopic.php?f=5&t=25559>, accessed on 24.08.2021
- (86) $\text{krestit}^{\text{IPF/PF}}$ → $\text{perekrestit}^{\text{PF}}$ →
 ‘to baptise/be baptising’ ‘to rebaptise’
 ? $\text{perekreščivat}^{\text{IPF}}$
 ‘to rebaptise/be rebaptising’

Another class of native biaspectual verbs consists of just one verb obeščat ‘to promise’. When this verb is prefixed with the repetitive prefix pere- , the derived verb is considered biaspectual at least by some speakers, which is evidenced by the examples in (87): in (87a) the verb pereobeščat ‘to promise anew’ is used as an imperfective verb in the periphrastic future construction budu pereobeščat ‘will repromise’ and in (87b) the same verb is used as a perfective verb.

- (87) a. $\text{Devuška, kotoroj obeščan dar}$
 girl.SG.NOM which promise.PART.PASS.SG.M gift
 $\text{molčit, esli v tečenii nedeli ne otvetit}$ –
 keep.silent.PRES.3.SG if during week not answer.PRES.3.SG
 budu pereobeščat' .
 will pere.promise.INF
 ‘The girl to whom I promised the gift, remains silent, if she does not reply within a week – I will repromise.’
<https://darudar.org/gift/1359284/>, accessed on 24.08.2021

2 A novel approach to the analysis of Russian complex verbs

- b. Poobeščali perezvonit', čto ja pereobeščal v
po.promise.PST.PL pere.call.INF, what I pere.promise.PST.SG in
svoju očered' Rome...
my turn Roma.DAT
'They promised to call back and I, in my turn, promised that to
Roma...' yphooteem.kidalia.com, last accessed in 2016

To my ear, the usage in (87a) is strange and I would mark the verb *pereobeščat'* 'to promise anew' as a perfective one, but, as evidenced by the examples found in the internet, some speakers accept this verb as belonging to the imperfective aspect as well.

The last group of verbs consists of those verbs that are formed with the suffix *-ova-* and are mostly derived from nominal roots. Examples of such verbs are *issledovat'* 'to investigate' (derived from the noun *sled* 'trace'), *ispol'zovat'* 'to use' (derived from the noun *pol'za* 'benefit'), *ispovedovat'* 'to profess', *naputstvovat'* 'to counsel' (derived from the noun *put'* 'path'). It is not always possible to prefix such verbs with the repetitive prefix *pere-*, but in case it is possible, the resulting verb is biaspectual. We have already seen one such example in (85), where the verb *ispovedovat'* 'to profess', prefixed with *pere-*, is used as an imperfective verb. An example of how the same verb can be used as a perfective verb is provided in (88).

- (88) Zanovo pereispovedoval i eščë dolgo utešal
Anew pere.profess.PST.SG.M and more long comfort.PSD.SG.M
sladkimi slovami o spasenii i radosti bogoljubija.
sweet word.PL.INST about salvation and joy godliness.GEN
'He professed me anew and spent a long time comforting me
with sweet words about the salvation and the joy of godli-
ness.' [https://azbyka.ru/otechnik/Varvara_Pylneva/chudo-ispovedi-
nepridumannye-rasskazy-o-tainstve-pokajaniija/](https://azbyka.ru/otechnik/Varvara_Pylneva/chudo-ispovedi-nepridumannye-rasskazy-o-tainstve-pokajaniija/), accessed on 24.08.2021

2.3.5 Borrowed prefixes

Apart from borrowed nouns and verbs, Russian language also includes some borrowed prefixes. One can find them in dictionaries, but they are not discussed in theoretical work. Examples of such prefixes are *de(z)-*, *dis-*, *re-*, *so-*. The prefix *de-/dez-* with the meaning of undoing or canceling what is described by the source verb can be attached to imperfective and to biaspectual verbs. Derived verbs with this prefix are always biaspectual, as exemplified by the following

pairs: *maskirovat*^{IPF} ‘to mask’ – *demaskirovat*^{IPF/PF} ‘to unmask’, *orientirovat*^{IPF/PF} ‘to orient’ – *dezorientirovat*^{IPF/PF} ‘to disorient’. The next prefix, *dis-*, has the same meaning as the prefix *de-/dez-*, but it does not affect the aspect of the source verb: imperfective verbs remain imperfective (*garmonirovat*^{IPF} ‘to be in harmony’ – *disgarmonirovat*^{IPF} ‘to not be in harmony’) and biaspectual verbs are still bi-aspectual after prefixation (*kvalificirvat*^{IPF/PF} ‘to qualify’ – *diskvalificirovat*^{IPF/PF} ‘to disqualify’). The semantics of the prefix *re-* is repetitive, similarly to the repetitive usage of the prefix *pere-*. According to Švedova (1982: 369), it attaches exclusively to biaspectual verbs, and the derived verbs are also biaspectual, as in the pair *organizovat*^{IPF/PF} ‘to organise’ – *reorganizovat*^{IPF/PF} ‘to reorganise’. The last prefix in the borrowed group, *so-*, which does not change the aspect of the verb it attaches to, has the semantics of the English prefix *co-*, as in the pair *učastvovat*^{IPF} ‘to participate’ – *součastvovat*^{IPF} ‘to co-participate’.

When it comes to the theoretical literature, such prefixes are usually not considered to be a part of the system. For example, Krongauz (1998: 101-105) lists five conditions under which a prefix is taken to belong to Russian verbal prefixation system: it must be capable of forming verbs, combine with verbs, perfectivise, be productive and be atomic. Since the prefixes listed above do not perfectivise, Krongauz (1998: 103) does not consider them as part of this system.

As I have shown with the behaviour of the prefix *pere-* with repetitive interpretation, perfectivization is not the crucial property of a prefix that belongs to the Russian prefixation system. It seems, however, that the verbs prefixed with *dis-*, *dez-*, *re-*, listed above, also exist in other languages, so there is no reliable evidence that prefixation took place after the verb had been loaned. As for the last prefix, *so-*, it is more often attached to nouns than to verbs (e.g., *brat* ‘brother’ – *sobrat* ‘fellow’) and should probably not be regarded as a verbal prefix (in this case *součastvovat* ‘to co-participate’ would be derived from *součastnik* ‘accomplice/partner’).

More detailed examination of the subsystem of borrowed prefixes and their interaction with borrowed verbs remains outside the scope of this thesis, although I believe it can reveal some interesting properties of the Russian verbal prefixation system in general and thus should not be completely ignored in future studies. In particular, I think it would be interesting to look at the historical linguistics data with respect to the repetitive interpretation of the prefix *pere-* and the loaned prefix *re-*: as these forms share part of the phonological structure, have the same semantics, and do not change the aspect of the verb, it would be interesting to check whether these properties of the repetitive prefix *pere-* might be due to some crosslinguistic inference.

2.3.6 Prefixed verbs of motion

Now that we have discussed cases of non-perfectivising prefixation due to the nature of prefixes or loaned status of verbal stems, let us consider a phenomenon that is often considered to be an exception in the prefixation system. This is the case of motion verbs, six of which seem to remain imperfective when prefixed with certain prefixes.²⁰

Russian verbs of motion consist of a limited set of basic imperfective verbs which exist in two forms: determinate (also called directed or unidirectional) and indeterminate (or multi-directional, non-directed). A couple of examples is provided in (89) and the whole list of such pairs and their interpretations is given in Table 2.3.

- (89) a. *idti* – *xodit'*
 go (one direction) – go (non-directional)
 b. *letet'* – *letat'*
 fly (one direction) – fly (non-directional)

Stilman (1951: 3f) gives the following informal characterisation of the meaning and usage differences between determinate and indeterminate verbs. According to him, determinate verbs describe “motion in a definite direction, actually taking place at a given time” and indeterminate verbs, on the other hand, are used to describe either “a given type of locomotion in general, without reference to progress in any particular direction”, or “motion in a definite direction when it is repeated or habitual”, or “a completed round trip (having gone somewhere and returned)” in the past tense.

Verbs of motion pose a challenge to the traditional view of Russian verbal morphology. It has been noticed that some verbs that seem to be derived from the indeterminate verbs of motion by prefixation remain imperfective. Titelbaum (1990) describes the phenomenon as follows: “Six indeterminate verbs, however – *xodit'*, *letat'*, *voztit'*, *vodit'*, *gonjat'*, and *nosit'* – [...] seem in some cases to remain imperfective when prefixed, serving as secondary imperfectives of their prefixed determinate counterparts *idti*, *letet'*, *vezti*, *vesti*, *gnat'*, and *nesti*.”

As an example, consider the pair of motion verbs *letet'*/*letat'* ‘to fly’. According to the traditional view, if the prefix *pri-* is combined with *letet'*_{det} ‘to fly’, the resulting verb is *priletet'*^{PF} ‘to arrive by flying’ and when the source verb is *letat'*_{indet} ‘to fly’, the derived verb is *priletat'*^{IPF} ‘to arrive/be arriving by flying’. Thus, the two derived verbs are of different aspect: *priletet'* ‘to arrive by flying’,

²⁰The material presented in this section is published in Zinova & Osswald (2016).

Table 2.3: Determinate/indeterminate motion verb pairs in Russian

determinate	indeterminate	
<i>idítí</i>	<i>xodít'</i>	'walk, go'
<i>bežát'</i>	<i>bégat'</i>	'run'
<i>letét'</i>	<i>letát'</i>	'fly'
<i>plyt'</i>	<i>plávat'</i>	'swim, sail'
<i>breští</i>	<i>brodít'</i>	'stroll, trudge'
<i>polztí</i>	<i>pólzat'</i>	'crawl'
<i>katít'sja</i>	<i>katát'sja</i>	'roll'
<i>lezt'</i>	<i>lázit'</i>	'climb, clamber'
<i>éxat'</i>	<i>ézdít'</i>	'ride'
<i>gnát'sja</i>	<i>gonját'sja</i>	'chase'
<i>nestís'</i>	<i>nosít'sja</i>	'rush'
<i>nestí</i>	<i>nosít'</i>	'carry'
<i>taščít'</i>	<i>taskát'</i>	'drag'
<i>katít'</i>	<i>katát'</i>	'roll, convey in a wheeled vehicle'
<i>gnat'</i>	<i>gonját'</i>	'drive'
<i>vestí</i>	<i>vodít'</i>	'lead'
<i>veztí</i>	<i>vozít'</i>	'haul, carry by conveyance'

in accordance with the standard view on prefixation, is perfective, while *priletat'* 'to arrive/be arriving by flying' is not. This is schematically illustrated in (90) and examples of the usage of the two prefixed motion verbs are provided in (91). In (91a) the prefixed determinate verb is used to describe a single event of arrival that happened in the past. In (91b) the prefixed indeterminate verb denotes a series of arrivals that happened regularly.

- (90) a. *letét'*^{IPF} → *priletét'*^{PF}
 'to fly' 'to arrive by flying'
- b. *letát'*^{IPF} → *priletát'*^{IPF}
 'to fly' 'to arrive/be arriving by flying'
- (91) a. On *priletel'*^{PF} v Berlin.
 he pri.fly.PST.SG.M in Berlin
 'He came to Berlin (by plane).'
- b. On *priletal'*^{IPF} v Berlin po voskresenjam.
 he pri.fly.PST.SG.M in Berlin on Sunday.PL
 'He came to Berlin on Sundays (by plane).'

2 A novel approach to the analysis of Russian complex verbs

The phenomenon illustrated in (90) has attracted a lot of attention without receiving any final solution. Two main views are continuously advocated in the literature. The first is illustrated above with the citation from Titelbaum (1990). It amounts to postulating an exceptional group of verbs that, when prefixed with certain prefixes, remain imperfective. Examples of this view include Meillet (1902: 46), Mazon (1908: 5), and Vondrák (1908), and later supported by Šaxmatov (1941), Gvozdev (1973), Vinogradov (1972), Townsend (1975), Švedova (1982), Wade (1992), Nessel (2008), and Janda (2010), among others. The second view considers these verbs that seem exceptionally imperfective to be secondary imperfectives derived from the prefixed determinate motion verbs, as illustrated by the chain (92). Examples of this view include Regnéll (1944), Isačenko (1960: 337-344), Zaliznjak & Šmelëv (2000: 87-95), Romanova (2006), and others.

- (92) letét^{'IPF} → priletét^{'PF} → priletát^{'IPF}
 'to fly' 'to arrive by flying' 'to arrive/be arriving by flying'

First let us assume that some motion verbs are exceptional and do not become perfective when prefixed. Since this is the oldest and more widespread view, in what follows I will call it *the traditional view*. As an example, consider the pair of verbs *letet'/letat'* 'to fly'. The result of the prefixation of these verbs with *pri-* are the verbs *priletat*^{'IPF} 'to arrive/be arriving by flying' and *priletet*^{'PF} 'to arrive by flying', as has been shown in (90).

Now let us look at two more cases of prefixation. When the determinate verb *letet*^{'IPF} 'to fly' is prefixed with *pro-*, the derived verb *proletet*^{'PF} 'to pass by flying' is perfective. Example (94a) illustrates one usage of this verb. If the indeterminate verb *letat*^{'IPF} 'to fly' is combined with *pro-*, two verbs are obtained: a perfective verb *proletat*^{'PF} 'to spend some time flying' and an imperfective verb *proletat*^{'IPF} 'to fly/be flying past something'. This is schematically represented in (93). The usage of the perfective verb *proletat*^{'PF} 'to spend some time flying' is illustrated by (94b) and the usage of the imperfective verb *proletat*^{'IPF} 'to fly/be flying past something' is illustrated by (94c).

- (93) a. letét^{'IPF} → proletét^{'PF}
 'to fly' 'to fly some distance or past something'
 b. letát^{'IPF} →
 'to fly'
 proletát^{'IPF/PF}
 'to be flying past something' / 'to spend some time flying'
- (94) a. My proleteli^{'PF} mimo Berlina.
 we pro.fly.PST.PL past Berlin
 'We flew over Berlin.'

- b. V 3 časa my proletali^{IPF} nad lesom.
 in 3 hours we pro.fly.PST.PL over forest
 ‘At 3 o’clock we were flying over the forest.’
- c. My proletali^{PF} nad lesom celyj den’.
 we pro.fly.PST.PL over forest whole day
 ‘We have spent the whole day flying over the forest.’

One more case that completes the set of crucial examples is prefixation with *po-*. It turns out that the derived *po-*prefixed verbs are always perfective, as illustrated by (95). The verb *poletét*^{PF} (derived from the determinate verb *letét*^{IPF}) denotes the start of flying (96a). The verb *poletát*^{PF} (derived from the indeterminate verb *letát*^{IPF}) denotes a flying event that lasted for a relatively short time (96b).

- (95) a. *letét*^{IPF} → *poletét*^{PF}
 ‘to fly’ ‘to start flying’
- b. *letát*^{IPF} → *poletát*^{PF}
 ‘to fly’ ‘to spend short time flying’
- (96) a. Ptenec *poletel*.
 nestling po.fly.PST.SG.M
 ‘The nestling started to fly.’
- b. Ja *poletaju* i *verнус’*.
 I po.fly.PRES.1SG and come.back
 ‘I will fly a bit and come back.’

So, under the traditional view, one has to assume that the result of prefixation of a determinate verb is always a perfective verb while the result of prefixation of an indeterminate verb depends on the prefix: it can be either an imperfective verb in case of the prefix *pri-*, both perfective and imperfective verbs in case of the prefix *pro-*, and a perfective verb in case of the prefix *po-*. An illustration, summarising the examples above, is provided in Figure 2.7.

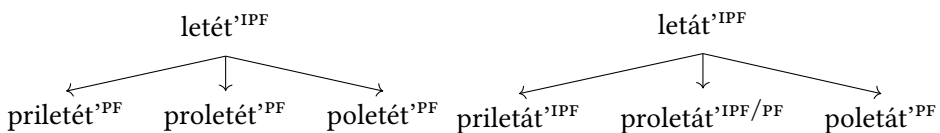

Figure 2.7: Traditional analysis

Adopting the traditional view requires us to provide some explanation why only indeterminate motion verbs do not follow the common pattern of turning

2 A novel approach to the analysis of Russian complex verbs

perfective when prefixed (with certain prefixes). The only candidate explanation (apart from bare postulations that some pairs of verbal prefixes and motion verbs constitute an exception) is offered in Janda 2010. It is based on the approach to the Russian aspectual system offered in Janda 2007. This approach uses a cluster model instead of the binary opposition of perfective/imperfective verbs. The theory of Janda (2010) also makes use of the notion of *completability* introduced in Janda 2007. A completable situation, according to Janda (2010: 129), “is one that makes progress and will usually reach a natural conclusion if it is continued”. The key idea is that, while most Russian verbs are ambiguous with respect to completability, motion verbs are specialised in this respect: determinate verbs are used to denote completable functions and indeterminate verbs are used for non-completable functions. Janda (2010: 138) concludes, that due to non-completability, indeterminate verbs form prefixed imperfectives and “three types of perfectives: Complex Act Perfectives that express engagement in an activity that is bounded in time; Single Act Perfectives that express a single cycle of a repeated action, namely a single round trip; and Specialised Perfectives that narrow reference to only a subset of the action described by the stem”.

Now let us consider a subclass of motion verbs that differ from pairs like *letat'*_{indet}-*letet'*_{det} ‘to fly’ with respect to the position of the stress, e.g., *bégat'*_{indet}-*bežát'*_{det} ‘to run’. The argument that follows is mentioned by Isačenko (1960), but is not considered in detail there, so I would like to go through it thoroughly.

It is assumed that, among the pairs of verbs of motion listed in Table 2.3, there are seven pairs that behave like *letat'*_{indet}/*letet'*_{det} ‘to fly’. Table 2.4 shows the result of prefixation of both members in each pair with the prefix *pro-*. Now let us consider the pair *bégat'*_{indet}/*bežát'*_{det} ‘to run’ (the pair *pólzat'*_{indet}/*polztí'*_{det} ‘to crawl’ behaves similarly). The crucial difference from the verbs in Table 2.4 is that in the pair of verbs *bégat'*_{indet}/*bežát'*_{det} ‘to run’ the position of the stress in the determinate verb is different from the position of stress in the indeterminate verb. So the imperfective and perfective prefixed verbs that were phonologically identical in the case we have considered before (*proletat'*^{IPF} ‘to spend some time flying’ and *proletat'*^{IPF} ‘to fly/be flying past something’) now look the same in written form but have different stress positions. Due to this fact, there is no way to represent *probegat'* as being one verb. There are two homographs: *probégat'*^{IPF} ‘to spend some time running’ and *probegát'*^{IPF} ‘to be running past something’.

Janda (2010) does not draw a distinction between the verbs of the *letat'*_{indet}/*letet'*_{det} (‘to fly’) and *bégat'*_{indet}/*bežát'*_{det} (‘to run’) type. The problem that arises is an unexpected stress shift that happens when prefixed imperfectives are formed from indeterminate stems, like in *probegát'*^{IPF} ‘to run/be running past something’. In the case where a prefixed perfective is formed from the same verb with the

Table 2.4: Prefixation with *pro-*: traditional view

type of motion	indet	pro+indet	det	pro+det
go	xodit'	proxodit' ^{IPF/PF}	idti	projti
fly	letat'	proletat' ^{IPF/PF}	letet'	proletet'
chase	gonjat'	progonjat' ^{IPF/PF}	gnat'	prognat'
haul	vozit'	provozit' ^{IPF/PF}	vesti	provesti
carry	nosit'	pronosit' ^{IPF/PF}	nesti	pronesti
rush	nosit'sja	pronosit'sja ^{IPF/PF}	nestis'	pronestis'
lead	vodit'	provodit' ^{IPF/PF}	vesti	provesti

same prefix (*probégat*^{PF} 'to run for some time'), no stress shift happens. This is illustrated by the derivational chains (97a) and (97b). This stress shift is not explained in Janda (2010).

- (97) a. *bégat*^{IPF} → *probégat*^{PF}
 'to run' 'to run for some time'
- b. *bégat*^{IPF} ? → *probegát*^{IPF}
 'to run' 'to run/be running past something'

Unlike Janda (2010), most researchers that accept the traditional view assume that the verb *probegát*^{IPF} 'to be running past something' is not an exceptional imperfective verb formed from the indeterminate verb *bégat*^{IPF}, but the secondary imperfective of the prefixed determinate verb *bežát*^{IPF}. It would then follow that the exceptional status of the six verbs listed in the Table 2.4 as opposed to the pairs *bégat*'/*bežát*' ('to run') and *pólzat*'/*polzti*' ('to crawl') is based only on the same stress position in both verbs of the pair.

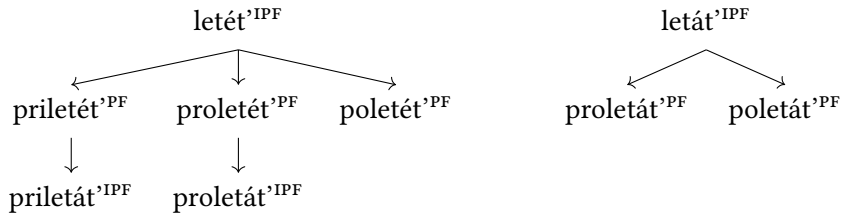

Figure 2.8: Reanalysis of the traditional view (cf. Figure 2.7)

Being left without any explanation in the literature defending the traditional view, let us turn to the alternative view, schematically represented in Figure 2.8.

2 A novel approach to the analysis of Russian complex verbs

Regnéll (1944) provides the following two arguments in favor of analysing prefixed imperfective verbs of motion as secondary imperfectives of the prefixed determinate verbs. First, indeterminate motion verbs, such as *nosit'*_{indet} 'to carry', contain (at least originally) a component of iterativity, while the corresponding prefixed imperfective verbs, such as *prinosit'* 'to bring/be bringing', lack it (this was noticed already by Mazon 1928). Second, some verbs clearly do not follow the pattern "indeterminate verb+prefix". For example, *priplyvat'* 'to come/be coming by swimming' is not formed by *pri-* + **plyvat'*, as the latter does not exist. Generally speaking, only one subclass of motion verbs demonstrates what seems to be an exceptional behaviour, while the other subclass produces regular secondary imperfective forms. Another point is that, in other Slavic languages, verbs similar to the Russian "exceptional" ones are clearly secondary imperfective forms, and all the verbs that are the result of direct prefixation of motion verbs are perfective.

Another kind of argumentation is provided by Romanova (2006: 146). She argues that prefixed imperfective verbs cannot occur as a result of prefixation of indeterminate motion verbs because those verbs cannot be combined with lexical prefixes. Consider the verbs *probegát'*^{IPF} 'to be running past something' and *probégat'*^{PF} 'to run for some time'. According to the theory advocated by Romanova (2006), the first verb contains a lexical prefix, whereas the second verb contains a superlexical prefix. Romanova's analysis of motion verbs includes the assumption that the position for lexical prefixes is already occupied in the structure of a non-prefixed indeterminate motion verb. From this it follows that the verb *probegát'*^{IPF} 'to be running past something', that contains a lexical prefix, cannot be derived from the indeterminate motion verb *begat'* 'to run'. This argument is based on the assumption of syntactic differences between superlexical and lexical prefixes as well as specific differences in the internal syntactic structure of motion verbs. As this assumption is examined in Chapter 3 and I propose to abandon it in its current form, I will not go into further details of such an approach here.

From the discussion in the literature and the facts examined above I conclude that there are no solid reasons to consider prefixation of indeterminate motion verbs to be exceptional and non-perfectivising. So let us stick to the derivations as they are presented in Figure 2.9, where all the motion verbs that are obtained by prefixation, whether determinate or indeterminate, are perfective, and some can be consequently imperfectivised.

It is worth mentioning that the imperfectivisation step that is included in the analysis represented on Figure 2.9 is attested in Russian, though it is not very

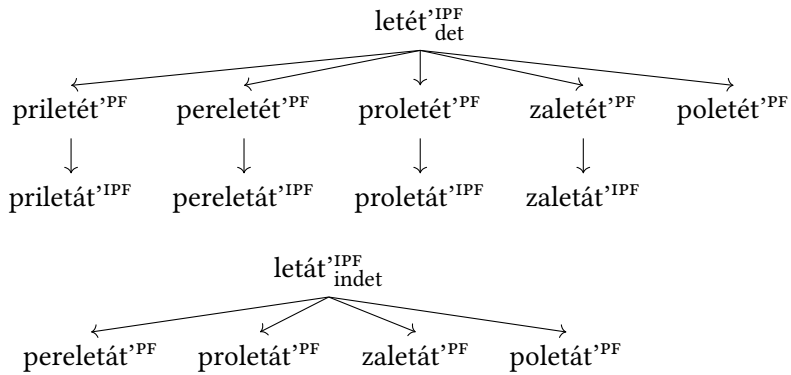

Figure 2.9: Derivational trees for motions verbs

common with unprefixated verbs. The following pairs illustrate this way of deriving imperfective verbs from the perfective source verbs: *brosit*^{PF} – *brosat*^{IPF} ‘to throw’, *lišit*^{PF} – *lišat*^{IPF} ‘to deprive’, *rešit*^{PF} – *rešat*^{IPF} ‘to solve’, *končit*^{PF} – *končat*^{IPF}, *prostit*^{PF} – *proščat*^{IPF} ‘to forgive’, *pustit*^{PF} – *puskat*^{IPF} ‘to let’, *obidet*^{PF} – *obižat*^{IPF} ‘to offend’, *voskresit*^{PF} – *voskrešat*^{IPF} ‘to resurrect’.

There are still several verbs for which the formation of an imperfective from the prefixed perfective does not follow a regular pattern: *prinesti*^{PF} ‘to bring’ – *prinosit*^{IPF} ‘to bring/be bringing’ or *prijiti*^{PF} ‘to come’ – *prixodit*^{IPF} ‘to come/be coming’. The common suggestion is to explain the imperfectivisation process in such cases by analogy, as it is done, e.g., by Regnéll (1944) and Švedova (1982: 589). This problem lies in the area of historical linguistics as it requires understanding of the relative timing of different processes (emergence of certain verbs vs. formation of the aspect category in the contemporary sense) as well as information about phonological rules applied throughout the centuries when the verbs in question were present in the language. As such, I will stick to the schema provided in Figure 2.9 and leave the problem of irregular secondary imperfective formation aside.

2.4 Prefixation and telicity

Whenever prefixes and perfectivity are mentioned, the issue of telicity arises. Although a thorough discussion of the relation between verbal aspect and telicity is beyond the scope of this thesis, at least a few observations are in order.

Let us take a look at how telicity is characterised in the literature. For instance, Rothstein (2008b: 3) writes that “[t]here is an intuitive agreement that telic pred-

icates are completed or inherently bounded, but what exactly that means is very much under debate". This also means that there is no single definition of telicity on which everybody agrees. The second main issue has to do with a disagreement about the level of grammatical description at which the notion of telicity ought to be applied. Both these issues make it hard to apply any characterisation of telicity across different languages.

Several paths can be adopted in this situation. First, a number of linguists take telicity in Slavic languages to be tightly connected to perfectivity and prefixation. For example, Borer (2003) and van Hout (2008), among others, assume that Slavic prefixes encode telicity on the verb, from which it follows that all prefixed verbs are telic. This assumption was challenged by Filip (2003) who pointed out that, although it is plausible to regard all perfective verbs as semantically telic, prefixes cannot be viewed as perfectivity or telicity markers.

Another approach, offered by Padučeva & Pentus (2008), follows the opposite path: separate telicity and aspect. The authors talk about telicity of aspectless verbal predicates. I find this approach interesting but unnatural, as aspect in Russian is not an inflectional category.

The notion of telicity has been originally developed on the basis of English data. The main tests used to identify telic predicates are (i) compatibility with temporal adverbials (*in x time/for x time*) and (ii) interpretation in the progressive aspect. The second test obviously cannot be applied to Russian data, because Russian does not have a grammaticalised progressive aspect. Moreover, the existence of true aspectual pairs (pairs of verb forms that only differ in aspect, but not in their lexical content) in Russian is controversial. What is left then is the first test, that indeed is often transferred to Russian as a semantic test for telicity: if an accusative time measure phrase (e.g., *X časov/minut* 'for X hours/minutes') can be added to the verbal phrase, the verbal predicate is considered atelic; if a prepositional measure phrase (e.g., *za X časov/minut* 'in X hours/minutes') can be added, the predicate is considered telic.

Example (98) illustrates the application of the test in the basic case: the verb is formally perfective, semantically telic, and compatible with *za*-headed temporal adverbials.

- (98) Ona svarila^{PF} sup za 3 časa.
 she s.boil.PST.SG.F soup.ACC behind 3 hours
 'She cooked the soup in 3 hours.'

This test, however, does not work with all perfective telic verbs. It is neither obligatory for the telic verbal description to be compatible with the *za*-headed tem-

poral adverbial nor does such compatibility indicate that the predicate denotes a set of single completed events. Consider the prefix *po-*. The verb *počitat*^{PF} ‘to read for some time’ is perfective and it denotes a set of bounded reading events, but it is only compatible with accusative temporal adverbials, as illustrated by (99).

- (99) a. On počital knigu pjat’ minut.
 he po.read.PST.SG.M book.SG.ACC five.ACC minute.PL.GEN
 ‘He read the book for 5 minutes.’
- b. *On počital knigu za pjat’ minut.
 he po.read.PST.SG.M book.SG.ACC behind five.ACC minute.PL.GEN

So if the compatibility with different temporal adverbials is regarded as a test for telicity for Russian, we would have to assume that some perfective verbs and even verb phrases (on the assumption that telicity is determined on the VP level, e.g. Borer 2005) could be atelic. This is not a problem per se, but does not agree with the semantic definition: if, according to the definition of Rothstein (2008b: 3), any predicate that denotes a set of either completed or bounded events is telic, then the verb *počitat* ‘read for some time’ and the verbal phrase *počitat’ knigu* ‘read the book for some time’ in (99a) are telic. From this it follows that compatibility with temporal adverbials in Russian cannot serve as a test for telicity in the sense of Rothstein (2008b).

Now the only path we are left with is the pure semantic definition of telicity: telic predicates are predicates that denote sets of bounded events. However, the application of this definition is not straightforward: there are cases for which it is hard to decide whether the set of events denoted by the verbal phrase contains only bounded events, especially when tenseless predicates are considered. For example, let us determine the telicity of the predicates in (100).

- (100) a. est’ sup
 eat.INF soup.SG.NOM
 eat soup
- b. est’ jabloko
 eat.INF apple.SG.NOM
 eat an/the apple

There will be probably no disagreement that the description (100a) (in absence of a context that would lead to a portion interpretation of the noun) is atelic. The second case is far less obvious: on the one hand, the description involves a quantised object and the corresponding English description is telic, so it is tempting

2 A novel approach to the analysis of Russian complex verbs

to consider the predicate (100b) to be telic. On the other hand, an event of partial consumption of an apple also falls under the denotation of (100b). In addition, the combination of the verb *est'* 'to eat' with explicit measure phrases is not possible (without strong contextual support and inclusion of a time measure phrase), as illustrated by (101).

- (101) # *est' dva litra supa*
 eat.INF two.M.ACC litre.SG.GEN soup.SG.GEN
 eat two litres of soup

This is unexpected if one considers that the telicity of the verb *eat* 'to eat' is determined not by the verb, but by the properties of the direct object (incremental theme). My intuition is that (100b) is an atelic description, as the theme does not contribute the measure, only the type of the object that is being consumed. The difference between the acceptability of (100b) and (101) is, in my opinion, due to the flexibility of the interpretation of nouns: *jabloko* 'apple' can be viewed as a type description and it can be viewed as a measure (where area and volume of the apple can be used for establishing the boundary of the respective scale). At the same time *sup* 'soup' (unless it is used in the sense of 'a portion of soup') is a pure type description and *dva litra supa* 'two litres of soup' is an overt measure description. These intuitions are summarised in Table 2.5.

Table 2.5: Interpretation of noun phrases

noun phrase	translation	type description	measure description
<i>sup</i>	'soup'	+	-
<i>jabloko</i>	'apple'	+	+
<i>dva litra supa</i>	'two litres of soup'	-	+

I will leave further discussion of telicity in Russian for future work. However, I will provide some answers to the questions that are related to the notion of telicity. For English, saying that a predicate is telic is equivalent to saying that it is compatible with certain time measure adverbials and gives rise (or not) to the imperfective paradox, as those properties are tied together. While leaving the notion of telicity outside of the upcoming discussion in Chapter 4, I will provide a (somewhat implicit) answer to the question of compatibility of verbal predicates with various types of time frame adverbials: as soon as we have semantic representations of verbs, prefixes, noun phrases, and time measure phrases (see Chapter 6), the compatibility or incompatibility will be predicted without using any extra features.

As for the conceptual part of the notion of telicity, it too will be present in my account, but without the name that raises additional questions. The whole account that I offer is based on scales and measurement and, as was pointed out in Rothstein (2008a: 60), “Information about measurement cannot be ignored and the calculation of telicity is fully compositional, working from the verbal head upwards.” So I will not label predicates except with the types that will be used in the semantic representations (and they will resemble Vendler classes, as there are *processes*, *states*, *events*, and *transitions*) and I will use scales and measurement and composition to calculate the possible combinations of various elements. I will also use terms *bounded* and *unbounded* and define them with respect to the semantic representation of predicates. I will leave the mapping of these categories to the traditional notion of telicity and to the behaviour of the corresponding English verbs for future work.

2.5 Summary

In this chapter we have discussed the main issues related to perfectivity. First, I have presented the basic facts about aspectual opposition in Russian. Then we have explored the existing approaches to the internal structure of complex verbs and found a group of verbs that are supposed to have different aspect under various accounts. Then we have proceeded with information about tests that help to identify aspect and shown that all the existing tests fail to distinguish imperfective verbs from biaspectual ones. In order to fill this gap, I have proposed a new test, one based on the Narration relation. This test allows to identify in a positive way whether a given verb can be used as a perfective verb, and thus serves to distinguish biaspectual verbs from perfective verbs.

In the next part of the chapter I have introduced the notions of derivational chains and a derivational graph. These instruments provide a possibility to explore the data in a more objective way and only exclude derivations that are not possible in the language, regardless of the preferred theory of a given researcher. As the described graph does not exist in its full form, judgements on the following chapters are based on examples from corpora/the web, where each derivation is checked against the proposed definition of a derivational chain.

The last part of the chapter addressed the issue of biaspectuality and imperfectivity in relation to prefixation. I have presented data concerning the attachment of the iterative prefix *pere-* to secondary imperfective verbs and compared the behaviour of native and loaned biaspectual verbs and prefixes. In sum, the number of cases when prefixation does not lead to perfectivisation turns out to be higher

2 A novel approach to the analysis of Russian complex verbs

than traditionally assumed, but further research is needed to bring more clarity in this regard. On the other hand, as it was shown in the very last part of the chapter, prefixed motion verbs do not constitute an exception to the “prefixation leads to perfectivisation” rule, contrary to numerous claims in the literature. In this respect, I have given evidence for an alternative analysis that does not require to postulate an exceptional group of motion verbs. With this, we are now ready to move on to a thorough discussion of the lexical/superlexical division of prefixes.

3 Lexical and superlexical prefixes?

This chapter discusses the distinction between lexical and superlexical prefixes in detail. This opposition constitutes the main driving force of the syntactic approaches to Russian prefixation (Ramchand 2004; Svenonius 2004b; Romanova 2006, among others), as prefixes that belong to different groups are claimed to have distinct syntactic positions and properties. In what follows I provide details about the history and various refinements of this distinction and discuss problems it involves. I then show that neither the bipartite nor the more fine-grained distinctions are sufficient to account for the full range of data. Based on the observations about the vagueness of the distinction together with insufficient predictive power, I abandon the hypothesis that the formation of complex verbs depends primarily on the structural positions of the affixes and develop an alternative (semantic) approach in Chapter 4.

The methodology of gathering and assessing the data proposed in Chapter 2 will be (mostly implicitly) used throughout the discussion in this chapter, as it allows to identify examples that are problematic if one does not presuppose any linguistic theory prior to collecting the data.

The chapter is organised as follows: first, in Section 3.1 I consider the main properties attributed to the prefixes of the superlexical group. In Section 3.2 I look at the ambiguity of classification stemming from different works. Sections 3.3–3.6 discuss the problems that arise with each of the four properties attributed to the class of superlexical prefixes. Section 3.7 is dedicated to the more elaborated classifications proposed in Tatevosov (2007; 2009). Section 3.8 concludes the discussion.

3.1 Main properties

The main idea of the classification discussed in this chapter has its origin in the long-standing tradition of distinguishing between two types of prefixes (Isačenko 1960; Forsyth 1970; Townsend 1975): lexical prefixes (also called “qualifying” or “internal” prefixes) vs. prefixes that derive Aktionsart verbs (“modifying” in the terminology of Isačenko, later in the literature called “superlexical” or “external”).

3 Lexical and superlexical prefixes?

The original idea of Isačenko (1960: 222–224) is to divide verbal prefixes into two classes on the basis of their semantic contribution to the meaning of the derived verb. Isačenko proposes that a qualifying prefix characterises the verbal meaning from the outside, altering the lexical meaning of the derivational base. The derived verb acquires a meaning detached from the meaning of its input and becomes a new independent lexeme. A modifying prefix, on the other hand, does not change the lexical meaning of the derivational base, but rather emphasises one of the inner characteristics of the process denoted by the non-prefixed verb.

As an example, Isačenko (1960) provides the prefixes *raz-* and *za-*: when the prefix *raz-* is attached to the verb *rval*^{'IPF} 'to tear', the resulting verb *razorval*^{'PF} acquires a new lexical meaning 'to tear apart/to pieces'. When, on the other hand, the prefix *za-* is attached to the verb *govorit*^{'IPF} 'to talk', the meaning of the resulting verb *zagovorit*^{'PF} 'to start talking' can be viewed as a shift of focus to delete the initial phase of the event denoted by the derivational base.

Isačenko (1960) also argues that verbs derived by the qualifying prefixes are grammatically distinct from the verbs derived by the modifying prefixes: the former and not the latter allow secondary imperfectivisation. Note that in the original proposal by Isačenko (1960) this is motivated by the semantics of the derived verb, based on whether it is distinct from that of the derivational base. This is the idea that I will (at least partially) return to in my analysis.

A couple of decades later the division of the prefixes into lexical/internal and superlexical/external¹ became the key component in contemporary (mostly syntactically-based) approaches to Russian prefixation (Schoorlemmer 1995; Babko-Malaya 1999; Borik 2002; Gehrke 2004; Ramchand 2004; Romanova 2004; 2006; Svenonius 2004a,b; Di Sciullo & Slabakova 2005). Following Svenonius (2004b: 229), who builds on the discussion of Russian by Schoorlemmer (1995), these two groups are distinguished according to the following diagnostics:

1. superlexical prefixes do not allow the formation of secondary imperfectives (invalid in Bulgarian),
2. superlexical prefixes can occasionally stack outside lexical prefixes, never inside,
3. superlexical prefixes select for imperfective stems,
4. superlexical prefixes attach to the non-directed form of a motion verb,

¹Note that the prefixes that, according to Isačenko (1960), modify the semantics of the verb *externally*, are called *internal* in the later literature, while prefixes that modify the *internal* aspects of the process denoted by the derivational base are later called *external*.

5. superlexical prefixes have systematic, temporal or quantising meanings, rather than spatial or resultative ones.

Babko-Malaya (1999) was the first to propose that the internal structure of complex verbs is represented by means of syntactic trees and that lexical and superlexical prefixes occupy different syntactic positions. More precisely, lexical prefixes are adjoined to a lexical head, while superlexical prefixes are adjoined to a functional category instead. Babko-Malaya predicts that “lexical prefixes modify the meaning of the verb, whereas superlexical prefixes are modifiers of verbal phrases or whole sentences” (Babko-Malaya 1999: 76). The (im)perfective aspect of a given complex verb is then determined by the properties of the highest affix in a structure. In what follows, let us have a look at some proposals that follow this research program.

Romanova (2004) proposes the structure for Russian verbs that is represented in Figure 3.1. Romanova (2004: 272) assumes “the presence of *AspP* in between *VP* and *vP*”, that “is a possible place for merge of the secondary imperfective suffix or purely perfectivizing prefixes”. She also postulates that lexical prefixes are located below *AspP*, while “superlexical prefixes originate – or at least end up – above the *AspP* domain” (p. 271). Throughout the paper, a lot of questions regarding the behaviour of prefixes are posed and the author arrives at the conclusion that “there is no uniform distribution of all superlexicals”.

While Babko-Malaya (1999) and Schoorlemmer (1995) (among others) assume that superlexical prefixes form a homogeneous class, Svenonius (2004b) argues that there is a tripartite division among superlexical prefixes based on their ability to form secondary imperfectives.

According to Svenonius (2004b), certain superlexical prefixes (*za-* with inceptive meaning, *ot-* with terminative meaning, and *pere-* with distributive meaning²) may be attached higher than the structural position of the imperfective suffix, which is *Asp*, the head of *AspP*. Such prefixes disallow the formation of secondary imperfectives (e.g., *za-* in its inceptive use). That is, the imperfective suffix cannot be directly attached to an imperfective stem and the result is an invalid structure (see Figure 3.2).

There are also mixed cases like cumulative *na-*, excessive *pere-*, and attenuative *po-*. The normal point of attachment of such prefixes, according to Svenonius (2004b: 231), is outside the scope of the secondary imperfective, although under certain exceptional conditions they allow a lower point of attachment.

²*pere-* has a variety of meanings (e.g. Švedova 1982 distinguishes between ten different meanings) including spatial, temporal, comparative, iterative, crossing the boundary, distributive, and excessive *pere-*. See Section 4.6 for more information.

3 Lexical and superlexical prefixes?

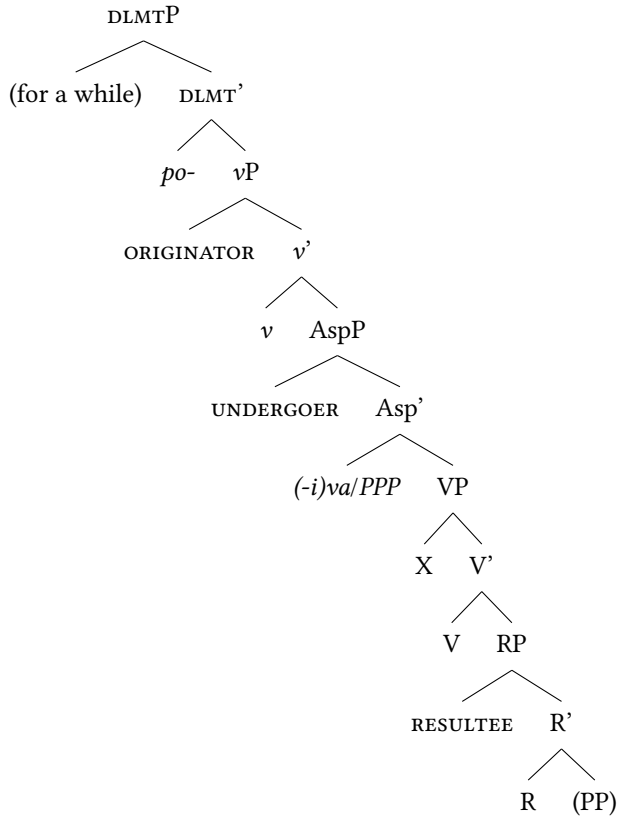

Figure 3.1: Verbal structure according to Romanova (2004: 272)

Svenonius' main generalisations can be stated as follows (see also the summary in Svenonius 2012):

1. lexical prefixes originate inside vP ;
2. superlexical prefixes originate outside vP ;
3. lexical and superlexical prefixes that (according to him) disallow secondary imperfectivisation are separated by *Asp* in the syntactic structure;
4. exceptional superlexical prefixes are merged (sometimes) outside vP , but below the *Asp*.

From another study that follows the same tradition, Ramchand 2004, the following “bottom-up” order of verbal affixes emerges:

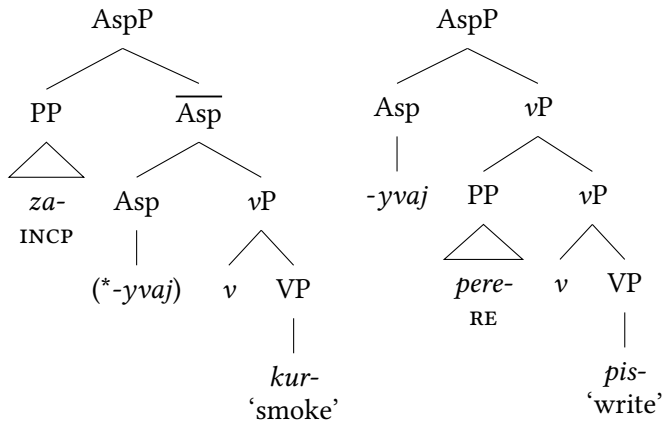

Figure 3.2: Verbal structure according to Svenonius (2004b: 231)

1. lexical prefixes;
2. an aspectual head that may contain either the imperfective suffix or a superlexical prefix;
3. a DP projection for superlexical distributional prefixes (she cites *pere-* and *po-*).

While the motivation for this hierarchical order is not entirely clear, it would seem to derive from the following assumptions made by Ramchand (2004):

1. lexical prefixes appear low in the syntactic structure, due to which a “pre-suppositional structure to the aspectual head” is introduced “to the effect that it creates a definite rather than an indefinite time moment in Asp” (p. 349);
2. most superlexical prefixes are in Asp and “impose a specific reference time on the relation between event and temporal anchoring” (p. 351);
3. a position that superlexical prefixes which are distributional (*pere-* and distributive *po-*) occupy is higher in the hierarchy than the Asp head (p. 352); such prefixes can be attached directly to the root or to the secondary imperfective verb.

The fundamental two-way distinction is of key importance for Romanova (2004), Svenonius (2004b), and Ramchand (2004). Putting it simply, the main idea is that

3 *Lexical and superlexical prefixes?*

lexical prefixes occupy lower positions in the syntactic tree than the superlexical ones. Though it is possible that there is more than one position for superlexical prefixes, all such positions should be higher than the one (unique) position for the lexical prefixes.

Due to this syntactic difference, superlexical prefixes are claimed to have the following properties:

1. they provide a systematic semantic contribution and do not change the lexical meaning of the verb;
2. they are incompatible with secondary imperfectivisation;
3. they do not change the argument structure of the verb;
4. they appear to the left of the lexical prefixes (if two or more prefixes are stacked).

Lexical prefixes, on the other hand, are expected to change the lexical meaning of the verb, allow for secondary imperfectivisation, change the argument structure of the verb, and always appear closer to the stem when prefix stacking occurs. At the same time two lexical prefixes can never stack, as there is a single position where they are allowed. While specific analyses vary a lot, this general idea remains the same.

The distinction between the lexical and superlexical prefixes has received some amount of criticism in the recent literature. For example, Braginsky (2008), analysing different usages of the prefix *za-*, arrives at the conclusion that “the contrasts between inchoative and non-inchoative prefixes *za-* cannot be accounted for by simply relating them to different structural positions on the syntactic tree” (p. 224). Let me now analyse in detail properties that are attributed to superlexical prefixes and problems that arise when one tries to use the lexical/superlexical distinction for analysing complex verbs in Russian.

3.2 **Classification ambiguity**

The general problem of the lexical/superlexical distinction has been pointed out by Kagan (2015: 32): many prefixes are not easily classified as either lexical or superlexical as they do not have the whole cluster of properties of one of the groups, but rather a mixture. This results in a range of classifications offered by different researchers. Table 3.1 summarises various proposals in this respect.

Table 3.1: Superlexical prefix inventory according to different studies

prefix	Babko-Malaya (1999)	Svenonius (2004a)	Svenonius (2004b) ^a	Ramchand (2004)	Romanova (2006)	Tatevosov (2009)	Svenonius (2012) ^b
inchoative <i>za-</i>	+	+	+	+	+	+	+
cumulative <i>na-</i>	-	+	+	+	+	+	+
saturative <i>na-</i>	-	+	-	-	-	-	+
repetitive <i>pere-</i>	-	+	+	-	-	+	+
excessive <i>pere-</i>	-	+	+	-	-	-	+
distributive <i>pere-</i>	-	-	+	-	+	+	+
distributive <i>po-</i>	-	+	-	-	+	+	+
delimitative <i>po-</i>	+	+	-	+	+	+	+
attenuative <i>po-</i>	-	+	+	-	-	-	+
attenuative <i>pri-</i>	-	-	-	-	+	-	-
attenuative <i>pod-</i>	-	-	-	-	+	+	-
terminative <i>ot-</i>	-	+	+	-	+	-	+
perdurative <i>pro-</i>	+	+	-	-	-	-	+
completive <i>iz-</i>	-	+	+	-	-	-	+
completive <i>do-</i>	-	+	-	+	-	+	+

^aSvenonius (2004b) provides a classification of Russian prefixes from the point of view of the formation of the secondary imperfective, but does not state whether the list is exhaustive.

^bSvenonius (2012) marks the list as taken from Svenonius (2004a), but the lists vary significantly.

3 Lexical and superlexical prefixes?

The rows of Table 3.1 show ten prefixes (*za-*, *na-*, *pere-*, *po-*, *pri-*, *pod-*, *ot-*, *pro-*, *iz-*, *do-*) together with their interpretations (up to three in case of the prefixes *pere-* and *po-*). The columns of the table represent seven different proposals: Babko-Malaya 1999, Svenonius 2004a, Svenonius 2004b, Ramchand 2004, Romanova 2006, Tatevosov 2009, and Svenonius 2012. A plus in the intersection indicates that the prefix of the row (with the fixed interpretation) is listed as superlexical in the work that names the column. As lexical prefixes are usually not explicitly listed, a minus in the intersection only indicates that the prefix with specific meaning is not listed as superlexical.

As is evident from the table, there is only one prefix that is overtly classified as superlexical in all the discussed studies: the inchoative prefix *za-*. For two more prefixes, cumulative *na-* and delimitative *po-*, there is almost complete consensus: all but one study describe them as being superlexical. Among the remaining prefixes, there is no single prefix listed as superlexical in five out of seven discussed works. After this gap comes a group of prefixes that are accepted as superlexical in most accounts represented in the table: repetitive *pere-*, distributive *pere-*, distributive *po-*, terminative *ot-*, and completive *do-*. This makes a total of three prefixes in the “strong” group and five more in the “weak” group. A further seven prefixes are considered superlexical only in a couple of studies. Note that there is no pair of works with identical lists of superlexical prefixes.

Such variability in the decisions about which prefix (even under a particular interpretation) falls into one of the two groups (lexical or superlexical) clearly shows that this distinction is problematic: the properties that are claimed to be associated with the superlexical prefixes do not coincide. I believe that they are not completely independent of each other, but the connection is weaker than is commonly assumed. Let us now discuss different properties attributed to the members of the superlexical class of prefixes and see if they are supported by the language data.

3.3 Semantics of the derived verb

The compositionality of meaning is one of the main characteristics of the superlexical prefixes, as shown in the summary provided in Section 3.1. It is important to note, however, that this property is not very valuable if we classify prefixes together with certain fixed interpretations. For instance, if one takes into account only inchoative usages of *za-*, then verbs formed with the inchoative prefix *za-* will all have the meaning of inception of the activity described by the derivational base. All the other *za-*-prefixed verbs, even if their semantics is perceived

as being close to that of inception, will remain outside the focus set of verbs. This means that when the prefix usages are classified, the property of contributing a compositional meaning is reduced to the productivity of a particular meaning of a given prefix. This said, one has to note that many prefixes that are classified as lexical have systematic transparent contributions: e.g., spatial prefixes when combined with motion verbs. Consider, in particular, the spatial usage of the prefix *pere-*, ‘to cross’. Whenever this prefix is attached to a directed motion verb, it contributes the meaning ‘to cross something in a manner denoted by the derivational base’, that can also be reformulated as ‘to perform the motion denoted by the derivational base along the path that crosses the landmark’. However, this prefix (and other similar ones) are not considered superlexical.

One may reply at this point, that it is not only the systematic semantic contribution, but the absence of change in the lexical meaning, that distinguishes superlexical prefixes from lexical ones. Let us consider the verb *proplyt*^{PF} ‘to swim a certain distance’ and the verb *proplavat*^{PF} ‘to swim for a certain time’. In the first case we are dealing with the spatial interpretation prefix *pro-* that is considered to be lexical, while in the second case the same prefix is interpreted temporally and is considered to be superlexical by Babko-Malaya (1999), Svenonius (2004a), and Svenonius (2012). Given the semantics of the derived verbs and the possibility of the unified analyses of the prefix *pro-* in these cases (Kagan 2015; Zinova & Osswald 2016), it would be very hard to argue that one of these prefixes affects the lexical meaning of the verb, while the other does not.

3.4 Secondary imperfectivisation

Another criterion that is used for establishing the lexical/superlexical status of a prefix with a fixed interpretation is the (un)availability of the secondary imperfectivisation. Basically, superlexically prefixed verbs should not allow secondary imperfectivisation while lexically prefixed verbs should be easily imperfectivised. Unfortunately, things are not as clear and there are exceptions from this rule in both directions.

To overcome this difficulty, Svenonius (2004b) and Tatevosov (2007; 2009) propose to split superlexical prefixes into further groups and to distinguish subclasses of superlexical prefixes that allow subsequent imperfectivisation. Note that in this case the property of used to delimit the classes (nemaly, having potential for further imperfectivisation), is not derived from other properties of the prefixes.

Furthermore, as is noted by Kagan (2015: 35), it is not the case that the availability of the secondary imperfective verb can be predicted from the knowledge

3 Lexical and superlexical prefixes?

about the last prefix attached to the verb (and its meaning). Distinct stems, when combined with the same prefix (with a fixed interpretation) behave differently: e.g., the verb *naest'sja* 'to eat one's fill' is easily imperfectivised and the combination of the verb *nasmotret'sja* 'to spend enough time looking at something' with an imperfective suffix is weird (example taken from Kagan 2015: 35).

Let us examine the inchoative prefix *za-* that, according to both Svenonius (2004b: 230) and Tatevosov (2009: 116), disallows subsequent imperfectivisation. Consider the verb *kurit*^{1PF} 'to smoke'. Which can be prefixed with the inchoative prefix *za-*. The output of prefixation is the verb *zakurit*^{1PF} 'to start smoking'. This is a superlexically prefixed verb, according to the common classification, with the most prototypical superlexical prefix: the only one which is included in the superlexical group in all of the studies I examined. However, this verb can be further imperfectivised. The result of this operation is an imperfective verb *zakurivat*^{1PF} 'to start/be starting smoking'. As the verb *zakurit* 'to start smoking' denotes a punctual event, the natural interpretation of the verb *zakurivat* 'to start/be starting smoking' is that of a habitual event. Consider example (1). In this sentence the speaker describes his regular activity: after some other event, he always started to smoke and smoked ten cigarettes in a row.

- (1) Ja zakurival i kuril desjat' štuk, ne
 I za.smoke.imp.PST.SG.M and smoke.PST.SG.M ten piece.PL.ACC, not
 vstavaja s mesta, odnu za drugoj.
 get.up.imp.CVB.PRES from place, one behind other
 'I started to smoke and smoked ten cigarettes one after another without
 getting up.' Vasilij Aksenov, *Zvezdnyj bilet*

At the first sight it seems impossible to interpret the resulting imperfective verb progressively. If this were possible, then a possible solution to the problem could be the one by Ramchand (2004). Ramchand suggests that secondary imperfective forms with a habitual reading may be derived by a different imperfectivising operator from secondary imperfective forms with a progressive reading. The operator with a habitual reading should then be situated higher than the superlexical prefix. This proposal does not solve the problem, as it turns out that progressive interpretation of the secondary imperfective verb containing the inchoative *za-* is possible. Out of the blue a native speaker of Russian (without linguistic training) would probably deny the existence of such a reading, but all the speakers I have consulted will accept the sentence (2). The trick here is to find some other event (in this case it is a glance) that takes even less time, and hence is "more punctual". Then the event of lighting a cigarette can be viewed as a progressive one. I will discuss this issue in more detail in the next chapter.

- (2) Arkadij Sergeevič kak raz zakurival, poètomu ne
 Arkadij Sergeevich as time za.smoke.imp.PST.SG.M, that is why not
 zametil, kak na poslednej fraze Olafson počemu-to
 notice.PST.SG.M, as on last phrase Olafson because of something
 vorovato strel'nul glazami.
 thievishly shoot.sem.PST.SG.M eye.PL.INST
 'Arkadij Sergeevich was just lighting the cigarette, so he didn't notice Olaf-
 son's thievish glance during the last phrase.'

Andrej Konstantinov, *Vydumščik*

Interestingly, while Tatevosov (2009), along with Svenonius (2004b), Ramchand (2004), and others, postulate the impossibility of subsequent imperfectivisation of verbs prefixed with inchoative *za-* (p. 116), the theory described in the paper does not prohibit it, as *za-* belongs to the group of prefixes that only attach to imperfective verbs (more details will follow in Section 3.7.2). This restriction is met in the example above: the verb *kurit*^{1PF} 'to smoke' is imperfective. It turns out that for Tatevosov (2009) the only group of prefixes that disallow subsequent imperfectivisation is the group of left periphery prefixes which comprises only one prefix: distributive *po-*. This amounts to the fact that one of the main properties of superlexical prefixes is attributed to just one prefix which is, moreover, not classified as superlexical by some authors.

On the basis of the facts described above I conclude that availability of the secondary imperfective form can neither be used for classification purposes nor be reliably predicted from the lexical/superlexical status of a given prefix.

3.5 Argument structure

One more property that is said to be associated with superlexical prefixes is that they do not change the argument structure of the verb (while lexical prefixes do). As this criterion is also not unproblematic, Tatevosov (2009: 116), for example, adopts a milder version of the statement, namely, that superlexical prefixes either do not change the argument structure of the verb or restrict the possibilities of argument structure variation in a predictable way. However, there are exceptions to this property even in the latter formulation.

The crucial example here is the cumulative prefix *na-*, which is considered to be superlexical in most studies. However, its attachment changes the argument structure of the verb: verbs that are optionally transitive when unprefixed become obligatorily transitive after the attachment of the cumulative *na-*, as illustrated by (3)–(4).

3 Lexical and superlexical prefixes?

- (3) a. Maša sčítaet^{IPF} do desjati.
Maša count.PRES.3.SG until ten
'Masha can count up to ten.'
- b. *Maša nasčítaet^{PF} do desjati.
Maša na.count.PRES.3.SG until ten
- (4) a. *Maša sčítaet^{IPF} desjat' konfet.
Maša count.PRES.3.SG ten.ACC candies.GEN
- b. Maša nasčítaet^{PF} desjat' konfet.
Maša na.count.PRES.3.SG ten.ACC candies.GEN
'Masha's count of candies will be ten.'

This could be still in accordance with the proposal of Tatevosov (2009), but it turns out that the prefixed verb also provides an additional restriction on the direct object: it must be a measure phrase. The unprefixed verb *sčítat*^{IPF} 'to count/be counting' takes as a direct object any plural accusative noun phrase (see example (4a)), whereas the prefixed verb *nasčítat*^{PF} 'to count a lot of' does not (see example (4b)). It requires a measure phrase (example (5b)), which is not a valid direct object in case of the unprefixed verb (5a).

- (5) a. Maša sčítaet^{IPF} konfety.
Maša count.PRES.3.SG candies.ACC
'Masha counts candies.'
- b. *Maša nasčítaet^{PF} konfety.
Maša na.count.PRES.3.SG candies.ACC

As a result, in all three pairs of examples above involving the verbs *sčítat*/*nasčítat* 'to count' only one variant (either unprefixed or prefixed) is possible. The unprefixed verb is required in case of an indirect object, as in (3), and in case of a direct object that is not a measure phrase, as in (4). Only the prefixed verb can be used when the direct object is a measure phrase, as in example (5). In fact, there seems to be no construction in which both *sčítat* 'to count' and *nasčítat* 'to count a lot of' could be felicitously uttered.

If one considers a pair where the unprefixed verb is obligatorily transitive, as *varit*^{IPF} 'to cook/be cooking' and *navarit*^{PF} 'to cook a lot of', it turns out these two verbs require different cases of the object. If the object is an accusative noun phrase (6), it is only compatible with the unprefixed verb. If it is a genitive noun phrase, it is only compatible with the prefixed member of the pair in question, as illustrated by (7).

- (6) a. Maša varit^{IPF} sup.
 Maša cook.PRES.3.SG soup.ACC
 ‘Masha is cooking soup.’
 b. *Maša navarit^{PF} sup.
 Maša na.cook.PRES.3.SG soup.ACC
- (7) a. *Maša varit^{IPF} supa.
 Maša cook.PRES.3.SG soup.GEN
 b. Maša navarit^{PF} supa.
 Maša na.cook.PRES.3.SG soup.GEN
 ‘Masha will cook a lot of soup.’

Interestingly, in the case of the pair *varit*^{IPF} ‘to cook/be cooking’ and *navarit*^{PF} ‘to cook a lot of’, a measure phrase can be used as a direct object with both verbs, as illustrated by (8).

- (8) a. Maša varit^{IPF} 5 litrov supa každyj den’.
 Maša cook.PRES.3.SG 5 litre.PL.GEN soup.GEN every day
 ‘Masha cooks five litres of soup every day.’
 b. Maša navarit^{PF} 5 litrov supa.
 Maša na.cook.PRES.3.SG 5 litre.PL.GEN soup.GEN
 ‘Masha will cook five litres of soup.’

This suffices to show that prefixes that are considered to be superlexical can change the argument structure of the verb, thereby not only limiting the existing options for the derivational base verb, but also adding new ones.

Now we consider the other direction: if the attachment of a superlexical prefix can lead to changes in the argument structure of the derivational base verb, we can try to reformulate the property. An alternative formulation would be to postulate that if a lexical prefix is attached to a verb, argument structures of the source and the derived verb will be distinct. This, however, does not work either. As an example, consider the pair of verbs *delat*’*sdelat*’ ‘to do’. Both verbs are obligatorily transitive. Illustrations of this fact are provided in (9) and (10).

- (9) a. Petja delaet^{IPF} domašnee zadanie.
 Petja do.PRES.3.SG home.SG.ACC assignment.SG.ACC
 ‘Petja is doing his homework.’
 b. *Petja delaet^{IPF}.
 Petja do.PRES.3.SG

3 Lexical and superlexical prefixes?

- (10) a. Petja sdelat^{PF} domašnee zadanie.
Petja s.do.PRES.3.SG home.SG.ACC assignment.SG.ACC
'Petja will do his homework.'
b. *Petja sdelat^{PF}.
Petja s.do.PRES.3.SG

As one may object that the prefix *s-* in *sdelat* 'to do' is what some researchers call an "empty prefix" (a prefix that changes the aspect, but does not lead to a clear change of the lexical meaning, *čistovidovaja pristavka* in the Russian tradition), let me provide another example where the prefix is clearly not an "empty" one, but, according to those who use the lexical/superlexical distinction, a lexical one. Consider the following three verbs: *nesti*^{IPF} 'to carry', *prinesti*^{PF} 'to carry to some destination', and *otnesti*^{PF} 'to carry away from some location'. All three verbs have the same argument structure: they are obligatorily transitive (see examples (11)–(13)).

- (11) a. Petja nesët^{IPF} korobku v podval.
Petja carry.PRES.3.SG box.SG.ACC in cellar.SG.PRP
'Petja is carrying the box to the cellar.'
b. *Petja nesët^{IPF} v podval.
Petja carry.PRES.3.SG in cellar.SG.PRP
- (12) a. Petja prinēsët^{PF} korobku v podval.
Petja pri.carry.PRES.3.SG box.SG.ACC in cellar.SG.PRP
'Petja will carry the box to the cellar.'
b. *Petja prinēsët^{PF} v podval.
Petja pri.carry.PRES.3.SG in cellar.SG.PRP
- (13) a. Petja otnēsët^{PF} korobku v podval.
Petja ot.carry.PRES.3.SG box.SG.ACC in cellar.SG.PRP
'Petja will carry the box to the cellar.'
b. *Petja otnēsët^{PF} v podval.
Petja ot.carry.PRES.3.SG in cellar.SG.PRP

This clearly shows that knowing the lexical or superlexical status of a prefix is not sufficient to predict whether its attachment will change the argument structure of the derivational base verb.

3.6 Position in the stem

The least problematic property of superlexical prefixes is that they always appear to the left of the lexical prefixes if two or more prefixes are stacked. When formulated this way, the property holds. However, a stronger version of this statement is used in the literature, either explicitly (Svenonius 2004b) or implicitly (Tatevosov 2009): because there is only one syntactic position a lexical prefix can appear in, it is assumed that lexical prefixes can only appear directly to the left of the verbal root and cannot be stacked. For example, Svenonius (2004b: 206) writes: “lexical prefixes are unique in each VP, as their structural position is unique – a single V cannot have more than one resultative complement.”

This, however, does not hold. Consider, for example, the verb *razukrasit'* ‘to decorate’ and the verb *razuznat'* ‘to find out’. Each of these verbs contains two prefixes, *raz-* and *u-*, both of which are lexical: if one consults Table 3.1 again, neither of the prefixes is classified as superlexical in any of the papers discussed. The derivation chains for the verbs are constructed using the criteria formulated in Chapter 2 and provided in (14a) and (14b).

- (14) a. *krasit'*^{IPF} → *ukrasit'*^{PF} → *razukrasit'*^{PF}
 to paint to embellish to decorate
 b. *znat'*^{IPF} → *uznat'*^{PF} → *razuznat'*^{PF}
 to know to learn to find out
 c. **ložit'*^{IPF} → *položit'*^{PF} → *raspoložit'*^{PF}
 to put to put to position

A similar case is presented in (14c) with the difference that in contemporary literary Russian the unprefixated verb **ložit'*^{IPF} does not exist (it exists in the colloquial language and in dialects).

From observing these three examples one may, for the sake of saving the hypothesis of a single position for lexical prefixes, hypothesize that the prefix *raz-/ras-* is a superlexical one. The problem with this hypothesis is that if one believes that the contributions of lexical and superlexical prefixes have particular characteristics, then the semantics of this prefix patterns with the semantics of lexical prefixes: a thorough study was performed by Janda & Nessel (2010), who list eleven subclasses for the meaning that is contributed by the prefix *raz-*, and only one of them (Complex Act Perfective in their terminology) is characteristic of the typical contribution of a superlexical prefix.

3.7 Subclasses of superlexical prefixes

So far we have observed that the binary distinction between lexical and superlexical prefixes is not sufficient to predict the existence and properties of verbs containing certain sets of affixes. As at least some of the problems mentioned above were noticed by the researchers working on Russian prefixation, several refinements of the original distinction have been proposed in the literature. In further developments of Russian prefixation theories we see a shift of focus from the bipartite distinction to the split of the whole class of prefixes into more than two groups: Tatevosov (2007) proposes a three-way classification of verbal prefixes and Tatevosov (2009) splits the class of superlexical prefixes into three subclasses.

3.7.1 Intermediate prefixes

Tatevosov (2007) introduces a class of intermediate prefixes that is supposed to accommodate prefixes which do not fit nicely into either the lexical or the superlexical category. This class comprises the completive prefix *do-* and the repetitive prefix *pere-*. Tatevosov (2007) proposes that these prefixes are structurally higher than lexical prefixes, but lower than superlexical prefixes and the secondary imperfective.

This division is motivated by examples like (15a) and (15b). For the analysis that assumes the two-way classification of prefixes, the verbs (15a) and (15b) have identical internal structure: a superlexical prefix, a lexical prefix, a stem, and the imperfective suffix. Nevertheless, these verbs are assigned different aspects: the verb *nazapisyvat'* 'to write down a lot' is perfective while the verb *perezapisyvat'* 'to be rewriting/to rewrite' is imperfective. For Tatevosov (2007), there is a structural difference between the two verbs, because *pere-* is classified as an intermediate prefix and is positioned between lexical prefixes and the imperfective suffix. As a result, the verb in (15b) is assigned the imperfective aspect. At the same time, *na-* remains a superlexical prefix and thus the verb *nazapisyvat'* 'to write down a lot' is assigned the perfective aspect.

- (15) a. *nazapisyvat'*^{PF}
na.za.write.imp.INF
'to write down a lot'
- b. *perezapisyvat'*^{IPF}
pere.za.write.imp.INF
'to be rewriting/to rewrite'

However, Kagan (2015) shows that the introduction of intermediate prefixes does not solve the problem of predicting the aspect of a given verb on the basis of information about the affixes it is formed with: she provides examples where verbs prefixed with the attenuative prefix *pod-* allow the subsequent formation of the secondary imperfective (Kagan 2015: 35, ex. (16) here)

- (16) a. pod-taj-a-t' - pod-taj-iva-t'
 pod.melt.INF - pod.melt.imp.INF
 melt slightly^{PF} - melt slightly^{IPF}
- b. pod-u-st-a-t' - pod-u-sta-va-t'
 pod.get.tired.INF - pod.get.tired.imp.INF
 get tired slightly^{PF} - get tired slightly^{IPF}
- c. pod-za-rabot-a-t' - pod-za-rabat-yva-t'
 pod.earn.INF - pod.earn.imp.INF
 earn some money^{PF} - earn some money^{IPF}

Kagan (2015) marks imperfective forms in (16b) and (16c) with ?? and * respectively, as out of context these forms sound weird to a native Russian speaker. However, if one needs to express the meaning 'earn a small amount of money from time to time' the best way to do it is to use the verb *podzarabatyvat'*. As soon as it is put in the context, as in (17), this verb starts to sound natural and may be marked with a question, but is definitely not ungrammatical. I hypothesise that the oddness of the secondary imperfective here can be of the same sort as the oddness of multiply prefixed verbs: it is almost impossible to process such verbs without a context and thus they are perceived as unnatural when given in isolation, but become fine in an appropriate setting.

- (17) Delaete xorošie fotosnimki? U vas est' vozmožnost'
 make good photos near you have possibility
 podzarabatyvat' na ètom!
 pod.za.earn.imp.INF on this
 'Do you take good photos? You have the chance to earn some money from it!' <http://smolgorforum.ru/index.php?/forum/65-foto-i-video/>, accessed on 24.08.2021

This suffices to show that the classification provided by Tatevosov (2007) does not allow one to reliably predict the aspect of the complex verb, despite the fact that this task can be viewed as the driving force of the proposed approach.

3.7.2 A three-way distinction

A more elaborate classification is proposed in Tatevosov 2009, which is mainly dedicated to the problem of prefix stacking. However, in order to account for the relevant stacking constraints, the proposal amounts to a list of postulations about the position of prefixes in the syntactic tree. Tatevosov (2009) abandons the previous tripartite distinction among all the prefixes, proposed in Tatevosov (2007), and instead argues for a classical bipartite division into lexical and superlexical prefixes, enriching it with a three-way classification of the superlexical prefixes in order to account for the relevant facts: left periphery prefixes, selectionally limited prefixes, and positionally limited prefixes.

The group of left periphery prefixes comprises only one prefix: distributive *po-* (as in *pobrosat* ‘to throw all of’). It occupies the left periphery of the verbal structure.

Selectionally limited prefixes can be added only to a formally imperfective verb. The group includes the delimitative prefix *po-* (*posidet* ‘to sit for some time’), the cumulative prefix *na-* (*navarit* ‘to cook a considerable amount of something’), the distributive prefix *pere-* (*perelovit* ‘X’ ‘to catch all of X’), and the inchoative prefix *za-* (*zabegat* ‘to start running around’).

The last group of positionally limited prefixes contains the completive prefix *do-* (*dodelat* ‘to finish doing’), the repetitive prefix *pere-* (*perepisat* ‘to rewrite’), and the attenuative prefix *pod-* (*podustat* ‘to become a little bit tired’). These prefixes, according to Tatevosov (2009), can be added only before³ the secondary imperfective suffix *-yva-/-iva-* and end up in the same structural position as intermediate prefixes in Tatevosov (2007), the group being extended by one prefix.

The net advantage of Tatevosov (2009) over Tatevosov (2007) seems to be that only the former can correctly predict the existence of the derived verbs in (16) and motivate the difference between (18a) and (18b). The drawback caused by the need to structurally distinguish cases like (18a) and (18b) is the stipulation that distributive prefix *po-* forms a singleton group. On Tatevosov’s (2009) account, distributive *po-* must be situated on the left periphery of the verb, thus there can be no derivation for (18b).

- (18) a. *ponazapisyvat*
po.na.za.write.imp.INF
‘to write down all of X one after another’

³The attachment of one affix *before* the other is understood in terms of the derivation chain: the first affix is attached at the earlier step of the derivation. This amounts to a lower attachment site in terms of the tree structure.

- b. *napozapisyvat'
na.po.za.write.imp.INF

In general, the theory proposed by Tatevosov (2009) seems to account nicely for many cases of multiple prefixation of Russian verbs. Let us for the moment set aside the problem of biaspectual verbs described in Section 2.1 as well as the problem of a singleton group, mentioned above, and concentrate on one of the central predictions of the theory: selectionally limited prefixes can be attached only to formally imperfective verbs.

It turns out that it is possible to find examples where prefixes that are supposed to belong to the selectionally-limited group are attached to formally perfective verbs, which contradicts the proposed theory of prefixation. We will look in turn at the prefixes *po-* (delimitative), *pere-* (distributive), and *na-* (cumulative).

3.7.2.1 Delimitative *po-*

First let us consider examples where the delimitative prefix *po-* can indeed only be added to an imperfective verb. In case of an aspectual pair where both verbs are unprefixated (as, for example, *rešit*^{'PF}/*rešat*^{'IPF} 'to solve') the prefix *po-* can only be combined with the imperfective member of the pair (in this case *rešat*^{'IPF} 'to solve/be solving'), as illustrated by example (19a) (example (62b) in Tatevosov 2009: 121). If the paired verbs both contain a prefix, as *zapisat*^{'PF}/*zapisyvat*^{'IPF} 'to write down/record', the delimitative prefix *po-* is normally attached to the imperfective verb (in this case *zapisyvat*^{'IPF} 'to write down/be writing down'), as illustrated by example (19b) (example (63b) in Tatevosov 2009: 121).

- (19) a. Posidim, *porešim (OKporešaem^{PF})
po.sit.PRES.1.PL, *po.solve.PRES.1.PL (OKpo.solve.imp.PRES.1.PL)
voprosy, s pacanami poznamišsja, čtoby
question.PL.ACC, with boy.PL.INST po.meet.PRES.1.PL.refl, that
dorogu slučajno ne perebegat'.
road.SG.ACC by chance not pere.run.INF
'We will sit a bit, solve some issues, you will get to know the boys so
that you won't accidentally cross their way.'
Gennadij Praškevič, Aleksandr Bogdan, *Čelovek "Č"*
(62b) in Tatevosov (2009)
- b. Poètomu zapustil programmu,
because of it za.let.PST.SG.M program.SG.ACC,
zapisyvajuščuju dejstvija na èkrane,
za.write.PART.ACT.PRES.SG.F.ACC action.PL.ACC on screen.SG.PREP,

3 Lexical and superlexical prefixes?

otkryl PSP, i nemnogo #po-zapisal
 open.PST.SG.M PSP, and a bit #po.write.PST.SG.M
 (^{OK}po-zapisyval^{PF}), što i kak.
 (^{OK}po.write.impPST.SG.M), what and how

‘For this reason I ran the program that records the actions on the screen and recorded for some time, what was happening and how.’
 =(63b) in Tatevosov (2009), nova-forum.com

Now let me provide some examples where the delimitative prefix *po-* is attached to a formally perfective verb. In the first example, (20), we are dealing with a selectionally limited prefix *po-* that is attached to the perfective verb *priotkryt*^{PF} ‘to open slightly’. The derivational base verb already contains the attenuative prefix *pri-*, so the delimitative prefix *po-* plays a role of an intensifier of the low degree property.

- (20) A na ešelone on nemnožko čut’ popriotkryl
 But at flight level he a little bit slightly po.pri.open.PST.SG.M
 okoško.
 window.SG.ACC
 ‘And at flight level he opened the window just a little bit.’
<http://www.rsdn.ru/forum/life/4244369.1>, accessed on 24.08.2021

Example (20) contains a verb that is the result of attaching the delimitative prefix *po-* to the perfective verb *priotkryt*^{PF} ‘to open slightly’. We can try to attach the same prefix to the paired imperfective verb *priotkryvat*^{IPF} ‘to open/be opening slightly’. It turns out that the verb that contains all the morphemes of the verb *priotkryvat*^{IPF} ‘to open/be opening slightly’ plus the prefix *po-* is the verb *popriotkryvat*^{IPF} ‘to slightly open some of X’. This verb cannot be substituted for the verb *popriotkryt*^{PF} ‘to open slightly’ in (20) without changing the meaning of the sentence: (21) means that every time the described person flies on the plane, he opens the window. Moreover, the verb *popriotkryvat*^{IPF} ‘to slightly open some of X’ is imperfective, unlike the verb *pozapisyvat*^{IPF} ‘to record for a while’ in example (19b).

- (21) A na ešelone on nemnožko čut’ popriotkryval^{IPF}
 but at flight level he a little bit slightly po.pri.open.imp.PST.SG.M
 okoško.
 window.SG.ACC
 ‘And at flight level he used to open the window just a little bit.’

Another example is provided in (22). Again, the delimitative prefix *po-* seems to be redundant as it contributes the delimitative semantics that is already present in the semantic representation of the derivational base (just because this is the condition under which it can be attached).

- (22) Za sorok let despotizma mozgi popodsoxli.
 after forty year.PL.GEN despotism brain.NOM po.pod.dry.PST.PL
 ‘During forty years of despotism his brain kind of dried up a bit.’
<http://otvet.mail.ru/question/65535779>, accessed on 24.08.2021

Like example (20), in example (22) it is impossible to substitute the verb *popodsoxli*^{PF} ‘dried a bit’ with the verb *popodsyxali*^{PF} ‘all of them dried a bit’ which is derived with an additional step of imperfectivisation in between the two prefixations. The modified sentence in (23) can only be interpreted as the ‘brain drying’ within a group of people, not only with one person.

- (23) Za sorok let despotizma mozgi popodsyxali.
 after forty year.PL.GEN despotism brain.NOM po.pod.dry.imp.PST.PL
 ‘During forty years of despotism their brains kind of dried up.’

The conclusion that can be drawn from the examples above is that although in general the delimitative prefix *po-* attaches to imperfective verbs, there are some exceptions to this rule. It also turns out that when we encounter an example of a perfective verb prefixed with the delimitative *po-*, it is not possible to substitute this verb with the result of the prefixation with *po-* of the paired imperfective verb without a change in the semantics of the sentence. This means that in cases like (20) and (22) the perfective verb prefixed with *po-* cannot be regarded as a “variant” of the verb that obeys the selectional restriction.

3.7.2.2 Distributive *pere-*

Another prefix that is categorised as selectionally limited by Tatevosov (2009) is the distributive prefix *pere-*. It turns out that there are examples where this prefix is attached to a formally perfective verb, although on the intuitive level the attachment of a distributive *pere-* to a perfective verb seems to be more an exception than a rule. Consider the verb *prosil*^{IPF} ‘to ask’. It can be prefixed with a lexical prefix *o-*. The result of this prefixation is a perfective verb *oprostil*^{PF} ‘to interview’. This verb can be prefixed with the prefix *pere-*, producing the verb *pereoprostil*^{PF} as the output of the prefixation. The question now is, which meaning does *pere-* have in this verb? According to Tatevosov (2009), it could be only iterative *pere-*. This meaning is indeed attested, as illustrated by the example in (24), where *pereoprostil* means ‘interviewed again’.

3 Lexical and superlexical prefixes?

- (24) Sledovateli Genprokuratury zanovo pereoprosili
 investigator.PL.NOM General.Prosecution.GEN anew pere.o.ask.PST.PL
 učitelej i odnoklassnikov Jakova.
 teacher.PL.ACC and classmate.PL.ACC JAKOV.GEN
 ‘Investigators from the General Prosecution interviewed the teachers and
 the classmates of Jakov again.’ https://www.topnews.ru/media_id_5978.html,
 accessed on 24.08.2021

However, the distributive meaning of *pere-* is also available: sentence (25) is true if the speaker posted on each forum and asked every mechanic only once.

- (25) Perepostil na vse alfaforumy, pereoprosil vse
 pere.post.PST.SG.M on all alfa.forums, pere.ask.PST.SG.M all.ACC
 znakomyx avtoslesarej.
 known mechanic.PL.GEN
 ‘I posted it on all the major forums and asked all mechanics I know.’ <https://fiat-club.org.ua/forum/viewtopic.php?t=27668>,
 accessed on 24.08.2021

Let us now consider the case of attaching the prefix *pere-* to an imperfective verb. The verb *oprosit*^{PF} ‘to interview’ can be imperfectivised, providing a paired verb *oprašivat*^{IPF} ‘to interview/be interviewing’. If this verb is prefixed with *pere-*, the result of the prefixation is the verb *pereoprašivat*^{PF} ‘to interview all of’. An example of the usage of this verb, found on the internet, is provided in (26). Like in (25), it is clear from the context that each of the scientists was asked separately and only once. Normally in a similar context one would use the verb *peresprašivat*^{PF} ‘to ask all of’, as *sprašivat*^{PF} ‘to ask’ refers to an individual question and the prefix *pere-* then provides iteration over the referents. On the other hand, the verb *oprašivat*^{PF} ‘to interview’ already encodes iteration of the questions, so after the attachment of the distributive *pere-* the resulting verb denotes an event that contains a double iteration: every respondent is asked every question. In case of (26), the speaker (or his hero in the computer game the forum is about) asked any other characters of the “scientist” type all the possible questions (limited by the game design).

- (26) Pereoprašival vse učenyx, nikto ne
 pere.o.ask.imp.PST.SG.M all.ACC scientist.PL.GEN, nobody not
 daët kvest na oazis...
 give.PRES.3.SG quest on oasis.SG.ACC
 ‘I’ve talked (asked all the questions) to all the scientists, none of them gave
 me the oasis quest.’ <https://antistarforce.com/forum/69-3832-26>,
 accessed on 24.08.2021

3.7.2.3 Cumulative *na-*

An interesting discussion can be found in Tatevosov (2013a). It concerns the possibility of attaching the cumulative prefix *na-* to a perfective verb. Citing Zaliznjak (2003), Tatevosov (2013a) concludes that there is a closed list of verbs consisting of a perfective stem prefixed with the cumulative *na-* that are accepted by all Russian native speakers. Tatevosov (2013a) mentions, for instance, the verbs *nakupit*^{PF} ‘to buy a lot of something’ and *napustit*^{PF} ‘to fill something with a lot of something’.

Tatevosov also writes, however, about another, much larger group of verbs that are formed according to this pattern. This group, according to him, includes such verbs as *napridumat*^{PF} ‘to come up with a lot of something’, *narasskazat*^{PF} ‘to tell a lot of something’, and *nasočinit*^{PF} ‘to write/compose a lot of something’. Consider example (27), taken from the internet. Here we see two verbs formed by prefixation of a perfective verb with the cumulative prefix *na-*: *naotkryt* ‘to open a lot of X’ and *nazapostit* ‘to write and publish a lot of posts.’

- (27) I naotkryl i nazapostil mnogo tem.
 and na.open.PST.SG.M and na.write.PST.SG.M many topics
 ‘And started a lot of posts and wrote about a lot of topics.’ <http://forum.hayastan.com/lofiversion/index.php/t5328-100.html>, last accessed in 2016

Tatevosov (2013a) claims that there is quite a large group of people who speak a dialect of Russian where the cumulative prefix *na-* lacks any syntactic restrictions and can be freely attached to perfective verbs. Two problems arise with this claim.

First, the distinction between the “major”, more restrictive dialect and the dialects that allow freer attachment of the cumulative *na-* seems to be not so clearcut. For example, for me as a native speaker of Russian there is a difference in the acceptability of the two verbs in (27): the verb *naotkryt* ‘to open a lot of X’ seems to be considerably less acceptable than the verb *nazapostit* ‘to post a lot’. This may be due to the fact that the verb *naotkryt* ‘to open a lot of X’ can be replaced by another verb in which the cumulative *na-* is attached to the imperfective stem: *naotkryvat*^{PF} ‘to open a lot of X’ derived from *otkryvat*^{IPF} ‘to open/be opening’. The verb *nazapostit* ‘to post a lot’, however, lacks a similar paired verb: if I try to form a secondary imperfective from the verb *zapostit* ‘to post’, none of the resulting forms sounds acceptable, possibly for phonological reasons: [?]*zapostivat*, [?]*zaposčivat*, [?]*zapoščivat*, [?]*zapošččivat*. Interestingly, all of these forms are attested on the internet, as evidenced by the examples in (28) (with the third variant, *zapoščivat*, being the most frequent).

3 Lexical and superlexical prefixes?

- (28) a. *Ix teksty ja zapostival na naš*
 they.GEN text.PL.ACC I za.post.imp.PST.SG.M on our
fakul'tetskij forum.
 department.SG.ACC.M forum.SG.ACC
 'Their texts I've posted on the forum of our department.'
 hgr.livejournal.com, last accessed in 2016
- b. *Tak ponevole budeš prosit' razrešenija, esli uže*
 so unwillingly will.2.SG ask.INF permission.SG.ACC, if already
raz započival, tak potërli.
 once za.post.imp.PST.SG.M, so po.rub.PST.PL
 'If you already posted something once and it was erased, you in-
 evitably start to ask for permission.' <https://www.forumavia.ru/t/172787/1/>, accessed on 24.08.2021
- c. *Davnen'ko ja ničego ne započival, no dejstvitel'no*
 quite a while I nothing not za.post.imp.PST.SG.M, but really
pisat' ne o čem.
 write.INF not about that.PRP
 'I haven't posted anything for quite a while, but I really have nothing
 to write about.' www.drive2.ru, last accessed in 2016
- d. *Reportaž 1 kanala RF o poxoronax*
 reportage.SG.ACC 1 channel Russian Federation about funeral.PRP
desantnika ja uže započčival.
 paratrooper.SG.GEN I already za.post.imp.PST.SG.M
 'I've already posted the documentary of the first federal channel
 about the funeral of a paratrooper.' waronline.org, last accessed in
 2016

The fact that all the possible variants of forming a secondary imperfective from the verb *zapotit'* 'to post' are attested on the internet indicates that neither of these variants is perfect and acceptable by all speakers.

Now let us explore another problem that arises if we postulate the absence of any restrictions on the attachment of the prefix *na-* for some dialects of Russian, as Tatevosov (2013a) does. The speakers of such a dialect should be able, for example, to derive the verb *naotkryt'*^{PF} 'to open a lot of X' and then imperfectivise it by the attachment of the suffix *-yva-*, deriving an imperfective verb **naotkryvat'*^{IPF} 'to open/be opening a lot of X'. However, the internet data do not supply any single attestation of the imperfective aspect for the verb *naotkryvat'* 'to open a lot of X'. This is unexpected if one assumes the theory proposed in Tatevosov (2013a) without further restrictions.

In sum, three out of four prefixes in the selectionally limited group proposed by Tatevosov (2009) do not strictly obey the selectional restriction.

3.8 Conclusion

In this chapter we have seen that none of the properties of the lexical and superlexical prefixes that are predicted on the basis of their syntactic position is universal. This leads to the conclusion that on the basis of the properties of the prefixes that we know so far it is impossible to postulate a clear-cut distinction between the different groups.

This is not to negate the existence of various types of prefixes associated with particular properties. For instance, some prefixes (in all their usages) always contribute a regular meaning that can be derived compositionally, and the contribution of others to the semantics of the complex verb is obscure. The key point that I would like to emphasise is that there is no natural cut-off between one group of prefixes and the other. It looks much more like a continuous scale on which the prototypical lexical prefixes are at one end, the prototypical superlexical prefixes are at the other end, and most prefixes are somewhere in between.

Such an approach to the classification of prefixes allows to build on the insights about the varying behaviour of distinct types of prefixes and at the same time not to be committed to drawing a line between these types, as this seems to create problems instead of solving them. On the other hand, assuming such a continuum means that it is not possible to assign each prefix a fixed position in the syntactic tree. In what follows I will show that it is possible to account for a range of facts that were shown as problematic in this chapter by replacing some of the syntactic restrictions with semantic restrictions.

4 Semantics of individual prefixes

4.1 Semantic approach to verbal prefixation

The main things that we have discussed so far are an efficient way of collecting and verifying the data and the fact that these data cannot be fully accounted for by means of existing syntactic approaches to Russian prefixation. Let us now explore what has been done in the domain of prefix semantics.

Semantics-oriented studies of Russian prefixes can be divided in three groups: (i) studies following the Russian tradition that investigate nuances of different prefix usages, (ii) studies following the “Western” tradition that aim to find uniform semantics (or one function) for all the prefixes (not only in Russian, but in Slavic languages in general), and (iii) studies that try to bridge the gap between the first two approaches. Let me provide a bit more detail about each of these directions of research.

The main question that is addressed in the Russian tradition is nicely formulated by Bogusławski (1963: 18), who writes that “the problem of defining all the meanings of ‘the same prefixes’ is first of all a practical problem and is of a great importance for the lexicographic studies”. The main purpose of the grammar (Vinogradov et al. 1952; Švedova 1982) and dictionaries (Černyšëv 1950–1965; Evgen’eva 1957–1961), as well as of many other studies of Russian prefixes (Avilova 1964; Golovin 1959; Lopatin 1997; Tixonov 1998, among others) is to examine the data in great detail and provide a full picture of the different usages that a particular prefix may have. As a next step, the type of relation (polysemy of homonymy) between these usages is analysed (Krongauz 1997; Plungyan 2001). This work is necessary, but its focus is on descriptive adequacy and not on finding differences or similarities between different prefixes or explaining why a particular combination of stacked prefixes is available or not.

As for the “Western” approach, the main idea they exploit is that Slavic verbal prefixes are markers of perfective aspect (see, e.g., Binnick 1991; Krifka 1992; Zucchi 1999, among others). Perfective aspect itself then gets analysed in terms of quantisation (first proposed in Krifka 1989; 1992, and later repeated by Piñón 1995), from which it follows that the semantic function of verbal prefixes is to contribute quantisation, defined by Krifka (1989) as shown in Definition 4.

4 Semantics of individual prefixes

Definition 4. *Quantisation* $QUA(P) \leftrightarrow \forall x, y [P(x) \wedge P(y) \rightarrow \neg y < x]$

A predicate P is quantised iff, whenever it applies to x and y, y cannot be a proper part of x.

However, Filip (1992) noticed that matters are more complicated, as there are perfective verbs that fail to be quantised according to the Definition 4. Filip (1992) raised a number of questions in this respect, and proposed that “the semantic property of the Incremental Theme NPs that is determined by aspect should not be characterised in terms of the “cumulative/quantised” distinction, but rather in terms of the ‘bounded/unbounded’ distinction, which characterises aspect” (Filip 1992: 147).

In a next step, Filip (1992) shifted the focus to the contribution of the Slavic linguistic tradition (Wierzbicka 1967; Rassudova 1975; Merrill 1985) and concluded that verbal prefixes must be associated with local quantificational effects¹ (among other meaning components). Filip (1999) later proposes to analyse Slavic verbal prefixes as scalar expressions. This became a departure point for the subsequent analyses (Filip 2000; 2003; 2005; Filip & Rothstein 2005; Kagan 2011; 2012; 2013; 2015). For example, Filip (1999: 183) writes that the prefix *na-* “adds to a verb the meaning of a sufficient or large quantity, or a high degree measured with respect to a certain contextually determined scale and with respect to some standard or subjective expectation value.” Later, Filip (2008) also formulated the general idea that prefixes (at least under certain usages) “contribute to the specification of the ordering criterion on events” and proposed to include them in the class of scale inducing expressions. This idea allowed Kagan (2012, 2015) to further develop the semantic approach to prefixation under which “the major semantic function of a prefix is to impose a certain relation between two degrees on a scale”. Various prefixes then differ with respect to the type of the scale they can apply to and the exact relation between the degrees they establish.

Following Filip (2008), the idea of scalar interpretation of verbal prefixes serves as a bridge between the two traditions: on the one hand, it reveals the common core of the prefixes, and on the other hand, it provides the space for explaining the distinctions between individual prefix usages.

I propose to use a scalar approach to prefix semantics in order to account for another complex issue: prefix combinatorics. Tatevosov (2009) correctly notices that descriptive approaches and structuralist theories of the semantics of Russian prefixes, such as Avilova (1964), Golovin (1959), Lopatin (1997), and Tixonov (1998), did not bring us closer to the understanding of how complex verb formation operates. On this basis, Tatevosov (2009) concluded that a semantic approach

¹A-quantification in terms of Partee et al. 1987; Bach et al. 1995, which is typically expressed at the sentence level or at the level of VP with sentence adverbs, “floated” quantifiers (e.g., *each*), verbal affixes, auxiliaries, and various argument-structure adjusters.

is not helpful for predicting the existence and properties of complex verbs. This conclusion is, however, not a valid one: an inspiring counterexample is the work by Filip (2003), who uses the “one delimitation per event” constraint to motivate the exclusion of some prefix-verb combinations on semantic grounds. This constraint is formulated by Tenny (1994: 79) as “[t]he event described by a verb may only have one measuring-out and be delimited only once”. It is grounded in the independent restrictions that come from the grammar of measurement in natural languages and it operates across both nominal and verbal domains.

Taking this as a point of departure, I propose to analyse certain restrictions on the formation of complex verbs as semantic restrictions. As I have shown in Chapter 2 and Chapter 3, a significant amount of data cannot be treated adequately in the syntactic approaches: biaspectual verbs, stacking of prefixes, formation of secondary imperfective verbs. I propose to look at these processes from a different angle, taking into account the semantics of verbal prefixes. I will show that the scalar semantic approach can be successfully used to motivate stacking of prefixes (as well as the existence of biaspectual verbs and certain restrictions on the formation of secondary imperfective verbs). A formalism that allows us to restrict derivations on the basis of semantic constraints is then required.

The goal of this chapter is to motivate intuitions about the behaviour of individual prefixes and provide informal semantic analyses of the prefixes under discussion in such a way that their combinatorial properties derive naturally from their semantic properties. This discussion provides the basis for the formalisation of prefix semantics that will follow in Chapter 6. The prefixes that we are going to look at are the following: *za-* (inchoative usage), *na-* (accumulative usage), *po-* (delimitative and distributive usages), *pere-* (iterative, distributive, and excessive usages), and *do-* (completive usage). I will occasionally mention some of the extra usages of the discussed prefixes, but analysing them, as well as other prefixes, is beyond the scope of this book.

For each prefix, the structure of the respective subsection is the same, covering three important issues and followed by a summary:

1. semantic contribution;
2. restrictions on the attachment: (in)compatibility of lexical semantics of verbal stems with prefix semantics;
3. subsequent imperfectivisation of a verb with the discussed prefix;
4. summary.

4 Semantics of individual prefixes

Before we proceed, I would like to note that shifting the focus from the syntactic restrictions to the semantic ones in the domain of prefix stacking does not mean that no syntactic theory of verbal structure is needed. There still remain constraints that are better formulated in (morpho-)syntactic terms. An example of such a constraint is the unavailability of multiple imperfective suffixes in Russian.

Another module that is involved in regulating complex verb formation in Russian is pragmatics. I propose some preliminary pragmatic explanations for the non-existence of certain verbs in this chapter and provide some more details in Chapter 5.

As scales are crucial in the analysis of the prefixes, let me provide a brief overview of the concept before discussing the properties of individual prefixes.

4.2 Scales

The original area of application of scales in linguistics is the domain of gradable adjectives. As suggested by Kennedy (1999), gradable adjectives (e.g., *wide*, *tall*, *expensive*) denote properties that for different individuals hold to different degrees. This means that they are analysed as denoting a certain relation between an individual-type and a degree argument. One formalisation of this idea is that an adjective lexicalises a *scale* and maps its argument to a certain degree on that scale (Kennedy 2001; Kennedy & Levin 2002). An alternative formalisation (e.g., Heim 2000) represents such adjectives as taking a degree as an argument and providing as its output the set of the individuals for which the lexicalised property holds up to this degree.

A *scale* is defined as a set of points (degrees, values), totally ordered along some *dimension* (e.g., length, quantity, volume, duration). If the scale has maximal and minimal elements, it is a *totally closed* scale (often called just *closed* scale). If the scale has neither a maximal nor a minimal element, it is a *totally open* (or just *open*) scale. Scales that have a minimal and lack the maximal element are *lower closed* and scales that lack the minimal and have the maximal element are *upper closed*. These properties play an important role in accounting for the adjectival semantics (see, e.g., Kennedy & McNally 2005; Rotstein & Winter 2004; Kagan & Alexeyenko 2010).

Other central notions in this domain are that of *comparison class* and *standard of comparison*. The relevant comparison class (see, e.g. Klein 1980; Kennedy & McNally 2005; Kennedy 2007) is constituted of objects similar to the individual argument in the relevant respects. The comparison class then provides the standard of comparison and the sentence like (1) is interpreted as asserting that the

price of the house is higher than the standard price of a house from the comparison class (houses with similar parameters in the same area).

(1) This house is expensive.

Comparative adjectives, such as in (2), differ in that they overtly specify the comparison class and, thus, the standard of comparison.

(2) This house is more expensive than the one we saw yesterday.

Differential degrees (Kennedy 2001, also called difference values in Kennedy & Levin 2002) and the operation of degree addition (Kennedy & Levin 2002) allow to represent the semantics of such sentences as (3) by explicitly stating how the relevant degrees of the individuals are related.

(3) This house is five thousand dollars more expensive than the one we saw yesterday.

The scalar approach to the semantics of event predicates has proven to have a considerable explanatory power and has been advocated in numerous works on event semantics (see, e.g., Ramchand 1997; Hay et al. 1999; Kennedy & Levin 2002; Caudal & Nicolas 2005; Filip & Rothstein 2005; Kearns 2007; Kennedy & Levin 2008; Filip 2008; Piñón 2008; Rappaport Hovav 2008, 2011; McNally 2011). Let me provide a very brief overview of the works that adopt a scalar approach in order to account for the aspectual properties of event predicates (for a more detailed observation and extra references see Arsenijević et al. 2013).

The first class of verbs that has been explored from the scalar semantics perspective is the class of degree achievements, such as *cool*, *grow*, or *widen*. The crucial difference between adjectives and degree achievement verbs is that while the former map individuals to degrees, the latter denote a change in degree: the degree to which the argument possesses the property at the end of the event is higher than at the beginning. Therefore, a temporal argument has to be introduced (Hay et al. 1999; Kennedy & Levin 2002).

In a next step, scalar approaches to degree achievements were integrated with earlier approaches to the aspectual composition. The theory of aspectual composition has been developed based on the observations about the behaviour of *incremental theme* verbs. Such verbs are characterised by referring to eventualities that involve an incremental change that is related to the internal argument (see Garey 1957; Wierzbicka 1967; Verkuyl 1972; Krifka 1989, 1992; Filip 1992, 1999). An example of a verb of an incremental creation is provided in (4). An important

4 Semantics of individual prefixes

observation is that when the incremental theme has some specified quantity, the predicate is telic; when there is no such specification, the predicate is atelic.

- (4) a. Lee wrote a poem in/??for an hour. telic
b. Lee wrote poetry for/??in an hour. atelic
= ex. (4.1) in Kennedy 2012: 103

Later, Filip (2005) has shown that the basic meaning of an incremental theme verb in English does not introduce a scale. This approach has been adopted by Rappaport Hovav (2008), Levin & Rappaport Hovav (2010), Kennedy (2012), and Bochnak (2013) who concluded that measure of change functions must be associated with the incremental theme arguments. These arguments then supply some value that is used to select an appropriate portion of the scale that has to be covered in course of the event.

Now let us describe additional kinds of scale types that will be relevant for the following discussion. First of all, I want to distinguish two types of situations involving a change along a scale: for the first type, the absolute value on the scale matters, and for the second type, the absolute values are not important and we are only interested in the difference between the values at the beginning and at the end of the event. For example, if John heated the water up to 40 degrees Celsius, it is the absolute value that matters, and if John gained 2 kilos it is the difference that is relevant. We will say that the first event proceeds along the *temperature* scale (I will call the class of such scales *proper scales*) and the linguistic context supplies the *maximum value* on that scale. In the second case, we will say that the event proceeds along the *measure of change scale* for *weight* and the direct object provides the *measure of change value*.

I adopt the notion of the *measure of change scale* from Kennedy & Levin (2008) and Kennedy (2012). The measure of change scale for *weight* is of course related to the proper *weight* scale, whereby the zero point (which is also the minimum point in this case) on the measure of change scale corresponds to the value on the *weight* scale at the beginning of the event. The point that is related to the end of the event may be not straightforwardly related to the measure of change: in the basic case, it can be represented as a sum of the value on the scale at the beginning of the event and the measure of change. If John gained 2 kilos and his weight before this event was 70 kg, his weight at after the event of gaining weight is 72 kg. This leads to the idea of keeping only the proper scale in the semantic representation and express changes in terms of the difference between the absolute values, as it is done by Kennedy (2001) and Kennedy & Levin (2002) by means of differential degrees and degree addition. However, there are cases where the connection is not so straightforward.

To illustrate the last point, let us consider a lexicalised example of measure of change/proper scale opposition: the duration/time pair. Duration can be seen as, but it is not reducible to, a difference between two time points. For example, the event denoted by (5) can consist of ten weekly one-hour classes. In this case the duration is the sum of the (approximate) durations of individual events, but not the difference between the time the first class started and the last class ended.

- (5) John took ten hours of dance classes.
 (6) Mary did two hours of biking on Sunday.

One can argue that such a case is special as multiple subevents are involved. Indeed, in the case of ten hours of dance classes we can represent the whole event as a series of events. This solution is not so obvious in case subevents that do not naturally form a series: if (6) is true, it could have been that Mary did two hours of continuous biking, or that she did one hour in the morning and one hour in the evening, or her whole day was full of small trips that resulted in a cumulative biking time of 2 hours (probably calculated by a fitness-tracker that also counted very short trips). I think that the semantic representation of the sentence should be neutral with respect to these scenarios, so I propose to keep distinct representations of time and duration as well as other proper and measure of change related attributes. This allows us to leave the relation between the proper scale and the measure of change scale underspecified.

In case it seems that the discussion above is only relevant to the duration/time pair and not to the other types of scales, let me provide one more example. A hiking guidebook usually provides information about the elevation gain on the route. If one looks at the description of the circular route, the elevation gain will be positive (theoretically it can be also 0, but it is very improbable). At the same time, the difference between the elevation level at the start and at the end of the event is 0. In such situations, we are dealing with three different scales: a proper elevation scale that has heights as its points, the elevation measure of change scale, that represents the difference between the elevations of the start and the end points of the path, and the elevation gain scale that represents cumulative elevation gain on the route. From the example (7) we can conclude that English does not distinguish between the last two situations, as (7) can be interpreted as either the net elevation gain or the cumulative elevation gain of 1000 metres took place.

- (7) The group of tourists went up a thousand metres up today.

4 Semantics of individual prefixes

- (8) 20 aprilja my podnjalis' na tysjaču pjat'sot metrov.
20 april we ascend.PST.PL.REFL on thousand five.hundred metres
'On April 20 we made a 1500 metres ascent/reached the 1500 metres elevation.'
(translation without context)
'By April 20 we had risen to an average level of 1,500 metres.'
(English original) *Twenty thousand leagues under the sea*, Jules Verne, 1870

As for Russian, some expressions can be interpreted using all the three scales: sentence (8) is most naturally interpreted with respect to one of the measure of change scales, although it is a translation of the English sentence that refers to reaching a depth of 1500 metres (by ascending). On the basis of such observations, I would like to have the means for both the underspecification of the scale and the co-existence of various types of scales without hard connections between their points. For example, the semantic representation of (8) should only contain the information that the maximum point of the scale of the type *elevation* is equal to 1500 metres without specifying whether this is a proper or a measure of change scale. If more information is available, as in (9), both the measure of change (400 metres) and the elevation scale (with a marked point on 1917 m) should be visible in the semantic representation.

- (9) We gained another 400 metres and reached the top of Mount Washington.

In sum, the crucial difference between the measure of change and the proper scale types is that only the latter type is directly bound to some parameters of the world, whereas for each measure of change scale there exist multiple proper scales it can correspond to. I claim that some of Russian prefixes are sensitive to this property, so in my analysis I will distinguish not only between open/closed/upper-closed and various dimensions of the scale, but also between proper scales (my term) and measure of change scales (term borrowed from Kennedy & Levin 2008). It is also possible to relocate this property from the scale level to the level of the event: in this case a *proper scale* event would be an event for which each degree on the scale is mapped to a unique time point, and a *measure of change* event would only require the extreme points to be mapped to different time points. In the proposal presented here I leave the proper/measure of change feature on the level of scale properties, although the event level could be conceptually more appropriate. This issue should be addressed in further research.

4.3 *za-*

4.3.1 Semantic contribution

There are three main uses of the prefix *za-* as described in the dissertation by Braginsky (2008): spatial, resultative and inchoative. The resultative meaning is further subdivided into four categories that Braginsky calls *accumulative*, *cover*, *damage* and *get*. He shows that different usages of *za-* can and should be analysed in a unified way. Braginsky argues convincingly that it is not the case that these meanings apply to all verbs indiscriminately, nor is it the case that they are distributed across specific verbs. So a particular verb does not have to be compatible with any meaning of *za-* nor does it have to have at most one interpretation when prefixed with *za-*.

I will, however, limit my remarks to the inchoative² use of *za-*, that is considered superlexical. The analysis provided here is extendable to other uses of *za-*. For example, Zinova & Osswald (2016) cover the case of the spatial interpretation of the prefix *za-*. The extension to the resultative uses is also possible, but requires some more work in order to define the procedure of selecting a scale along which the event is measured. Some of the resultative usage cases are covered in Zinova (2014), a paper which deals with the locative alternation in Russian and English. The approach presented there is concerned with the ‘accumulative’ and ‘cover’ subclasses of the resultative meaning of *za-*, but does not include the ‘damage’ type of meaning (see Braginsky 2008 for more details about the classification of the resultative sub-meanings).

As for the description of the semantics of the inchoative *za-*, Braginsky (2008) writes (following Šeljakin 1969) that “the function of the inchoative ZA- is to ensure that a given process/state, denoted by an input verb, has passed from the state of non-existence into existence.” Importantly, there are no restrictions imposed by *za-* on the duration of the process or the state that is initiated.

4.3.2 Restrictions on the attachment

There has been a good deal of discussion about the types of verbs that serve as input for prefixation with the inchoative *za-* (Isačenko 1960; Zemskaja 1955; Šeljakin 1969; Zaliznjak 1995; Braginsky 2008). Most of the work focuses on listing different types of possible derivational bases, but as this list turns out to be

²I follow Braginsky (2008) and adopt the term *inchoative*, that he takes from Zemskaja (1955) and Zaliznjak (1995). There are alternative terms in the literature, referring to the same usage of *za-*, such as *inceptive* or *ingressive*, see also the relevant discussion in Maslov 1965.

4 Semantics of individual prefixes

rather long and is still unlikely to be complete, I will try to approach the problem from the other side and concentrate on listing the restrictions on the derivational bases.

When one thinks about the inchoative semantics of the prefix *za-*, the obvious restriction on the derivational base that will be prefixed with it is the presence of a time scale in the verbal semantic structure. On one hand, it seems that all verbs are connected to a time scale. On the other hand, there are indeed verbs that cannot be combined with the inchoative *za-* and such verbs seem to be not non-eventive predicates. Let us first explore the literature on this point.

Braginsky (2008: 275), based on proposals by Šeljakin (1969) and Padučeva (1996), formulates the following conditions that have to hold in order for the verb to be incompatible with any of the core meanings of *za-*:

1. the verb is not compatible with expressing motion into some location;
2. the verb does not have theme arguments;
3. the verb is not localised in time or the event denoted by the verb holds for extra-long intervals.

The first condition captures verbs that are combined with *za-* in its spatial meaning and the second condition plays a role if one wants to attach the resultative *za-* to the derivational base. What is interesting for us here is the third condition, as it refers to the inchoative usage of the prefix *za-*. According to Padučeva (1996), three classes of verbs are not compatible with the meaning of initiation:

1. State verbs that denote atemporal properties/relations, i.e., cannot be localised at specific time moment or interval: *stoit*^{'IPF} 'to cost', *vesit*^{'IPF} 'to weigh', *značit*^{'IPF} 'to mean', *imet*^{'IPF} 'to have'.
2. State verbs denoting steady situations, i.e., hold for extra long temporal intervals: *golodat*^{'IPF} 'to hunger', *ljubit*^{'IPF} 'to love', *gorditsja*^{'IPF} 'to feel proud', *znat*^{'IPF} 'to know'.
3. Activity verbs denoting occupation and behaviour: *žit*^{'IPF} 'to live', *pravit*^{'IPF} 'to rule', *učitel'stvovat*^{'IPF} 'to work as a teacher', *filosovstvovat*^{'IPF} 'to philosophise'.

Padučeva (1996) also writes that verbs denoting atemporal properties do not occur with punctual time or duration modifiers (e.g., *sejčas* 'now', *vsegda* 'always', *X dnej* 'for X days'). This seems reasonable if there is no time scale made available for these verbs, but it turns out to be an invalid observation: examples in (10) illustrate successful combinations of verbs listed above with such modifiers.

- (10) a. Moloko sejčas stoit 60 rublej za litr.
milk now cost.PRES.SG.3 60 rubles for litre
'Milk costs 60 rubles per litre now.'
- b. Takaja formulirovka vseгда značit otkaz.
such formulation always mean.PRES.SG.3 rejection
'Such a formulation always means a rejection.'
- c. On vesil 100 kilogramm 5 let.
he weigh.PST.SG.M 100 kilos 5 years
'He weighed 100 kilos for 5 years.'

A similar problem occurs with the observations made by Padučeva (1996) about the verbs denoting steady states. Padučeva (1996) writes that they are incompatible with punctual (as *v X časov* 'at X hours'), frequency (as *dvaždy* 'twice', *inogda* 'sometimes') and intensive duration (as *ves' den'* 'all day long') modifiers. The examples in (11) illustrate that at least some of the verbs belonging to that class are compatible with some of these modifiers.

- (11) a. On ljubil dvaždy: v 18 i v 35.
he love.PST.SG.M twice: in 18 and in 35
'He loved twice: when he was 18 and when he was 35.'
- b. On gordilsja synom ves' den', poka večerom oni
he feel.proud.PST.SG.M son.INSTR whole day, until evening they
ne porugalis'.
not argued
'He felt proud of his son for the whole day, until they had an argument in the evening.'

Another observation is that if verbs like *stoit*^{1PF} 'to cost' or *značit*^{1PF} 'to mean' were atemporal and verbs like *ljubit*^{1PF} 'to love' were not semantically compatible with time descriptions, then the sentences in (12) would not be acceptable.

- (12) a. No vposledstvii my uvidim, kak i pod kakimi vlijanijami
but later we will.see, how and under which influence
ëtot obraz u nego razvilsja i čto
this image of he.GEN develop.PST.SG.M.refl and what
stal značit'.
become.PST.SG.M mean.INF
'But we will later see how, and under what influences, this image developed in him, and what meaning it began to acquire.'
- V. F. Xodasevič. *Esenin* (1926)

4 Semantics of individual prefixes

- b. Cement-to voobšče bešenye den'gi stal
 cement-somehow at all mad money become.PST.SG.M
 stoit'
 cost.INF
 'Moreover, cement somehow started to cost a crazy amount of
 money!' Roman Senčin. *Eltyševy* (2008)
- c. Lida zdravo ob'jasnjala, čto tak ne byvaet, čto by
 Lida soundly explained, that so not be.imp.PRES.SG.3, that
 včera ljubil, a segodnja zabył.
 yesterday loved, but today forget.PST.SG.M
 'Lida sensibly explained that it cannot be that today he forgot the
 person he loved yesterday.'
 Nina Gorlanova. *Filologičeskij amur* (1980)

In sum, verbs of these three classes are special in the sense of the relation to the time scale, but not "atemporal": they are compatible with time specifications. Padučeva (1996: 132) herself notes that "[m]nogie glagoly javljajutsja ili ne javljajutsja atemporal'nymi v zavisimosti ot tipa subjekta" (many verbs are or are not atemporal depending on the type of the subject). As an example she points to the verb *stojat* 'to stand' that is, according to her, atemporal³ only when used with non-animate subjects, as in (13) and not with animate subjects, as in (14).

- (13) a. Xram stoit na xolme.
 church stand.PRES.SG.3 on hill
 'The church stands on the hill.'
- b. ?Xram sejčas stoit na xolme.
 church now stand.PRES.SG.3 on hill
 'The church now stands on the hill.'
- (14) a. Vasja stoit na xolme.
 Vasja stand.PRES.SG.3 on hill
 'Vasja stands on the hill.'
- b. Vasja sejčas stoit na xolme.
 Vasja now stand.PRES.SG.3 on hill
 'At the moment, Vasja stands on the hill.'

In fact, the verb *stojat* 'to stand' exhibits some atemporality (or, better, it is not compatible with the adverbial *sejčas* 'now') only when it is combined with certain

³According to Padučeva (1996) incompatibility with the adverbial *sejčas* 'now' is diagnostic of atemporality.

types of subject. Consider the noun *kniga* ‘book’. Example (15) illustrates that the combination of the verb *stojat* ‘to stand’ with the non-animate subject *kniga* ‘book’ and an adverbial *sejčas* ‘now’ is possible. In my view, this is clear evidence that “atemporality” is not a property of a verb, but part of world knowledge: it is hard to imagine the church moving around in the normal world, so it does not make sense to utter (13b). The sentence becomes fine if uttered in a world where buildings can disappear and reappear at a nearby location. There are also cases when similar sentences can be uttered to describe a situation in our world: for example, there are some famous houses in Moscow that were moved to allow to widen the road. Another possibility is a change in the landscape: a small island may turn out to be a hill if the water level drops.

Note that if the word order (and, thus, the information structure) is changed in such a way that the hill becomes the focus of the sentence, as in (16), the initial sentence (13b) becomes unmarked also if uttered in the real world in non-exceptional situations. This favours the hypothesis that the problem with sentence (13b), noticed by Padučeva (1996), is not due to the semantic properties of the verb *stojat* ‘to stand’. It also seems reasonable to suggest that the same applies to similar verbs in other languages.

- (15) a. *Kniga stoit na polke.*
 book stand.PRES.SG.3 on shelf
 ‘The book is on the shelf.’
- b. *Kniga sejčas stoit na polke.*
 book now stand.PRES.SG.3 on shelf
 ‘The book is on the shelf.’
- (16) *Na xolme sejčas stoit xram.*
 on hill now stand.PRES.SG.3 church
 ‘On the hill there is now a church.’

Let us now examine the incompatibility of the inchoative prefix *za-* with verbs denoting atemporal/steady situations or occupations. At the first glance, verbs like **zastoit* (*za+stoit* ‘za + to cost’), **zavesit* (*za+vesit* ‘za + to weigh’), **zaznačit* (*za+značit* ‘za + to mean’), **zagordit’sja* (*za+gordit’sja* ‘za + to feel proud’), *zaučitel’stvovat* (*za+učitel’stvovat* ‘za + to work as a teacher’) seem to be non-existent. However, after a careful consideration it becomes clear that there is no semantic reason why the core meaning of such verbs cannot be combined with that of the inchoative *za-*. It turns out that these (and similar) verbs can be divided in the following three categories:

4 Semantics of individual prefixes

1. Verbs that can be prefixed with the inchoative *za-*, as *učitel'stvovat'* 'to work as a teacher'. The derived inchoative verbs are not frequent and thus seem odd out of the context, but native speakers do occasionally use them, as illustrated by (17).
2. Verbs that can be combined with the resultative *za-*, as *zagordit'sja* 'to become stuck-up', *zavesit'* 'to weigh something' (colloquial).
3. Verbs that do not exist in combination with the prefix *za-*, as **zastoit'*, **za-značit'*.

- (17) Malen'kij Ilja èto soobražal, a bolšoj vyros –
 little Ilja this understand.PST.SG.M, but big grow.PST.SG.M –
 zavažničal, zaučitel'stvoval, nu i polučil spolna,
 za.showboat.PST.SG.M, za.teach.PST.SG.M, and receive.PST.SG.M full,
 čto zarabotal!
 that earn.PST.SG.M
 'When he was little, Ilja understood this, but when he grew up, he started
 to showboat, to teach others, and got everything he deserved.'
 positive-lit.ru/novels/gde-konchajutsa-relsy/224, accessed on 24.08.2021

The difference between the first group of verbs and the other two that one may see when looking at the lists above (except for the verb *zagordit'sja* 'to become stuck-up') is that verbs like *učitel'stvovat'* 'to work as a teacher' are intransitive.⁴

Let us explore this connection. Note that there are verbs that can be combined both with the resultative and the inchoative *za-*. In such cases one can notice that the verb with the inchoative *za-*, as in (18a), is intransitive, whereas the verb with the resultative *za-*, as in (18b), is transitive.

- (18) a. On zagovoril.
 he za.talk.PST.SG.M
 'He started talking.'
- b. On zagovoril menja.
 he za.talk.PST.SG.M me
 'He made me forget about something by his talking.'

An evident exception to this observation are motion verbs. With motion verbs, transitivity does not hinder the attachment of the inchoative *za-*, as illustrated

⁴The verb *zagordit'sja* 'to become stuck-up' it is a reflexive verb, so in some sense the direct object is "integrated" in the verb, so we will leave it aside.

by (19a). At the same time, the resultative *za-* cannot be attached to motion verbs. What can be attached is the spatial *za-*, but it requires the *path* scale to be presented in the structure of the verb and the path itself has to be provided (more details in Zinova & Osswald 2016). As we have discussed in Section 2.3.6, prefixes acquire spatial interpretations only with determinate motion verbs. The derived prefixed verbs (see example (19a)) may, in turn, look identical to the corresponding indeterminate motion verbs that are prefixed with the same prefix (see (19b)) and then imperfectivised (see (19c)) and compare the examples (19a) and (19c)).

- (19) a. Maša zanosila_{indef}^{PF} posylki.
 Maša za.carry.PST.SG.F parcel.PL.ACC
 ‘Masha started carrying parcels.’
- b. Maša zanesla_{det}^{PF} posylku Kate.
 Maša za.carry.PST.SG.F parcel.SG.ACC Katja.DAT
 ‘Masha brought Katja the parcel.’
- c. Maša zanosila_{det}^{IPF} posylku Kate.
 Maša za.carry.PST.SG.F parcel.SG.ACC Katja.DAT
 ‘Masha was carrying the parcel to Katja.’

As is pointed out by Braginsky (2008: 227), some transitive non-motion verbs can be prefixed with the inchoative *za-* if the direct object is a bare plural noun (no measure phrases or numeral expressions).

- (20) Ivan začital^{PF} (*vse) / (*tri) / (*kak minimum tri) knigi.
 Ivan za.read.PST.PL.M all / three / at least three books
 ‘Ivan started reading books (in general).’
 = example (17) in Braginsky 2008: 227

The verb *čitat* ‘read’ can also be combined with the resultative *za-*. The output is the verb *začitat* ‘to damage as a result of prolonged reading’ (21). In this case the direct object must be definite, so also a bare plural noun is interpreted as a definite description.

- (21) Ivan začital^{PF} vse knigi.
 Ivan za.read.PST.SG.M all books
 ‘Ivan damaged all the books by his reading.’
 = example (37a) in Braginsky 2008: 246

The unifying property of all the examples we have just considered is that in cases when the attachment of the inchoative *za-* is not possible, some scale, except for

4 Semantics of individual prefixes

the time scale, is available either due to the verbal semantic structure or due to the direct object. In parallel, when the inchoative *za-* can be attached, the time scale is the only scale available. On the basis of this observation I agree with Padučeva (1996) that the relation to the time scale is the crucial property for the attachment of the inchoative *za-*, but I want to propose a different explanation for this fact. I claim that what prevents these verbs that have been categorised as holding for extra-long intervals of time by Padučeva (1996) from being prefixed with the inchoative *za-* is that they lexicalise some specific scale: the event of weighing is by default measured in weight units, not in terms of time, as an event of jumping, for example. Time specification is still available for such verbs, but it is not the default domain, which prevents them from being combined with the inchoative *za-*. This is related to the other pattern we will discuss later in this chapter: verbs that do not lexicalise any other scale, except for the time scale, are usually capable of serving as a source for prefixation with the delimitative prefix *po-* (applied to the time scale).

The proposed explanation does not cover the case of the verb *ljubit'* 'to love', as there seems to be no other scale except for the *time* in the semantic structure of this verb. I do not have an answer why the verb *ljubit'* 'to love' cannot be prefixed by the inchoative *za-*, but I would like to note that it can be interpreted inchoatively when it is prefixed with *po-*. The result of the prefixation is the verb *poljubit'* 'to fall in love with'. If the verb *ljubit'* was atemporal, the derivation of a verb with an inceptive interpretation from it would not be possible with any prefix, yet it is possible and also unusual, as the prefix *po-* is (except in this case) only interpreted inchoatively when attached to determinate motion verbs. So it seems that the verb *ljubit'* 'to love' is special and deserves an investigation from a historical perspective.

Let us now discuss another example, the verb *zaželtet'* 'to become seen as yellow', mentioned by Braginsky (2008) as a verb that contains the inchoative *za-*. The verb *želtet'* has two interpretations: 'to become yellow' and 'to have yellow colour and be seen'. These two interpretations are connected to different internal scales: the first one is about colour intensity, whereas the second one is about visibility while the colour remains constant (yellow). The two interpretations also lead to different prefix contributions when *za-* is attached: resultative semantics of the derived verb in case of 'to become yellow' meaning of the derivational base, as illustrated by (22a), and an inchoative interpretation in case the derivational base denotes a situation in which an object of yellow colour becomes visible, as in (22b).

- (22) a. On podros i sdelalsja neprijatno
 he pod.grow.PST.SG.M and s.make.PST.SG.M.REFL unpleasantly
 zubastym, glaz zaželtel, zrački priobreli
 toothy, eye za.become.yellow.PST.SG.M, pupils pri.get.PST.PL
 demoničeskuju vertikal'nuju formu.
 demonic vertical form
 'He grew up and became unpleasantly toothy, his eye became yellow-
 coloured and his pupils acquired a demonic vertical form.' [https://
 books.google.com/books?isbn=5457040119](https://books.google.com/books?isbn=5457040119), accessed on 24.08.2021
- b. Čerez neskol'ko minut na gorizonte zaželtel
 across several minutes on horizon za.seen.as.yellow.PST.SG.M
 svet far.
 light headlight.PL.GEN
 'Several minutes later yellow headlights appeared on the horizon.'
<https://books.google.com/books?isbn=5457264963>, accessed on
 24.08.2021

It is sometimes difficult to distinguish between the resultative and the inchoative interpretation of the prefix *za-*. To do this, the first idea is to use a part of the traditional test for telicity (see Section 2.4): try to modify the verbal phrase with a time measure phrase like *za 3 časa* 'in 3 hours'. If this is not possible, can only be interpreted inchoatively. Unfortunately, there is no reverse implication: if the event described by the inchoative verb has a non-instantaneous preparatory phase, such a verb is also compatible with the *za 3 časa* 'in 3 hours' measure phrase. In order to distinguish such verbs from *za-*-prefixed verbs that have resultative interpretation, I propose to use the context schematically represented in (23).

- (23) On Y-al, Y-al, i za-Y-al.
 he verb.PST.SG.M verb.PST.SG.M and za.verb.PST.SG.M
 'He was Y-ing, Y-ing, and finally Y-ed.'

Such contexts can be embedded directly into the original sentence in order to check the interpretation of the given verb in the given context. If structure (23) can be successfully embedded in the sentence, the usage of the verb prefixed with *za-* is resultative. If the sentence does not make sense after the insertion of context (23), the prefix *za-* has inchoative semantics.

Let us run the test with the sentences in (22) in order to illustrate how it works. We substitute the verb *zaželtel* 'became yellow/seen as yellow' with the phrase

4 Semantics of individual prefixes

želtel, želtel, i zaželtel. If the verb *želtet* is interpreted as ‘to become yellow’, this phrase means ‘was becoming and becoming more yellow and then became yellow’. The same phrase in the ‘to have yellow colour and be seen’ interpretation of the verb *želtet* can be translated as ‘it was yellow and was seen and seen and then it appeared and it was yellow’. It is obvious that the second interpretation of this phrase does not make sense, so the whole sentence (24b) can not be interpreted. Sentence (24a) is a perfect Russian sentence (although its English translation is not natural).

- (24) a. On podros i sdelalsja neprijatno
 he pod.grow.PST.SG.M and s.make.PST.SG.M.REFL unpleasantly
 zubastym, glaz želtel, želtel,
 toothy, eye become.yellow.PST.SG.M, become.yellow.PST.SG.M,
 i zaželtel, zrački priobreli
 and za.become.yellow.PST.SG.M, pupils pri.get.PST.PL
 demoničeskuju vertikal’nuju formu.
 demonic vertical form
 ‘He grew up and became unpleasantly toothy, his eye became more
 and more yellow and finally it turned completely yellow, and his
 pupils acquired a demonic vertical form.’
<https://books.google.com/books?isbn=5457040119>
- b. #Čerez neskol’ko minut na gorizonte želtel,
 across several minutes on horizon seen.as.yellow.PST.SG.M,
 želtel, i zaželtel svet
 seen.as.yellow.PST.SG.M, and za.seen.as.yellow.PST.SG.M light
 far.
 headlight.PL.GEN
 #‘After several minutes the yellow light was seen and seen and then
 appeared on the horizon.’

What these examples show is that in case the verb *zaželtel* ‘to become yellow/to be yellow and become seen’ has the colour intensity scale in its structure (when interpreted as ‘to become yellow’), it acquires resultative meaning after being prefixed with *za-*. If no other scale than the time scale is available in the structure of the verb as it is the case with the second interpretation of the verb *želtet* (‘to be yellow and become seen’), the attachment of the prefix *za-* leads to the inchoative interpretation of the derived verb.

Similarly, obligatorily transitive verbs are usually not compatible with the inchoative interpretation of the prefix *za-*, as for these verbs the obligatory direct

objects provide scales associated with it: the event of reading three books is measured in the cumulative length or quantity of the books that are read. As for motion verbs, *katat' tri teležki* 'to roll three carts' is not measured by the number of carts rolled, as the action denoted by this phrase is perceived as happening simultaneously with all three carts. So for indeterminate motion verbs the time scale is the only scale available. It is different in the case of determinate motion verbs: the phrase *katit' tri teležki* 'to push three carts' describes rolling three carts along some path, so the attachment of the prefix *za-* leads to the spatial interpretation.

Apart from indeterminate motion verbs, there are other cases when the direct object does not contribute a scale to the verb which makes the attachment of the inchoative *za-* is possible, e.g., the verb *xotet'* 'to desire', mentioned by Braginsky (2008). As desiring three ice creams is not an event progressing along the *quantity* scale but is only related to time, the prefix *za-* is interpreted inchoatively when attached to the verb *xotet'* 'to desire'.

- (25) Ivan *zaxotel*^{PF} tri morožennyx srazu.
 Ivan ZA-wanted three ice-creams at once
 'Ivan began to want three ice-creams at once.'
 = example (47b) in Braginsky 2008: 254

The explanation I offer for the (non-)availability of the inchoative interpretation of the prefix *za-* with particular verbs is in some respect similar to the explanation of Braginsky (2008), who proposes that inchoative interpretations occur in cases where resultative interpretations are blocked. The absence of any other scale except for the time scale guarantees that the resultative interpretation is not available. The advantage of the approach advocated here is that there is no need for a separate explanation for the cases when both resultative and inchoative interpretations are not possible, which is a part missing in the account of Braginsky (2008).

Now that we came closer to the understanding of the semantic properties that are required for the attachment of the inchoative prefix *za-*, let us consider another type of restriction associated with this prefix. Tatevosov (2009) categorises *za-* as a selectionally limited prefix, namely, a prefix that can be attached to imperfective verbs only. Judging from the available data and introspection, this generalisation seems to be correct. A question one may ask is whether there is some deeper motivation for such a restriction. I claim that the answer to this question is positive and, again, motivated semantically.

4 Semantics of individual prefixes

Let us consider the semantic structure of a perfective verb and the semantic contribution of the inchoative prefix *za-*. A perfective verb normally (not always) denotes an event that is maximal with respect to some scale (i.e., the end point of that scale is reached). As we have just discussed, in order for the inchoative prefix *za-* to be attached, the time scale should be the only available scale in the verbal semantic structure. This rules out the possibility of attachment of the inchoative *za-* to any perfective verb with a prefix that does not select the time scale. What is left are verbs that are measured with respect to the time scale (as can happen in the case of perfective verbs with prefixes *po-* and *pere-*). The problem is that such events are associated with an endpoint at which the activity (denoted by the derivational base verb) stops.

On the other hand, the inchoative *za-* contributes the information that, at the end of the event described by the derived verb, the activity denoted by the derivational base is being performed. These two pieces of semantic information are incompatible and thus the attachment of *za-* is impossible. There is one case when the explanation provided above is not valid, namely when *po-* has inceptive semantics. However, the inceptive semantics of *po-* results from its attachment to a directed motion verb and is associated with the initial segment of the *path* scale. There is one exception to this pattern, as we have seen above: the verb *poljubit'* 'to fall in love' contains the prefix *po-* with inceptive semantics, even though it is not a motion verb. Indeed (and to my personal surprise), the verb *zapoljubit'* 'to start loving' is used by some native speakers, as illustrated by example (26). The semantics of this verb is intensified inception, which is not a very clear concept, but the number of examples in the web evidencing this verb is such that its existence (at least in the colloquial language) is beyond doubt.

- (26) ili že, naoborot, igral s det'mi, što očen' v poslednee
or again conversely played with children that very in last
vremja zapoljubil
time za.po.love.PST.SG.M
'or, on the contrary, he played with children, which he suddenly started
to love in the last time' www.poezia.ru

From this follows that the restriction on the aspect of the derivational base is motivated by two aspects. First, it is the semantic representations of the verb and prefixes, and second, a principle that tells that two verbs belonging to a derivational chain cannot have the exact same semantics. The latter is another way of saying that additional morphological complexity has to be avoided if the semantics is not enriched. As Braginsky (2008) formulates it, "the economy principle of the word-formation does not allow grammar to form new words with the exact

lexical meanings as the existing ones.” This principle will be used repeatedly in the proposed analysis.

4.3.3 Secondary imperfective

It has been observed that suffixing an inchoative *za*-prefixed verb with the imperfective suffix is not always possible. The question when it is possible and when not is discussed in the literature, but the conclusions different authors arrive at are vague. For example, Svenonius (2004b: 230) writes that “inceptive *za*-almost never forms secondary imperfectives in Russian” and Braginsky (2008: 220) states that “some inchoative *ZA*-prefixed forms allow secondary imperfectivisation.” Braginsky (2008: 231) also claims that “[t]hose inchoative forms that do undergo secondary imperfectivisation acquire a habitual reading of imperfective aspect, rather than a progressive one.” In addition, he notes that this may be due to the fact that “inchoative *ZA*-prefixed verbs are achievements”, but acknowledges that “[t]he problem is, however, that most inchoatives block even a habitual secondary imperfectivisation.” However, Tatevosov (2009) associates the inchoative prefix *za-* with a restriction on its attachment site, but not with a restriction on the subsequent imperfectivisation. With this in mind, let us look at the data.

As we have already seen in Section 3.4, there are in fact cases when the imperfective verb derived from the *za*-prefixed inchoative verb receives an ongoing interpretation. One example, which we have already seen, is repeated in (27), another is given in (28).

- (27) Arkadij Sergeevič kak raz zakurival, poètomu ne
 Arkadij Sergeevich as time *za.smoke.IMP.PST.SG.M*, that is why not
 zametil, kak na poslednej fraze Olafson počemu-to
 notice.*PST.SG.M*, as on last phrase Olafson because of something
 vorovato strel'nul glazami.
 thievishly shoot.*sem.PST.SG.M* eye.*PL.INST*
 ‘Arkadij Sergeevich was just lightning the cigarette, so he didn’t notice
 Olafson’s thievish glance during the last phrase.’ = example (2) here
- (28) Ja dal emu sigaretu i, kogda on zakurival,
 I give.*PST.SG.M* he.*DAT* cigarette and, when he *za.smoke.imp.PST.SG.M*,
 ja zametil, što u nego drožat ruki.
 I notice.*PST.SG.M*, that near he.*GEN* tremble.*INF* hand.*PL.NOM*
 ‘I gave him a cigarette and, when he was lightning it, I noticed, that his
 hands were trembling.’ Charles Bukowski, *Jug bez priznakov severa*
 [South of no north] (Russian translation)

4 Semantics of individual prefixes

For many other verbs, however, the progressive interpretation is indeed impossible. Braginsky (2008) provides the following examples of usages of perfective and imperfective verbs that contain the inchoative prefix *za-*:

- (29) a. Ivan zagovoril^{PF} / zagovarival^{IPF} s proxožimi.
Ivan ZA-talked / used to ZA-talk with passers-by
'Ivan started talking / used to start talking with passers-by.'
- b. Ivan zapel^{PF} / zapeval^{IPF} pesnju.
Ivan ZA-sang / used to ZA-sang song
'Ivan started singing / used to start singing a song.'
- = ex. (7) in Braginsky 2008: 221

The imperfective verbs in the examples (29a) and (29b) do not receive a progressive interpretation. (At least, searching for progressive usages of these verbs does not provide any result.) I claim that the difference between them and the verbs that allow a progressive interpretation, as *zakurivat* 'to start smoking' in examples (27) and (28), is the absence of a preparatory phase.

From the above follows, that whenever a secondary imperfective is derived from a *za-* prefixed verb with inchoative semantics, it can acquire a progressive interpretation if the event denoted by the verb has a preparatory phase with a non-zero time span. In (28) the trembling happens in the period of lightning the cigarette, the end of which is referred to by the perfective verb *zakurit* 'to start smoking'⁵.

So the idea of Braginsky (2008) seems to be on the right track: many inceptive *za-*prefixed verbs do not receive a progressive interpretation when imperfectivised because they denote achievements: inception events that are instantaneous and usually lack a preparatory phase. What Braginsky (2008) has not described is the possibility of a progressive interpretation where the event denoted by the verb can be coerced into an event with a preparatory phase. Here, the preparatory phase is understood as something unambiguously identified as preceding the start of the process/activity described by the derivational base verb. E.g., for the verb *zaprygat* 'to start jumping' it is hard to imagine some phase that is unambiguously identified as the preparation for jumping, but is not a part of the jumping event. In the case of *zakurit* 'to start smoking', lighting a cigarette is, on the one hand, an obvious preparation for smoking, but is also, on the other hand, not smoking per se.

⁵While the English translation is ambiguous, the Russian verb refers to the preparatory phase and not to the event of smoking itself.

The situation with achievements in English is, in a way, similar: the progressive of some verbs denoting achievements is more acceptable than of some others (see examples (30a) and (30b)). As Rothstein (2004) proposes, it is possible to coerce some achievements into accomplishments by adding a preparatory phase (for further discussion on this topic, see Gyarmathy 2015).

- (30) a. The train was arriving at the station.
 b. *John was finding his phone.

So the difference between the resultative and the inchoative interpretations of *za-* can be formulated in the following way. Verbs prefixed with the resultative *za-* focus on the culmination point (and may refer to this point plus a period that precedes it) achieved as a result of performing the action denoted by the derivational base, as revealed by context (23). Verbs prefixed with the inchoative *za-* focus on the point after which the action denoted by the derivational base is performed (and, again, may also refer to the preceding period), so they fit into context (31).

- (31) On *za-Y-al* *i* *Y-al* 10 minut.
 he *za.verb.PST.SG.M* and *verb.PST.SG.M* 10 minutes
 ‘He started to Y and Y-ed for 10 minutes.’

Note also, that if a time measure phrase can be added to a verbal phrase headed by a *za-*prefixed verb with inchoative interpretation, this time phrase refers to the duration of the preparatory phase, rather than to the duration of the initiated event. This is illustrated by (32). Therefore, inchoative *za-*prefixed verbs that allow progressive interpretation of their imperfective derviate also should allow modification by the time measure phrase headed with the preposition *za*. (There is no implication in the other direction as the completed preparatory phase can be identified via the initiated process, while an incomplete one requires other non-linguistic cues.)

- (32) *Kompjuter zarabotal* *za* *četyre* *časa*.
 computer *za.work.PST.SG.M* behind four.ACC hour.SG.GEN
 ‘The computer started to work in four hours.’

Now we will explore the second point that has been noticed by Svenonius (2004b) and Braginsky (2008), but not taken into account by Tatevosov (2009): the absence of secondary imperfectives from many inchoative *za-*prefixed verbs.

The first class of such verbs consists of verbs that generally do not form secondary imperfectives after being prefixed, such as *želtet* ‘to become yellow/to

4 Semantics of individual prefixes

be yellow and become visible'. As it is not possible to construct any secondary imperfective form of this verb, the restriction may be a phonological one or related to the fact that the verb is derived from a colour name. In this case, the impossibility of secondary imperfectivisation seems associated with the verbal stem and not with the inchoative semantics of the prefix.

The second class of verbs is more interesting: these are verbs that have secondary imperfectives, but not when prefixed with the inchoative *za-*. For example, *zatakivat'* is an imperfective verb formed from *zatoľkat'* 'to push inside/to start pushing', but it only means 'to push/be pushing inside', not 'to start/be starting pushing'. A similar behaviour is observed for the verb *zanašivat'* that means 'to wear/be wearing until the thing is damaged', but not 'to start/be starting wearing', although the perfective verb *zanosit'* can mean both 'to wear until the thing is damaged' and 'to start wearing'.

For this class I offer the following explanation. On the one hand, the resultative meaning of such verbs when they are prefixed with *za-* is much more common than the inchoative meaning. So when the secondary imperfective verb is analysed, the more frequent meaning is processed as a candidate meaning for the source perfective verb. And, as we have discussed above, resultative and inchoative interpretations are produced on the basis of different interpretations of the derivational base (one involving only the time scale, another including some other scale), so there is no possibility of an easy shift between these interpretations. On the other hand, there is an alternative lexical way to express the inchoative meaning: one has to use the combination of the non-prefixed verb together with the verb *načat'* 'to start'. If the imperfective is needed, the 'auxiliary' verb *načat'* 'to start' can be imperfectivised. No comparable standard solution can be offered for the resultative interpretation of *za-*. These two facts together may have led to the current state, in which *za-*-prefixed verbs with resultative interpretation, form the secondary imperfective only from this interpretation. This explanation is tentative and leaves space for further research.

The third class consists of verbs that seem to have no secondary imperfectives, but can form them, if needed. As an example, consider the verb *zaigrat'* 'to start playing'. Out of context, the verb *zaigryvat'* is interpreted as 'to flirt', but it can also mean 'to start/be starting playing', if a supporting context is provided. This is the case of the example (33).

- (33) ...[n]o on smeľsja, zeval, preryval eë vostoržennye mečtanija
...but he laughed, yawned, intervened her enthusiastic dreams
pros'boju zakazat' k zavtrašnemu obedu pobol'se vetčiny ili,
request order to tomorrow dinner more ham or,

soskučivšis' slušat' neponjatnye dlja nego zvuki,
 become.bored listen not understandable for him sounds,
 zaigryval na svoj lad pesenku, kotoraja vozmuščala
 za.play.imp.PST.SG.M on his mood song.SG.ACC, that perturbed
 vsě suščestvovanie bednoj Ol'gi.
 all existence poor Olga

'...[b]ut he laughed, yawned, interrupted her enthusiastic dreams with a request to order more ham for the dinner tomorrow or, bored from listening to sounds he could not understand, was starting to play a song in his own way, that perturbed the whole existence of poor Olga.'

E. A. Gan. *Ideal* (1837)

Another example is the verb *zasmejat'sja* which can be interpreted both inchoatively ('to start laughing') and resultatively ('to laugh until reaching some state'). The resultative meaning is, however, very uncommon. When this verb is suffixed with the imperfective suffix *-iva-*, the resulting verb, *zasmeivat'sja*, receives two interpretations: the habitual interpretation 'to regularly start laughing' that stems from the inchoative meaning of *zasmejat'sja* 'to start laughing', as in (34a), and the habitual interpretation 'to regularly laugh until reaching some state' that is based on the resultative meaning of *zasmejat'sja* 'to laugh until reaching some state', as in (34b). These examples support the tentative explanation of the behaviour of verbs in the second class: the frequency of different interpretations seems to play a role in the possibility of getting a secondary imperfective with a particular interpretation.

- (34) a. Priam vsě zasmeivalsja s bol'šim azartom
 Priam all za.laugh.PST.SG.M.refl with greater fervour
 'Priam started laughing again and again, every time with greater fervour.'
<https://ficbook.net>
- b. ...postojanno do slěz zasmeivalsja zaključennymi...
 ...constantly until tears za.laugh.PST.SG.M.refl prisoner.PL.INST...
 '...he always laughed at prisoners until he wept tears...' mobooka.ru

4.3.4 Summary

To sum up, the formal representation of the inchoative *za-* should have the following properties:

1. the inchoative interpretation of the prefix is only possible when the derivational base does not have any explicit scales except for the time scale in its

4 Semantics of individual prefixes

semantic representation (and the derived verb can only be used in contexts that do not contribute a scale);

2. attaching the prefix *za-* relates the starting point of the event to the state of the absence and the end point of the event to the state of the presence of the activity denoted by the derivational base.

Other properties that we have discussed should be reflected in the representation of the verbs and the secondary imperfective suffix: e.g., verbs that denote events with an extended preparatory phase should have information about it in their semantic structure. In turn, the progressive interpretation of the secondary imperfective and the time measure phrase should be capable of modifying the preparatory phase of the event in case the event itself does not have any duration. The lexical entries of verbs that do not allow the attachment of the imperfective suffix under any circumstances should be marked as such.

What is not possible to formalise within the framework adopted in the current analysis are the restrictions on the attachment of the imperfective suffix associated with the frequency (or probability) of a particular interpretation of the given verb. If a probabilistic approach to semantics is integrated in the system, this should become possible, provided the explanation offered above is on the right track.

4.4 *na-*

4.4.1 Semantic contribution

First let us have a look at the different usages available for the prefix *na-*. For this, we consult the grammar by Švedova (1982: 360), where the following six types of *na-*prefixed verbs are listed:

1. to direct the action denoted by the derivational base onto some surface, to place on or come across something (productive type): *nakleit'* 'to paste';
2. to accumulate something by performing the action denoted by the derivational base (productive type): *navarit'* 'to cook a lot of';
3. to perform the action denoted by the derivational base intensively (productive type): *nagladit'* 'to iron thoroughly' (colloquial);
4. to perform the action denoted by the derivational base weakly, lightly, on the go (non productive type): *naigrat'* 'to strum' (colloquial);

5. to learn something or acquire some skill by performing the action denoted by the derivational base (productive type): *natrenirovat'* 'to train until some level', *nabegat'* 'to train to run' (only in professional slang);
6. to perform the action denoted by the derivational base until the result (productive type): *nagret'* 'to heat up', *namočít'* 'to make wet', *napoit'* 'to give something to drink'.

This section investigates the cumulative usage (type 2 in the above list) more closely. Note that other productive usages of the prefix *na-* are not considered superlexical by those linguists who adopt the distinction. At the same time the representation I provide for the prefix *na-* in Chapter 6 covers not only the second usage, but also the usages listed under three, five, and six.

The cumulative prefix *na-* and the prefix *po-* (in the delimitative meaning) that we are going to discuss in Section 4.5, share a number of properties. Both prefixes are claimed to denote a vague measure function (Filip 2000; Součková 2004). Součková (2004) formulates two differences between these prefixes: the direction of the relation and the dimensions of the scales they select for.

There are two main usages of the cumulative prefix *na-* in Russian: transitive and reflexive. Transitive usage is exemplified by (35a), where the prefix measures the quantity of the direct object (potatoes) that has been cleaned. Reflexive usage is exemplified by (35b); here, the prefix *na-* measures the degree to which the subject (Katja) is full after eating potatoes. The case of the reflexive usage will not be discussed in this thesis, for analyses see Kagan & Pereltsvaig (2011a,b); Součková (2004); Filip (2000; 2005). (In fact, the analysis of *na-* would remain the same, what is needed for this case is the interpretation of the postfix *-sja* that would provide the appropriate scale.)

- (35) a. Katja načistila kartoški.
 Katja na.clean.PST.SG.F potato.GEN
 'Katja peeled a lot of potatoes.'
- b. Katja naelas' kartoški.
 Katja na.eat.PST.SG.F.refl potato.GEN
 'Katja became full by eating potatoes.'

There is another usage of *na-* (listed under (6) above) that is closely related to the cumulative usage exemplified by (35a). The verb *namočil* 'wet' in (36) denotes an event of wetting something that is non-cumulative in every respect: a single actor wet a single object with a single move. Another difference with respect to the verbs such as *načistit'* 'to peel a lot of' is the source of the scale: in (35a) the

4 Semantics of individual prefixes

event is measured along the quantity scale provided by the direct object, while in case of (36) the relevant wetness scale is encoded by the verb.

- (36) Petja namočil kistočku v stakane vody.
Petja na.wet.PST.SG.M brush.SG.ACC in glass.SG.PRP water.SG.GEN
'Petja wet the brush by putting it into a glass with water.'

To account for this, one can either accept the polysemy among the productive usages of the prefix *na-* or try to unify them. If one considers the list of *na-*prefixed verbs that do have clear cumulative semantics, one can notice that for verbs in this list there is another way to express the completion of the event denoted by the derivational base. For example, instead of (35a) the speaker could have uttered (37a) which would be neutral with respect to the quantity of the potatoes peeled or (37b) that would mean that Katja peeled all of the potatoes. The same happens in the pair of sentences (38a) and (38b). The sentence with the verb prefixed with *na-* refers to an event of cooking involving some quantity of the soup that exceeds the standard amount. The sentence with the *s-*prefixed verb does not carry any information about the quantity of soup produced.

- (37) a. Katja počistila kartoški.
Katja po.clean.PST.SG.F potato.GEN
'Katja peeled some potatoes.'
b. Katja počistila kartošku.
Katja po.clean.PST.SG.F potato.ACC
'Katja peeled the potatoes.'
- (38) a. Liza navarila supa.
Liza na.cook.PST.SG.F soup.GEN
'Liza cooked a lot of soup.'
b. Liza svarila sup.
Liza s.cook.PST.SG.F soup.ACC
'Liza cooked soup.'

On the basis of these observations I can offer the following potential explanation of what is happening with the prefix *na-*: the core meaning of the cumulative prefix *na-* is 'performing an action until the validation point is reached'. The validation point is, in different cases, either some standard quantity of the direct object or some degree on the scale. When it is reached, the action denoted by the derivational base counts as having been performed. For example, the verb *gret*^{1PF} means 'to warm' and the verb *nagret*^{2PF} 'to heat up' denotes warming

until the warm state of the object is reached. Such an approach would unify the second, third, fifth, and sixth usages in the list by Švedova (1982), so that the only other productive usage not covered here is associated with the spatial scale (first usage in the list above).

This description is very close to that of Kagan (2015), who offers the semantic representation of the prefix *na-*, as shown in (39). Kagan (2015: 55) proposes that “*na-* looks for a verbal predicate that takes a degree, an individual and an event argument and imposes the ‘ \geq ’ relation between the degree argument and the contextually provided expectation value d_c . As a result, the degree of change is entailed to be no lower than the standard.”

- (39) $[[na-]] = \lambda P \lambda d \lambda x \lambda e. [P(d)(x)(e) \wedge d \geq d_c]$
 where d = degree of change (Kennedy & Levin 2002)
 = (17) in Kagan 2015: 55

The semantic representation proposed by Kagan (2015) allows us to capture the semantics of the cumulative and the resultative usages of the prefix *na-*. What is left unclear are the circumstances, in which the cumulative interpretation is obtained. For example, for the verb *nagret* ‘to heat up’ one does not want to derive the interpretation like ‘heat more than expected’, as this would be the meaning of the verb *peregret* ‘to overheat’. A possible solution will be to simplify the semantics of *na-* by restricting it to achieving the standard/expected degree on the scale and derive the additional component of exceeding the expectations in some cases in the pragmatic module. For this, one has to look at the competition between different perfective verbs derived from the same derivational base. If there is an alternative competing verb that is neutral with respect to the quantity of the direct object, uttering the verb prefixed with *na-* implies a higher degree on the scale than standard. Similar pragmatic reasoning is not uncommon in the literature: for example, Kennedy & Levin (2008: 21) use pragmatic reasoning to explain certain preferences in the domain of degree achievements. I will provide more details in this respect in Chapter 5.

4.4.2 Restrictions on attachment

As we have discussed in the previous chapter, the cumulative prefix *na-* is usually attached to imperfective verbs. There are, however, exceptions to this generalisation. At least two verbs formed by prefixation of perfective verbs with the cumulative *na-* are accepted by all native speakers of Russian. These are *nakupit*^{PF} ‘to buy a lot of something’ and *napustit*^{PF} ‘to fill with a lot of something’. In addition, Tatevosov (2013a) notes that there is a group of speakers, seemingly from an older

4 Semantics of individual prefixes

generation (and representing an earlier linguistic norm of the language) who accept a larger class of verbs derived by the *na*-prefixation of perfective verbs, such as [?]*napridumat*^{'PF} 'to come up with a lot of something', [?]*narasskazat*^{'PF} 'to tell a lot of something', and [?]*nasočinit*^{'PF} 'to write/compose a lot of something'.

Starting with the information about the earlier norm of the language, let us take a diachronic perspective in order to explain the behaviour of the cumulative *na*-. Suppose some time ago the attachment of the cumulative *na*- to a perfective verb was the norm in the language (for whatever reason). This does not mean that *na*- was attached only to perfective verbs, but just the absence of the restriction (as is suggested by Tatevosov (2013a) for those speakers who nowadays produce verbs such as *narasskazat*^{'PF} 'to tell a lot of something'). Then in such pairs as [?]*napridumat* – *napridumyv*^{'at} 'to come up with a lot of something', [?]*naotkryt* – *naotkryvat*^{'at} 'to open a lot of', *nakupit* – *napokupat*^{'at} 'to buy a lot of' both verbs were acceptable. As the first members of these pairs are morphologically less complex, they might have been preferred over the second members of the pairs.⁶

Note that the difference in morphological complexity of the two members of the pair can vary. The morphological complexity difference between the competing verbs *naotkryt* 'to open a lot of' and *naotkryvat* 'to open a lot of' is only one morpheme: the imperfective suffix, as is clear from the derivational chains (40a) and (40b). In the pair *nakupit* 'to buy a lot of' and *napokupat* 'to buy a lot of' this difference is two morphemes: in order to derive a cumulative verb from an imperfective verb, a prefix is added and the suffix changed, as illustrated by the derivational chains (41a) and (41b).

- (40) a. *ot-kr-y-t*^{'PF} → *na-ot-kr-y-t*^{'PF}
to open → to open a lot of
- b. *ot-kr-y-t*^{'PF} → *ot-kr-y-va-t*^{'IPF} → *na-ot-kr-y-t*^{'PF}
to open → to open/be opening → to open a lot
- (41) a. *kup-i-t*^{'PF} → *na-kup-i-t*^{'PF}
to buy → to buy a lot
- b. *kup-i-t*^{'PF} → *po-kup-a-t*^{'IPF} → *na-po-kup-a-t*^{'PF}
to buy → to buy/be buying → to buy a lot

To provide some evidence in favour of the theory of competition sketched above, let us consider cases where the perfective verb is equally or more morphologi-

⁶This can be explained by a pragmatic principle related to the one we have already discussed: if there are two forms with identical semantics, the less complex form is preferred. In this case forms of different complexity do not belong to one derivational chain, so this principle is only about the preference, not about the exclusion of one of the verbs.

cally complex than the corresponding imperfective verb. In the first pair of verbs, *oščut-i-t*^{'PF}/*oščušč-a-t*^{'IPF} 'to feel', the imperfective verb is as complex as the perfective one, as the two verbs include the same number of morphemes. In the second pair, *vz-j-a-t*^{'PF}/*br-a-t*^{'IPF} 'to take', the perfective verb is morphologically more complex than the corresponding imperfective verb. It turns out that in both pairs the cumulative prefix *na-* can only be attached to the imperfective verb for all speakers of Russian (see chains in (42) and (43) and examples (44) and (45)).

- (42) a. *oščut-i-t*^{'PF} → **na-oščut-i-t*^{'PF}
to feel
- b. *oščušč-a-t*^{'IPF} → *na-oščuč-a-t*^{'PF}
to feel/be feeling → to feel a lot
- (43) a. *vz-j-a-t*^{'PF} → **na-vz-j-a-t*^{'PF}
to take
- b. *br-a-t*^{'IPF} → *na-br-a-t*^{'PF}
to take/be taking → to take a lot
- (44) Instinkt žizni diktuet naoščučat' kak možno bol'she za žizn'.
instinct life.SG.GEN dictates na.feel.INF as possible more for life
'The instinct of life dictates that you should feel as much as possible during your life.'
Mixail Veller. *Belyj oslik* (2001)
- (45) On nabral celoe ožerel'e rakušek [...]
he na.take.PST.SG.M whole necklace shell.PL.GEN
'He gathered shells for a whole necklace [...]'
Aleksandr Dorofeev. *Èle-Fantik* (2003)

Taking this into account, we can modify the assumption about the absence of a restriction on the attachment of the cumulative *na-*, saying that the attachment to the imperfective verbs was still slightly preferred over the attachment to the perfective verb. Together with the pragmatic principle that penalises morphologically more complex verbs we then obtain a system that corresponds to the earlier norm.

Now that we have discussed the competition between different verbs in the situation when the cumulative *na-* can be attached to both imperfective and perfective verbs, let us see what happens when the norm shifts and the attachment of the cumulative *na-* to a perfective verb becomes significantly dispreferred. At this moment the rules of competition change: increasing the morphological complexity of the verb by one morpheme becomes better than violating the aspectual restriction. And in such pairs as *napridumat'* vs. *napridumyvat'* 'to come up with

4 Semantics of individual prefixes

a lot of something' the second member becomes preferred over the first. If, however, increasing the morphological complexity by two is still penalised more than violating the aspectual restriction, verbal pairs with greater difference in morphological complexity would still allow the attachment of the cumulative prefix *na-* to the perfective derivational base. And this is exactly what we observe in case of *kupit' – pokupat'* 'to buy'.

Another exception is the verb *napustit'*^{PF} 'to fill with a lot of something' that is derived from the perfective verb *pustit'*^{PF} 'to let'. It is not clear what exactly happens with this particular verb, but it is exceptional not only with respect to the combination with the cumulative *na-*. First of all, a whole range of prefixed verbs that seem to be formed via prefixation of the derivational base *puskat'*^{IPF} 'to let' turn out to be imperfective: *otpuskat'*^{IPF} 'to let leave', *zapuskat'*^{IPF} 'to start something', *napuskat'*^{IPF} 'to fill with a lot of something', *spuskat'*^{IPF} 'to let out', etc. If we assume that these verbs are indeed derived from the imperfective verb *puskat'*^{IPF} 'to let', as shown in (46), we have to postulate non-perfectivising usages for a number of prefixes. This is an argument in favour of the alternative hypothesis: the assumption that the last step in the derivation of these verbs is imperfectivisation, as shown in (47). Such an explanation is not complete as it just reduces the problem to the puzzle about a concrete verb, not about the prefixation system, but I have no solution for this new puzzle at the moment. I believe that the answer might be given from a historical perspective and may have similar roots as the answer to the puzzle of the motion verbs. I leave this question open for future research.

(46) *puskat'*^{IPF} → *zapuskat'*^{IPF} / *napuskat'*^{IPF}
 to let → to (be) starting something / to (be) fill(ing) with a lot of

(47) *pustit'*^{PF} → *zapustit'*^{PF} / *napustit'*^{PF} →
 to let → to start something / to fill with a lot of →
zapuskat'^{IPF} / *napuskat'*^{IPF}
 to (be) starting something / to (be) fill(ing) with a lot of

4.4.3 Subsequent imperfectivisation

The attachment of the imperfective suffix to verbs prefixed with *na-* is treated in the literature similarly to the case of the inchoative prefix *za-*: Svenonius (2004b: 230) classifies the cumulative *na-* as a prefix that sometimes allows the formation of the secondary imperfective, whereas Tatevosov (2009) does not pose any specific restrictions (if fact, such restrictions are absent in his account at all).

An illustrative example is provided by Svenonius (2004b: 233) and repeated here as (48). In (48a) we see a perfective verb with a literal interpretation of the derivational base, whereas in (48b) and (48c) we observe that the secondary imperfective can not be interpreted literally. Svenonius (2004b: 233) attributes this asymmetry of the secondary imperfective formation to the difference in the structural positions. I claim that the verb *nakalyvat*^{IPF} ‘to pin/be pinning/to cheat/be cheating’ is usually not interpreted as ‘to crack/be cracking a lot’ not because of the position of the prefix in the structure of the verb *nakolot*^{PF} ‘to crack a lot’, but because the latter verb also has the other meaning ‘to pin’, derived from the spatial interpretation of the prefix *na-*.

- (48) a. On na-kolol orexov.
 he cmlt-cracked^P nuts
 ‘He cracked a sufficiently large quantity of nuts’
- b. *On na-kalyval orexov.
 he cmlt-cracked^I nuts
 (‘He was cracking a sufficiently large quantity of nuts’)
- c. On na-kalyval klijentov.
 he on-cracked^I clients
 ‘He was cheating the clients’
- = example (63) in Svenonius 2004b: 230

So the situation turns out to be similar to that of the inchoative prefix *za-*: when a *na-*-prefixed verb has two interpretations, one (more frequent) of them involving spatial and the other involving cumulative meaning, the secondary imperfective of this verb will be normally interpreted as formed on the basis of the spatial interpretation. The reason is also similar: there is a regular lexical way to express the meaning that a secondary imperfective verb with the cumulative interpretation of the prefix *na-* would have (use the non-prefixed imperfective and the adverb *mnogo* ‘a lot’). For the lexical meaning of the prefix, no such regular replacement of the secondary imperfective is available. Indeed, if we search for the examples of the usage of the verb *nakalyvat*, we mostly find sentences like (49), involving the spatial usage of the prefix *na-*.

- (49) a. Izvestny slučai, kogda eži podbirali i
 known cases when hedgehogs pod.take.imp.PST.PL and
 nakalyvali na svoi igly okurki ili pytalis’
 na.prick.imp.PST.PL on their needles cigarette stubs or try.PST.PL

4 Semantics of individual prefixes

“vyvaljat’sja” v kofejnyx zernax.

vy.wallow.imp.INF.REFL in coffee beans

‘We know about cases when hedgehogs picked up and pinned on their needles cigarette stubs or tried to roll in and get covered with coffee beans.’ <http://www.ogoniok.com>

- b. Očiščennye orexi nužno nakolot’, ja nakalyvala
peeled nuts necessary na.pin.INF, I na.pin.imp.PST.SG.F
vilkoj - tak bystree, čem zubočistkoj.
fork - so faster, then toothpick

‘You have to make holes in the peeled nuts, I pierced them with a fork, this is faster than using a toothpick.’ www.carina-forum.com

At the same time if we consult the dictionary, it turns out that the first interpretation provided for the verb *nakalyvat’* is ‘to crack something in some (normally big) quantity’ (Efremova 2000), which is exactly the interpretation of the secondary imperfective verb derived from the verb *nakolot’* ‘to crack a lot of’, that, according to Svenonius (2004b) does not exist and, according to the internet data, is at least very uncommon, if used at all. As dictionaries tend to represent an outdated norm, this phenomenon can be related to the norm shift we have discussed above.

I want to emphasise that the imperfectivisation of verbs prefixed with the cumulative *na-* is available in a larger number of cases than seems at first sight. I have sketched a possible explanation why its formation is dispreferred in case a spatial interpretation of the derivational base is available, but this explanation is about preference, not complete unavailability and uses information about the relative frequency of different interpretations. Consider the verb *navarit*^{PF} ‘to cook a lot/to weld something’. For the perfective verb, the cumulative interpretation is the default one, but the spatial interpretation is accessible in the relevant context. After the attachment of the imperfective suffix, the spatial interpretation (see example (50b)) is the default. The cumulative interpretation is dispreferred, but possible and easy to identify, as illustrated by (50a).

- (50) a. Ona navarivala sebe bol’sie kastrjuli kompotu i
she na.cook.imp.PST.SG.F yourself big pots compot and
s”edala ego s serym xlebom, v odinočku.
s.eat.imp.PST.SG.F him with grey bread, in singleton
‘She regularly cooked herself large pots of compote and ate it on her own together with rye bread.’ <http://gatchina3000.ru/>

- b. V obščem, vse vvxodnye brigada mestnyx svarščikov
 in general, all weekends team local welders
 latala im nos, navarivala listy
 patch.PST.SG.F them bow, na.weld.imp.PST.SG.F sheet.PL.ACC
 obšivki prjamo poverx izmjatyx.
 sheathing directly on top wrinkled
 ‘In sum, the whole weekend the team of local welders patched their
 bow, welding the sheathing sheets directly on top of the wrinkled
 ones.’ <http://kamafleetforum.ru/>

It turns out that the formation of secondary imperfective verbs from verbs prefixed with cumulative *na-* is in general available, although the derived imperfective verbs may not sound acceptable without a context. To provide another example, let us try to imperfectivise the verb *naguglit’* ‘to find something by googling’. The derived verb *naguglivat’* ‘to find something by googling occasionally’ is used, as evidenced by the examples one can find in the internet, such as (51). This verb is interpreted exclusively habitually which can be explained by using the principle based on the Horn’s division of labour (see Horn 1984): if there are two verbs that express the same meaning, the simpler one should be used. Indeed, the potential progressive interpretation of the verb *naguglivat’* is ‘to google something’, exactly the same as the interpretation of the verb *guglit’* ‘to google’ when it is used transitively. As for the habitual interpretation, there is a clear difference between the semantics of the basic imperfective verb *guglit’* ‘to google’ and the semantics of the derived secondary imperfective verb *naguglivat’* ‘to find something by googling occasionally’, as the latter includes the resultative component for every event of googling.

- (51) Spaseniem dejstvitel’no byli sovremennye stat’i, blogi, sajty,
 salvation really were contemporary articles, blogs, pages,
 kotorye ja naguglivala na planšete, v ktorom
 that.PL.NOM I na.google.imp.PST.SG.F on tablet, in that.M.SG.PRP
 že borolas’ so “Staršej Èddoj”.
 again fought with “older Edda”
 ‘My salvation was in contemporary articles, blogs and web pages that I
 googled on my tablet, that I also used to fight with “Older Edda”.’
<http://www.livelib.ru/review/259836>

Based on what we have observed so far, one can hypothesise that the progressive interpretation of secondary imperfective verbs that include the cumulative

4 Semantics of individual prefixes

prefix *na-* should be possible in cases when the derivational base is interpreted not just resultatively, but also carries the ‘a lot’ component (which happens due to competition with other verbs). This is confirmed by the data. As an example, consider the verb *nagotovit* ‘to cook/prepare a lot’.⁷ The derived secondary imperfective verb *nagotavlivat* ‘to prepare/be preparing a lot’ can be interpreted progressively (52a) as well as habitually (52b).

- (52) a. s 5 časov uže ne spitsja,
from 5 hours already not sleep.PRES.SG.3.REFL,
nagotavlivaju detjam
na.prepare.imp.PRES.SG.1 child.PL.DAT
‘I can’t sleep since 5 a.m., so I am preparing food for the children’
www.plastic-club.ru
- b. Vprok nikogda ne nagotavlivaju, ljubim vse
in store never not na.prepare.imp.PRES.SG.1, love.PRES.PL.1 all
svežee.
fresh
‘I never cook food for the next several days, we prefer to eat fresh.’
forum.bel.ru

4.4.4 Summary

To sum up, the formal representation of the cumulative prefix *na-* should have the following properties:

1. the prefix requires an open scale that is provided by the verb and a parameter of the object;
2. when the prefix is attached, it specifies the starting point of the event being at the starting point of the scale and the end of the event being at (or, possibly, at or above, see the discussion in the beginning of the section) the standard degree on the same scale.

Similarly to the analysis of *za-*, I am not going to restrict the attachment of the secondary imperfective to verbs prefixed with the cumulative *na-* in the semantic module.

⁷I consider it instead of the verb *navarit* ‘to cook’ here, as there are no other interpretations involving spacial *na-* available for it and thus the secondary imperfective is in general easily accessible. The neutral perfective derived from the verb *gotovit* ‘to prepare/be preparing’ is the verb *prigotovit* ‘to cook/prepare something’.

4.5 *po-*

4.5.1 Semantic contribution

To begin with, let us again look at the Russian grammar by Švedova (1982), who provides a list of possible usages of the prefix *po-* and their productivity. Švedova (1982: 364–365) names the following five types of situations the verbs prefixed with *po-* can refer to:

1. to do the action that is denoted by the derivational base with low intensity, sometimes also gradually: *poprivyknuť* ‘to get somehow used’, *poznošit’sja* ‘to get somewhat worn out’, *pomaslit’* ‘to put some butter on something’ (productive, especially in spoken language);
2. to do the action that is denoted by the derivational base repeatedly, with many or all of the objects or by many or all of the subjects: *povyvezti* ‘to take out many/all of something’ (productive, especially in spoken language);
3. to do the action that is denoted by the derivational base for some (often short) time: *pobesedovat’* ‘to spend some time talking’ (productive);
4. to start the action that is denoted by the derivational base: *pobežat’* ‘to start running’ (productive);
5. to complete the action denoted by the derivational base: *poblagodarit’* ‘to thank’ (productive).

We are going to look at the usages of the prefix *po-* that are traditionally called delimitative and distributive. The delimitative usage covers both the first and the third class of *po-*-prefixed verbs listed by Švedova (1982), and the distributive usage corresponds to the second type of outcome in the list above. The fourth usage (inceptive) is encountered when the prefix *po-* is attached to a motion verb; this usage is discussed in Zinova & Osswald 2016. As for the last usage from the list by Švedova (1982), I will show that it can be unified with the delimitative usage of *po-*. In sum, I will provide a unified underspecified semantics for the prefix *po-*.

4.5.1.1 Delimitative *po-*

Traditionally, the delimitative meaning of *po-* is associated with some characteristic of an event being lower than the expected value: for example, an event lasting for a short period of time, a small quantity of the theme consumed, etc. This

4 Semantics of individual prefixes

usage of *po-* is also called attenuative by some authors (e.g. Svenonius 2004b). According to Filip (2000: 47–48), who compares it with accumulative *na-*, “[t]he prefix *po-* contributes to the verb the opposite meaning of a small quantity or a low degree relative to some expectation value, which is comparable to vague quantifiers like *a little, a few* and vague measure expressions like *a (relatively) small quantity/piece/extent of*.”

Braginsky (2008: 183) applies a neat test in order to show the difference between the verbs prefixed with the resultative *za-* and the verbs prefixed with *po-*. The idea of this test is to continue the given sentence with ‘but it is hard to call it X’ where X is the result state corresponding to the derivational base. Such a continuation is only possible if there is no restriction on the degree reached on the relevant scale by the end of the event. Braginsky (2008: 183) provides two examples repeated as (53) and (54) here. What these examples show is that, indeed, when sentences are headed by the *po-*prefixed verb, the result state must not be reached, which is not the case with the *za-*prefixed resultative verbs.

- (53) a. Varen’je pogustelo^{PF}, no ego ešče trudno nazvat’ gustym.
Jam PO-thickened but it yet hard to call thick
‘The jam thickened a bit, but it is hard to define it as thick yet.’
b. *Varen’je zagustelo^{PF}, no ego ešče trudno nazvat’ gustym.
Jam ZA-thickened but it yet hard to call thick

= example (49) in Braginsky 2008: 183

- (54) a. Gvozd’ poržavel^{PF}, no ego ešče trudno nazvat’ ržavym.
Nail PO-became rusty but it yet hard to call rusty
‘The nail became a bit rusty, but it is hard to define it as rusty yet.’
b. *Gvozd’ zaržavel^{PF}, no ego ešče trudno nazvat’ ržavym.
Nail ZA-became rusty but it yet hard to call rusty

= example (50) in Braginsky 2008: 183

Součková (2004), analysing Czech prefixes, shows that *po-* can quantify over different dimensions: duration, distance, or degree of the property attained by the internal argument. Součková argues that despite the existence of different domains of quantification there is one single delimitative *po-* and its semantic contribution is sensitive to the content of the VP. This is true also for Russian and allows us to unify the first and the third usage listed by Švedova (1982): the unified semantic representation later combines with a scale provided either by the verb or by the direct object, leading to different relevant interpretations.

Examples of the delimitative usage of the prefix *po-* include such sentences as (55), taken from Filip (2000) and Součková (2004) and also used by Kagan (2015), whereby the sentence (55a) expresses that the walk around the city was short, and (55b) that the quantity of the apples eaten was relatively small.

- (55) a. Ivan poguljal po gorodu.
 Ivan po.walk.PST.SG.M around town
 ‘Ivan took a (short) walk around the town.’
 = example (9c) in Filip 2000
- b. Ivan poel jablok.
 Ivan po.eat.PST.SG.M apple.PL.GEN
 ‘Ivan ate some (not many) apples.’ = example (3) in Kagan 2015: 46

Although the observations about the low degree on some scale, associated with the discussed usage of the prefix *po-*, are commonly accepted and seem to be well established, the assumption that this degree has to be low in any case prevents us from accounting for some of the prefix usage cases one can find. As an illustration, let me provide some examples from the corpora.

- (56) a. Znat', mnogo po svetu pobrodil, vsjakogo raznogo
 know a lot on world po.wander.PST.SG.M all different
 uspel naslušat' sja- nasmotret' sja.
 have time na.hear.INF.refl na.look.INF.refl
 ‘You know, he wandered a lot around the world, he had time to see
 and hear all kinds of different things.’
 Marija Semenova. *Volkodav: Znamenie puti* (2003)
- b. Kogda do stolicy ostavalos' tridcat' kilometrov, našel
 when before capital stay.PST.SG.N.refl thirty kilometres found
 stolovuju i očen' plotno poel, poskol'ku do
 canteen and very full po.eat.PST.SG.M because before
 sledujuščego priëma pišči neizvestno skol'ko vremeni.
 next reception food unknown how much time
 ‘When I was about 30 km away from the capital, I found a canteen
 and had a very square meal, as I didn't know how long it would take
 until my next chance to eat something.’
 Anatolij Azol'skij. *Lopušok* (1998)

In (56a) the verb *pobrodil* ‘wandered’, that presumably contains the delimitative prefix *po-*, refers to a lot of wandering, and in (56b) the verb *poel* ‘he ate’ refers

4 Semantics of individual prefixes

to a situation of eating a lot. If the semantics of the delimitative prefix *po-* included the semantic component ‘the degree is lower than the expected value’, such sentences would be unacceptable or would trigger an additional pragmatic inference, i.e., be interpreted sarcastically. This is not the case: both (56a) and (56b) are unmarked. What is also important is that some verbs can also be used in combination with adverbials denoting a small quantity (such as *nemnogo* ‘a bit’), as in the examples (57).

- (57) a. On pobrodit nemnogo i sejšas že ujdet.
he po.wander.PRES.SG.3 a bit and now same u.GO.PRES.SG.3
‘He will wander around a little bit and immediately leave.’
Anna Berseneva. *Vozrast tret’ej ljubvi* (2005)
- b. My kupim ptičkam kormu i sami poedim
we buy.PRES.PL.1 birds food and ourselves po.eat.PRES.PL.1
nemnogo.
a bit
‘We will buy food for the birds and we’ll have a bite to eat ourselves.’
V. P. Kataev. *Bezdel’nik Èduard* (1920)

A possible solution would be to say that we are dealing with two different usages of *po-*: a delimitative in the examples (55a) and (55b) and some other in the examples (56a) and (56b), probably corresponding to the last, resultative, usage of *po-* in the list provided by Švedova (1982). This solution does not seem right to me: the verb *poel* ‘he ate’ in (55b) and the verb *poel* ‘he ate’ in (56b) seem to have the same meaning. If one consults dictionaries, one will find just one meaning of the verb *poest* ‘to eat’ that reflects the meaning of the verbs *poel* ‘he ate’ in the examples (55b) and (56b). This can be either ‘to eat not much’ (Ušakov 1935–1940) or ‘to eat’ (Efremova 2000). Further evidence in favour of the single meaning is that the verbal phrase in example (55b) can also be modified with an adverbial denoting sufficient quantity, as evidenced by example (58), taken from the corpora.

- (58) Togda on poel jablok vdovol’.
then he po.eat.PST.SG.M apple.PL.GEN enough
‘Then he ate apples to his heart’s content.’
Aleksandr Iličevskij. *Matiss* (2007)

So again I propose to apply the same technique as in the case of the cumulative *na-*. We can define the semantics of the delimitative usage⁸ of *po-* in such a way

⁸I will use the term *delimitative* to refer to this in order to differentiate it from the distributive and inchoative usages, but I will not imply attenuativity.

that the verb prefixed with it can either denote the unmarked completion of the event or include the semantic component ‘quantity/degree is lower than some expectation value’.

Kagan (2015: 48), following the analyses proposed by Filip (2000) and Součková (2004), proposes that “*po-* looks for a predicate that takes a degree, and individual and an event argument and imposes the ‘ \leq ’ relation between the degree argument and the contextually provided expectation value d_c .”

- (59) $[[po-]] = \lambda P \lambda d \lambda x \lambda e. [P(d)(x)(e) \wedge d \leq d_c]$
 where d = degree of change (Kennedy & Levin 2002)

This approach captures the semantics of the prefix in the examples discussed here as it includes the possibility that $d = d_c$ and thus both completion and delimitation can be expressed by the same prefix. What needs to be added here is some elaboration on discussion of the conditions under which the verb prefixed with *po-* tends to be interpreted delimitatively when used out of the context or in the neutral context.

Let me sketch how the pragmatic competition mechanism can be used in order to evoke such conditions. Consider sentence (55b). For this sentence, there are alternative ways of denoting a completed eating event, such as (60a). So if the speaker wants to describe an event of eating all of the apples, they can utter (60a). The most appropriate description of the situation of eating the apples until becoming full is (60b). Given this competition when sentence (55b) (that literally means that some apples were eaten) is uttered, it gets enriched with an additional inference that the quantity of the apples eaten is lower than the number of apples available and the amount of apples necessary for the actor to become full. I will provide some additional details on this kind of pragmatic competition in Chapter 5.

- (60) a. Ivan s”el jabloki.
 Ivan s.eat.PST.SG.M apple.PL.ACC
 ‘Ivan ate the apples.’
 b. Ivan naelsja jablok.
 Ivan na.eat.PST.SG.M.refl apple.PL.GEN
 ‘Ivan ate the apples until becoming full.’

From the proposed competition between different perfective verbs, it also follows that if *po-* is not the first prefix that is attached to the verb, it often tends to be interpreted as referring to a partial event because it competes with the perfective verb without the prefix *po-*.

4 Semantics of individual prefixes

4.5.1.2 Distributive *po-*

Another usage of *po-* we discuss in detail is the distributive (second meaning in the list taken from the grammar by Švedova 1982). The distributive interpretation of the prefix *po-* seems to be the least studied prefix usage among all the prefix usages that are classified as superlexical by those linguists that adopt the distinction. Tatevosov (2009), for example, identifies it as a left periphery prefix (the only one in this category) and suggests the reader to look in the other paper of the same author for discussion, but this paper is a 2009 manuscript and not available in any form. In the book by Kagan (2015) the distributive usage of *po-* is not discussed either.

What one can find are a few descriptive notes in Russian studies of verbal prefixation. For example, Isačenko (1960: 289–290) compares *po*-prefixed and *pere*-prefixed verbs with distributive semantics and concludes that distributive verbs containing the prefix *po-* “oboznačajut distributivnost’ dejstvija, no bez ottenka poočerednosti otdel’nyx aktov, svojstvennogo glagolam na pere-... Semantičeskaja raznica, odnako, očen’ tonkaja i nečetkaja” [denote the distributivity of the action, but without the semantics of the succession of the separate acts, that is characteristic for the verbs prefixed with *pere*-... The difference in the semantics between the classes of verbs is, however, very slight and fuzzy].

So for the moment let us assume that the distributive usage of the prefix *po-* can be characterised as ‘performing the action denoted by the derivational base with all of the objects or by all of the subjects specified in the sentence, without the individualisation of the subevents.’ We will compare the distributive usage of the prefix *po-* with the distributive usage of the prefix *pere-* in Section 4.6.

4.5.2 Restrictions on attachment

Let us start by considering the delimitative usage of the prefix *po-*. Tatevosov (2009) classifies the delimitative prefix *po-* as a selectionally limited prefix. As we have already discussed in Section 3.7.2, there are exceptions to this observation. For example, the verb *popriotkryt’* ‘to open very slightly’ in sentence (61) is derived by prefixing the perfective verb *priotkryt’* ‘to open slightly’ with the delimitative prefix *po-*.

- (61) A na ešelone on nemnožko čut’ popriotkryl
But at flight level he a little bit slightly po.pri.open.PST.SG.M
okoško.
window.SG.ACC

‘And at the flight level he just a little bit opened the window.’

= ex. (20) in Chapter 3

If one consults the list of usages of the prefix *po-* provided by Švedova (1982), one will find that the list of examples for the first usage contains verbs with two prefixes and no imperfective suffix, such as *poprivyknut* ‘to get somehow used’ and *poiznosit’sja* ‘to get somewhat worn out’.

A possible informal explanation of the observed facts is the following: the delimitative prefix *po-* normally cannot be attached to a perfective verb, because such a verb already denotes a completed⁹ event. The semantic contribution of the prefix *po-* is weaker than the semantic contribution of prefixes that demand the culmination of the event to correspond to the maximum on the scale or be higher than some expected value. Consequently, combining perfective verbs that contain such prefixes with the delimitative *po-* will not enrich their semantics. The only possible change is removing the completeness (reaching the maximum point on the scale) component from the source event semantics, but this is not possible if one accepts the Monotonicity Hypothesis (Kiparsky 1983).

Let us consider again example (19b) from Chapter 3, repeated here as (62) Tatevosov (2009). The verb *zapisat* ‘to write down/to record’ refers to a completed event of writing something down or recording. The relevant scale in this case is provided by the direct object, so the event is considered completed when the whole object is written down/recorded. If the verb *zapisat* ‘to write down/record’ could be combined with the delimitative prefix *po-*, the semantics of the derived verb would remain unchanged: the derivational base includes the information that the maximum point of the relevant scale has been reached whereas the prefix contributes the information that some point on the scale has been reached. In this case the attachment of the prefix violates the pragmatic principle introduced above, as it leads to a derivational chain in which two subsequent verbs have exactly the same semantics.¹⁰

- (62) Poèтому zapustil programmu, zapisyvajuščuju
 because of it za.let.PST.SG.M program.SG.ACC, za.write.PAP.SG.F.ACC
 dejstvija na èkrane, otkryl PSP, i nemnogo
 action.PL.ACC on screen.SG.PREP open.PST.SG.M PSP and a bit
 #po-zapisal (^{OK}po-zapisyval^{PF}), što i kak.
 #po.write.PST.SG.M (^{OK}po.write.impPST.SG.M) what and how
 ‘For this reason I ran the program that records the actions on the screen
 and recorded for some time, what was happening and how.’
 = ex. (63b) in Tatevosov 2009 and (19b) in Chapter 3

⁹“Completed” here means that the maximum point or the contextually determined standard point on the scale is reached. Punctual events can be considered a marginal case when the maximum and the minimum points are identical.

¹⁰This is the case when semantic representations would be literally the same, as the information contributed by the prefix is already contained in the semantics of the derivational base.

4 Semantics of individual prefixes

Why is the proposed preliminary semantic explanation preferable to the syntactic one? Exactly because, according to this explanation, there is no reason why the verb *popriotkryt* ‘to open very slightly’ could not exist. The semantic explanation why *po-* does not usually combine with perfective verbs hinges on the fact that most of them denote events such that the end point of the event corresponds to one fixed point on the scale. If a perfective verb denotes an event such that its end point is not bound to the maximum (or contextually determined standard) point on the scale, but can be any point from a range of points, then it should be possible to prefix it with the delimitative *po-*. The meaning of the resulting verb would be the intensified (which in our case means further limitation) meaning of the derivational base. This is exactly the case of (61).

Another example is provided in (63). In accordance with the intuition we are describing, the delimitative prefix *po-* is redundant when it is attached to a perfective verb, as its semantic contribution is already present in the semantic representation of the derivational base. This explains why such verbs are awkward without a good context that motivates the need to emphasise the low degree on the relevant scale. In (61), the usage of the verb is motivated by the speaker’s intention to report the actor’s idea that a tiny opening cannot harm. In the other example, (63), that we have already discussed in Chapter 3, it would be very harsh to use the frequent verb *podsoxnut* ‘to dry to some extent’ with respect to one’s brains, so the author of this comment chooses to soften the description by adding another delimitative prefix, *po-*.

- (63) Za sorok let despotizma mozgi popodsoxli.
after forty year.PL.GEN despotism brain.NOM po.pod.dry.PST.PL
‘During forty years of despotism his brain kind of dried up a bit.’
= ex. (22) in Chapter 3

Let us go back to the discussion of example (61). It turns out that there also exists a perfective verb *popriotkryvat*^{PF} ‘to slightly open multiple times’, that is formed with an additional imperfectivisation before the attachment of the prefix *po-*. This verb denotes multiple events of opening within a short time period.

Consider the examples (64) and (65). In (64) the verb *popriotkryvala*^{PF} ‘she slightly opened’ denotes a short series of occurrences of slight opening of the mouth, so the prefix *po-* temporally limits the series of openings. This series, in turn, is denoted by the derivational base *priotkryvat*^{IPF} ‘to open/be opening slightly’. In the example (65) the verb *popriotkryval*^{PF} ‘he slightly opened all of’ also refers to a series of opening events. The difference between (64) and (65) is that in the latter case each opening event takes place with a different object (all

the pots where there were no saplings to see), so according to descriptions of Russian prefixation this *po-* is not delimitative, but distributive.¹¹

- (64) Poprobovali dat' im krevetku, Oskar ne
 po.try.PST.PL give.INF they.DAT shrimp.SG.ACC Oskar.NOM not
 otreagiroval, a Matil'da nemnogo rot popriotkryvala^{PF},
 ot.react.PST.SG.M but Matilda a bit mouth po.pri.open.imp.PST.SG.F
 no tak i ne poela.
 but so and not po.eat.PST.SG.F
 'We have tried to give them a shrimp, Oskar didn't react at all and Matilda
 slightly opened her mouth several times but didn't eat it.'
<http://cherepahi.ru>

- (65) Daby izbežat' podobnogo, slegka popriotkryval^{PF}
 for iz.run.IMP similar.SG.M.GEN slightly po.pri.open.imp.PST.SG.M
 vatu vo vsech goršočkax, gde net vsxodov.
 cotton wool in all.PREP pot.PL.PREP where no sapling.PL.GEN
 'To avoid a similar situation, I slightly opened the cotton wool coverage
 on all the pots where there were no saplings to see.'
<http://ganja-forum.com>

In some cases it is not clear which meaning the prefix contributes. Even the number of the relevant noun does not always help. Consider example (66). It can be interpreted as a statement about the generation as a whole growing up a little bit and it can also mean that each person from this generation grew up. This example is useful to illustrate the intuition of Isačenko (1960) that there is no object-by-object iteration when the verb contains the distributive prefix *po-*.

- (66) ...a nynče ž – novoe pokolenie, kak-nikak,
 ...but nowadays well – new generation.SG.NOM, after all,
 popodroslo, a ono ž, èto pokolenie, – ogo-go!
 po.pod.grow.SG.PST.N, but it.NOM this generation.SG.NOM, – wow
 '...but now, after all, the new generation grew up a bit, and it is quite a
 generation!' <http://ergos-paragogis.livejournal.com/37099.html>

The conclusion one can arrive at after considering the examples above and in particular (66) is that the delimitative and the distributive meanings of *po-*, despite being very distinct at first sight, are instances of the same underlying semantic

¹¹One can say that the verb *popriotkryvala* 'she slightly opened multiple times' is distributive as well, if distribution over time is allowed.

4 Semantics of individual prefixes

representation. As we have seen, it is sometimes difficult to determine which of the two usages of prefixes we are looking at in any given example. This is an argument in favour of abandoning the hypothesis of a strict boundary between the delimitative *po-* and the distributive *po-*.

It turns out that the scalar approach to prefixation allows us to provide a single representation that can result in either interpretation depending on the type of scale selected to measure the event progress. As we have seen, a distributive interpretation occurs only in cases when there is a plural direct object that is interpreted definitely. This means that in the representation of this object there is an attribute such that its value can be used as the maximum point on the measure of change scale. (The minimum point on the measure of change scale is always 0.) The maximum and minimum points then become linked to the start and the end points of the event, respectively. This is interpreted as the event taking place until the action denoted by the verb has been applied to all of the members in the set denoted by the direct object. If the amount of the direct object is indefinite, no value that can serve as a maximum on the measure of change scale is available, so the end point of the event will correspond to an arbitrary point of this scale, leading (through an additional step of pragmatic strengthening) to the delimitative interpretation of the event. More details about the pragmatic level and the formal representation of the prefix will be provided together in Chapter 5 and Chapter 6.

4.5.3 Subsequent imperfectivisation of a verb with the discussed prefix

As the prefix *po-* in its distributive usage does not have any puzzling restrictions on its attachment, the intriguing part turns out to be located in the imperfectivisation domain. Švedova (1982: 365) notes that many of the verbs prefixed with the distributive *po-* are derived from perfective verbs (and at the same time are colloquial) and are synonymous with the verbs that are motivated by the imperfective counterparts of the derivational bases (some of these verbs are also colloquial, but their percentage is much lower), as in the pair *povybit*^{PF} – *povybivat*^{PF} ‘to knock out many/all of’.

For the account presented here, such data poses a certain challenge, i.e. it has to be explained why, e.g., in the pair *povybit*^{PF} – *povybivat*^{PF} ‘to knock out many/all of’ the second verb could not be derived from the first one or, if it could, why it is perfective despite the fact that adding the imperfective suffix is the last step of the derivation. I propose to take the first path and to explain why

imperfectivisation is not possible after attaching the distributive *po-* (or, adjusting to the merge of the two usages proposed above, why in the situation where attachment of the prefix *po-* leads to the distributive interpretation of the derived verb, this verb is not compatible with further imperfectivisation. It turns out that if the semantics of the imperfective suffix is added to the semantics of the verb prefixed with distributive *po-*, the semantics of the resultant verb is similar to that of an imperfective verb that is not prefixed with *po-*. For this reason, the derivation of a more complex form to express the same meaning is blocked.

To provide more details, let us consider the pair of verbs *povybežat*^{PF} – *povybegat*^{PF} ‘to run out’. The sentence (67a) illustrates the usage of the second verb in this pair. The first verb, formed from the perfective derivational base *vybežat* ‘to run out’, can also be used in the same sentence (the verb itself is colloquial) which is illustrated by (67b).

- (67) a. I povybegali^{PF} na ulicu, i stali smotret’ v
 and po.vy.run.PST.SG.M on street, and begin.PST.SG.M look.INF in
 zvězdoe nebo i slušat’ goluboj zvon.
 starry sky and listen.INF blue ringing
 ‘And they all ran out onto the street and started staring at the starry
 sky and listening to the blue ringing.’
 Sergej Kozlov. *Pravda, my budem vseгда?*
- b. I povybežali^{PF} na ulicu, i stali smotret’ v
 and po.vy.run.PST.SG.M on street, and begin.PST.SG.M look.INF in
 zvězdoe nebo i slušat’ goluboj zvon.
 starry sky and listen.INF blue ringing
 ‘And they all ran out onto the street and started staring at the starry
 sky and listening to the blue ringing.’

If it were possible to imperfectivise the verb *povybežat*^{PF} ‘to run out’ by suffixation, that secondary imperfective verb would have two interpretations: progressive and habitual. A progressive interpretation in the above context would mean that people are in the process of running out to the street. This meaning can be conveyed with the imperfective verb *vybegat*^{IPF} ‘to run/be running out’, as exemplified by (68) (the verb in the second clause has to be changed in order to satisfy discourse restrictions on the aspect of the verbs in the narrative sequence, see Section 2.1.5 for more details). The second possible interpretation of a potential imperfective verb formed by suffixing the verb *povybežat*^{PF} ‘to run out’ is habitual: each time after a certain other event, people run out onto the street and stare at the sky. This interpretation is also a possible interpretation of sentence

4 Semantics of individual prefixes

(68). So if we accept that there is competition between different verbs such that when the semantics of the two verbs is effectively the same,¹² only the verb that is morphologically simpler can be used, the absence of the secondary imperfective verbs derived from *po*-prefixed verbs with the distributive interpretation is expected.

- (68) I vybegali^{IPF} na ulicu, i načinali smotret' v zvezdnoe
 and vy.run.PST.SG.M on street and begin.PST.SG.M look.INF in starry
 nebo i slušat' goluboj zvon.
 sky and listen.INF blue ringing
 'And they were running out onto the street and starting to stare at the
 starry sky and to listen to the blue ringing.'

This explanation is valid in case the only meaning that is contributed by the prefix is distributive. Now let us explore what happens if there is a delimitative component in the semantic contribution of *po*-. Consider the verb *poest*^{IPF} 'to eat/to eat up', that we have already discussed. It can be suffixed with the imperfective suffix and yield the imperfective verb *poedaet*^{IPF} 'to eat up/be eating up'. Examples (69a) and (69b) show how the habitual and the progressive interpretations of this verb can be expressed. Note that it is the submeaning 'to eat up/destroy by eating' that is relevant in these contexts.

- (69) a. V dikoj prirode tak už zavedeno: milye i trogatel'nye
 in wild nature so well organised cute and touching
 zveruški poedajut drug druga.
 beast.dim.PL.NOM po.eat.imp.PRES.PL.3 friend.SG.NOM friend.SG.ACC
 'It is just like this in the wild: cute and touching animals eat each
 other up.' mixstuff.ru
- b. Ja sčitaju, što činovniki – èto takoe sugubo
 I consider.PRES.SG.1 that official.PL.NOM this such especially
 nadstroečnoe soslovie, kotoroe sejčas prosto
 superstructural estate that now simply
 poedaet stranu.
 po.eat.imp.PRES.SG.3 country.SG.ACC
 'I think that officials are just a superstructural estate, that now is
 simply eating up the country.'

Elena Semenova. *Oligarx bez galstuka* (2003)

¹² As I provide a compositional account, it cannot be exactly the same in this case as the representation of the derivational base gets updated after the prefixation with *po*-. The semantics being effectively the same means that when the formal representation is interpreted, there is no semantic difference between the two verbs.

Let us try to see why in this case the formation of the imperfective is not blocked. Consider sentences (70a) and (70b), obtained by replacing the verb *poedat*^{IPF} ‘to eat up/be eating up’ with the verb *est*^{IPF} ‘to eat’ in the sentences (69a) and (69b), respectively.

- (70) a. V dikoj prirode tak už zavedeno: milye i trogatel’nye
 in wild nature so well organised: cute and touching
 zveruški edjat drug druga.
 beast.dim.PL.NOM po.eat.imp.PRES.PL.3 friend.SG.NOM friend.SG.ACC
 ‘It is just like this in the wild nature: cute and touching animals eat each other.’
- b. ?Ja sčitaju, što činovniki – èto takoe sugubo
 I count.PRES.SG.1 that official.PL.NOM – this such especially
 nadstroečnoe soslovie, kotoroe sejčas prosto
 superstructural estate, that now simply
 est stranu.
 po.eat.imp.PRES.SG.3 country.SG.ACC
 ‘I think that officials are just a superstructural estate, that now is simply eating the country.’

The English translations of the sentence pairs (69a)/(70a) and (69b)/(70b) show that the meaning changes when the verb *poedat* ‘to eat up/be eating up’ is replaced by the verb *est* ‘to eat’. Sentence (70a) lacks the destruction meaning component and is naturally interpreted as referring to a situation of two animals sitting and chewing each others’ parts simultaneously. So the sentence (70a) can be uttered instead of (69a), but it does not convey the same meaning.

The difference between the sentences (69b) and (70b) is even bigger: while sentence (69b) has the meaning that the country is being destroyed and in the end will be destroyed (‘eaten up’) completely by the officials, sentence (70b) sounds strange, as the verb *est* ‘eats’ lacks the figurative meaning of destroying and is interpreted literally as officials nourishing on the country. It also lacks the component of the intention to eat the whole country. In sum, the verb *est* ‘to eat’ refers to a situation of eating literally, whereas the verb *poest* ‘to eat/to eat up’ can have both the literal and the figurative meaning and the verb *poedat* ‘to eat up/be eating up’ retains only the figurative part of the meaning. This is summarised in Table 4.1. For discussion of a similar phenomenon in English and Italian see Folli & Harley (2005).

The verb *popriotkryvat* ‘to open slightly’ provides another illustration of the same phenomenon. As we have seen, it can have both distributive and delimitative interpretations. The derivational chains in (71) show two ways in which

4 Semantics of individual prefixes

Table 4.1: Distribution of literal and figurative meanings of *est'* 'to eat' and its derivatives

	literal	figurative
IPF	<i>est'</i>	<i>poedat'</i>
PF	<i>poest'</i>	<i>poest'</i>

the verb *popriotkryvat'* 'to open slightly' can be derived, each of which leads to a different aspect and a different interpretation of the verb: if the prefix *po-* is attached in the last step of the derivation (chain (71a)), the derived verb denotes a series of slight opening events. If the imperfective suffix is attached in the last step of the derivation (chain (71b)), the derived verb is imperfective and denotes a set of very slight opening events.

- (71) a. *otkryt'*^{PF} → *priotkryt'*^{PF} → *priotkryvat'*^{IPF} →
to open to open slightly to (be) slightly open(ing)
popriotkryvat'^{PF}
to slightly open multiple times
- b. *otkryt'*^{PF} → *priotkryt'*^{PF} → *popriotkryt'*^{PF} →
to open to open slightly to open very slightly
popriotkryvat'^{IPF}
to (be) open(ing) very slightly

The imperfective aspect of the verb *popriotkryvat'* 'to open slightly' may be hard to access, but it is attested, as evidenced by example (72).

- (72) A *ešče pojavljaetsja prikol'naja, čisto pontovaja,*
but also *po.appear.PRES.SG.3.refl neat pure show off*
vozmožnost' poprikryvat' \ popriotkryvat' kryšku v ljuboju
possibility *po.pri.close.INF \ po.pri.open.INF lid in any*
moment.
moment
'And you also have the neat, purely exhibitionistic, ability to very slightly
close and open the lid at any moment.' www.chevrolet-cruze-club.ru

Let us now consider example (73) where the imperfective verb *popisyval* 'wrote' seems to be interpreted distributively. This sentence means that the actor wrote his articles without devoting much time to it, non-seriously. So the prefix in this case delimits the time spent during each writing session, but not the length of

the article: the sentence is interpreted in a way that the articles were probably completed and it is also possible that during each writing session a whole article was written. On the other hand, this does not have to be the case and can be explicitly denied, as is illustrated by (74). The holistic implication is also lost if the direct object is singular (75), as in this case occasional writing is only possible if the article is not completed.

- (73) V svobodnoe vremja on popisyval statji.
 in spare time he po.write.imp.PST.SG.M article.PL.ACC
 ‘In his spare time he wrote articles.’
- (74) V svobodnoe vremja on popisyval staji, no ni
 in spare time he po.write.imp.PST.SG.M article.PL.ACC but nor
 odnu ne zakončil.
 one not za.complete.PST.SG.M
 ‘In his spare time he wrote articles, but never finished any of them.’
- (75) V svobodnoe vremja on popisyval statju.
 in spare time he po.write.imp.PST.SG.M article.SG.ACC
 ‘In his spare time he was writing an article.’
- (76) V svobodnoe vremja on pisal statji.
 in spare time he write.PST.SG.M article.PL.ACC
 ‘In his spare time he wrote articles.’

This serves as evidence that the delimitative interpretation of the prefix *po-* only arises when the progression of the event is not related to the scale contributed by the direct object. The plural object creates the distributivity effect, which is also present in case of the non-prefixed verb: sentence (76) lacks the component of ‘non-serious occupation that does not take much time’, but still refers to the situation of multiple articles being written on multiple occasions.

4.5.4 Summary

I propose to provide a unified formal representation for the delimitative, resultative, and distributive usages of the prefix *po-*, thereby covering all the interpretations provided by Švedova (1982). The following observations are crucial for the construction of the desired semantic representation:

- *po-* can be attached to different scales; in the default case, the scale is one of the verbal scales; if an event denoted by the derivational base is an iteration, a *cardinality* scale provided by the direct object can be used as well;

4 Semantics of individual prefixes

- if the scale selected by *po-* is of type *cardinality*, then the start point of the event gets linked to the minimum point on the scale and the end point of the event gets linked to the maximum point on the scale; if the scale is a verbal scale, an arbitrary point on (the open end of) the scale is linked to the respective endpoint of the event;
- in case the endpoint of the event results in being linked to an arbitrary point of the scale, pragmatic strengthening can take place if there are other verbs capable of denoting events corresponding to some definite portions of the scale (for more details see Chapter 5).

4.6 *pere-*

4.6.1 Semantic contribution

The prefix *pere-* is notoriously polysemous. To start, we will consult Švedova (1982: pp. 363–364), who distinguishes the following ten meanings that the prefix may contribute to the semantics of the derived verb:

1. to direct the action denoted by the derivational base from one place to another through space or over another object: *perenesti* ‘to carry something over something’, *perebrošit* ‘to throw over’ (productive usage, some derivational bases are perfective);
2. place something between other objects or parts of other objects by performing an action denoted by the derivational base: *peresypat* ‘to pour something between something else’ (non-productive);
3. to perform the action denoted by the derivational base again or anew: *peredelat* ‘to redo’, *pereizbrat* ‘to reelect’, *pereproektirovat* ‘to redesign’, *pereoborudovat* ‘to reequip’ (productive usage, some derivational bases are perfective or biaspectual, some derived verbs are biaspectual);
4. to perform the action multiple times with different objects of the same kind or by different subjects: *pereglotat* ‘to swallow all of something one by one’, *perezarazit* ‘to infect all of’, *pereranit* ‘to wound all of’ (productive usage, some derivational bases are perfective or biaspectual);
5. to perform the action denoted by the derivational base with too much intensity or for too long a time: *peregret* ‘to overheat’ (productive);

6. to perform the action denoted by the derivational base intensively: *perepugat'* 'to scare a lot' (non-productive);
7. to overcome someone else, performing an action denoted by the derivational base: *peresporit'* 'to win the argument' (productive, derived verbs are obligatory transitive);
8. to perform the action denoted by the derivational base for a predefined time: *perezdat'* 'to pass the necessary time waiting' (productive in colloquial speech);
9. to stop the state, process or activity denoted by the derivational base after a long period: *perebolet'* 'to recover from illness' (productive);
10. a short, non-intense action, performed during a pause of another action: *perekurit'* 'to smoke, taking a break' (non-productive).

This is a detailed list of *pere-* usages, some of which can be merged. For example, Kagan (2015: 119–125) provides a unified account covering the following five different meanings of *pere-*:

1. 'to cross' (corresponds to the first usage in the list above, see example (77a));
 2. 'to redo' (corresponds to the third usage in the list above, see example (77b));
 3. excess (corresponds to the fifth usage in the list above, see example (77c));
 4. comparison (corresponds to the seventh usage in the list above, see example (77d));
 5. spending time (corresponds to the usages eight, nine, and ten in the list above, see example (77e));
- (77) a. Vasja pereplyl reku.
 Vasja pere.swim.PST.SG.M river.SG.ACC
 'Vasja swam across the river.'
- b. Vasja perepisal examen.
 Vasja pere.write.PST.SG.M exam.SG.ACC
 'Vasja rewrote the exam.'

4 Semantics of individual prefixes

- c. Vasja peregre^l sup.
 Vasja pere.warm.PST.SG.M soup.SG.ACC
 ‘Vasja overheated the soup.’
- d. Vasja pereigral Mašu.
 Vasja pere.play.PST.SG.M Masha.ACC
 ‘Vasja outplayed Masha.’
- e. Vasja pereždal dožd’.
 Vasja pere.wait.PST.SG.M rain.SG.ACC
 ‘Vasja waited for the rain to stop.’

Let me show how Kagan (2015) unifies different usages of the prefix *pere-*. For the base meaning, Kagan (2015: 120–121), following Janda (1988), takes the spatial interpretation ‘to cross’. Here is the characterisation that Kagan (2015: 121) gives for the underlying meaning of *pere-*: “[t]here is a certain spatial location, and the individual that undergoes motion moves through this location, eventually getting to ‘the other side.’” Based on this, Kagan (2015: 122) proposes that the “prefix imposes a relation of inclusion between two intervals on a scale”. This is formalised in (78), where d_s refers to the contextually provided standard degree.

- (78) $\llbracket pere- \rrbracket = \lambda P \lambda d_s \lambda d \lambda x \lambda e. [P(d)(x)(e) \wedge d_s \subseteq_U d]$
 where d = degree of change (Kennedy & Levin 2002) and \subseteq_U is defined as
 $\forall d \forall d' [d \supset d' \leftrightarrow (d \supset d' \wedge \max \{p : p \in d\} > \max \{p : p \in d'\})]$
 (from Kagan 2015: 123)

The formal semantics in (78) give rise to the spatial meaning of *pere-* when applied to the *path* scale. When the same is applied to the *time* scale, the meaning ‘to spend some particular time’ arises. So the event of swimming described in (77a) is terminated when the path covered in course of swimming includes the width of the (deep part of the) river. As for (77e), the time of the waiting event is determined by the time of the rain: the waiting started when the rain started (or shortly after) and the waiting stopped when the rain was over (or became insignificant).

4.6.1.1 Excessive and comparison usages

In order to derive meanings of excess and comparison, Kagan (2015: 133) additionally strengthens the representation in (78) by replacing the upper inclusion (\subseteq_U) relation with the proper upper inclusion (\subset_U). This is motivated by the fact that a sentence such as (77c) refers to a situation when Vasja heated the soup

more than the soup should be heated. (Note that (77c) cannot be uttered in a situation when Vasja heated (and thus immediately started to overheat) the soup that was already hot at the moment Vasja started to heat it.) Similarly, sentence (77d) refers to a situation where Vasja played better or longer than Masha, not equally good or long.

Two meanings are related to two different sources of scales. Consider the example (77d). The only scale that is present in the semantic representation of the verb *igrat* 'to play' is the time scale. If *pere-* is attached to it, we find ourselves in the *excess* situation: the verb *pereigrat* 'to play for too long' refers to exceeding the time of playing appropriate for the subject. Again, the verb *pereigrat* 'to play for too long' cannot refer to a situation where any time of playing would be too long (in other words, when the playing starts at the point that marks the appropriate time for the subject to play). Together with the verbs *poigrat* 'to play for some time' and *proigrat* (3 časa) 'to play continuously (for 3 hours)' the verb *pereigrat* 'to play for too long' covers the domain of possible time-related meanings the speaker may want to express with respect to the playing event.

To acquire the comparison meaning, the verb has to become transitive, as noted by Švedova (1982). The reason for this is that when it becomes transitive, the direct object becomes another, external, source of scales. The process of obtaining a scale may not be straightforward, though. An individual (e.g., *Masha* in example (77d)) is not a scale. So, in order to interpret the sentence, the scale has to be constructed. I propose to describe the scale construction process as proceeding along the following lines. First, one of the scales that are relevant in the situation described by the verb is picked (this can be playing quality or playing length in our example); second, one point that corresponds to the performance of the individual that is denoted by the direct object (how well or how long has Masha played) is marked on this scale. When this is done, the situation is no longer different from that of playing too much, where a point that represents the appropriate time of playing for the subject is marked on the time scale.

Before we proceed, I would like to make two observations that concern the comparison meaning and reveal some details about the structure of this meaning. First, note that verbs of comparison illustrated in (77) are only used in situations where the initial stage of the event favours the patient, not the actor (when they do not refer to the time scale). This means that for sentence (77d) to be true it has to not only be the case that Vasja ended up outplaying Masha, but also that when Vasja started to play he had a weaker position than Masha. If this is not the case and they simultaneously start to play without expectations who will be playing better, another verb, *obygrat* 'X to win from X' will be used, as in example (79).

4 Semantics of individual prefixes

- (79) Vasja obygral Mašu.
 Vasja ob.play.PST.SG.M Masha.ACC
 'Vasja won against Masha.'

Another illustrative pair of examples is given in (80) and (81), where the verb prefixed with *pere-* (*peregnat* 'to overtake') is used in the situation when the actor was located behind the patient (in the literal or metaphorical sense) at the beginning of the event, whereas the verb prefixed with *ob-*, *obognat* 'to overtake' lacks this requirement: sentence (81) can be used in a situation when the height of the trunks has been exactly the same all the time. If we try to modify the sentence, replacing the verb *obognat* 'to overtake' with the verb *peregnat* 'to overtake', the resulting sentence in (82) is suitable to use in a situation when the periods of the 'height leadership' of one trunk are followed by the periods of the 'height leadership' of the other.

- (80) Dognal, konečno, i peregnal, potom
 do.race.PST.SG.M of course and pere.race.PST.SG.M then
 sbavil skorost' i poravnjalsja.
 reduce.PST.SG.M speed and po.equal.PST.SG.M.refl
 'I caught up, of course, and overtook, then reduced speed and came along-
 side.'
 I. Grekova. *Na ispytanijax* (1967)
- (81) Ix korni s maloletstva splelis', ix stvoly
 their roots from childhood weave.PST.PL.refl their trunks
 tjanulis' vverx rjadom k svetu, starajas' obognat' drug
 stretch.PST.PL.refl up near to light trying ob.race.INF one
 druga.
 another
 'Their roots got woven together from their childhood, their trunks stretch-
 ed up to the sun, trying to overtake each other.'
 M. M. Prišvin. *Kladovaja solnca* (1945)
- (82) Ix korni s maloletstva splelis', ix stvoly
 their roots from childhood weave.PST.PL.refl their trunks
 tjanulis' vverx rjadom k svetu, starajas' peregnat' drug
 stretch.PST.PL.refl up near to light trying pere.race.INF one
 druga.
 another
 'Their roots got woven together from their childhood, their trunks stretch-
 ed up to the sun, trying to overtake each other.'

The second observation concerns with cases where the time scale is used for the comparison. Let us consider an example provided by Kagan (2015: 142) and repeated here in (83). Sentence (83) refers to a situation when the lifespans of Dima and Masha overlap and there is an interval following Dima's death when Masha is still alive. This sentence can be uttered also in case Masha and Dima are conjoined twins and were born simultaneously, as is illustrated by the example (84).

- (83) Maša perežila Dimu.
 Masha pere-lived Dima
 'Masha outlived Dima.' = example (50) in Kagan (2015)
- (84) V Londone umerli razdelennye siamskie bliznecy: odna sestra
 in London die.PST.PL separated conjoined twins: one sister
 perežila druguju na 4 nedeli.
 pere.live.PST.SG.F other on 4 weeks
 'In London, separated conjoined twins have died: one sister outlived the
 other for 4 weeks.' <http://newsru.com/arch/world/26dec2008/twins.html>

Examples (83) and (84) show that the only point on the scale that is taken from the information about the direct object is the date and time of death. The time when Dima was born does not matter for the truth conditions of (83). So only the point of Dima's death becomes the fixed point on the scale and the information conveyed by sentence (83) is that Masha started to live at some time before the death of Dima, lived at the moment of the death of Dima, and stopped living at some time after the death of Dima. This is exactly what Kagan (2015) considers this sentence to mean.

The difference between the approach I offer and that of Kagan (2015) is that Kagan (2015) operates with a time interval (corresponding to Dima's lifespan in the discussed example),¹³ whereas I propose to use only one point (that of Dima's death). The value on the scale has to change from some value below this point to some value above it in the course of the event. As follows both from the explanations provided by Kagan (2015) and from what we have just discussed, the information about the birth of Dima is of no importance for the interpretation of sentence (83). So the proposal of Kagan (2015) can be simplified by replacing the interval with the relevant point, as is done here. I will show how this works in Chapter 6.

¹³Kagan (2015: 143–144) has to deal with additional difficulties related to the elimination of the condition that Masha started to live not later than Dima. She proposes to use *an upper part* of the time interval of Dima's life.

4.6.1.2 Repetitive usage

Now let us discuss how the analysis proposed by Kagan (2015) can be extended to the repetitive usage of the prefix *pere-*, as this extension seems to be more tricky. Kagan (2015: 149) provides a number of valuable observations in this respect, arriving at the conclusion that “repetitive *pere-* is only possible with those predicates that contribute closed scales” such that “an increase along the same scale can be repeated”. She also emphasises the importance of the event and its iteration being connected to each other. Kagan (2015: 148) arrives at the following description of the important properties of the repetitive meaning of *pere-* (conditions (2) and (3) come together in the original proposal):

1. “An event that falls under the denotation of the VP (or brings about the same kind of result state) is presupposed to have taken place before event time.”
2. “The event predicate is interpreted as telic. Both the presupposed event and the entailed one are associated with a natural endpoint.”
3. “In the course of the presupposed event, this point [the natural endpoint] has been reached.”
4. “Typically, the entailed and the presupposed event are interrelated and can be conceptually unified.”

I agree with the second point about the telicity of the events and also with the last point about the two events being interrelated. We will discuss the first point in detail in the next chapter (Chapter 5).

As for the third point, there seems to be some confusion with respect to the identification of natural endpoints. Kagan (2015) provides example (85) to support her claim. She notices that (85) cannot be uttered in the situation when the dress was first washed, then worn, became dirty and was washed again. A possible scenario would be one where the dress was washed but did not become clean and thus it had to be washed again. In this case the first event of washing terminates but it does not reach the natural endpoint which corresponds to the clean state of the dress.

- (85) Lena perestirala plat'e.
Lena pere-washed dress
'Lena rewashed the dress.' = example (56) in Kagan (2015)

In fact it is even possible that the first washing was not complete: for example, the power could have gone off, the washing machine stopped without finishing its cycle and because of this the whole washing of the dress had to be redone. So it turns out that exactly the fact that the event did not reach the natural endpoint motivates why the whole process must be repeated.

Another example (86) describes a situation where a girl did not have a chance to finish the exam (which is the natural endpoint of writing it) because she was expelled. Nevertheless, a new attempt to pass the same exam can be referred to by either the perfective verb *peresdat'* 'to retake' or the imperfective verb *peres-davat'* 'to retake/be retaking'. This situation is not compatible with one of the conclusions of Kagan (2015).

- (86) Sud ne razrešil peresdat' EGE škol'nice, kotoruju
 court not allow.PST.SG.M pere.s.give.INF EGE schoolgirl.SG.DAT, that
 vygnali s èkzamina za spisyvanie.
 vy.chase.PST.PL from exam for cheating
 'The court did not allow the schoolgirl to retake the EGE exam she was
 expelled from for cheating.' <http://www.newsmsk.com/>

One more example to consider is provided in (87). The event of redoing the bed (changing the linen) does not require the bed to be done inappropriately. Sentence (87) can be used in the situation when Katja did the bed, someone slept in it, it became dirty and she changed it. What I consider crucial here is that Katja had to undo the bed before doing it again. This is revealed in comparison with sentence (88) where the verb prefixed with *po-* denotes an event of doing the bed but does not require the bed to be undone as a preparatory step for the main event.

- (87) Katja perestelila postel'.
 Katja pere.lay.PST.SG.F bed
 'Katja changed the bedlinen.'
- (88) Katja postelila postel'.
 Katja po.lay.PST.SG.F bed
 'Katja made the bed.'

I think that the semantics of the *pere-*prefixed verbs in examples (85), (86), and (87) can be unified by imposing a requirement for the preparatory phase of the event denoted by a *pere-*prefixed verb. The preparatory phase has to include the annulation of the result of the previous event. This can be represented as moving

4 Semantics of individual prefixes

from the point on the scale that has been reached earlier back to the start point. In the case of (85) an event of washing a dress after it has been washed and became dirty again is excluded due to the result of the washing being already annulled by the wearing of the dress. In case of the exam, the result of the previous attempt is annulled when the new attempt begins. If we are talking about redoing the bed, it still has bedlinen at the beginning of the redoing event and the fact it is dirty does not affect its presence. Thus we obtain the desired asymmetry between the examples (85) and (87). This approach also works in other cases discussed in Kagan 2015 with respect to the repetitive usage of the prefix *pere-*.

In sum, I propose to weaken the condition formulated by Kagan (2015) that the first event must reach the natural endpoint and make the last condition about the two events being interrelated more precise. This is done by introducing the preparatory phase that includes an event that proceeded along the same scale and had some final stage associated with a certain point on this scale. The transition from the preparatory phase to the main event then necessarily includes annulling the result of the preparatory event, as this corresponds to the transition to the minimum point of the scale (that is, in turn, the initial stage of the main event).

There is a certain flexibility with respect to the scale selection that leads to various possible interpretations of the same repetitive verb. For example, the verb *perešit* ‘to re sew’ often refers to changing a piece of clothing to fit the size of the other person without changing its kind, as in example (89a).

- (89) a. ona s udovol'stvijem perešila na devoček svoi svetlye,
 she with pleasure pere.sew.PST.SG.F on girls her light
 v melkij cvetoček, v venoček, v buketik
 in little flower.dim in wreath.dim in bouquet.of.flowers.dim
 plat'ja
 dresses
 ‘she took pleasure in resewing her light dresses with prints of little
 flowers, wreathes and bouquets for girls’
 Ljudmila Ulickaja. *Kazus Kukockogo* (2000)
- b. A barin-to byl v potěrtom pal'tiške,
 but barin-PARTICLE was in shabby coat.dim
 perešitom iz soldatskoj šineli
 pere.sew.PART.PST.SG.M.PRP from soldier greatcoat
 ‘And the barin himself was in a shabby coat re sewn from a military
 greatcoat’
 V. P. Kataev. *Almaznyj moj venec* (1975–1977)

It is also possible to utter the verb *perešit* ‘to re sew’ when a piece of clothing is transformed into another, as in example (89b), where the coat that comes into existence as a result of the re sewing event is no longer the greatcoat it used to be. This points to the fact that the scale is not necessarily bound to the type of object sewn in case of the verb *šit* ‘to sew’. In such cases, however, the mismatch has to be explicitly specified. E.g., it is not possible to understand sentence (89a) as an event after which some other clothes, not dresses, come into existence. If the type of clothing changes in the process of re sewing, the material used has to remain the same. This means that the scale of completeness associated with the sewn piece of clothing is also related to the material used in the sewing.

One more remark that I want to add before we proceed to the distributive usage of the prefix *pere-* is that the repetitive usage is more frequent and flexible than it may seem. Even if the attachment of the repetitive *pere-* seems impossible, as with the verb *napisat* ‘to write down’, it is occasionally produced by native speakers when they need to express the relevant meaning, as illustrated by (90).

- (90) Mog by kto-to perenapisat' ètu programmu, no tol'ko v si?
 can would someone pere.na.write.INF this program but only in C
 ‘Could someone reprogram this in C?’ www.cyberforum.ru

Usually the verb *perepisat* ‘to copy/rewrite’ can be used to refer to rewriting, but it means either copying or rewriting and correcting something that already exists. The semantics of the verb *perepisat* ‘to copy/rewrite’ includes limiting the activity denoted by the verb *pisat* ‘to write’ and relating it to another writing event that proceeds along the same scale. Now if we consider the attachment of the *pere-* prefix in its repetitive usage to the verb *napisat* ‘to write down’, the derived verb would be able to denote not only copying and rewriting something that turned out to be not good enough (for this, there is a morphologically simpler alternative – the verb *perepisat* ‘to copy/rewrite’), but also creating something written again. This meaning is derived from ‘to create something written’ interpretation of the verb *napisat*. This interpretation cannot be obtained by simply bounding the activity denoted by the verb *pisat* ‘to write’. Thus the verb *perepisat* ‘to copy/rewrite’ cannot be used in contexts like (90), where not only the writing per se has to be performed, but also the thinking and creating the structure of the code has to be redone to make the program function in the other language.

One more aspect that is related to the repetitive usage of the prefix *pere-* is the realisation of the requirement for the presence of a closed scale in the event structure. If *pere-* is attached to a perfective verb or to a secondary imperfective verb, this requirement is automatically satisfied. Complications occur when the

4 Semantics of individual prefixes

derivational base is a basic imperfective verb, such as *čítat* ‘to read’. As long as the derivational base refers to an unbounded event, the mechanism of constructing the repetitive meaning, described above, cannot be applied: there is no result state that can be annulled to license the repetitive interpretation as neither the final nor the initial stage of the event is defined. A way out in this case is to allow coercion that will select a scale using the context (e.g., a scale associated with the direct object) and map the beginning of the event onto the minimum point of this scale and the end of the event onto some other point on the same scale. (Note that a possible way to do this is to leave the scale underspecified by using a variable to identify it and provide the mapping that will be supplied with values later when the semantic representations of the arguments of the verb become available.)

4.6.1.3 Distributive usage

The last usage of the prefix *pere-* that we are going to explore is distributive. We have already discussed the distributive usage of the prefix *po-* in Section 4.5, so let us compare them, considering the examples (91a) and (91b).

- (91) a. Ira perečítala vse knigi v biblioteke.
Ira pere.read.PST.SG.F all books in library
‘Ira read all the books in the library.’
b. Ira počítala vse knigi v biblioteke.
Ira po.read.PST.SG.F all books in library
‘Ira read from all the books in the library.’

Two main differences can be spotted between the situations that the sentences (91a) and (91b) can refer to:

1. when the reading event is referred to by the verb *perečítat* ‘to read all of’, events of reading single books are clearly individualised;
2. (91a) denotes an event of reading all the books through, whereas (91b) is compatible with the situation of reading only certain portions of every book.

The first difference can be addressed by saying that the prefix *pere-* requires a proper cardinality scale as an input, whereas the prefix *po-* does not impose such a requirement. Let me explain this in more detail. A natural form of representation of plural individualised objects is a set. When we deal with a *po-*prefixed verb, we describe the event as happening with all the objects in this set by starting

the event when zero objects have been affected and ending when all the objects have been affected. This is achieved by using the measure of change scale on which the cardinality of the set corresponds to the maximum point but there is no mapping between the subsets of the objects and the intermediate points on the scale.

If we choose to describe the event using the *pere*-prefixed verb, such a structure is not sufficient and a proper scale that fixes not only the extreme points, but also all the intermediate points on the scale, is needed. It is important that the subevents do not overlap when the situation is described with the *pere*-prefixed verb. For example, if Misha had five balloons and made them burst one by one, both (92a) and (92b) can be used. If he was jumping on the balloons and each landing made some balloons burst (e.g., with his first jump he destroyed two balloons, then one, and then another two), then only description (92b) is suitable.

- (92) a. Miša perelopal vse šary.
 Miša pere.burst.PST.SG.M all ballon.PL.ACC
 ‘Misha bursted all the ballons (one by one).’
 b. Miša polopal vse šary.
 Miša po.burst.PST.SG.M all balloon.PL.ACC
 ‘Misha bursted all the ballons.’

The difference in the requirements of the *pere*- and *po*-prefixed verbs is also revealed when the direct object is a mass noun: in such a case, only *po*-prefixed verbs can be interpreted distributively, as (93a), and *pere*-prefixed verbs need to acquire some other interpretation, as in (93b), where the verb *peremërz* ‘he froze’ is interpreted excessively. I explain this by a lack of a mechanism that would extract a proper scale from a cumulative description.

- (93) a. Pomërzla kartoška-to u nas none, vsja
 po.freeze.PST.SG.F potato-PARTICLE at our now all
 pomërzla.
 po.freeze.PST.SG.F
 ‘Our potato plants got frozen now, all of them.’
V. G. Korolenko. *Čudnaja* (1880)
 b. Minuvšaja zima byla očen’ surovovj, i u mnogix urožaj
 last winter was very severe and at many harvest
 peremërz v ovoščexraniliščax.
 pere.freeze.PST.SG.M in vegetable.store
 ‘Last winter was very severe and many people lost their harvest in
 the vegetable stores as it was frozen.’ www.molsib.info

4 Semantics of individual prefixes

Another condition that has to be observed in order to obtain the distributive interpretation is that performing the action denoted by the derivational base with all the objects that are ordered to form a scale is only possible if every subevent (performing the action with a particular object) is somehow limited. (This is similar to what we have discussed with respect to the repetitive usage of the prefix *pere-*.) In other words, in order to map the whole event denoted by the distributive *pere-*prefixed verb onto the time scale and ensure that the subevents do not overlap, we need to know not only the order of subevents (determined according to the order acquired when a proper scale is constructed), but also the duration of each subevent. I propose to use the coercion mechanism in this case to delimit individual subevents if the derivational base is a simplex imperfective verb.

Another point that has to be mentioned with respect to the distributive usage of the prefix *pere-* is that it cannot arise when the prefix is attached to a perfective verb. This has been noticed by Tatevosov (2009), who identifies this usage of the prefix as selectionally limited. Indeed, when we try to attach the prefix *pere-* to a perfective verb, we obtain a verb with repetitive and not distributive interpretation: prefixing the verb *otkryt* 'to open' provides us with the verb *pereotkryt* 'to open again', prefixing the verb *zapisat* 'to write down/to record' leads to the verb *perezapisat* 'to write down anew/rerecord', but not 'to write down/record all of'. This naturally follows from the semantic structure of perfective verbs according to the view I propose.

Let us consider the verb *zapisat* 'to write down/to record'. In its semantic structure this verb carries information that the start of the writing event is related to the minimum point of the scale contributed by the direct object. The end of the event is related to the maximum point on the same scale. It is a scale of the measure of change type and the maximum of this scale is either the length of the direct object, if it is singular, or the number of objects, if the direct object is plural. What it cannot be is the length of one object belonging to the set denoted by the plural direct object. And if the distributive *pere-* was added to the verb, this is exactly what had to be denoted by the embedded event. This is easier to see by looking at the formal representations (see Chapter 5).

Another approach is offered by Demijanow (1997) who suggests that the distributive interpretation of the prefix *pere-* should share the prefix schema with the repetitive interpretation. This is motivated by the idea that verbs prefixed with the distributive *pere-* trigger presuppositions (similarly to the verbs prefixed with the repetitive *pere-*). As an example, Demijanow (1997) provides sentence (94) that she claims means that some of the candles were blown out.

- (94) On ne peretušil vse sveči.
 he not *pere*.blow.out.PST.SG.M all candles
 ‘He did not blow out all the candles.’

= example (153) in Demjjanow 1997: 120

Here I only want show that it is not required that any part of the action denoted by the distributive *pere*-prefixed verb was performed if such verb is uttered under negation. The presuppositional view on the repetitive usage of the prefix *pere*- will be discussed in Chapter 5. Indeed, the most natural interpretation of (95) is that the editor (Panferov) did not look through any part of the manuscript.

- (95) Pridja v redakciju “Oktjabrja”, Juz položil pered
 come.PART in editorial office Oktjabr’.GEN Juz po.lay.PST.SG.M in front
 Panferovym tolstuju rukopis’, i tot, daže ne
 Panferov.INST thick manuscript and that even not
 perelistav, napisal na nej: “V nabor”.
pere.thumb.PART.PST, na.write.PST.SG.M on she.PRP in print

When Juz came to the editorial office of Oktjabr’ and laid a thick manuscript in front of Panferov, Panferov, without even thumbing through it, wrote on it: “Publish.” Samuil Alešin. *Vstreči na grešnoj zemle* (2001)

4.6.2 Restrictions on attachment

I claim that all the usages discussed above except for the repetitive one (but including the distributive), can be unified using the idea that *pere-* can be only attached to a scale that is closed and non-binary. In other words, the scale that *pere-* selects for must contain at least three distinct points. Along with this strong requirement (in comparison with other prefixes) there are several ways to construct an appropriate scale and this explains the polysemous nature of the prefix.

Let the two extreme points on the scale s that is provided as an input for the prefixation with *pere-* be x and z and the set Y be the set of all intermediate points y such that $\forall y \in Y : x < y < z$. All the intermediate points must be ordered as well. The prefix requires that Y is not empty. This corresponds to a Complex type in terms of Beavers 2012 (44c).¹⁴ I propose the following general procedure for acquiring a scale that *pere-* can attach to.

¹⁴In earlier work, Beavers 2002 and Beavers 2008, the notion of Non-Minimally Complex Object is used.

4 Semantics of individual prefixes

1. If the direct object provides a closed scale that is non-binary, x is the minimum of this scale, z is the maximum and Y is the set of all the intermediate points.¹⁵
2. If the direct object (possibly in combination with the context) provides a single point on some scale, this point becomes a member of the set Y . The points x and z are chosen arbitrarily in such a way that they are located below and above the marked point on the scale, respectively.
3. If the direct object denotes a set, the scale is constructed by arranging the equivalence classes corresponding to the gradually increasing number of objects: x is 0, z is the cardinality of the set, and Y contains points that represent subevents related to the subsets consisting of a whole number of objects in the set (the first point in Y is an equivalence class of all single objects in the set, the second point is the equivalence class of all pairs of objects, the third point is the equivalence class of all triplets, etc.).

This scale selection is motivated by the idea that when *pere-* is attached to a verb, the action denoted by that verb has to be performed at all the intermediate points on the relevant scale and each point on that scale has to correspond to some subevent. If the scale is dense (first case described above), as with *time* and *path* scales, this will mean performing the action while moving along the scale. If the scale is discrete (third case), as with the *cardinality* type of scales, the verb prefixed with *pere-* acquires a distributive interpretation.

The attachment of *pere-* results in the following types of mappings: if Y contains multiple points, the event consists of the iteration of the event denoted by the derivational base for each point on the scale until the point z is reached. Each individual event is measured according to the measure of change scale of the corresponding element.

If Y contains a single point or an infinite number of points, the event proceeds along the scale s from x to z through all the points in Y . This mapping can be unified with the previous one (for multiple points) if the continuous movement along the scale is represented as an iterated movement through the infinite number of points on the closed scale. I do not think that this is computationally reasonable and prefer to have two separate representations for the implementation.

The process of scale selection I propose does not rely on the semantics of the verbal roots and it is even independent of the scale dimension. For example, usually those verbs that lexicalise *path* and *time* scales acquire the crossing semantics

¹⁵Note that extracting a *path* scale from the direct object that refers to some landmark is also a complex process, as the *path* scale is not present in the semantic structure of the object, but has to be constructed taking into account the position of the subject.

that relies on traversing all the points on the scale (related to the scale of the type 1 in the list above). But they can also acquire the interpretation using the same mechanism as is used for the excess meaning (second procedure in the list above). This happens when the direct object denotes something that is conceptualised as having point-like width or point-like duration. In the case of point-like width, unlike the case of non point-like width, the crossing event has to start in front of the crossed object and end behind it and not on its border.

For example, the phrase (96a) cannot be uttered in a situation when someone steps over the puddle on their way. The actor has to step into the puddle at least once and at the same time it is enough that the actor crosses the puddle with the last step on the border of the puddle and not outside it. If the crossed object is conceptualised as being point-like, then the event necessarily starts and ends on the different sides of the object: in this case, stepping over the same puddle can be described by (96b) and the end point of the motion cannot be in the puddle.

- (96) a. perejti lužu
 pere.go.INF puddle
 ‘to cross the puddle’
 b. perešagnut’ lužu
 pere.step.INF puddle
 ‘to step over the puddle’

This approach accounts for the ambiguity allowed in the analysis of Kagan (2015) by the absence of the proper upper inclusion constraint: verbs that acquire *path*- and *time*-related semantics denote events with a measure that is either equal to or exceeds the measure contributed by the direct object. The analysis I offer here allows us disentangling these possibilities while maintaining the idea of the underlying uniform semantics of the prefix.

The other two usages, that of excess and comparison, are related to the scale constructed according to the second procedure in the list above. These usages are also guided by the same idea of proceeding through some values on the scale. In these cases, only the marked point is important and it is the only point through which the event has to proceed. The event starts when the value on the scale is below the marked point, proceeds through this point and ends when the value on the scale is above it. This accounts for examples such as (77c), (77d), and (83).

The case of the repetitive meaning of the prefix (‘again’) is not unified naturally with the other cases. First, it is the only case where a separate preparatory phase has to be created. Second, it is widely available, often simultaneously with other interpretations, and such *pere*-prefixed verbs seem to be disambiguated only by

4 Semantics of individual prefixes

the context. So despite the fact that the repetitive meaning has received a unified account with the other interpretations of the prefix *pere-* in some earlier works (Demjjanow 1997; Kagan 2015), I will set it aside.

The approach presented here allows us to treat most of the differences between the different uses of *pere-* as a matter of scale selection. An important property of such an approach is that various meanings arise as a result of different properties of the scales lexicalised by verbs or contributed by the direct objects. So this formalises the intuition that the particular meaning of *pere-*prefixed verb can only be determined in the context (and the direct object plays a crucial role).

As we have seen, the prefix *pere-* is both very demanding and very flexible: in order to be attached, it requires a closed not-two point scale on which all the intermediate points can be mapped onto sub-events, but there are various mechanisms that can be used to obtain this scale. Moreover, it does not impose any restrictions on the dimension of the scale: as Kagan (2015: 151) summarises, *pere-* can apply to “all scale dimensions that are familiar from the literature on verbal domain”. So depending on the type of the scale available, one or several interpretations are possible for the verbs derived through the attachment of the prefix *pere-* to any derivational base. I will provide various examples in Chapter 6.

4.6.3 Subsequent imperfectivisation of a verb with the discussed prefix

Secondary imperfective formation is possible with all the usages of the prefix *pere-*: crossing, waiting, excess, comparison, distributive, and repetitive semantics.

Examples (97a) and (97b) illustrate the usage of the secondary imperfective verbs *perebegat*^{IPF} ‘to run/be running across’ and *pereplěvyvat*^{IPF} ‘to spit/be spitting over something’ formed from the *pere-*prefixed verbs *perebežat*^{PF} ‘to run across’ (see Section 2.3.6 for more details about why I consider the verb *perebegat*^{IPF} ‘to run/be running across’ to not be derived from the verb *begat*^{IPF} ‘to run’ via prefixation) and *perepljunut*^{PF} ‘to spit over something’. This provides evidence for the existence of the secondary imperfective verbs derived from *pere-*prefixed verbs with crossing semantics.

- (97) a. I ot každoj pary valenok, kto v lagere gde šěl
and from each pair felt boots who in camp where go.PST.SG.M
ili perebegal, – skrip.
or pere.run.PST.SG.M creak
‘And each pair of boots when someone in the colony went or ran
somewhere produced a creak.’

Aleksandr Solženicyn. *Odin den’ Ivana Denisoviča* (1961)

- b. Byl skup na slova. Ele pereplěvyval čerez
 be.PST.SG.M stingy on words barely pere.spit.imp.PST.SG.M over
 vyvoročennye guby.
 vy.turned lips
 ‘He was stingy with his words. Barely spat them over his everted
 lips.’ R. B. Gul’. *Azef* (1958)

Sentences (98), (99), (100), and (102) serve as evidence for the existence of secondary imperfectives formed from *pere*-prefixed verbs with waiting (*pereždat* ‘to pass time waiting for something to end’ → *perežidat* ‘to pass/be passing time waiting for something to end’), excess (*peregret* ‘to overheat’ → *peregrevat* ‘to overheat/be overheating’), comparison (*perepljunut*^{’PF} ‘to surpass’ → *pereplěvyvat*^{’PF} ‘to surpass/be surpassing’), distributive (*perepisat*^{’PF} ‘to list all of’ → *perepisyvav*^{’PF} ‘to be listing all of’), and repetitive (*perepisat* ‘to rewrite’ → *perepisyvav* ‘to rewrite/be rewriting’) semantics, respectively.

- (98) Pravda, na zimu ona ostanavlivaetsja v roste, no ne
 truth on winter she stop.PRES.SG.3.refl in growth but not
 obrazuet nastojaščix poček, a liš’ perežidaet
 form.PRES.SG.3 real burgeon but only pere.wait.imp.PRES.SG.3
 zimnee poxolodanie.
 winter cooling
 ‘It does, in fact, stop to grow for the winter time, but does not form real
 burgeons, it only waits for the cool winter period to pass.’
 Ju. N. Karpun. *Priroda rajona Soči* (1997)
- (99) Inogda na rynke popadaetsja židkij mēd, kotoryj
 sometimes on market po.fall.PRES.SG.3.refl liquid honey that
 prodavcy special’no peregrevajut, čtoby ostanovit’
 seller.PL.NOM intentionally pere.heat.imp.PRES.PL.3 that stop.INF
 broženie.
 fermentation
 ‘Sometimes liquid honey can be found on the market; it is overheated by
 the sellers on purpose to stop fermentation processes.’
 Vladimir Ščerbakov. “*Pravil’nyj*” *mēd* (2002)
- (100) Da už, puskaj lučše v vese i roste nas
 yes well let better in weight and height us
 mal’čiki-sentjabriki pereplěvyvajut.
 boys-september.ik.PL.NOM pere.spit.PRES.PL.3
 ‘Oh well, I’d better let those September-born boys overtake us in weight
 and height.’ Naši deti: Malyši do goda (forum) (2004)

4 Semantics of individual prefixes

- (101) Kogda inspektor Mykomel' perepisyval vsex
 when inspector.SG.NOM Mukomel pere.write.imp.PST.SG.M all.ACC
 passažirov, ona nazvalas' Melodiej Dz'ujn.
 passenger.PL.GEN she na.name.PST.SG.F.refl Melody Dzujn
 'When Inspector Mukomel was writing down the list of all the passen-
 gers, she named herself Melody Dzujn.'
 Vadim Rossik. *Tëmnyj čelovek* (2015)
- (102) Vmesto togo čtoby každyj raz perepisyvat' istoriju,
 instead that that each time pere.write.imp.INF history.SG.ACC
 razumnee prinjat' eë takoj, kakoj ona vyjasnjaetsja
 rational.COMP accept her that as she vy.clear.PRES.SG.3.refl
 sama.
 herself
 'Instead of rewriting history each time, it is more rational to accept it as
 it turns out to be.' Èduard Limonov. *U nas byla Velikaja Èpoxa* (1987)

4.6.4 Summary

As has been shown by Kagan (2015), various usages of *pere-* that seem to be unrelated at first sight can be unified under a scalar account for prefixation. We have gone somewhat further and shown that some of the differences between the usages that are present in the account by Kagan (2015) can be motivated by the properties of the input scale. The available scales may be provided by the direct object, world knowledge, context, or the verb itself. I have proposed a mechanism that uses scales of various types as input and (depending on the properties of a concrete scale) provides a scale as its output, which is suitable as an input to prefixation by *pere-*. One of the interpretations of the prefix that arises as a result of applying the proposed system is the distributive usage of *pere-*, that has previously not been unified with other interpretations. The scale selection process that leads to various interpretations of the prefix ends up being motivated by the requirement that the prefix has to receive a non-binary scale as its input. The notorious polysemy of the prefix *pere-* arises due to the availability of different ways to satisfy this requirement.

On the other hand, I have decided to exclude the repetitive interpretation of the prefix *pere-* from being integrated in the system described above. At the moment, I do not see a natural way of unifying the repetitive meaning of the prefix with the other interpretations, as it has several distinctive properties. First, it includes a preparatory phase (presupposition on the accounts of Demjjanow 1997, Kagan

2015, more details in Chapter 5), that is not present in other usages. Second, it is compatible with a binary scale as an input for prefixation. Third, the attachment of the repetitive *pere-* to a non-basic imperfective or biaspectual verb does not lead to a change of aspect (see Section 2.3 for more details). These facts allow us to treat the repetitive prefix *pere-* and the prefix *pere-* that may acquire all the other meanings described here as homonyms. This hypothesis, however, requires further scrutiny.

Despite all the work towards the unification of the usages of *pere-*, for the computational analysis I propose to allow three different representations, which account for the various mapping types required by different scales. Remember, this mapping is always motivated by the idea of performing the action denoted by the derivational base at all the intermediate points of the scale.

The basic representation should account for spatial ('crossing'), time ('waiting'), and distributive usages in cases of closed scales. In these, the prefix establishes the mapping between all the points on the scale and distinct event stages. The second representation accounts for cases where there is only one marked point on the relevant scale. In this case the event proceeds from some point below the marked point through this point to the point above it. The last representation is needed for the repetitive usage: it takes the event denoted by the source verb, creates a copy of it, and constructs a new event (from the copy) that has the old one as the preparatory phase.

4.7 *do-*

4.7.1 Semantic contribution

Let us again start by looking up the characterisations of the verbs derived with the prefix in question (now *do-*) in the grammar by Švedova (1982: 357–358). Three possible interpretations of the derived verbs are listed there:

1. to perform the action denoted by the derivational base until the end or until some limit (productive type): *dovarit'* 'to finish cooking';
2. to perform the action denoted by the derivational base in addition to something, or in order to reach a certain norm (productive type): *doplatit'* 'to pay in addition';
3. to lead to an undesirable condition by performing the action denoted by the derivational base (productive in colloquial speech): *dolečit'* 'to cure incorrectly, causing a serious illness'.

4 Semantics of individual prefixes

As we see, *do-* is not a highly polysemous prefix. Nevertheless, *do-* is very interesting concerning phenomena of prefix stacking, as it is very productive and can lead to the formation of biaspectual verbs, as we have discussed in Section 2.1.

Kagan (2015: 70) characterises the prefix *do-* as relating “the standard of comparison to the degree that is achieved at the endpoint of an event”. She identifies this prefix as delimitative and distinguishes between the terminative and additive usages. The terminative usage corresponds to the first and the additive usage corresponds to the second usage in the list by Švedova (1982) provided above. My primary goal is to study the terminative usage. Kagan (2015: 72) describes the semantics of the terminative usage of the prefix *do-* in the following way: “The prefix introduces the relation of identity between two degrees. It applies to a gradable property an increase along which is entailed by the predicate.”

A simple illustration is provided by (103). The verb *varit*^{1PF} ‘to cook’ lexicalises a scale with the maximum point corresponding to *fully cooked* and the prefix *do-* contributes information that at the end of the event this point is reached.

- (103) Liza dovarila sup.
Liza do.cook.PST.SG.F soup
‘Liza finished cooking the soup.’

What is important is that (103) normally refers to an event of cooking the soup that does not start not from scratch. It may be the case that the soup was almost ready but Liza had to pause cooking and answer a phone call before finishing cooking. It can also be the case that John was cooking the soup, considered it cooked, and left it for Liza. Liza came later, tasted the soup and realised it is not ready, and then had to do some additional cooking to make the soup edible. The second interpretation corresponds to the additive usage of the prefix. However, it does not represent a special case different from the first usage in terms of scalar semantics: in both cases, the event that the *do-*prefixed verb refers to proceeds along the relevant scale from some point *x* until the scale’s maximum. The difference between the prefix *do-* and other prefixes is that *x* does not have to be the minimum point on the relevant scale. It can also be the case that there is no minimum point on the relevant scale at all. For example, the event of heating the soup proceeds along the temperature scale and the start of the event is associated with some temperature of the soup that cannot be easily reconstructed, but is definitely not equal to the minimum of the scale. From the fact that a sentence such as (104) normally refers to the whole event of heating the soup up to the

boiling point it follows that the condition I have formulated above seems to work well. A stronger requirement (for the presence of another event associated with the temperature increase) would be superfluous.

- (104) Liza dovela sup do kipenija.
 Liza do.lead.PST.SG.F soup until boiling
 ‘Liza made the soup boil.’

Kagan (2015: 75) claims that the semantics of the terminative *do-* “can be divided into an entailed and a presupposed part”. The observation provided above seems to speak against such an additional inference associated with the prefix *do-*. The sentence (105) can be successfully uttered in a situation when Liza did not heat the soup at all. We will discuss this topic further in Chapter 5.

- (105) Liza ne dovela sup do kipenija.
 Liza not do.lead.PST.SG.F soup until boiling
 ‘Liza did not make the soup boil.’

Although additive *do-* is not in the focus of this book, I would like to add some remarks about it, as these remarks contribute to the overall picture of pragmatic competition between different prefixes. Kagan (2015: 79) points out that the main difference between the terminative and the additive interpretations is that in the first case the presupposed and the entailed events are viewed as constituting one event and in the second case they are viewed as two separate events. What usually comes along with this distinction is that in the first case the degree on the measure of change scale that has to be reached in the end is specified. In the second case the measure of change of the second event is linguistically supplied, whereas the cumulative standard that has to be reached in the end can be left implicit. Kagan (2015: 79) provides the examples repeated in (106) to illustrate the differences between these usages.

- (106) a. (Ivan *lög pospat*’..) On *dospal do polunoči*.
 Ivan lay po-sleep he do-slept till midnight
 ‘Ivan went to bed. He slept till midnight.’
 b. (Ivan *za noč ne vyspalsja*.) Potom on *dospal paru časov*.
 Ivan in night NEG vy-slept-refl then he do-slept couple hours
 ‘Ivan hadn’t had enough sleep during the night. He then slept for a
 couple more hours.’ = (12) in Kagan (2015: 79)

4 Semantics of individual prefixes

In the first case (example (106a), terminative usage) there is a single event of sleeping that lasts until midnight.¹⁶ In the second case, there was one sleeping event that proved to be insufficient so there was a second event in the course of which Ivan slept for several hours and thus cumulatively over two events reached the required amount of sleep.

As Kagan (2015: 80) points out, in case of the additive usage of the prefix *do-* the first event can be of a different kind, as illustrated by example (107) that describes a situation when additional payment has to be made not after another payment, but after giving away empty bottles.

- (107) Kupili džužinu butylok fruktovoj vody, a v obmen sdali
 bought dozen bottles fruit water, but in exchange s.give.PST.PL
 8 pustyx butylok. Skol'ko deneg doplatili?
 8 empty bottles how.much money do.pay.PST.PL
 'We bought a dozen bottles of fruit water and handed back 8 empty bottles. How much money did we have to pay in addition?' vceve.ru

Another example is provided in (108). Sentence (108) does not exclude that the speaker never bought raisins, dried apricots, and/or plums before or that he had ever possessed any. It only implies that he needed them in order to make stewed fruit. What the verb *dokupit*^{PF} 'to buy in addition' means in this case is that he bought the dried fruits but this was not the first step in gathering the ingredients for something he wanted to cook. The "scale" in this case includes possession of the necessary amount of raisins, dried apples, apricots, and plums.

- (108) Mne test' vydal sušěnyx jablok s dači, ja
 me father-in-law vy.give.PST.SG.M dried apples from dacha I
 dokupil izjuma, kuragi, černosliva i teper'
 do.buy.PST.SG.M raisins dried apricots dried plums and now
 reguljarno vspominaju detstvo – varju kompot iz
 regularly remember childhood cook stewed fruit from

¹⁶Note that as the first (bracketed) sentence refers only to the initiation of the sleeping situation and does not even require the agent to fall asleep. This is clear from that fact that it is possible to cancel the inference that Ivan slept, as in (i).

- (i) Ivan lěg pospat'. On proležal 3 časa, no tak i ne smog
 Ivan lay po.sleep.INF he pro.lay.PST.SG.M 3 hours, but so and not able.PST.SG.M
 usnut'.
 fall.asleep.INF
 'Ivan went to bed. He stayed in bed for 3 hours but did not manage to fall asleep.'

suxofruktov.
dried fruits

‘My father-in-law gave me some dried apples from his dacha, I also bought raisins, dried apricots and plums and now I regularly invoke childhood memories by making myself some stewed dried fruit.’

<https://murmolka.com>

Based on these observations, I propose that the inference of the event being an addition to something else is drawn in the process of the pragmatic competition between the *do-*prefixed verb and other perfective verbs that can express the same literal meaning (in case of the example (108) it would be the verb *kupit*^{PF} ‘to buy’). The competition is triggered by the absence of the requirement that the starting point of the event has to be the minimum on the relevant scale in the semantic representation of the prefix *do-* (unless it is overtly specified, as in (109), or the scale is of a measure of change type, as in (110)). A broader pragmatic picture will be provided in the next chapter.

- (109) Za šest’ časov možno doletet’ iz N’ju-Jorka do San-Francisko.
behind six hours can do.fly.INF from New York to San Francisco.
‘In six hours one can get from New York to San Francisco by plane.’

Boris Levin. *Inorodnoe telo* (1965–1994)

- (110) A na poljax nota bene – takoj-to ne doplatil tri
but on margins nota bene such-PARTICLE not do.pay.PST.SG.M three
kopejki, vozместit togda-to...
copecks, compensate.PRES.SG.3 then-PARTICLE
‘And on the margins there is a note: he failed to pay 3 copecks, which he will compensate for on day Y.’

Jurij Davydov. *Sinie tjul’pany* (1988–1989)

4.7.2 Restrictions on attachment

Kagan (2012: 236) points out that the prefix *do-* in its terminative interpretation can apply to a variety of scales. Let me first illustrate this thesis with a poem by Ekaterina Starostina called *Dočuvstvovat’* ‘To finish feeling’. This poem contains 13 *do-*prefixed verbs in 12 lines (they are marked with bold font), and in 4 verbs *do-* is not the only prefix.

4 Semantics of individual prefixes

- (111) a. ...**Dočuvstvovat'**. **Dooščuščat'**.
do.feel.INF do.sense.INF
Dotronut'sja ili kosnut'sja...
do.touch.INF.refl or touch.INF.refl
Dobyť tebja, **docelovat'**...
do.be.INF you do.kiss.INF
...i polnym serdcem ulybnut'sja...
and full heart smile.INF.refl
To finish feeling. To finish sensing.
To touch you slightly...
To get you and finish kissing
...and smile with a full heart...
- b. **Dogladit'** pal'cy na rukax...
do.caress.INF fingers on hands
Domnožit' sčast'e v našix dušax.
do.multiply.INF happiness in our souls
Doperežit', **dopereždat'**...
do.pere.live.INF, do.pere.wait.INF
Dorazobrat' vsě to, čto nužno...
do.raz.take.INF all that that needed
To finish caressing the fingers...
To multiply the joy in our souls.
To live, to wait till the end of our lives...
To disassemble all we need...
- c. **Dorazukrašivat'** mečty,
do.raz.u.paint.imp.INF dreams
Dobit'sja srazu: vsě i mnogo...
do.hit.INF.refl at once all and a lot
I dobrym utrom do poroga
and kind morning until doorstep
Čut' zabludivšejsja **dojti**...
slightly za.wander.PART.ACT.PST.refl do.go.INF
To finish colouring my dreams,
To get at once all that I wanted...
And one fine morning, having slightly strayed
To reach the doorstep...
Ekaterina Starostina, *Dočuvstvovat'* (www.stihi.ru)

In this poem the prefix *do-* is attached to a scale of stages through which the event develops (e.g., *dočuvstvovat* ‘to finish feeling’, (111a)), to a path scale (e.g., *dojti* ‘to get to’, (111c)), as well as to the time scale that either derives directly from the semantic structure of the verb (e.g., *doočuščit* ‘to finish sensing’, (111a)) or is already used in course of the attachment of another prefix (e.g., *doperežit* ‘to survive something’, (111b)). Kagan (2015) proposes the following hierarchy of sources for a scale the prefix *do-* can attach to:

- “If the verbal stem lexicalizes a scale, it is to this scale that *do-* will apply.”
- “If the verb itself does not contribute a scale, but it is an incremental theme verb, then the prefix will apply to the scale introduced by the direct object (a volume/extent scale).”
- “If none of these conditions is satisfied, the prefix can apply to the time scale.”

Kagan (2012) also notes that *do-* can apply to both upper closed and open scales, but “[i]f *do-* applies to a scale that is not upper closed, and a *do*-PP is absent, the context has to be sufficiently rich to determine what counts as the standard of comparison.” I would like to provide one more illustration of this point for cases when *do-* applies to the time scale. As follows from the observations made by Kagan (2012), the maximum point that is reached has to be specified (at least by the context) because the time scale is an open scale. For example, (112a) cannot be uttered if it is not clear from the context until what time the actor was supposed to sit. The situation is different with (112b) and (112c). These can be used without any supportive context. This illustrates that the requirements of these prefixes vary (*po-* can create limits on an open scale and *pere-* is supported by the scale construction mechanism that is able to extract non-linguistic information about the appropriate time for the actor to spend sitting).

- (112) a. Ja dosidel.
 I do.sit.PST.SG.M
 ‘I sat till the end.’
- b. Ja posidel.
 I po.sit.PST.SG.M
 ‘I sat for a while.’
- c. Ja peresidel.
 I pere.sit.PST.SG.M
 ‘I sat for too long.’

4 Semantics of individual prefixes

It is also important that in case the time point until which the sitting lasted is explicit, the difference between the literal semantics of the verb *dosidet* 'to sit until a certain time' and *posidet* 'to sit for a while' is lost, as illustrated by (113a) and (113b). In this situation the difference between the *po*- and the *do*-prefixed verbs results from their pragmatic competition. We obtain the enriched meaning of the *do*-prefixed verb that the sitting event lasted relatively long and the enriched meaning of the *po*-prefixed verb that the sitting event was rather short.

- (113) a. Ja dosidel do pjati utra, i, tak i ne
 I do.sit.PST.SG.M until 5 morning and that and not
 doždavšis' tebjā, usnul.
 do.wait.PART.PST.refl you, fall.asleep.PST.SG.M
 'I sat there waiting for you until 5 a.m. and fell asleep (before you arrive).' <https://ficbook.net>
- b. Priexal na učebu k 7, posidel do 8:15 –
 pri.ride.PST.SG.M on study to 7, po.sit.PST.SG.M until 8:15 –
 otpustili domoj.
 ot.let.PST.PL home
 'I arrived for the class at 7, sat there until 8:15 and then I was free to go home.' <https://twitter.com>

From the bleached difference between the literal semantics of *po*- and *do*-prefixed verbs when these prefixes apply to the time scale follows that they cannot be stacked. When the prefix *po*- with its 'for a while' meaning is attached to a verb, e.g. *sidet*¹⁷ 'to sit', the event denoted by this verb is conceptualised as being homogeneous and having some limited duration. This verb cannot be further prefixed with *do*-: the verb **doposidet* does not exist. The potential semantics of this verb after the attachment of two prefixes would be 'to complete sitting for a while', which is equivalent to either 'to sit for a while' or 'to finish sitting', that can both be expressed with morphologically simpler verbs. In case only the time scale is available in the verbal semantic structure, the reverse stacking (*po*- on top of *do*-) is not available for the same reason: the verb **podosidet* could mean 'to sit for a while finishing sitting', but there is no event falling under this denotation that could not be described by either 'to sit for a while' or 'to finish sitting'. Note that when *do*- selects some other scale than the time scale, the prefix *po*- can be stacked on top of it after the verb is imperfectivised. This is illustrated by chain (114)¹⁷ and example (115).

¹⁷Only additive interpretations are provided for the verbs in the chain, but terminative interpretations are also possible. In this case the last derived verb means either 'to write the final part for a while' or 'to finish writing all of'.

- (114) *pisat'*^{IPF} → *dopisat'*^{PF} → *dopisyvat'*^{IPF} →
 to write → to write in addition → to (be) writing in addition →
podopisyvat'^{PF}
 to write in addition in all of/for a while
- (115) *Podopisyval noli v isxodnye dannye.*
 po.do.write.imp.PST.SG.M zeros in initial data
 'I added zeros to the initial data.' www.planetaexcel.ru

Tatevosov (2009) lists *do-* as a positionally limited prefix which means that it can be attached only below the secondary imperfective suffix. As we have already discussed in Section 2.1, this is not a valid observation. For example, the verb *dovyšivat'* 'to finish embroidering' is either perfective or biaspectual, depending on whether the individual speaker considers whether or not the verb *dovyšit'* 'to finish embroidering' exists. What is important is that no speaker I have consulted responded that this verb can have only the imperfective interpretation, as suggested by the theory proposed in Tatevosov 2009. In the poem (111) the verb *dorazukrašivat'* 'to finish colouring' is also perfective as it is constructed according to the derivation presented in (116a). The verb containing the same morphemes can also be imperfective if the order of attachment is different, as represented in (116b).

- (116) a. *krasit'*^{IPF} → *ukrasit'*^{PF} → *razukrasit'*^{PF} → *razukrašivat'*^{IPF}
 to paint → to decorate → to colour → to colour/be colouring
 → *dorazukrašivat'*^{PF}
 → to finish colouring
- b. *krasit'*^{IPF} → *ukrasit'*^{PF} → *razukrasit'*^{PF} → *dorazukrasit'*^{PF} →
 to paint → to decorate → to colour → to finish colouring →
dorazukrašivat'^{IPF}
 to finish/be finishing colouring

A couple of other biaspectual verbs are the verbs *doobdumyvat'* 'to finish thinking about' (see examples in (117)) and *dozabivat'* 'to finish hammering' (see examples in (118)).

- (117) a. *V processe čtenija v golove načali oformljat'sja vsjakie*
 in process reading in head start.PST.PL form.INF.refl various
xitrye i kovarnye idei, no ix eščë nužno akkuratno
 tricky and crafty ideas but they also needed carefully

4 Semantics of individual prefixes

doobdumyvát'^{PF}.

do.ob.think.IMP.INF

'While I was reading it some tricky and crafty ideas came into my head, but I need to think them over accurately.'

<http://nicka-startcev.livejournal.com>

- b. Zásim ja idu morozit' nos i doobdumyvát'^{IPF}
 hereupon I go.PRES.SG.1 freeze.INF nose and do.ob.think.imp.INF
 včerašnjaju ideju, poka ona ne ubežala ot menja
 yesterday's idea while she not u.run.PST.SG.F from me
 okončatel'no.
 completely

'Hereupon I go to freeze my nose and think more about yesterday's idea until it has fled from me completely.'

8794.diary.ru

- (118) a. Tam eščë, čut' popozže, krjuk eščë i dozabivat'^{PF} v sneg
 there also a bit later hook also and do.za.hit.imp.INF in snow
 umudrjajutsja, i, prežde čem verjovku rezat', celuju
 manage.INF.refl and before what.INSTR rope cut.INF whole
 reč' proiznosjat.
 speech pronounce.PRES.PL.3

'In the same video, a bit later, they also manage to hammer the hook in the snow completely and then they deliver a whole speech before cutting the rope.'

<http://yarin-mikhail.livejournal.com>

- b. Gvozdi inogda dozabivat'^{IPF} prixoditsja.
 nails sometimes do.za.hit.imp.INF pri.go.PRES.SG.3.refl

'The nails sometimes have to be additionally hammered.'

<https://forumhouse.ru>

It seems that the prefix *do-* is very undemanding with respect to the verb it attaches to. Sometimes the resulting verb seems odd, as *donapisat'* 'to finish writing', but such difficulties are of the same kind as with attaching the repetitive prefix *pere-* to some perfective verbs (see Section 4.6) and we do find these verbs in some contexts. Such contexts require exactly the semantics obtained by the semantic composition of the prefix *do-* with the prefixed verb (e.g., *napisat'* 'to write/create something written') and not with the unprefixed verb (e.g., *pisat'* 'to write'). An example is provided in (119a) to be contrasted with (119b) in which the verb is replaced. As we see, the speaker wants to express the additive semantics, and as the most natural interpretation of the verb *dopisat'* is 'to finish writing', he prefers to use the verb *donapisat'* 'to write something in addition'. This leads

to the question of how the meaning of the prefix is related to the properties of the derivational base.

- (119) a. Tam ja donapisal pis'ma i novoe
 there I do.na.write.PST.SG.M letter.PL.ACC and new
 stixotvorenje, a takže porabotal s fotografijami.
 poem but also po.work.PST.SG.M with photos
 'There I also wrote letters and a new poem, and also worked a bit
 with the photos.' dd.vl.ru
- b. Tam ja dopisal pis'ma i novoe stixotvorenje,
 there I do.write.PST.SG.M letter.PL.ACC and new poem
 a takže porabotal s fotografijami.
 but also po.work.PST.SG.M with photos
 'There I finished writing the letters and the new poem, and also
 worked a bit with the photos.'

Note that the aspect of the derivational base matters. In general, if the derivational base is perfective, the interpretation of the derived *do*-prefixed verb tends to be additive (compare (120a) and (120b)), and if the derivational base is a secondary imperfective verb, the additive interpretation seems to be not available (see example (121a)). In case a *do*-prefixed verb gets imperfectivised, both additive and terminative interpretations become available for the derived imperfective verb (see examples under (122)).

- (120) a. Katja dokupila mandarin.
 Katja do.buy^{PF}.PST.SG.F tangerine.PL.GEN
 'Katja also bought some tangerines.'/'Katja bought some additional
 tangerines.'
- b. Katja dopokupala mandariny.
 Katja do.buy^{IPF}.PST.SG.F tangerine.PL.ACC
 'Katja finished buying tangerines.'
- (121) a. Petja dozapisyval^{PF} dva diska.
 Petja do.za.write.imp.PST.SG.M two CDs
 'Petja finished recording two CDs.'
- b. Petja dozapisal^{PF} dva diska.
 Petja do.za.write.PST.SG.M two CDs
 'Petja additionally recorded two CDs'/'Petja finished recording two
 CDs.'

4 Semantics of individual prefixes

- (122) a. Mexanik dozapravil^{PF} samolët (i zakuril
mechanic do.fill.PST.SG.M plane.SG.ACC (and za.smoke.PST.SG.M
sigaretu).
cigarette)
'The mechanic additionally fueled the plane and lit a cigarette.'
- b. Mexanik dozapravljal^{PF} samolët (i
mechanic do.fill.imp.PST.SG.M plane.SG.ACC (and
zakuril sigaretu).
za.smoke.PST.SG.M cigarette)
'The mechanic finished fueling the plane and lit a cigarette.'
- c. Mexanik dozapravljal^{IPF} samolët (i kuril
mechanic do.fill.imp.PST.SG.M plane.SG.ACC (and smoke.PST.SG.M
sigaretu).
cigarette)
'The mechanic was finishing fueling/ additionally fueling the plane
and smoking.'

The verbs used in (122) result from the following derivations. The perfective verb *zapravit* 'to fuel' can be either directly prefixed with *do-* (as in the chain (123a)) or imperfectivised before (as in the chain (123b)). In the first case the derived verb is *dozapravit*^{'PF} 'to fuel additionally' (used in example (122a)) that can then be imperfectivised in order to obtain the verb *dozapravljal*^{'IPF} that can either mean 'to finish/be finishing fueling' or 'to fuel/be fueling additionally', as illustrated by example (122c). If the morphemes are attached in the different order, as illustrated by chain (123b), the derived verb *dozapravljal*^{'PF} 'to finish/be finishing fueling' is perfective and acquires terminative semantics (see example (122b)).

- (123) a. *zapravit*^{'PF} → *dozapravit*^{'PF} →
to fuel → to fuel additionally →
dozapravljal^{'IPF}
to (be) finish(ing) fueling/to (be) fuel(ing) additionally
- b. *zapravit*^{'PF} → *zapravljal*^{'IPF} → *dozapravljal*^{'PF}
to fuel → to fuel/be fueling → to finish/be finishing fueling

Chain (123a) illustrates that the additive meaning component associated with a *do-*prefixed verb is not inherited and can be replaced by another inference after the imperfectivisation step. This speaks in favour of the hypothesis that this kind of additional inference is not specified in the semantic structure of the verb but arises as a result of the interpretation of the semantic representation followed by

a pragmatic competition. For this reason, I will abandon the distinction between the additive and the terminative usages of *do-*. In sum, I claim that it is not only possible to unify the additive and the terminative usages of the prefix *do-*, but that there are no distinct representations for these usages. Instead, there are different ways to interpret the semantic representation of the derived verb that result in different inferences.

- (124) a. Nu, doperepisal, tak-to proizvedenie bylo napisano v
 well do.pere.write.PST.SG.M that composition was written in
 97–98 gg...
 97–98 years
 ‘Well, I finished rewriting it, as the work was actually written in
 1997–1998.’ na-ive.diary.ru
- b. Doperepisyval načisto, s nekotorymi
 do.pere.write.imp.PST.SG.M clean with some
 ispravlenijami, preljudiju do mažor.
 corrections prelude C major
 ‘Finished rewriting the final version of the C major prelude (with
 some corrections).’ 1001.ru

Another observation concerns stacking the prefix *do-* on top of the prefix *pere-*: when *pere-*-prefixed verbs are further prefixed with *do-*, they acquire a terminative interpretation independently of derivational base’s aspect (see examples (124a) and (124b)). Putting it simply, the events referred to by the *pere-*-prefixed verbs are conceptualised as proceeding through contiguous stages. The additive interpretation of the prefix *do-* requires (according to the proposal of Kagan 2015) that there is a break between the event associated with the initial part of the scale and the event associated with the final part of the scale. Such a gap is incompatible with the semantics of the derivational base if it contains the prefix *pere-*.

In sum, I propose to represent the contribution of the prefix *do-* as fixing the final stage of the event and specifying the event denoted by the derived verb as being part of an event denoted by the derivational base.

4.7.3 Subsequent imperfectivisation of a verb with the *do-* prefix

The existence of a prefix that has a transparent semantic contribution and does not block subsequent imperfectivisation at all is not predicted by the theory of distinct structural positions for the lexical and superlexical groups of prefixes. However, the possibility of attaching the imperfective suffix to *do-*-prefixed verbs

4 Semantics of individual prefixes

cannot be denied and this prefix has been incorporated in the lexical/superlexical framework, acquiring a different status (e.g., falling in the category of *intermediate* prefixes in the theory of Tatevosov 2007). Imperfectivisation of verbs prefixed with *do-* seems to be possible in all cases when the verbal stem allows the addition of the imperfective suffix. Some examples of secondary imperfective verbs with the prefix *do-* have been provided above: these are the sentences (122c) and (124b).

The cases when imperfectivisation is not possible are those cases when the verbal stem is not compatible with the imperfective suffix at all, as in the case of the verb *želtet* 'to turn yellow/to be seen as yellow' that we have already discussed in connection with the prefix *za-*. This verb in its 'to turn yellow' interpretation can be prefixed with *do-*. The result is the verb *doželtet* 'to finish turning yellow' (see example (125)). This verb cannot be further imperfectivised.

- (125) Te list'ja doželteli i opali.
that leaves do.turn.yellow.PST.PL and o.fall.PST.PL
'Those leaves finished turning yellow and fell off.'

www.bonsaiforum.ru

4.7.4 Summary

Summing up the above discussion, we need to bear in mind the following observations when the formal representation of the prefix *do-* is constructed.

1. If the derivational base lexicalises a scale, *do-* selects this scale. If not, the second choice is the scale contributed by the direct object (which can be a measure of change scale). If both options are unavailable, *do-* can quantify over the time scale.
2. The scale selected by *do-* has to be upper closed.
3. The end point of the event denoted with the *do-*prefixed verb has to correspond to the maximum point on the scale.
4. If *do-* attaches to a perfective verb and the start of the event denoted by this verb is related to the minimum on the scale, the event can be decomposed into a preparatory and a focused phase.

4.8 Secondary imperfective

Formally representing the semantics of the imperfective suffix is a task I am not aiming to complete in this book. However, it is not possible to construct the desired compositional semantics of complex verbs without a semantic representation of the imperfective suffix. In order to achieve the goal of analyzing prefix stacking (with respect to the prefixes discussed above plus verbs that are listed in the dictionaries) I have to construct some formal representation of the semantics of the imperfective suffix. I will do this for two cases: (1) progressive meaning of the imperfective and (2) habitual meaning of the imperfective. This involves a number of decisions that I will present without proper justification.

The first puzzle that has to be solved in some way concerns the general problem with the progressive interpretation of the secondary imperfective that seems to cancel the “reaching the boundary” component added by the prefix. I claim that when secondary imperfectivisation happens, there is no “reversion” to the initial imperfective semantics. I will account for this in the following way.

Let us start with a basic imperfective verb. Such a verb denotes an activity or a process that is not mapped onto the time scale. If one wants to describe it in terms of telicity, it can be either atelic, as *sidet*^{TPF} ‘to sit/be sitting’ or telic, as *pisat’pis’mo* ‘to write/be writing a letter’, but in neither case does it have endpoints that are mapped onto the time scale. According to my view, this mapping is added by prefixes. As the verb gets prefixed, its semantic structure gets enriched with endpoints that are related to time points. In case the scale selected by the prefix is the time scale, some points on this scale are directly associated with the start and the end of the event. In case the event proceeds along another scale, points on that scale are mapped onto the time scale.

I propose that when the imperfective suffix with progressive semantics is attached to a perfective verb, the boundaries that are present in the semantic structure of the derivational base do not disappear. Instead, the derived verb denotes an event that is part of the event denoted by the derivational base and is of type *progression*. It can as well turn out that this partial event coincides with the whole event in case the verb is prefixed further or the imperfective is actually used to describe a completed event.

The second meaning of the secondary imperfective suffix that I will formalise is the repetitive/habitual meaning. My solution resembles that for the distributive *pere-* except for the absence of the set that has to be iterated through. In the case of the imperfective suffix the iteration is performed without imposing restrictions on when the first event of the iterated series started and when (and whether) the series is going to end. Attachment of the imperfective suffix with a

repetitive/habitual interpretation is similar to providing a repetitive context for a telic verb in English: independently of the language, the iteration of a bounded event results in an unbounded event. For English this means that verbs denoting accomplishments and achievements become compatible with *for*-adverbials. For Russian the consequence of the attachment of the imperfective suffix is an additional layer of verbal structure that makes the event unbounded and thus imperfective and also opens additional prefixation possibilities.

4.9 Summary

In this chapter, I have provided an overview of semantic approaches to Russian verbal prefixation and examined the semantic and combinatorial properties of five verbal prefixes: *za-*, *na-*, *po-*, *pere-*, and *do-*. For each prefix I have discussed its semantic contribution, restrictions on its attachment and on further combination with the imperfective suffix.

As, following Kagan (2015), I adopt a scalar analysis of prefix semantics, I have also provided general information about scales and drawn attention to the types of scales individual prefixes are compatible with and the relations they impose between scalar points and event stages.

I have concluded that the prefix *za-* in its inceptive usage requires the time scale and that the initial stage of the event denoted by the derived verb corresponds to the absence of the event denoted by the derivational base while the final stage corresponds to the presence of the event denoted by the derivational base.

The prefix *na-* accepts a wide range of scales as long as they are provided by the verb and belong to the set of parameters of the object. It maps the initial stage of the event to the minimal point of the scale and the end of the event to some point that is at or above the contextually specified standard degree. The prefix *po-* is compatible with any verbal scale and the *cardinality* scale in case of a plural object. It relates the initial and the final stages of the event to points on the scale.

The prefix *pere-* has three different interpretations that depend on the type of scale: in case of a closed scale the event proceeds from the minimum to the maximum on the scale through all its points; in case of a scale with one marked point the event proceeds from the point below the marked point and further through the marked point to some point above it; in case of a *property* scale the repetitive interpretation of the prefix is delete available and the new event is created by copying the event denoted by the derivational base which, in turn, becomes the preparatory phase of the new event.

The last prefix, *do-*, is compatible with scales provided by the verb and by the object as long as they are upper closed. It maps the initial stage of the event onto some point on the scale and the final stage of the event onto the maximum of the scale.

In course of the discussion of the prefix *do-* and the repetitive usage of the prefix *pere-* I have also raised questions concerning possible presuppositional components in the semantic structure of these verbs, as suggested by Kagan (2015). I will address these questions in the next chapter.

After that, in Chapter 6, I will offer a formalization of the intuitions and observations laid out in this chapter, using the combination of (Fillmore 1982) and LTAG (Joshi & Schabes 1997) formalised in Kallmeyer & Osswald 2013.

5 Pragmatics

In this chapter, I discuss the pragmatic effects associated with the attachment of certain verbal prefixes, mentioned in the previous chapter. The main aim of the Sections 5.1, 5.2, and 5.3 is to establish that, contrary to most analyses, the inferences associated with the perfective aspect of the derived verb and particular verbal prefixes are not semantic presuppositions.

In Section 5.1, I explore two common claims. The first claim is that perfective verbs trigger a presupposition that the initial phase (or the process part) of events denoted by them actually took place (henceforth a *process presupposition*). While exploring this claim, I outline the evidence in favour of a semantic presuppositional analysis offered in previous Slavic studies and provide a brief overview of an alternative pragmatic approach, proposed by Grønn (2004; 2006).

The second claim is that there is a presupposition triggered by specific verbal prefixes independently of the grammatical properties of the whole surface verb. The prefixes that are discussed in this respect are the completive prefix *do-* and the repetitive prefix *pere-*. These prefixes have been claimed to give rise to presuppositions similar to those associated with lexical items like *finish* and *again*, respectively (see Kagan 2015 and Sections 4.6–4.7 here).

Section 5.2 presents evidence against the presuppositional approach outlined in Section 5.1. In Section 5.3, I show that both cases of inferences (related to the perfective aspect and to the prefixes *do-* and *pere-*) are better analysed as (scalar) implicatures in negative contexts and questions and as entailments in affirmative declarative sentences. This hypothesis is supported by empirical tests that allow to tease apart presuppositions, entailments and (scalar) implicatures associated with Slavic verbs. The testing methodology relies on some results from recent research in the domain of projective content (Schlenker 2008; Chemla 2009; Romoli 2011, and references therein). Sections 5.1–5.3 present joint work with Hana Filip, also published as Zinova & Filip 2014 and Zinova & Filip 2015a.

The last section of this chapter, Section 5.4, is dedicated to providing an overall picture of how the whole prefixation system works when the range of meanings available for the prefixed verbs gets constrained by pragmatic competition.

5.1 Previous approaches

5.1.1 Inferences associated with the perfective aspect

This section addresses the common claim that perfective verbs presuppose the initial phase (or a process part) of the events denoted by them, and assert their final phase (or a culmination part), while the meaning of imperfective verbs lacks both these components. Different formulations of this claim have been proposed by Padučeva (1996; 2011) and Romanova (2006) for Russian, and by Dočekal & Kučerová (2009) for Czech.

As an example, consider (1). It contains a perfective verb *pročítat* ‘to read through’ that denotes (a set of) accomplishments (its imperfective simplex base *čítat* ‘to read’ denotes (a set of) processes). According to the proposals by Padučeva (1996; 2011), Romanova (2006), and Dočekal & Kučerová (2009), (1) presupposes the existence of the process (initial) part of events it denotes, i.e., ‘Ivan started reading the book’ and asserts that the denoted events culminated, i.e., ‘Ivan finished reading the book’.

- (1) Ivan pročítal^{PF} ètu knihu.
 Ivan pro.read.PST.SG.3 this book
 ‘Ivan read this book completely through.’

The presuppositional nature of the process component of perfective verbs is viewed as being confirmed by the observation that it is preserved under negation and in questions, as shown in (2a) and (2b), respectively:

- (2) a. Ivan ne pročítal^{PF} ètu knihu.
 Ivan not pro.read.PST.SG.M this book
 ‘Ivan did not read this book completely through.’
Assertion: Ivan did not finish reading this book.
Inference: Ivan started reading/read a part of this book.
- b. Ivan pročítal^{PF} ètu knihu?
 Ivan pro.read.PST.SG.M this book
 ‘Has/Did Ivan read this book completely through?’
Question: The speaker asks the addressee to confirm or deny whether Ivan finished reading this book.
Inference: Ivan started reading/read a part of this book.

In the example (2a) the meaning component that is negated is the culmination, but not the process (initial) part of described events, i.e., (2a) can be felicitously

uttered in a situation in which it is known that Ivan started reading the book. In (2b), what is questioned is whether the speaker finished reading the book. To the extent that the previous studies rely on the negation and question tests, it is fair to assume that what they have in mind is a semantic presupposition. The presence of a presupposition is sometimes (e.g., by Padučeva 1996; Romanova 2004) also viewed as a common core of all perfective verbs. Let us now address the details of the analyses that follow from different linguistic traditions.

5.1.1.1 Russian linguistic tradition

In the Russian linguistic tradition, the idea that perfective verbs have a bipartite structure can be traced back to Maslov (1984). On his view, Russian perfective verbs consist of an “eventive” part (*sobytijnyj komponent*) and a “stative / resultative” part (*statal’nyj komponent*).

Building on Maslov (1984), Padučeva (1996; 2011) proposes that these two components of perfective verbs differ in their communicative status. What roughly corresponds to Maslov’s “eventive” component is presupposed and concerns backgrounded information. On her view, it comprises not only the process part of events described by perfective verbs, but also their preparatory conditions and various pragmatic factors like intentions, expectations and obligations associated with the utterance of sentences headed by perfective verbs. The second, asserted, component regards focused information, including the ‘reaching of a/the boundary’, i.e., the final phase of events involving goals, results, and limits of various sorts.

Padučeva (1996) illustrates these points by contrasting sentences (3a) and (3b). According to her, the sentence (3a), which is headed by an imperfective verb, is a neutral question about whether a cab was called. Sentence (3b), which is headed by a perfective verb, in addition suggests that from the point of view of the speaker the addressee was required, expected, or obliged to call a cab.

- (3) a. Taksy vyzyvali^{IPF}?
 Taxi call.PST.PL
 ‘Did you call a cab?’ = (1a) in Padučeva 1996: 55
- b. Vy vyzvali^{PF} taksy?
 you.PL call.PST.PL taxi
 ‘Did you call a cab?’
Presupposition: The hearer was expected/required to call a cab.
 = (1a) in Padučeva 1996: 55

5 Pragmatics

Although Padučeva (1996) adduces a number of valid and subtle intuitions in support of her approach to the uses of perfective verbs (e.g., the negation test), as opposed to imperfective ones, its major weakness is that it fails to separate between the semantic meaning components of perfective verbs, and various speech-act-related pragmatic inferences (such as speaker's deontic and normative expectations on the addressee) associated with utterances of sentences with perfective verbs.

The second problem, and one that is also mentioned in Grønn 2004, is that the observed speaker-oriented modality inferences are not consistently attached to all the uses of sentences with perfective verbs. For instance, as Grønn (2004) observes, they are not associated with the utterances of affirmative sentences headed by perfective verbs. Take, for example, (4), which is an affirmative correspondent of (3b), but unlike (3b) does not suggest (under the most neutral circumstances) that the referent of *ja* 'I' was required, expected, or obliged to call a cab:

- (4) Ja vyzval^{PF} taksi.
I call.PST.SG.M taxi
'I called a cab.' = example (53) in Grønn 2004: 61

Padučeva (1996: 56) also observes that there is no reason to assume that the utterance of (4) triggers the inference of an "expectation component" ("komponent ožidanija") on the part of the speaker, but she does not motivate this observation any further. That is, Padučeva (1996) is aware of the fact that not all the sentences with perfective verbs carry the relevant inference (or "presupposition" in her wide sense), but she does not provide any account when it may, must or must not be present in sentences with perfective verbs.

5.1.1.2 Syntactic approaches to the decomposition of perfective verbs

Following Padučeva (1996), Romanova (2006) proposes that "perfective verbs must have a complex semantic structure, where one part is asserted, the other is presupposed" (p. 29). She adopts the characterisation of the presupposed part given by Padučeva (1996), but has a different understanding of the asserted component.

Most importantly, according to Romanova (2006), "it is not true that only resultative verbs or the verbs with 'reaching-the-boundary' component, can bear the presupposition of perfectives" (p. 29), but rather all perfectives are "words that encode decomposable structures (informational, semantic and therefore syntactic)" (ibid., p. 53). For example, even the class of inceptive verbs like those with

the prefix *za-* (e.g., *zapet* ‘to begin to sing’) which fail to entail culmination or result of some sort (under the most usual understanding), are taken to have a complex semantic structure, whereby the first part is presupposed. According to Romanova (2006), the sentence (5), for instance, asserts that Tonja did not start to sing and presupposes that Tonja was expected to sing her song.

- (5) Tonja ne zapela^{PF} svoju pesnju.
 Tonja not za.sing.PST.SG.F self’s.F.ACC song.ACC
 ‘Tonja didn’t start to sing her song.’
Presupposition: Tonja was expected to sing her song.
 = example (64a) in Romanova 2006: 29

Another example that is used by Romanova (2006) is provided under (6) here: the sentence is claimed to be associated with a presupposition that the addressee was supposed to buy bread.

- (6) Ty kupila^{PF} xleb?
 You.SG.NOM bought.PST.SG.F bread.ACC
 ‘Did you buy bread?’
Presupposition: You were supposed to buy bread.
 = example (65) in Romanova 2006: 30

This generalisation allows Romanova (2006) to represent the semantics of all perfective verbs as that of accomplishments, which are commonly assumed to have a bipartite structure. Romanova (2006) follows a syntactic approach of Ramchand (2004), on which accomplishments are analysed in terms of syntactic structures that consist of two separate projections, namely process (ProcP) and result (resP). Those projections correspond to the presuppositional and assertive components of the meaning of perfective verbs, respectively.

There are three main problems with the account by Romanova (2006). First, the meaning of perfective verbs as a whole class cannot be assimilated to that of accomplishments (for counterarguments see Filip 2000; Filip & Rothstein 2005). Obviously, there are perfective verbs that cannot be meaningfully decomposed into two subevents, a process and a result subevent. One good example is the class of semelfactive verbs with the suffix *-nu-* in Russian, such as *prygnut* ‘to jump’.

Second, what remains entirely unclear is the representation of speaker- and/or addressee-oriented attitudes in terms of syntactic structures. For instance, the syntactic representation of the alleged ‘contrary to the expectation’ (see example (5)) and obligation (see example (6)) inference that is supposed to be associ-

ated with the process (ProcP) part of the syntactic structure of perfective verbs remains on a pretheoretic level.

Third, it is easy to show that the alleged presuppositional meaning components (here, the expectation of the speaker on the addressee or on some participant of the situation described by perfective sentences) are not tied to the uses of perfective verbs only, which is a point of criticism that also applies to the proposal of Padučeva (1996). Compare (5) with (7). Sentence (5) is headed by a perfective verb, while sentence (7) is headed by the corresponding imperfective simplex verb. Also (7), and not only (5), triggers the inference that Tonja was expected to sing her song.

- (7) Tonja ne pela^{IPF} svoju pesnju.
 Tonja not sing.PST.F.SG self's.F.ACC song.ACC
 'Tonja wasn't singing/didn't sing her song.'
Inference: Tonja was expected to sing her song.

The account proposed by Romanova (2006) also inherits the problems related with the proposal of Padučeva (1996): first, the failure to distinguish between semantic components of perfective verbs and pragmatic factors having to do with obligations, expectations and the like on the part of the interlocutors, and second, the fact that the alleged presuppositions of perfective verbs fail to be present in all their uses, most notably in utterances of affirmative sentences.

5.1.1.3 Event semantics

One illustrative example of an event semantics approach is Dočekal & Kučerová (2009). They take it for granted that all perfective verbs have a uniform meaning of telic predicates. Telic predicates are equated with accomplishment predicates, which means that they are decomposed into two subevents, where e_1 is a process and e_2 is the result state (mainly following Giorgi & Pianesi 2001). Their main innovation is the claim that perfective verbs carry the "activity presupposition" tied to e_1 or "the first homogeneous part of telic events". The evidence for this claim comes from the observation that it exhibits the usual projective properties of a semantic presupposition: namely, it "projects under negation and under a question operator".

Similar to the case of the proposal by Romanova (2006), an immediate problem with this account is that the meaning of perfective verbs as a whole class cannot be equated with that of accomplishments. Another problem is noticed by Dočekal & Kučerová (2009) themselves: namely, imperfective verbs can also carry the

“activity presupposition”. A case in point is the class of secondary imperfective verbs (in most cases explicitly marked with the imperfective suffix *-yva-*) that are formed with the “completive” (or “terminative”) prefix *do-*, as in the example (8a). The sentence (8a) denies that Vasya was about to finish reading the book yesterday, and implies that he read a part of it, but was nowhere near being close to finishing reading it. But notice that the same inference – namely that Vasya read a part of the book – is also triggered by the sentence with the corresponding perfective verb (8b):

- (8) a. Včera Vasja ne dočityval^{IPF} tu knigu.
 Yesterday Vasya not do.read.IMP.PST.SG.M that book
 ‘Yesterday Vasya was not finishing reading that book.’
Inference: He started reading that book.
- b. Včera Vasja ne dočital^{PF} tu knigu.
 Yesterday Vasya not do.read.PST.SG.M that book
 ‘Yesterday Vasya did not finish reading that book.’
Inference: He started reading that book.

Dočekal & Kučerová (2009) acknowledge that such prefix usages as the terminative usage of the prefix *do-*, when they constitute a part of a secondary imperfective verb, are problematic for their account, because secondary imperfectives with such prefixes can also trigger the “activity presupposition” just like perfective verbs. They set this problem aside for future research.

5.1.1.4 Summary of the presuppositional accounts

All the works summarised up to this point share the claim that all and only perfective verbs can be decomposed into two parts, effectively having the bipartite structure of accomplishments. In this bipartite structure, the first part (“process” or “activity”) is presupposed while the second part (“result”) is asserted. However, there is a number of perfective verbs that do not have the structure of accomplishments, i.e., that cannot be plausibly decomposed into a process and a result component (see Filip 2000; Filip & Rothstein 2005: and references therein).

Second, some studies of perfective verbs (here represented by Padučeva 1996; Romanova 2006) contain claims about the association of perfective verbs with certain speaker-oriented modalities; particularly prominent are speaker’s normative and deontic expectations on the addressee. Such speech-act-related factors clearly lie outside of the lexical semantic structure of perfective verbs (which is not to deny that they may arise from the interaction of the lexical meaning of

perfective verbs with pragmatic factors). This raises the question about the distribution and robustness of such pragmatic inferences that are allegedly associated with the uses/meaning of perfective verbs.

Third, despite frequent claims about the “presupposition” of perfective verbs, there seems to be little reflection on the status of such claims, and if any concrete empirical evidence is adduced at all, it is their preservation under negation and in questions. However, not all that projects is a presupposition (see, e.g., Chierchia & McConnell-Ginet 1990; Beaver 2001; Potts 2005), so more evidence is needed to establish the status of the observed inferences.

5.1.1.5 Pragmatic implicature

Grønn (2004: 61) correctly recognises that “[t]he negation test in itself is not a sufficient argument for associating perfective accomplishments with a presupposition”. Instead, he proposes that the process inference is a matter of pragmatic implicature (Grice 1975).

The account by Grønn (2004; 2006) is based on two main assumptions. First, it relies on the markedness theory of Slavic aspect (Maslov 1958; Jakobson 1971), according to which the imperfective aspect is semantically unmarked, i.e., unspecified with respect to the distinguishing semantic feature of the perfective aspect that is taken to be the marked member of the aspectual opposition. Second, it integrates pragmatic assumptions related to speaker’s and hearer’s economy effort in communication, based on “the Gricean idea that the best form-meaning pairs are the ones which minimize both the speaker’s and hearer’s effort (whose interests are, in a sense, conflicting)” (Grønn 2006: 71). Grønn’s idea of aspectual competition can be illustrated with the following examples:

- (9) a. Ivan ne čital^{PF} ètu knigu.
 Ivan not read.PST.SG.3 this book
 ‘Ivan did not read this book.’
- b. Ivan ne pročital^{PF} ètu knigu.
 Ivan not pro.read.PST.SG.3 this book
 ‘Ivan did not read this book completely through.’
 = ex. (2a) in this chapter

The unmarked imperfective (9a) is the default choice of the speaker when the existence of a whole (culminated) event is negated. If the speaker chooses (9b), with the aspectually marked perfective form, instead of the unmarked imperfective one, as in (9a), the hearer infers that there was some attempt or activity on

the part of the agent of the described events which did not culminate, because it would have been more economic for the speaker to use the unmarked imperfective, if it were possible/relevant.

This account is implemented in Optimality Theory (Blutner 2000) and provides an important contribution to the understanding of aspectual distinction in Russian due to the shift from semantic presupposition to pragmatic analysis.

5.1.2 Prefixes: The completive *do-* and iterative *pere-*

The completive prefix *do-* is claimed to behave similarly to the English verb *finish*. For example, Kagan (2015: 75) states that “*finish* and *do-* presuppose that a particular event begins, or takes place partially, and entail that it reaches a certain finishing point”. As an illustration, consider (10a) that contains a perfective verb *dočitat* ‘to finish reading’, formed with the completive prefix *do-*. According to Kagan (2015), the sentence in (10a) entails that the whole book was read and presupposes that the event of reading the book took place.

- (10) a. Ivan dočital^{PF} ètu knigu.
Ivan do.read.PST.SG.3 this book
‘Ivan finished reading this book.’
b. Ivan perečital^{PF} ètu knigu.
Ivan pere.read.PST.SG.3 this book
‘Ivan reread this book.’

As for the iterative prefix *pere-*, Kagan (2015: 145) states that (10b) “presupposes that Ivan read the book in question before the event time and entails that another reading event took place”. Note that the prefix *pere-* has a range of other meanings (see Section 4.6) that are irrelevant here.

In support of a presuppositional analysis, Kagan (2015) relies on the negation test. The negation of (10a), shown in (11a), is claimed to presuppose that Ivan read a part of the book and to negate the culmination of the reading event. The sentence in (11b) is taken to presuppose that Ivan read the book before and negate the existence of the second completed reading event.

- (11) a. Ivan ne dočital^{PF} ètu knigu.
Ivan not do.read.PST.SG.3 this book
‘Ivan did not finish reading this book.’
Inference: Ivan read a part of this book.

5 Pragmatics

- b. Ivan ne perečital^{IPF} ètu knigu.
Ivan not pere.read.PST.SG.3 this book
'Ivan did not reread this book.'
Inference: Ivan read this book before.

If perfective accomplishments prefixed with the completive prefix *do-* and the iterative prefix *pere-* are tested, as is done in Kagan 2015 and also illustrated here by the examples (11a) and (11b), two different phenomena are potentially confounded. Specifically, if the completive *do-* constitutes a part of a complex perfective verb, its contribution overlaps with the meaning of perfective aspect. In order to eliminate the confounding factor of perfectivity and to get at the semantics of these two prefixes, it is better to test them when they occur in imperfective verbs, i.e., when they co-occur with the secondary imperfective suffix and no other prefix(es) on the same verb.

To illustrate that the question about presupposition triggering arises at all in the case of imperfective verbs containing the prefixes *do-* and *pere-*, let us address the examples in (12). As shown, (12a) has an inference that the reading of the book started and (12b) has an inference that there was a previous event of reading (either completed or not).

- (12) a. Ivan ne dočityval^{IPF} ètu knigu.
Ivan not do.read.PST.SG.3 this book
'Ivan did not finish/was not finishing reading this book.'
Inference: Ivan read a part of this book.
- b. Ivan ne perečityval^{IPF} ètu knigu.
Ivan not pere.read.PST.SG.3 this book
'Ivan did not reread/was not rereading this book.'
Inference: Ivan read/was reading this book before.

5.2 Evidence against a presuppositional approach

The account by Grønn (2004; 2006) summarised above sheds considerable doubts on the status of the inferences in question as semantic presuppositions. Therefore, in this section, I take a closer look at them, relying on standard tests used in the research on projective meaning to diagnose semantic and pragmatic presuppositions, in particular in contrast with (scalar) implicatures. These tests provide evidence that the process inference associated with perfective verbs is not a matter of either semantic or pragmatic presupposition. The same tests are also

applied to test the status of inferences triggered by the completive prefix *do-* and the iterative prefix *pere-*. However, they do not lead to any conclusive results in this case.

5.2.1 Projection out of the antecedents of conditionals

According to theories of presupposition projection, semantic presuppositions project out of the antecedents of conditionals, as in (13b), but (scalar) implicatures do not (14b).

- (13) a. John didn't win the marathon.
 → John participated in the marathon.
 b. If John won the marathon, he will celebrate tonight.
 → John participated in the marathon.
 c. If John didn't win the marathon, he will not celebrate tonight.
 → John participated in the marathon.

The sentence (13a) contains a presupposition trigger: the verb *to win*. Under negation, the inference that John participated in the marathon is preserved. It is also preserved when the same trigger is located in the antecedent of a conditional, both in affirmative, as in the sentence (13b), or negated, as in the sentence (13c), variants.

- (14) a. John didn't read all the books.
 → John read some of the books.
 b. If John read all the books, he will pass the exam.
 ↔ John read some of the books.
 c. If John didn't read all the books, he will fail the exam.
 ↔ John read some of the books.

If, instead of the presupposition trigger *to win*, a scalar item such as *all* is used, the inference under negation, as in the sentence (14a), seems to be of the same kind as in (13a). However, examples that involve conditionals reveal the difference between the inferences that arise due to the presuppositional triggers and inferences that arise due to the presence of the scalar items. For instance, in (14b) and (14c) the inference that John read some of the books no longer projects.

Now let us explore the Russian data. Example (15) shows that the alleged “process presupposition” that is claimed to be triggered by perfective accomplishments does not project out of the antecedents of conditionals. Hence, it fails to exhibit one of the properties of semantic presupposition.

5 Pragmatics

- (15) Esli Vasja pročital^{IPF} učebnik, on sdast èkzamen.
if Vasya pro.read.PST.SG.M textbook he passes exam
'If Vasya completely read the textbook, he will pass the exam.'
→ Vasya read/began reading the textbook.

As far as the prefixes *do-* and *pere-* are concerned, native speakers have no clear intuitions as to whether the alleged inferences in (16) and (17), which are traditionally taken to be of presuppositional nature, hold. Recall that in order to separate the contribution of prefixes from perfective aspect, it is better to test their contribution in imperfective verbs.

- (16) Esli Vasja včera dočityval^{IPF} učebnik, on sdast èkzamen.
if Vasya yesterday do.read.imp.PST.SG.M textbook he pass exam
'If Vasya finished reading/was finishing reading the textbook yesterday, he will pass the exam.'
? → Vasya read at least a part of the textbook.
- (17) Esli Vasja včera perečityval^{IPF} učebnik, on sdast èkzamen.
if Vasya yesterday pere.read.imp.PST.SG.M textbook he pass exam
'If Vasya (was) reread(ing) the textbook yesterday, he will pass the exam.'
? → Vasya read at least a part of the textbook before.

5.2.2 Defeasibility

Semantic presuppositions are generally taken to be non-cancelable. However, the alleged "process presupposition" of perfective accomplishments can be easily cancelled. Consider the discourse in (18), which is felicitous even though the first sentence is followed by a sentence that denies the "process presupposition" taken to be associated with it, namely, 'Ivan started reading the book.'

- (18) Ivan ne pročital^{PF} ètu knigu. On daže ne otkryl
Ivan not pro.read.PST.SG.3 this book he even not open.PST.SG.M
eě.
it.ACC.F
'Ivan didn't read this book. He did not even open it.'

Again, testing the prefixes *do-* and *pere-* (in imperfective verbs) does not lead to any clear conclusion; the discourses in (19) and (20) are odd, but not as bad as in the case of classic presupposition failure, as in (21).

- (19) Ivan ne dočityval^{IPF} ètu knigu. [?]On daže ne otkryval
 Ivan not do.read.imp.PST.SG.3 this book he even not open.PST.SG.M
 eë.
 it.ACC.F
 ‘Ivan wasn’t finishing/didn’t finish reading this book. He did not even open it.’
- (20) Ivan ne perečityval^{IPF} ètu knigu. [?]On daže ne otkryval
 Ivan not pere.read.imp.PST.SG.3 this book he even not open.PST.SG.M
 eë.
 it.ACC.F
 ‘Ivan wasn’t rereading/didn’t reread this book. He did not even open it.’
- (21) Ivan ne znaet, čto Vasja čital^{IPF} ètu knigu. [#]Vasja daže ne
 Ivan not know that Vasya read.PST.SG.3 this book Vasya even not
 čital^{IPF} eë.
 read it
 ‘Ivan doesn’t know that Vasya read this book. [#]Vasya didn’t even read it.’

5.2.3 “Hey, wait a minute!”

Pragmatic presuppositions are often understood as requirements on the common ground (see e.g., Karttunen 1973; Stalnaker 1973; Shannon 1976; Heim 1983/2002). Shannon (1976: 248) writes that “[u]pon uttering S, a speaker P pragmatically presupposes Q if it is suitable for the hearer to utter ‘One moment, I did not know that Q’ in response to S.”

Sentence (22a) with the perfective accomplishment *pročitala* ‘she read completely (through)’, pronounced with a neutral intonation, cannot be followed by (22b) which denies its alleged “process presupposition”. This suggests that it cannot be a matter of pragmatic presupposition. Notice that (22a) can be followed by (22c), showing the validity of the test, as the ability to read is pragmatically presupposed by (22a).

- (22) a. Katya pročitala^{PF} skazki Puškina.
 Katya pro.read.PST.SG.F fairy tales Pushkin.GEN
 ‘Katya read the fairy tales by Pushkin completely through.’
- b. #Pogodi-ka! Ja ne znal, čto ona ix
 wait I not know.PST.SG.M that she.NOM they.ACC
 čitala^{IPF}!
 read.PST.SG.F
 ‘Wait a minute! I didn’t know that she was reading them!’

5 Pragmatics

- c. Pogodi-ka! Ja ne znal, čto ona umeet čitat'^{IPF!}
 wait I not know.PST.SG.M that she.NOM can read.INF
 'Wait a minute! I didn't know that she can read!'

As for the verbs prefixed with the completive prefix *do-*, the inference introduced by the prefix does not have the properties of the pragmatic presupposition either, as (23a) cannot be followed by the hearer uttering (23b). Again, it is natural for the hearer to utter (22c) after he hears (23a).

- (23) a. Katja dočityvaet^{IPF} skazki Puškina.
 Katya do.read.imppRES.SG.F fairy tales Pushkin.GEN
 'Katya is finishing reading the fairy tales by Pushkin.'
 b. #Pogodi-ka! Ja ne znal, čto ona ix
 wait I not know.PST.SG.M that she.NOM they.ACC
 čitala^{PF!}
 read.PST.SG.F
 'Wait a minute! I didn't know that she was reading them!'
- (24) a. Katja sejčas perečityvaet^{IPF} skazki Puškina.
 Katya now pere.read.imppRES.SG.F fairy tales Pushkin.GEN
 'Katya is now rereading the fairy tales by Pushkin.'
 b. ?Pogodi-ka! Ja ne znal, čto ona ix čitala^{IPF!}
 wait I not know.PST.SG.M that she they.ACC read.PST.SG.F
 'Wait a minute! I didn't know that she was reading them!'

More complications arise with verbs prefixed with the iterative prefix *pere-*. In (24), the hearer's reaction (24b) is slightly odd, but it is more felicitous than the reaction of the hearer in (23b) (in the pair (23a) and (23b), which tests the contribution of the prefix *do-*). However, the acceptability is much lower with some other verbs prefixed with the iterative *pere-*, as in (25a). In this case, the hearer's reaction in (25b) is inappropriate. This points towards a more subtle nature of the inference that is associated with the sentence (24).

- (25) a. Katja sejčas peredelyvaet^{IPF} domašneje zadanije.
 Katya now pere.do.imppRES.SG.F homework.ACC
 'Katya is now redoing the homework.'
 b. #Pogodi-ka! Ja ne znal, čto ona ego delala^{IPF!}
 wait I not know.PST.SG.M that she.NOM he.ACC do.PST.SG.F
 'Wait a minute! I didn't know that she did it!'

5.2.4 Summary

The tests presented in this section lead to the conclusion that the putative “process presupposition” that is claimed to be triggered by perfective accomplishments is not a matter of semantic or pragmatic presupposition.

It is therefore plausible to explore the proposal by Grønn (2004; 2006) that the inference associated with perfective accomplishments is better viewed as a pragmatic phenomenon and analysed in terms of an implicature. This raises the question which kind of implicature is involved here. Section 5.3 focuses on establishing that the observed inference can be treated as a scalar implicature in questions and under negation. In the affirmative sentences it is a plain entailment.

As for the inferences triggered by the prefixes *do-* (completive) and *pere-* (iterative), standard diagnostic tests for semantic and pragmatic presuppositions do not lead to any reliable results. Therefore, another testing strategy is needed in order to find out whether these inferences are of a presuppositional nature.

5.3 Proposal: Scalar implicature

5.3.1 Perfective accomplishments

Perfective accomplishments and their imperfective counterparts can be thought of as being linearly ordered by their degree of informativeness or semantic strength. Intuitively, the relevant scalar implicature can be derived in the following way:

1. Perfective accomplishments have in their denotation only those events that have culminated. Imperfective verbs can refer to either culminated events or events that have started but have not reached their culmination. As the first set of events is smaller than the second one, in affirmative declarative sentences, a perfective verb is more informative than the corresponding imperfective verb and thus the perfective verb presents a stronger alternative.
2. If a sentence headed by a perfective accomplishment holds true, then a sentence with a corresponding imperfective verb must also, given that the process part of the lexical structure of that perfective verb corresponds to the process part of its imperfective counterpart.

5 Pragmatics

Table 5.1 shows that perfective accomplishments are informationally stronger ($>_{\text{INF}}$) than the corresponding imperfective verbs. This holds true of all perfective accomplishments, regardless of whether they are prefixed or not.

Table 5.1: Informational strength of perfective accomplishments and their imperfective counterparts

perfective verb (accomplishment)	$>_{\text{INF}}$ imperfective
pročítat ^{'PF} 'to read completely through'	$>_{\text{INF}}$ čítat ^{'IPF} 'to read'
řešit ^{'PF} 'to solve'	$>_{\text{INF}}$ řešat ^{'IPF} 'to solve'

Under negation, the scale is reversed, as can be seen in Table 5.2. Now, imperfective negated verbs are informationally stronger than perfective ones. The reason for this is that generally when a primary (i.e., simplex, or basic) imperfective verb is negated, it denies the existence of a whole event, while the corresponding perfective accomplishment under negation entails the absence of the culmination phase of the described events, but not necessarily the absence of the initial (process) part.

Table 5.2: Informational strength of perfective accomplishments and their imperfective counterparts under negation

negated perfective	$<_{\text{INF}}$ negated imperfective
ne pročítat ^{'PF} 'to not read completely through'	$<_{\text{INF}}$ ne čítat ^{'IPF} 'to not read'
ne řešit ^{'PF} 'to not solve/be solving'	$<_{\text{INF}}$ ne řešat ^{'IPF} 'to not solve'

5.3.2 The completive prefix *do-* and the iterative prefix *pere-*

Table 5.3 illustrates the fact that a sentence with an imperfective verb formed with the prefix *do-* is informationally stronger than the corresponding sentence headed by a basic (root) imperfective verb. In fact, the former entails the latter.

A sentence with an imperfective verb formed with the iterative prefix *pere-* entails that there is at least one previous event of the same kind (as the verb is imperfective, this can be also a partial event). Hence, it entails the corresponding sentence with a basic (root) imperfective verb, and is thus informationally stronger. This is shown in Table 5.4.

Table 5.3: Informational strength of verbs containing the completive prefix *do-* and simplex verbs

secondary imperfective with <i>do</i> ^a	> _{INF} non prefixed imperfective
dočityvat' ^{IPF} 'to finish/be finishing reading'	> _{INF} čitat' ^{IPF} 'to read'
dodelyvat' ^{IPF} 'to finish/be finishing doing'	> _{INF} delat' ^{IPF} 'to do'

^aGeneric (habitual) uses/meanings of secondary imperfectives are not considered here.

Table 5.4: Informational strength of verbs containing the iterative prefix *pere-* and simplex verbs

secondary imperfective with iterative <i>pere-</i>	> _{INF} non prefixed imperfective
perečityvat' ^{IPF} 'to reread/be rereading'	> _{INF} čitat' ^{IPF} 'to read'
peredelyvat' ^{IPF} 'to redo/be redoing'	> _{INF} delat' ^{IPF} 'to do'

Finally, Table 5.5 illustrates the fact that under negation the scale is reversed. When a secondary imperfective verb that contains the completive prefix *do-* is negated, the scope of negation is either the whole event or its culmination/final part; when a secondary imperfective verb that contains the iterative prefix *pere-* is negated, the scope of negation is the existence of either the whole event or its iteration. On the other hand, the negation of a basic (root) imperfective verb is always the denial of the existence of any part of the event. Thus, under negation a basic imperfective verb represents a stronger alternative than a secondary imperfective one.

In other words, a negated secondary imperfective verb that contains the prefix *do-* or the iterative prefix *pere-* is the weaker alternative if the set of alternatives contains a non-prefixed negated imperfective verb. If the speaker uses the weaker alternative, by the maxim of quantity (Grice 1975) the hearer infers that the stronger alternative, the sentence with a corresponding negated non-prefixed imperfective verb does not hold. This amounts to the inference that at least the 'process' subpart (but not the 'culmination' subpart) of the denoted events took place.

In sum, a perfective verb that denotes accomplishments and contains one of the prefixes in question (*do-* or *pere-*) is informationally stronger than the corresponding secondary imperfective verb containing the same prefix as well as its imperfective simplex base (this follows from the general statement about the

Table 5.5: Informational strength of verbs containing the prefixes *do-* or *pere-* and simplex verbs: negation

negated secondary imperfective with iterative <i>pere-</i> or completive <i>do-</i>	$<_{\text{INF}}$ non prefixed negated imperfective
ne dočityvat ^{'IPF} 'to not (be) finish(ing) reading'	$<_{\text{INF}}$ ne čitat ^{'IPF} 'to not read'
ne perečityvat ^{'IPF} 'to not (be) reread(ing)'	$<_{\text{INF}}$ ne čitat ^{'IPF} 'to not read'
ne dodelyvat ^{'IPF} 'to not (be) finish(ing) doing'	$<_{\text{INF}}$ ne delat ^{'IPF} 'to not do'
ne peredelyvat ^{'IPF} 'to not (be) redo(ing)'	$<_{\text{INF}}$ ne delat ^{'IPF} 'to not do'

information conveyed by perfective and imperfective verbs), while at the same time, secondary imperfectives are informationally stronger than their imperfective roots. The emerging scale of informational strength is shown in (26).

- (26) basic imperfective verb (V)
 $<_{\text{INF}}$ secondary imperfective verb (PREF_i + V + iva)
 $<_{\text{INF}}$ prefixed perfective verb (PREF_i+V)

5.3.3 Testing the scalar properties

As I have shown, the standard diagnostics for semantic and pragmatic presuppositions fail to provide us with any clear results for the alleged presuppositional properties of the completive prefix *do-* and the iterative prefix *pere-*. Therefore, other tests are needed. A testing methodology that seems useful for this purpose has been developed in Zinova & Filip 2014. It builds on the study by Chemla (2009), who proposed an experimental design aimed at distinguishing the projection properties of presuppositions from the projection properties of (scalar) implicatures, capitalising on the insights of the presupposition projection theories (e.g., Heim 1983/2002; Schlenker 2008 and references therein). For the purposes of developing the testing methodology, among the most relevant insights of Chemla (2009) are those that concern different types of inferences of sentences that are embedded under the universal quantifiers *every/each* and *no*.

One of the main results obtained in Chemla 2009 is that presuppositions project universally rather than existentially when triggered from the scope of the

universal quantifiers *every* and *no*. Inferences that project universally from the scope of *every* and existentially from the scope of *no* are akin to (scalar) implicatures. Stated more formally, if a sentence *S* with the presupposition $P(x)$ is embedded under the universal quantifiers *every* or *no*, the presupposition of the resulting sentence is universal: $\forall x : P(x)$. This means that the presupposition is the same in sentences with universal assertion (*every*) and universal negation (*no*). However, this property does not hold for (scalar) implicatures. It follows from the procedure of deriving (scalar) implicatures that if a sentence *S* entails that $I(x)$, then *S* embedded under *every* entails that $\forall x : I(x)$ (universal inference) and *S* embedded under *no* implicates that $\exists x : I(x)$ (existential inference).

Note that the examples that are of interest here are those that involve *indirect scalar implicatures*. Direct (scalar) implicatures are cases when, e.g., a sentence that contains *some* is understood as negating a stronger alternative with *all*. Indirect (scalar) implicatures are implicatures which arise when, e.g., a sentence with *all* is understood as negating an alternative with *some*. As an example, consider the sentence (27a). It indirectly implicates (27b).

- (27) a. John read all books. = (13) in Chemla 2009
 b. John read some of the books.

Now, if a sentence with *all* is embedded under the universal assertion, as in (28a), it implicates (28b).

- (28) a. Each student read all the books. = (14) in Chemla 2009
 b. Each student read some of the books.

In order to proceed with the derivation of a scalar implicature in cases in which a scalar item is embedded under the universal negation, let me first illustrate the reasoning that motivates an indirect scalar implicature in a non-embedded negated case. As an example, consider the sentence in (29a) (taken from Chemla 2009). This sentence involves a strong scalar item *all* in a downward entailing context (here negation).

- (29) a. John didn't read all the books. = (12) in Chemla 2009
 b. Alternative: John didn't read any of the books.
 c. Scalar implicature: John read some of the books.

The scalar implicature (29c) of (29a) is derived as follows (following suggestions in Grice 1975; Ducrot 1969; Horn 1972, among others). Sentences with *all*, as (29a), and *any*, as (29b), belong to a set of linguistic alternatives of the same grammatical category, which can be arranged in a linear order by degree of informativeness.

ness. The sentence (29b) is a logically stronger alternative to (29a). If the cooperative and well-informed speaker does not use (29b), the most natural explanation is to conclude that the alternative, (29b), is false. The negation of (29b), ‘It is not the case that John didn’t read any of the books’, is the indirect scalar implicature (29c) of (29a) (the two negations cancel each other out).

Similar reasoning works for deriving the scalar implicature (30c) from the sentence (30a); the alternative (30b) is negated, as it is stronger and was not uttered, and the inference (30c) is obtained.

- (30) a. No student read all the books. = (18) in Chemla 2009
 b. *Alternative*: No student read any book.
 c. *Scalar implicature*: At least one student read some of the books.

5.3.4 The empirical study

Following the results and suggestions in the study by Chemla (2009), a new test for distinguishing between presuppositions and (scalar) implicatures triggered by Russian verbs has been designed (Zinova & Filip 2014). The idea of this test is to embed sentences that contain inferences of an unknown nature under negative universal quantifiers and use a questionnaire to ascertain whether the resulting sentences have universal or existential inferences. From what has been said in Section 5.3.3, it follows that in the case of such an embedding, if the inference of the resulting sentence is universal, the embedded sentence contains a presupposition trigger; if, on the other hand, the inference is existential, the embedded sentence involves a scalar implicature.

Let us consider one Russian example. The sentence (31a) contains a verb with the completive prefix *do-* that is traditionally claimed to be a presupposition trigger, and a universal negation *nikto* ‘nobody’. The alternative sentence that the speaker could have uttered is (31b). It differs from the sentence (31a) by the absence of a prefix on the verb (the aspect stays the same). This alternative sentence, as follows from Table 5.5, is informationally stronger than (31a).

- (31) a. Nikto iz nas ne dočityval^{IPF} učebnik.
 nobody of us not do.read textbook
 ‘None of us finished/was finishing reading the textbook.’
 b. Nikto iz nas ne čital^{IPF} učebnik.
 nobody of us not read textbook
 ‘None of us read [a part of] the textbook.’

Now, there are two possible inferences that (31a) may have: the existential inference (32a) that corresponds to the hypothesis that it is a scalar implicature, and the universal inference (32b) that is in line with its presuppositional nature.

- (32) a. Kto-to iz nas čital^{IPF} učebnik.
 somebody from us read.PST.SG.M textbook
 ‘Some of us read [at least a part of] the textbook.’ *scalar implicature*
- b. Vse iz nas čitali^{IPF} učebnik.
 all from us read.PST.PL textbook
 ‘All of us read [at least a part of] the textbook.’ *presupposition*

In order to establish the nature of inferences in sentences like (31a), an online questionnaire was offered to a number of Russian native speakers. The experimental design was similar to the one used in Chemla 2009: participants were provided with two sentences in each trial and asked to judge if the first one suggests¹ the second one. Respondents were supposed to assume that the first sentence was uttered by a reliable, honest and well-informed speaker² in order to establish a natural context in which Grice’s maxims can be applied.

As the task of determining whether a particular inference holds can be very difficult in some cases, respondents were allowed to choose not only one of the two variants “yes” and “no”, as was done in Chemla 2009, but also “probably yes” and “probably no”. Consequently, a 4-point scale was used, effectively preventing the respondents from selecting the middle variant in difficult cases.

Afterward, the answers were assigned numeric values and mean values were calculated, with the following correspondences between the answers and the numerical values: “yes” was rated as 4, “probably yes” as 3, “probably no” as 2, and “no” as 1. The questionnaire was answered by 140 respondents. It had 4 lists (one participant answered only one list), and there was a minimum of 26 respondents per list. Each list contained 40 trials: 20 fillers and 20 test sentence pairs.

As for the data, two groups of control items and two groups of test items were used. The first group of control items involved sentences with presupposition triggers embedded under universal quantifiers: 10 sentences with the classic presupposition trigger *znat* ‘to know’ and 16 with different types of possessive pronouns. The second group of control items contained 26 pairs of sentences where the second member of the pair was either true or false (also including “pragmatically true/false” ones). The true sentences of this group received the resulting rating of 3.6 and the false sentences got an average of 1.1, which shows that these control items were evaluated correctly. The tested items included 38 pairs of sentences with verbs prefixed with *pere-* and 20 pairs of sentences with verbs prefixed with *do-*.

¹In Russian instructions *predpolagaet*.

²In Russian instructions *nadežnyj, iskrennij i informirovannyj sobesednik*.

5 Pragmatics

A few illustrative examples of sentences used in the questionnaire are provided under (33)–(35). Among the sentences headed by verbs prefixed with *do-* and *pere-* and embedded under negative universal quantifiers were pairs like (33) and (34). Notice that they are analogous to examples (12) and (18) from Chemla 2009. Each participant of the study was presented with only one of the tested inferences (either universal or existential); different inferences were distributed over different lists.

- (33) Nikto iz nas ne doedal^{IPF} “kašu moločnuju”.
none of us not do.eat.PST.SG.M porridge milk
‘None of us were finishing the milk porridge.’

Tested inferences:

- a. Vse probovali kašu.
‘Everyone tried the porridge.’
b. Kto-to proboval kašu.
‘Some of us tried the porridge.’
- (34) Nikto ne peredelal^{PF} rabotu.
Nobody not pere.do.PST.SG.M work
‘No one has redone the work.’

Tested inferences:

- a. Vse sdělali rabotu ranee.
‘Everyone did the work before.’
b. Kto-to sdělal rabotu ranee.
‘Some did the work before.’

One example of a pair of control sentences where the first sentence includes a presupposition trigger *znat* ‘to know’ embedded under a negative universal quantifier is given in (35).

- (35) Nikto iz studentov ne znal, čto prepodavatel’ postavit
None of students not know.PST.SG.M that lecturer put.PRES.SG.3
im začët “avtomatom”.
them credit automatically
‘None of the students knew that the lecturer was going to give them the credit automatically.’

Tested inferences:

- a. Vsem studentam postavjat začët “avtomatom”.
‘All of the students will receive the credit automatically.’
b. Nekotorym studentam postavjat začët “avtomatom”.
‘Some of the students will receive the credit automatically.’

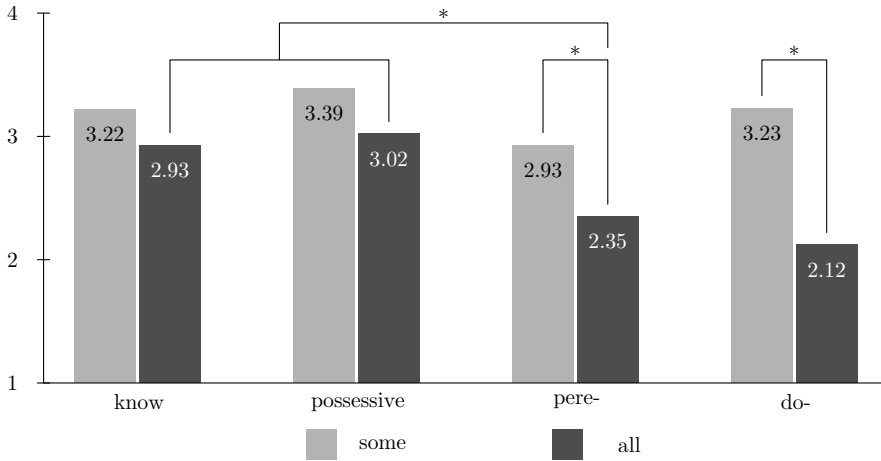

Figure 5.1: Acceptability of existential and universal inferences for different triggers. Asterisks indicate significant difference.

The main results of the questionnaire are provided in Figure 5.1. It turned out that there is no statistically significant difference between the acceptance rates of universal and existential inferences in case of the presupposition trigger *znat* ‘to know’ and possessive pronouns, which is in line with the results obtained in Chemla 2009. There is, however, a statistically significant difference in the acceptance rate of universal and existential inferences in case of test items of both categories: those involving the verb with the completive prefix *do-* and those with the verb prefixed with the iterative *pere-* (*t*-test, $p < 0.001$ in both cases). For the existential inferences, the answers ranged from “yes” to “probably no” and for the universal inferences, from “probably yes” to “no” and the overall results cannot be explained in terms of between-speaker variation. Furthermore, the difference between the acceptance rates in control and test sentences for existential inferences was not significant, while the difference for universal inferences was (*t*-test, $p < 0.001$).

The obtained results strongly suggest that the inferences triggered by the completive prefix *do-* and the iterative prefix *pere-* are not of a presuppositional nature. On the other hand, the observed behaviour is compatible with a scalar implicature analysis.

5.3.5 Conclusion

The standard tests for semantic and pragmatic presuppositions show that inferences triggered by the perfective aspect of accomplishments do not behave like semantic or pragmatic presuppositions.

As for the inferences triggered by prefixes *do-* and *pere-*, standard tests could not be used as evidence for or against presuppositional analysis, and therefore a new testing method is used to establish their nature: a questionnaire based on results of experimental work by Chemla (2009). The projection properties of Russian verbs containing prefixes *do-* and *pere-* in downward entailing contexts (under the universal quantifier *no*) indicate that the projected inference behaves more like scalar implicature than like presupposition.

5.4 The overall pragmatic picture

In Chapter 4, I have evoked the notion of the pragmatic competition several times. In order to see how this competition works on the level of the whole prefixation system to result in the global picture, let us look at the domain of verbal meanings and see how this domain is covered with prefixed verbs. I propose that whenever the general meaning of the prefix is underspecified, the interpretation of a particular verb gets settled in the optimal way for the range of the prefixed verbs derived from one root to cover the range of meanings a speaker may want to express. The reasoning that I outline below is a first sketch of the analysis that must be tested on a wider range of examples.

First let me illustrate the flexibility of the individual prefixes. As we have discussed in Sections 4.4 and 4.5, verbs prefixed with *na-* or *po-* can refer to events that culminate when the expected/standard degree is reached. In addition, verbs prefixed with *na-* can denote events that culminate at the degree higher than the expected degree. As for the verbs prefixed with *po-*, they may refer to events that culminate without reaching the standard degree. This part of the prefixation system is complemented by the prefix *pere-* that contributes the semantics of excess. Let us consider the verbs prefixed with *pere-* in its excessive usage. It turns out that there is always another verb derived from the same base, that is used as a neutral perfective. Under *neutral perfective* I mean either a verb that refers to an action performed until the normal/standard/appropriate degree,³ or a verb that denotes an action that lasted for some non-specified time.⁴ For example, if the verb *gret* 'to heat' is prefixed with *pere-*, the resulting verb *peregret* means 'to overheat'. The same verb can be prefixed with *na-* and the resulting verb *na-gret* means 'to warm up (until the desired temperature)'. In addition, the verb

³These verbs would constitute aspectual pairs with the imperfective source verbs on the pair-based accounts of Russian verbal system. Janda (2007) calls such verbs Natural Perfectives. See also Chapter 2 for a discussion.

⁴Such verbs fall in the Complex Act Perfectives class in the account by Janda (2007).

pogret ‘to heat’ means warming up without necessarily reaching some particular temperature. In this case both *nagret* ‘to warm up’ and *pogret* ‘to heat’ are neutral perfectives, only with respect to different scales. More pairs and triples are provided in the Table 5.6. Let us explore them.

The upper third of the table contains three intransitive verbs. The prefix that is used to form a neutral perfective depends on the scale lexicalised by the verb. If there is no scale except for the time scale, the prefix *po-* is used. If there is a scale that allows for the attachment of the resultative *za-*, it may be the option. The lines in the middle third of the table are occupied by two transitive verbs that denote events that are by default measured according to these verbs’ internal scales and do not rely on the information coming from the verbal arguments. These verbs form neutral perfectives using the prefix *po-*. In the bottom third the other type of transitive verbs is represented: for those verbs the standard is determined for the pairs of event types and undergoers. In such case it is the *na-*prefixed verb that refers to the situation of reaching the standard. The attachment of the prefix *po-* is also possible, but now the *po-*prefixed verbs tend to refer to events in course of which the standard value is not reached.

What we see is that even if the range of prefixes that two verbs can attach is the same, as for the verbs *žarit* ‘to fry’ and *gret* ‘to heat’, the semantic contribution of these prefixes may be different. While both *perežarit* ‘to burn by frying’ and *peregret* ‘to overheat’ have the meaning of excess, the role of the prefix *na-* in the verbs *nažarit* ‘to fry a lot of’ and *nagret* ‘to heat’ seems to be not the same. In what follows we will explore a couple of verbs in detail and see how these differences in the final semantic contribution can be explained using pragmatic competition principles.

Consider the verb *zimovat* ‘to spend the winter’. The OSLIN database of verbal aspect provides the following list of the verbs derived from it: *vyzimovat* ‘to survive the winter’ (usually about the plants), *dozimovat* ‘to spend the rest of the winter’, *zazimovat* ‘to stay for the winter’, *otzimovat* ‘to finish spending the winter’, *perezimovat* ‘to spend the winter’, *pozimovat* ‘to spend some winter time’, *prozimovat* ‘to spend the winter time’. Examples illustrating the usage of these verbs are provided in (36).

- (36) a. Vinograd ne mozet vyzimovat v srednej polose RSFSR.
 grape not can.PRES.SG.3 vy.winter.INF in middle band RSFSR
 ‘Grape cannot survive the winter in the midland of the RSFSR.’
 = example of verb usage from Ušakov 1935–1940

Table 5.6: Distribution of excess-denoting and neutral perfectives across verbal bases and prefixes

source verb	translation	“excess”	neutral	other competing verbs
<i>zanimat’ sja</i>	‘to study’	<i>perezanimat’ sja</i>	<i>pozanimat’ sja</i>	
<i>platit’</i>	‘to pay’	<i>pereplatit’</i>	<i>zaplatit’</i>	<i>oplatit’</i> ^{trans} ‘to pay for smth’
<i>rabotat’</i>	‘to work’	<i>pererabotat’</i>	<i>porabotat’</i>	<i>otrabotat’</i> ^{trans} ‘to work in compensation of smth’
<i>xvalit’</i>	‘to praise’	<i>perexvalit’</i>	<i>poxvalit’</i>	
<i>žarit’</i>	‘to fry’	<i>perežarit’</i>	<i>požarit’</i>	<i>prožarit’</i> ‘to fry thoroughly’, <i>nažarit’</i> ‘to fry a lot of’
<i>gret’</i>	‘to heat’	<i>peregret’</i>	<i>nagret’</i>	<i>pogret’</i> ‘to heat’, <i>progret’</i> ‘to heat through’
<i>kormit’</i>	‘to feed’	<i>perekormit’</i>	<i>nakormit’</i>	<i>pokormit’</i> ‘to feed’
<i>trenirovat’</i>	‘to train’	<i>peretrenirovat’</i>	<i>natrenirovat’</i>	<i>potrenirovat’</i> ‘to train for some time’

- b. Dozimuem na korable vo l'dax.
do.winter.PRES.PL.1 on ship in ice.PL.PREP
'We will spend the rest of the winter on a ship on the ice.'
= example of verb usage from Ušakov 1935–1940
- c. Èkspedicija zazimovala na Novoj Zemle.
expedition.SG.NOM za.winter.PST.SG.F on Novaya Zemlya
'The expedition wintered on Novaya Zemlya.'
= example of verb usage from Ušakov 1935–1940
- d. Otzimovali my pervuju zimu, k vesne
ot.winter.PST.PL we first winter.SG.ACC, to spring
priezžaet Matveič.
pri.ride.PRES.SG.3 Matveich
'We have spent the first winter, Matveich will arrive when the spring comes.'
Dmitrij Karalis. *Roman s heroinej* (2001)
- e. Perezimovat' v derevne.
pere.winter.INF in village.SG.PREP
'To spend the winter in a village.'
= example of verb usage from Ušakov 1935–1940
- f. Ix by k nam na severa, čtoby pozimovali v svoix
they to us on north.PL.PREP, that po.winter.PST.PL in their
kartočnyx domikax.
card house.PL.PREP
'I would like to see them spending winter time here in the north in their houses of cards.'
doskapozorakomi.ru
- g. Po obyčaju togo vremeni polk naš
along custom that time regiment.SG.NOM our
prozimoval v odnix i tex že kvartirax osem'
pro.winter.PST.SG.M in one and that same flat.PL.PREP eight
zim s liškom.
winters with over
'According to the customs of that time our regiment spent a bit more than eight winters in the same flats.'
T. G. Ševčenko. *Kapitanša* (1855)

The abundance of the derivatives of the verb *zimovat'* 'to spend the winter' that one finds in the dictionary data, turns out to be undermined by the status of some of these verbs in the contemporary language. Two verbs from this list are barely used (*vyzimovat'* 'to survive the winter' and *otzimovat'* 'to finish spending

the winter'), the verb *prozimovat'* 'to spend the winter time' has been used but is not common any longer (corpora examples are mostly dated with the XIX century), so we are left with four verbs that are actually encountered in text and speech: *zazimovat'* that refers to the beginning of the 'spending the winter' event, *dozimovat'* that focuses on its end, *perezimovat'* that denotes spending the time of the whole winter, and *pozimovat'* that is not related to a specific portion of the winter, but to any amount of the winter time (can be part of one winter or multiple winters). With these four verbs, we see how the available prefixed verbs cover the domain of fixing different set of points: *pozimovat'* 'to spend some winter time' describes a finished event of staying in some particular place without imposing further restrictions on the start and the end of the stay; *zazimovat'* 'to stay for the winter' establishes a connection between the start of a stay in one place and the beginning of the winter; *dozimovat'* 'to spend the rest of the winter' fixes the end point of the stay to be related to the end of the winter; *perezimovat'* 'to spend the winter' relates both the start and the end points of the stay to the beginning and the end of the winter, respectively.

The question I want to answer here is why, for example, the verb *pozimovat'* 'to spend some winter time', that contains the prefix *po-* and therefore could, from the semantics point of view, mean 'to spend the whole winter', is usually not used to refer to such an event. Similarly, the verb *dozimovat'* 'to spend the rest of the winter' is also not used to refer to the situation of spending the whole winter despite the fact that there is no semantic restriction that would prevent it. To see how the distribution of the meanings gets established, let us first represent the different logically natural meanings that can be realised by means of the prefixed verbs.

It is reasonable to assume that if the speaker wants to refer to a completed event of spending some winter time at a particular location, there are in principle four situations that they may want to describe (as there are only two distinguished points on the time scale in this case): the situation of spending one whole winter, the situation of spending the initial part of the winter, the situation of spending the final part of the winter, and the situation of spending some time of the winter without bounding the event duration to the duration of the winter. These four situations are presented in Table 5.7.

Now let us see which prefixed verbs can describe which of the situations t_1-t_4 given the restrictions in the semantics of these prefixes. As we have discussed before, for the prefix *pere-* this will be the equation of both event start and event end to the start and the end points of the relevant scale. The prefix *za-* necessarily equates the start point of the event with the start point of the scale, the prefix *do-* only fixes the end point of the event, equating it with the end point of the relevant

scale. The prefix *po-*, in turn, does not restrict the positions of the start and the end points of the event with respect to the scale. In our case the scale in question is the time scale with the start and the end points associated with the start and the end of the winter. The combination of the meanings specified in Table 5.7 with the restrictions imposed by particular prefixes is shown in Figure 5.2.

Table 5.7: The domain of terminated events related to spending the winter

	event start = winter start	event end = winter end
t ₁	+	+
t ₂	+	-
t ₃	-	+
t ₄	-	-

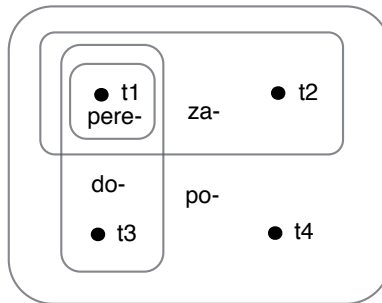

Figure 5.2: Possible interpretations of the verbs derived from *zimovat* ‘to spend the winter’, see also Table 5.7

Now pragmatic theory (e.g., Optimality Theory, henceforth OT, see Blutner 2000; van Rooy 2004; Benz & Mattausch 2011) can be applied to the underspecified semantics representations of the prefixed perfective verbs derived from the base verb *zimovat* ‘to spend the winter’. As is shown in Figure 5.2, the optimal usage of prefixed verbs would be to describe t₁ with the verb *perezimovat* ‘to spend the winter’, t₂ and t₃ – with the verbs *zazimovat* ‘to stay for the winter’ and *dozimovat* ‘to spend the rest of the winter’, respectively. The verb *pozimovat* ‘to spend some winter time’ is then used in the situation t₄, but not in the other cases. This is exactly the distribution that is observed in the data.

The case of the verbs that refer to the time scale only is in a way the simplest, as there are no other scales intervening. Let us now consider the verb *gret*

5 Pragmatics

‘to heat’ that is also part of Table 5.6. The default scale for this verb is the temperature scale. The distinguished point on this scale is the desired/appropriate temperature (let us call it t_s). Temperature t_s depends on the direct object, as the verb *gret* ‘to heat’ is transitive. It is also possible to talk about the other point on the scale that represents the temperature of the object at the start of the heating event, but it is not relevant for determining the space of meanings. With this we obtain three possible meanings related to the temperature scale that one may want to express: reaching a point below the distinguished point, reaching exactly the distinguished point, and reaching some point above the distinguished point. Let us call the temperature reached by the end of the heating event t_f . The space of meanings is presented in Table 5.8.

Table 5.8: The domain of terminated events related to heating

	$t_f > t_s$	$t_f = t_s$	$t_f < t_s$
t_1	1	0	0
t_2	0	1	0
t_3	0	0	1

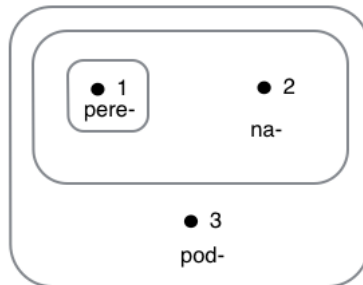

Figure 5.3: Possible interpretations of the verbs derived from *gret* ‘to heat’, see also Table 5.8

What we see in Figure 5.3 is the range of the meanings that certain prefixed verbs derived from the verb *gret* ‘to heat’ may cover given the general restrictions for the semantics of these prefixes. In particular, the verb *peregret* ‘to overheat’ can refer only to the situation of heating the object more than up to t_s . The verb *nagret* ‘to warm up’ could refer to the same situation as well as to heating exactly up to the expected temperature (this temperature can be also specified

via a measure phrase). The verb *podogret* ‘to heat to some degree’ that contains the prefix *pod-* (not discussed in details in this work) can refer to an event of heating that terminates with a temperature being lower than t_s . The verb *pogret* ‘to heat’ can refer to any event of heating.

Applying OT to the verb-meaning pairs represented by Figure 5.3 results in the prediction that in the situation of overheating the verb *peregret* ‘to overheat’ should be used. In the situation of reaching the t_s the appropriate description is provided by the verb *nagret* ‘to heat’. The verb *podogret* ‘to heat to some degree’ denotes exactly the situations when the temperature reached at the end of the heating event is below t_s . As all the relevant scenarios are covered by more specific verbs, the verb *pogret* ‘to heat’ is used when the degree of change is not at issue and thus it is a neutral perfective.

Taking just two verbs *zimovat* ‘to spend the winter’ and *gret* ‘to heat’ as examples already allows us to see the source of the observed variability of the prefix interpretations. As a part of the verb *pozimovat* ‘to spend some winter time’, the prefix *po-* tends to be interpreted as restricting the portion of the winter time to be below the standard (where the standard is the duration of the winter). As a part of the verb *pogret* ‘to heat’ the same prefix does not restrict the duration of the heating event, and the resulting verb often refers to an event of heating for the standard time.

The description of the pragmatic competition I offer here is a first sketch. It works nicely in a number of cases I explored, but it must be tested on a wider range of verbs. Further elaboration of the approach as well as answering questions related to such architecture of the analysis goes beyond the scope of this thesis. There is a hope that the preliminary analysis I proposed here can be implemented using the computational pragmatics approach of Rational Speech Act Theory (RSA, Franke 2009; Frank & Goodman 2012; Goodman & Stuhlmüller 2013; Franke & Jäger 2015; Goodman & Frank 2016).

One more question that I want to mention is whether the reasoning that is used to find an optimal distribution of meanings among the available verbs is computed online or is conventionalised. The account outlined here does not favour one of the views on this process, although the status of the semantic representations for prefixes depends on the answer to this question. In future work, I plan to experimentally test whether speakers operate with the underspecified semantic representations or with conventionalised representations.

5.5 Summary

In this chapter, I have explored inferences associated with perfective aspect and prefixes *do-* and *pere-*. I have provided tests that address the claim about the presence of the presuppositional component within all perfective verbs and within verbs that are derived by prefixes *do-* and *pere-*. For the whole class of perfectives the standard tests were enough to show that the inference in question does not have the presuppositional nature. In order to test whether prefixes *do-* and *pere-* trigger presuppositions I had to use a specially developed questionnaire. I then concluded that the observed inferences are better analysed as entailments and (scalar) implicatures (in positive and negative environments, respectively) then as presuppositions.

In the second part of the chapter, I have proposed a preliminary analysis in terms of Optimality Theory of how the prefixation system in Russian works as a whole. The idea that I plan to develop in future work is that the exact interpretation of the given verb depends on the range of competing verbs derived from the same base, while the semantic representation remains underspecified. The set of competing verbs in turn depends on the type of the scale the verb is associated with.

6 Frame semantics for prefixes

As I have shown in the previous chapters, Russian verbal prefixation is a complex system that cannot be successfully modelled by means of one linguistic layer. In order to simplify individual components of the system and allow for the observed flexibility without massive overgeneration, one needs to coordinate the work of the morphological, syntactic, semantic, and pragmatic representations, as well as describe the interfaces between them. In the fragment I describe here I limit myself to the first three systems, leaving pragmatic strengthening at the level of a tentative proposal provided in Chapter 5. Even with this limitation there are not a lot of formalisms that would be suitable for such a representation.

Following Kallmeyer & Osswald (2012; 2013), I will adopt a combination of frame semantics (Fillmore 1982) and Lexicalised Tree Adjoining Grammars (LTAG, Joshi & Schabes 1997; Frank 1992; Abeillé & Rambow 2000; Abeillé 2002; Frank 2002). This framework has various benefits, such as a transparent syntax-semantics interface, numerous factorisation possibilities within the lexicon (especially important for modelling of the derivational morphology), and cognitive plausibility. More information about the advantages of frame-based LTAG semantics can be found in Kallmeyer & Osswald (2013).

In this chapter, I concentrate on the semantic side of the analysis and show semantic composition that is triggered by operations at the morphological and syntactic levels. I also provide trees and tree fragments that are associated with the proposed semantic frames, but the presentation is kept on a level suitable also for those readers that are not familiar with LTAG and XMG 2 (Petitjean et al. 2016). In Chapter 7 I will provide more technical details about the syntactic part of the analysis, metagrammar decomposition, and specific implementation problems. As for the material that I present in this chapter, the number of decisions motivated by the framework restrictions is small and I discuss all of them. Thus, the proposed frames can be easily adapted to be used within some other framework or even translated into another language of semantic description, e.g. Neo-Davidsonian event representation.

6.1 LTAG and frame semantics

6.1.1 TAG

Tree Adjoining Grammar (TAG, Joshi & Schabes 1997; Abeillé & Rambow 2000) is a tree-rewriting grammar formalism. A TAG consists of a finite set of *elementary trees* with labelled nodes with two operations on them: *substitution* and *adjunction*.

All elementary trees are either *auxiliary trees* or *initial trees*. An *auxiliary tree* is a tree which has exactly one *foot node* – a leaf that is marked with an asterisk. Leaf nodes can be labelled with terminals and other nodes are labelled only with non-terminals. The derivation process starts from an initial tree and in the final *derived tree* all the leaves must be labelled by terminals.

Substitution allows to replace a non-terminal leaf with a new tree and adjunction is used for replacing an internal node with an auxiliary tree. Adjunction to the node labelled with X is allowed if the root and foot nodes of the adjoining auxiliary tree have the same label X. It is also possible to indicate nodes where adjunction is obligatory or not allowed and to specify the set of all possible trees for adjunction.

Figure 6.1 shows an example of a derivation: the initial tree for *Mary* substitutes into the subject slot of the elementary tree for *laughs*, and the *sometimes* auxiliary tree for the VP modifier adjoins to the VP node. The result of performing these two operations is shown on the right side of the same figure.

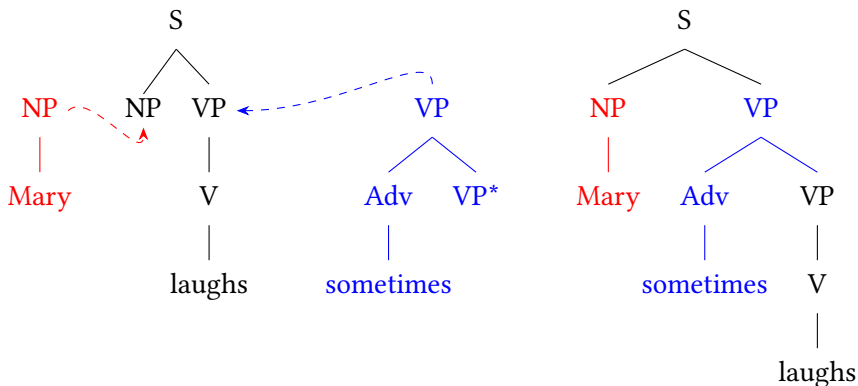

Figure 6.1: Example of a TAG derivation

6.1.1.1 Feature-structure based TAG

Feature-structure based TAG, or FTAG, is a variant of TAG in which elementary trees are enriched with feature structures (Shanker & Joshi 1988). Using feature structures as non-terminal nodes allows to generalise agreement via underspecification, helps to model adjunction constraints and leads to more compact grammars.

For example, Figure 6.2 shows the derivation of the sentence *Grammars leak* without feature structures and some trees involved in it (this example, including Figures 6.2–6.5, is due to Timm Lichte). One can see that already such a small piece of derivation contains a lot of redundancy that cannot be avoided if only labelled categories are used. In such a TAG, the following trees have to be kept in the grammar for a regular noun, such as *grammars*: third person singular nominative, third person singular accusative, plural nominative, and plural accusative.

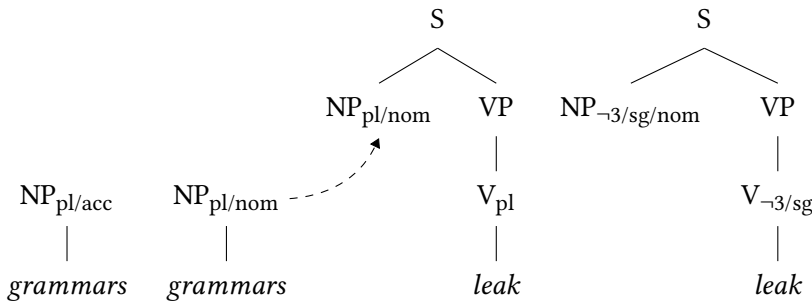

Figure 6.2: Example of a derivation for *Grammars leak* without feature structures

If feature structures are used, the example described above looks as shown on Figure 6.3. In this case only two entries for the noun *grammar* must be kept in the lexicon: one for the single form *grammar* and one for the plural form *grammars*. Case can remain underspecified, as it does not influence the surface form of the noun.

However, when adjunction is performed, the adjunction site is practically split in two. In this case, feature structures must be also split. Such a split has been proposed by Shanker & Joshi (1988). The idea behind it is that top features should show “what the node represents in the surrounding structure” and bottom features should show “what the tree below the node represents”.

As a result, in an FTAG all the nodes have a top feature structure and, furthermore, all nodes except substitution nodes have a bottom feature structure.

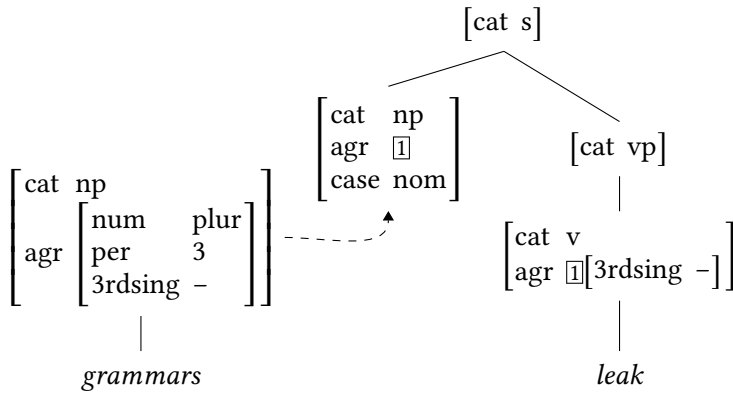

Figure 6.3: Example of a derivation for “Grammars leak” with feature structures

Feature unification applies during the derivation process when adjunction and substitution take place and is performed according to the following rules:

- when substitution takes place, the top of the root of the rewriting tree unifies with the top of the substitution node;
- when adjunction takes place, the top of the root of the rewriting tree unifies with the top of the adjunction site, and the bottom of the foot of the rewriting tree unifies with the bottom of the adjunction site (as illustrated by Figures 6.4 and 6.5).

In the final derived tree, top and bottom feature structures unify for all nodes. Feature structures used in an FTAG are allowed to have re-entrancies, but the same attribute should not occur on the path more than once. Due to the extended domain of locality of TAGs, nodes within one elementary tree can share features, allowing to express constraints among dependent nodes easily. On the other hand, the feature structures of FTAG belong to a finite set and thus do not add expressive power, so FTAG and TAG are weakly equivalent.

6.1.1.2 Lexicalised TAG

Abeillé (2002) and Frank (2002) formulate principles that specify how TAG elementary trees should look like if they are used to model natural languages. First, each elementary tree must have at least one non-empty lexical item. This item is called *lexical anchor*. When all the elementary trees satisfy this condition, a

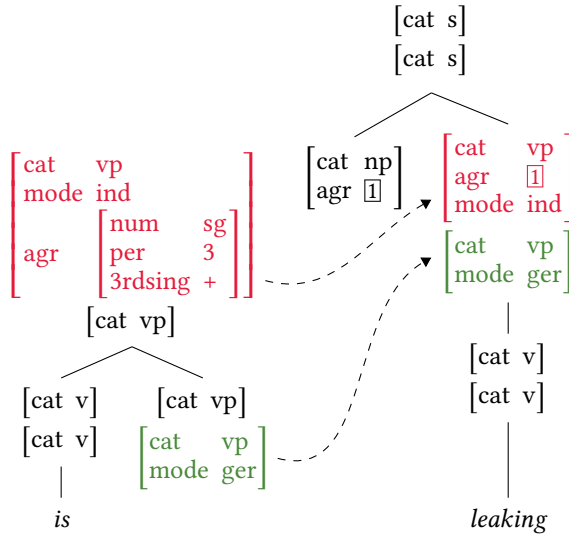

Figure 6.4: Adjunction of *is* into the tree for *leaking*

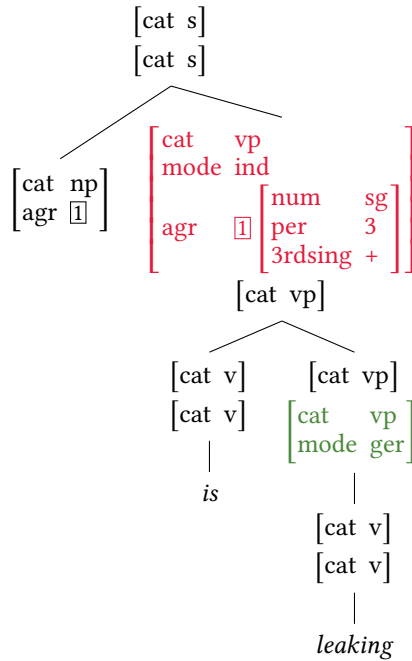

Figure 6.5: Adjunction of *is* into the tree for *leaking*: result

TAG is called *lexicalised TAG*, or LTAG. This property has been argued to be a reasonable requirement with respect to modelling of natural languages. On the computational side it reduces the parsing time.

The second important principle for a natural language TAG is called *theta-criterion for TAG* (Frank 1992), or *elementary tree minimality*. It requires that every elementary tree with a predicate as a lexical anchor must contain slots (substitution nodes or foot nodes) for all arguments of this predicate (including the subject) and for nothing else. Nominal arguments are usually represented as substitution nodes, whereas sentential arguments are often realised by foot nodes in order to allow long-distance dependency constructions through adjunction (Kroch 1989; Frank 2002).

As I have already mentioned, there are several levels of factorisation of the LTAG lexicon. The first step is the separation of lexical anchors and tree templates (unanchored elementary trees). As a second step, the set of elementary trees is organised into tree families. Each tree family represents all possible realisations of one subcategorisation frame: e.g., there is a tree family for transitive verbs (this means transitive verbs should be used as lexical anchors, i.e. fill the node marked with a diamond). This tree family contains patterns as shown on Figure 6.6: canonical position, argument extraction, realisation in combination with a passive verb form, among others.

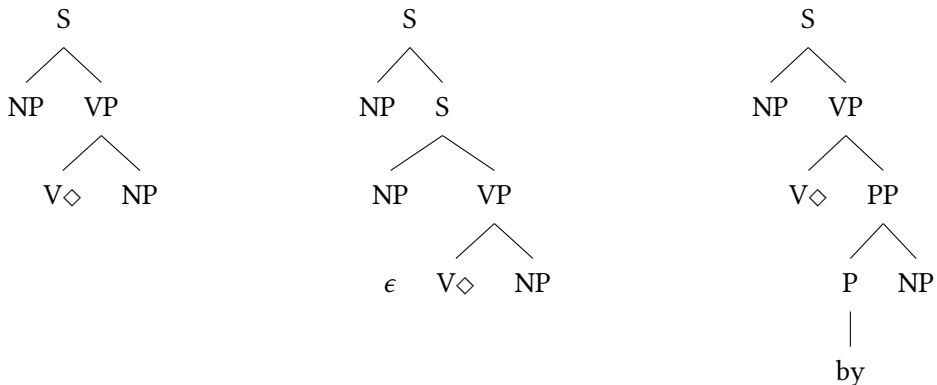

Figure 6.6: Some elementary trees from the transitive verb tree family

The next factorisation level is the decomposition of tree templates into tree fragments, that is done using a *metagrammar* description (Candito 1999; Crabbé & Duchier 2004; Crabbé et al. 2013). The idea of the metagrammar is to define tree fragments that can be used in different tree templates and tree families. These tree fragments are minimal models of a constraint system that operates in terms

of category assignments and dominance and precedence relations. Such system allows for a compact linguistic description that captures generalisations.

The level of the metagrammar is well-suited for capturing derivational morphology processes: it allows for a general description of derivational patterns that can be accompanied by a change of the argument structure. I will talk about the technical details of the metagrammar description in Chapter 7. As for now, it is important to know that frames shown in what follows belong to four different description levels:

1. frames for the prefixes, frames used for coercion, and dimension constructors accompany special tree fragments that are described in the metagrammar;
2. frames for the verbs are stored in the dictionary;
3. frames that represent the result of combining the frame for the derivational base and the prefix frame are obtained when the unanchored trees produced by the metagrammar description get anchored;
4. frames that represent the semantics of a verbal phrase are obtained on parallel with the syntactic parsing.

6.1.2 Frame semantics

The idea of using frame representations in linguistic semantics and cognitive psychology has been put forward by Fillmore (1982) and Barsalou (1992), among others. A widescale realisation of this idea is the Berkeley FrameNet project (Fillmore et al. 2003). The goal of this project is to describe a huge variety of situations by basic role frames that represent the type of the situation and the semantic roles of its participants. One issue that FrameNet does not address is modelling compositional semantics: the frames used in the project are static and do not interact with each other. In order to widen the area where frames could be used, a number of studies that offer further formalisation of the frame theory has been conducted in the last years (Petersen 2007; Petersen & Osswald 2009; Kallmeyer & Osswald 2012; 2013; Kallmeyer et al. 2015; Löbner 2014, among other).

The main ideas that motivate the use of frames as a general semantic and conceptual representation format can be summarised as follows (cf. Löbner 2014):

- conceptual-semantic entities can be described by types and attributes;
- attributes are functional relations, i.e., each attribute assigns a unique value to its carrier;

6 Frame semantics for prefixes

- attribute values can be also characterised by types and attributes (recursion);
- attribute values may be connected by additional relational constraints (Baralou 1992) such as spatial configurations or ordering relations.

These ideas are formalised in Kallmeyer & Osswald (2013) who define frames as *base-labelled feature structures with types and relations*. Frames in the sense of Kallmeyer & Osswald (2013) are finite relational structures in which attributes correspond to functional relations. The members of the underlying set are referred to as the *nodes* of the frame. An important restriction is that any frame must have a *functional backbone*. This means that every node has to be accessible via attributes from at least one of the *base nodes*: nodes that carry *base labels*. Importantly, feature structures may have multiple base nodes. In such a case often some nodes that are accessible from different base nodes are connected by a relation.

Base labels serve as unique identifiers, that is, a given base label cannot be assigned to more than one node. Due to the functional backbone requirement, every node of the frame can be addressed by a base label plus a (possibly empty) finite sequence of attributes. The middle column of Figure 6.7 (this figure and Figure 6.8 are provided by Rainer Osswald) illustrates this fact for the frame depicted on the left of the figure, where circles represent nodes, the bold-face letters **b** and **c** are base labels, labels of solid arrows stand for attributes, labels of dotted arrow indicated (binary) relations, and the symbols *s* and *t* are types.

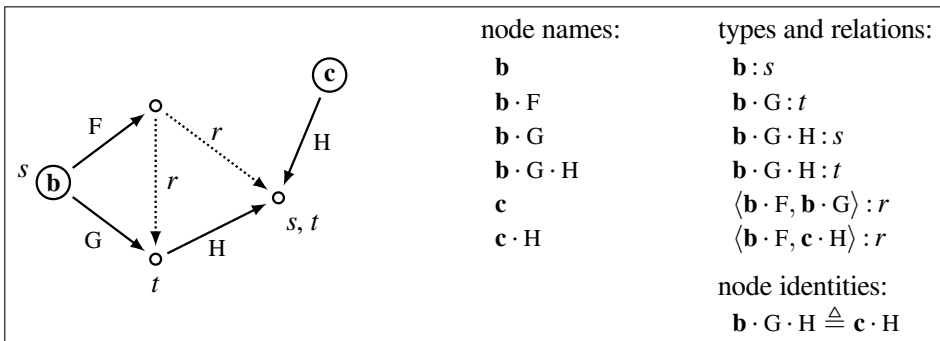

Figure 6.7: Example of a base-labelled feature structure with types and relations

As the example in Figure 6.7 reveals, a node can have more than one type. The special property of the type system used in frame theory as it is presented in Kallmeyer & Osswald 2013 is that type conjunction is always possible unless it

violates explicitly stated incompatibility constraints. We will return to the discussion of the type hierarchy in Section 6.1.4.

Frames as attribute-value descriptions can be reformulated in terms of first-order predicate logic and thus related to other semantic representation formats, such as Neo-Davidsonian event semantics. In such a reformulation (fully described in Kallmeyer & Osswald 2013: Section 3.3.3), types and base labels are regarded as one-place predicates, attributes as two-place predicates, and relation symbols as n -place predicates with $n > 1$. In addition, attributes are required to be functional and base labels must not denote more than one node; that is, the following two axioms are assumed to hold for all attributes f and base labels l :

$$(1) \quad \forall u \forall v \forall w (f(u, v) \wedge f(u, w) \rightarrow v = w) \quad \text{and} \quad \forall u \forall v (l(u) \wedge l(v) \rightarrow u = v)$$

The frame shown on Figure 6.7 can be viewed as a *model* of the formula shown on the upper left of Figure 6.8 (in the sense of predicate logic). This model also satisfies the formulas given in (1). In what follows I will use frames in form of attribute-value matrices, like the frame shown on the right side of Figure 6.8.

predicate logic:	attribute-value matrix:
$\begin{aligned} &\exists v_0 \exists v_1 \exists v_2 \exists v_3 \exists v_4 (\mathbf{b}(v_0) \wedge s(v_0) \wedge F(v_0, v_1) \\ &\quad \wedge G(v_0, v_2) \wedge t(v_2) \wedge r(v_1, v_2) \\ &\quad \wedge H(v_2, v_3) \wedge s(v_3) \wedge t(v_3) \wedge r(v_1, v_3) \\ &\quad \wedge \mathbf{c}(v_4) \wedge H(v_4, v_3)) \end{aligned}$	$\mathbf{b} \begin{bmatrix} s \\ F \boxed{1} \\ G \boxed{2} \left[\begin{array}{l} t \\ H \boxed{3} s \wedge t \end{array} \right] \end{bmatrix}$
<p>attribute-value logic:</p> $\mathbf{b} : (s \wedge G : (t \wedge H : (s \wedge t)) \wedge [F, G] : r \wedge [F, G \cdot H] : r) \\ \wedge \mathbf{b} \cdot G \cdot H \triangleq \mathbf{c} \cdot H$	$\begin{array}{l} r(\boxed{1}, \boxed{2}) \\ r(\boxed{1}, \boxed{3}) \\ \mathbf{c} \left[H \boxed{3} \right] \end{array}$

Figure 6.8: Alternative ways of specifying the frame on the left side of Figure 6.7

For the purposes of a metagrammar specification we need another way of description of frames: attribute-value logic that is defined by Kallmeyer & Osswald (2013: Section 3.3.2). It is constructed as a language of general attribute-value descriptions and then complemented by base labels.

The primitive general attribute-value descriptions over a signature $\langle A, T, R \rangle$ are expressions of the form:

$$t, r, p : t, p \doteq q, p \triangleq q, (p_1, \dots, p_n) : r$$

and

$$\langle p_1, \dots, p_n \rangle : r, \text{ with } p, p_i, q \in A^*, t \in T, \text{ and } r \in R.$$

For a feature structure $F = \langle V, \delta, \tau, \pi \rangle$ over a signature $\langle A, T, R \rangle$ with $v, w, v_i \in V$ the satisfaction relation \models between attribute-value descriptions and nodes/node tuples of F is defined as shown in (2) (Def. 3 in Kallmeyer & Osswald 2013).

- (2)
- | | |
|--|---|
| a. $v \models t$ | iff $v \in \tau(t)$ |
| b. $\langle v_1, \dots, v_n \rangle \models r$ | iff $\langle v_1, \dots, v_n \rangle \in \rho(r)$ |
| c. $v \models p : t$ | iff $\delta(v, p) \models t$ |
| d. $v \models p \doteq q$ | iff $\delta(v, p) = \delta(v, q)$ |
| e. $\langle v, w \rangle \models p \doteq q$ | iff $\delta(v, p) = \delta(w, q)$ |
| f. $v \models \langle p_1, \dots, p_n \rangle : r$ | iff $\langle \delta(v, p_1), \dots, \delta(v, p_n) \rangle \models r$ |
| g. $\langle v_1, \dots, v_n \rangle \models \langle p_1, \dots, p_n \rangle : r$ | iff $\langle \delta(v_1, p_1), \dots, \delta(v_n, p_n) \rangle \models r$ |

Labelled attribute-value descriptions are of the form $l \cdot \phi, l \cdot p \doteq k \cdot q$, and $\langle l_1 \cdot p_1, \dots, l_n \cdot p_n \rangle : r$, with $k, l, l_i \in B$. The satisfaction conditions are listed in (3) (Def. 4 in Kallmeyer & Osswald 2013).

- (3)
- | | |
|---|---|
| a. $\langle F, \beta \rangle \models l \cdot \phi$ | iff $\beta(l) \models \phi$ |
| b. $\langle F, \beta \rangle \models l \cdot p \doteq k \cdot q$ | iff $\langle \beta(l), \beta(k) \rangle \models p \doteq q$ |
| c. $\langle F, \beta \rangle \models \langle l_1 \cdot p_1, \dots, l_n \cdot p_n \rangle : r$ | iff $\langle \delta(\beta(l_1), p_1), \dots, \delta(\beta(l_n), p_n) \rangle \models r$ |

Labelled descriptions are allowed to be combined with Boolean operators. The attribute-value matrix shown on the right side of Figure 6.8 can be regarded as a normal form of the attribute-value description given at the bottom of the left side of the same figure.

6.1.3 Combining TAG and frame semantics

There is a number of properties that make LTAG a good candidate for a combination with a frame-based compositional semantics. Two properties are especially important in this respect: the combination of an extended domain of locality and the fact that elementary trees are lexicalised and contain slots for all the arguments of the respective predicate. This allows to link semantic representations directly to the argument slots. It is also convenient that no structural parallelism is required between the syntactic and semantic representations, as argument linking is explicit. The combination of an LTAG and frame semantics has been introduced in Kallmeyer & Osswald (2012) and the most extensive description so far has been provided in Kallmeyer & Osswald (2013: Section 4.1).

In the approach proposed in Kallmeyer & Osswald (2013) that I adopt here, a single semantic representation (a semantic frame in this case) is linked to the en-

tire elementary tree. When an elementary tree is coupled with a semantic frame, syntactic arguments can be directly linked to their counterpart in the semantics. (Similar approaches with different semantic representation frameworks were introduced earlier in Gardent & Kallmeyer 2003 and Kallmeyer & Romero 2008.) Semantic composition is then modelled by unification, which is a result of performing adjunctions and substitutions. Figure 6.9 provides a simple illustration of the syntactic and semantic composition. The feature I on the nodes is a syntax-semantics interface feature. It stands for “individual” and is used for argument linking. In this example, substitutions trigger unifications between the nodes 1 and g and between the nodes 2 and h. This leads to the correct insertion of the argument frames into the frame of loves. The resulting frame representation is shown on Figure 6.10.

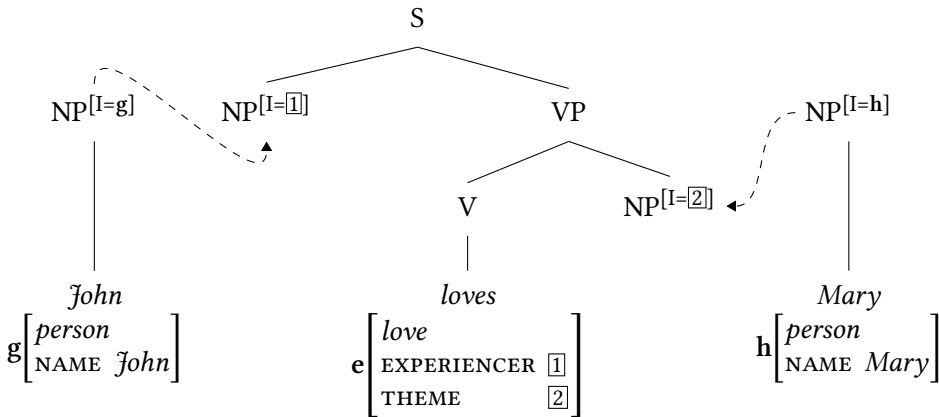

Figure 6.9: Syntactic and semantic composition of *John loves Mary*

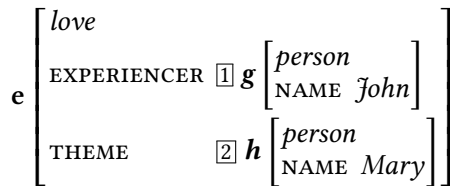

Figure 6.10: Result of frame unifications shown on Figure 6.9

6.1.4 Type hierarchy

The type hierarchy is one of the crucial elements of the analysis, as it is the main mechanism of blocking derivations. Since the number of syntactic restric-

tions I use is very limited, many derivations will be filtered out by the semantic constraints. For this, there are two main mechanisms: unification failure (type incompatibility or conflicting attribute values) and constraint failure (requirement for the two values to be in a specific relation is not satisfied).

As I have already mentioned above, any two types can be unified unless there is an explicit constraint that prohibits it. Due to this, adding new types to the type hierarchy is an operation that in most cases can be performed very fast: usually all that one has to do is to specify one or more supertypes of the new type. I will use the term *subtype of type x* to refer to a type that is ordered under the type *x*. Such hierarchy architecture leads to a large number of connections (e.g. in comparison with a type hierarchy in HPSG, Pollard & Sag 1994), so I will not show the full hierarchy of types used in this chapter, and mostly talk about the relevant restrictive statements (incompatibility of certain types).

The list of types I use for the frames in this chapter and for the implementation to follow can be divided into three major categories (three subtypes of the type *root*): *entity*, *event*, and *scale*. Among these, *entity* is the only type that is not compatible with the other two. It has subtypes *object* and *person*, that in turn have subtypes and are not compatible with each other. As I do not aim at constructing a large ontology, I use trivial object types and assume that they cannot be unified.

The part of the hierarchy that is more interesting for the current analysis concerns the subtypes of events and scales. Let us start with events. I will be using the following types of events (not compatible with each other): *process*, *state*, and *transition*. These types can be combined with the event types *bounded-event* and *iteration*. Such classification covers Vendler's (Vendler 1967) four-way distinction between states, activities (*process* here), accomplishments (*process* \wedge *bounded-event* here), and achievements (*transition*). What is not built into the type system is the distinction between dynamic and static states, that is used, e.g., by Bach (1986). The rest of the classification proposed in Bach 1986 is effortlessly expressed: *process* has the same name, protracted event is a *process* \wedge *bounded-event*, happening is *transition*, and culmination is *transition* that has a preparatory phase. These types may have subtypes: e.g., *translocation* and *change-of-state* are subtypes of a *process*.

The last and most important part of type hierarchy for this work is the domain of scales. The main subtypes of the type *scale* are *closed-scale*, *one-marked-point*, *proper-scale*, *measure-of-change*, *cardinality*, and *property*. These six types come in three groups such that the subtypes of one group are not compatible with each other. The first group is constituted by the types *closed-scale* and *one-marked-point*, that refer to the presence of end points and are not compatible with each other. To the second group belong the types *measure-of-change* and *proper-scale*.

They describe how the scale is organised: in case of a *proper-scale*, for each point of the scale there must be an event stage that is characterised exactly by this point. The *measure-of-change* scale type does not have such requirements: as long as the initial and the final stage of the event are associated with particular scale values, any intermediate stages are allowed. The last group is formed by the *cardinality* and *property-scale* types that refer to the dimension and not to the structure of the scale. Subtypes of the *property-scale* type (such as *colour*, *temperature*, *length*, *amount* etc.) are not compatible with each other. The *cardinality* type of the scale allows to talk about iterated events.

A special case is the case of conjunction of the types *event* and *scale*. The idea that underlies it is that events may be conceived as carrying a scalar structure by themselves. One can talk about event *stages* that hold at different moments in the course of the event. Thus, stages are instantaneous situations that are ordered by temporal precedence and can be used to talk about time in connection to the event but without relating this to other events in the world or any kind of a global time representation. For more details, see Zinova & Osswald (2016).¹

Now that all the parts needed for the analysis are introduced, let us move to the sections that are dedicated to the particular prefixes.

6.2 Frame semantics for the prefix *za-*

In this section I propose the frame semantic representation for the inchoative interpretation of the prefix *za-* and show how this prefix combines with a verb. To start, let us recall the conclusions that I have made about the prefix *za-* (in particular about its inchoative interpretation) in Chapter 4 by further developing the ideas of Braginsky (2008) and Kagan (2015). First, I proposed that the inchoative interpretation of the prefix is only possible when the derivational base does not contain any explicit scales except for the time scale in their semantic representation. Second, I offered the following description of the semantic contribution of the prefix *za-* under inchoative interpretation: when the prefix is attached, it relates the initial stage of the event to the state of the absence and the final stage of the event to the state of the presence of the activity denoted by the derivational base.

There are two ways in which the proposed requirement regarding the scale type can be connected with the semantic change caused by the prefix attachment: a *restrictive* one and a *conditional* one. With *restrictive* I mean a straightforward

¹Note that it is not necessary to represent time scales this way, more explicit representations will also be compatible with the frames proposed in this chapter.

realisation of the proposal above: select only such verbs that have no other scale rather than time (realised with the self-scaling of the event according to the proposal above) in their semantic structure and then describe the semantics of the derived verb in this case. With *conditional* I mean a proposal of such a prefix semantics that, only in case the input verb is related exclusively to the time scale, the desired output (inchoative interpretation of the derived verb) is produced. I pursue the second, more general option. This choice implies the stronger claim that the semantics of the prefix in combination with the semantics of a verb, yields the correct interpretations (probably with some minor modifications or additional constraints) also in cases when the verb is associated with another type of scale (e.g. a *path* scale or a *property* scale).

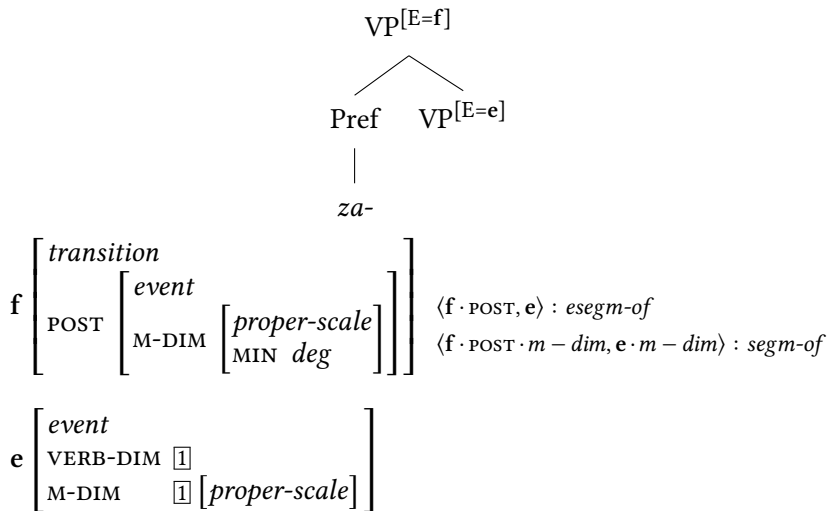

Figure 6.11: Representation of the contribution of the prefix *za-*

The basic frame that I propose in order to represent the general semantic contribution of the prefix *za-* is provided on Figure 6.11 together with a tree fragment that represents the attachment of the prefix (and belongs to the metagrammar description). Informally it can be read in the following way: suppose the derivational base denotes some event *e* that has as its measure dimension some scale of type *proper-scale*. Then the verb prefixed with the prefix *za-* denotes another event that is of type *transition*. A transition is in general characterised by its anterior and posterior states. In this case we are interested in the posterior state that has to be a segment of the event denoted by the derivation base. What we also know is that the scale in the measure dimension of the posterior state of the

transition event corresponds to some initial segment of the scale in the measure dimension of the event denoted by the derivational base. The identity of two attributes VERB-DIM and M-DIM of the event frame on Figure 6.11 ensures that the measure dimension of the event is determined by the verb.

Let me now illustrate what happens when this prefix is attached to a verb. Consider an indeterminate motion verb *begat* ‘to run’. The frame representation of this verb is provided on the left side of Figure 6.12. It refers to an event of type *translocation* with the manner of motion of type *run*. The motion leaves some trace and it is performed by some actor. Note that there is no PATH attribute. This is the assumption made and advocated in Zinova & Osswald 2016, as the TRACE is regarded to be a set of points the object moved through and thus it is present in the description of any event of type *translocation*. The PATH attribute is taken to have a more complex structure and be present only in case of a directed motion event.

Verbal base in the dictionary

$$\mathbf{g} \left[\begin{array}{l} \textit{transloc} \\ \text{MANNER} \left[\textit{run} \right] \\ \text{ACTOR} \quad \boxed{1} \\ \text{TRACE} \quad \boxed{2} \end{array} \right]$$

Verb after dimension constructor

$$\mathbf{g} \left[\begin{array}{l} \textit{transloc} \wedge \textit{scale} \wedge \textit{time} \\ \text{MANNER} \left[\textit{run} \right] \\ \text{ACTOR} \quad \boxed{1} \\ \text{TRACE} \quad \boxed{2} \\ \text{VERB-DIM} \quad \mathbf{g} \end{array} \right]$$

Figure 6.12: Frame representation of an indeterminate motion verb *begat* ‘to run’

The frame on the right side of Figure 6.12 is an enriched variant of the frame on the left: here, information about the verbal dimension is added. Let me explain the idea behind this enrichment in a bit more detail. I claim that from the point of view of the dimension interpretations, all verbs can be divided in two categories: verbs that have a scale they are related to, and verbs that are more flexible in this respect. In the first category fall such verbs as *stoit* ‘to cost’ (price scale), *gret* ‘to warm up’ (temperature scale), *močit* ‘to make wet’ (degree of wetness scale), *letet* ‘to fly (directional)’ (path scale).

The second group of verbs is such that no specific scale is provided in their representation. This means that most of the time these verbs will “accept” the scales “offered” by the direct objects, except for the cases when the prefix demands that the measure dimension is determined by the verb. In these situations the representation of the verb has to be enriched with the information about the scale. The only scale that seems to be generally available as the verbal dimension is the event itself. So the frame on the right side of Figure 6.12 obtains an attribute

6 Frame semantics for prefixes

VERB-DIM with a value of type *scale* that has to be identified with the event itself. The type *scale* then gets conjoined with the type *event*. The separation of the dimension information (if this information is not verb-specific) from the rest of the verbal frame (as it is shown by the different states of the frames on the left and right sights of Figure 6.12) allows for a more compact lexicon representation. At the same time it is also possible to store the enriched representation as a dictionary entry and this is in fact what I have to do in the implementation (see Chapter 7) due to the current restrictions of the formalism.

Now we are ready to unify the verbal frame (on the right side of Figure 6.12) with the prefix frame shown on Figure 6.11. As a result, we obtain the frame for the verb *zabegat* ‘to start running’ that is presented on Figure 6.13. This figure also shows a simplified (no agreement features) initial tree for the derived verb.

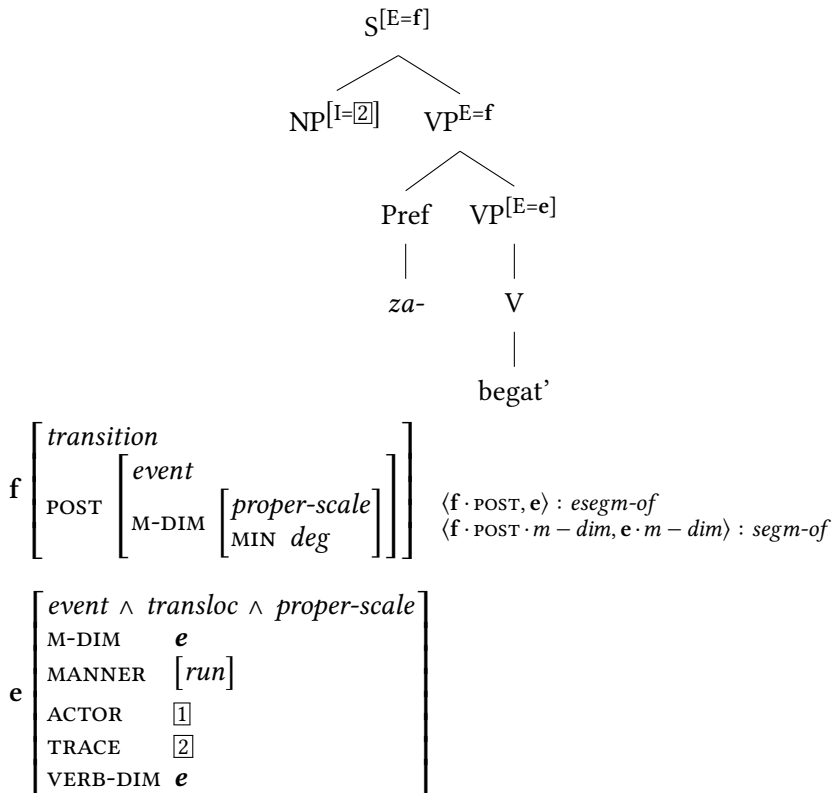

Figure 6.13: Frame representation of the verb *zabegat* ‘to start running’

The frame on Figure 6.13 can be read as follows: the verb *zabegat* ‘to start running’ denotes an event of type *transition* such that the posterior state is a part

of a running event and the minimum degree on the event scale after the transition corresponds to the beginning of running. In other words, the combination of the two frames describes a transition from not running into running, which corresponds to the inchoative interpretation. The noun dimension has to agree with the measure dimension, which becomes relevant in case a direct object is present.

Now I would like to spell out two processes: the process of selection of a sub-part of the scale that is used as a measure dimension of the new event and the process of obtaining the minimum degree on this scale. The first step is to recall that self-scaling means to consider the event as being itself a scale. From this we can derive a general rule that the minimum of the event scale is always the start of the event and the maximum of the event scale is always the end of the event, so those attribute-value pairs get equated. As a consequence, for this type of the scale the interpretation of the *za*-prefixed verb is inchoative, as the posterior state is associated with the initial portion of the event.

I would like to pay attention to one more detail of the analysis: the type of the scale that is used as a measure dimension. As defined by the prefix frame, this scale has to be a *proper* scale. As I have proposed in Chapter 4, proper scales carry more information than measure of change scales and those two types are incompatible (as stated in the type hierarchy and repeated as a constraint in (4)). With this assumption we can show why sentences as (5) are not acceptable, but first we need to construct the frame for the time measure expression 2 *časa* ‘for two hours’.

(4) *proper-scale* \wedge *measure-of-change* $\rightarrow \perp$

(5) #Vasja zabegal_{indet} dva časa.
Vasya ZA.run.PST.SG.M two hours

Let me note that Russian and English time measure expressions are not parallel. For example, the accusative time measure phrase *dva časa* ‘for two hours’ can become a part of a prepositional construction *za dva časa* ‘in two hours’, which is not possible for English (**in for two hours*). Furthermore, it can be used in the *v*-headed prepositional phrase to refer to a point in time (*v dva časa* ‘at two o’clock’). Keeping this in mind, I propose to represent the semantics of the measure expression *dva časa* ‘two hours’ as shown on the left side of Figure 6.14.

Such a representation is neutral with respect to further insertion in various types of constructions and is also shared with other measure-related expressions, such as *p’at’ kilometrov* ‘five kilometres’ and *tri kilogramma* ‘three kilograms’.

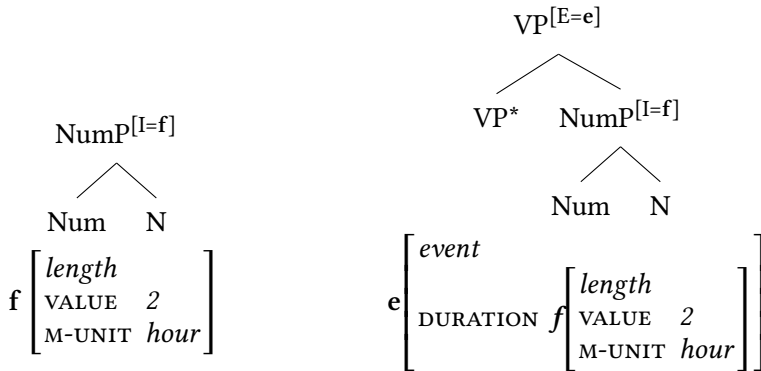

Figure 6.14: Frame representation of the time adverbial *dva časa* ‘for two hours’

In order to combine the measure phrase with a verbal phrase, we need to embed it into the verbal construction as shown on the right side of Figure 6.14. When this is performed, a VP node becomes the head of the phrase, so the measure expression loses the ability to become a part of a prepositional phrase. At the same time another VP node marked as a footnote is created, so now the measure phrase can be adjoined at a VP node. On the semantic side a new base node of type *event* is created and the initial representation of the measure phrase becomes the value of the `DURATION` attribute of this event.

When the verbal phrase is constructed, constraint (6) is applied. It states that if the type of the frame is *bounded-event*, than the measure dimension of this event is of type *measure-of-change* and *time*, the minimum on the scale is *zero* and the maximum is equal to the value of the duration.

$$(6) \quad \textit{bounded-event} \wedge (\textit{DURATION} = \top) \rightarrow (\textit{M-DIM} = \textit{measure-of-change} \wedge \textit{time}) \\ \wedge \textit{M-DIM} . \textit{MIN} = 0 \wedge \textit{M-DIM} . \textit{MAX} \stackrel{\Delta}{=} \textit{DURATION} . \textit{VALUE}$$

Now we can combine the representation on the right side of Figure 6.14 with the representation of the verb *zabegat* ‘to start running’ provided on Figure 6.13. The unification in this case leads to a conflict due to the type constraint shown in (4). The combination of the two frames with the underlined conflict is shown on Figure 6.15.

To complete the picture, let me show that there is no unification failure when the same time measure phrase is combined with a non-prefixed verb. In this case the resulting phrase *begat dva časa* ‘run for two hours’ is perfectly acceptable. Indeed, as the verbal dimension is required to unify with the measure dimension only at the moment of *za*-prefixation, no conflict arises in this case, as the values

$$\begin{array}{l}
 \text{za-V f} \left[\begin{array}{l} \text{transition} \\ \text{POST } [2] \left[\begin{array}{l} \text{event} \\ \text{M-DIM } [2] \left[\begin{array}{l} \text{proper-scale} \\ \text{MIN } \text{deg} \end{array} \right] \end{array} \right] \end{array} \right] \left. \begin{array}{l} \langle \text{f} \cdot \text{POST}, \text{e} \rangle : \text{esegm-of} \\ \langle \text{f} \cdot \text{POST} \cdot \text{m} - \text{dim}, \text{e} \cdot \text{m} - \text{dim} \rangle : \text{segm-of} \end{array} \right] \\
 \\
 \text{V e} \left[\begin{array}{l} \text{transloc} \\ \text{DURATION} \left[\begin{array}{l} \text{length} \\ \text{VALUE } 2 \\ \text{M-UNIT } \text{hour} \end{array} \right] \\ \text{M-DIM } \text{e} \left[\begin{array}{l} \text{measure-of-change} \wedge \text{proper-scale} \wedge \text{time} \\ \text{MIN } 0 \\ \text{MAX } 2 \end{array} \right] \\ \text{MANNER } \text{run} \\ \text{ACTOR } \text{entity} \\ \text{TRACE } \text{trace} \\ \text{VERB-DIM } \text{e} \end{array} \right]
 \end{array}$$

Figure 6.15: Failure of unification of the frames for *zabegat* ‘to start running’ and *dva časa* + ‘for two hours’

of the attributes *M-DIM* and *VERB-DIM* remain unrelated. The frame can be read as follows: “There is an event of translocation with manner *run* that some actor is involved in. This translocation leaves some trace and has a duration of two hours.” The rest of the frame is not relevant for its final interpretation and, in fact, could be generated at the moment of prefix attachment (this is, however, not possible to implement in the framework I use due to current restrictions of the compiler).

As there is nothing special with the indeterminate motion verbs that could influence the process of combining them with the prefix *za-*, other verbs that have self-reference (*event* \wedge *scale* type) as the verbal dimension acquire inchoative interpretation in combination with the prefix *za-* in exactly the same way. Let me illustrate this and also the fact that the proposed analysis can be extended to other usages of the prefix *za-* (that occur in presence of other scales) using as an example the verb *želtet* ‘to be yellow and be seen/to become yellow’ that we have discussed in Chapter 4. First let us construct two frames that reflect two interpretations of the basic imperfective verb that probably follow two semantic schemes associated with deriving verbs from colour terms. Under the first interpretation, the verb refers to a state of the theme. The colour of the theme is (constantly) yellow and the state can be specified as *be seen*. As for any other stative verb, the only available verbal dimension is the event (state) itself.

6 Frame semantics for prefixes

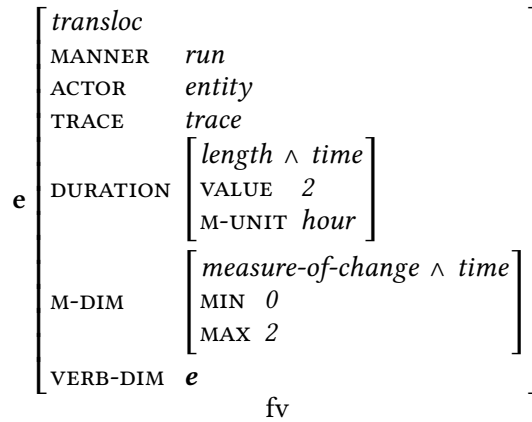

Figure 6.16: Frame representation of the verbal phrase *begat' dva časa* 'run for two hours'

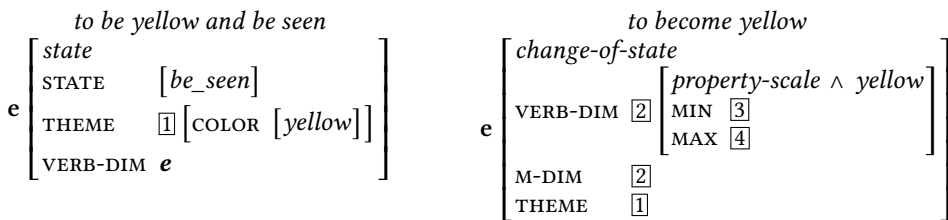

Figure 6.17: Frame representations of the verb *želtet'* 'to be yellow and be seen/to become yellow'

The second interpretation is related to a different kind of event – a change of state. What we know in this situation is that there is a theme that undergoes a change of state along the property scale, more specifically – a scale of type *yellow*. Note that representing verbal semantics in detail is not the primary focus of this thesis and verbal frames provided here should probably be revised (especially with respect to an accurate representation of change of colour), but suffice to show how the prefix *za-* functions.

Let us unify the frame for the prefix *za-* with the frame representations of the verb. We will start with the interpretation of the derivational base that makes use of the event scale ('to be yellow and become seen'). Here everything proceeds exactly as in case of the verb *begat'* 'to run' and the frame obtained as a result of the unification describes an event of type *transition* such that the posterior state of this transition corresponds to the initial stage of the event 'be yellow and be seen', where 'be yellow' is a constant property of the theme, so this means that the derived verb refers to a beginning of the 'be seen' state.

$$\begin{array}{l}
 \mathbf{f} \left[\begin{array}{l}
 \text{transition} \\
 \text{POST} \left[\begin{array}{l}
 \text{event} \\
 \text{M-DIM} \left[\begin{array}{l}
 \text{proper-scale} \\
 \text{MIN } \textit{deg}
 \end{array} \right]
 \end{array} \right]
 \end{array} \right] \\
 \mathbf{e} \left[\begin{array}{l}
 \text{state} \wedge \text{proper-scale} \\
 \text{STATE} \quad [\textit{be_seen}] \\
 \text{THEME} \quad [2] [\text{COLOR} [\textit{yellow}]] \\
 \text{VERB-DIM} \quad \mathbf{e} \\
 \text{M-DIM} \quad \mathbf{e}
 \end{array} \right]
 \end{array}$$

$\langle \mathbf{f} \cdot \text{POST}, \mathbf{e} \rangle : \textit{esegm-of}$
 $\langle \mathbf{f} \cdot \text{POST} \cdot m - \textit{dim}, \mathbf{e} \cdot m - \textit{dim} \rangle : \textit{segm-of}$

Figure 6.18: Frame representation of the verb *zaželtet* ‘to be yellow and become seen’

Next I would like to show what happens in the other case: when the verbal dimension is the colour property scale. Under this interpretation of the derivational base the transition should have as its posterior state some part of the original event. Which part the posterior state corresponds to is determined by the measure dimension of the derived transition event: the minimum point of the scale has to be included. It is, however, not clear, what the minimum point is, as for the verb *želtet* ‘to become yellow’ it is only given in form of a variable. This means that for the new event (transition) the minimum point on the property scale remains a variable. As a result, we obtain a frame that describes an event of type *transition* with a posterior state corresponding to some yellow state (but we do not know its exact characteristics) of the theme. The underspecification of the scale allows for two interpretations of the derived verb in this case: in the minimum on the scale is some point that can be not considered as being yellow, than the derived verb is interpreted as ‘to start becoming yellow’; if the minimum on the scale is some point that is yellow, then the derived verb is interpreted as ‘to become yellow’.

In sum, two representations of the verb combined with one prefix representation yield three possible interpretations of the derived verb: ‘to be yellow and be seen’, ‘to become yellow’, and ‘to start becoming yellow’. This result agrees with the dictionary data that points exactly to these three meanings of the verb *zaželtet*’.

Another important scale type that can be provided by the verb is *path*. This is the case of determinate motion verbs, such as *bežat* ‘to run (one direction)’. When the frame representation of the prefix *za-* proposed above is combined with the frame representation of such a verb, the resulting interpretation of the derived verb is ‘transition such that the posterior state is associated with the locomotion that starts at the border of the contextually specified region’. This case is analyzed in detail in Zinova & Osswald (2016), so I will skip further details here.

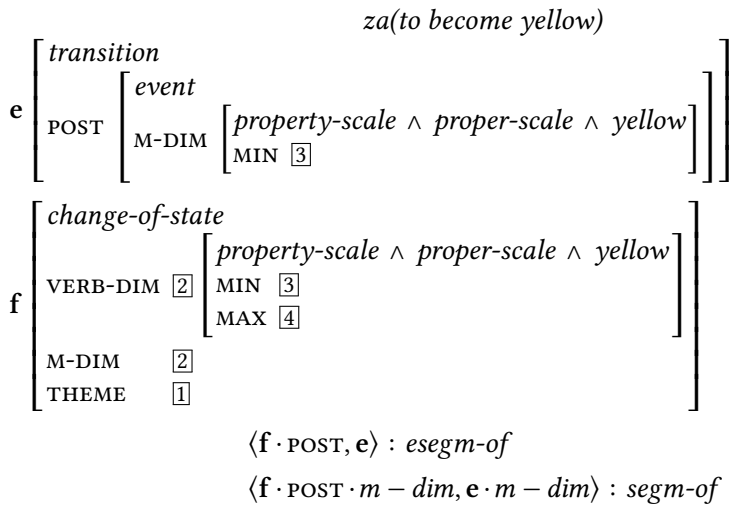

Figure 6.19: Frame representation of the verb *zaželtet* ‘to become yellow/to start becoming yellow’

As for the resultative interpretation, some more details and ideas are provided in Zinova & Kallmeyer 2012 and Zinova 2014, which address the locative alternation phenomena that in Russian is related to the resultative usage of the prefix *za-*.

6.3 Frame semantics for the prefix *na-*

The second prefix that we have discussed in Chapter 4 is the prefix *na-* with its cumulative interpretation. As I have concluded after analysing the proposals of Filip (2000) and Kagan (2015) and providing further examples and observations (see discussion in Section 4.4), the prefix requires a scale that is provided by the verb and is at the same time a parameter of the object. For example, temperature is a variable parameter for most of the objects, although it may be easier accessible for objects like *soup* than for objects like *book*.

When these requirements are met and the prefix is attached, it maps the minimum point of the scale onto the initial stage of the event and some point that is located at or above the threshold value onto the final stage of the event. As I have shown earlier, there are cases when a *na-*prefixed verb is compatible with a singular object description. Taking this possibility into account, I propose a frame representation for the prefix as shown on Figure 6.20. This frame encodes the following information: the event denoted by a *na-*prefixed verb is a bounded event,

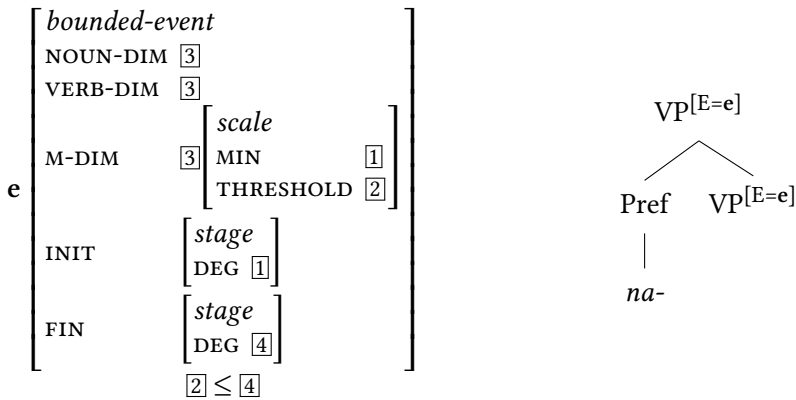
Figure 6.20: Representation of the contribution of the prefix *na-*

the measure dimension is at the same time the verbal dimension and the noun dimension, the initial stage of the event corresponds to the minimum point of the measure dimension scale (that normally is provided by the noun and is identical to the initial value of the relevant property) and the final stage of the event corresponds to the point on the scale that is located at or above the threshold value.

Note that there is no direct requirement for an open scale, but in many cases it automatically emerges from the semantic restrictions and pragmatic principles alone. The argumentation proceeds in two steps. First, the semantic representation of the event carries a requirement that the event must continue at least until the threshold value on the relevant scale is reached. At the same time the event cannot continue beyond the maximum value on the scale. This means that if there is a maximum value of the property that is supplied by the noun and no information that this maximum value is at least the threshold value, uttering such verb would be pragmatically unsuccessful. Second, suppose the threshold value equals the maximum value on the scale. Then the final stage of the event has to be related to the scale maximum. This is, however, only a special case of the interpretation of a *na*-prefixed verb. If there is another verb that semantically states the equation between the maximum point of the scale and the final stage of the event explicitly, it is preferred over the *na*-prefixed verb for pragmatic reasons (see Chapter 5 for more details).

For example, the verbal phrase *navarila supa* ‘she made a lot of soup’ is interpreted as the quantity of the soup should be significant. This can be explained in terms of a competition with an alternative description *svarila soup* ‘she made a soup’. If such alternative is absent, then no pragmatic conflict arises in case the

maximum of the scale coincides with the threshold: the verbal phrase *naguglit' film* 'to google the film' uses the binary scale of the non-found or found state of the object and the maximum on this scale trivially corresponds to the threshold. As there is no other verb that would explicitly equate the maximum value on the scale with the final state, the phrase *naguglit' film* 'to google the film' sounds natural. Note, however, that a change of case of the object (*naguglit' filmov* 'to google some films') leads to a change of the measure dimension to that of *quantity* that has no inherit maximum and the resulting interpretation is 'to find a number of films that is at or above the contextually specified threshold'.

A similar mechanism applies in case another prefixed verb with an excessive interpretation is available. Consider the verb *gret'* 'to heat' that has derivatives *peregret'* 'to overheat' and *nagret'* 'to warm up' that both refer to the same measure dimension: temperature. The *pere*-prefixed verb denotes events the final stage of which is associated with a value strictly above the threshold. In this case the range of events the *na*-prefixed verb denotes gets limited to the events the final stage of which is associated with the threshold value (in our example it is heating the object up to the appropriate temperature). When an alternative *pere*-prefixed verbs is absent (this, for example, is always the case when the measure dimension is of type *quantity*, as in this case the excessive interpretation of the prefix *pere*- is not possible), the *na*-prefixed verb would cover the excessive interpretation domain.

$$e \left[\begin{array}{l} \text{change-of-state} \\ \text{MANNER} \quad [heat] \\ \text{ACTOR} \quad \boxed{1} \\ \text{THEME} \quad \boxed{2} \\ \text{VERB-DIM} \quad \boxed{3} \quad [temperature] \\ \text{M-DIM} \quad \boxed{3} \end{array} \right]$$

Figure 6.21: Frame representation of the verb *gret'* 'to heat'

With this in mind let us see how the prefix is combined with some verbs that operate on different scales. We start with the verb *gret'* 'to heat' that has as the verbal dimension the temperature scale (that is also copied to the measure dimension attribute). When this verb combines with the prefix *na*-, the resulting frame (provided on Figure 6.22) denotes a bounded change of state with manner *heat*, some actor, and some theme that has a temperature attribute. The event starts at the temperature corresponding to the minimum of the scale and ends when the temperature is at or above the threshold value. Note that at this moment the minimum on the scale is an unbound variable that will acquire its value

later. The threshold value will also be determined only by the pragmatic module that is as well used to block the “above the threshold” interpretation of the verb *nagret* ‘to warm up’, as sketched above.

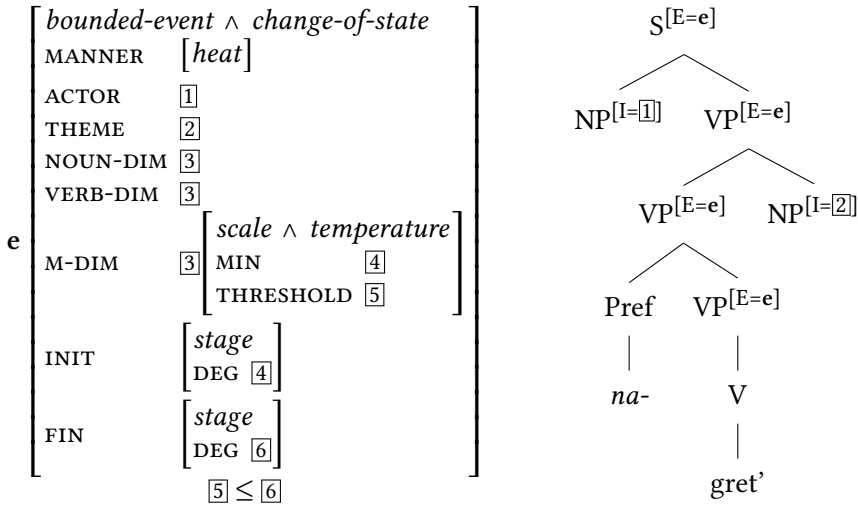

Figure 6.22: Representation of the verb *nagret* ‘to warm up’

The next step that is relevant for understanding how prefix frames function is the combination of the verb and the direct object. In our case it is a combination of the verb *nagret* ‘to warm up’ with some appropriate theme, e.g., *sup* ‘soup’. Here we would need a similar mechanism of enriching noun representations with dimension information, as I have proposed above for the verbs that do not carry measure dimension information. In our case (see the frame on Figure 6.23) the object of type *soup* has a temperature attribute, as well as an amount attribute, a kind attribute, and a taste attribute. At the same time *amount* and *temperature* can serve as scalar dimensions, which gives rise to the attributes AMOUNT-DIM and TEMPERATURE-DIM.

Note that the relations between the values of the AMOUNT and TEMPERATURE attributes of the *soup* and the respective measure dimension specifications differ: in case of the *amount* dimension, the type of the scale is *measure-of-change* and thus the minimum on the scale is 0. The maximum point of the scale is the value of the AMOUNT attribute of the *soup*. In case of the *temperature* dimension the value of the TEMPERATURE attribute serves as a minimum point of the respective dimension. The type of the scale is *proper-scale* and the maximum value is 100 (degrees Celsius).

6 Frame semantics for prefixes

f	<i>soup</i>	
	AMOUNT	$\left[\begin{array}{l} \textit{amount} \\ \text{VALUE } \boxed{1} \\ \text{M-UNIT } \textit{ml} \end{array} \right]$
	TEMPERATURE	$\left[\begin{array}{l} \textit{temperature} \\ \text{VALUE } \boxed{2} \\ \text{M-UNIT } \text{°C} \end{array} \right]$
	KIND	$\left[\textit{soup-kind} \right]$
	TASTE	$\left[\textit{taste} \right]$
	AMOUNT-DIM	$\left[\begin{array}{l} \textit{amount} \wedge \textit{measure-of-change} \\ \text{MIN } 0 \\ \text{MAX } \boxed{1} \end{array} \right]$
	TEMPERATURE-DIM	$\left[\begin{array}{l} \textit{temperature} \wedge \textit{proper-scale} \\ \text{MIN } \boxed{2} \\ \text{MAX } 100 \end{array} \right]$

Figure 6.23: Frame representation of the noun *sup* ‘soup’

The variability of the minimum or maximum value representation as a static attribute is supported by the variation with respect to which stage is modified by an adjective: if you warm a very cold soup, it is the initial stage of the soup that can be described as *very cold*, but if you write a very long novel, it is the end stage of the novel that can be described as having a length that is greater than the typical length of a long novel. I acknowledge, however, that static representations may prove insufficient: the attribute that provides the relevant dimension undergoes changes and thus is a function of time. However, as such a representation would require significantly more complex modelling and the proposed simplification seems to be sufficient for the purposes of current analysis, I will use static representations.

Objects in general may be associated with various measure dimensions, as in the case of *soup*, so they have to undergo the process of dimension selection. To perform it, I introduce *dimension constructors* that apply to nouns that have relevant dimensions and identify one of these dimensions with a noun dimension attribute of an event. The first dimension constructor that can be applied to *soup* makes use of the temperature dimension of the noun, identifying it with the value of the attribute NOUN-DIM of the event. The event frame gets linked to a VP that linearly precedes the NP (such constructors are part of the metagrammar description). The semantic and syntactic parts of the constructor are shown

on Figure 6.24. The result of the unification of the temperature dimension constructor frame and the noun phrase frame is shown on Figure 6.25.

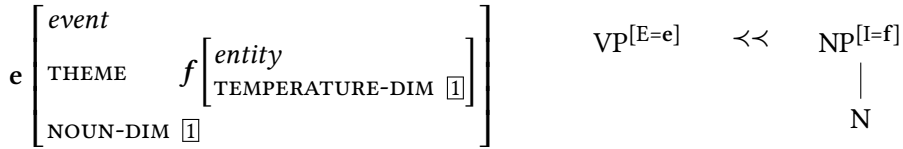

Figure 6.24: Temperature dimension constructor

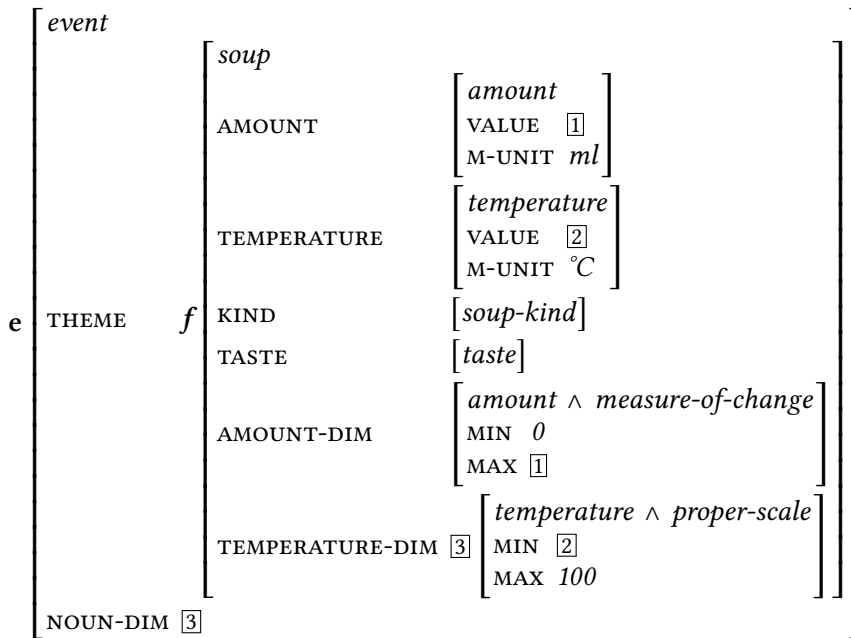

Figure 6.25: Result of unification of the temperature dimension constructor frame with the frame for the noun *sup* ‘soup’

The second dimension constructor applicable in case of the noun *sup* ‘soup’ is the amount dimension constructor. It is similar to the temperature dimension constructor shown before, but it also imposes a syntactic requirement for a genitive case of the object. This constructor is shown on Figure 6.26 and the result of the unification of its frame part with the representation of the noun *sup* ‘soup’ is provided on Figure 6.27.

Now we can try combine the representations that emerge from the unification of the noun frame with the frames of dimension constructors (Figure 6.26 and

6 Frame semantics for prefixes

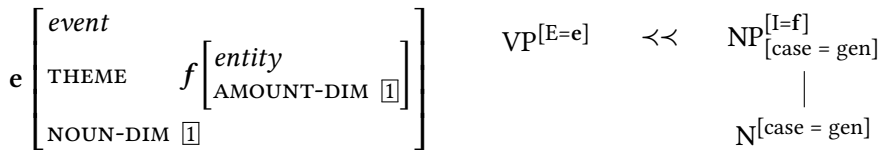

Figure 6.26: Amount dimension constructor

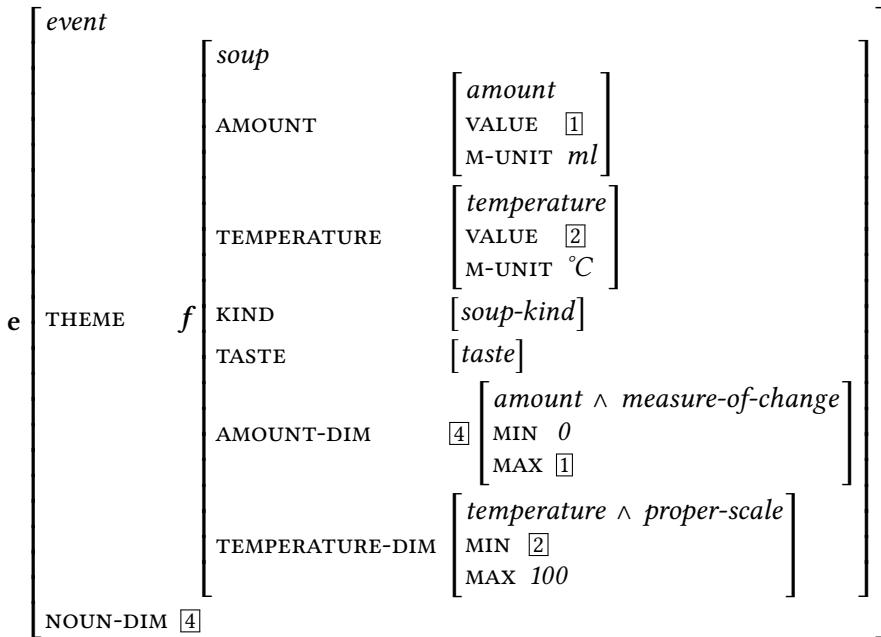

Figure 6.27: Result of unification of the amount dimension constructor frame with the frame for the noun *sup* 'soup'

Figure 6.24) with the frame for the verb *nagret* 'to warm up' (Figure 6.22). First let us use the frame that is produced by the temperature dimension constructor (Figure 6.25). The result of inserting the noun representation into the theme slot of the verb in this case is shown on Figure 6.28. As one can see, now the initial stage of the event corresponds to the initial (minimal) value of the temperature scale associated with the concrete portion of the soup. The final stage is defined as being at least at the threshold value, but not higher than the maximum value. This means that, for example, it would be not possible to heat the soup up to more than 100°C.

What if we try to combine the frame for the verb *nagret* 'to warm up' with the same noun *sup* 'soup' that went through another dimension constructor?

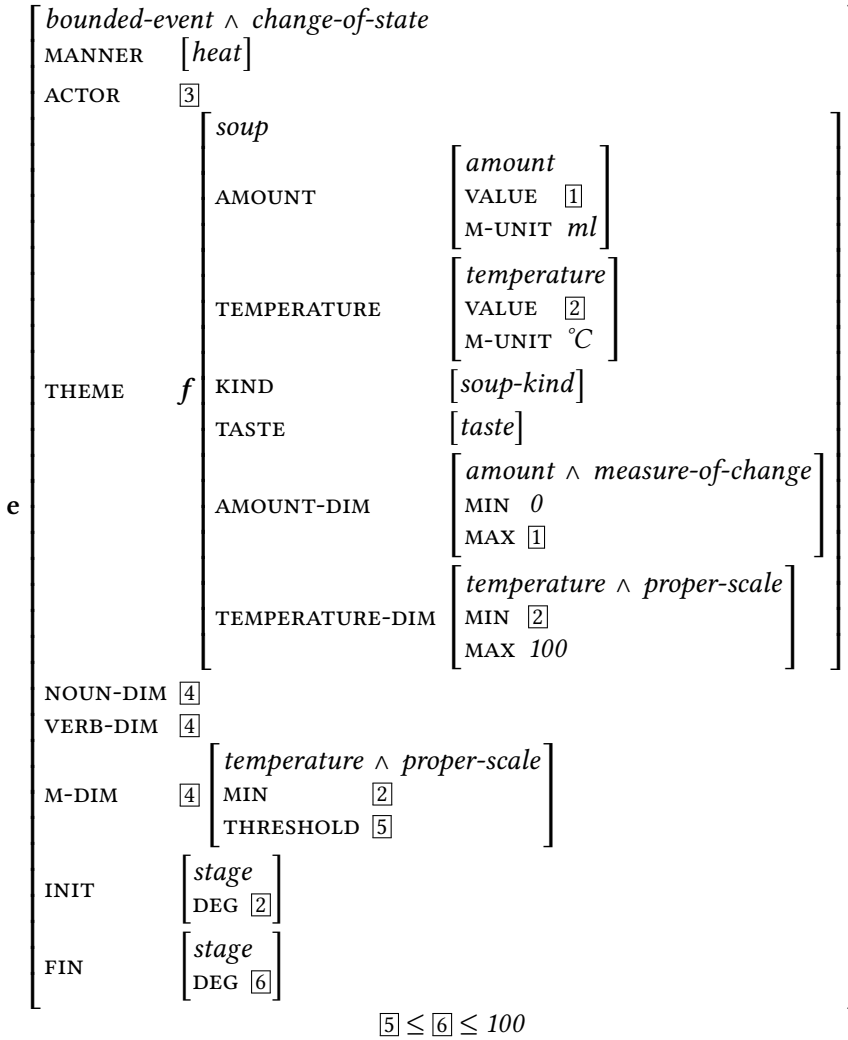

Figure 6.28: Frame representation of the verbal phrase *nagret' sup* 'to warm up the soup'

Let us take the representation shown on Figure 6.27 and unify it with the frame representation of the verb. When unification is performed, it turns out that the measure dimension of the event has to be simultaneously of types *temperature* and *amount*. This is not possible due to the constraint (7) on type incompatibility. The type conflict that arises in case the amount dimension is selected as the noun dimension is marked on Figure 6.29.

$$(7) \quad \textit{amount} \wedge \textit{temperature} \rightarrow \perp$$

The mechanism of type conflict is the main mechanism that prevents unwanted prefix stacking and inappropriate measure phrases or direct object interpretations. Note, however, that noun representations allow for different interpretations and the concrete interpretation is only selected relative to an event. This means that the same noun can be viewed as providing different dimensions when several event nodes are present in the semantic structure. This is even possible with one verb (secondary imperfective verb with habitual/iterative interpretation) due to different measure dimensions of the iterated subevent and the event that refers to the whole series of subevents.

Another way of implementing the same system of agreement between the dimensions of the verb and the noun is to formulate requirements (here, for example, a requirement for a temperature scale), but in the current version of the formalisation of frame semantics within XMG 2 that I am using here it is not possible. For this reason such requirements have to appear implicitly as type or value incompatibilities. I leave it to future research to find out whether an approach that uses constructors and type conflicts is cognitively plausible.

Let me provide one more example of the interaction between the prefix *na-*, a verb, and a direct object. This time we will consider the verb *varit* 'to cook' as the base verb. The frame representation of this verb is provided on the left side of Figure 6.30 and shows that there is no preselected verbal dimension. At the same time the frame uncovers the parameter of the cooking event: apart from the type of the theme, the quantity (amount) of the cooked food plays a role. I propose to introduce a dimension constructor that

1. constructs a measure dimension of the type *amount*;
2. is only available if the next step is the attachment of the prefix *na-*;
3. can be applied if the verbal frame contains a specification of the amount of one of the arguments.

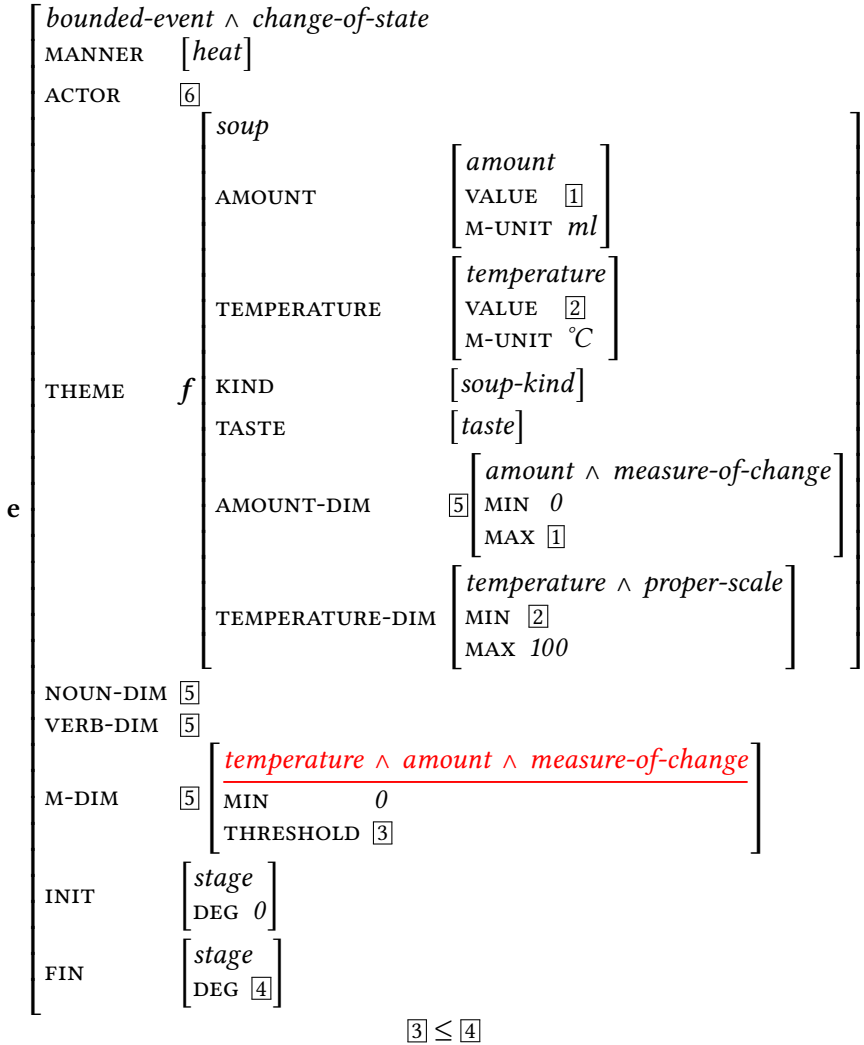

Figure 6.29: Failure during the unification of the frames for *nagret* ‘to warm up and *sup* ‘soup’ with amount dimension interpretation

6 Frame semantics for prefixes

If such constructor is used, the verbal representation acquires the corresponding measure dimension, as shown on the right side of Figure 6.30. In contrast to the noun dimension constructors, no changes on the syntactic side are associated with the verbal dimension constructor. At the same time, as stated above, it can be only used in connection with *na*-prefixation.

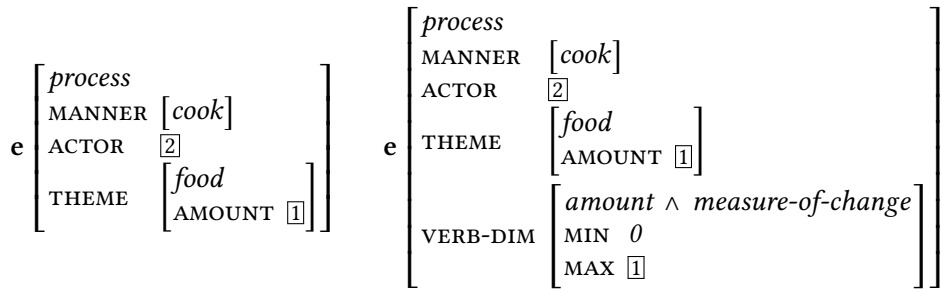
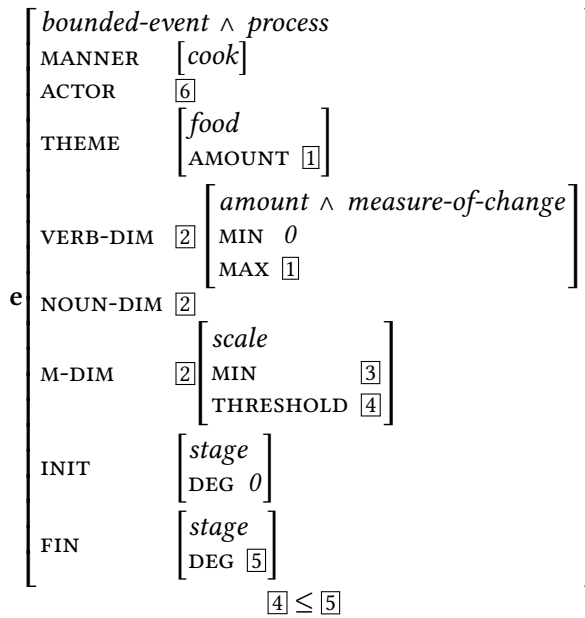

Figure 6.30: Frame representation of the verb *varit* ‘to cook’ before (left) and after (right) an enrichment with scalar information

Now the verb has a VERB-DIM argument and can be combined with the prefix frame. The result of the unification of the frame on Figure 6.20 with the frame on the right side of Figure 6.30 is shown on Figure 6.31. It describes a bounded process that starts with no food being cooked and ends when some amount of food that exceeds the threshold is cooked. The *measure-of-change* type of the *amount* scale ensures that there is no requirement for any intermediate event stage to correspond to some intermediate value on the amount scale, so no gradual cooking in terms of amount is required, which means that the soup may be prepared as one portion.

As a next step, we try to combine the representation of the verb *navarit* ‘to cook a lot of’ with two possible interpretations of the noun *sup* ‘soup’ that we have discussed above (see Figure 6.25 and Figure 6.27). Here the result is opposite to that with the verb *nagret* ‘to warm up’: the temperature-related interpretation of the noun fails to serve as the theme of the event, while the amount interpretation can be successfully used. The unification failure in the first case is due to the type conflict that is marked on Figure 6.32. The type compatibility constraints are violated two times: *amount* conflicts with *temperature* (7) and *proper-scale* conflicts with *measure-of-change* (4).

Note that this representation format stores a lot of world knowledge: not only the resulting verbal frame in case of the verb *nagret* ‘to warm up’ contains information that the event of warming something proceeds along the temperature scale, but the frame for the verb *navarit* ‘to cook’ also carries the knowledge that

Figure 6.31: Frame representation of the verb *navarit'* 'to cook a lot of'

it is not the temperature domain that is relevant in this case, although temperature changes are definitely present during the cooking process. At the same time selection of the amount dimension of the verb is a special case and the proposed architecture does not prevent the event from being measured in other terms (e.g., degree of being cooked) when the verb is prefixed with other prefixes.

Now, when we combine the appropriate amount-related representation of the noun *sup* 'soup' (in genitive case) with the frame for the verb *navarit'* 'to cook a lot of', unification is successfully performed. The resulting frame for the verbal phrase *navarit' supa* 'to cook a lot of soup', shown on Figure 6.33, can be read as follows: a bounded process of cooking is performed by some actor. The theme of the event is *soup* that was not present (zero amount value) at the initial stage, but is present at the final stage of the event. The amount of soup cooked at the end of the event equals or exceeds the threshold value.

6 Frame semantics for prefixes

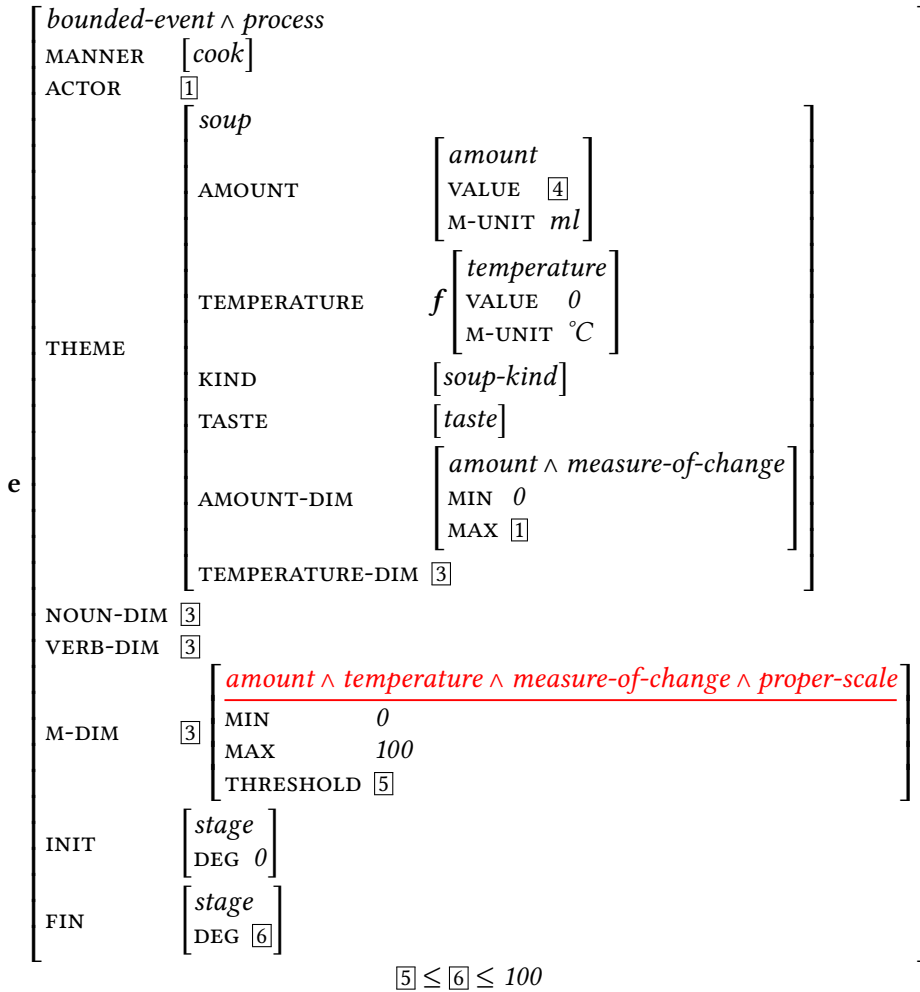

Figure 6.32: Failure of unification of the frame for the verb *navarit* 'to cook a lot of' and the frame for the noun *sup* 'soup' with temperature dimension interpretation

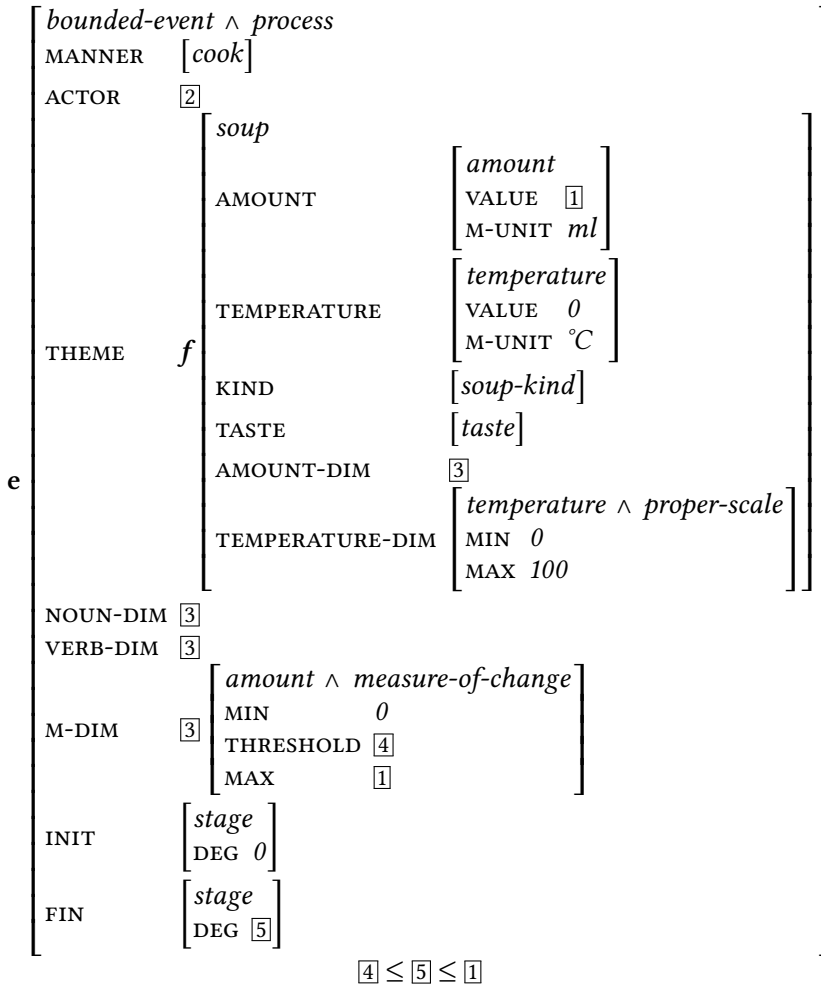

Figure 6.33: Frame representation of the verbal phrase *navarit' supa* 'to cook a lot of soup' (amount dimension interpretation of the noun)

6.4 Frame semantics for the prefix *po-*

The next prefix I provide a frame representation of is *po-*. In Chapter 4 on the basis of the analyses proposed by Filip (2000) and Kagan (2015) and an extensive data discussion, I have concluded that all the usages of the prefix *po-* can be unified under one underspecified semantic representation. As has already been observed by Kagan (2015), the prefix *po-* can be attached to different types of scales. In the default case, the scale is one of the verbal scales. In addition, if the event denoted by the derivational base is of type *iteration*, a *cardinality* scale can be provided by the direct object and used as an event scale. As shown on the left side of Figure 6.34, the prefix adds information that the event is bounded and the initial and the final stages of the event are related to arbitrary points on the scale.

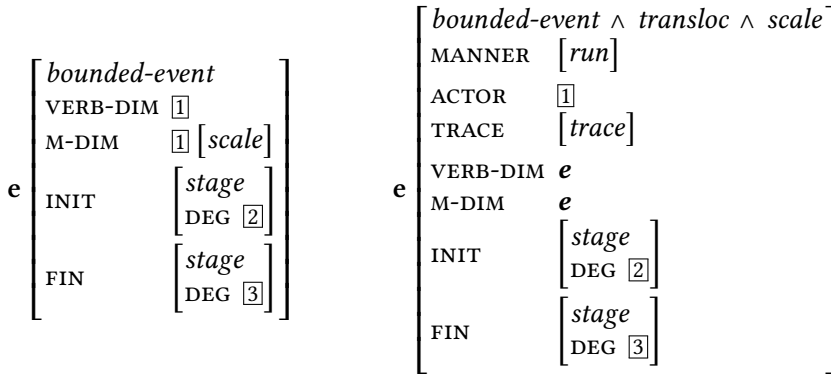

Figure 6.34: Frame representations of the prefix *po-* (left) and of the verb *pobegat* ‘to run for some time’ (right)

Although the prefix does not provide information about the exact scalar degrees associated with the initial and final stages of the event, in some cases the derived verb carries such information. This happens when the measure dimension is the event itself and thus the MIN and MAX attributes of the scale become promoted to the event level. In this case the initial and the final stages need to be identified with the maximum and the minimum points on the scale. This is done via constraints shown under (8).

- (8) a. $\text{MIN} = \top \wedge \text{init} = \top \rightarrow \text{init.deg} \triangleq \text{MIN}$
 b. $\text{MAX} = \top \wedge \text{fin} = \top \rightarrow \text{fin.deg} \triangleq \text{MAX}$

Let us now combine the frame representation of the prefix *po-* with the verbal frames that we have already considered above. The first verb is an indeterminate motion verb *begat* ‘to run’. The only dimension constructor the prefix *po-* has

access to (in case the verb has no specified measure dimension) is the self-scaling constructor. This means that the prefix frame can be combined with the frame on the right side of Figure 6.12. The result of the unification of the enriched verbal frame with the prefix frame (Figure 6.34) is provided on the right side of Figure 6.34. The derived frame can be interpreted as describing a bounded event of translocation with manner *run*, some actor and some trace, that started at some point and ended at some other point. To ensure that the two degrees on the scale differ from each other, I assume a general constraint shown in (9).

$$(9) \quad \textit{bounded-event} \rightarrow \textit{init.deg} \neq \textit{fin.deg}$$

If now this verb is combined with a temporal measure phrase, such as *dva časa* ‘two hours’ (see the frame on the right side of Figure 6.14), the verbal phrase *pobe-gat’ dva časa* ‘to run for two hours’ receives the frame representation shown on Figure 6.35. Two things has to be taken into account at this point due to the fact that the measure dimension is the event itself. First, all the information about the measure dimension needs to be “passed” to the event level. Afterwards, constraints (6) and (8) are applied. As a result, (1) the event representation acquires the complex type *bounded-event* \wedge *transloc* \wedge *scale* \wedge *measure-of-change* \wedge *time*, (2) the minimum of the measure dimension is equated with the minimum of the event and with the scale degree that corresponds to the initial stage of the event, and (3) the maximum of the measure dimension is equated with the maximum of the event and with the scale degree that corresponds to the final stage of the event.

In order to see how the representation of the prefix *po-* interacts with other verbal scales, let us consider the verb *gret’* ‘to heat’ that denotes a change along the temperature dimension (Figure 6.21). The derived verb *pogret’* ‘to warm up’ refers to a bounded change of state of the theme. This change happens along the temperature dimension, but no particular values are associated with the initial and the final stages of the event. The resulting frame can be interpreted as ‘there is an event of manner *heat* that lead to some increase of the temperature’.

Now let us proceed to the case when the prefix *po-* is interpreted distributively. This occurs when an argument of the verb supplies a cardinality scale that is used to measure the event. For this situation to be available, the initial event has to be of type *iteration* or has to be compatible with such interpretation.² The only special tool that we need to account for this case is the constraint (10) that introduces *iteration* type in case something of type *event* is simultaneously of type *cardinality*.

$$(10) \quad \textit{event} \wedge \textit{cardinality} \rightarrow \textit{iteration}$$

²In the latter case the distributive interpretation usually has to be supported by an overt quantifier.

6 Frame semantics for prefixes

	$bounded-event \wedge transloc \wedge measure-of-change \wedge time$
	MANNER [run]
	ACTOR [entity]
	TRACE [trace]
	DURATION [length \wedge time]
	VALUE 2
	M-UNIT hour
e	VERB-DIM e
	M-DIM e
	INIT [stage]
	DEG 0
	FIN [stage]
	DEG 2
	MIN 0
	MAX 2

Figure 6.35: Frame semantics of the verbal phrase *pobegat dva časa* ‘to run for two hours’

	$bounded-event \wedge change-of-state$
	MANNER [heat]
	ACTOR [entity]
	THEME [entity]
	VERB-DIM 1 [temperature]
e	M-DIM 1
	INIT [stage]
	DEG 2
	FIN [stage]
	DEG 3

Figure 6.36: Frame semantics of the verb *pogret* ‘to warm up’

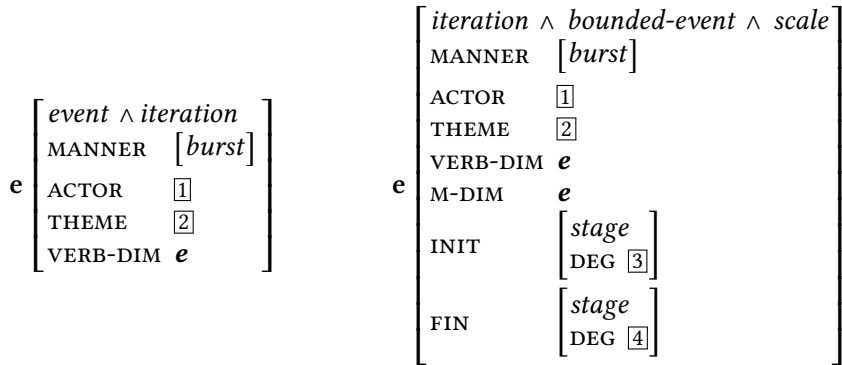

Figure 6.37: Frame representations of the verbs *lopat'* 'to burst' (left) and *polopat'* 'to burst for some time/all of' (right)

Let us consider the case where a non-quantified object can cause the distributive interpretation of the verb. To do this, we will look at the semantics of the verb *lopat'* 'to burst' and its derivatives. As an event of bursting is punctual, the default interpretation of the imperfective verb is iterative, so the type of the frame on Figure 6.37 is *iteration*. The verbal dimension is the event itself. When this verb is prefixed with *po-*, the result of the unification is the frame shown on the right side of Figure 6.37.

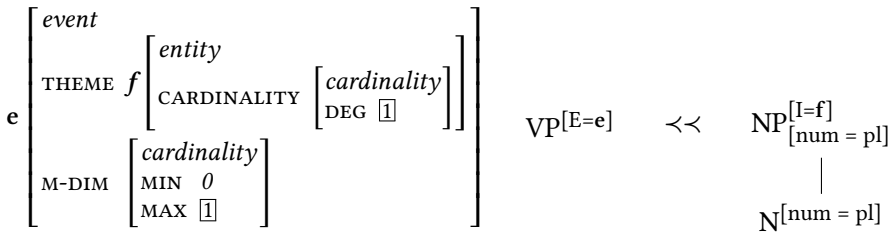

Figure 6.38: Cardinality dimension constructor

The second “ingredient” for the verbal phrase *polopat' šary* ‘to burst the balloons’ is the noun *šar* ‘balloon’ that has to supply some measure dimension, which in this case is the cardinality scale. The constructor of the cardinality scale, shown on Figure 6.38, is similar to the constructors introduced before. What differs on the syntactic side is the presence of the requirement for the plural number of the noun. As for the semantic side, here the information about the scale of the event is passed directly into the m-dimattribute and not into the NOUN-DIM attribute. Informally speaking, this means that once the cardinality constructor applies, the cardinality scale must be used. At the same time the usage of this

constructor needs to be restricted to cases when the noun is a direct object of a verb that denotes an event of type *iteration*.

The frame representation of the noun *šar* ‘balloon’ is shown on the right side of Figure 6.39. The right side of the same figure shows the result of unification of the noun representation with the cardinality dimension constructor.

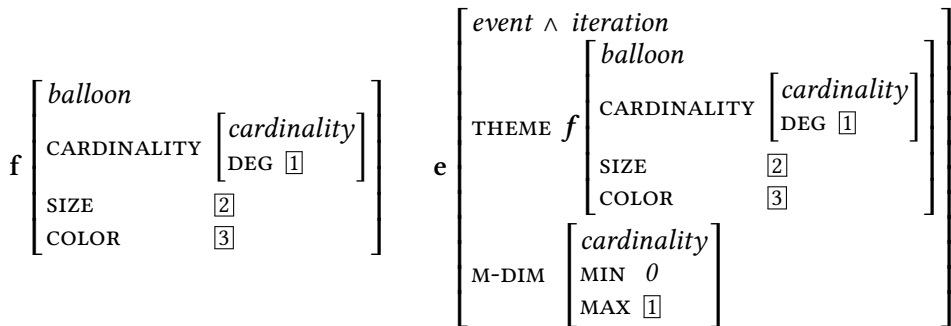

Figure 6.39: Frame representations of the noun *šar* ‘balloon’ (left) and of the result of its unification with the cardinality dimension constructor (right)

Now we are ready to combine the verbal and the nominal frames and obtain the representation of the verbal phrase *polopat’ šary* ‘to burst the balloons’ that is shown on Figure 6.40. The frame describes a bounded iteration event of bursting. The actor is not yet specified, and the theme is of type *balloon* with some cardinality, size, and colour. The event is measured along the cardinality dimension: it starts when zero balloons are burst and ends when all the balloons are burst. There is no information about the internal structure of the bursting event, apart from the *iteration* type. This means that several balloons could be burst at once as long as there are multiple bursting sub-events.

Note that the interpretation of the same phrase that describes the bursting event only in terms of time is also possible. As the prefix frame in case of *po-* only requires the verbal dimension to be present, the application of the dimension constructor is not obligatory. This means that we can unify directly the frame for the verb *polopat’* ‘to burst for some time/all of’ on the right side of Figure 6.37 and the frame for the noun *šar* ‘balloon’ provided on the left side of Figure 6.39. The result of this unification is shown on Figure 6.41. Such an interpretation of the verbal phrase *polopat’ šary* ‘to burst balloons’ is indeed possible and can be paraphrased as ‘to spend some time bursting balloons’.

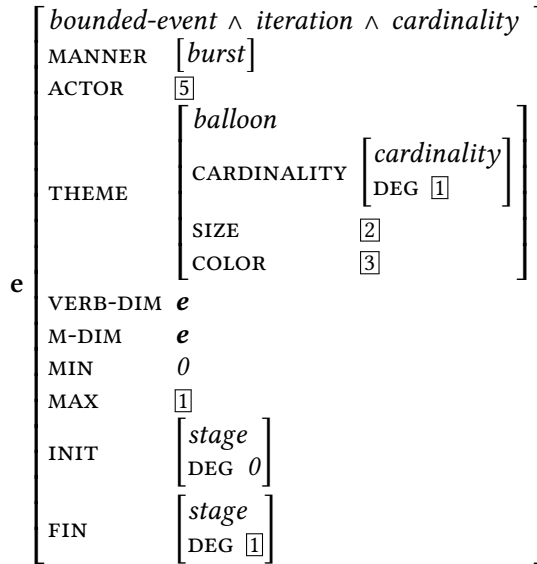

Figure 6.40: Frame representation of the verbal phrase *polopat' šary* 'to burst the balloons'

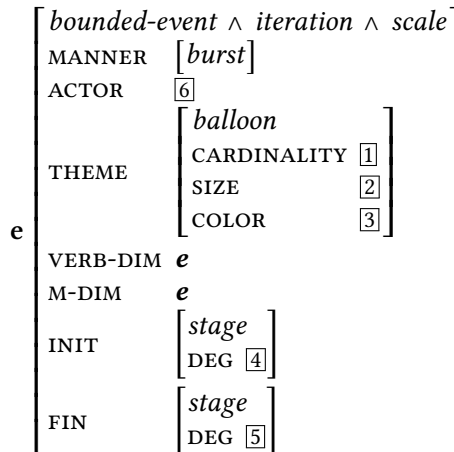

Figure 6.41: Frame representation of the verbal phrase *polopat' šary* 'to burst balloons for some time'

6.5 Frame semantics for the prefix *pere-*

The next prefix, *pere-*, is the most polysemous of Russian verbal prefixes. As I have argued in Section 4.7, starting with the proposals of Demjjanow (1997) and Kagan (2015) and providing further data and observations, several representations are required to acquire different interpretations of the prefix, although the process of selection is fully dependent on the type of the scale.

The first representation accounts for spatial (crossing), time-related (passing the time, waiting), and distributive usages. It applies when the measure dimension is such scale that there is a possibility to map each degree on the scale onto the event stages. In particular, this requires the scale to be closed. The second representation applies when there is only one marked point on the relevant scale (e.g., excessive and ‘outdo’ usages). In this case the event proceeds from some point below the marked point through the marked point point to the point above it. The last representation leads to the iterative interpretation of the event. In this case the derived verb refers to a new event that has as its preparatory phase the event denoted by the derivational base. I will now show these representations one by one.

6.5.1 Distributive, crossing and waiting interpretations

The first frame representation is, on the one hand, the most “ordinary”, as it resembles a lot the frames we have already discussed. On the other hand, it covers three “traditional” usages. As we have already discussed a number of similar frames, I will now only point out what is special in this case (the frame is shown on Figure 6.42). As before, the key restrictive factor is the type of the measure dimension: a closed proper scale in this case. The source of this scale is the noun, if it is not already specified by the verb (in this case the noun has to offer an appropriate scale). The initial and final stages of the event correspond to the minimum and maximum points on the scale.

Let me now illustrate how this prefix frame combines with the representations of the verbs. First consider the verb *zimovat* ‘to spend winter time’ that we have discussed in Chapter 5. This verb has as the verbal dimension the time scale, as many verbs, but this scale is predefined already in the lexicon, so no choice of dimension constructors is possible. The frame for this verb is shown on Figure 6.43. (The choice of the type of the manner and the representation of the extremes of the scale may be revised.) Note that the fact that the verbal frame contains information about the minimum and the maximum of the scale does not lead to a bounded interpretation of the verb: it arises only in presence of the initial and final attributes.

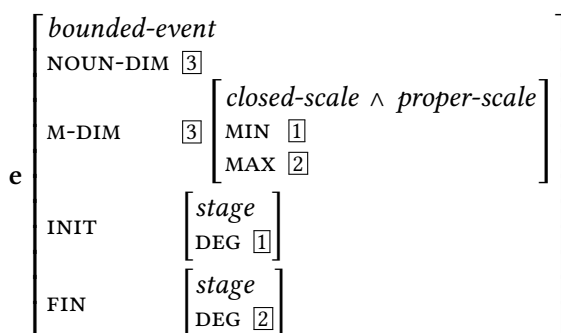
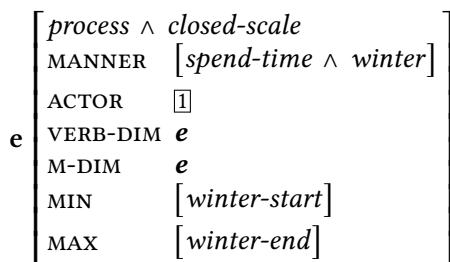
Figure 6.42: Frame representation of the prefix *pere-*: case of a closed scaleFigure 6.43: Frame representation of the verb *zimovat* ‘to spend winter time’

Now we can combine the frame for the verb *zimovat* ‘to spend winter time’ with the frame for the prefix *pere-*. The result of the unification of the two frames is shown on Figure 6.44. This new frame refers to a bounded process of spending winter time that starts when the winter starts and ends when the winter ends. In other words, it is an event of spending the whole winter, which corresponds to the meaning of the verb. The identity of the scale minimum with the initial stage of the event and of the scale maximum with the final stage of the event is established due to the constraints shown in (8).

The second example is the case of the path scale. Consider a determinate motion verb *bežat* ‘to run’. The frame representation of this verb (on the left side of Figure 6.45) differs from the frame representation of the indeterminate motion verb *begat* ‘to run’ (shown on Figure 6.12) in that it contains a *PATH* attribute and the *path* scale is selected as a measure dimension.

When the verb *bežat* ‘to run’ combines with the prefix *pere-*, the frame for the derived verb refers to a bounded translocation event of manner *run* that is measured according to the *path* that has to be also the measure dimension of

6 Frame semantics for prefixes

$$\begin{array}{l}
 \left[\begin{array}{l}
 \textit{process} \wedge \textit{bounded-event} \wedge \textit{closed-scale} \wedge \textit{proper-scale} \\
 \text{MANNER} \quad [\textit{spend-time} \wedge \textit{winter}] \\
 \text{ACTOR} \quad \boxed{3} \\
 \text{VERB-DIM} \quad \mathbf{e} \\
 \text{NOUN-DIM} \quad \mathbf{e} \\
 \text{M-DIM} \quad \mathbf{e} \\
 \text{MIN} \quad \boxed{1} [\textit{winter-start}] \\
 \text{MAX} \quad \boxed{2} [\textit{winter-end}] \\
 \text{INIT} \quad \left[\begin{array}{l} \textit{stage} \\ \text{DEG} \boxed{1} \end{array} \right] \\
 \text{FIN} \quad \left[\begin{array}{l} \textit{stage} \\ \text{DEG} \boxed{2} \end{array} \right]
 \end{array} \right]
 \end{array}$$

Figure 6.44: Frame representation of the verb *perezimovat* ‘to spend the winter’

$$\begin{array}{l}
 \left[\begin{array}{l}
 \textit{transloc} \\
 \text{MANNER} \quad [\textit{run}] \\
 \text{ACTOR} \quad \boxed{1} \\
 \text{TRACE} \quad [\textit{trace}] \\
 \text{PATH} \quad \boxed{2} [\textit{path}] \\
 \text{VERB-DIM} \quad \boxed{2} \\
 \text{M-DIM} \quad \boxed{2}
 \end{array} \right]
 \end{array}
 \quad
 \begin{array}{l}
 \left[\begin{array}{l}
 \textit{bounded-event} \wedge \textit{transloc} \\
 \text{MANNER} \quad [\textit{run}] \\
 \text{ACTOR} \quad \boxed{4} \\
 \text{PATH} \quad \boxed{1} \\
 \text{TRACE} \quad [\textit{trace}] \\
 \text{VERB-DIM} \quad \boxed{1} \\
 \text{M-DIM} \quad \boxed{1} \left[\begin{array}{l} \textit{path} \wedge \textit{closed-scale} \wedge \textit{proper-scale} \\ \text{MIN} \boxed{2} \\ \text{MAX} \boxed{3} \end{array} \right] \\
 \text{NOUN-DIM} \quad \boxed{1} \\
 \text{INIT} \quad \left[\begin{array}{l} \textit{stage} \\ \text{DEG} \boxed{2} \end{array} \right] \\
 \text{FIN} \quad \left[\begin{array}{l} \textit{stage} \\ \text{DEG} \boxed{3} \end{array} \right]
 \end{array} \right]
 \end{array}$$

Figure 6.45: Frame representations of the determinate motion verb *bežat* ‘to run’ (left) and of the verb *perebežat* ‘to run across’ (right)

the noun. The event starts at the minimum point of the path and ends at the maximum point of the path. This frame is shown on the right side of Figure 6.45.

What is still missing in this frame is the specification of the path that has to come from the noun. This has to be a closed path across the object the noun refers to. I propose to use a dimension constructor that takes as its input any object that has width or diameter (or, probably, some other attribute) and outputs a path across this object. This path is probably still underspecified, as information from the context is needed to find out at least on which “side” of the landmark the movement starts. So if we start with a dictionary noun representation, such as shown on the left side of Figure 6.47, it can be unified with the constructor shown on Figure 6.46. This constructor is similar to those we have already seen. It specifies the NOUN-DIM attribute of the event as being of type *path*. This path is located in the LOC of the landmark. The extreme points of this path belong to the set of the edge points of the landmark. There should be an extra condition that ensures that the path goes to the “opposite” side, but this is hard (if possible) to formalise (at least in the purely semantic terms and especially for such objects that do not have distinct edges, e.g., a lake), so I will leave this problem for future research.

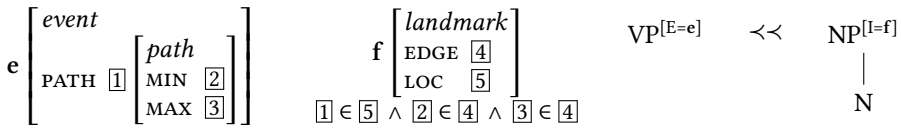

Figure 6.46: Path dimension constructor

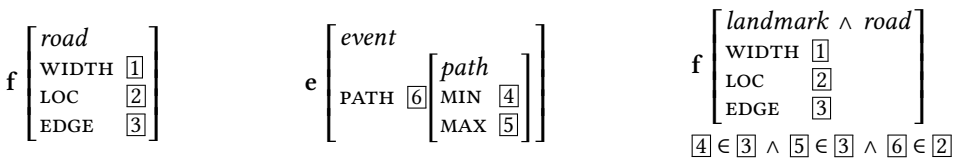

Figure 6.47: Frame representations of the noun *doroga* ‘road’ (left) and of its unification with the path dimension constructor (right)

Now we are ready to combine the verbal frame that is shown on the right side of Figure 6.45 with the noun representation that is unified with the dimension constructor (shown on the right side of Figure 6.47). The result of the unification is provided on Figure 6.48. In the derived frame the noun contributes information about the path across the landmark that becomes the measure dimension of the event.

6 Frame semantics for prefixes

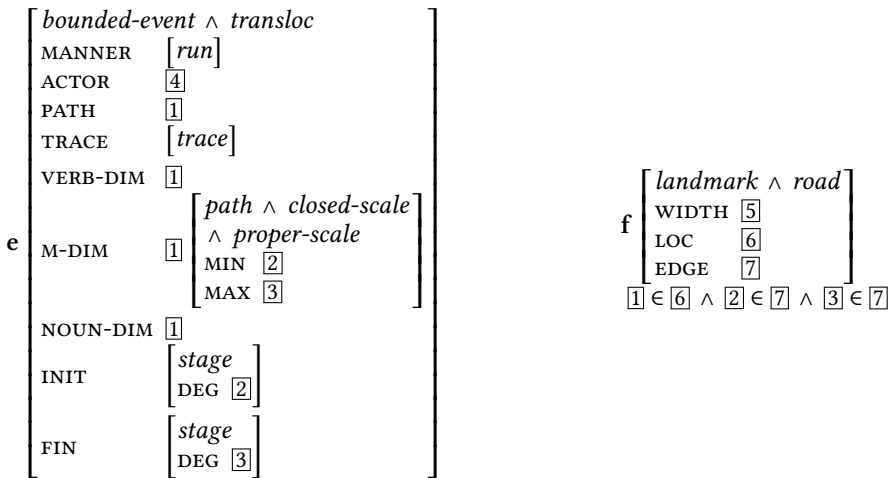

Figure 6.48: Frame representation of the verbal phrase *perebežat' dorogu* 'to run across the road'

To illustrate how the distributive interpretation of the verb is obtained with the same prefix frame, let us take the verb *lopat'* 'to burst' and the noun *šar* 'balloon' that we have already used to illustrate the distributive usage of the prefix *po-*. The resulting frame representation of the phrase *perelopat' šary* 'to burst all the balloons' is shown on Figure 6.49 and differs from the frame for the phrase *polopat' šary* 'to burst the balloons' shown on Figure 6.40 only with respect to the type of the scale that represents the measure dimension. Now the type is not *measure-of-change*, but *proper-scale*. This means that the scale description now contains not only the extreme points, but also all the natural numbers between zero and the cardinality of the set of balloons. So the iteration of the bursting sub-events now has to proceed from zero burst balloons to one burst balloon, to two burst balloons, etc. No simultaneous bursting of two or more balloons is allowed. The *proper-scale* type is a compact way to encode this difference between two distributive interpretations.

6.5.2 Excessive interpretation

The next sub-meaning of the prefix *pere-* that we are going to discuss occurs if the scale has only one marked point. In this case the initial stage of the event is associated with some point of the scale that lays below the marked point and the end stage of the event is associated with some point of the scale that lays above the marked point. Often this point would be the same as the threshold value that

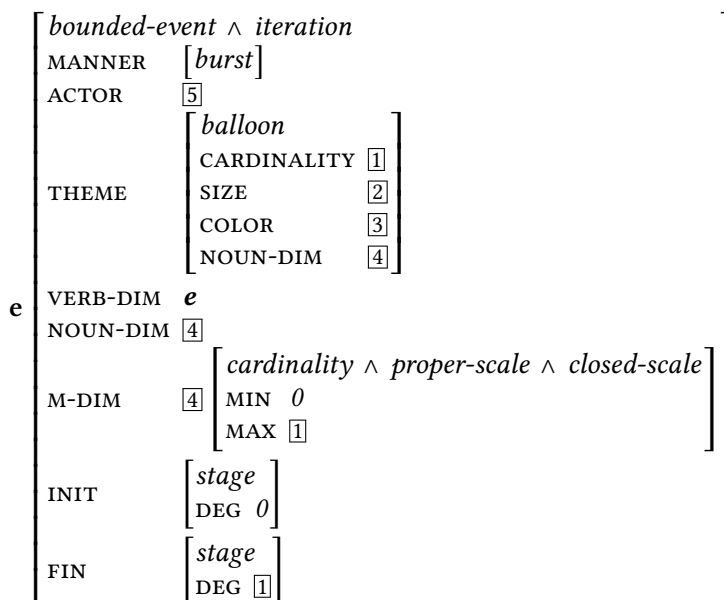

Figure 6.49: Frame representation of the verbal phrase *perelopat' šary* 'to burst all the balloons'

we have used for the prefix *na-*. Similarly to the case of the distributive/crossing usage of the prefix *pere-* that we have considered above, the measure dimension should correspond to the dimension provided by the noun. The frame that encodes these ideas is provided on Figure 6.50.

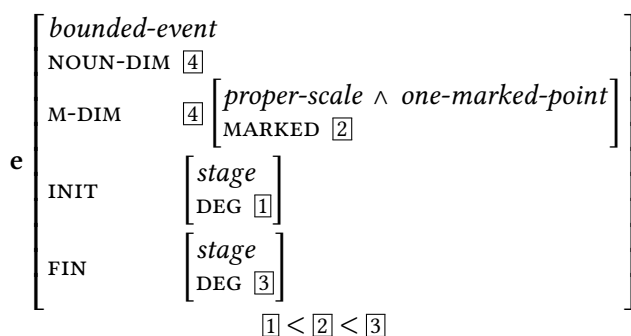

Figure 6.50: Frame representation of the prefix *pere-*: case of a scale with one marked point

6 Frame semantics for prefixes

Let us see what happens if this prefix usage is combined with the verb *gret* ‘to heat’ and the noun *sup* ‘soup’ that we have discussed above. The frame on Figure 6.51 represents the semantics of the verb *peregret* ‘to overheat’ obtained by the unification of the frame on Figure 6.50 with the frame on Figure 6.21. It refers to a bounded change of state with manner *heat* that starts with the temperature of the theme being below the marked point and ends with the temperature of the theme being above the marked point.

e	<i>bounded-event</i> \wedge <i>change-of-state</i>	
	MANNER	[<i>heat</i>]
	ACTOR	[5]
	THEME	[6]
	NOUN-DIM	[4]
	VERB-DIM	[4]
	M-DIM	[4] [<i>proper-scale</i> \wedge <i>one-marked-point</i> \wedge <i>temperature</i>] [MARKED 2]
	INIT	[<i>stage</i>] [DEG 1]
	FIN	[<i>stage</i>] [DEG 3]

Figure 6.51: Frame representation of the verb *peregret* ‘to overheat’

Next we combine the frame for the verb *peregret* ‘to overheat’ with the frame for the noun *sup* ‘soup’ that has been unified with the temperature dimension constructor. As a result, as expected, we obtain the frame that describes an event of heating of the soup that starts from the temperature lower than the marked temperature (marked temperature in this case is the same as the threshold value in case of the *na*-prefixed verb) and ends when the temperature is greater than the marked temperature.

The next class of derivational bases to which the same frame for the prefix *pere-* can be attached is constituted by directed motion verbs such as *letet* ‘to fly’. The frame for the base verb, shown on Figure 6.53 is similar to that of the verb *bežat* ‘to run’ (Figure 6.45).³ The only difference is the value of the *MANNER* attribute.

³The verb *bežat* ‘to run’ cannot be used in combination with the discussed interpretation of the prefix *pere-*. I cannot tell the exact reason for this, but it seems to be related to the granu-

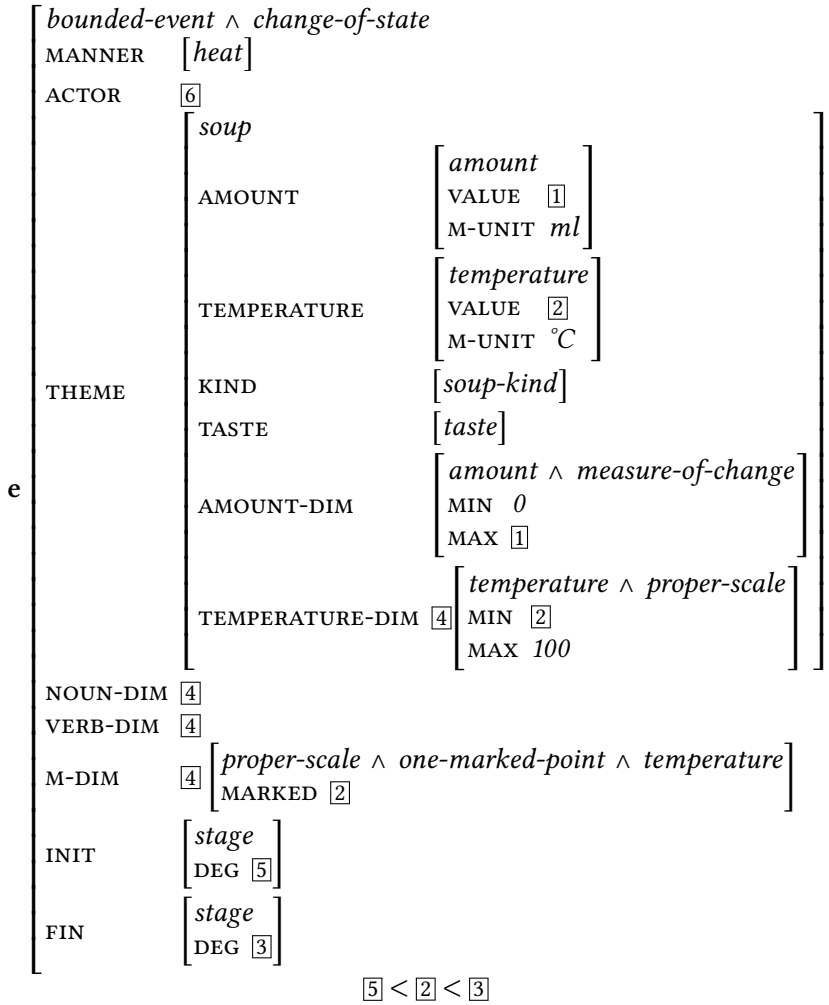

Figure 6.52: Frame representation of the verbal phrase *peregret' sup* 'to overheat the soup'

e	<i>transloc</i> MANNER [<i>fly</i>] ACTOR [1] TRACE [<i>trace</i>] PATH [2] [<i>path</i>] VERB-DIM [2] M-DIM [2]
---	--

Figure 6.53: Frame representation of the determinate motion verb *letet* 'to fly'

When the frame for the verb *letet* 'to fly' is unified with the frame representation of the prefix *pere-* (Figure 6.50), we obtain the frame shown on Figure 6.54. This frame describes a bounded translocation event of manner *fly* that starts at some point of the path below the marked point and ends at some point of the path that is above the marked point. The marked point has to be provided by the noun, as the nominal dimension is equated to the measure dimension of the whole event.

For this to be possible, the object has to be conceptualised as having an almost zero width (or the width smaller than one unit of motion, e.g., one step). The marked point is then the coordinate of the crossing place that can be obtained by intersecting the motion vector with the representation of the object. It is probable that only the projections on the two dimensional space (surface of the group) are considered while finding this point and constructing the relevant path. I will not describe the mechanism of finding this point and just assume that it exists and provides the relevant point based on the information about the location of the object. As shown on Figure 6.55, the constructor that generates this type of the measure dimension also sets the value of the *WIDTH* attribute to *epsilon* and uses a constraint that the marked point has to belong to the set of points provided as a value of the *LOC* attribute.

If the representation of the verb *pereletet* 'to fly over', shown on Figure 6.54, is combined with the representation of the noun *doroga* 'road' that provides information about a one point scale, we obtain the frame shown on Figure 6.56.

larity. The 'over' meaning of the prefix *pere-* arises with all semelfactive motion verbs, such as *prygnut* 'to jump once' and with some but not all activity-denoting motion verbs. The latter class probably can be described as those verbs that refer to a manner of motion that cannot be denoted by a semelfactive verb. My analysis does not explain the difference between the verbs *bežat* 'to run' and *letet* 'to fly' in this respect and I hypothesise that this difference lays outside of the semantic domain.

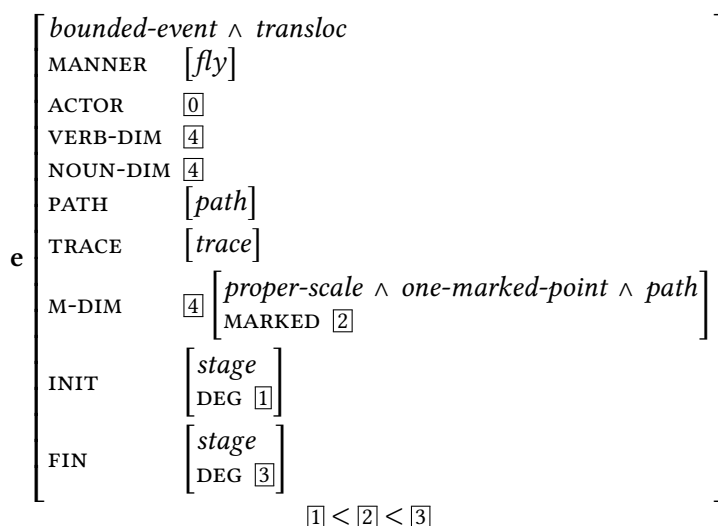
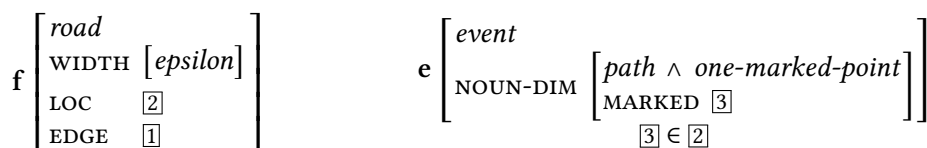
Figure 6.54: Frame representation of the verb *pereletet* ‘to fly over’Figure 6.55: Frame representation of the noun *doroga* ‘road’ unified with the constructor of one point path

Note that the representation of the accusative noun does not become a value of any attribute and stays connected only through the relation of inclusion of the marked point into the path. Such representation of a relation between a path-related landmark and the motion along the path is also used in the analysis of English motion expressions proposed in Kallmeyer & Osswald 2013, e.g., for the sentence *John walked along the brook* (Kallmeyer & Osswald 2013: 32, Figure 23).

As in this case the measure dimension of the event is the noun dimension, the same noun enriched with the crossing interpretation (as shown on the right of Figure 6.47) cannot be combined with the verb *pereletat* ‘to fly over’ as shown on the Figure 6.54. The conflict that arises in this case is due to the constraint (11) and is marked on Figure 6.57.

$$(11) \quad \textit{one-point-scale} \wedge \textit{closed-scale} \rightarrow \perp$$

6 Frame semantics for prefixes

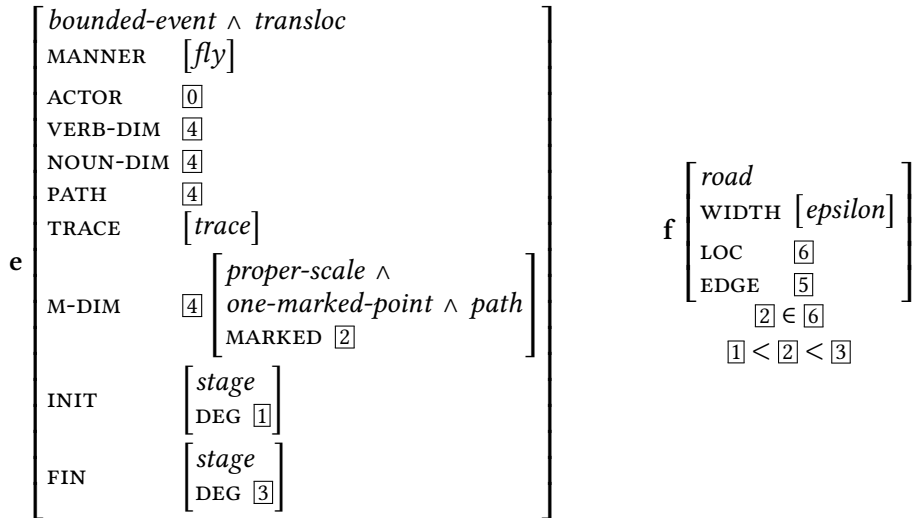

Figure 6.56: Frame representation of the verbal phrase *pereletet' dorogu* 'to fly over the road'

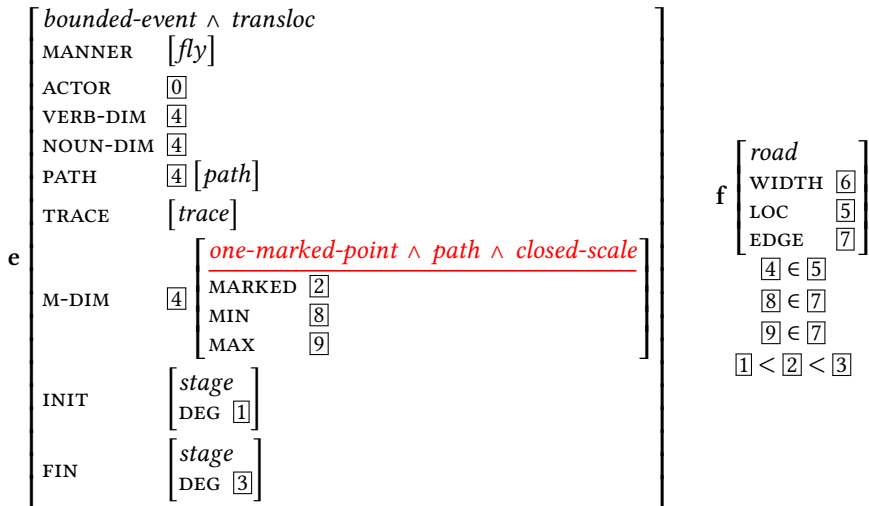

Figure 6.57: Failure of unification of the frames for the verb *pereletet'* 'to fly over' and for the noun *doroga* 'road' enriched with the information of a path across it

The last case I want to show with respect to the excessive interpretation of the prefix *pere-* is the case where this prefix can be translated with the English prefix *out-*, as in *perežit'* 'to outlive'. So let us start with the frame for the verb *žit'* 'to live', that is shown on the right side of Figure 6.58. The event of living is measured in terms of time, therefore we use the event itself as a measure dimension. As a next step, we unify the frame for the verb *žit'* 'to live' with the frame for the prefix *pere-* that makes use of a one point scale (Figure 6.50) and obtain the frame shown on the right side of Figure 6.58.

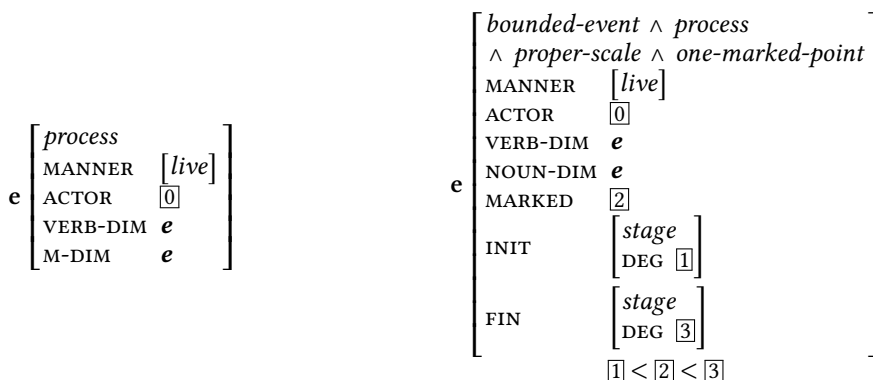

Figure 6.58: Frame representation of the verbs *žit'* 'to live' (left) and *perežit'* 'to outlive' (right)

Now the noun that is used as a direct object has to provide information about the time point that can be used as a marked point. First let us do it with a noun that can be seen as referring directly to such point, e.g., *uragan* 'hurricane'. The frame for this noun is provided on the left side of Figure 6.60. The constructor on Figure 6.59 can be used in case the hurricane is viewed as an event of a relatively short duration so that it is represented as a point on the time scale. (If the same event is regarded as having a significant duration, a closed time scale with the initial and final points corresponding to the start and end of the hurricane can be obtained using another constructor.)

If the enriched noun representation is combined with the representation of the verb *perežit'* 'to outlive', the resulting frame describes a bounded process of living of the (yet unspecified) actor that started before the hurricane time and ended after it. This frame is shown on Figure 6.61. As in the case of crossing the road, the hurricane is not an argument of the verb and the two frames are only connected via the identity of the values of the attributes NOUN-DIM.

The extraction of the marked point on the time scale can be also performed with nouns that lack explicit time points, such as person names like *Maša* 'Masha'.

6 Frame semantics for prefixes

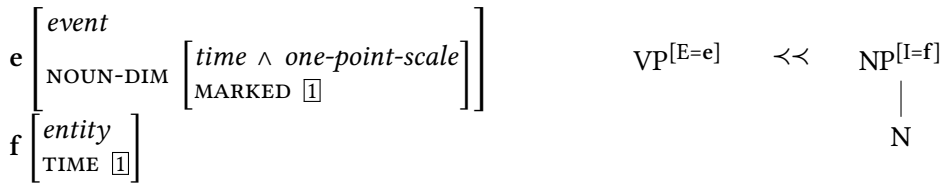

Figure 6.59: Time scale constructor: case of a scale with one marked point

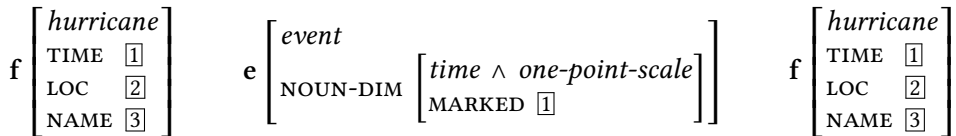

Figure 6.60: Frame representations of the noun *uragan* ‘hurricane’: dictionary entry on the left and the result of the unification with the time scale constructor on the right

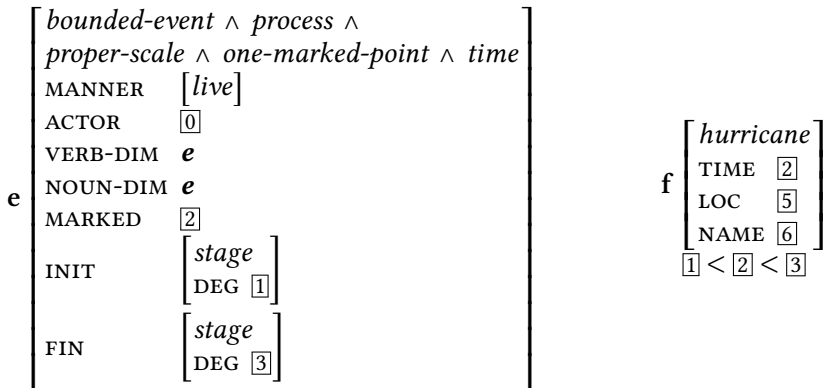

Figure 6.61: Frame representation of the verbal phrase *perezhit’ uragan* ‘to survive the hurricane’: dictionary entry on the left and enriched representation on the right

Of course, such extraction requires a more complex procedure that cannot be described in detail here, but the idea is that some significant point related to the event type denoted by the verb is extracted using a special constructor. In case of the event of living and a person *Maša* ‘Masha’ this point should be the time of Masha’s death. To obtain it, one can use the constructor that creates a representation of the event of living of Masha from the representation of the name *Maša* (using the representation of the derivational base for the *pere*-prefixed verb, so in our case the frame on Figure 6.58). The tentative result of an application of such a constructor is shown on Figure 6.62.

e	<i>process</i>	
	MANNER	[<i>live</i>]
	ACTOR	[<i>Masha</i>]
	NOUN-DIM	[<i>time</i>]
	VERB-DIM	e
	M-DIM	e
	MIN	[1]
	MAX	[2]

Figure 6.62: Frame representation of the referent of the name *Maša*, coerced into event interpretation using the verb *žit* ‘to live’

Now let us combine the frame representation of the verb *perežit* ‘to outlive’ and the representation of *Maša* interpreted as an event of living of Masha that provides as a marked point Masha’s time of death. Let us also fill the ACTOR slot with the referent of the name *Vasya*. With this, we obtain the frame representation of the tenseless variant of the phrases *Vasja perežil/pereživët Mašu* ‘Vasya outlived/will outlive Masha’. This representation is provided on Figure 6.63 and contains the following information: the sentence describes a bounded event e of living of Vasya. There is another event f of living of Masha, that is not central but is used for the comparison. The main event e started at the time prior to the maximum point of living of Masha (point of Masha’s death) and ended or will end at the time after the time of Masha’s death. The relation between the time of Vasya’s life and the time of Masha’s birth is not specified.

To complete the picture, let us consider the verb *igrat* ‘to play’. This verb does not provide a preselected measure dimension, so there is some freedom with respect to the selection of a relevant parameter of the direct object. The frame for the verb *igrat* ‘to play’ is shown on the left side of Figure 6.64.

6 Frame semantics for prefixes

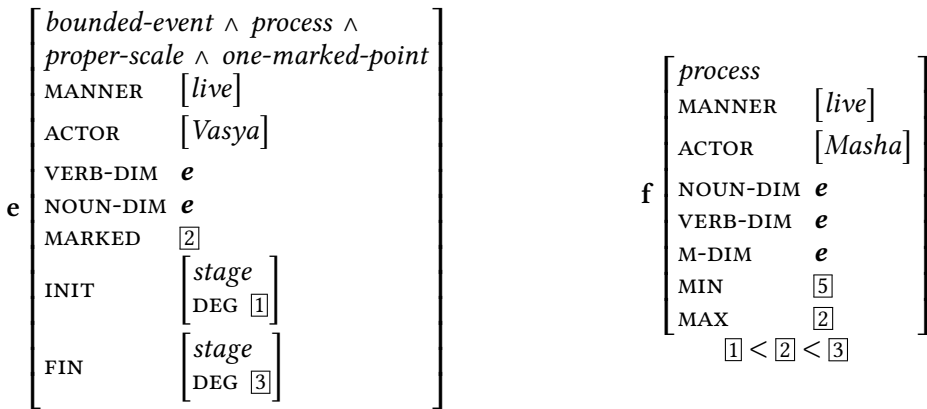

Figure 6.63: Frame representation of the tenseless variant of the phrases *Vasja perežil/pereživët Mašu* ‘Vasya outlived/will outlive Masha’

When the representation of the verb *igrat’* is combined with the representation of the prefix *pere-* that is compatible with a marked point scale, we obtain the frame shown on the right side of Figure 6.64 that represents the semantics of the verb *pereigrat’* ‘to outplay’: a bounded event of MANNER *play* that ends at a point of the scale above the marked point.

The type of the scale and the marked point remain underspecified and need to be identified using the information about the direct object. I propose to use the same strategy as above: if the direct object is a referent of the name *Maša*, the dimension constructor is based on the frame for the verb *igrat’* ‘to play’ to obtain an event of Masha playing that has some parameters, such as duration of the play or the quality of the play. As we have discussed in Section 4.6, such sentences as *Vasja pereigrat Mašu* ‘Vasya outplayed Masha’ are ambiguous and hard to interpret without the context that would provide the relevant parameter. The representations that can be obtained as a result of such complex scale extraction procedure are shown on Figure 6.65: the time-related interpretation on the left side and the quality-related interpretation on the right side.

On the last step one of these representations gets combined with the frame for the verb *pereigrat’* ‘to outplay’ (let us take the quality interpretation) and the resulting frame denotes an event of playing by some ACTOR where the end of the playing event is associated with a higher value on the quality scale than the marked point that is the quality of Masha’s playing.

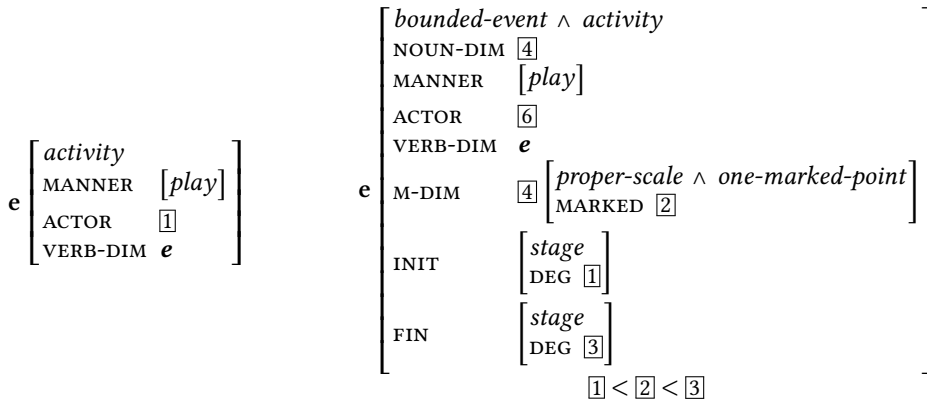

Figure 6.64: Frame representations of the verbs *igrat* ‘to play’ (left) and *pereigrat* ‘to outplay’ (right)

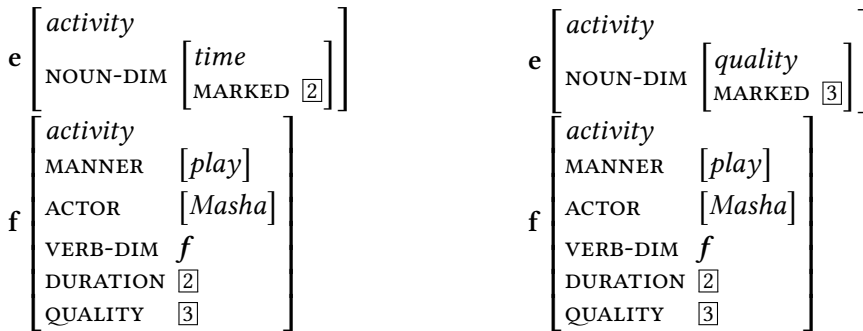

Figure 6.65: Frame representations of the referent of the name *Maša*, coerced into event interpretation using the verb *igrat* ‘to play’ and then enriched with measure dimension information

6.5.3 Iterative interpretation

The last usage of the prefix *pere-* that I provide a frame for is iterative and arises when the measure dimension of the event denoted by the derivational base is of type *property-scale*. This event then becomes a value of the preparatory phase attribute of the new event. The initial and the final stages, the noun dimension, the measure dimension, and the manner attributes are copied to the event node that refers to the new event.

The next restriction, apart from the property type of the scale, is that the event denoted by the derivational base must have a final stage in its representation. This means that a simplex imperfective verb cannot be combined with this prefix usage, unless it is coerced into a bounded event. On the formal side it means that

6 Frame semantics for prefixes

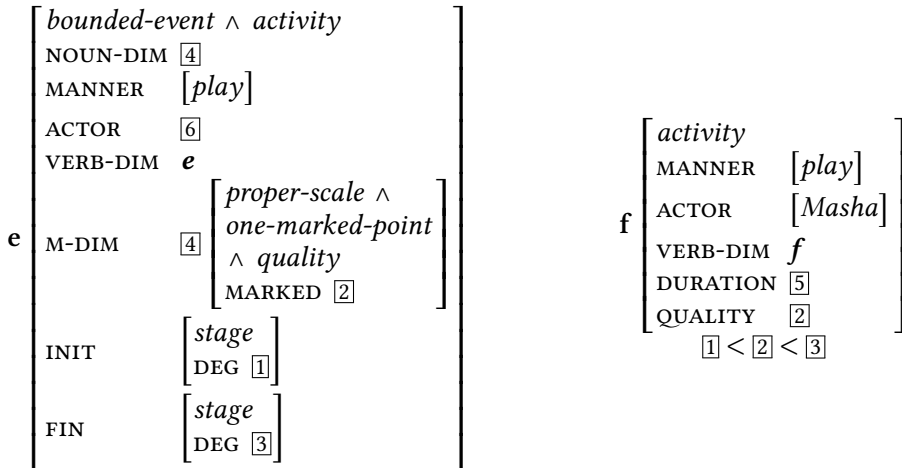

Figure 6.66: Frame representation of the verbal phrase *pereigrat' Mašu* 'to outplay Masha'

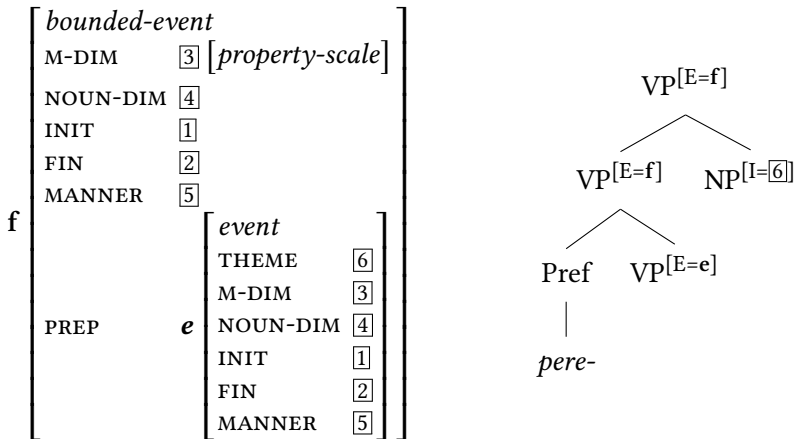

Figure 6.67: Representation of the contribution of the prefix *pere-*: case of a property scale

we need a way to formulate the requirement on the frame (presence of the finat-tribute). For implementing the coercion of an unbounded event into a bounded event I propose to use the frame shown on Figure 6.68. On the syntactic side it is accompanied by the introduction of an extra VP node.

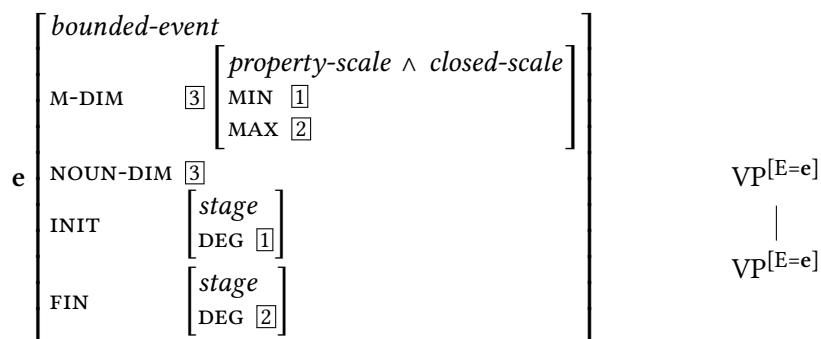

Figure 6.68: Frame and tree for coercion of an unbounded event into a bounded event

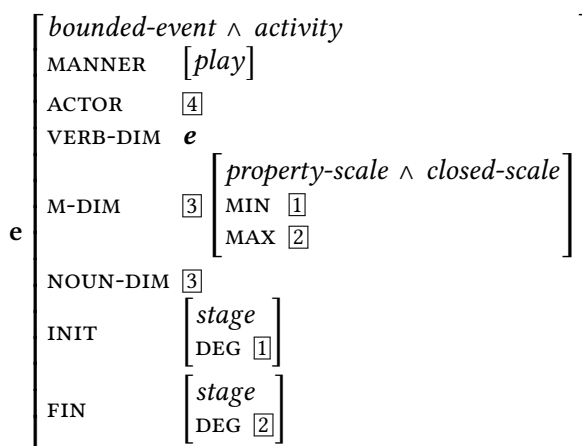

Figure 6.69: Frame of the verb *igrat'* 'to play', coerced into a bounded event interpretation

Now if we take an imperfective verb, such as *igrat'* 'to play', and first coerce it using the frame on Figure 6.68 (this operation is performed in the metagrammar and its result is shown on Figure 6.69) and then attach the prefix *pere-* with the semantic representation shown on Figure 6.67, we obtain the frame shown on Figure 6.70. This frame describes a bounded event of manner *play* that is measured along the property scale, the initial stage being located at the minimum

of the scale and the final stage being located at the maximum of the scale. In addition, there is a preparatory phase that refers to another event with similar characteristics.

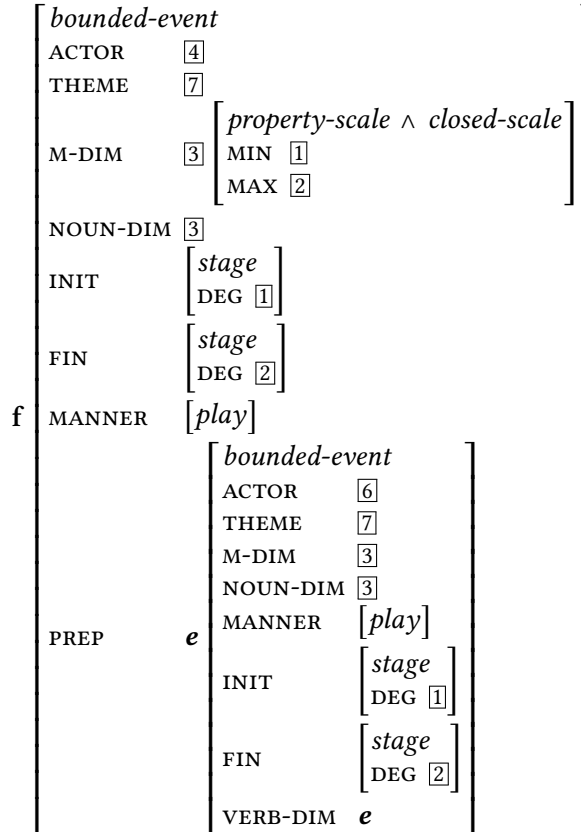

Figure 6.70: Frame representation of the verb *pereigrat* ‘to replay’

When the verb *pereigrat* ‘to replay’ is used, an appropriate noun, probably unified with some dimension constructor, should occupy the position of the theme and contribute additional information about the scale. Let us take the noun *partija* ‘match’ that is probably characterized by duration, the type of the game it is a match of, and the set of players (see the left side of Figure 6.71). We are interested in particular in the DURATION attribute as it is the only parameter that can bind the event. As we have already seen before, this attribute can be used to enrich the representation with the measure dimension information, as shown on Figure 6.71.

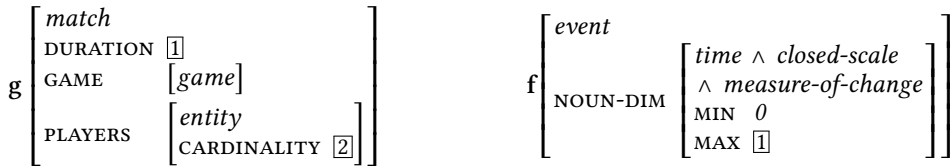

Figure 6.71: Frame representations of the noun *partija* ‘match’ (left) and of an additional component that is obtained as a result of its unification with the dimension constructor (right)

As a final step, we can now combine the frames on Figures 6.70 and 6.71 and obtain the frame shown on Figure 6.72 (page 284). This frame describes a bounded event of playing that is preceded with another such event and both events are measured out according to the duration of the match.

6.6 Frame semantics for the prefix *do-*

The last prefix I will provide a frame for is the prefix *do-*. As we have discussed in Chapter 4, primarily following Kagan (2015), this prefix has completive or additive semantics: it can refer to the terminal part of the event or an event that can be seen as a continuation of another event. In Section 4.7 I came to the following conclusions with respect to the selection of the scale for the measure dimension: the first choice is the pre-specified verbal scale, next comes the scale extracted from the representation of the noun, and the last option is the event scale.

This scheme can be realised by identifying the values of the measure dimension and the noun dimension attributes and adding an extra rule that would equate the verbal dimension with the measure dimension for intransitive verbs. When the prefix is attached, the maximum of the scale has to be associated with the final stage of the event. The frame that realises these ideas is shown on Figure 6.73 (page 285). Note that attributes in frame semantics are functional, so the attribute *PART-OF* has to satisfy this restriction as well. To ensure this, I propose to define the value of this attribute as the maximum event that the event in question is part of. In particular, it would be an event that proceeds from the minimum to the maximum degree on the relevant scale (provided by the *m-dim* attribute). The scale has to be closed in order for the value of the *PART-OF* attribute to be defined.

Similarly to the iterative usage of the prefix *pere-*, the prefix *do-* can be only attached to bounded events. This means that, again, simplex imperfective verbs need to be first coerced into a bounded interpretation. For coercion I propose to

6 Frame semantics for prefixes

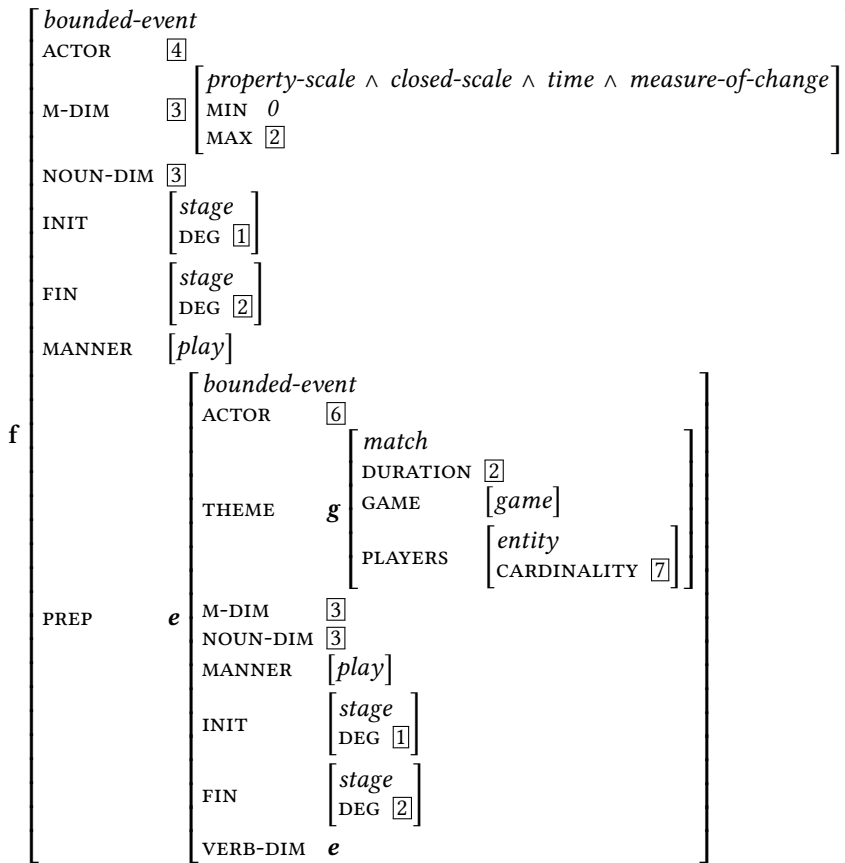

Figure 6.72: Frame representation of the verbal phrase *pereigrat' partiju* 'to replay the match'

use the same frame as we have used before when combining the verbs with the prefix *pere-*: coercion frame shown on Figure 6.68. As we have already performed coercion for the verb *igrat'* 'to play', let us see how the prefix *do-* attaches to this verb. For this, we take the frame on Figure 6.73 and use the frame on Figure 6.69 as a base event identified as *e* in the frame on Figure 6.73. As a result we obtain the frame shown on Figure 6.74 that refers to a bounded event that is part of another event. The scale of the new event is also a part of the scale of the event denoted by the derivational base.

To make clear why the complicated rules of how the measure dimension is constructed are needed, let me show what happens when the direct object comes into play and how the verb prefixed with *do-* once differs from the verb prefixed

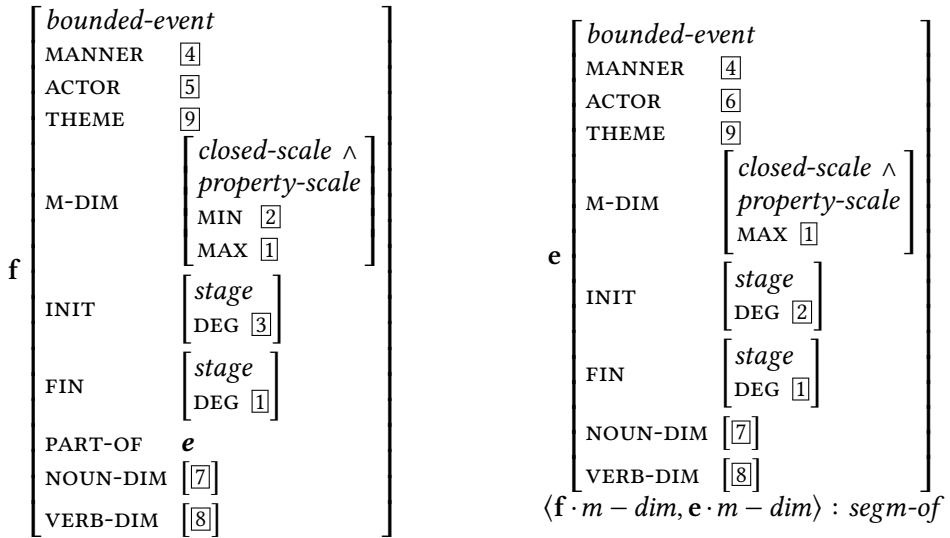

Figure 6.73: Frame representation of the prefix *do-*

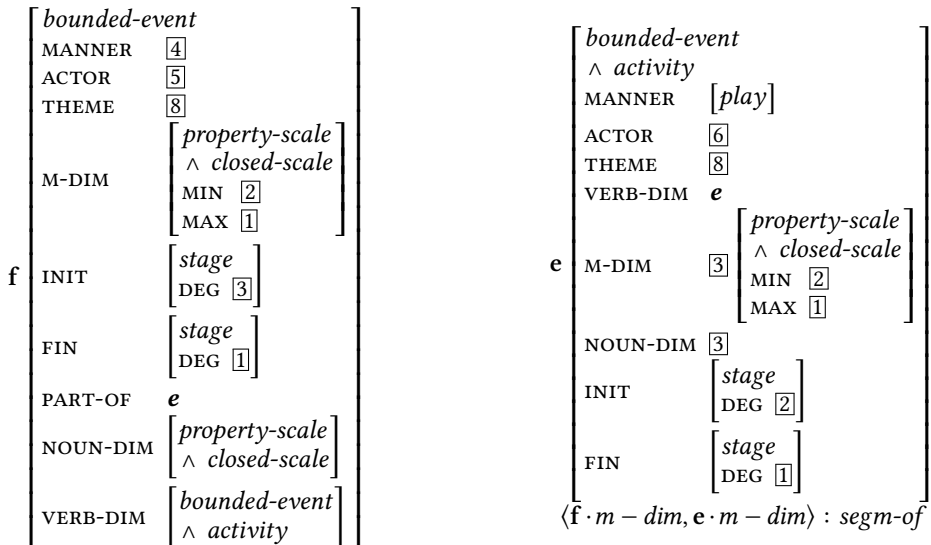

Figure 6.74: Frame representation of the verb *doigrat* ‘to finish playing’

with the same prefix twice. The frame on Figure 6.75 shows the representation of the phrase *doigrat' partiju* 'to finish playing the match', formed using the frame on Figure 6.74 and the frame on the right side of Figure 6.71. It is important to note that the information that comes from the direct object is unified at the deepest relevant level: this means that for a non-suffixed verb with multi-event representation it would be always the representation of the event denoted by the base verb. In case of the prefix *pere-*, despite the multi-layer representation, this did not play a role, as all the information is passed to the higher layer without changes. Here, however, the THEME is identical for the partial event and the whole event, but the noun dimension of the new event only inherits the type of the scale and not the values of the extreme points. Instead, a new scale of the same type, but probably with a different MIN point, is constructed.

As one can see on Figure 6.75, in this case the measure dimension of the partial event is the same as the measure dimension of the whole event. It is different when two prefixes are stacked, as in the verb *dodoigrat'* 'to finish playing the final part'. One would like to see a different semantic representation in this case, while otherwise such verb could not be used, as it would violate the pragmatic principles. Under the analysis I propose here, the verbal phrase *dodoigrat' partiju* 'to finish playing the final part of the match' receives the frame representation shown on Figure 6.76 (this frames makes reference to the frame shown on Figure 6.75). So the event denoted by the verbal phrase *dodoigrat' partiju* 'to finish playing the final part of the match' is an event of playing that does not necessarily start from the minimum of the scale and the minimum of the scale is not bound to the beginning of the match. Such a frame still allows the interpretation that the new event refers to an event of playing the whole match, but this will be blocked by pragmatic reasoning.

Let me show what happens when the prefix *do-* is attached to a verb that has a pre-selected measure dimension. Consider a determinate motion verb *bežat'* 'to run' that we have used earlier in combination with the prefix *pere-* (see Figure 6.45). The basic verb *bežat'* 'to run' also has to be coerced before prefixation, so instead of doing this step (that would be similar to the procedure above, illustrated by the verb *igrat'* 'to play'), let us take as an input the prefixed verb *perebežat'* 'to cross'. The result of combining the frame representation of the verb *perebežat'* 'to cross' (right side of Figure 6.45) with the frame representation of the prefix *do-*, shown on Figure 6.73, is provided on Figure 6.77. This verb denotes an event that is a part of an event of crossing the road and necessarily includes the final part of the crossing.

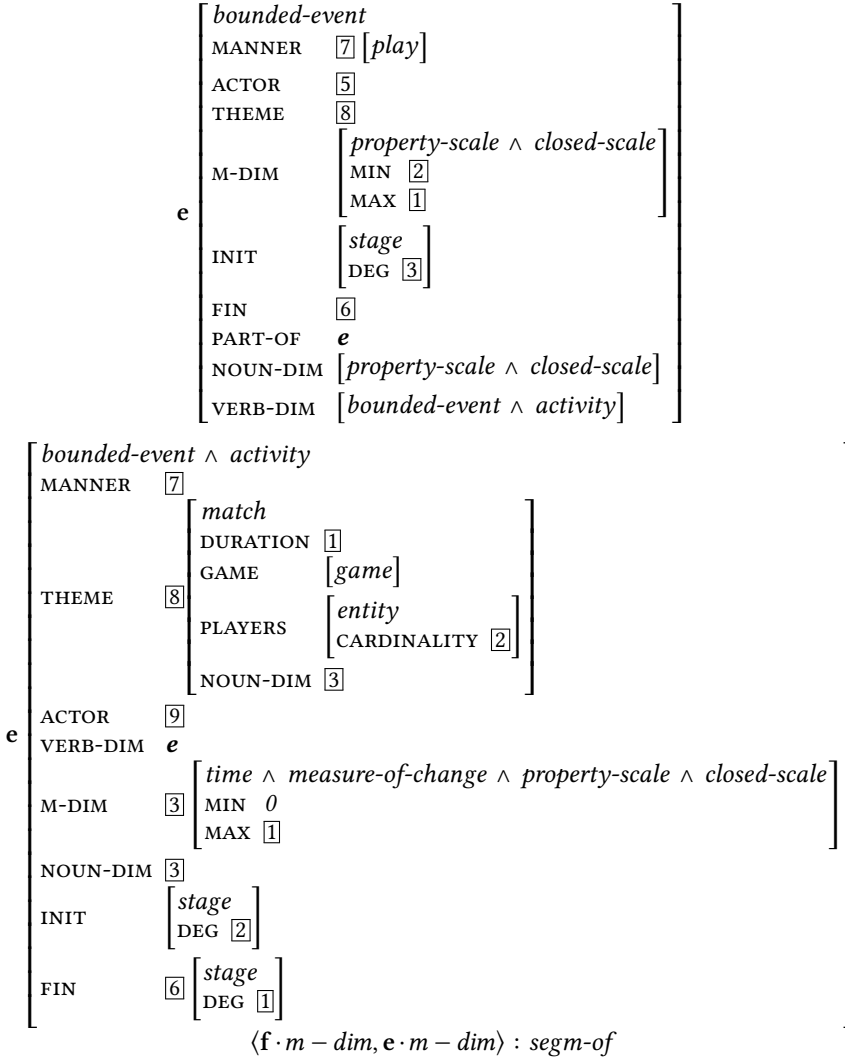

Figure 6.75: Frame representation of the verbal phrase *doigrat' partiju* 'to finish playing the match'

g	<i>bounded-event</i>	
	MANNER	7 [play]
	ACTOR	4
	THEME	8
	M-DIM	<div style="border-left: 1px solid black; padding-left: 10px;"> $time \wedge measure-of-change \wedge property-scale \wedge closed-scale$ MIN 3 MAX 1 </div>
	INIT	<div style="border-left: 1px solid black; padding-left: 10px;"> stage DEG 10 </div>
	FIN	<div style="border-left: 1px solid black; padding-left: 10px;"> 6 <div style="border-left: 1px solid black; padding-left: 10px;"> stage DEG 1 </div> </div>
	PART-OF	<i>f</i>
	NOUN-DIM	[<i>property-scale</i> \wedge <i>closed-scale</i>]
	VERB-DIM	[<i>bounded-event</i> \wedge <i>activity</i>]

$\langle g \cdot m - dim, f \cdot m - dim \rangle : segm-of$

Figure 6.76: Frame representation of the verbal phrase *dodoigrat' partiju* 'to finish playing the final part of the match': additional component with respect to Figure 6.75

6.7 Summary

In this chapter I have proposed frame representations of the semantic contribution of five Russian verbal prefixes: *za-*, *na-*, *po-*, *pere-*, and *do-*. We have seen that these representations are quite distinct: in case of the prefix *za-* the derived verb refers to a transition that is connected with the event denoted by the derivational base via relations; the prefixes *na-* and *po-* both add information to the initial event frame, but differ with respect to the processes of dimension selection and assigning scale degrees to the initial and final stages of the event; the prefix *pere-* creates a new event with a preparatory phase consisting of the event denoted by the derivational base; and the prefix *do-* refers to a partial event that is constructed during the derivation with a probable change of the minimum point of the measure dimension scale.

We have also seen that in order to obtain the representation of the derived verb, several steps related to the scalar selection process have to be made. We need to select the dimension of the verb, the relevant dimension of the object, and find out the type of the scale that will be used for measuring the event. In some cases this scale is the event itself.

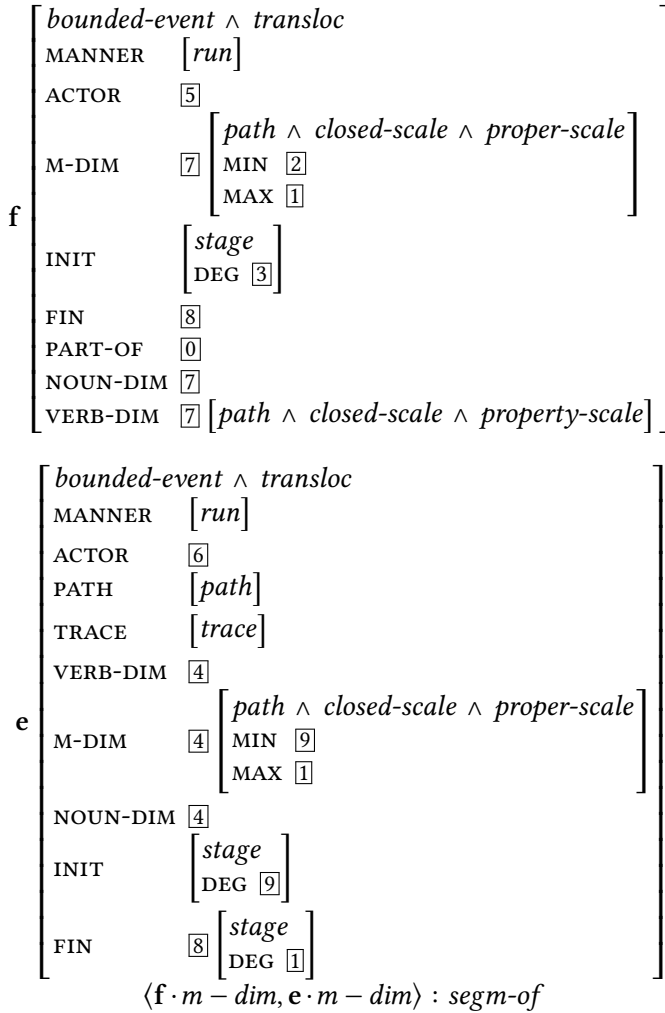

Figure 6.77: Frame representation of the verb *doperebežat* ‘to finish crossing’

As objects are often associated with different dimensions, I have proposed various constructors that allow to extract relevant information. Some of these constructors (e.g., temperature dimension constructor, Figure 6.24) can be applied without restrictions, some (e.g., amount dimension constructor, Figure 6.26) are accompanied by syntactic restrictions, and some (e.g., the constructor that reconstructs the event of living from the person's name) can be used only in special cases when the scalar interpretation is required and no other constructor can be applied. As modelling semantic representation and shifts of meaning of nouns is not the goal of this work, the proposed constructors will most probably require revisions, but they suffice to illustrate how the object can contribute to determining the interpretation of the prefixed verb.

The representations I have proposed here differ in their complexity: while frames for some prefixed verbs differ from the representations of the respective derivational bases only by the presence of several additional attributes (as in case of the prefixes *po-* and *na-*), frames for other prefixed verbs are a lot more complex (prefixes *do-* and *pere-*). A hypothesis that would be interesting to check empirically is whether in case of verbs that are represented using multi-layered frames the interpretation requires an increased amount of processing time relative to verbs with the same morphological complexity but less complex semantic representation.

In the next part, Chapter 7, I will show how frame representations proposed in this chapter can be implemented using a metagrammar compiler.

7 Implementation of the analysis using XMG

In Chapter 6 I have proposed a frame semantic analysis of various prefixes together with selected pieces of the syntax-semantics interface. In this chapter I present the implementation of the proposal.

In order to describe and provide a compact grammar description, one can use a metagrammar compiler. A TAG metagrammar is a reduced description that captures linguistic generalisations that appear in the trees that belong to the grammar (Candito 1999). EXtensible MetaGrammar¹ (XMG, Crabbé et al. 2013) is a formalism that allows to describe linguistic information contained in the grammar and a tool to compute grammar rules and produce a redundant strongly lexicalised TAG.

Among the properties of XMG that distinguish it from other grammar engineering environments, two are of particular importance for the current work. First, XMG is a declarative language, which means that it is based on constraints and not on procedures. This allows for an order-independent definition of grammaticality. Second, XMG's notation is highly expressive: in particular, various linguistic dimensions are treated in a modular way, and grammatical units can be disjoint, conjoint, and inherited.

XMG 2 (Petitjean et al. 2016) is a tool that is used to create metagrammar compilers, adapting them to specific needs. Whereas XMG supports three independent levels of description: syntactic trees (syn), semantic predicate structures (sem), and dynamic interfaces between syn and sem (dyn), XMG 2 allows to introduce additional dimensions. The compiler I am using for the current implementation is created using XMG 2 and has a syntactic (syn) and a frame semantic (frame) dimension (Lichte & Petitjean 2015).

The syntactic dimension is described using the following elements: first, all the nodes are declared using the keyword `node` and a variable name. These declarations are accompanied by optional marks (in brackets) and syntactic features (in square brackets, separated by commas). Values of syntactic features can be either specified or represented by a variable to ensure the same value of the feature

¹<http://xmg.phil.hhu.de/>

across the nodes without specifying it. Second, the relations between the nodes are stated. I will use the following relations (x and y range over node variables): $x \rightarrow y$ for the immediate dominance of the node x over the node y ; $x \rightarrow +y$ for the dominance (reflexive transitive closure of the immediate dominance relation) of the node x over the node y ; $x \gg y$ for the immediate precedence of the node x ; and $x \gg +y$ for the precedence (transitive closure of the immediate precedence relation) of the node x .

XMG is designed to output unanchored TAG elementary trees, but as currently there is no parser that would take into account frame semantic dimension, I simulate the insertion of lexical anchors in the metagrammar. This solution leads to a more complicated metagrammar architecture, but allows to see the results in a form that can be easily understood. If I were to output the unanchored trees only, I would obtain prefixation schemes but the stem that carries important information would not be inserted, which would make it very hard to check the predictions.

The implemented grammar fragment I want to show contains the following elements: a noun *rasskaz* ‘story’, a verb *pisat* ‘to write’, a prefixed verb *zapisat* ‘to write down’, prefixes *po-* (delimitative and distributive interpretations), *pere-* (repetitive and distributive interpretations), and *do-*, and imperfective suffix *-iva-* (iterative and progressive interpretations). With this inventory I construct verbs with a maximum of four affixes (can be realised if the a base verb is prefixed two times, then suffixed, and then prefixed again). This architecture in principle allows to construct more than 1000 verbal phrases, out of which the compiler outputs 88 models. Nine of those models have to be filtered out later by the pragmatic module, but those numbers show that most of the work is done by the constraints from the syntax-semantics part.

In this chapter I will show fragments of the implementation and explain decisions that I had to make. The whole code and the corresponding output of the compiler are provided in Section B.1 of Appendix B. In the last section I will present an implementation of the analysis proposed in Tatevosov (2009) (code provided in Section B.2 of Appendix B) that is done using the same tools. I will then compare the outputs of two implementations. Both implementations and the xml files that are output by the compiler are also available online².

²<https://user.phil-fak.uni-duesseldorf.de/~zinova/XMG/index.html>

7.1 Type hierarchy and constraints

The code starts with the three unicity constraints shown on Figure 7.1 that prevent the appearance of some features more than once in the same elementary tree. The first constraint is a standard one, as it ensures that each tree has one lexical anchor. The second constraint has to be introduced because I use XMG not only for constructing the unanchored trees, but also for the insertion of the lexical anchors. This constraint allows to make sure that only one noun is inserted in the accusative noun slot.

```
use unicity with (mark=anchor) dims (syn)
use unicity with (mark=nounacc) dims (syn)
use unicity with (iteration=yes) dims (syn)
```

Figure 7.1: XMG code: unicity constraints

The third constraint restricts the appearance of the *iteration* feature to one per tree. The nature of this constraint is semantic and the natural way would be to locate it in the semantic dimension. This is, however, not yet implemented, so I copy the feature to the syntactic level and apply the unicity constraint in the syntactic dimension.

The next three sections introduce syntactic features, types associated with values of these features, and frame types. Here I want to note two more features that I had to “lift” to the syntactic level due to the fact that such feature checking inside the semantic dimension of XMG is not yet supported: *bounded* and *limited*. The feature *bounded* appears at those nodes that are associated with frames of *event* type. It gets the value *yes* if there is a path from the central node of the frame to an attribute *fin* that can proceed through the *PART-OF* attributes. If there is no such path, the value of the feature is *no*. The feature *limited* is a stronger version of a similar constraint: for *limited* to get the value *yes*, the central node has to have an attribute *fin* and its value has to be specific (concrete value or a bound variable). In all other cases the feature *limited* gets value the *no*.

We have discussed the crucial fragments of the type hierarchy in Section 6.1.4. Now all those restrictions plus some more constraints that are related to the nominal domain were left out from the previous discussion have to be formalised. Figure 7.2 shows a part of type constraints that states that *length* is a type of *scale*, in particular *property-scale*. This type is not compatible with a *cardinality* scale type which is always a *closed-scale*. The rest of the hierarchy is written in a similar way.

```

property-scale -> scale,
length -> property-scale,
cardinality property-scale -> -,
closed-scale -> scale
cardinality -> closed-scale,

```

Figure 7.2: A fragment of type hierarchy

7.2 Lexical anchors

In a proper implementation that would separate the metagrammar level from the syntactic level the following elements would not belong to the metagrammar, but would be used as lexical anchors for the appropriate tree families. The first entry is the noun that will be used to fill the object slot. I have selected the plural form of the noun *rasskaz* ‘story’ that has some length and also cardinality. The constraint on the unicity of the feature *nounacc* that I have shown above is used here to prevent multiple insertions of the accusative noun lexical anchor.

The description of the noun is straightforward: on the syntactic side, it is a daughter of the N category node and on the semantic side it contains relevant attributes. The two nodes (?N and ?Story) are declared in the first two lines of the syntactic domain description and connected via an immediate dominance relation in the third line. Both nodes are characterised with feature *i=?X0* which connects them to the semantic frame characterised in the frame dimension. The frame description states that the type of the frame ?X0 is *story* and it has two attributes: The label of the central node of the frame (?X0) as well as the syntactic nodes and relevant dimension-related variables are exported for future use.

The code for the class is shown on Figure 7.4. Note that I do not distinguish between top and bottom feature structures in the provided descriptions, as due to the absence of the adjunction in the implemented fragment the division into top and bottom parts is not relevant. Figure 7.3 shows the tree and the frame that are described by the code for the class *Story* (features of the syntactic dimension are omitted).

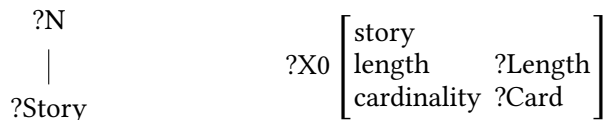

Figure 7.3: Tree and frame representation of the code in Figure 7.4

```

class Story
export ?Length ?Card ?N
declare ?N ?Story ?X0 ?Length ?Card
{
  <syn>{
    node ?N (mark=coanchor) [cat=n, num = pl, i=?X0];
    node ?Story (mark=nounacc) [cat=rasskazy, num = pl, i=?X0];
    ?N -> ?Story
  };
  <frame>{
    ?X0[story,
      length: ?Length,
      cardinality: ?Card
    ]
  }
}

```

Figure 7.4: XMG code: noun that is used to fill the accusative NP slot

Later this noun can enter one of the two dimension constructors: length or cardinality. The cardinality constructor code is shown on Figure 7.5. It should be available for all nouns that have a cardinality attribute with an additional restriction for plural number. The constructor creates a NP node that dominates the N node exported from the description of the noun, and a VP node that linearly precedes the NP node. The output of the class is a discontinuous tree, as shown by the tree on Figure 7.6. On the semantic side an m-dimattribute is created and the event description bounded to the VP node also acquires the type *iteration*. This is, as announced before, doubled via the iteration attribute on the syntactic side. The frame described by the frame part of the code is provided on the right side of Figure 7.6.

Another dimension constructor that I use, implemented in the class Noun-Length, is organised in a similar way with a difference that it creates a NOUN-DIM, not an m-dimattribute of the event, is available for nouns that have a LENGTH attribute independently of their number, and does not specify the event type.

The second group of lexical items consists of two verbs: *pisat'* 'to write' and *zapisat'* 'to write down'. The second verb contains the prefix *za-*, but its semantic contribution is not transparent, so the whole verb must be stored in the dictionary. The class that represents the verb *pisat'* 'to write' has a simple syntactic structure of two nodes (see Figure 7.7): the node of category V and the node that contains the verb itself, where the V node inherits all syntactic properties of the

7 Implementation of the analysis using XMG

```

class NounCardinal
export ?N ?NP ?VP
declare ?NCard ?X0 ?Card ?N ?NP ?VP ?Dim ?Theme ?Case ?Num
{
  ?NCard=Story[];
  ?NCard.?Card = ?Card;
  ?N=?NCard.?N;
  <syn>{
    node ?NP [cat=np, case=?Case, num = pl, i=?Theme];
    node ?VP [cat=vp, e=?X0, iteration = yes];
    node ?N (mark=coanchor) [cat=n, case = ?Case, num = pl, i=?Theme];
    ?VP >>+ ?NP;
    ?NP -> ?N
  };
  <frame>{
    ?X0[iteration,
      theme:?Theme,
      m-dim:[cardinality,
        min:[zero],
        max:?Card
      ]
    ]
  }
}

```

Figure 7.5: XMG code: constructor of the cardinality dimension

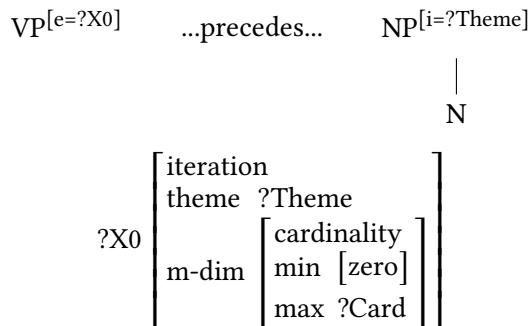

Figure 7.6: Tree and frame representation of the code provided on Figure 7.5

```

class Pisat
export ?V
declare ?V ?Pisat ?X0 ?Actor ?Theme ?Mean
{
  <syn>{
    node ?V (mark=anchor) [cat=v, e=?X0, asp = unbound, aspect = imperf];
    node ?Pisat (mark=flex) [cat=pisat, e=?X0, asp = unbound,
      aspect = imperf];
    ?V -> ?Pisat
  }
  ;
  <frame>{
    ?X0[event & process,
      actor:?Actor,
      theme:?Theme,
      mean:?Mean,
      manner:[write],
      verb-dim:?X0
    ]
  }
}

```

Figure 7.7: XMG code for representation of the verb *pisat* ‘to write’

verb, except for the category. The *aspect* feature, in contrast with the features *limited* and *bounded*, is a syntactic feature and carries information about the syntactic aspect of the verb represented by the respective node. For the frame semantic side, I use a simple representation that serves the purposes of the current analysis. I acknowledge that the fully elaborated representation may be more complex or just differ in details, but this should not influence the results of the current study.

The syntactic structure of the prefixed verb *zapisat* ‘to write down/record’ is more complex: the highest node is of category VP and under it a prefix node and another VP node are located. The internal VP node (VPInt in the code) is needed to make the structure of the dictionary-stored prefixed verb similar to the structure of prefixed verbs assembled in the metagrammar. On the semantic side this verb also differs from the verb *pisat* ‘to write’ a lot: it includes information about the measure dimension as well as about the initial and final stages of the event. The XMG code of the class that represents the verb *zapisat* ‘to write down/record’ is shown on Figure 7.8 and the result of the compilation of the class is provided on Figure 7.9.

7 Implementation of the analysis using XMG

```
class Zapisat
export ?VP ?VPInt ?VPBase
declare ?V ?Pisat ?Za ?ZaLex ?X0 ?Actor ?Theme ?ScMin ?ScMax ?AGR ?VP
?VPInt ?VPBase
{
  ?VPBase = ?VPInt;
  <syn>{
    node ?VP [cat=vp, agr=?AGR, e=?X0, asp = bound, aspect = perf];
    node ?V (mark=anchor) [cat=v, agr=?AGR, asp = unbound,
      aspect = imperf];
    node ?Pisat (mark=flex) [cat=pisat, agr=?AGR, asp = unbound,
      aspect = imperf];
    node ?Za [cat=pref];
    node ?ZaLex (mark=flex) [cat=za-];
    node ?VPInt [cat=vp, agr=?AGR, e=?X0, aspect = perf, asp = bound];
    ?VP -> ?VPInt;
    ?VPInt -> ?V;
    ?VP -> ?Za;
    ?Za -> ?ZaLex;
    ?Za >> ?VPInt;
    ?V -> ?Pisat
  }
  ;
  <frame>{
    ?X0[bounded-event & process,
      actor:?Actor,
      theme:?Theme,
      manner:[record],
      verb-dim:?X0,
      noun-dim:[property-scale,
        min: ?ScMin,
        max: ?ScMax
      ],
      m-dim:[property-scale,
        min: ?ScMin,
        max: ?ScMax
      ],
      init: [stage,
        scale-deg:?ScMin
      ],
      fin: [stage,
        scale-deg:?ScMax
      ]
    ]
  }
}
```

Figure 7.8: XMG code for representation of the verb *zapisat* 'to write down/record'

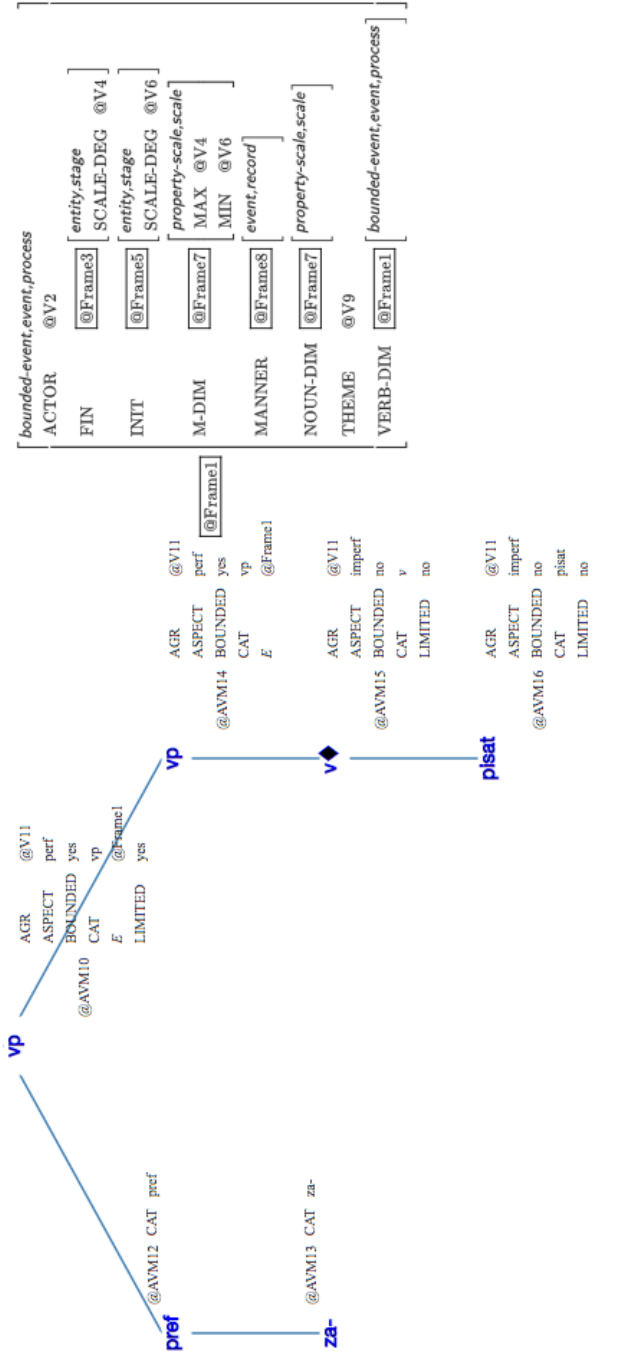

Figure 7.9: Result of the compilation of the class Zapisat

7.3 Prefixes

As we have already discussed the frames for all individual prefix usages in the previous chapter, I will not go through the code for all of them (it can be found in Appendix B), but show how frames correspond to the XMG descriptions and what happens on the syntactic side, taking one prefix as an example.

Figure 7.10 shows the XMG description of the class for the prefix *po-*. In this code, the syntactic part represents a VP that consists of a prefix head and another (internal) VP that carries information about the derivational base. The agreement information as well as the semantic frame are then passed to the higher VP node. This node is also characterised by having perfective aspect (one may not call this aspect and consider aspect appearing at a later stage, but then this feature stores the value that will appear as soon as the aspect feature is initialised) independently of the value of the aspect feature of the internal VP node. Following the definitions provided above, the feature *limited* is assigned the value *yes* because the semantic frame contains the attribute *fin*, but the feature *bounded* is assigned the value *no*, as the value of the attribute *finis* is a free variable.

As for the frame description part, it follows straightforwardly earlier proposed frame configuration. To illustrate this, let us compare the code with Figure 7.11 that shows the frame that was proposed in Chapter 6 for the delimitative usage of the prefix *po-*. If one has a look on those two pictures, it becomes obvious that they differ only with respect to the variable names.

To make sure that the code not only looks similar to the frame, but also produces the desired result, let me show Figure 7.12 that contains the result of the compilation of the proposed metagrammar class.

Encoding of other prefix usages proceeds in the similar way: the syntactic part does not vary much from prefix to prefix and semantic descriptions can be directly obtained from the frame descriptions I have proposed in Chapter 6. However, there are a couple of difficulties I want to discuss. First let us consider the prefix *pere-* in the repetitive usage. There are several things that are different compared to the case of the “delimitative” usage of the prefix *po-*. First, the value of the features *aspect* and *bounded* is inherited from the lower VP and the value of the *limited* feature of the derivational base has to be *yes*. Second, at the moment of prefix attachment the central node of the frame shifts: derived VP (node ?VP on Figure 7.13) is related to the frame ?X1 whereas the semantics of the derivational base is represented by the frame ?X0 (subframe of ?X1 on Figure 7.13). This realises the solution proposed in the previous chapter.

In order to perform the coercion that is needed when the prefix *pere-* is attached to a simplex imperfective verb, a separate step is required. It is realised by the class `NDimCoercedVerb` (see Figure 7.14) that transforms a non-bounded event into a bounded event using the nominal scale.

```

class PoVerb
export ?VP ?VPInt
declare ?VP ?VPInt ?Po ?PoLex ?AGR ?X0 ?Init ?Fin ?VDim
{
  <syn>{
    node ?VP [cat=vp, agr=?AGR, e=?X0, limited = yes, bounded = no,
              aspect = perf];
    node ?Po [cat=pref];
    node ?PoLex (mark=flex) [cat=po-];
    node ?VPInt [cat=vp, agr=?AGR, e=?X0, bounded = no];
    ?VP -> ?VPInt;
    ?VP -> ?Po;
    ?Po -> ?PoLex;
    ?Po >> ?VPInt
  } ;
  <frame>{
    ?X0[bounded-event,
        m-dim: ?VDim,
        verb-dim: ?VDim,
        init: [stage,
              scale-deg:?Init],
        fin: [stage,
              scale-deg:?Fin]
    ]
  }
}

```

Figure 7.10: XMG code for the class describing the ‘delimitative’ usage of the prefix *po-*

$$\mathbf{e} \begin{bmatrix} \textit{bounded-event} \\ \text{VERB-DIM} \boxed{1} \\ \text{M-DIM} \quad \boxed{1} \textit{ [scale]} \\ \text{INIT} \quad \begin{bmatrix} \textit{stage} \\ \text{DEG} \boxed{2} \end{bmatrix} \\ \text{FIN} \quad \begin{bmatrix} \textit{stage} \\ \text{DEG} \boxed{3} \end{bmatrix} \end{bmatrix}$$

Figure 7.11: Semantic contribution of *po-*

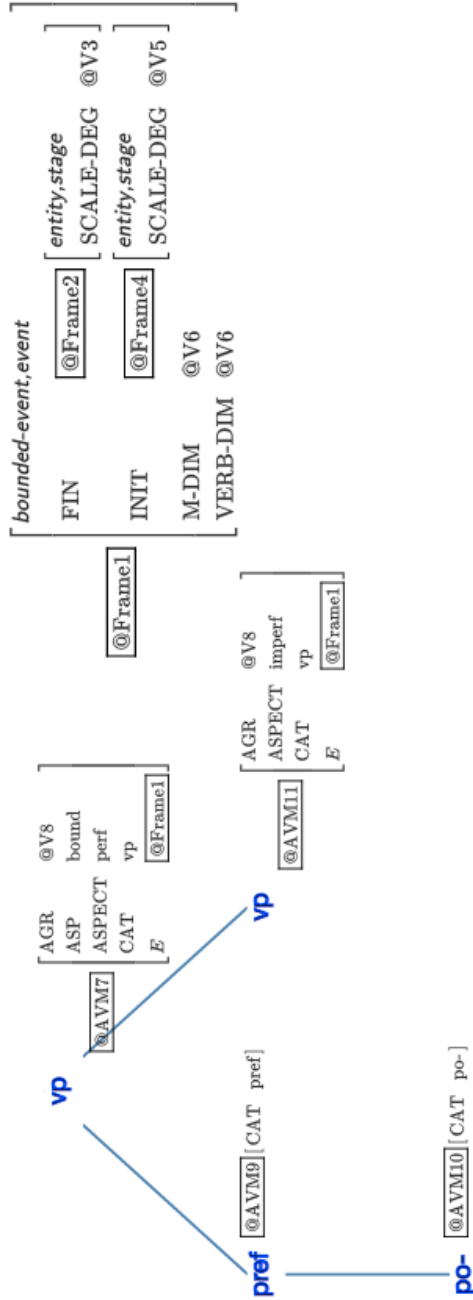

Figure 7.12: Result of the compilation of the class PoVerb

7.4 Imperfective suffix

I use two separate classes to produce two interpretations of secondary imperfective verbs: progressive and habitual. For the analysis I propose it is important to distinguish between them when another prefix is attached after the suffixation, as these two interpretations have different semantic properties.

The habitual interpretation of the imperfective suffix, realised by the code shown on Figure 7.15, produces an unlimited event that is a series of limited events. The NOUN-DIM of the new event necessarily is of type *cardinality* and does not need to correspond to the respective attribute of the derivational base. The verbal dimension is copied from the individual event level to the series level. This interpretation of the imperfective suffix is also associated with the introduction of the *iteration* type of the event and the respective syntactic feature. The result of the compilation of this class is shown on Figure 7.16.

The second interpretation of the imperfective suffix is progressive: on the semantic side I represent it as a creation of a new event that is a PART-OF the event denoted by the derivational base. Due to the PART-OF relation the new event remains limited. On Figures 1.1 and 1.2 in Chapter 1 I have realised *part of* as a relation, as in this case (in contrast to the prefix *do-*) it is not functional. As relations are currently not implemented in XMG, for the sake of the implementation I use PART-OF as an attribute when representing the progressive interpretation of the imperfective suffix.

7.5 Assembling the parts

The last part of the code assembles the verbal phrases from the components described above. As the resource has to be finite, recursion is not allowed in the XMG class descriptions. Due to this restriction, it is not possible to define a single class that would allow an arbitrary number of prefixes to be stacked (by the possibility of attaching a new prefix to the output of the same class). This means that each prefixation level has to be described separately. First three classes do the job of assembling verbs with one prefix: the first class (*OneBasePrefixedVerb*) combines a simplex verb and one of the prefixes; the second class (*OneCoercedPrefixedVerb*) combines a coerced verb with one of the prefixes *pere-* (repetitive interpretation) and *do-*; the last class (*VerbWithOnePrefix*) assembles under one name the results of the first two classes and all prefixed verbs that are stored in the dictionary.

On the next step (class *TwoPrefixedVerb*, shown on Figure 7.17) the resulting models of the first part are combined again with all available prefix descriptions.

7 Implementation of the analysis using XMG

```
class PereIterVerb
export ?VP ?VPInt
declare ?VP ?VPInt ?Pere ?PereLex ?AGR ?X0 ?X1 ?Deg1 ?Deg2 ?Scale ?
    NounDim
?Aspect ?EventType ?Init ?Fin ?Asp
{
  <syn>{
    node ?VP [cat=vp, agr=?AGR, e=?X1, bounded = ?Asp, limited = yes
      ,
          aspect = ?Aspect];
    node ?Pere [cat=pref];
    node ?PereLex (mark=flex) [cat=pere-];
    node ?VPInt [cat=vp, agr=?AGR, e=?X0, bounded = ?Asp, limited =
      yes,
          aspect = ?Aspect];

    ?VP -> ?VPInt;
    ?VP -> ?Pere;
    ?Pere -> ?PereLex;
    ?Pere >> ?VPInt
  };
  <frame>{
    ?X1[?EventType,
      m-dim:?Scale[property-scale],
      noun-dim:?NounDim,
      init: ?Init,
      fin: ?Fin,
      prep:?X0[?EventType,
        m-dim:?Scale,
        noun-dim:?NounDim,
        init: ?Init,
        fin: ?Fin]
    ]
  }
}
```

Figure 7.13: XMG code for the class that describes the repetitive usage of the prefix *pere-*

```

class NDimCoercedVerb
export ?VP ?VPInt
declare ?VP ?AGR ?X0 ?ScMin ?ScMax ?NounDim ?VPInt
{
  <syn>{
    node ?VP [cat=vp, agr=?AGR, e=?X0, bounded = yes, limited = yes,
              aspect = perf];
    node ?VPInt [cat=vp, agr=?AGR, e=?X0, limited = no, aspect =
                 imperf];
    ?VP -> ?VPInt
  };
  <frame>{
    ?X0[bounded-event,
        m-dim: ?NounDim[property-scale & closed-scale,
                          min: ?ScMin,
                          max: ?ScMax],
        noun-dim:?NounDim,
        init:[stage,
              scale-deg:?ScMin],
        fin:[stage,
             scale-deg:?ScMax]
    ]
  }
}

```

Figure 7.14: XMG code for the class that implements coercion of an unbounded event into a bounded event

This piece of code illustrates how class descriptions are reused: the variable `?VP`-pref gets identified with one of the prefix classes (`DoVerb`, `PereVerb`, `PereIterVerb`, or `PoVerb`). This is possible only in case all the disjoint classes export the same set of variables. Due to such requirement it is possible to access the exported variables: for example, a `?VP` variable gets identified with the `?VP` variable of the `?VPpref` class (`?VPpref. ?VP`). Similarly the variable `?VSp` gets identified with a `VerbWithOnePrefix` class (which, in turn, contains all possible models of verbs with one prefix) and the `?VPInt` variable is then linked to both the `?VPInt` node of the `?VPpref` class and the `?VP` node of the `?VSp` class.

Both types of verbs (with one prefix, `VerbWithOnePrefix` class, and with two prefixes, `TwoPrefixedVerb` class) then serve as an input to the class `SuffVerb`.

7 Implementation of the analysis using XMG

```
class IterVerb
export ?VP ?VPInt
declare ?VP ?VPInt ?Suf ?Iva ?AGR ?X0 ?X1 ?VDim
{
  <syn>{
    node ?VP [cat=vp, agr=?AGR, e=?X1, bounded = no, limited = no,
              aspect = imperf, iteration = yes];
    node ?Suf [cat=suf];
    node ?Iva (mark=flex) [cat=iva-];
    node ?VPInt [cat=vp, agr=?AGR, e=?X0, limited = yes];
    ?VP -> ?VPInt;
    ?VP -> ?Suf;
    ?Suf -> ?Iva;
    ?VPInt >> ?Suf
  };
  <frame>{
    ?X1[event & iteration,
        segment:?X0[bounded-event,
                    noun-dim:[property-scale],
                    verb-dim: ?VDim],
        verb-dim: ?VDim,
        noun-dim:[cardinality]
    ]
  }
}
```

Figure 7.15: XMG code for the habitual interpretation of the imperfective suffix

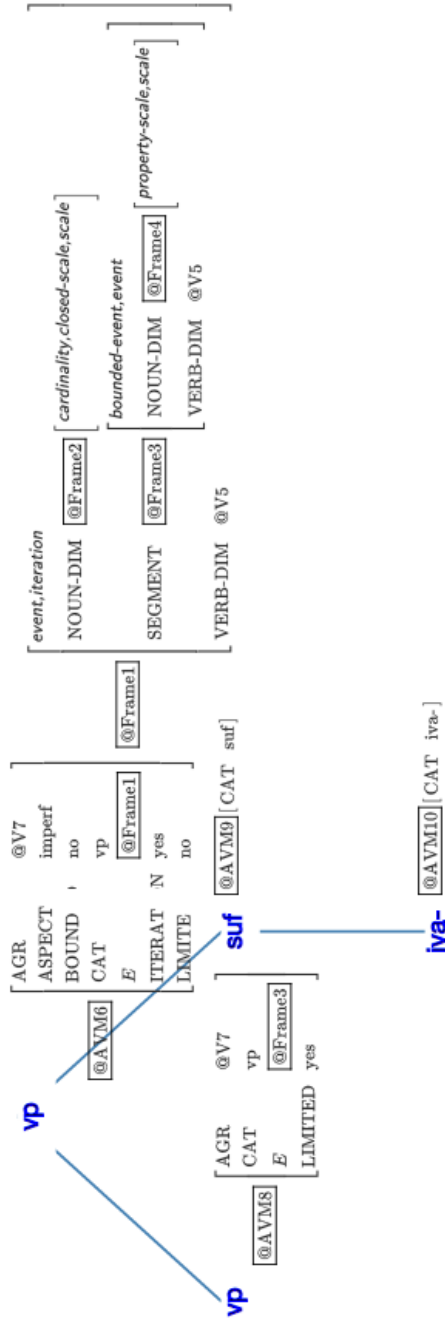

Figure 7.16: Result of the compilation of the class `IterVerb`

```

class TwoPrefixedVerb
export ?VP ?VPInt ?VPBase
declare ?VP ?VPpref ?V ?VSp ?VPInt ?VP ?VPBase
{
  {?VPpref = DoVerb[] | ?VPpref = PereVerb[] | ?VPpref =
    PereIterVerb[]
   | ?VPpref = PoVerb[]};
  ?VP = ?VPpref.?VP;
  ?VSp = VerbWithOnePrefix[];
  ?VPInt = ?VSp.?VP;
  ?VPInt = ?VPpref.?VPInt;
  ?VPBase = ?VSp.?VPBase
}

```

Figure 7.17: XMG code for the verbs with two prefixes

This class uses the results of nominal dimension constructors, as the dimension of the noun can be changed after the attachment of the suffix and it still has to agree with the requirements of the previously attached prefixes. The exported variable `VPBase` is used to keep track of the attachment point of the semantic representation of the noun. On the syntactic level the noun stays to the right of the verb and will be always attached higher than all the verbal morphemes.

After the suffixed verbs are assembled, the type matching has to be performed. In the current version of XMG type copying is performed not via creating a connection between two types (as it is done with attributes), but by copying the value that is there at the moment the operation is performed. As the noun is attached later, the type of the scale it is associated with is not passed to the higher level if the central node of the frame shifts. To ensure correct typing, I have introduced a class `TypeMatcher` (code shown on Figure 7.18) that identifies all types of the measure dimensions between the higher and the embedded frames (`m-dim`, `NOUN-DIM`, `verb-dim`). The class `SuffTyped` uses the `TypeMatcher` class together with the `SuffVerb` class. In sum, as the VP that contains the scalar interpretation of the noun is identified with the lowest VP available, the type matching mechanism allows to pass the types to a higher level. If the central node of the frame was not changed in the course of prefix attachments, variables `?X1` and `?X0` refer to the same frame node.

I allow for one more derivational step in the described fragment: attachment of a prefix after suffixation. This is performed by the class `TwoPrefixedSuffixedVerb` that uses the result of the compilation of the `SuffTyped` class and all avail-

```

class TypeMatcher
export ?VP0ut ?VPInt
declare ?VPInt ?X0 ?X1 ?NDimType ?VDimType ?MDim ?VP0ut
{
<syn>{
  node ?VP0ut [e=?X1];
  node ?VPInt [e=?X0]
  };
<frame>{
  ?X1[event,
    m-dim: [?MDim],
    noun-dim: [?NDimType],
    verb-dim: [?VDimType]
  ];
  ?X0[event,
    m-dim: [?MDim],
    noun-dim: [?NDimType],
    verb-dim: [?VDimType]
  ]
}
}

```

Figure 7.18: XMG code for the operation of type matching

able prefix classes. At this moment all possible verbal models are created. Then the next step of combining those models with various interpretations of the direct object is performed.

This step is done by two classes: `PrefixVerbDirObj` and `PrefixSuffixedVerbDirObj` that take, respectively, prefixed and prefixed-suffixed verbs, and all available dimension constructors. An output of those classes are models of all possible VPs that use all the available scalar interpretations of the direct objects. This output is again combine with the `TypeMatcher` class to ensure proper type inheritance.

Before discussing the produced output I would like to note that the architecture of the program is such that as soon as there is a TAG parser that is compatible with frame semantic representation, lexical anchors can be removed and the rest of the code would produce unanchored trees with prefixed verbs and appropriate dimension constraints on the argument slot.

7.6 Output

The compilation of the code produces 88 verbal phrases. The full xml of the output is provided in Section B.2 of Appendix B. Here I will show and provide a brief analysis of all the obtained models.

The first group of models consists of verbs with one or two prefixes. A total of 16 models is produced (see Table 7.1). Six of these models are models of verbs with one prefix. They all exist, but this is partially due to the selection of the prefixes and the base verb. The upper part of Table 7.1 shows these verbs with their English translations and the dimension interpretation of the argument. The last two columns indicate whether the verb exists and if not, whether it will be filtered out by pragmatic module as described in Chapter 5.

Table 7.1: Output of the XMG processing for the class of one- or two- prefixed verbs

verb	semantics	noun interpretation	exists	blocked by pragmatics
popisat'	to write for some time	length	yes	–
dopisat'	to finish writing	length	yes	–
perepisat'	to rewrite	length	yes	–
zapisat'	to write down	length	yes	–
perepisat'	to write all of	cardinal	yes	–
popisat'	to write all of	cardinal	yes	–
dodopisat'	to finish finishing writing	length	yes	–
doperepisat'	to finish rewriting	length	yes	–
dozapisat'	to finish writing down	length	yes	–
peredopisat'	to refinish writing	length	yes	–
pereperepisat'	to rewrite again	length	yes	–
perezapisat'	to write down again	length	yes	–
popopisat'	to write for some time	length	no	yes
perepopisat'	to write all of	cardinal	no	yes
popopisat'	to write all of	cardinal	no	yes
doperepisat'	to finish writing all of	cardinal	yes	–

In the second part of Table 7.1 verbs that contain two prefixes are present. Out of those verbs three must be filtered out for pragmatic reasons since their semantics is equivalent to the semantics of simpler verbs: two variant of the verb *popopisat'* are associated with exactly the same frames as two variants of the verb *popisat'* 'to write for some time/to write all of' that can be found in the upper

part of the Table 7.1. The third verb that also needs to be discarded is the verb *perepopisat*’ that has exactly the same representation as the verb *perepisat*’ “to write all of”.

Note that already at this stage XMG reduces 40 possible models (five variants of the first prefix, four variants of the second prefix, and two interpretations of the noun) to only 10 (seven correct and three non-existent) by an appropriate combination of constraints.

Now let us have a look at the next step: when the verbs from the list above get suffixed with the imperfective suffix (in one of two interpretations). The output of this part consists of 23 verbs out of which only two must be filtered out as they are produced on the basis of the verbs that, as we have discussed above, do not exist: *perepopisat*’ ‘to write all of’ and *popopisat*’ ‘to write for some time’. It is interesting to note that the second interpretation of the last verb does not get suffixed, so the number of wrong models on the new level does not get multiplied (by the two possible interpretations of the suffix). Instead of the six potential incorrect models just on the basis of the wrong predictions of the previous level we obtain only two. All the verbs produced by this part of the implementation are shown in Table 7.3 (page 313) together with their English translations, interpretation of the imperfective suffix, and information about existence.

The last group of verbs consists of 49 models that contain at least one prefix attached before the imperfective suffix and at least one prefix attached after it. They are shown in Table 7.2 together with English translations (not always exact) and the aspect (as here some of the verbs, despite being prefixed on the last derivation step, are imperfective). This part is harder to evaluate as many of the verbs cannot be found on the internet. A possible evaluation method would be to test the unanchored models with various lexical anchors against corpus data, but this requires both the parser that supports frame semantics (to work efficiently with different verbs) and a large corpus that contains complex verbs. I leave these tasks for future research.

Table 7.2: Output of the XMG processing for the class of verbs that are prefixed, then possibly suffixed, and then prefixed again

verb	semantics	aspect
*perepopisyvat’	–	perfective
peredopisyvat’	to write the final parts of all of	perfective
pereperepisyvat’	co copy/rewrite all of	perfective
perezapisyvat’	to write down all of	perfective
peredodopisyvat’	to write the very final parts of all of	perfective

7 Implementation of the analysis using XMG

verb	semantics	aspect
peredoperepisyvat'	to finish rewriting all of	perfective
peredozapisyvat'	to finish writing down all of	perfective
pereperedopisyvat'	to rewrite the final parts all of	perfective
perepereperepisyvat'	co copy/rewrite again all of	perfective
pereperezapisyvat'	to write down again all of	perfective
*perepopopisyvat'	derivational base does not exist	perfective
*popopisyvat'	to write for some time habitually all of	perfective
podopisyvat'	to finish writing all of	perfective
poperepisyvat'	to rewrite all of	perfective
pozapisyvat'	to write down all of	perfective
pododopisyvat'	to write the very final parts of all of	perfective
podoperepisyvat'	to finish rewriting all of	perfective
podozapisyvat'	to finish writing down all of	perfective
poperedopisyvat'	to rewrite the final part all of	perfective
popereperepisyvat'	co copy/rewrite again all of	perfective
poperezapisyvat'	to write down again all of	perfective
*popopopisyvat'	derivational base does not exist	perfective
dodopisyvat'	to finish writing the final part	perfective
doperepisyvat'	to finish rewriting	perfective
dozapisyvat'	to finish writing down	perfective
dododopisyvat'	to finish writing the very final part	perfective
dodoperepisyvat'	to finish the final part of rewriting	perfective
dodozapisyvat'	to finish writing down the final part	perfective
doperedopisyvat'	to finish rewriting the final part	perfective
dopereperepisyvat'	to finish rewriting again	perfective
doperezapisyvat'	to finish writing down again	perfective
peredopisyvat'	to be rewriting the final part	imperf
pereperepisyvat'	to be rewriting again	imperf
perezapisyvat'	to be writing down again	imperf
peredodopisyvat'	to be finishing rewriting the final part	imperf
peredoperepisyvat'	to be finishing rewriting again	imperf
peredozapisyvat'	to be writing down the final part again	imperf
pereperedopisyvat'	to be rewriting the final part again	imperf
perepereperepisyvat'	to be rewriting for the forth time	imperf
pereperezapisyvat'	to be writing down for the third time	imperf
podopisyvat'	to spend some time finishing writing	perfective
poperepisyvat'	to spend some time rewriting	perfective
pozapisyvat'	to spend some time writing down	perfective
pododopisyvat'	to spend some time finishing the final part	perfective

verb	semantics	aspect
podoperepisyvat'	to spend some time finishing rewriting	perfective
podozapisyvat'	to spend some time finishing writing down	perfective
poperedopisyvat'	to spend some time rewriting the final part	perfective
popereperepisyvat'	to spend some time rewriting again	perfective
poperezapisyvat'	to spend some time writing down again	perfective

Table 7.3: Output of the XMG processing for the class of prefixed and then suffixed verbs

verb	semantics	imperfective interpretation	exists
perepisyvat'	to be writing all of	progressive	yes
popisyvat'	to be writing for some time habitually	habitual	yes
dopisyvat'	to be finishing writing	progressive	yes
dopisyvat'	to finish writing habitually	habitual	yes
perepisyvat'	to be rewriting	progressive	yes
perepisyvat'	to rewrite habitually	habitual	yes
zapisyvat'	to be writing down	progressive	yes
zapisyvat'	to write down habitually	habitual	yes
doperepisyvat'	to be finishing writing all of	progressive	yes
dodopisyvat'	to be finishing writing the final part	progressive	yes
dodopisyvat'	to finish writing the final part habitually	habitual	yes
doperepisyvat'	to be finishing rewriting	progressive	yes
doperepisyvat'	to finish rewriting habitually	habitual	yes
dozapisyvat'	to be finishing writing down	progressive	yes
dozapisyvat'	to finish writing down habitually	habitual	yes
perepopisyvat'	to be writing all of	progressive	no
peredopisyvat'	to be rewriting the final part	progressive	yes
peredopisyvat'	to rewrite the final part habitually	habitual	yes
pereperepisyvat'	to be rewriting again	progressive	yes
pereperepisyvat'	to rewrite again habitually	habitual	yes
perezapisyvat'	to be writing down again	progressive	yes
perezapisyvat'	to write down again habitually	habitual	yes
popopisyvat'	to be writing for some time habitually	habitual	no

According to the available data and introspection, out of 49 models four must be discarded. Two of them (*popopopisyvat'* and *perepopopisyvat'*) are formed from the derivational bases that need to be discarded (discussed above). Other two must be discarded by the pragmatic module.

The first of the two verbs, **perepopisyvat*’, that could have been translated as ‘to write all of for some time’ would be blocked because the interpretation of the prefix *pere-* related with the cardinality scale is ‘performing the action completely with each item in the set’. Now, if the interpretation of the prefix *po-* does not get strengthened (some time → all context-specified time), we obtain a contradiction. If it does get strengthened (every writing event is maximal with respect to the corresponding member of the set), then the same semantics can be expressed by the simpler verb *perepisat*’ ‘to write all of’.

The second verb, **popopisyvat*’, has a similar semantic structure and also could be translated as ‘to write all of for some time’ (see the discussion about the differences between the distributive interpretations of the prefixes *po-* and *pere-* in Chapter 4). This verb refers to the same set of events as the verb *popisat*’ with distributive interpretation (‘to write all of’), although the surface semantic representations of the two verbs are different, so a deeper analysis is needed in this case.

By now we have seen all the models that my implementation produces. Out of 88 models nine should be discarded, but what is harder to evaluate is the recall of the model (fraction of the number of correct models in the output to the number of correct models), as there is no standard that would provide the later number (the total of correct models for the described grammar fragment). I will approach this problem in the next section.

7.7 Result evaluation and comparison

In order to compare the predictions of my model to that of earlier theories, I have implemented the system proposed in Tatevosov (2009) for exactly the same fragment (one verbal stem, one “lexical” prefix, five prefix-interpretation pairs, the imperfective suffix). For this part I have omitted the lexical entries for direct objects as they do not influence the interpretation of the prefixed verbs. As the approach is syntactic, all restrictions are formulated in syntactic terms and the frame dimension is used to represent the order of attachment of affixes with different semantics. In this implementation, for example, the class for the distributive interpretation of the prefix *pere-* looks as shown on Figure 7.19. The restriction on this prefix attachment is the imperfective aspect of the base verb, which is reflected via a syntactic constraint on the feature *aspect* here.

However, a direct comparison of the predictions of the two models is not possible, as Tatevosov (2009) does not offer any theory about the nature of various interpretations of the imperfective suffix. Two solutions are available in this situation: either introduce both interpretations of the imperfective suffix in the implementation of the theory proposed by Tatevosov (2009) or count those models

```

class PereVerb
export ?VP ?VPInt
declare ?VP ?VPInt ?Pere ?PereLex ?AGR ?X0 ?X1
{
  <syn>{
    node ?VP [cat=vp, agr=?AGR, e=?X1, aspect = perf];
    node ?Pere [cat=pref];
    node ?PereLex (mark=flex) [cat=pere-];
    node ?VPInt [cat=vp, agr=?AGR, e=?X0, aspect = imperf];
    ?VP -> ?VPInt;
    ?VP -> ?Pere;
    ?Pere -> ?PereLex;
    ?Pere >> ?VPInt
  };
  <frame>{
    ?X1[distributive,
      of: ?X0]
  }
}

```

Figure 7.19: XMG implementation for the distributive interpretation of the prefix *pere-* according to the theory of Tatevosov (2009)

produced with the implementation of my theory that differ only with respect to the interpretation only once. The second option requires more manual checking, but is more fair with respect to the analysis of Tatevosov (2009), so I decided to adopt it.

My implementation of the analysis proposed in Tatevosov (2009) produces 81 models for the same fragment. I have done a full analysis of the resulting models and I would like to show the results from verbs with two prefixes and the verbs that are prefixed after the imperfective suffix is attached. At the end I will provide the summary with precision, recall, and F-score data for the two models.

Table 7.4 shows the full list of verbs produced by two implementations. As we have already discussed above, seven verbs in this list exist and the “semantic” implementation produces three models that have to be discarded. The model of the analysis by Tatevosov (2009) produces five verbs that do not exist (under the interpretation associated with them) and three verbs that should be discussed in more detail (marked with question marks in the table).

Table 7.4: Verbs with two prefixes produced by two implementations

verb	semantics	exists	this account	Tatevosov (2009)
dodopisat'	to finish finishing writing	yes	+	+
doperepisat'	to finish rewriting	yes	+	+
doperepisat'	to finish writing all of	yes	+	+
dopopisat'	to finish writing for some time	no	-	+
dozapisat'	to finish writing down	yes	+	+
peredopisat'	to refinish writing	yes	+	+
pereperepisat'	to rewrite all of	no	-	+
pereperepisat'	to rewrite again	yes	+	+
perepopisat'	to write for some time again	no	-	+
perezapisat'	to write down again	yes	+	+
podopisat'	to finish writing all of	??	-	+
poperepisat'	to rewrite all of	??	-	+
poperepisat'	to write all of	no	-	+
popopisat'	to write all of for some time	no	-	+
pozapisat'	to rewrite all of	??	-	+
popopisat'	to write for some time	no	+	-
perepopisat'	to write all of	no	+	-
popopisat'	to write all of	no	+	-

These three verbs are verbs that contain the distributive prefix *po-* stacked over some other prefix (with non-distributive interpretation): *podopisat'* 'to finish writing all of', *poperepisat'* 'to rewrite all of', and *pozapisat'* 'to rewrite all of'. They are, according to the theory proposed in Tatevosov (2009), possible, but not extensively discussed in the paper (a manuscript by the same author, dedicated to this usage of the prefix and cited among the references, never appeared). I personally do not find them acceptable and Tatevosov (2009: 143) himself marks such verbs as "interpretable with difficulty". They could be accommodated in my account if the distributive interpretation of the prefix *po-* is represented separately and is two-layered, effectively combining in itself the semantics of the imperfective suffix (iterative/habitual interpretation) and the current representation of the prefix *po-*. The piece of code shown on Figure 7.20 implements this solution and allows to produce exactly those three verbs (if the class is combined with verbs that are already prefixed once). One would probably want to associate this representation with a higher cost in comparison with the initial representation I offer if a subsequent pragmatic module is used.

```

class PoDistrVerb
export ?VP ?VPInt
declare ?VP ?VPInt ?Po ?PoLex ?AGR ?X0 ?X1 ?Init ?Fin ?VDim
{
  <syn>{
    node ?VP [cat=vp, agr=?AGR, e=?X1, limited = yes, bounded = yes,
              aspect = perf, iteration = yes];
    node ?Po [cat=pref];
    node ?PoLex (mark=flex) [cat=po-];
    node ?VPInt [cat=vp, agr=?AGR, e=?X0, bounded = yes];
    ?VP -> ?VPInt;
    ?VP -> ?Po;
    ?Po -> ?PoLex;
    ?Po >> ?VPInt
  };
  <frame>{
    ?X1[bounded-event & iteration,
        m-dim:?VDim[cardinality],
        verb-dim: ?VDim,
        segment:?X0[event,
                    m-dim:[property-scale]
                  ]
    ]
  }
}

```

Figure 7.20: XMG code for implementing the ‘coerced’ distributive interpretation of the prefix *po-*

If the three verbs that we have just discussed are considered existent, then the prefixation system proposed by Tatevosov (2009) produces five models that must be discarded. In contrast with my proposal, there is no further explanation of why exactly those verbs (two of them are produced by the same rule that forms the three verbs we have just discussed) would be problematic.

Among the verbs with one or two prefixes and an imperfective suffix added at the last step of the derivation the number of errors stays close (two versus three), although again constructed but not existent verbs are distinct in two approaches. Both implementations have full recall with respect to this part and the part we have discussed before.

The comparison becomes more interesting when we consider the most complex verbs created by the two implementations. The number of models produced

here is close: 45 models according to the analysis by Tatevosov (2009) and 49 models in the implementation of my analysis. The overlap of these sets constitutes, however, only 27 models. The first thing to note is that the group of verbs that are marked as imperfective in Table 7.2 cannot be (and is not) produced in the system proposed by Tatevosov (2009). One may ask whether they should be produced at all: an attentive reader probably noticed that both Table 7.3 and Table 7.2 contain, for example, the imperfective verb *perezapisyvat* 'to be writing down again'. The structure of the two verbs, however, is different: in one case the imperfective suffix is attached as the last step of the derivation and in the other case it happens before the repetitive *pere-* is attached. On the semantic side this is reflected in what ends up to constitute the preparatory stage of the event: once it is the whole completed event of the same type, and in the second case it is another ongoing/partial event. Another difference is that only in the first structure the habitual interpretation of the suffix is possible.

The second group of complex verbs that is not produced by the implementation of the analysis offered in Tatevosov 2009 is formed by the verbs with the outermost prefix *do-*. They follow the pattern we have extensively discussed in Chapter 2.

Among the rest of the models produced by the second implementation are such verbs as *pereperepopisyvat* with a semantic structure of a distributive interpretation over imperfective of the repetition of a delimited event. Such semantic structures are hardly conceivable and the corresponding verbs do not exist.³

To quantify precision and recall, I decided to do the following:

- count 79 models instead of 88 for my analysis by removing such models that differ only with respect to the interpretation of the secondary imperfective;
- count the models for the existence of which I argue in Chapter 2 as correct (imperfective verbs formed when the last affix attached is the repetitive *pere-* and perfective *do-*prefixed verbs)
- calculate all measures two times: once counting three questionable verbs as incorrect (Table 7.5) and once counting them as correct (Table 7.6);
- on pair with the previous decision I will use two versions of the implementation of my analysis: the original one and one that uses the update shown in Figure 7.20.

³This judgement is mostly based on introspection and personal communication with other native speakers, as any such verb would be rare and the absence of data on the Internet is not a reliable indicator of the non-existence. I plan to conduct additional experiments in future to get statistically reliable evidence about the existence of such complex verbs.

Based on this, I obtain the following numbers: for the implemented fragment there are 70 or 73 correct models⁴. Out of these models, the implementation of the analysis provided in Tatevosov (2009) produces, respectively, 52 or 55, and the total number of models output is 81. The original implementation of my analysis produces 70 correct models and the total number of models (after the duplicates among imperfective verbs are removed) is 79. The updated version produces 70 and 73 of the correct models, respectively, and the total number of models in this case is 82. The precision (fraction of correct models out to all produced models), recall (fraction of correct models in the output to all correct models), and F-measures ($2 * (precision * recall) / (precision + recall)$) are provided in Table 7.5 for the first version of calculation (three questionable models excluded) and in Table 7.6 for the second version.

Table 7.5: Precision, recall and F-measure for different implementations (three questionable verbs excluded)

analysis	precision	recall	F-measure
current analysis original	0.886	1	0.94
Tatevosov (2009)	0.642	0.743	0.689
current analysis modified	0.854	1	0.921

Table 7.6: Precision, recall and F-measure for different implementations (three questionable verbs included)

analysis	precision	recall	F-measure
current analysis original	0.886	0.959	0.921
Tatevosov (2009)	0.679	0.753	0.714
current analysis modified	0.89	1	0.942

The numbers in the tables show that despite the close number of the models in the output there is a significant difference in precision and recall between the implementation of the analysis proposed here and that of the analysis from Tatevosov (2009). In addition I have shown that my analysis can easily be adapted in case of different acceptability judgements to obtain the full recall. I also offer

⁴I have manually checked the possibilities using the assumption that there can be no existing complex verb derived from a non-existing verb. The calculation of the recall is thus based on this assumption.

7 Implementation of the analysis using XMG

pragmatic reasoning to exclude the models that do not belong to the set of correct ones. Besides that the output of the analysis contains fully spelled-out semantic representations that are obtained compositionally and the semantics of the prefix in a given position is derived and not stipulated.

8 Conclusions, remarks and further questions

In this work I have explored the Russian verbal prefixation system and proposed a complex account that models it. In Chapter 2 I have presented new data that did not receive an appropriate analysis within the earlier accounts of Russian prefixation. I have also developed a method of collecting data that prevents any decisions that may be biased by the theory one proposes. This method was used throughout the entire work to ensure careful data representation.

After considering the data I have discussed the commonly assumed distinction between lexical and superlexical prefixes in Chapter 3. I have shown that despite the clear differences between the properties of particular prefixes the proposal of the strict distinction between the classes has to be rejected together with the possibility to restrict prefix stacking due to different positions of various prefixes. The division into prefix classes is then substituted with a scale. One end of this scale is occupied by those prefixes that do not have a predictable semantic contribution, can never stack on top of other prefixes, and change the argument structure of the verb. On the other end of the scale are located those prefixes that have a transparent semantics, can stack freely and do not change the argument structure of the verb. Other prefixes are located in between these extremes without clear class borders. On this basis I have decided to abandon the hypothesis of different structural positions of various prefixes and develop a semantic account that would have at least the same predictive power with respect to possible affix combinations and also explains the data presented in Chapter 2.

In Chapter 4, I went through the first step towards a semantic account of verbal prefixation in Russian: I provided an informal analysis of the semantic and combinatorial properties of five prefixes (*za-*, *na-*, *po-*, *pere-* and *do-*) as well as a brief discussion of the (simplified) treatment of the imperfective suffix that I assume. I then continued with the exploration of the pragmatic properties of individual prefixes and of the competition between various prefixed verbs derived from the same base in Chapter 5. I have shown that there is not enough evidence to assume the presuppositional account of the prefixes *do-* and *pere-* and concluded that the inferences associated with their usage should be treated as entailments and implicatures. In the second part of the chapter I have outlined a preliminary version of the pragmatic competition between prefixed verbs. I have

shown some examples of how the interpretation of a prefixed verb can be derived using underspecified semantics and basic pragmatic principles.

Following the theoretical part, in Chapter 6 I have provided a frame semantic analysis of the five prefixes which I have explored in this work. I have introduced the formalism, provided frame representations of various prefixes and shown how these frames combine with verbal frames, frames for the direct object, measure phrases, and special dimension constructors. To evaluate the predictions of the analysis I have implemented it for a small language fragment using the metagrammar description formalism (XMG). I have provided the details of the implementation and discussed the difficulties related to it in Chapter 7. I have also implemented the proposal of Tatevosov (2009) and compared the output of the two proposals with respect to the predictive power of available affix combinations for a given verb.

In sum, I have provided and partially implemented an account that predicts the possibility of prefix attachment (for five prefixes) and in case of a positive answer also the semantics, aspect, and semantic and syntactic restrictions on the arguments of the derived verb.

On the other hand, I have raised a number of questions that could not be answered in course of this work and are worth further investigation. These are, for example, questions about the unexpected behaviour of loaned biaspectual verbs when they are prefixed with *do-* or *pod-* and about the status of loaned prefixes, such as *dis-* or *re-*. I also have not examined the behaviour of the imperfective suffix in detail and instead used a simplification that has to be replaced with a more thorough description in the future.

Another research direction that I aim to address in my future work is the development of the pragmatic part. I hope to implement the proposal concerning the competition of various prefixed verbs using the Rational Speech Act framework. In parallel, I would like to run the experiments to obtain probabilistic predictions for various interpretations of the prefixed verbs. Of particular interest are cases where, according to my analysis, a particular interpretation is part of the semantics of the verb, but is blocked for pragmatic reasons. I then plan to compare the quantitative output of the implemented system with experimental results that would allow to test the whole theory in an objective way.

The implementation of the proposal I have done so far also needs to be extended. This would be possible as soon as the relevant tools are available (most important of which is a parser that would work with TAG and frame representations) and the contribution of other prefixes is represented in terms of frames. A large-scale implementation would allow to create the derivational graph, as proposed in Chapter 2, that would open the way for further research and testing in the domain of Russian complex verbs.

Appendix A: Frame representations

A.1 Constraints

- (1) $proper-scale \wedge measure-of-change \rightarrow \perp$
- (2) $amount \wedge temperature \rightarrow \perp$
- (3) $event \wedge cardinality \rightarrow iteration$
- (4) $bounded-event \wedge DURATION.T \rightarrow (m-dim.measure-of-change \wedge time) \wedge m-dim.MIN = 0 \wedge m-dim.MAX \triangleq DURATION.VALUE$
- (5)
 - a. $MIN.T \wedge init.T \rightarrow init.deg \triangleq MIN$
 - b. $MAX.T \wedge fin.T \rightarrow fin.deg \triangleq MAX$

A.2 Prefixes

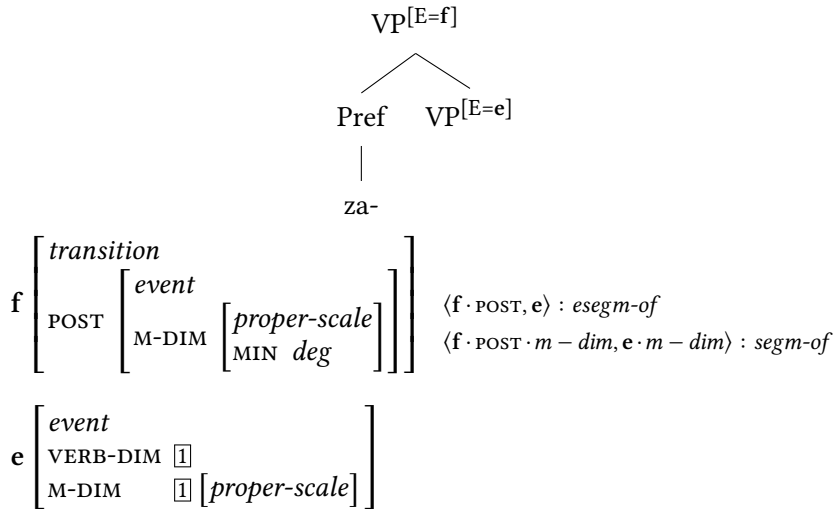

Figure A.1: Representation of the contribution of the prefix *za-*

A Frame representations

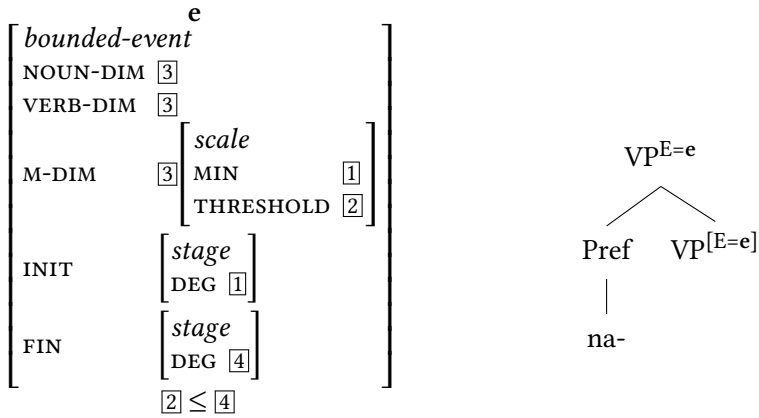

Figure A.2: Representation of the contribution of the prefix *na-*

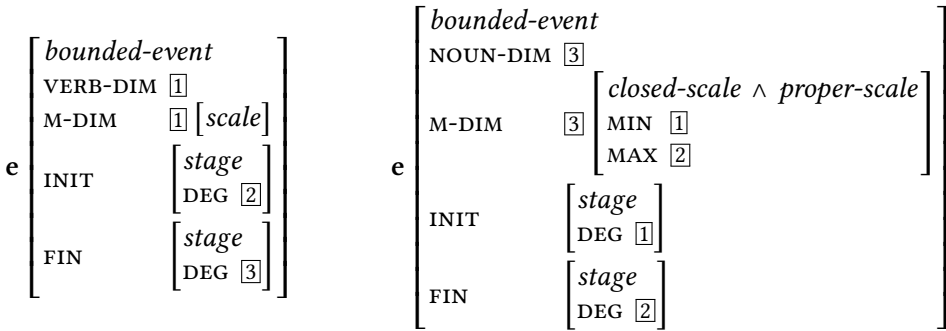

Figure A.3: Frame representations of the prefix *po-* (left) and of the prefix *pere-* for the closed scale case (right)

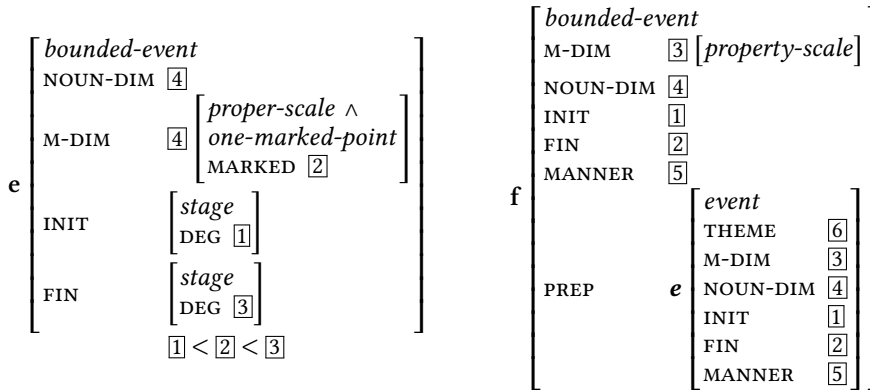

Figure A.4: Frame representation of the prefix *pere-*: case of a one marked point scale on the left and case of a property scale on the right

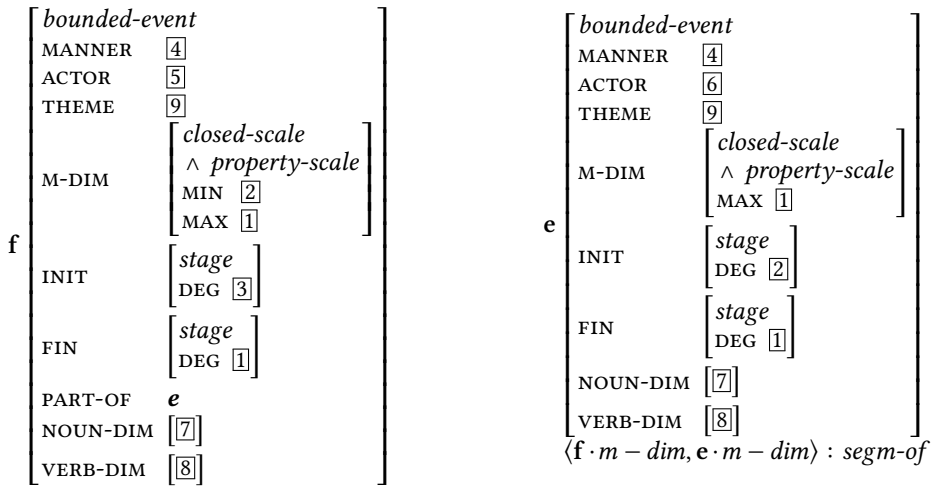

Figure A.5: Frame representation of the prefix *do-*

A.3 Verbs

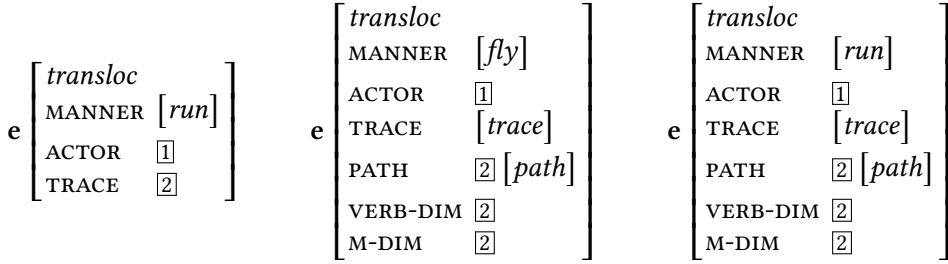

Figure A.6: Verbs *begat*^{ind_{det}} ‘to run’ (left), *letat*^{det} ‘to fly’ (center), and *bežat*^{det} ‘to run’ (right)

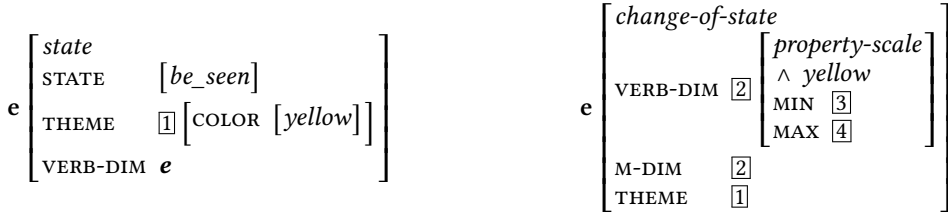

Figure A.7: Two interpretations of the verb *želtet* ‘to be yellow and be seen/to become yellow’

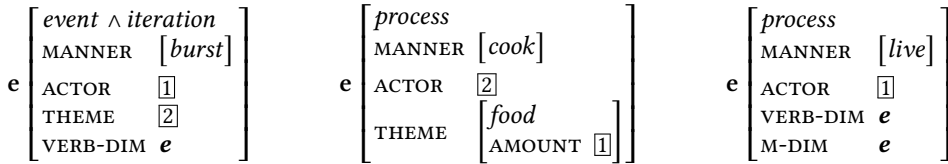

Figure A.8: Verbs *lopat* ‘to burst’ (left), *varit* ‘to cook’ (center), and *žit* ‘to live’ (right)

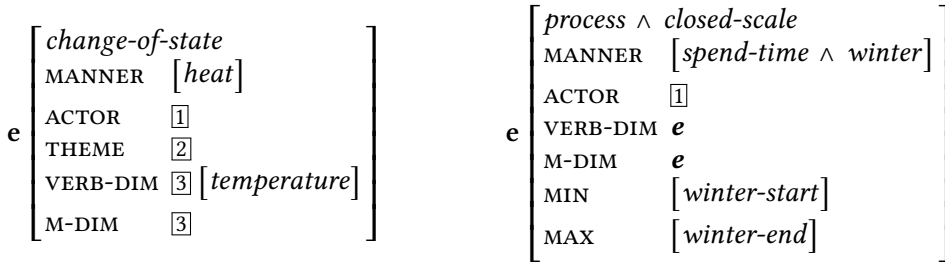

Figure A.9: Verbs *gret* ‘to heat’ (left) and *zimovat* ‘to spend winter time’ (right)

A.4 Nouns

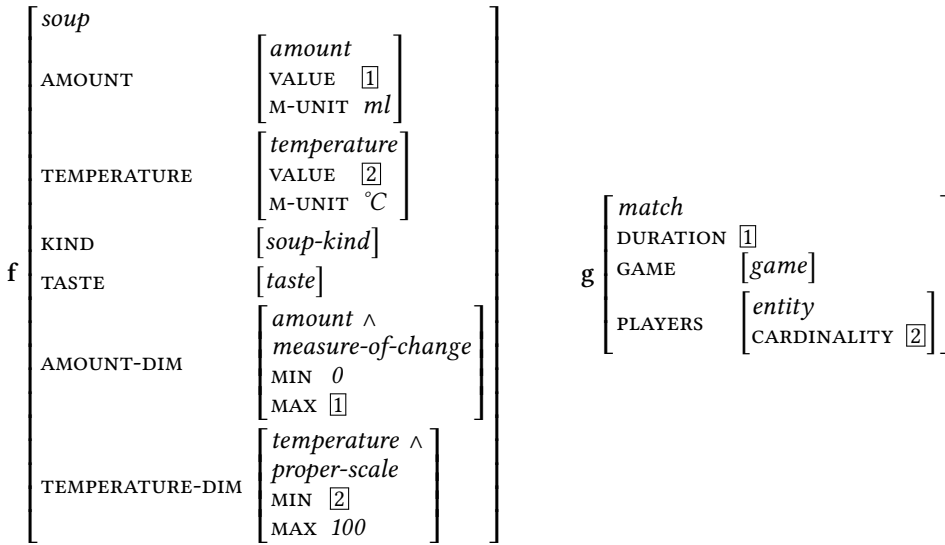

Figure A.10: Nouns *sup* ‘soup’ (left) and *partija* ‘match’ (right)

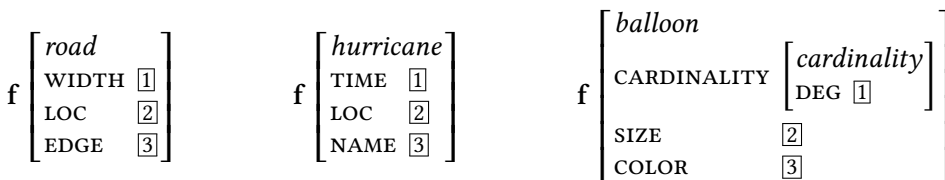

Figure A.11: Nouns *doroga* ‘road’ (left), *uragan* ‘hurricane’ (center), and *sar* ‘balloon’ (right)

A.5 Measure phrases

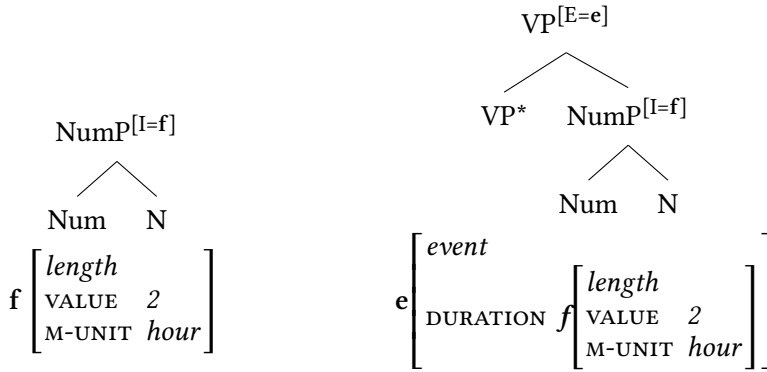

Figure A.12: Frame representation of the time adverbial 2 časa ‘for 2 hours’ before and after enriching its structure

A.6 Constructors

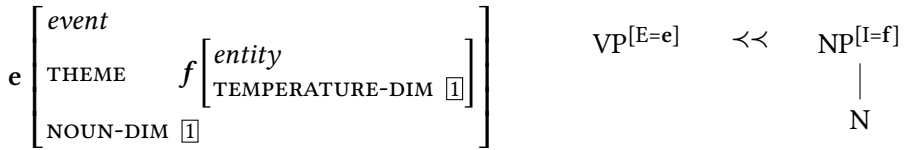

Figure A.13: Temperature dimension constructor

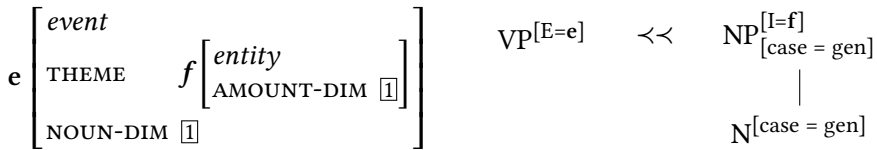

Figure A.14: Amount dimension constructor

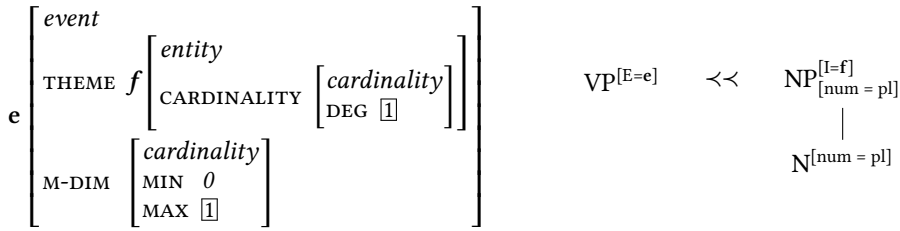

Figure A.15: Cardinality dimension constructor

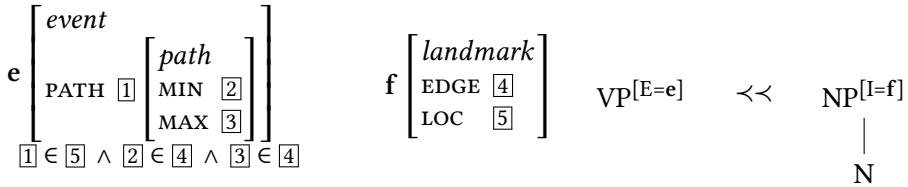

Figure A.16: Path dimension constructor

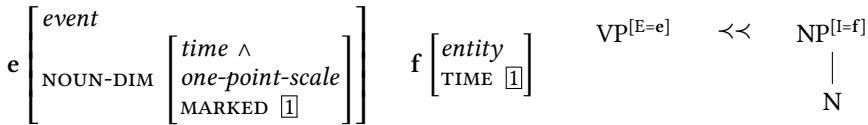

Figure A.17: Time scale constructor: case of one marked point

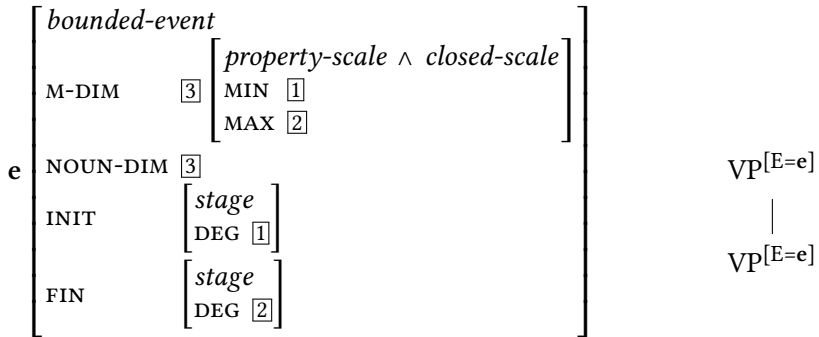

Figure A.18: Frame and tree for coercion of an unbounded event into a bounded event

Appendix B: XMG Implementation

B.1 Current analysis

```
1 use unicity with (mark=anchor) dims (syn)
2 use unicity with (mark=nounacc) dims (syn)
3 use unicity with (iteration=yes) dims (syn)
4
5 type CAT={np, vp, s, n, v, det, pref, prep, suf, pp, pisat,
   zapisat,
6           rasskazy, vse, po-,pere-, do-, za-, iva-,
   vpfull}
7 type MARK={lex,anchor,coanchor,flex,nounacc}
8 type CASE={acc,gen,nom,inst}
9 type NUMBER={sg, pl}
10 type AGR !
11 type LABEL!
12 type ASP={perf, imperf}
13 type YES={yes,no}
14
15 feature cat: CAT
16 feature e: LABEL
17 feature i: LABEL
18 feature agr: AGR
19 feature case: CASE
20 feature gcase: CASE
21 feature num: NUMBER
22 feature aspect:ASP
23 feature bounded:YES
24 feature limited: YES
25 feature iteration: YES
26 property mark: MARK
27
```

B XMG Implementation

```
28
29 frame-types = {event, scale, write, entity, object, story,
    bounded-event,
30             length, measure-of-change, proper-scale,
                iteration,
31             property-scale, stage, cardinality,
                closed-scale, zero,
32             process, record, progression, non-
                eventive}
33
34 frame-constraints = {
35     event entity -> -,
36     object -> entity,
37     stage -> entity,
38     story -> object,
39     event zero -> -,
40     zero entity -> -,
41     scale entity -> -,
42     scale zero -> -,
43
44     bounded-event -> event,
45     process -> event,
46     iteration -> event,
47     progression -> event,
48     record -> event,
49
50     closed-scale -> scale,
51     measure-of-change -> closed-scale,
52     cardinality -> closed-scale,
53     proper-scale -> scale,
54     proper-scale measure-of-change -> -,
55
56     event cardinality -> iteration,
57     length -> property-scale,
58     cardinality property-scale -> -,
59     property-scale -> scale,
60     event property-scale -> -,
61     property-scale proper-scale -> -,
62     non-eventive event -> -,
```



```

63     non-eventive -> scale,
64     progression iteration -> -
65 }
66
67 %%Lexical entries for the object
68 class Story
69 export ?Length ?Card ?N
70 declare ?N ?Story ?X0 ?Length ?Card
71 {
72   <syn>{
73     node ?N (mark=coanchor) [cat=n, num = pl, i=?X0];
74     node ?Story (mark=nounacc) [cat=rasskazy, num = pl, i=?X0];
75     ?N -> ?Story
76   };
77   <frame>{
78     ?X0[story,
79       length: ?Length,
80       cardinality: ?Card]
81   }
82 }
83
84 %%Dimension constructors
85 class NounLength
86 export ?N ?NP ?VP
87 declare ?NLength ?X0 ?Length ?N ?NP ?VP ?Dim ?Theme ?Case ?Num
88 {
89   ?NLength=Story[];
90   ?NLength.?Length = ?Length;
91   ?N=?NLength.?N;
92   <syn>{
93     node ?NP [cat=np, case=?Case, num = ?Num, i=?Theme];
94     node ?VP [cat=vp, e=?X0];
95     node ?N (mark=coanchor) [cat=n, case = ?Case, num = ?Num, i
          =?Theme];
96     ?VP >>+ ?NP;
97     ?NP -> ?N
98   };
99   <frame>{
100     ?X0[event,

```

B XMG Implementation

```
101         theme:?Theme,
102         noun-dim:[length,
103                 min:[zero],
104                 max:?Length]
105     ]
106 }
107 }
108
109 %% Plural nouns can be interpreted as introducing a cardinality
110     scale
111 class NounCardinal
112 export ?N ?NP ?VP
113 declare ?NCard ?X0 ?Card ?N ?NP ?VP ?Dim ?Theme ?Case ?Num
114 {
115     ?NCard=Story[];
116     ?NCard.?Card = ?Card;
117     ?N=?NCard.?N;
118     <syn>{
119         node ?NP [cat=np, case=?Case, num = pl, i=?Theme];
120         node ?VP [cat=vp, e=?X0, iteration = yes];
121         node ?N (mark=coanchor) [cat=n, case = ?Case, num = pl, i=?
122             Theme];
123     };
124     <frame>{
125         ?X0[iteration,
126             theme:?Theme,
127             m-dim:[cardinality,
128                 min:[zero],
129                 max:?Card]
130     ]
131 }
132 }
133
134 %% NP -> m-dim
135 class NDim
136 export ?NP ?N ?VP
137 declare ?VP ?NP ?N ?Noun
```

```

138 {
139   {?Noun=NounCardinal[] | ?Noun=NounLength[]};
140   ?N=?Noun.?N;
141   ?NP = ?Noun.?NP;
142   ?VP = ?Noun.?VP
143 }
144
145 %Lexical entries for verbs
146 class Zapisat
147 export ?VP ?VPInt ?VPBase
148 declare ?V ?Pisat ?Za ?ZaLex ?X0 ?Actor ?Theme ?ScMin ?ScMax
149 ?AGR ?VP ?VPInt ?VPBase ?MDim
150 {
151   ?VPBase = ?VPInt;
152   <syn>{
153     node ?VP [cat=vp, agr=?AGR, e=?X0, bounded = yes,
154               limited = yes, aspect = perf];
155     node ?V (mark=anchor) [cat=v, agr=?AGR, bounded = no,
156                           limited = no, aspect = imperf];
157     node ?Pisat (mark=flex) [cat=pisat, agr=?AGR, bounded = no,
158                              limited = no, aspect = imperf];
159     node ?Za [cat=pref];
160     node ?ZaLex (mark=flex) [cat=za-];
161     node ?VPInt [cat=vp, agr=?AGR, e=?X0, aspect = perf, bounded
162                 = yes];
163     ?VP -> ?VPInt;
164     ?VPInt -> ?V;
165     ?VP -> ?Za;
166     ?Za -> ?ZaLex;
167     ?Za >> ?VPInt;
168     ?V -> ?Pisat
169   };
170   <frame>{
171     ?X0[bounded-event & process,
172         actor:?Actor,
173         theme:?Theme,
174         manner:[record],
175         verb-dim:?X0,
176         noun-dim:?MDim [property-scale,

```

B XMG Implementation

```
176         min: ?ScMin,
177         max: ?ScMax],
178     m-dim:?MDim,
179     init: [stage,
180         scale-deg:?ScMin],
181     fin: [stage,
182         scale-deg:?ScMax]
183     ]
184 }
185 }
186
187 class Pisat
188 export ?V
189 declare ?V ?Pisat ?X0 ?Actor ?Theme
190 {
191     <syn>{
192         node ?V (mark=anchor) [cat=v, e=?X0, bounded = no,
193             limited = no, aspect = imperf];
194         node ?Pisat (mark=flex) [cat=pisat, e=?X0, bounded = no,
195             limited = no, aspect = imperf];
196         ?V -> ?Pisat
197     };
198     <frame>{
199         ?X0[event & process,
200             actor:?Actor,
201             theme:?Theme,
202             manner:[write],
203             verb-dim:?X0[scale]
204         ]
205     }
206 }
207
208 %Creating the minimal VP and filling the verbal slot
209 class VSpine
210 export ?VP ?VPInt
211 declare ?VP ?V ?AGR ?X0 ?K ?VPInt ?Asp ?VLex ?A ?Lim
212 {
213     ?VPInt = ?VP;
214     ?VLex = Pisat[];
```

```

215   ?V = ?VLex.?V;
216   <syn>{
217     node ?VP [cat=vp, agr=?AGR, e=?X0, bounded = ?Asp, aspect =
218       ?A,
219       limited = ?Lim];
220     node ?V (mark=anchor) [cat=v, agr=?AGR, e=?X0, bounded = ?
221       Asp,
222       aspect = ?A, limited = ?Lim];
223     ?VP -> ?V
224   }
225 }
226 %%%%%%%%%%%%%%%%%%%%%%%%%%%%%%%%%%%%%%%%%%%%%%%%%%%%%%%%%%%
227 %Constructions associated with prefixes
228 %%%%%%%%%%%%%%%%%%%%%%%%%%%%%%%%%%%%%%%%%%%%%%%%%%%%%%%%%%%
229 %"Delimitative" and distributive po-
230 class PoVerb
231 export ?VP ?VPInt
232 declare ?VP ?VPInt ?Po ?PoLex ?AGR ?X0 ?Init ?Fin ?VDim
233 {
234   <syn>{
235     node ?VP [cat=vp, agr=?AGR, e=?X0, limited = yes,
236       bounded = no, aspect = perf];
237     node ?Po [cat=pref];
238     node ?PoLex (mark=flex) [cat=po-];
239     node ?VPInt [cat=vp, agr=?AGR, e=?X0, bounded = no];
240     ?VP -> ?VPInt;
241     ?VP -> ?Po;
242     ?Po -> ?PoLex;
243     ?Po >> ?VPInt
244   };
245   <frame>{
246     ?X0[bounded-event,
247       m-dim:?VDim[scale],
248       verb-dim: ?VDim,
249       init: [stage,
250         scale-deg:?Init],
251       fin: [stage,

```

B XMG Implementation

```
252         scale-deg:?Fin]
253     ]
254 }
255 }
256
257 class PereVerb
258 export ?VP ?VPInt
259 declare ?VP ?VPInt ?Pere ?PereLex ?AGR ?X0 ?ScMin ?ScMax ?MDim
260 {
261     <syn>{
262         node ?VP [cat=vp, agr=?AGR, e=?X0, bounded = yes,
263             limited = yes, aspect = perf];
264         node ?Pere [cat=pref];
265         node ?PereLex (mark=flex) [cat=pere-];
266         node ?VPInt [cat=vp, agr=?AGR, e=?X0, bounded = no];
267         ?VP -> ?VPInt;
268         ?VP -> ?Pere;
269         ?Pere -> ?PereLex;
270         ?Pere >> ?VPInt
271     };
272     <frame>{
273         ?X0[bounded-event,
274             m-dim: ?MDim[proper-scale,
275                 min: ?ScMin,
276                 max: ?ScMax],
277             init: [stage,
278                 scale-deg:?ScMin],
279             fin: [stage,
280                 scale-deg:?ScMax],
281             noun-dim:?MDim
282         ]
283     }
284 }
285
286 %% Repetitive pere-
287 class PereIterVerb
288 export ?VP ?VPInt
289 declare ?VP ?VPInt ?Pere ?PereLex ?AGR ?X0 ?X1 ?Deg1 ?Deg2
290         ?Scale ?NounDim ?Aspect ?EventType ?Init ?Fin ?Asp
```

```

291 {
292   <syn>{
293     node ?VP [cat=vp, agr=?AGR, e=?X1, bounded = ?Asp,
294       limited = yes, aspect = ?Aspect];
295     node ?Pere [cat=pref];
296     node ?PereLex (mark=flex) [cat=pere-];
297     node ?VPInt [cat=vp, agr=?AGR, e=?X0, bounded = ?Asp,
298       limited = yes, aspect = ?Aspect];
299     ?VP -> ?VPInt;
300     ?VP -> ?Pere;
301     ?Pere -> ?PereLex;
302     ?Pere >> ?VPInt
303   };
304   <frame>{
305     ?X1[?EventType,
306       m-dim:?Scale[property-scale],
307       noun-dim:?NounDim,
308       init: ?Init,
309       fin: ?Fin,
310       prep:?X0[?EventType,
311         m-dim:?Scale,
312         noun-dim:?NounDim,
313         init: ?Init,
314         fin: ?Fin]
315     ]
316   }
317 }
318
319 class DoVerb
320 export ?VP ?VPInt
321 declare ?VP ?VPInt ?Do ?DoLex ?AGR ?X0 ?X1 ?Deg1 ?Deg2 ?Deg3
322   ?NDimType ?VDimType ?NDim ?VDim ?MDim
323 {
324   <syn>{
325     node ?VP [cat=vp, agr=?AGR, e=?X1, bounded = yes,
326       limited = yes, aspect = perf];
327     node ?Do [cat=pref];
328     node ?DoLex (mark=flex) [cat=do-];
329     node ?VPInt [cat=vp, agr=?AGR, e=?X0, limited = yes];

```

B XMG Implementation

```
330     ?VP -> ?VPInt;
331     ?VP -> ?Do;
332     ?Do -> ?DoLex;
333     ?Do >> ?VPInt
334 };
335 <frame>{
336     ?X1[bounded-event,
337         m-dim:[closed-scale,
338             min: ?Deg1,
339             max: ?Deg2],
340     fin:[stage,
341         scale-deg:?Deg2],
342     init: [stage,
343         scale-deg:?Deg3],
344     part-of: ?X0
345 ];
346     ?X0[bounded-event,
347         init: [stage,
348             scale-deg:?Deg1],
349         fin: [stage,
350             scale-deg:?Deg2],
351         m-dim: [non-eventive]
352 ]
353 }
354 }
355
356
357 % Coersion: allows to create bounded events out of unbounded
           events
358 class NDimCoercedVerb
359 export ?VP ?VPInt
360 declare ?VP ?AGR ?X0 ?ScMin ?ScMax ?NounDim ?VPInt
361 {
362     <syn>{
363         node ?VP [cat=vp, agr=?AGR, e=?X0, bounded = yes,
364             limited = yes, aspect = perf];
365         node ?VPInt [cat=vp, agr=?AGR, e=?X0, limited = no, aspect =
366             imperf];
367     }
368     ?VP -> ?VPInt
```



```

367   };
368   <frame>{
369     ?X0[bounded-event,
370       m-dim: ?NounDim[property-scale & closed-scale,
371         min: ?ScMin,
372         max: ?ScMax],
373       noun-dim:?NounDim,
374       init:[stage,
375         scale-deg:?ScMin],
376       fin:[stage,
377         scale-deg:?ScMax]
378     ]
379   }
380 }
381
382 %%%%%%%%%%%%%%%%%%%%%%%%%%%%%%%%%%%%%%%%%%
383 %Imperfective suffix
384 %%%%%%%%%%%%%%%%%%%%%%%%%%%%%%%%%%%%%%%%%%
385
386 %With iterative meaning
387 class IterVerb
388 export ?VP ?VPInt
389 declare ?VP ?VPInt ?Suf ?Iva ?AGR ?X0 ?X1 ?VDim
390 {
391   <syn>{
392     node ?VP [cat=vp, agr=?AGR, e=?X1, bounded = no, limited =
393       no,
394       aspect = imperf, iteration = yes];
395     node ?Suf [cat=suf];
396     node ?Iva (mark=flex) [cat=iva-];
397     node ?VPInt [cat=vp, agr=?AGR, e=?X0, limited = yes];
398     ?VP -> ?VPInt;
399     ?VP -> ?Suf;
400     ?Suf -> ?Iva;
401     ?VPInt >> ?Suf
402   };
403   <frame>{
404     ?X1[event & iteration,
405       segment:?X0[bounded-event,

```

B XMG Implementation

```
405         noun-dim:[property-scale],
406         verb-dim: ?VDim],
407     verb-dim: ?VDim,
408     noun-dim:[cardinality]
409 ]
410 }
411 }
412
413 %With progressive meaning
414 class ProgrVerb
415 export ?VP ?VPInt
416 declare ?VP ?VPInt ?Suf ?Iva ?AGR ?X0 ?X1 ?NounDim ?VDim
417 {
418     <syn>{
419         node ?VP [cat=vp, agr=?AGR, e=?X1, bounded = no,
420                 limited = yes, aspect = imperf];
421         node ?Suf [cat=suf];
422         node ?Iva (mark=flex) [cat=iva-];
423         node ?VPInt [cat=vp, agr=?AGR, e=?X0, bounded = yes];
424         ?VP -> ?VPInt;
425         ?VP -> ?Suf;
426         ?Suf -> ?Iva;
427         ?VPInt >> ?Suf
428     };
429     <frame>{
430         ?X1 [event & progression,
431             part-of:?X0[bounded-event,
432                 noun-dim: ?NounDim,
433                 verb-dim: ?VDim],
434             noun-dim: ?NounDim,
435             verb-dim: ?VDim
436         ]
437     }
438 }
439
440 %%%%%%%%%%%%%%%%%%%%%%%%%%%%%%%%%%%%%%%%%%%%%%%%%%%%%%%%%%%%%%%%%%%%%%%%%
441 %Gathering verbs with one prefix
442
443 class OneBasePrefixedVerb
```

```

444 export ?VP ?VPInt ?VPBase
445 declare ?VP ?VPpref ?VSp ?VPInt ?VP ?AGR ?X0 ?VPBase
446 {
447     {?VPpref = DoVerb[] | ?VPpref = PereVerb[] |
448     ?VPpref = PereIterVerb[] | ?VPpref = PoVerb[]};
449     ?VP = ?VPpref.?VP;
450     ?VSp = VSpine[];
451     ?VPInt = ?VSp.?VP;
452     ?VPInt = ?VPpref.?VPInt;
453     ?VPBase = ?VPInt
454 }
455
456 class OneCoercedPrefixedVerb
457 export ?VP ?VPInt ?VPBase
458 declare ?VP ?VPpref ?VSp ?VPInt ?AGR ?X0 ?VPBase ?VCoerce
459 {
460     {?VPpref = DoVerb[] | ?VPpref = PereIterVerb[]};
461     ?VP = ?VPpref.?VP;
462     ?VSp = VSpine[];
463     ?VCoerce = NDimCoercedVerb[];
464     ?VPInt = ?VCoerce.?VP;
465     ?VPInt = ?VPpref.?VPInt;
466     ?VCoerce.?VPInt = ?VSp.?VP;
467     ?VPBase = ?VPInt
468 }
469
470 class VerbWithOnePrefix
471 export ?VP ?VPInt ?VPBase
472 declare ?Verb ?VP ?VPInt ?VPBase
473 {
474     {?Verb = OneBasePrefixedVerb[] | ?Verb =
475     OneCoercedPrefixedVerb[]
476     | ?Verb = Zapisat[]};
477     ?VP = ?Verb.?VP;
478     ?VPInt = ?Verb.?VPInt;
479     ?VPBase = ?Verb.?VPBase
480 }
481

```

B XMG Implementation

```
482 %%%%%%%%%%%%%%%%%%%%%%%%%%%%%%%%%%%%%%%%%%%%%%%%%%%%%%%%%%%%%%%%%%%%%%%%%%
483 %Assembling multiply prefixed-suffixed verbs
484
485 %Stacking the second prefix above the first
486 class TwoPrefixedVerb
487 export ?VP ?VPInt ?VPBase
488 declare ?VP ?VPpref ?V ?VSp ?VPInt ?VP ?VPBase
489 {
490     {?VPpref = DoVerb[] | ?VPpref = PereVerb[] |
491         ?VPpref = PereIterVerb[] | ?VPpref = PoVerb[]};
492     ?VP = ?VPpref.?VP;
493     ?VSp = VerbWithOnePrefix[];
494     ?VPInt = ?VSp.?VP;
495     ?VPInt = ?VPpref.?VPInt;
496     ?VPBase = ?VSp.?VPBase
497 }
498
499 %Adding imperfective suffix
500 class SuffVerb
501 export ?VP ?VPInt ?VPBase ?NP ?VPFin ?VPBaseOld
502 declare ?VP ?VPInt ?Suf ?VPBaseOld ?VPBase ?Verb ?NP ?Noun ?
    VPFin
503 {
504     {?Verb = VerbWithOnePrefix[] | ?Verb = TwoPrefixedVerb[]};
505     ?VPInt = ?Verb.?VP;
506     ?VPBaseOld = ?Verb.?VPBase;
507     {?Suf = ProgrVerb[] | ?Suf = IterVerb[]};
508     ?VP = ?Suf.?VP;
509     ?VPInt = ?Suf.?VPInt;
510     ?VPBase = ?VP;
511     ?Noun = NDim[];
512     ?NP = ?Noun.?NP;
513     ?VPBaseOld = ?Noun.?VP;
514     <syn>{
515         node ?VPFin [cat = vpfull];
516         ?VPFin ->+ ?VP;
517         ?VPFin -> ?NP
518     }
519 }
```

```

520
521 %%%%%%%%%%%%%%%%%%%%%%%%%%%%%%%%%%%%%%%%%%
522 %Checking that types are inherited
523 class TypeMatcher
524 export ?VP0ut ?VPInt
525 declare ?VPInt ?X0 ?X1 ?NDimType ?VDimType ?MDim ?VP0ut
526 {
527 <syn>{
528     node ?VP0ut [e=?X1];
529     node ?VPInt [e=?X0]
530 };
531 <frame>{
532     ?X1[event,
533         m-dim: [?MDim],
534         noun-dim: [?NDimType],
535         verb-dim: [?VDimType]
536 ];
537     ?X0[event,
538         m-dim: [?MDim],
539         noun-dim: [?NDimType],
540         verb-dim: [?VDimType]
541     ]
542 }
543 }
544
545 class SuffTyped
546 export ?VP ?VPBase ?NP ?VPFin
547 declare ?VP ?VPInt ?Suf ?VPBase0ld ?VPBase ?NP ?Verb ?VPFin
548     ?X0 ?X1 ?NDimType ?VDimType ?MDim ?Typing ?VP0ut
549 {
550     ?Verb = SuffVerb[];
551     ?Typing = TypeMatcher[];
552     ?VPInt = ?Verb.?VPInt;
553     ?VPInt = ?Typing.?VPInt;
554     ?VP0ut = ?Verb.?VPBase0ld;
555     ?VP0ut = ?Typing.?VP0ut;
556     ?VPBase = ?Verb.?VPBase;
557     ?NP = ?Verb.?NP;
558     ?VPFin = ?Verb.?VPFin;

```

B XMG Implementation

```
559     ?VP = ?Verb.?VP
560 }
561
562 %%%%%%%%%%%%%%%%%%%%%%%%%%%%%%%%%%%%%%%%%%%%%%%%%%%%%%%%%%
563 %Stacking the another prefix above the suffix
564
565 class TwoPrefixedSuffixedVerb
566 export ?VP ?VPInt ?VPBase ?NP ?VPFin
567 declare ?VP ?VPpref ?V ?VSp ?VPInt ?VP ?AGR ?X0 ?VPBase ?NP ?
    VPFin
568 {
569     {?VPpref = DoVerb[] | ?VPpref = PereVerb[]
570     | ?VPpref = PereIterVerb[] | ?VPpref = PoVerb[]};
571     ?VP = ?VPpref.?VP;
572     ?VSp = SuffTyped[];
573     ?VPInt = ?VSp.?VP;
574     ?VPInt = ?VPpref.?VPInt;
575     ?VPBase = ?VSp.?VPBase;
576     ?VPFin = ?VSp.?VPFin;
577     ?NP = ?VSp.?NP
578 }
579
580 %%%%%%%%%%%%%%%%%%%%%%%%%%%%%%%%%%%%%%%%%%%%%%%%%%%%%%%%%%
581 %Assembling the direct object
582
583 class PrefixedVerbDirObj
584 export ?VPFin ?NP ?VPBase
585 declare ?VP ?VPpref ?V ?VSp ?VPInt ?VP ?AGR ?X0 ?X1 ?NP
586         ?VPFin ?Noun ?VPBase ?ASP ?NDimType ?VDimType ?MDim
587 {
588     ?Noun = NDim[];
589     ?NP = ?Noun.?NP;
590     {?VPpref = VerbWithOnePrefix[] | ?VPpref = TwoPrefixedVerb[]};
591     ?VP = ?VPpref.?VP;
592     ?VPBase = ?Noun.?VP;
593     ?VPBase = ?VPpref.?VPBase;
594     ?VPInt = ?VPpref.?VPInt;
595     <syn>{
```

```

596   node ?VPFin [cat = vpfull, agr = ?AGR, aspect = ?ASP, e = ?X1
      ];
597   node ?VP [cat = vp, agr = ?AGR, aspect = ?ASP, e = ?X1];
598   node ?VPBase [e=?X0];
599   node ?NP [case = acc];
600   ?VPFin -> ?VP;
601   ?VPFin -> ?NP
602   }
603 }
604
605 class PrefixedSuffixedVerbDirObj
606 export ?VPFin ?NP ?VPBase
607 declare ?VP ?VPpref ?V ?VSp ?VPInt ?VP ?AGR ?X0
608         ?NP ?VPFin ?Noun ?VPBase ?ASP ?X0
609 {
610   ?Noun = NDim[];
611   ?NP = ?Noun.?NP;
612   ?VPpref = TwoPrefixedSuffixedVerb[];
613   ?VP = ?VPpref.?VP;
614   ?VPBase = ?Noun.?VP;
615   ?VPBase = ?VPpref.?VPBase;
616   ?VPInt = ?VPpref.?VPInt;
617   ?NP = ?VPpref.?NP;
618   ?VPFin = ?VPpref.?VPFin;
619   <syn>{
620     node ?VPFin [cat = vpfull, agr = ?AGR, aspect = ?ASP, e = ?X0
        ];
621     node ?VP [cat = vp, agr = ?AGR, aspect = ?ASP, e = ?X0];
622     node ?NP [case = acc];
623     ?VPFin -> ?VP;
624     ?VPFin -> ?NP
625   }
626 }
627
628 %%%%%%%%%%%%%%%%%%%%%%%%%%%%%%%%%%%%%%%%%%%%%%%%%%%%%%%%%%%%%%%%%%%%%%%%%
629 %Matching types again
630 class PrefTyped
631 export ?NP ?VPFin ?VPBase ?VP
632 declare ?VP ?VPInt ?VPBase ?NP ?Verb ?VPFin ?X0 ?X1

```

B XMG Implementation

```
633         ?NDimType ?VDimType ?MDim ?Typing ?VP0ut
634 {
635     {?Verb = PrefixedVerbDirObj[]|?Verb =
        PrefixedSuffixedVerbDirObj[]};
636     ?Typing = TypeMatcher[];
637     ?VPInt = ?Verb.?VPBase;
638     ?VPInt = ?Typing.?VPInt;
639     ?VP0ut = ?Verb.?VPFin;
640     ?VP0ut = ?Typing.?VP0ut;
641     ?NP = ?Verb.?NP;
642     ?VPFin = ?Verb.?VPFin;
643     ?VPBase = ?Verb.?VPBase;
644     ?VP = ?VPFin
645 }
646
647 %%%%%%%%%%%%%%%%%%%%%%%%%%%%%%%%%%%%%%%%%%%%%%%%%%%%%%%%%
648 %Assembling the results in one class
649 class AllVerbs
650 declare ?Verb
651 {
652     {?Verb = PrefTyped[] | ?Verb = SuffTyped[]}
653 }
654
655 value AllVerbs
```

B.2 Analysis proposed by Tatevosov (2009)

```
1 use unicity with (mark=anchor) dims (syn)
2
3 type CAT={vp,v,det,pref,suf,pisat,zapisat, po-,pere-,do-,za-,iva
  -}
4 type MARK={lex,anchor, flex}
5 type CASE={acc,gen,nom,inst}
6 type AGR !
7 type LABEL!
8 type A={perf, imperf}
9
```

B.2 Analysis proposed by Tatevosov (2009)

```
10 feature cat: CAT
11 feature e: LABEL
12 feature agr: AGR
13 feature gcase: CASE
14 feature aspect:A
15 property mark: MARK
16
17 frame-types = {write, write-down, distributive, delimitative,
18   completive, iteration, imperfective, repetitive}
19 frame-constraints = {
20 write write-down -> -,
21 distributive delimitative -> -,
22 completive delimitative -> -,
23 distributive iteration -> -,
24 distributive repetitive -> -
25 }
26
27 %%Lexical entries for verbs
28 class Zapisat
29 export ?VP ?VPInt
30 declare ?V ?Pisat ?Za ?ZaLex ?X0 ?AGR ?VP ?VPInt
31 {
32   <syn>{
33     node ?VP [cat=vp, agr=?AGR, e=?X0, aspect = perf];
34     node ?V (mark=anchor) [cat=v, agr=?AGR, aspect = imperf];
35     node ?Pisat (mark=flex) [cat=pisat, agr=?AGR, aspect =
36       imperf];
37     node ?Za [cat=pref];
38     node ?ZaLex (mark=flex) [cat=za-];
39     node ?VPInt [cat=vp, agr=?AGR, e=?X0, aspect = perf];
40     ?VP -> ?VPInt;
41     ?VPInt -> ?V;
42     ?VP -> ?Za;
43     ?Za -> ?ZaLex;
44     ?Za >> ?VPInt;
45     ?V -> ?Pisat
46   };
47   <frame>{
48     ?X0[write-down]
```

B XMG Implementation

```
48   }
49   }
50
51   class Pisat
52   export ?V
53   declare ?V ?Pisat ?X0
54   {
55     <syn>{
56       node ?V (mark=anchor) [cat=v, e=?X0, aspect = imperf];
57       node ?Pisat (mark=flex) [cat=pisat, e=?X0, aspect = imperf
58         ];
59       ?V -> ?Pisat
60     };
61     <frame>{
62       ?X0[write]
63     }
64
65     %Creating the minimal VP and filling the verbal slot
66     class VSpine
67     export ?VP ?VPInt
68     declare ?VP ?V ?AGR ?X0 ?K ?VPInt ?Asp ?VLex ?A
69     {
70       ?VPInt = ?VP;
71       ?VLex = Pisat[];
72       ?V = ?VLex.?V;
73       <syn>{
74         node ?VP [cat=vp, agr=?AGR, e=?X0, aspect = ?A];
75         node ?V (mark=anchor) [cat=v, agr=?AGR, e=?X0, aspect = ?A
76           ];
77         ?VP -> ?V
78       }
79
80       %%%%%%%%%%%%%%%%%%%%%%%%%%%%%%%%%%%%%%%%%%%%%%%%%%%%%%%%%
81       %%Constructions associated with prefixes
82       %%"Delimitative" po-
83       class PoVerb
84       export ?VP ?VPInt
```

B.2 Analysis proposed by Tatevosov (2009)

```
85 declare ?VP ?VPInt ?Po ?PoLex ?AGR ?X0 ?X1
86 {
87   <syn>{
88     node ?VP [cat=vp, agr=?AGR, e=?X1, aspect = perf];
89     node ?Po [cat=pref];
90     node ?PoLex (mark=flex) [cat=po-];
91     node ?VPInt [cat=vp, agr=?AGR, e=?X0, aspect=imperf];
92     ?VP -> ?VPInt;
93     ?VP -> ?Po;
94     ?Po -> ?PoLex;
95     ?Po >> ?VPInt
96   };
97   <frame>{
98     ?X1[delimitative,
99       of: ?X0]
100  }
101 }
102
103 class PoDistrVerb
104 export ?VP ?VPInt
105 declare ?VP ?VPInt ?Po ?PoLex ?AGR ?X0 ?X1
106 {
107   <syn>{
108     node ?VP [cat=vp, agr=?AGR, e=?X1, aspect = perf];
109     node ?Po [cat=pref];
110     node ?PoLex (mark=flex) [cat=po-];
111     node ?VPInt [cat=vp, agr=?AGR, e=?X0];
112     ?VP -> ?VPInt;
113     ?VP -> ?Po;
114     ?Po -> ?PoLex;
115     ?Po >> ?VPInt
116   };
117   <frame>{
118     ?X1[distributive,
119       of: ?X0]
120  }
121 }
122
123 class PereVerb
```

B XMG Implementation

```
124 export ?VP ?VPInt
125 declare ?VP ?VPInt ?Pere ?PereLex ?AGR ?X0 ?X1
126 {
127   <syn>{
128     node ?VP [cat=vp, agr=?AGR, e=?X1, aspect = perf];
129     node ?Pere [cat=pref];
130     node ?PereLex (mark=flex) [cat=pere-];
131     node ?VPInt [cat=vp, agr=?AGR, e=?X0, aspect = imperf];
132     ?VP -> ?VPInt;
133     ?VP -> ?Pere;
134     ?Pere -> ?PereLex;
135     ?Pere >> ?VPInt
136   };
137   <frame>{
138     ?X1[distributive,
139       of: ?X0]
140   }
141 }
142
143 %% Repetitive pere-
144 class PereIterVerb
145 export ?VP ?VPInt
146 declare ?VP ?VPInt ?Pere ?PereLex ?AGR ?X0 ?X1
147 {
148   <syn>{
149     node ?VP [cat=vp, agr=?AGR, e=?X1, aspect = perf];
150     node ?Pere [cat=pref];
151     node ?PereLex (mark=flex) [cat=pere-];
152     node ?VPInt [cat=vp, agr=?AGR, e=?X0];
153     ?VP -> ?VPInt;
154     ?VP -> ?Pere;
155     ?Pere -> ?PereLex;
156     ?Pere >> ?VPInt
157   };
158   <frame>{
159     ?X1[repetitive,
160       of: ?X0]
161   }
162 }
```

```
163
164 class DoVerb
165 export ?VP ?VPInt
166 declare ?VP ?VPInt ?Do ?DoLex ?AGR ?X0 ?X1
167 {
168   <syn>{
169     node ?VP [cat=vp, agr=?AGR, e=?X1, aspect = perf];
170     node ?Do [cat=pref];
171     node ?DoLex (mark=flex) [cat=do-];
172     node ?VPInt [cat=vp, agr=?AGR, e=?X0];
173     ?VP -> ?VPInt;
174     ?VP -> ?Do;
175     ?Do -> ?DoLex;
176     ?Do >> ?VPInt
177   };
178   <frame>{
179     ?X1[completive,
180       of:?X0]
181   }
182 }
183
184 %%%%%%%%%%%%%%%%%%%%%%%%%%%%%%%%%%%%%%%%%%%%%%%%%%%%%%%%%%%%%%%%%%%%%%%%%
185 %%Gathering verbs with one prefix
186 class OneBasePrefixedVerb
187 export ?VP ?VPInt
188 declare ?VP ?VPpref ?VSp ?VPInt ?VP ?AGR ?X0
189 {
190   {?VPpref = DoVerb[] | ?VPpref = PereVerb[] | ?VPpref =
191     PereIterVerb[] |
192     ?VPpref = PoVerb[]};
193   ?VP = ?VPpref.?VP;
194   ?VSp = VSpine[];
195   ?VPInt = ?VSp.?VP;
196   ?VPInt = ?VPpref.?VPInt
197 }
198 class VerbWithOnePrefix
199 export ?VP ?VPInt
200 declare ?Verb ?VP ?VPInt
```

B XMG Implementation

```
201 {
202     {?Verb = OneBasePrefixedVerb[] | ?Verb = Zapisat[]};
203     ?VP = ?Verb.?VP;
204     ?VPInt = ?Verb.?VPInt
205 }
206
207 %%%%%%%%%%%%%%%%%%%%%%%%%%%%%%%%%%%%%%%%%%%%%%%%%%%%%%%%%%%%%%%%%%%%%%%%%
208 %%Assembling multiply prefixed-suffixed verbs
209 %%Stacking the second prefix above the first
210
211 class TwoPrefixedVerb
212 export ?VP ?VPInt
213 declare ?VP ?VPpref ?V ?VSp ?VPInt ?VP ?AGR ?X0
214 {
215     {?VPpref = DoVerb[] | ?VPpref = PereVerb[] |
216     ?VPpref = PereIterVerb[] | ?VPpref = PoVerb[]};
217     ?VP = ?VPpref.?VP;
218     ?VSp = VerbWithOnePrefix[];
219     ?VPInt = ?VSp.?VP;
220     ?VPInt = ?VPpref.?VPInt
221 }
222
223 %%Adding imperfective suffix
224 class ImpVerb
225 export ?VP ?VPInt
226 declare ?VP ?VPInt ?Suf ?Iva ?AGR ?X0 ?X1
227 {
228     <syn>{
229         node ?VP [cat=vp, agr=?AGR, e=?X1, aspect = imperf];
230         node ?Suf [cat=suf];
231         node ?Iva (mark=flex) [cat=iva-];
232         node ?VPInt [cat=vp, agr=?AGR, e=?X0];
233         ?VP -> ?VPInt;
234         ?VP -> ?Suf;
235         ?Suf -> ?Iva;
236         ?VPInt >> ?Suf
237     };
238     <frame>{
239         ?X1[imperfective,
```

```
240         of:?X0]
241     }
242 }
243
244 %%Assembling suffixed verb
245 class SuffVerb
246 export ?VP ?VPInt
247 declare ?VP ?VPInt ?Suf ?X0 ?X1 ?X2 ?X3 ?Verb
248 {
249     {?Verb = VerbWithOnePrefix[] | ?Verb = TwoPrefixedVerb[]};
250     ?VPInt = ?Verb.?VP;
251     ?Suf = ImpVerb[];
252     ?VP = ?Suf.?VP;
253     ?VPInt = ?Suf.?VPInt
254 }
255
256 %%Stacking the another prefix above the suffix
257 class PrefixedSuffixedVerb
258 export ?VP ?VPInt
259 declare ?VP ?VPpref ?V ?VSp ?VPInt ?VP ?AGR ?X0
260 {
261     {?VPpref = PereVerb[] | ?VPpref = PoVerb[]};
262     ?VP = ?VPpref.?VP;
263     ?VSp = SuffVerb[];
264     ?VPInt = ?VSp.?VP;
265     ?VPInt = ?VPpref.?VPInt
266 }
267
268 class AlmostAllVerbs
269 export ?VP ?VPInt
270 declare ?Verb ?VP ?VPInt
271 {
272     {?Verb = VerbWithOnePrefix[] | ?Verb = SuffVerb[]};
273     ?VP = ?Verb.?VP;
274     ?VPInt = ?Verb.?VPInt
275 }
276
277 class PoDistrPrefixedVerb
278 export ?VP ?VPInt
```

B XMG Implementation

```
279 declare ?VP ?VPpref ?V ?VSp ?VPInt ?VP ?AGR ?X0
280 {
281     ?VPpref = PoDistrVerb[];
282     ?VP = ?VPpref.?VP;
283     {?VSp = AlmostAllVerbs[] | ?VSp = VSpine[]};
284     ?VPInt = ?VSp.?VP;
285     ?VPInt = ?VPpref.?VPInt
286 }
287
288 class AllVerbs
289 declare ?Verb
290 {
291     {?Verb = AlmostAllVerbs[] | ?Verb = PoDistrPrefixedVerb[]
292     | ?Verb = PrefixedSuffixedVerb[] | ?Verb = TwoPrefixedVerb[]}
293 }
294
295 value AllVerbs
```

References

- Abeillé, Anne. 2002. *Une grammaire électronique du français*. Paris: CNRS Editions.
- Abeillé, Anne & Owen Rambow. 2000. Tree Adjoining Grammar: An overview. In Anne Abeillé & Owen Rambow (eds.), *Tree Adjoining Grammars: Formalisms, linguistic analyses and processing*, 1–68. Stanford: CSLI Publications.
- Altshuler, Daniel. 2012. Aspectual meaning meets discourse coherence: A look at the Russian imperfective. *Journal of Semantics* 29(1), 39–108.
- Anderson, Cori. 2002. *Biaspectual verbs in Russian and their implications on the category of aspect*. The University of North Carolina. (Senior Honor dissertation).
- Arsenijević, Boban, Berit Gehrke & Rafael Marín. 2013. The (de)composition of event predicates. In Boban Arsenijević, Berit Gehrke & Rafael Marín (eds.), *Studies in the composition and decomposition of event predicates* (Studies in Linguistics and Philosophy), 1–26. Dordrecht: Springer.
- Asher, Nicholas & Laure Vieu. 2005. Subordinating and coordinating discourse relations. *Lingua* 115(4), 591–610.
- Avilova, Natal'ja S. 1964. Razvitije pristavočnogo glagol'nogo slovoobrazovanija [The development of prefixational verb derivation]. In Viktor Vladimirovič Vinogradov & Natalja Jurjevna Švedova (eds.), *Glagol, narečije, predlogi i sojuzy v ruskom literaturnom jazyke XIX veka*. [Verbs, adverbs, prepositions, and conjunctions in Russian literary language of XIX century.], 45–104. Moscow: Nauka.
- Avilova, Natal'ja S. 1968. Dvuvidovye glagoly s zaimstvovannoju osnovoj v ruskom literaturnom jazyke novogo vremeni [Biaspectual verbs with loaned stem in contemporary Russian literary language]. *Voprosy jazykoznanija* 5, 66–78.
- Avilova, Natal'ja S. 1976. *Vid glagola i semantika glagol'nogo slova* [Verbal aspect and the semantics of the verb]. Moscow: Akademija nauk SSSR.
- Babko-Malaya, Olga. 1999. *Zero morphology: A study of aspect, argument structure, and case*. Rutgers University. (dissertation).
- Bach, Emmon. 1986. The algebra of events. *Linguistics and Philosophy* 9(1), 5–16.

References

- Bach, Emmon, Eloise Jelinek, Angelika Kratzer & Barbara H. Partee (eds.). 1995. *Quantification in natural languages*. Vol. 54 (Studies in Linguistics and Philosophy). Dordrecht: Springer.
- Barsalou, Lawrence W. 1992. Frames, concepts, and conceptual fields. In Adrienne Lehrer & Eva Feder Kittay (eds.), *Frames, fields, and contrasts* (New Essays in Semantic and Lexical Organization), chap. 1, 21–74. Hillsdale, New Jersey: Lawrence Erlbaum Associates.
- Beaver, David I. 2001. *Presupposition and assertion in dynamic semantics*. Vol. 29. Stanford: CSLI publications.
- Beavers, John. 2002. Aspect and the distribution of prepositional resultative phrases in English. In *LinGO working paper*, vol. 2002-07. Stanford: Center for the Study of Language & Information, Stanford University. <http://lingo.stanford.edu/working-papers.html>.
- Beavers, John. 2008. Scalar complexity and the structure of events. In Johannes Dölling, Tatjana Heyde-Zybatow & Martin Schäfer (eds.), *Event structures in linguistic form and interpretation*, 245–268. Berlin: de Gruyter.
- Beavers, John. 2012. Lexical aspect and multiple incremental themes. In Violeta Demonte & Louise McNally (eds.), *Telicity, change, and state: A cross-categorical view of event structure*, 23–59. Oxford: Oxford University Press.
- Benz, Anton & Jason Mattausch. 2011. *Bidirectional optimality theory*. Vol. 180 (Linguistics today). Amsterdam: John Benjamins Publishing.
- Binnick, Robert I. 1991. *Time and the verb: A guide to tense and aspect*. New York: Oxford University Press.
- Blutner, Reinhard. 2000. Some aspects of optimality in natural language interpretation. *Journal of Semantics* 17(3). 189–216.
- Bochnak, M. Ryan. 2013. Two sources of scalarity within the verb phrase. In Boban Arsenijević, Berit Gehrke & Rafael Marín (eds.), *Studies in the composition and decomposition of event predicates* (Studies in Linguistics and Philosophy), 99–123. Dordrecht: Springer.
- Bogusławski, Andrzej. 1963. *Prefiksacja czasownika we współczesnym języku rosyjskim*. Warszawa, Kraków: Zakład Narodowy im. Ossolińskich.
- Bondarko, Aleksandr. 1971. *Vid i vremja russkogo glagola [The aspect and tense of the Russian verb]*. Moscow: Prosveščeniye.
- Borer, Hagit. 2003. *The exo-skeletal trilogy*. University of Southern California, Los Angeles. (MA thesis).
- Borer, Hagit. 2005. *Structuring sense II: The normal course of events*. Oxford: Oxford University Press.

- Borer, Hagit. 2015. Between function and content: The case of Slavic perfective prefixes. In Gerhild Zybatow, Petr Biskup, Marcel Guhl & Claudia Hurtig (eds.), *Slavic grammar from a formal perspective: The 10th anniversary FDSL conference, Leipzig 2013*. Frankfurt: Peter Lang.
- Borik, Olga. 2002. *Aspect and reference time*. University of Utrecht. (Doctoral dissertation).
- Braginsky, Pavel. 2008. *The semantics of the prefix ZA- in Russian*. Bar-Ilan University, Department of English. (Doctoral dissertation).
- Candito, Marie-Hélène. 1999. *Organisation modulaire et paramétrable de grammaires électroniques lexicalisées. Application au français et à l'italien*. Université Paris 7. (Doctoral dissertation).
- Caudal, Patrick & David Nicolas. 2005. Types of degrees and types of event structures. In Claudia Maienborn & Angelika Wöllstein (eds.), *Event arguments: Foundations and applications*, 277–300. Tübingen: Niemeyer.
- Černyšev, Vasilij I. (ed.). 1950–1965. *Slovar' sovremennogo russkogo literaturnogo jazyka*. [Dictionary of contemporary Russian literary language]. Moscow: Izdatel'stvo Akademii Nauk SSSR.
- Čertkova, Marina Ju. & Pej-Či Čang. 1998. Evoljucija dvuvidovyx glagolov v sovremennom russkom jazyke. [Evolution of the biaspectual verbs in contemporary Russian.]. *Russian linguistics* 22. 13–34.
- Čertkova, Marina Ju. 1996. *Grammatičeskaja kategorija vida v sovremennom russkom jazyke* [The grammatical category of aspect in contemporary Russian]. Moscow: Moscow State University.
- Chemla, Emmanuel. 2009. Presuppositions of quantified sentences: Experimental data. *Natural Language Semantics* 17(4). 299–340. DOI: 10.1007/s11050-009-9043-9.
- Chierchia, Gennaro & Sally McConnell-Ginet. 1990. *Meaning and grammar: An introduction to semantics*. Cambridge, MA: MIT Press.
- Comrie, Bernard. 1976. *Aspect*. Cambridge: Cambridge University Press.
- Crabbé, Benoît, Denys Duchier, Claire Gardent, Joseph Le Roux & Yannick Parmentier. 2013. XMG: EXtensible MetaGrammar. *Computational Linguistics* 39(3). 591–629.
- Crabbé, Benoît & Denys Duchier. 2004. Metagrammar redux. In *International workshop on constraint solving and language processing*. Copenhagen.
- Cubberly, Paul V. 1982. On the “empty” prefixes in Russian. *Russian Language Journal* 36. 14–30.
- Demjjanow, Assinja. 1997. *Eine semantische Analyse der Perfektivierungspräfigierung im Russischen* (Slavistische Beiträge 365). München: Sagner.

References

- Di Sciullo, Anne M. & Roumyana Slabakova. 2005. Quantification and aspect. In Henk Verkuyl, Henriette de Swart & Angeliek van Hout (eds.), *Perspectives on aspect*, vol. 32 (Studies in Theoretical Psycholinguistics), 61–80. Dordrecht: Springer.
- Dickey, Stephen. 2000. *Parameters of Slavic aspect: A cognitive approach*. Stanford: CSLI Publications.
- Dočekal, Mojmir & Ivona Kučerová. 2009. Bound ability readings of imperfective verbs. *Philosophy* 24. 223–270.
- Ducrot, Oswald. 1969. Présupposés et sous-entendus. *Langue Française* 4. 30–43.
- Efremova, Tatiana F. 2000. *Novyj slovar' russkogo jazyka. Tolkovo-slovoobrazovatel'nyj [New dictionary of Russian: Explanatory and interpretational]*. Moscow: Russkij jazyk.
- Evgen'eva, Anastasia P. (ed.). 1999. *Malyj Akademičeskij Slovar' [Small academic dictionary]*. Moscow: Russkij jazyk.
- Evgen'eva, Anastasia P. (ed.). 1957–1961. *Slovar' russkogo jazyka. [Dictionary of Russian language]*. Moscow: Russkij jazyk.
- Filip, Hana. 1992. Aspect and interpretation of nominal arguments. In Costas P. Canakis, Grace P. Chan & Jeanette Marshall Denton (eds.), *Proceedings of the Chicago linguistic society (CLS) 28*, 139–158. Chicago: The University of Chicago.
- Filip, Hana. 1999. *Aspect, eventuality types and nominal reference*. New York: Taylor & Francis.
- Filip, Hana. 2000. The quantization puzzle. In Carol Tenny & James Pustejovsky (eds.), *Events as grammatical objects*, 39–96. Stanford: CSLI Press.
- Filip, Hana. 2003. Prefixes and the delimitation of events. *Journal of Slavic Linguistics* 1(11). 55–101.
- Filip, Hana. 2005. Measures and indefinites. In Gregory N. Carlson & Francis Jeffrey Pelletier (eds.), *References and quantification: The Partee effect*, 229–288. Stanford: CSLI Publications.
- Filip, Hana. 2008. Events and maximalization. In Susan Rothstein (ed.), *Theoretical and crosslinguistic approaches to the semantics of aspect*, 217–256. Amsterdam: John Benjamins.
- Filip, Hana & Susan Rothstein. 2005. Telicity as a semantic parameter. In James Lavine, Steven Franks, Hana Filip & Mila Tasseva-Kurktchieva (eds.), *Formal approaches to Slavic linguistics (FASL 14): The Princeton University meeting*, 139–156. Ann Arbor, MI: Michigan Slavic Publications.
- Fillmore, Charles J. 1982. Frame Semantics. In the Linguistic Society of Korea (ed.), *Linguistics in the morning calm*, 111–137. Seoul: Hanshin Publishing Co.

- Fillmore, Charles J., Christopher R. Johnson & Miriam R. L. Pertuck. 2003. Background to FrameNet. *International Journal of Lexicography* 3(16). 235–250.
- Folli, Raffaella & Heidi Harley. 2005. Flavors of *v*. *Aspectual inquiries* 62. 95–120.
- Forsyth, James. 1970. *A grammar of aspect: Usage and meaning in the Russian verb*. Cambridge: Cambridge University Press.
- Frank, Michael C. & Noah D. Goodman. 2012. Predicting pragmatic reasoning in language games. *Science* 336(6084). 998–998.
- Frank, Robert. 1992. *Syntactic locality and tree adjoining grammar: Grammatical, acquisition and processing perspectives*. University of Pennsylvania. (Doctoral dissertation).
- Frank, Robert. 2002. *Phrase structure composition and syntactic dependencies*. Cambridge, MA: MIT Press.
- Franke, Michael. 2009. *Signal to act: Game theory in pragmatics*. Amsterdam: Institute for Logic, Language & Computation. (Doctoral dissertation).
- Franke, Michael & Gerhard Jäger. 2015. Probabilistic pragmatics, or why Bayes' rule is probably important for pragmatics. *Zeitschrift für Sprachwissenschaft* 35(1). 3–44.
- Galton, Herbert. 1976. *The main functions of the Slavic verbal aspect*. Skopje: Macedonian Academy of Sciences & Arts.
- Gardent, Claire & Laura Kallmeyer. 2003. Semantic construction in f-TAG. In *10th conference of the European chapter of the association for computational linguistics*. Budapest, Hungary: Association for Computational Linguistics. <https://www.aclweb.org/anthology/E03-1030>.
- Garey, Howard B. 1957. Verbal aspects in French. *Language* 33. 91–110.
- Gehrke, Berit. 2004. *How temporal is telicity?* Paper presented at the workshop *Argument realization: Conceptual and grammatical factors*. Leipzig.
- Giorgi, Alessandra & Fabio Pianesi. 2001. Ways of terminating. In Carlo Cecchetto, Gennaro Chierchia & Maria Teresa Guasti (eds.), *Semantic interfaces: Reference, anaphora and aspect*, 211–277. Stanford: CSLI.
- Gladney, Frank Y. 1982. Biaspectual verbs and the syntax of aspect in Russian. *Slavic and East European Journal* 26(2). 202–215.
- Golovin, Boris N. 1959. *Slovoobrazovatel'naja tipologija pristavochnyh glagolov [A derivational topology of prefixed verbs]*. Moscow: Slavyanskoje jazykoznanije.
- Goodman, Noah D. & Michael C. Frank. 2016. Pragmatic language interpretation as probabilistic inference. *Trends in Cognitive Sciences* 20(11). 818–829.
- Goodman, Noah D. & Andreas Stuhlmüller. 2013. Knowledge and implicature: Modeling language understanding as social cognition. *Topics in Cognitive Science* 5(1). 173–184.

References

- Grice, Herbert P. 1975. Logic and conversation. In Peter Cole & James L. Morgan (eds.), *Syntax and semantics 3: Speech acts*, 41–58. New York: Academic Press.
- Grønn, Atle. 2004. *The semantics and pragmatics of the Russian factual imperfective* (Acta Humaniora). PhD thesis. Oslo: University of Oslo.
- Grønn, Atle. 2006. Information structure and aspectual competition. In B. Gyuris, L. Kalman, C. Piñon & K. Varasdi (eds.), *The Ninth Symposium on Logic and Language*, 70–77. Budapest.
- Grønn, Atle & Arnim von Stechow. 2010. Complement tense in contrast: The SOT parameter in Russian and English. In Atle Grønn & Irena Marijanovic (eds.), *Russian in contrast*, vol. 2:1 (Oslo Studies in Language), 1–45. Oslo: University of Oslo.
- Gvozdev, Aleksandr N. 1973. *Sovremennyj literaturnyj russkij jazyk. č.1. Fonetika i morfologija [contemporary Russian. P.1. Phonetics and morphology]*. Moscow: Prosveščeniye.
- Gyarmathy, Zsófia. 2015. *Achievements, durativity and scales*. Berlin: Logos Verlag.
- Hay, Jen, Christopher Kennedy & Beth Levin. 1999. Scale structure underlies telicity in ‘degree achievements’. In Tanya Matthews & Devon Strolovitch (eds.), *Semantics and Linguistic Theory*, vol. 9, 127–144. Ithaca, NY: CLC Publications.
- Heim, Irene. 2000. Degree operators and scope. In *Proceedings of SALT 10*, 40–64. Ithaca, NY: CLC Publications.
- Heim, Irene. 1983/2002. On the projection problem for presuppositions. In *Formal semantics: The essential readings*, 249–260. Oxford: Blackwell.
- Horn, Laurence R. 1972. *On the semantic properties of logical operators in English*. Ph.D. dissertation. Los Angeles: UCLA.
- Horn, Laurence R. 1984. Towards a new taxonomy of pragmatic inference: Q-based and R-based implicature. In Deborah Schiffrin (ed.), *Meaning, form, and use in context: Linguistic applications*, 11–42. Washington: Georgetown University Press.
- Isačenko, Alexander V. 1960. *Grammatičeskij stroj russkogo jazyka v sopostavlenii s slovackim [Grammatical structure of Russian in comparison to Slovak]*. Moscow: Jazyki slavjanskoj kultury. <http://books.google.de/books?id=jKFhAAAAMAAJ>.
- Jakobson, Roman. 1957. *Shifters, verbal categories and the Russian verb* (Russian language project). Harvard University, Department of Slavic Languages & Literatures, Russian Language Project. <https://books.google.de/books?id=ASkAAAAIAAJ>.
- Jakobson, Roman. 1971. *Selected writings II: Word and language*. Berlin: Mouton de Gruyter.

- Janda, Laura A. 1988. The mapping of elements of cognitive space onto grammatical relations: An example from Russian verbal prefixation. *Topics in Cognitive Linguistics* 50. 327–344.
- Janda, Laura A. 2007. Aspectual clusters of Russian verbs. *Studies in Language* 31(3). 607–648.
- Janda, Laura A. 2010. Perfectives from indeterminate motion verbs in Russian. In Victoria Hasko & Renee Perelmutter (eds.), *New approaches to Slavic verbs of motion*. 125–39. Amsterdam: John Benjamins.
- Janda, Laura A. & Tore Nessel. 2010. Taking apart Russian *raz-*. *Slavic and East European Journal* 54(3). 477–502.
- Janssen, Maarten & Olga Borik. 2012. A database of Russian verbal aspect. *Oslo Studies in Language* 4(1).
- Jászay, László. 1999. Vidovye korreljaty pri dvuvidovyx glagolax [Aspectual correlates of biaspectual verbs]. *Studia Russica* 17. 169–177.
- Jespersen, Otto. 1924. *Philosophy of grammar*. London: George Allen & Unwin Ltd.
- Joshi, Aravind K. & Yves Schabes. 1997. Tree-Adjoining Grammars. In Grzegorz Rozenberg & Arto Salomaa (eds.), *Handbook of formal languages*, 69–123. Berlin: Springer.
- Kagan, Olga. 2011. The scale hypothesis and the prefixes *pere-* and *nedo-*. *Scando-Slavica* 57(2). 160–176.
- Kagan, Olga. 2012. Degree semantics for Russian verbal prefixes: The case of *pod-* and *do-*. *Oslo Studies in Language* 4(1). 207–243.
- Kagan, Olga. 2013. Scalarity in the domain of verbal prefixes. *Natural Language & Linguistic Theory* 31. 483–516.
- Kagan, Olga. 2015. *Scalarity in the verbal domain: The case of verbal prefixation in Russian*. Cambridge: Cambridge University Press.
- Kagan, Olga & Sascha Alexeyenko. 2010. Degree modification in Russian morphology: The case of the suffix *-ovat*. In Y. N. Falk (ed.), *Proceedings of IATL* 26.
- Kagan, Olga & Asya Pereltsvaig. 2011a. Bare NPs and semantic incorporation: Objects of intensive reflexives at the syntax-semantics interface. In Wayles Browne, Adam Cooper, Alison Fisher, Esra Kesici, Nikola Predolac & Draga Zec (eds.), *Formal approaches to Slavic linguistics 18: The Cornell meeting*, 226–240. Ann Arbor, MI: Michigan Slavic Publications.
- Kagan, Olga & Asya Pereltsvaig. 2011b. Syntax and semantics of bare NPs: Objects of intensive reflexive verbs in Russian. In Olivier Bonami & Patricia Cabredo Hofherr (eds.), *Empirical issues in syntax and semantics*, vol. 8, 221–238.

References

- Kallmeyer, Laura & Rainer Osswald. 2012. A frame-based semantics of the Dative alternation in lexicalized tree adjoining grammars. Submitted to *Empirical Issues in Syntax and Semantics* 9.
- Kallmeyer, Laura & Rainer Osswald. 2013. Syntax-driven semantic frame composition in lexicalized tree adjoining grammars. *Journal of Language Modelling* 1(2). 267–330.
- Kallmeyer, Laura, Rainer Osswald & Sylvain Pogodalla. 2015. Progression and iteration in event semantics – An LTAG analysis using hybrid logic and frame semantics. In *Colloque de syntaxe et sémantique à Paris (CSSP 2015)*.
- Kallmeyer, Laura & Maribel Romero. 2008. Scope and situation binding in LTAG using semantic unification. *Research on Language and Computation* 6(1). 3–52.
- Karcevski, Serge. 1927. *Système du verbe russe*. Paris: Imprimerie “Legiografie”.
- Karttunen, Lauri. 1973. Presuppositions of compound sentences. *Linguistic Inquiry* 4. 167–193.
- Kearns, Kate. 2007. Telic senses of deadjectival verbs. *Lingua* 117. 26–66.
- Kennedy, Christopher. 1999. *Projecting the adjective: The syntax and semantics of gradability and comparison*. New York: Garland.
- Kennedy, Christopher. 2001. Polar opposition and the ontology of ‘degrees’. *Linguistics and Philosophy* 24. 33–70.
- Kennedy, Christopher. 2007. Vagueness and grammar: The semantics of relative and absolute gradable predicates. *Linguistics and Philosophy* 30. 1–45.
- Kennedy, Christopher. 2012. The composition of incremental change. In V. Demonte & L. McNally (eds.), *Telicity, change, state: A cross-categorical view of event structure*, 103–121. Oxford: Oxford University Press.
- Kennedy, Christopher & Beth Levin. 2002. Telicity corresponds to degree of change. Northwestern University and Stanford University.
- Kennedy, Christopher & Beth Levin. 2008. Measure of change: The adjectival core of degree achievements. In Louise McNally & Christopher Kennedy (eds.), *Adjectives and adverbs: Syntax, semantics, and discourse*, 156–182. Oxford: Oxford University Press.
- Kennedy, Christopher & Louise McNally. 2005. Scale structure, degree modification, and the semantics of gradable predicates. *Language* 81(2). 345–381.
- Kiparsky, Paul. 1983. Word-formation and the lexicon. In *Proceedings of the 1982 mid-America linguistics conference*, vol. 3, 22.
- Klein, Ewan. 1980. A semantics for positive and comparative adjectives. *Linguistics and Philosophy* 4. 1–45.
- Krifka, Manfred. 1989. *Nominalreferenz und Zeitkonstitution. Zur Semantik von Massentermen, Individualtermen, Aspektklassen*. Germany, Munich: Wilhelm Fink Verlag Munchen.

- Krifka, Manfred. 1992. Thematic relations as links between nominal reference and temporal constitution. In Ivan Sag & Anna Szabolcsi (eds.), *Lexical matters*, 29–53. Stanford: CSLI Publications.
- Kroch, Anthony. 1989. Asymmetries in long-distance extraction in a Tree-Adjoining Grammar. In Baltin & Kroch (eds.), *Alternative conceptions of phrase structure*. University of Chicago: Chicago Press.
- Krongauz, Maksim A. 1997. Opyt slovarnogo opisanija pristavki *ot-* [Experience of dictionary description of the prefix *ot-*]. In *Glagol'naja prefiksacija v rusckomazykye, collection of articles*, 62–86. Moscow: Russkije slovni.
- Krongauz, Maksim A. 1998. *Pristavki i glagoly v rusckomazykye: Semanticheskaja grammatika [Prefixes and verbs in Russian language: A semantics grammar]*. Moscow: Jazyki rusckoj kultury.
- Lascarides, Alex & Nicholas Asher. 1993. Temporal interpretation, discourse relations and commonsense entailment. *Linguistics and Philosophy* 16(5). 437–493.
- Levin, Beth & Malka Rappaport Hovav. 2010. Lexicalized scales and verbs of scalar change. Paper presented at the 46th Annual Meeting of the Chicago Linguistics Society, April 8–10, 2010.
- Lichte, Timm & Simon Petitjean. 2015. Implementing semantic frames as typed feature structures with XMG. *Journal of Language Modelling* 3(1). 185–228.
- Löbner, Sebastian. 2014. Evidence for frames from human language. In Thomas Gamerschlag, Doris Gerland, Rainer Osswald & Wiebke Petersen (eds.), *Frames and concept types (Studies in Linguistics and Philosophy 94)*, 23–67. Dordrecht: Springer.
- Lopatin, Vladimir V. 1997. *Rusckaja slovoobrazovatel'naja morfemika [Russian derivational morphology]*. Moscow: Nauka.
- Maslov, Jurij S. 1958. *Rol' tak nazyvajemoj perfektivacii i imperfektivacii v processe vozniknovenija slavjanskogo vida [The role of so-called perfectivization and imperfectivization in the process of emergence of the Slavic aspect]*. Moscow: Izdatel'stvo Akademii nauk SSSR.
- Maslov, Jurij S. 1965. Systema osnovnyx ponjatij i terminov slavjanskoj aspektologii [The system of core notions and terminology in Slavic aspectology]. In *Voprosy obščego jazykoznanija*, 53–80. Leningrad: LGU.
- Maslov, Jurij S. 2004. *Izbrannye trudy: Aspektologija. Obščee jazykoznanie*. Moscow: Jazyki slavjanskoj kultury.
- Mazon, André. 1908. *Morphologie des aspects du verbe russe*. Paris: H. Champion.
- Mazon, André. 1928. Quelques observations sur les “studie o česckém vidu slovesném” de Fr. Trávniček. *Slavia* 7. 819–826.

References

- McNally, Louise. 2011. The relative role of property type and scale structure in explaining the behavior of gradable adjectives. In Rick Nouwen, Robert van Rooij, Uli Sauerland & Hans-Christian Schmitz (eds.), *Vagueness in communication: Lecture notes in artificial intelligence, Folli*, 151–168. Heidelberg: Springer.
- Meillet, Antoine. 1902. *Études sur l'étymologie & le vocabulaire du vieux slave*. Vol. 1. Paris: Bibl. de l'École des Hautes Études, Sciences historiques et philologiques.
- Merrill, Peter. 1985. Universal quantification and aspect in Russian. In Michael Flier & Richard Brecht (eds.), *Issues in Russian morphosyntax*, 58–72. Slavica Pub.
- Gerdes, Kim, Tilmann Reuther & Leo Wanner (eds.). 2007. *Imperfectivization in Russian*. München - Wien: Gesellschaft zur Förderung slawistischer Studien. 20–24.
- Neset, Tore. 2008. Path and manner: An image-schematic approach to Russian verbs of motion. *Scando-Slavica* 54(1). 135–158.
- Ožegov, Sergej I. 1990. *Slovar' russkogo jazyka [Russian dictionary]*. Moscow: Russian Language Publishing House.
- Ožegov, Sergej I. & Natalja Ju. Švedova. 1992. *Tolkovyj slovar' russkogo jazyka. [Explanatory dictionary of the Russian language.]* Moscow: Izdatel'stvo "Az".
- Ožegov, Sergej I. & Natalja Ju. Švedova. 2001. *Slovar' russkogo jazyka [Russian dictionary]*. Moscow: Russkij jazyk.
- Padučeva, Elena V. 1996. *Semantičeskie issledovanija: Semantika vremeni i vida v ruskom jazyke; Semantika narrativa [Semantic studies: Semantics of tense and aspect in Russian; Semantics of the narrative]*. Moscow: Škola "Jazyki Russkoj Kultury".
- Padučeva, Elena V. 2004. O semantičeskom invariante vidovogo značenija glagola v ruskom jazyke [About the semantic invariant of the verbal aspect meaning in Russian]. *Russkij jazyk v naučnom osveščennii* 2(8). 5–16.
- Padučeva, Elena V. 2011. Prezumpcija [Presupposition]. Proekt korpusnogo opisanija ruskoj grammatiki [A project of corpora-based description of Russian grammar]. <http://rusgram.ru>.
- Padučeva, Elena V. & Mati Pentus. 2008. Formal and informal semantics of telicity. In Susan Rothstein (ed.), *Crosslinguistic and theoretical approaches to the semantics of aspect*, 191–215. Amsterdam: John Benjamins.
- Partee, Barbara H., Emmon Bach & Angelika Kratzer. 1987. Quantification: A cross-linguistic investigation. NSF proposal, University of Massachusetts at Amherst, ms.

- Paslawska, Alla & Arnim von Stechow. 2003. Perfect readings in Russian. In Monika Rathert, Artemis Alexiadou & Arnim von Stechow (eds.), *Perfect explorations*, 307–362. Berlin: Mouton de Gruyter.
- Petersen, Wiebke. 2007. Representation of concepts as frames. In *The Baltic international yearbook of cognition, logic and communication*, vol. 2, 151–170.
- Petersen, Wiebke & Tanja Osswald. 2009. A formal interpretation of frame composition. In *Proceedings of the Second Conference on Concept Types and Frames*. To appear. Düsseldorf.
- Petitjean, Simon, Denys Duchier & Yannick Parmentier. 2016. XMG 2: Describing description languages. In *Logical aspects of computational linguistics 2016*.
- Piñón, Christopher. 2001. A problem of aspectual composition in Polish. In Gerhild Zybatow, Uwe Junghanns, Grit Mehlhorn & Luka Szucsich (eds.), *Current issues in formal Slavic linguistics*, 397–415. Frankfurt/Main: Lang.
- Piñón, Christopher. 2008. Aspectual composition with degrees. In Louise McNally & Christopher Kennedy (eds.), *Adjectives and adverbs: Syntax, semantics and discourse*, 183–219. Oxford, UK: Oxford University Press.
- Piñón, Christopher. 1995. *An ontology for event semantics*. Stanford University. (Doctoral dissertation).
- Piperski, Alexander. 2016. Between imperfective and perfective: Quantitative approaches to the study of Russian biaspectual verbs. Draft available at www.academia.edu/21426579.
- Plungyan, Vladimir A. 2001. Pristavka *pod-* v rusском jazyke: K opisaniju semantičeskoj seti [The prefix *pod-* in Russian: To the description of the semantic network]. *Moskovskij lingvističeskij žurnal* 5(1). 95–124.
- Pollard, Carl & Ivan A. Sag. 1994. *Head-driven phrase structure grammar* (Studies in Contemporary Linguistics). Chicago, London: The University of Chicago Press.
- Potts, Christopher. 2005. *The logic of conventional implicatures*. Vol. 7. Oxford: Oxford University Press.
- Ramchand, Gillian. 1997. *Aspect and predication*. Oxford: Clarendon Press.
- Ramchand, Gillian. 2004. Time and the event: The semantics of Russian prefixes. *Nordlyd* 32(2). 261–323.
- Rappaport Hovav, Malka. 2008. Lexicalized meaning and the internal temporal structure of events. In Susan Rothstein (ed.), *Crosslinguistic and theoretical approaches to the semantics of aspect*, 13–42. Amsterdam: John Benjamins.
- Rappaport Hovav, Malka. 2011. Lexicalized scales and scalar change in two domains. In *Paper presented at the workshop “Scalarity in verb-based constructions”*. Düsseldorf.

References

- Rassudova, Olga P. 1975. Aspectual meaning and aspectual context in the teaching of Russian verbal aspect. *Slavic and East European Journal* 19(2). 139–144.
- Regnéll, Carl G. 1944. *Über den Ursprung des slavischen verbalaspektes [About the origin of the Slavic verbal aspect]*. Reprinted in 1983. Lund: Harlan Ohlsons Boktrycke.
- Romanova, Eugenia. 2004. Superlexical versus lexical prefixes. *Nordlyd* 32(2). 255–278.
- Romanova, Eugenia. 2006. *Constructing perfectivity in Russian*. University of Tromsø. (Doctoral dissertation).
- Romoli, Jacopo. 2011. The presuppositions of soft triggers are not presuppositions. In A. Chereches N. Ashton & D. Lut (eds.), *Proceedings of Semantics and Linguistic Theory (SALT) 21*, 236–256. CLC Publications.
- Rosenthal, Dietmar E. & Margarita A. Telenkova. 1976. *Slovar'-spravočnik lingvističeskikh terminov [Dictionary of linguistic terms]*. 2nd. Moscow: Prosveščenie.
- Rothstein, Susan. 2004. *Structuring of events: A study in the semantics of lexical aspect*. Oxford: Blackwell.
- Rothstein, Susan. 2008a. Telicity, atomicity and the Vendler classification of verbs. In Susan Rothstein (ed.), *Crosslinguistic and theoretical approaches to the semantics of aspect*, 43–77. Amsterdam: John Benjamins.
- Rothstein, Susan (ed.). 2008b. *Theoretical and crosslinguistic approaches to the semantics of aspect*. Vol. 110. John Benjamins Publishing.
- Rotstein, Carmen & Yoad Winter. 2004. Total adjectives vs. partial adjectives: Scale structure and higher-order modifiers. *Natural Language Semantics* 12. 259–288.
- Vinogradov, Viktor V., Evgenia S. Istrina & Stepan G. Barxudarov (eds.). 1952. *Grammatika russkogo jazyka [Grammar of Russian language]*. Moscow: Izdatel'stvo AN SSSR.
- Šaxmatov, Aleksej A. 1941. *Očerk sovremennogo russkogo literaturnogo jazyka [A study of contemporary Russian literary language]*. Moscow: Gosudarstvennoe učebno-pedagogičeskoe izdatel'stvo Narkomprosa RSFSR.
- Schlenker, Philippe. 2008. Be articulate: A pragmatic theory of presupposition projection. *Theoretical Linguistics* 34(3). 157–212.
- Schoorlemmer, Maaïke. 1995. *Participial passive and aspect in Russian*. Utrecht: LEU.
- Šeljakin, Michail A. 1969. Funkcii i slovoobrazovatel'nye svjazi načinatel'nyx prstavok v russkom jazyke [Functions and derivational relations of inchoative prefixes in Russian]. In *Leksichesko-grammatičeskie problemy russkogo glagola*, 3–33. Novosibirsk.

- Shanker, Vijay K. & Aravind K. Joshi. 1988. Feature structures based Tree Adjoining Grammars. In *Proceedings of COLING*, 714–719. Budapest.
- Shannon, Benny. 1976. On the two kinds of presuppositions in natural language. *Foundations of Language* 14. 247–249.
- Skott, Staffan. 1979. On biaspectual verbs in Russian. In Thore Pettersson (ed.), *Aspectology*, 17–33. Stockholm: Almqvist & Wiksell.
- Součková, Kateřina. 2004. *Measure prefixes in Czech: Cumulative na- and delimitative po-*. University of Tromsø. (MA thesis).
- Stalnaker, Robert. 1973. Presuppositions. *Journal of Philosophical Logic* 2(4). 447–457.
- Stilman, Leon. 1951. *Russian verbs of motion: Going, carrying, leading*. New York: Columbia University Press.
- Švedova, Natalja Ju. 1982. *Russkaja grammatika*. Vol. 1. Moscow: Nauka.
- Svenonius, Peter. 2004a. Slavic prefixes and morphology: An introduction to the Nordlyd volume. *Nordlyd* 32(2). 177–204.
- Svenonius, Peter. 2004b. Slavic prefixes inside and outside VP. *Nordlyd* 32(2). 205–253.
- Svenonius, Peter. 2012. Structural and featural distinctions between Germanic and Slavic prefixes. In *Stuttgart P-Workshop*.
- Talmy, Leonard. 2000. Vol. Toward a Cognitive Semantics. Cambridge, MA: MIT Press.
- Tatevosov, Sergei. 2007. Intermediate prefixes in Russian. In *Proceedings of the annual workshop on formal approaches to Slavic linguistics*, vol. 16.
- Tatevosov, Sergei. 2009. Množestvennaja prefiksacija i anatomija ruskogo glagola [Multiple prefixation and the anatomy of Russian verb]. In Xenia Kisseleva, Vladimir Plungian, Ekaterina Rakhilina & Sergei Tatevosov (eds.), *Korpusnye issledovanija po rusškoj grammatike [Corpus-based studies in the grammar of Russian]*, 92–156. Moscow: Probel.
- Tatevosov, Sergei. 2011. Severing perfectivity from the verb. *Scando-Slavica* 57. 216–244.
- Tatevosov, Sergei. 2013a. Grammatika glagola i dialektnoe var'irovanie [Verbal grammar and dialectal variation]. In *Kompjutersnaja lingvistika i intelektual'nye texnologii: Po materialam ežegodnoj meždunarodnoj konferencii "dialog"* (12), 19.
- Tatevosov, Sergei. 2013b. Množestvennaja prefiksacija i eë sledstvija (Zametki o fiziologii ruskogo glagola) [Multiple prefixation and its consequences (Notes on the physiology of Russian verb)]. *Voprosy jazykoznanija* 3. 42–89.
- Tenny, Carol. 1994. *Aspectual roles and the syntax-semantics interface*. Dordrecht: Kluwer Academic Publishers.

References

- Timberlake, Alan. 1982. Invariance and the syntax of Russian aspect. In Paul Hopper (ed.), *Tense-aspect: Between semantics and pragmatics*, 305–331. Amsterdam: John Benjamins.
- Timberlake, Alan. 2004. *A reference grammar of Russian*. Cambridge: Cambridge University Press.
- Titelbaum, Olga A. 1990. Prefixed Russian verbs of transportation. *Russian Linguistics* 14. 37–46.
- Tixonov, A. N. 1998. *Russkij glagol: Problemy teorii i leksikografirovanija [Russian verb: Theoretical and lexicographical problems]*. Moscow: Academia.
- Townsend, Charles Edward. 1975. *Russian word-formation*. Bloomington: Slavica Publishers.
- Txurruka, Isabel Gómez. 2003. The natural language conjunction *and*. *Linguistics and Philosophy* 26(3). 255–285.
- Ušakov, Dmitrij N. (ed.). 1935–1940. *Tolkovyj slovar' russkogo jazyka. [Explanatory dictionary of the Russian language.]*. Moscow: Izdatel'stvo Akademii Nauk SSSR.
- van Rooy, Robert. 2004. Signalling games select Horn strategies. *Linguistics and Philosophy* 27(4). 493–527.
- van Hout, Angeliek. 2008. Acquiring telicity cross-linguistically: On the acquisition of telicity entailments associated with transitivity. In Melissa Bowerman & Penelope Brown (eds.), *Crosslinguistic perspectives on argument structure: Implications for learnability*, 255–278. Hillsdale: Lawrence Erlbaum.
- Vendler, Zenon. 1967. *Linguistics and Philosophy*. Ithaca: Cornell University Press.
- Verkuyl, Henk. 1972. *On the compositional nature of the aspects* (Foundations of Language, Supplementary Series 15). Dordrecht, Holland: D. Reidel Publishing Co.
- Verkuyl, Henk. 1995. *Aspectuality and event structure*. Course material. ESSLI 95. Barcelona.
- Vinogradov, Viktor V. 1972. *Russkij jazyk [Russian language]*. Moscow: Vysšaja škola.
- Vondrák, Wenzel. 1908. *Vergleichende slavische Grammatik*. Vol. 2. Göttingen: Göttingen Sammlung indogermanischer Grammatiken.
- Wade, Terence. 1992. *A comprehensive Russian grammar*. Oxford: Blackwell.
- Wierzbicka, Anna. 1967. On the semantics of the verbal aspect in Polish. *To Honor Roman Jakobson* 3. 2231–2249.
- Zaliznjak, Andrej A. 1977. *Grammatičeskij slovar' russkogo jazyka [Grammatical dictionary of Russian]*. Moscow: Russkij jazyk.

- Zaliznjak, Andrej A. 2003. Aktionsart [Sposob dejstvija]. Ėncyclopedia “Krugosvet”. http://www.krugosvet.ru/enc/gumanitarnye_nauki/lingvistika/SPOSOB_DESTVIYA.html.
- Zaliznjak, Anna A. 1995. Opyt modelirovanija semanitiki pristavochnyx glagolov v russkom jazyke [Experience of modelling the semantics of prefixed verbs in Russian]. *Russian Linguistics* 19. 143–185.
- Zaliznjak, Anna A. & Alexej D. Šmelëv. 2000. *Vvedenie v russkuju aspektologiju* [Introduction to Russian aspectology]. Moscow: Jazyki russkoj kultury.
- Zemskaja, Elena A. 1955. Tipy odnovidovyx pristavočnyx glagolov v sovremennom russkom jazyke [Types of aspectually non-paired prefixed verbs in contemporary Russian]. In Natalja Ju. Švedova (ed.), *Issledovanija po grammatike literaturnogo russkogo jazyka*, 5–41. Moscow: Izdatel'stvo Akademii Nauk SSSR.
- Zinova, Yulia. 2012. *Russian Verbal Prefixation Puzzles*. Handout of a talk given at the graduate research seminar at Heinrich-Heine University. Düsseldorf. <https://www.academia.edu/8359697>.
- Zinova, Yulia. 2014. Locative alternation in English and Russian: A frame semantic analysis. In Margot Colinet, Sophia Katrenko & Rasmus K. Rendsvig (eds.), *Pristine perspectives on logic, language, and computation*, 49–68. Berlin: Springer.
- Zinova, Yulia & Hana Filip. 2013. Biaspectual Verbs: A Marginal Category? In Martin Aher, Daniel Hole, Emil Jeřábek & Clemens Kupke (eds.), *10th International Tbilisi Symposium on Logic, Language, and Computation*, 310–332. Paper presented at TbiLLC 2013. Gudauri, Georgia: Springer.
- Zinova, Yulia & Hana Filip. 2014. Meaning components in the constitution of the Russian verbs: Presuppositions or implicatures? In *Semantics and linguistic theory*, vol. 24, 353–372.
- Zinova, Yulia & Hana Filip. 2015a. Scalar implicatures of Russian verbs. In M. Szabel-Keck, R. Burns & D. Kavitskaya (eds.), *Formal approaches to Slavic linguistics. The first Berkley meeting 2014*. Vol. 23, 382–401. Ann Arbor: Michigan Slavic Publications.
- Zinova, Yulia & Hana Filip. 2015b. The role of derivational history in aspect determination. In Gerhild Zybatow, Petr Biskup, Marcel Guhl & Claudia Hurtig (eds.), *Slavic grammar from a formal perspective: The 10th anniversary FDSL conference, Leipzig 2013*. Frankfurt: Peter Lang.
- Zinova, Yulia & Laura Kallmeyer. 2012. A frame-based semantics of locative alternation in LTAG. In *Proceedings of the 11th International Workshop on TAG and Related Formalisms*.

References

- Zinova, Yulia & Rainer Osswald. 2016. Prefixation of Russian verbs of motion: A frame-based analysis. Manuscript, Heinrich Heine University Düsseldorf.
- Zucchi, Sandro. 1999. Incomplete events, intensionality and imperfective aspect. *Natural Language Semantics* 7(2). 179–215.

Name index

- Abeillé, Anne, 223, 224, 226
Alexeyenko, Sascha, 106
Altshuler, Daniel, 34
Anderson, Cori, 13, 14
Arsenijević, Boban, 107
Asher, Nicholas, 28, 32
Avilova, Natal'ja S., 10, 13, 103, 104
- Babko-Malaya, Olga, 78, 79, 83–85
Bach, Emmon, 104, 234
Barsalou, Lawrence W., 5, 229, 230
Beaver, David I., 198
Beavers, John, 167
Benz, Anton, 219
Binnick, Robert I., 103
Blutner, Reinhard, 199, 219
Bochnak, M. Ryan, 108
Bogusławski, Andrzej, 103
Bondarko, Aleksandr, 10
Borer, Hagit, 18, 72, 73
Borik, Olga, 14, 23, 24, 38, 78
Braginsky, Pavel, 82, 111, 112, 117,
118, 121–125, 140, 235
- Candito, Marie-Hélène, 228, 291
Čang, Pej-Či, 13
Caudal, Patrick, 107
Černyšëv, Vasilij I., 103
Čertkova, Marina Ju., 13
Chemla, Emmanuel, 4, 191, 208–214
Chierchia, Gennaro, 198
- Comrie, Bernard, 10
Crabbé, Benoît, 228, 291
Cubberly, Paul V., 38
- Demjjanow, Assinja, 166, 167, 170,
172, 264
Di Sciullo, Anne M., 78
Dickey, Stephen, 10
Dočekal, Mojmir, 192, 196, 197
Duchier, Denys, 228
Ducrot, Oswald, 209
- Efremova, Tatiana F., 136, 142
Evgen'eva, Anastasia P., 38, 103
- Filip, Hana, 2, 4, 9, 28, 30, 36, 72,
104, 105, 107, 108, 129, 140,
141, 143, 191, 195, 197, 208,
210, 244, 258
Fillmore, Charles J., 189, 223, 229
Folli, Raffaella, 151
Forsyth, James, 10, 77
Frank, Michael C., 221
Frank, Robert, 223, 226, 228
Franke, Michael, 221
- Galton, Herbert, 13
Gardent, Claire, 233
Garey, Howard B., 107
Gehrke, Berit, 78
Giorgi, Alessandra, 196
Gladney, Frank Y., 13

Name index

- Golovin, Boris N., 103, 104
Goodman, Noah D., 221
Grice, Herbert P., 198, 207, 209
Grønn, Atle, 4, 46, 191, 194, 198, 200, 205
Gvozdev, Aleksandr N., 66
Gyarmathy, Zsófia, 125

Harley, Heidi, 151
Hay, Jen, 107
Heim, Irene, 106, 203, 208
Horn, Laurence R., 137, 209

Isačenko, Alexander V., 3, 10, 13, 66, 68, 77, 78, 111, 144, 147

Jäger, Gerhard, 221
Jakobson, Roman, 10, 198
Janda, Laura A., 10, 11, 13, 39, 41, 66, 68, 69, 91, 156, 214
Janssen, Maarten, 14, 38
Jászay, László, 13
Jespersen, Otto, 34
Joshi, Aravind K., 189, 223–225

Kagan, Olga, 2–4, 82, 85, 86, 93, 104, 106, 129, 131, 141, 143, 144, 155, 156, 159–162, 169, 170, 172, 174–177, 179, 185, 188, 189, 191, 199, 200, 235, 244, 258, 264, 283
Kallmeyer, Laura, 5, 189, 223, 229–233, 244, 273
Karcevski, Serge, 36
Karttunen, Lauri, 203
Kearns, Kate, 107
Kennedy, Christopher, 106–108, 110, 131, 143, 156
Kiparsky, Paul, 145
Klein, Ewan, 106
Krifka, Manfred, 103, 107
Kroch, Anthony, 228
Krongauz, Maksim A., 63, 103
Kučerová, Ivona, 192, 196, 197

Lascarides, Alex, 28
Levin, Beth, 106–108, 110, 131, 143, 156
Lichte, Timm, 225, 291
Löbner, Sebastian, 5, 229
Lopatin, Vladimir V., 103, 104

Maslov, Jurij S., 10, 26, 111, 198
Mattausch, Jason, 219
Mazon, André, 66, 70
McConnell-Ginet, Sally, 198
McNally, Louise, 106, 107
Meillet, Antoine, 66
Merrill, Peter, 104
Mikaeljan, Irina, 26–28

Nesset, Tore, 66, 91
Nicolas, David, 107

Osswald, Rainer, 2, 5, 46, 64, 85, 111, 117, 139, 189, 223, 229–232, 235, 237, 243, 273
Osswald, Tanja, 229
Ožegov, Sergej I., 14, 38

Padučeva, Elena V., 4, 10, 29, 72, 112–115, 118, 192–194, 196, 197
Partee, Barbara H., 104
Paslawska, Alla, 46
Pentus, Mati, 72
Pereltsvaig, Asya, 129
Petersen, Wiebke, 229
Petitjean, Simon, 7, 223, 291
Pianesi, Fabio, 196

- Piñón, Christopher, 46, 103, 107
Piperski, Alexander, 28
Plungyan, Vladimir A., 103
Pollard, Carl, 234
Potts, Christopher, 198

Rambow, Owen, 223, 224
Ramchand, Gillian, 3, 18, 20, 34, 46,
77, 78, 80, 81, 83, 84, 86, 87,
107, 195
Rappaport Hovav, Malka, 107, 108
Rassudova, Olga P., 104
Regnéll, Carl G., 66, 70, 71
Romanova, Eugenia, 3, 4, 18, 20, 25,
34, 46, 66, 70, 77–81, 83, 84,
192–197
Romero, Maribel, 233
Romoli, Jacopo, 191
Rosenthal, Dietmar E., 11, 13
Rothstein, Susan, 71, 73, 75, 104, 107,
125, 195, 197
Rotstein, Carmen, 106

Sag, Ivan A., 234
Šaxmatov, Aleksej A., 66
Schabes, Yves, 189, 223, 224
Schlenker, Philippe, 191, 208
Schoorlemmer, Maaïke, 22, 25, 78,
79
Šeljakin, Michail A., 111, 112
Shanker, Vijay K., 225
Shannon, Benny, 203
Skott, Staffan, 13
Slabakova, Roumyana, 78
Šmelëv, Alexej D., 13, 66
Součková, Kateřina, 129, 140, 141,
143
Stalnaker, Robert, 203
Stilman, Leon, 64

Stuhlmüller, Andreas, 221
Švedova, Natalja Ju., 2, 3, 13, 14, 37,
38, 50, 52, 63, 66, 71, 79,
103, 128, 131, 139, 140, 142,
144, 145, 148, 153, 154, 157,
173, 174
Svenonius, Peter, 1–3, 18, 20, 21, 34,
46, 77–81, 83–87, 91, 123,
125, 134–136, 140

Talmy, Leonard, 10
Tatevosov, Sergei, iv, 1–3, 7, 18–22,
34, 46, 77, 83–88, 91–97,
99–101, 104, 121, 123, 125,
131, 132, 134, 144, 145, 166,
181, 186, 292, 314–319, 322,
348
Telenkova, Margarita A., 11, 13
Tenny, Carol, 105
Timberlake, Alan, 10, 13
Titelbaum, Olga A., 64, 66
Tixonov, A. N., 103, 104
Townsend, Charles Edward, 66, 77
Txurruka, Isabel Gómez, 32

Ušakov, Dmitrij N., 14, 142, 215, 217

Van Hout, Angeliek, 72
van Rooy, Robert, 219
Vendler, Zeno, 234
Verkuyl, Henk, 46, 107
Vieu, Laure, 32
Vinogradov, Viktor V., 66, 103
Von Stechow, Arnim, 46
Vondrák, Wenzel, 66

Wade, Terence, 66
Wierzbicka, Anna, 104, 107
Winter, Yoad, 106

Name index

Zaloznjak, Andrej A., 14, 99
Zaloznjak, Anna A., 13, 66, 111
Zemskaja, Elena A., 111
Zinova, Yulia, 2, 4, 9, 22, 28, 30, 36,
46, 64, 85, 111, 117, 139, 191,
208, 210, 235, 237, 243, 244
Zucchi, Sandro, 103

Subject index

- accomplishment, 196, 203, 205, 206
- adjunction, 224–226, 228, 294
- argument structure, 82, 87, 89, 90, 229, 321
- aspect, 10
 - aspectless verb, 72
 - test, 2, 9, 10, 15, 18, 22, 24, 25, 28, 31, 72
- aspectual change, 12
 - imperfectivisation, 18, 40, 52, 70, 71, 78, 80, 82, 85–87, 97, 123, 134, 136, 146, 148, 149, 184–187
- aspectual pair
 - aspectual pair, 11, 12, 25–28, 38, 72, 95, 214, 215
- aspectual restriction, 133, 134
- atemporal verbs, 112–115, 118
- attribute-value description, 232
- auxiliary tree, 224

- backgrounded information, 193
- base label, 231
- biaspectual verb, 2, 9, 10, 12–14, 17, 22, 25, 27, 28, 30, 31, 35, 43, 44, 46, 53, 56, 58–63, 75, 95, 105, 174, 181, 322
- bounded event, 73, 247, 251, 253, 255–261, 263, 266, 268–271, 273–276, 278–281, 283, 287–289

- cluster
 - cluster model, 11, 68
 - verbal cluster, 41
- coerced into, 124, 279, 283
- common ground, 203
- communicative status, 193
- comparison class, 106, 107
- competition, 44, 143, 175, 177, 180, 185, 191, 207, 209, 214, 215, 221, 321
- conditional, 201
- conjunction, 16, 31–33, 230, 235
- context, 2, 3, 7, 13, 15, 16, 27, 30–35, 43, 48, 55, 73, 93, 98, 108, 110, 116, 119, 125, 126, 131, 136, 137, 143, 146, 149, 156, 164, 168, 170, 172, 179, 188, 209, 211, 267, 278
- culmination, 192, 205

- degree achievement, 107, 131
- derivational base, 4, 37, 78, 84, 85, 89, 90, 96, 97, 112, 118, 122, 124–131, 134–136, 138–140, 144–146, 149, 150, 153–155, 164, 166, 168, 170, 173, 183, 185–188, 229, 235–237, 242, 243, 258, 264, 277, 279, 284, 288, 300, 303, 312
- derivational chain, 36–38, 40, 42–44, 47, 49, 55, 56, 60, 69, 75, 122, 132, 145, 151

Subject index

- derivational graph, 9, 36, 38, 40–42,
45, 46, 75, 322
- derived tree, 226
- dimension constructor, 229, 249,
254, 261, 264, 295, 309, 322
- discourse , 29, 31
- Background relation, 30–32
 - Cause relation, 31
 - coordinating relation, 30, 32
 - Narration relation, 32, 33, 75
- discourse relation, 32
- distributive, 19, 46, 59, 79, 81, 83, 84,
87, 94, 95, 97, 98, 105, 139,
142, 144, 147–151, 153, 163,
164, 166–168, 170–173, 187,
259, 261, 264, 268, 269, 292,
314, 316, 318
- economy principle, 122
- elementary tree, 224, 226, 228, 233,
238, 293
- embedded event, 166
- empty prefix, 90
- entailment, 205
- frame semantics, 223, 232, 233, 237,
243, 244, 252, 258, 259, 262,
264, 265, 268, 272, 277, 286,
311
- functional category, 79
- gradable adjective, 106
- homograph, 68
- homonymy, 103
- imperfective aspect, 1, 2, 10, 13,
23–28, 30, 31, 38, 48, 55, 59,
63, 64, 67, 68, 70, 71, 75, 87,
95, 97, 121, 123, 124, 131, 133,
137, 192, 196, 200, 202, 206,
208, 283, 318, 319
- habitual intepretation, 26, 27,
65, 86, 109, 123, 146, 152,
252, 303
- iterative interpretation, 16, 252,
264
- progressive interpretation, 2,
15, 23, 48, 51, 57, 60, 86,
123–125, 128, 137, 149, 187,
303
- secondary imperfective, 43, 55,
57, 69–71, 75, 79, 81, 83,
85–87, 92–94, 99, 100, 105,
124, 126–128, 134–138, 149,
150, 163, 170, 181, 183, 186,
187, 197, 200, 207, 208, 252,
303, 318
- imperfective paradox, 74
- implicatures, 4, 191, 200, 201, 205,
208–211, 213, 214, 222
- incremental change, 107
- incremental theme, 74, 108
- inference, 63, 142, 143, 175–177, 184,
194–198, 200, 201, 204, 205,
207, 209–211, 214, 222
- information structure, 13, 115,
206–208, 210
- intermediate prefixes, 3, 19, 20,
92–94
- internal argument, 107, 140
- lexical anchor, 228, 292–294, 309,
311
- lexical head, 79
- lexical prefixes, 1, 7, 18, 20, 44, 70,
75, 77–82, 84, 87, 89, 91, 92,
97, 101, 118, 215, 224, 262,
297, 300

- loaned verbs, 12–14, 46, 47, 54, 56,
58, 63, 64, 75, 322
- LTAG, 189, 223, 228, 232
- Maslov criterion, 26–28
- metagrammar, 223, 228, 229, 231,
236, 248, 281, 290–292, 294,
297, 300, 322
- Monotonicity Hypothesis, 145
- morphological complexity, 122,
132–134, 150, 163, 180, 290
- morphological distance, 55
- morphological operation, 37, 50
non-perfectivising prefixation,
50, 56, 63, 64, 66, 70
prefixation, 1–4, 7, 9–12, 14, 18,
20, 22, 36–38, 42–44, 46,
47, 49, 50, 53, 58–60,
63–68, 70, 72, 75–78, 86, 92,
95, 97–99, 103, 104, 111, 118,
131, 132, 134, 144, 147, 148,
150, 167, 170, 172, 173, 188,
191, 214, 222, 223, 240, 254,
286, 292, 303, 317, 321
productive pattern, 14
stress shift, 11, 68, 69
suffixation, 1, 11, 50, 52, 149,
303, 308
suppletion, 11
thematic vowel alternation, 11
- motion verb, 64, 70, 78, 85, 122, 139,
237, 241, 243, 258, 259, 265,
272, 286
determinate verb, 64–70
indeterminate verb, 64–70
- narrative sequence, 25–27, 149
- negation, 192, 198, 201, 206–210
- neutral perfective, 12, 138, 214, 215,
221
- nominal dimension, 272, 308
- noun phrase, 74, 249
accusative noun phrase, 88
genitive noun phrase, 88
- one delimitation per event, 105
- Optimality Theory, 199, 219, 221,
222
- participle
past passive participle, 25
present active participle, 24
present participle, 23, 24, 48, 51,
57
- perfective aspect, 1, 2, 4, 10, 22–25,
28, 29, 31, 34, 38, 72, 73, 75,
95, 99, 104, 122, 131–133,
143, 145, 146, 148, 166, 177,
182, 191–198, 200, 219, 222
- perfectivization, 63
- phasal verb, 23, 48, 57
- phonological restriction, 54
- polysemy, 3, 4, 103, 130, 172
- postfix, 37, 40, 129
- pragmatics, 44, 132, 133, 145, 148,
154, 223
- prefix
de-, 62, 63
dez-, 62, 63
dis-, 62, 63, 322
do-, 1, 4, 5, 15, 19–22, 40, 41,
43–45, 50, 53, 55, 56, 83, 84,
92, 105, 173–177, 179–186,
188, 189, 191, 197, 199–202,
204–208, 210–214, 218, 222,
283–286, 288, 290, 292,
303, 318, 321, 322, 325
iz-, 83, 84
na-, 4, 12, 19, 20, 39, 79, 83, 84,
87, 95, 99, 100, 104, 105,

Subject index

- 128–138, 140, 142, 188, 214,
215, 244–247, 252, 254, 269,
270, 288, 290, 321, 324
- ot-*, 54, 79, 83, 84
- pere-*, 2, 4, 19, 20, 47, 49, 50, 55,
56, 58–63, 75, 79, 81, 83–85,
92, 95, 97, 98, 105, 122, 144,
154–158, 160–173, 179, 182,
185, 187–189, 191, 199–202,
204–208, 211–214, 218, 222,
246, 264, 265, 268–270, 272,
275, 277–281, 283, 284, 286,
288, 290, 292, 300, 303, 304,
314, 315, 318, 321, 324, 325
- po-*, 4, 19, 20, 37, 67, 73, 79, 80,
83, 84, 87, 94–97, 105, 118,
122, 129, 139–150, 152–154,
161, 164, 165, 179, 180, 188,
214, 215, 218, 219, 221, 258,
259, 261, 262, 268, 288, 290,
292, 300, 301, 314, 316, 317,
321, 324
- pod-*, 19, 53, 56, 83, 84, 93, 221,
322
- pri-*, 64, 66, 67, 70, 83, 84, 96
- pro-*, 66–69, 83–85
- ras-*, 91
- raz-*, 78, 91
- re-*, 14, 62, 63, 322
- s-*, 12, 90, 130
- so-*, 62, 63
- u-*, 91
- vy-*, 35, 45
- za-*, 16, 19, 20, 72, 78, 79, 81–84,
86, 87, 105, 111, 112, 115–128,
134, 135, 138, 140, 186, 188,
215, 218, 235, 236, 238–244,
288, 295, 321, 323
- prefix classification , 3, 19, 92, 94
- prefix interpretation
- attenuative, 19, 79, 83, 93, 94,
96, 140
- comparison, 7, 106, 155–157,
159, 161, 167, 169–171, 234,
277, 314, 316, 317
- completive, 14, 19, 20, 22, 43,
44, 50, 55, 83, 84, 92, 94,
105, 191, 197, 199–201, 204,
205, 207, 208, 210, 213, 283
- cumulative, 19, 20, 39, 79, 83,
84, 87, 94, 95, 99, 104, 109,
121, 129–138, 142, 165, 175,
244
- delimitative, 19, 20, 83, 84,
94–97, 105, 118, 129,
139–142, 144–148, 150, 151,
153, 174, 292, 300
- distributive , 20, 81
- excessive, 79, 83, 105, 155, 156,
169–171, 214–216, 246, 264,
275
- inceptive, 19, 20, 82–84, 86, 87,
94, 105, 111, 112, 115–127,
134, 135, 142, 235, 236, 239,
241
- perdurative, 83, 155
- repetitive, 19, 47, 50, 55, 56,
58–63, 83, 84, 92, 94, 98,
146, 147, 154, 155, 160,
162–164, 166, 167, 169–173,
182, 187–189, 191, 207, 292,
300, 303, 318
- resultative, 79, 91, 111, 112,
116–121, 125–127, 131, 137,
138, 140, 142, 153, 193, 194,
215, 244
- spatial, 79, 85, 111, 112, 117, 121,
131, 135, 136, 155, 156, 169,

- 173, 230, 264, 286
- terminative, 54, 79, 83, 84,
 - 174–177, 180, 183–185, 197
- prefix stacking, 3, 4, 82, 94, 104, 106,
 - 174, 187, 252, 321
- prefixed noun, 50, 56
- preparatory phase, 119, 124, 125, 128,
 - 161, 162, 169, 172, 173, 188,
 - 234, 264, 279, 282, 288
- presupposition, 4, 77, 160, 172,
 - 191–205, 208, 209, 211, 214
 - cancellation, 202
 - presupposition trigger, 201,
 - 210–213
- presuppositional approach, 191
- projection properties, 208, 214
- punctual event, 31, 86
- quantisation, 103
- restrictions on prefixation, 5, 7, 40,
 - 99, 101, 105, 106, 218, 233,
 - 234, 245, 290, 322
- result state, 140, 160, 164, 196
- scalar approach, 4, 104, 107, 148
- scalar expression, 104
- scalar implicatures, *see* implicatures
- scale, 7, 75, 106, 108–110, 118, 121,
 - 127, 129, 153, 157, 160, 168,
 - 170, 172, 173, 177, 179, 188,
 - 189, 215, 219, 234, 235, 237,
 - 239, 241, 246, 258, 259
- amount scale, 249, 252, 254,
 - 255, 290
- cardinality scale, 164, 259, 261,
 - 314
- complex type, 259
- degree on a scale, 104, 141, 146
- dimension, 236, 237, 239, 240,
 - 243, 245–247, 252, 254, 258,
 - 259, 261, 264, 265, 267–269,
 - 272, 273, 275, 277, 279,
 - 282–284, 286, 288, 297
- distance, 66, 85, 140, 228
- duration, 106, 109, 111, 113, 125,
 - 128, 140, 166, 169, 180, 218,
 - 221, 240, 241, 275, 278, 282,
 - 283
- expectation value, 104, 131, 140,
 - 143
- marked point, 157, 234, 270, 271,
 - 273, 274, 276
- maximum value, 110, 145, 148,
 - 154, 165, 166, 174, 179, 186,
 - 245, 247, 267, 277
- measure of change scale,
 - 108–110, 148, 165, 168, 175,
 - 186
- minimum value, 174, 246, 281,
 - 286
- natural endpoint, 160–162
- non-binary, 167, 168, 172
- path scale, 179, 237, 265
- proper scale, 108–110, 165, 166,
 - 264
- property , 140, 242, 244, 281,
 - 282, 284, 287, 288
- standard value, 130, 138, 156,
 - 188, 214
- temperature scale, 248–250,
 - 259, 270, 290
- time scale, 112, 114, 118, 120–122,
 - 126, 127, 157, 159, 166, 179,
 - 180, 186–188, 215, 218, 219,
 - 235, 236, 264, 275
- totally closed, 234, 265, 266,
 - 284, 285, 289

Subject index

- totally open, 138, 179, 245
- underspecification, 110, 243
- upper closed, 110
- wetness scale, 130, 237
- semantic analysis, 2, 7, 291, 322
- semantic composition, 20, 37, 39, 101, 187, 229, 232, 320
- semelfactive, 10, 18, 195, 272
- speaker variation, 17, 22, 221, 248
- standard of comparison, 106, 107, 174, 179
- stem selection, 18, 78
- stress position, 69
- subevent, 109, 144, 165, 166, 168, 195, 196, 252
- substitution, 32, 225, 226, 228
- suffix
 - imperfective suffix, 1–3, 5, 7, 10, 14–16, 18, 20, 22, 40, 41, 43, 44, 46, 47, 49, 52, 54, 56, 57, 79, 81, 86, 92, 100, 106, 123, 127, 128, 132, 134, 136, 145, 148–150, 152, 185–188, 195, 197, 292, 303, 311, 314–318, 321, 322
 - ova*-, 12, 28, 49, 52, 54, 57, 62
- superlexical prefixes, 3, 18–20, 22, 25, 46, 70, 76–82, 84–87, 89–92, 94, 101, 111, 129, 144, 157, 185, 186, 321
- left periphery prefix, 19, 46, 87, 94, 144
- positionally limited prefixes, 19, 94
- selectionally limited prefixes, 19, 20, 22, 94, 95
- syncretic paradigm, 13
- syntactic account, 4, 18, 20, 34, 42, 70, 77, 79
- syntactic structure, 2, 18–20, 22, 36, 43, 70, 79–82, 94, 101, 123, 196, 291, 295, 297
- syntax-semantics interface, 233, 291
- telicity
 - telic verb, 29, 72, 188
 - telicity test, 16
- temporal argument, 107
- temporal extent, 31
- tense
 - future, 16, 48, 51, 57, 61
 - historical present, 10, 26, 27
 - past, 2, 10, 24–26, 30, 31, 33, 34, 54, 55, 64–66, 68–70
- time measure phrase, 74, 239
 - accusative time measure phrase, 72, 73, 239
 - prepositional time measure phrase, 16
- time specification
 - duration, 112
 - punctual, 112
- transitive verbs, 120, 215, 228
- type hierarchy, 231, 233, 234, 239, 293
- unification, 173, 226, 233, 240, 242, 249, 252, 254, 255, 259, 261, 262, 265, 267, 270
 - unification failure, 234, 240, 254
- uniform semantics, 103, 169
- universal inference, 209, 210, 213
- universal quantifier, 212, 214
- upper inclusion, 156, 169
- verbal dimension, 237, 240, 241, 243, 245, 246, 252, 254, 261, 262, 264, 283, 303

verbs

complex verbs, 2, 7, 14, 18, 22,
39, 75, 77, 79, 82, 105, 133,
187, 311, 317, 318, 322

unprefixed verbs, 70, 71, 78, 126,
135, 153, 207, 240

XMG, 7, 223, 252, 291–293, 297, 300,
303, 308, 311, 322

Russian verbal prefixation

This book addresses the complexity of Russian verbal prefixation system that has been extensively studied but yet not explained. Traditionally, different meanings have been investigated and listed in the dictionaries and grammars and more recently linguists attempted to unify various prefix usages under more general descriptions. The existent semantic approaches, however, do not aim to use semantic representations in order to account for the problems of prefix stacking and aspect determination. This task has been so far undertaken by syntactic approaches to prefixation, that divide verbal prefixes in classes and limit complex verb formation by restricting structural positions available for the members of each class. I show that these approaches have two major drawbacks: the implicit prediction of the non-existence of complex biaspectual verbs and the absence of uniformly accepted formal criteria for the underlying prefix classification. In this book the reader can find an implementable formal semantic approach to prefixation that covers five prefixes: *za-*, *na-*, *po-*, *pere-*, and *do-*. It is shown how to predict the existence, semantics, and aspect of a given complex verb with the help of the combination of an LTAG and frame semantics. The task of identifying the possible affix combinations is distributed between three modules: syntax, which is kept simple (only basic structural assumptions), frame semantics, which ensures that the constraints are respected, and pragmatics, which rules out some prefixed verbs and restricts the range of available interpretations. For the purpose of the evaluation of the theory, an implementation of the proposed analysis for a grammar fragment using a metagrammar description is provided. It is shown that the proposed analysis delivers more accurate and complete predictions with respect to the existence of complex verbs than the most precise syntactic account.

ISBN 978-3-96110-298-3



9 783961 102983