

Preparation and characterization of drug-loaded (meth)acrylic intraocular lenses

Dissertation zur Erlangung des akademischen Grades des

Doktors der Naturwissenschaften (Dr. rer. nat.)

eingereicht im Fachbereich Biologie, Chemie, Pharmazie

der Freien Universität Berlin

vorgelegt von

Marius Heck

aus Hamburg, Deutschland

Berlin, 2018

Die vorliegende Arbeit wurde von Januar 2015 bis September 2018 unter der
Leitung von
Prof. Dr. Roland Bodmeier im Institut für Pharmazeutische Technologie an der
Freien Universität Berlin angefertigt.

1. Gutachter:	Prof. Dr. Roland Bodmeier
2. Gutachter:	Prof. Dr. Philippe Maincent
Disputation am:	12. Oktober 2018

*Unless the Lord builds the house,
the builders labor in vain.
Unless the Lord watches over the city,
the guards stand watch in vain.*

*In vain you rise early and stay up late,
toiling for food to eat—
for he grants sleep to those he loves.*

*Psalm 127: 1 – 2
(The Bible)*

Acknowledgments

Thanks a lot to all, who helped me during this time and supported me to conduct this research and to write this thesis at the Freie Universität Berlin.

First, I would like to express my deepest thankfulness to my supervisor Prof. Dr. Roland Bodmeier who gave me this opportunity to study and work at this institute in his research group and for supporting me in my scientific development.

Additionally, I would like to thank Prof. Dr. Philippe Maincent for evaluating my thesis.

Apart from that, I am sincerely thankful to Kathrin, Marina, Miriam, Prutha, Luisa, Friederike, Marco, Rahul, Benjamin, Reza, and Rick for proofreading parts of my thesis and for their support in countless discussions.

Especially, I am grateful to Frau Ewest, Gabriela Karsubke and Stefan Walter for helping me in many situations, such as providing the necessary devices, mastering paperwork and repairing various equipment.

Furthermore, I thank all my colleagues from my research group for their friendship!

Special thanks I would like to devote to my wife Cathlen, my sister Aila, my parents and my extended family in general. They had to experience my absence many times and supported me in all my struggles regarding science, but also helped me and encouraged me throughout my whole life. Thanks a lot!

Finally, I would like to express my deepest gratitude to God as well. In this study, I often felt peace and experienced how my creator and the almighty God was carrying me though!

Table of content

1. Introduction	1
1.1. The human eye	1
1.2. Cataract.....	2
1.3. History of cataract surgery	4
1.4. History of intraocular lenses.....	7
1.5. IOLs in these days	10
1.5.1. Lens types.....	11
1.5.2. Lens designs	13
1.5.3. Manufacturing of IOLs.....	14
1.5.4. Challenges for IOLs	15
1.6. Ophthalmic drug administration.....	17
1.6.1. Overview	17
1.6.1.1. Ocular barriers and drug distribution within the eye	18
1.6.1.2. Routs of administration.....	20
1.6.2. Extended drug delivery to ocular tissues.....	22
1.7. Lenses as drug delivery systems	25
1.7.1. Contact lenses.....	25
1.7.2. Intraocular lenses.....	25
1.7.2.1. Approaches for producing drug eluting IOLs	26
1.7.2.2. Inserts	29
1.7.2.3. Copolymerization.....	31
1.7.2.4. Soaking	31
1.7.2.5. Coating.....	33
1.8. Research Objective.....	34
2. Materials and methods	35
2.1. Materials.....	35

2.1.1.	Monomers & excipients for polymerization	35
2.1.2.	APIs	36
2.1.3.	Salts, to prepare artificial aqueous humor	37
2.1.4.	Solvents	37
2.1.5.	Polymers	38
2.1.6.	Instruments	38
2.1.7.	Others	39
2.2.	Methods	40
2.2.1.	Lens preparation	40
2.2.2.	Lens characterization	42
2.2.2.1.	Chemical/physical properties	42
2.2.2.1.1.	Water uptake	42
2.2.2.1.2.	Wetting angle/ contact angle	42
2.2.2.1.3.	Foldability	43
2.2.2.1.4.	Scanning electronic microscopy (SEM)	43
2.2.2.1.5.	Differential scanning calorimetry (DSC)	43
2.2.2.1.6.	FT-IR	43
2.2.2.1.7.	Het-Cam test (hens egg test-chorio-allantoic membrane)	44
2.2.2.2.	Optical properties	44
2.2.2.2.1.	Refractive index	44
2.2.2.2.2.	Transmittance	44
2.2.2.2.3.	Glistening	45
2.2.2.2.4.	Morphology / Macroscopic pictures	45
2.2.3.	Drug loading	45
2.2.3.1.	Soaking	46
2.2.3.2.	Copolymerization	46
2.2.3.3.	Coating	46
2.2.3.3.1.	IOL coating	47

2.2.3.3.2.	Haptic coating.....	47
2.2.3.3.3.	Lateral surface coating.....	48
2.2.4.	Drug release.....	48
2.2.4.1.	Artificial aqueous humor	48
2.2.4.2.	Sampling	49
2.2.4.3.	Calculation of drug release	49
2.2.4.3.1.	Dual wavelength method	49
2.2.4.4.	PH-measurement.....	50
2.2.5.	Statistical calculations	50
2.2.5.1.	F2 factor.....	50
2.2.5.2.	Apparent diffusion coefficient.....	51
3.	Results and discussion.....	52
3.1.	Introduction	52
3.1.1.	Polymerization	52
3.1.2.	Physical characterization of intraocular lens formulations	53
3.1.3.	Optical properties of intraocular lenses.....	55
3.1.4.	Purification	56
3.1.5.	Sterilization	57
3.1.6.	HET-CAM test	57
3.2.	Hydrophilic lenses.....	58
3.2.1.	Background	58
3.2.2.	Lens formulations.....	58
3.2.2.1.	Polymer volume fraction.....	60
3.2.2.2.	Addition of water to expand the polymer structure	61
3.2.3.	Loading approaches.....	63
3.2.3.1.	Drug loading by copolymerization	63
3.2.3.1.1.	Nanoparticles	66
3.2.3.2.	Soaking	67

3.2.3.2.1.	Time.....	68
3.2.3.2.2.	Concentration.....	69
3.2.3.2.3.	Temperature.....	71
3.2.3.2.4.	Solvents	72
3.2.3.2.4.1.	Solvent evaporation	73
3.2.3.2.4.2.	Drying procedures	74
3.2.3.2.5.	API.....	76
3.2.3.2.6.	pH	77
3.2.3.2.7.	Cross-linker	78
3.2.3.2.8.	Dyes	79
3.2.4.3.	Functionalized monomers.....	80
3.2.4.4.	Osmolarity.....	82
3.2.4.5.	Loading at the lateral surface.....	84
3.2.4.5.1.	Loading for polymer rods	84
3.2.4.5.2.	Homopolymer	85
3.2.4.5.3.	Lateral - polymer - coating	87
3.2.4.6.	Coating.....	90
3.2.4.7.	Dual drug loading	91
3.2.4.7.1.	Dual drug loading by rehydration.....	91
3.2.4.7.2.	Dual drug loading in advance	95
3.2.4.7.3.	Rehydration procedures	95
3.2.4.7.4.	Drug loading and release study.....	96
3.2.4.7.4.1.	DSC – API within the lens	98
3.2.4.7.4.2.	Transmittance	99
3.2.5.	Suggested dosage form.....	100
3.2.6.	Conclusions	101
3.3.	Hydrophobic lenses.....	102
3.3.1.	Background	102

3.3.2.	Lens characterization.....	102
3.3.2.1.	Lens formulation and characterization.....	102
3.3.3.	Drug loading by copolymerization.....	103
3.3.4.	Drug loading by soaking	104
3.3.4.1.	Soaking	104
3.3.4.2.	Additives to lens polymers in order to improve diffusion	106
3.3.5.	Drug loading by coating	108
3.3.5.1.	Haptic coating	108
3.3.5.2.	Lens coating	110
3.3.5.3.	Coating at the lateral area of the lens	110
3.3.5.3.1.	Coating by polymerization	110
3.3.5.3.2.	Coating solvents	113
3.3.5.4.	Coating near/at the lateral surface.....	113
3.3.5.4.1.	Coating patterns	113
3.3.5.4.2.	Coating layers	114
3.3.5.4.2.1.	Influence of release media.....	117
3.3.5.4.2.1.1.	Coating layers	117
3.3.5.4.2.1.2.	Pore former	119
3.3.5.4.3.	Drug – polymer concentration (Drug loading)	121
3.3.5.4.4.	PLGA types	122
3.3.5.4.5.	Coating level.....	123
3.3.5.4.6.	Morphology of dexamethasone/PLGA coatings	125
3.3.5.5.	Dual drug loading by coating.....	127
3.3.5.5.1.	Suggestion for industrial scale.....	131
3.3.6.	Conclusions	131
3.4.	Amphiphilic lenses	132
3.4.1.	Background	132
3.4.2.	Lens characterization.....	132

3.4.2.1.	Lens formulations	132
3.4.3.	Loading approaches.....	133
3.4.3.1.	Coating.....	133
3.4.3.2.	Soaking	134
3.4.3.2.1.	Lens formulation.....	134
3.4.3.2.2.	Concentration of the soaking solution	136
3.4.3.2.3.	API.....	141
3.4.3.2.4.	Glistening.....	144
3.4.3.2.4.1.	Lens polymers optimization	145
3.4.3.3.	Copolymerization.....	148
3.4.3.4.	Loading at the lateral surface	149
3.4.3.4.1.	Polymers with low drug solubility.....	149
3.4.3.4.2.	Polymer with improved drug solubility	152
3.4.4.	Conclusions	154
4.	Summary/Zusammenfassung	155
4.2.	English.....	155
4.3.	Deutsch.....	160
5.	References	166
6.	Publications and posters	186
7.	Curriculum vitae.....	187

Abbreviations

API	Active pharmaceutical ingredient
DDS	Drug delivery system
DSC	Differential scanning calorimetry
EC	Ethyl cellulose
FDA	Food and Drug Administration
FTIR	Fourier transformer infrared
HCL	Hydrochloride
IOL	Intraocular lens
NaCl	Sodium chloride
PLA	Poly(D,L-lactide acid)
PLGA	Poly(D,L-lactide-co-glycolide)
SD	Standard deviation
Tg	Glass transition temperature
USP	United states pharmacopoeia
UV - Vis	Ultraviolet visible light
WHO	World Health Organization

Excipients for polymerization:

Benzoyl peroxide	BP
Butyl methacrylate	BMA
Ethyl acrylate	EA
Ethylene glycol dimethacrylate	EDMA
Hydroxybutyl methacrylate	HBMA
Hydroxyethyl acrylate	HEA
Hydroxyethyl methacrylate	HEMA
Isobutyl methacrylate	IBMA
Methyl methacrylate	MMA
Phenoxyethyl acrylate	POEA

1. Introduction

The present thesis, entitled “Preparation and characterization of drug-loaded (meth)acrylic intraocular lenses” deals with the preparation and characterization of drug-loaded intraocular lenses (IOL). In this chapter, an introduction is given on various topics, related to this subject. First, the anatomy and specific conditions of the eye are revealed. Next, cataract is described, the main reason for the use of IOLs and a historical background of IOL development is presented, followed by presenting characteristics of different ocular drug administration routes. Finally, the state of the art for drug-loaded intraocular lenses is reviewed and the need for these devices is explained.

1.1. The human eye

Our senses open our environment to us. Seeing, hearing, tasting, smelling, touching enable a complex perception of the world. All the senses are important, but the most important sensory organ for humans is the eye (Figure 1).

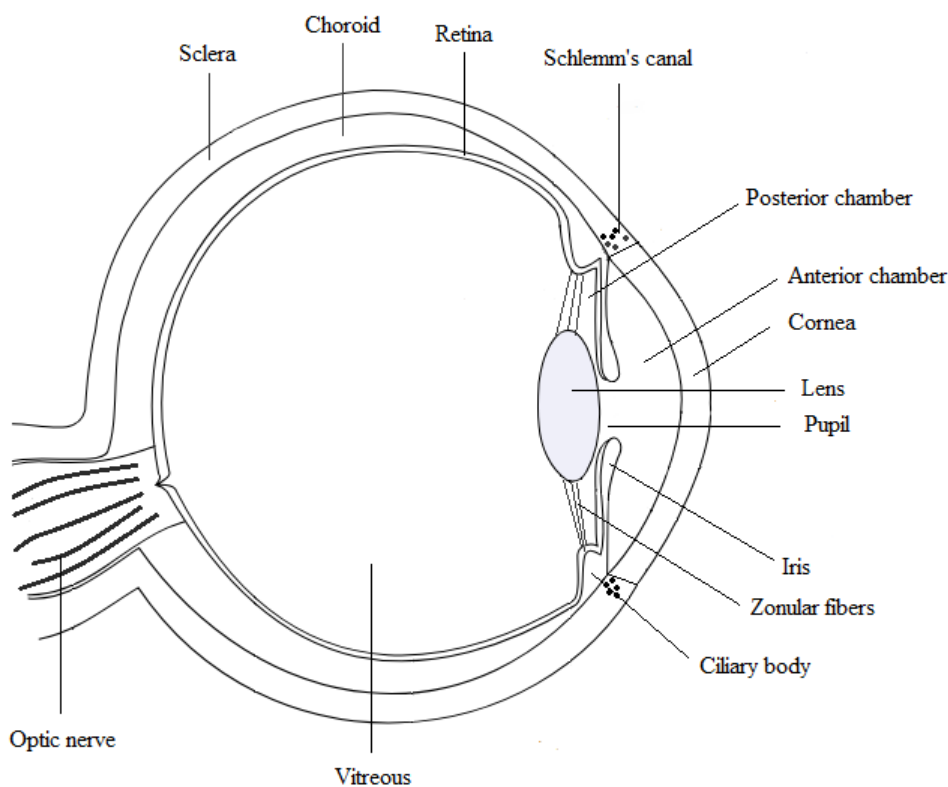

Figure 1: Schematic illustration of the human eye

Humans are first and foremost visually oriented beings. This is also indicated by the fact that 70 percent of the total amount of our sensory cells are in the retina of the eye [1].

The eye can be divided into two main parts, the outer section and the inner section. The outer part consists of the cornea, the pupil and the iris. The cornea is a thin transparent multi-layer epithelia structure that is the frontal closure of the eyeball. By providing a refraction power of +43 diopter, the cornea is the main part for image focusing. The cornea has no blood vessels and is maintained from the surrounding tissues and aqueous humor [2], filling the posterior and anterior chamber. The pupil is surrounded by the iris, which functions like a diaphragm and regulates the incidence light quantity by adjusting the pupil width.

In the inner part of the eye, different structures are present but for vision, compounds such as the lens and the retina are pivotal. The lens is connected all around by the zonular fibers to the annular ciliary muscle. The contraction of this muscle relaxes the zonular fibers, which makes the lens more curved due to its inherent elasticity. Thus near vision is focused. When the muscle relaxes, the pull of the zonular fibers leads to a flattening of the lens and thus to the setting for distance vision. The scattered light is projected on the retina, which contains many photosensitive nerve cells (photoreceptors), the cones and rods [1,3,4]. While the rod cells are responsible for seeing in the dark, the cones give rise to colors during the day and at dusk. The choroid surrounds the retina and is responsible for the blood circulation of the eye and the absorption of important nutrients.

To create an image in the mind, light has to pass the cornea, the anterior and posterior chamber, the pupil, the lens and the corpus vitreum and hit the sensory cells of the retina. Formed electric impulses are transmitted via the optic nerve to the brain where the stimuli are processed. Therefore, optical structures within the eye have to be transparent and provide different light refraction in order to focus [1]. If the light refraction is not adjusted perfectly, vision becomes blurry and glasses might be needed to compensate these errors.

1.2. Cataract

The eye is the main sensory organ for humans and impaired vision decreases the life quality of millions all over the world. Cataract affects more than 95 million people worldwide and is still the leading reason for blindness in less developed countries [5,6]. The natural human lens is a transparent biconvex structure within the eye which provides light refraction and is able to accommodate by focusing light onto the retina. In the early pregnancy month, the ocular lens

is formed in the embryo by fibers and is surrounded by the capsule. The lens epithelium generates new fibers constantly, which immigrate towards the center, thus older fibers cumulate in the core whereas newer fibers are located at the outer parts, named Cortex. Cataract usually is developed in older people, also named age-related cataract. The lens becomes cloudy, caused by protein aggregation and thereby the light transmittance is decreasing. In severe cases of cataract, the lens appears turbid, even from outside. In ancient Greek, physicians assumed that some liquid fell down and covered the pupil. Therefore, the word “cataract” can be derived from the Greek word “υπόχρυσις” (kataráktēs) which means, the “fall of water” [7].

Cataract is classified in three main types (Figure 2) [5]. The nuclear cataract is formed in the nucleus (central zone) of the lens and is related to the age of the patient. In contrast, posterior subcapsular cataract is associated with diabetes and high doses of steroid medications as well as the cortical cataract [8]. Most cataracts are a combination of all three cataract types.

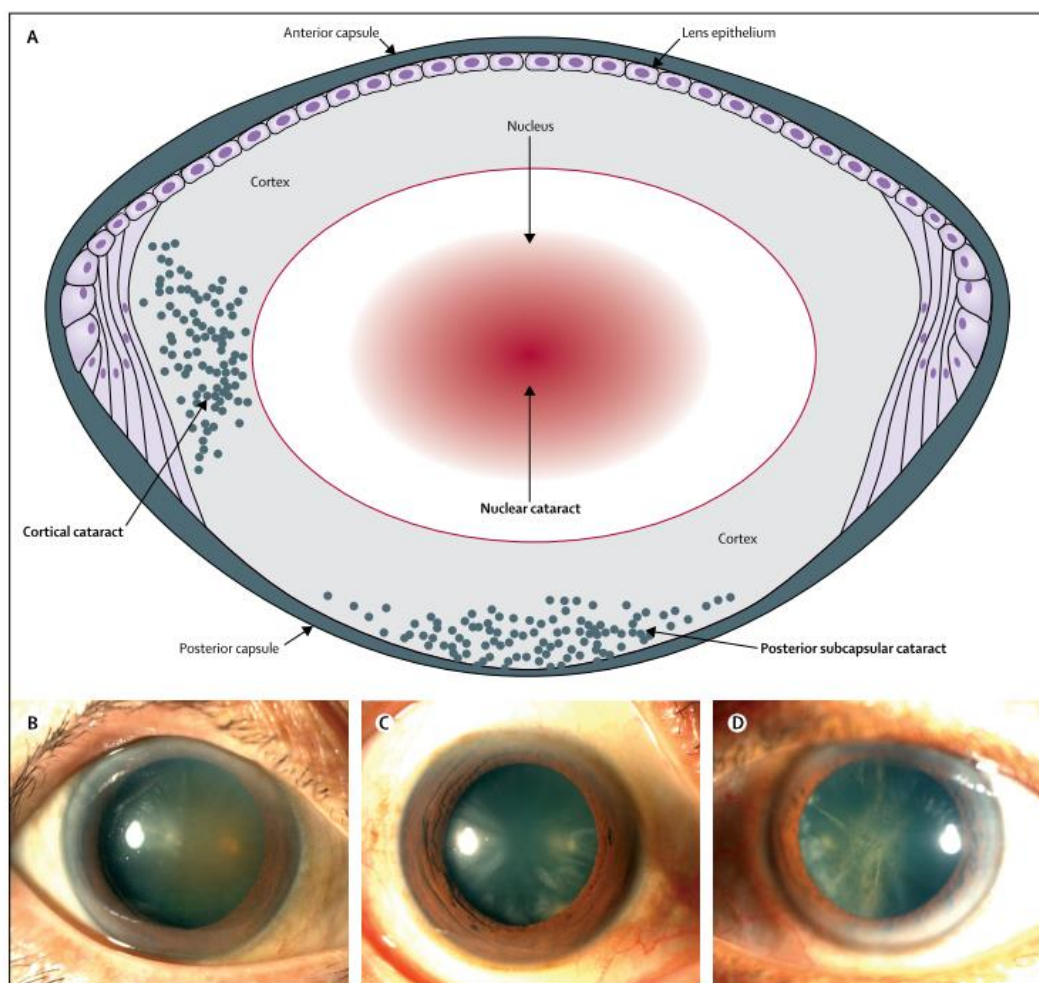

Figure 2: Characteristics of lens structures and different types of cataracts (adapted from “Cataract, The Lancet, 2017”)

- A: Lens structure and different types of cataract
- B: Nuclear cataract
- C: Cortical cataract
- D: Posterior subcapsular cataract

In 2016, eye drops, containing lanosterol as API, were suggested as a remedy for cataract [9,10], attributed to the capability of lanosterol to reduce protein aggregation in the lens. This effect of lanosterol could be demonstrated in animal studies in case of age-related cataract. However, until this product can be introduced to the market, many years will pass and clinical studies have to be conducted.

However, so far there is no commercialized medical remedy for lenses, which suffer cataract. To improve vision after developed cataract, the natural lens has to be removed and needs to be replaced by an artificial intraocular lens (IOL). This medical procedure was developed in the 20th century and became the most often performed surgery worldwide nowadays [8].

1.3. History of cataract surgery

Cataract was already common in ancient times, thus it was already mentioned about 1525 B.C. in the Ebers papyrus in Egypt [11] and in various other cultures throughout the ages like the Greeks, the Latins and the Arabas [12]. A small stature, nowadays located in the Egyptian museum in Cairo, Egypt, documents the oldest known case of cataract. This sculpture is from the 5th dynasty (about 2457-2467 B.C.) and represents a priest, that suffered cataract in his right eye. Ancient surgery instruments which were found reveal, that already in ancient Egypt, it was tried to heal cataract and basic surgery technics were developed [12]. Surgical instruments and wall paintings in the tomb of “Ipwy at Thebes” (about 1200 B.C.) revealed, that the operation consisted in crashing the natural clouded lens and couching it into the vitreous cavity [7]. This “couching” surgery (Figure 3) [13] was conducted by one sharp instrument that just pushes the turbid natural lens to the bottom of the eye and is most probably one of the oldest developed surgeries at all and was also performed in the first Babylonian dynasty [7]. However, by this

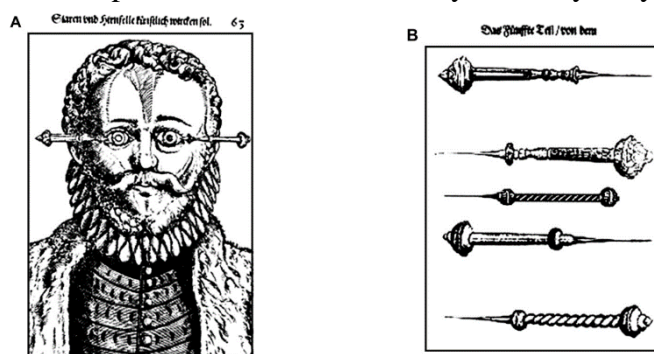

Figure 3: German atlas for eye surgery, 16th century
Ancient technic of “couching”
A: Frontal view
B: Couching needles
(adopted from Apple et al. 2011)

technic, the clouded lens is removed from the optical axis of the eye, but the visions for patients was blurry afterward, due to insufficient refraction power of remaining tissues.

This “couching” method prevailed the ages and was common also in the Middle Ages and is still used in some areas in Yemen and Africa [14] today.

Later, physicians started to extract the lens during the surgery but this was even more harmful. The eye was opened with a large incision and a hollow needle was injected. The surgeon took the other side of the needle in his mouth and aspirated the lens [15]. That way, he ensured that the lens could not get into the field of vision, but the outcome was detrimental anyway.

The first successful lens extraction was performed in Europe by the French ophthalmologist Jacques Daviel (1696 – 1762) on April 8, 1747 [15]. In this time, the German composer Johann Sebastian Bach was treated by this technic as well (1750) but four months after the surgery he died as a blind man [15]. However, John Taylor, the physician, who treated Johann Sebastian Bach as well, started to break the lens into parts before he removed it.

First by Sir Nicholas Harold Ridley (1906 – 2001, Salisbury, United Kingdom) (Figure 4) [16][13] the cataract surgery changed fundamentally [15]. He was an ophthalmologist at the Moorfield Eye Hospital and St. Thomas hospital in London and was unsatisfied with the outcome of cataract surgeries.

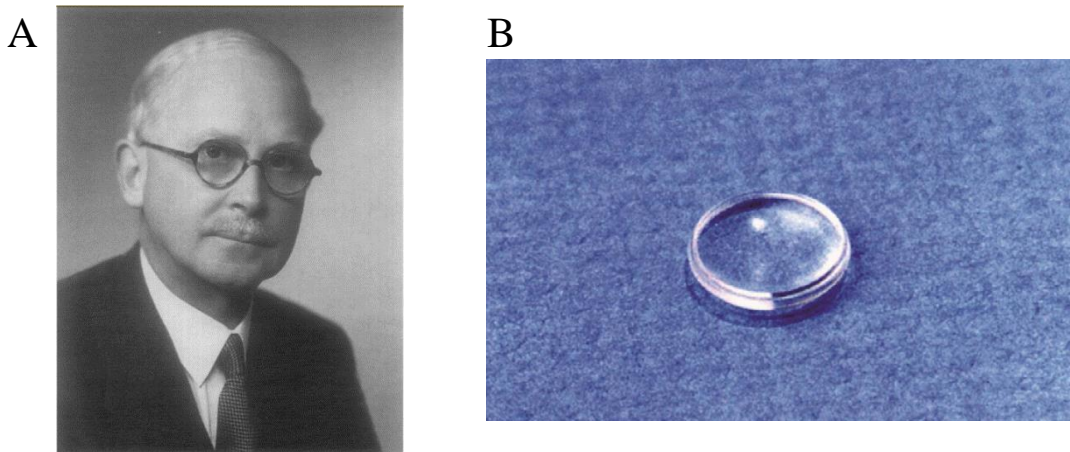

Figure 4: A: Harold Ridley, about 1950, at the time of the first intraocular lens implantation
B: Ridley’s original IOL (1949), made of rigid polymethyl methacrylate
(adopted from Apple et al. 1996 and Apple et al. 2011)

One day, an unknown medical assistant mentioned during a surgery, that it is a pity, that the lens could not be replaced by a transparent lens. Ridley observed during the Second World War, that scattered pieces of the canopy of aviators remained in the eye, without leading to inflammation. These broken parts were made of polymethyl methacrylate (PMMA) and were

considered as biocompatible and safe by Ridley [17]. In 1940, he introduced the idea of implanting an artificial lens after lens removal and on November 29th 1949 he implemented the first intraocular lens successfully into a woman's eye in the St. Thomas Hospital, London. The lens was made of PMMA and had a mass of 138 mg. In the beginning, other physicians were not convinced by the idea of replacing natural material by artificial ones and Ridley's technique was less adopted by others until he published his paper "Intra-Ocular Acrylic Lenses" in 1951 [17]. In the year 1966, the first international symposium on IOLs was conducted and Ridley became the first president of the "Intraocular Implant Club" (IIC). Ridley's student Peter Choyce investigated different lens models and in 1981, the first intraocular lens, named Choyce Mark IX was approved by the US Food and Drug Administration [7].

Ridley had to overcome many obstacles and prejudices in his life but finally, he was awarded by many different comities and societies and was knighted by HM Queen Elizabeth II at the Buckingham Palace in February 2000 [18].

Charles D. Kelman introduced in 1967 the phacoemulsification technic [19], fascinated by his dentist, who used an ultrasonic probe. He used this technic in order to emulsify the clouded lens by ultrasonic waves to aspirate scattered pieces through a small hollow needle. Since that time, just small incisions are needed and the surgery became less painful and the suture recovered faster. Additionally, this smaller incision was less prone to complications and shorter convalescent periods were required.

Nowadays, most intraocular lenses are flexible and are applied folded through very small incisions, named "Manual Small Incision Cataract Surgery" (MSICS). In 2008, a clouded natural lens was broken into pieces by a femtosecond laser the first time [19]. By this technic, the sharply focused laser targeted specific areas within the lens and thereby the crystalline lens was fragmented. This technic seems promising, but the classical phacoemulsification is still the most prominent procedure.

By better medical possibilities and improved hygiene, cataract surgeries are considered as quite safe, but complications occur nevertheless.

1.4. History of intraocular lenses

Even when cataract surgeries were conducted already in ancient times, the story of intraocular lenses just started in the middle of the 20th century with Sir Harold Ridley in 1949. Since that time, many different lens formulations were investigated and the improvements are stunning.

Ridley had no knowledge about the light refraction of PMMA, the first lens material. Therefore, he calculated the size of the first IOLs just by the dimensions of the natural lens. Thus, the first lens measured 8.35 mm in diameter and 2.40 mm in thickness and had a mass of 138 mg [17,20]. The refraction of this lens was too pronounced, but the surgery went well and 17 months afterward, he presented his results and accomplished new calculation procedures, to predict lens dimensions in order to provide appropriate light refraction [21]. In the next years, Ridley implemented more than 1000 PMMA lenses, which were located in the capsular back. That time became known as the “first generation” of IOLs [22,23].

Regarding insufficient lens fixation, in the second generation (beginning of the 50s to the beginning of the 60s) IOLs were placed in the anterior chamber and fastened in the iridocorneal angle. The surgery became easier for these anterior chamber lenses than the posterior lens injection that was introduced by Ridley. Many different lens shapes were developed but the cornea clouded in some cases and inflammations occurred often, also attributed to inappropriate materials that were used for IOLs [24].

The third generation of IOLs was attached to the iris by specific haptics. An intraocular lens consists out of the ocular lens and the haptic, which are small anchors that locate the lens within the eye. In 1957, the first iris-clipped lens was prepared by Binkhost, which had 4 haptics, two were placed in front and the other two haptics behind the iris. That was how the lens was fastened. But in respect to eroding iris tissue, these lenses dislocated after a few years frequently. However, these lenses remained prominent over 20 – 25 years.

In the 1960s and 70s, the fourth generation of IOLs emerged. This time, previous anterior chamber lenses were improved, regarding dimensions, designs and material. Attributed to

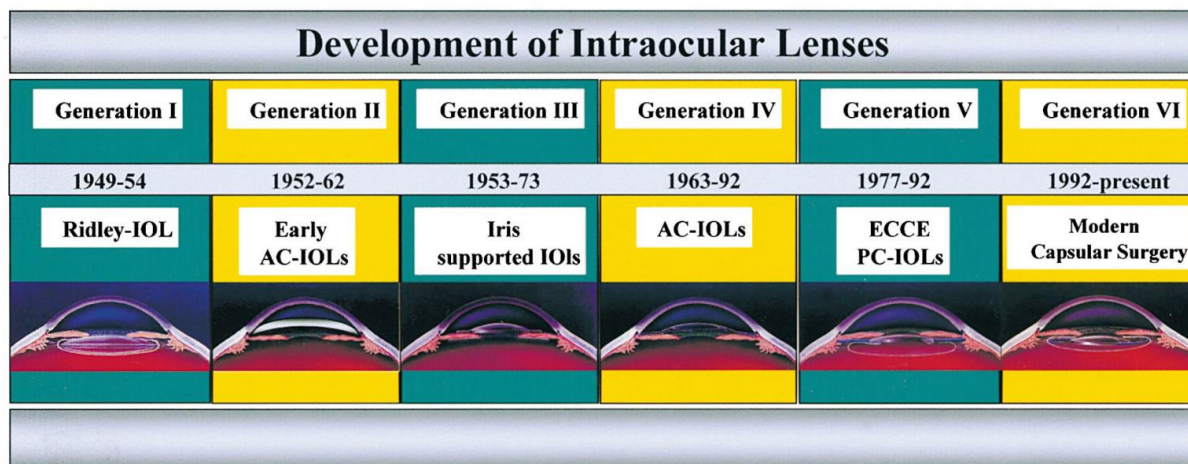

Figure 5: Timeline presents the six major generations of IOLs (adopted from Apple et al. 2000)

applied IOLs, that were not approved and had limitations in their quality such as insufficient polishing, followed by not smooth surfaces, many lenses induced the UGH-syndrome (Uveitis-Glaucoma-Hyphema) [25]. Regarding the different dimensions in human eyes, lenses with flexible haptics emerged, that could adjust to the conditions within the eye. Various lenses were investigated and 1987, many IOLs were refused of the marked again by the FDA [25]. At that time, microscopes for the ophthalmic surgery appeared and phacoemulsification was improved. Thus, the next generation (generation V) was mainly attributed to better surgery technics. The ICCE (intra capsular cataract extraction) was replaced by the extra capsular cataract extraction (ECCE), in which the capsular bag remains in the eye and could be used for lens location. Furthermore, lenses with improved haptics were investigated and the first IOLs coatings such as heparin or polyfluorocarbonate coatings appeared at the market in order to avoid post-surgery inflammation and less cell adhesion [26,27] (Figure 5) [12].

The first soft and foldable lenses were developed and applied in primates already in the 1950s. In 1978, the first folded lens was injected into a human eye [28] and silicon lenses became famous in the 80s by Mazzocco [29].

Table 1: Development of intraocular lenses [12]

Generation	Dates and Types of IOLs
I	1949 – 1954 Original Ridley posterior chamber, PMMA* IOL manufactured by Rayner
II	1952 – 1962 Early anterior chamber lens
III	1953 – 1973 Iris-supported, including iridocapsular IOL implanted after ECCE
IV	1963 – 1992 Transition towards modern anterior chamber IOLs
V	1977 – 1992 Transition to and maturation of posterior chamber lenses
VI	1992 – present Modern posterior chamber IOLs

Nowadays, the sixth generation of intraocular lenses is present (Table 1) and it is not possible to classify them as simple anymore, concerning innumerable different lenses, regarding, shape, material, haptic, insertion technic and various other aspects [24]. Just between 1981 and 2011, more than 19400 different IOLs were studied [13]. Today, most IOLs are foldable and are injected into the capsular bag in the posterior chamber. The optical part if the IOL is polished and transparent to improve vision, whereas the haptic is also flexible and locates the lens within the center of the capsular bag (Figure 6). Today, hydrophobic acrylates are the most common lens materials.

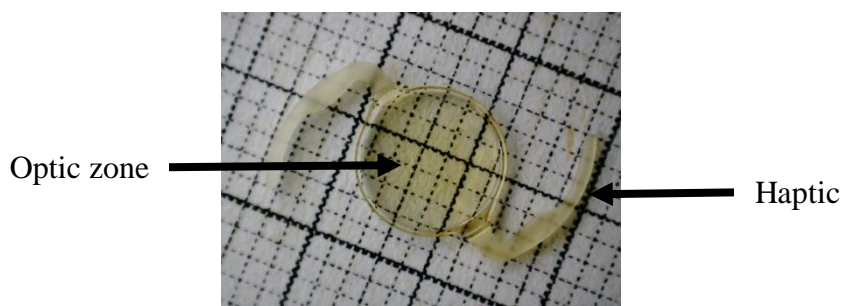

Figure 6: Intraocular lens
 Model: NS-60YG
 Product name: EyeCee® ONE
 Intended placement: Posterior chamber

The cataract surgery nowadays:

In a common uneventful cataract surgery, the cornea is opened by a very small incision (~ 2 mm) and the natural lens is broken into pieces by an ultrasonic probe (phacoemulsification) and aspirated afterward. The capsular bag remains in the eye, is cleansed from remaining cells and the intraocular lens is injected into it (Figure 7) [30].

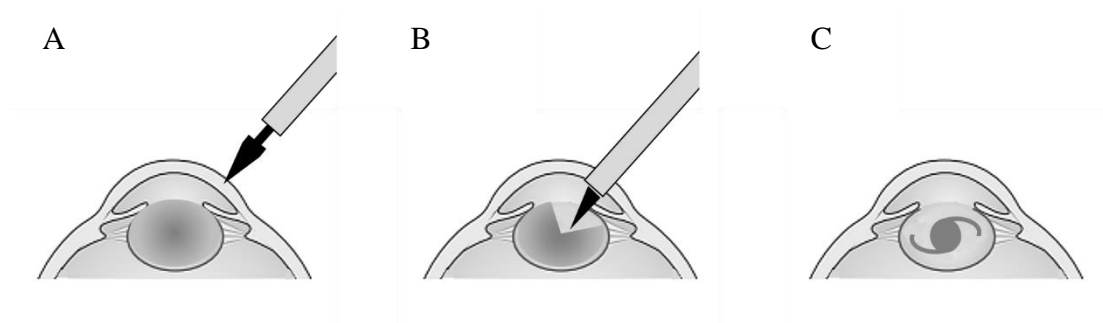

Figure 7: Cataract Surgery, using “Phacoemulsification”

A: Small incision is made in the cornea (1.8 – 2.2 mm) by a diamond knife

B: Ultrasonic emulsification and aspiration of the lens nucleus, by a phacoemulsification needle

C: Implantation of an intraocular lens into the capsular bag
(adopted from Lam et al. 2015)

The whole procedure is conducted with local anesthesia and consumes less than 10 minutes. To avoid postoperative complications, antibiotics are applied for one to two weeks to avoid infections, whereas steroids are provided for approximately 1 month [31,32] to avoid inflammation.

1.5. IOLs in these days

Intraocular lenses can be categorized by different aspects, such as material, shape and location within the eye. Attributed to the countless IOLs nowadays, an overview is given (Table 2).

Table 2: General classifications of intraocular lenses [33]

Characteristic	Modifications
Destination	Capsular bag, ciliary sulcus, scleral fixation, iris fixation, angle supported
Overall design	3 piece/1 piece
Overall length	10–13 mm
Optic material	Rigid (PMMA), flexible (silicone), foldable (hydrophobic acrylic, hydrophilic acrylic), Collamer
Refractive index	1.42 – 1.55
Optics shape	Biconvex, plano-convex, meniscus
Optic diameter	5 – 7 mm
Optics design	Spherical, aspheric, toric multifocal, multifocal toric
Optics color	Transparent, tinted
Haptic properties	3 piece/1 piece (PMMA, PVDF, polyamide, 2, 3, 4, 6 haptics)
Type of implantation	Injectable, not injectable
Type of packaging	Pre-loaded, not pre-loaded

1.5.1. Lens types

In this thesis, lenses were divided into groups, accordingly to their hydrophilic-hydrophobic balance. The three main used IOL materials are polymers of hydrophobic acrylates, hydrophilic acrylates and silicones. The main monomers are methyl methacrylate (MMA) and phenoxyethyl acrylate (POEA) as hydrophobic and 2-hydroxyethyl methacrylate (HEMA) as hydrophilic compounds (Figure 8).

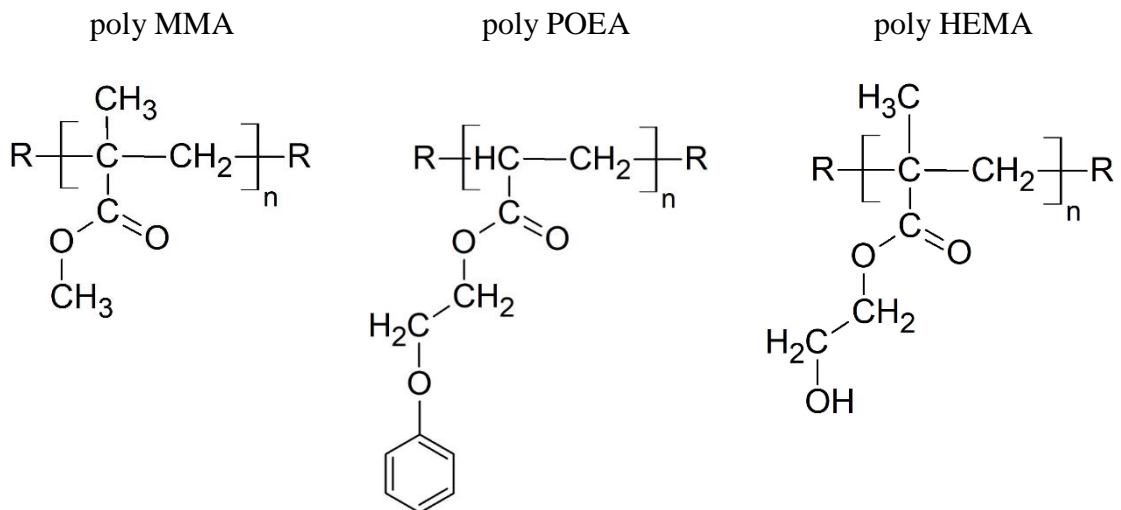
**Figure 8:** Polymers of the three main monomers that are used in IOLS production

Hydrophobic Acrylates:

Polymethyl methacrylate:

In high-income countries, the non-foldable PMMA is almost obsolete and is just used for children, due to its long-term stability, but in less developed countries, it is still common regarding its low expense [34,35] and its good biocompatibility. PMMA with sharp optic edges had low posterior capsule opacification (PCO) rates [36–39]. By this design, the capsular bag and the artificial IOLs are connected perfectly and cell immigration between lenses and capsular bag is avoided. PMMA has low water uptake (<1%) and a high refractive index (1.4900) [33].

Foldable hydrophobic acrylates:

Nowadays, flexible hydrophobic acrylates are the most common lens materials [40] due to its high refractive index (1.4400 – 1.5500) and its elastic properties at room temperature [33]. This material unfolds in a controlled manner so that adverse effects within the eye are rare. Furthermore, these polymers have good shape memory, thus also the haptic can be prepared by this material. So, one piece IOLs are reasonable with hydrophobic acrylates [33]. Additionally, these lenses are more resistant to PCO and in case of developed PCO, they are quite insusceptible to Neodymium:YAG (Nd:YAG) laser, the treatment to recover posterior capsule opacification [41].

The two main drawbacks of these materials are glistening and dysphotopsias. Small liquid-filled vacuoles (1-30 μm) within the lens polymer are named glistening [35,42–44]. It is common in hydrophobic acrylates and does not decrease optical quality in all patients' eyes, but mostly, contrasts are less pronounced in lenses, that developed glistening. Dysphotopsias describes halos or edge glares, but this phenomena could be reduced extremely by more sophisticated lens shapes [45].

Attributed to their foldable properties, hydrophobic intraocular lenses are supplied in dry conditions but they are sticky and might need a lubricant for ejection by the injector.

Foldable hydrophilic acrylates:

Hydrophilic intraocular lenses are made of hydrophilic acrylates and methacrylates. They are lathed and polished in the dry state. Afterward, they are stored and supplied in an aqueous solution to make them flexible, attributed to the plasticizing effect of water. In this media, hydrophilic acrylates swell and have high water uptakes and form hydrogels. Hydrogels are

extremely well tolerated by organic tissues, due to their similar nature and water content [33]. For hydrophilic lenses, the incidence of PCO was slightly higher but attributed to improved lens shapes, this drawback was vanquished [46,47].

Credited to their high water content, the refractive index (~1.4300) is less than for hydrophobic lenses. In some hydrophilic lenses, the optical quality decreased, caused by formed calcium phosphate crystals on the lens surfaces, named calcification [48–51].

Silicones:

Silicones were the first foldable materials, that could be used for intraocular lenses, but in the last years, the use of it declined constantly [45]. The PCO rate is low for silicones [52,53], but injections appeared as difficult. Furthermore, the use of silicone oils for other ocular diseases like retinal detachment is limited [54,55].

Regarding the small market share of silicone intraocular lenses, drug-loaded IOLs made of silicon were not considered as targeted IOLs.

1.5.2. Lens designs

In the last years, many different lens designs were investigated. Besides the biconvex structure of the optical part that is common for most intraocular lenses, various modifications of the haptic were prepared (Figure 9) [13].

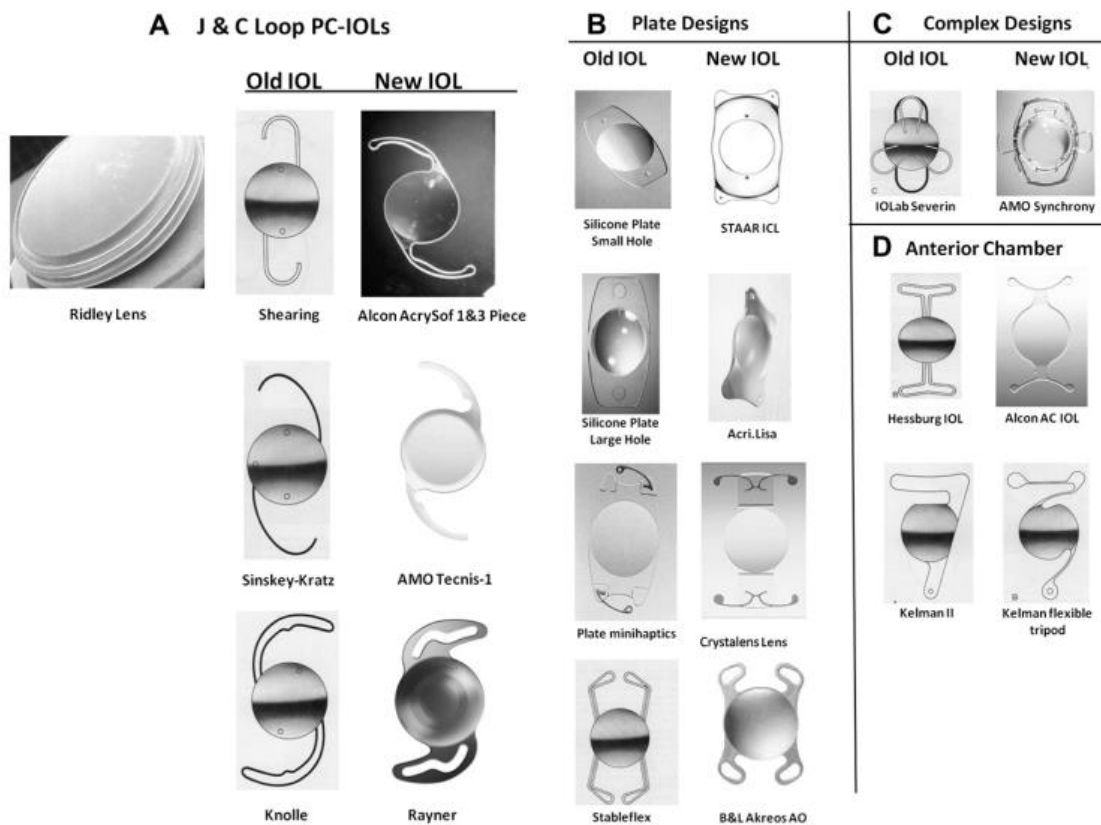

Figure 9: Classification of current IOLs in four groups

A: J and C shaped haptics, named “J & C loop design”

B: Plate design

C: Complex designs, consist mostly on different parts that are assembled later

D: Anterior Chamber lenses, are not injected into the capsular bag

(adopted from “Survey of Ophthalmology volume 56/Supplement 1/November-December 2011”)

1.5.3. Manufacturing of IOLs

Intraocular lenses are prepared by two different approaches [41,56–58] (Figure 10). Either the mixture of monomers is cast into a mold and the lenses are already polymerized in the final form, named molding method [59–61] or by the lathe - cut method [12,62–64]. During that procedure, polymer rods are prepared and the IOLs are lathed out.

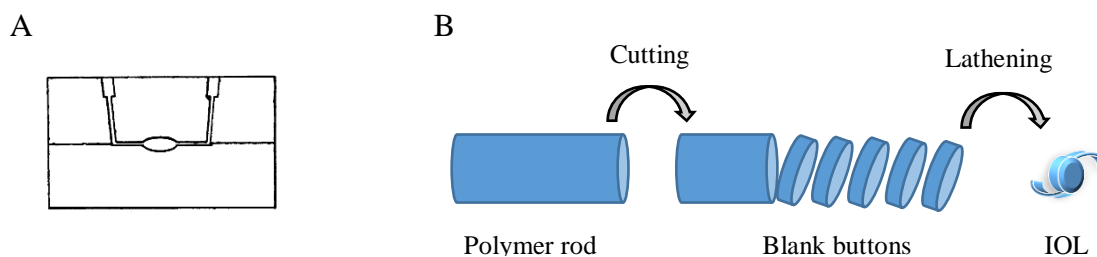

Figure 10: Lens production:

A: Molding; Mixture of monomer is cast in a mold and polymerization is performed

B: Lathening; Polymer rod is cut and lenses are drilled out

For flexible IOLs, molding is the standard method. For brittle polymers, that can be drilled easily, the lathening method is most prominent. Thus, non-soaked hydrophilic and PMMA lenses are cut into small “blank buttons”, which are drilled to IOL shapes. All polymers are purified normally with water or organic solvents, in order to remove remaining process residuals such as monomers, cross-linkers and initiators [58], [65]. Final polishing is necessary for both preparation methods. Flexible materials are cooled below the glass transition temperature (T_g), to make them more resistant during polishing and smoothing.

In this thesis, lenses were prepared by the lathening method.

1.5.4. Challenges for IOLs

Since 1950, intraocular lenses and surgery technics improved extremely and the cataract surgery is considered as one of the safest operations with excellent outcomes. However, some challenges are still present, that need to be overcome.

Posterior capsule opacification:

The main issue for IOLs is the possible development of posterior capsule opacification, also named secondary cataract or after cataract [46,47,66]. Actually, it is not another cataract that is formed, but the symptoms are similar. Lens epithelial cells (LEC) that remained in the capsular bag during the cataract surgery immigrate to the posterior capsule, where they proliferate. Thus, a layer of cells is formed at the center of the capsular bag, mostly between the IOLs and the capsular bag, resulting in opacification. PCO is common and appears from a few months up to a few years after the surgery in more than 50% of treated eyes [67]. However, various factors such as lens material and shape have an impact on the incidence of PCO [47,67–69]. Thus, the

sharp edge design had proven to be advantageous, because cell immigration between the capsular bag and the lens is avoided (Figure 11), resulting in less PCO [37,38,70]. Unfortunately, sharp edges are associated with “edge glare” phenomena, because light refraction is also provided at the peripheral side of the IOL [71,72]. By half rounded edge designs, the posterior side is sharp, whereas the anterior profile is round, hence those limitations and disturbing side effects were overcome [45].

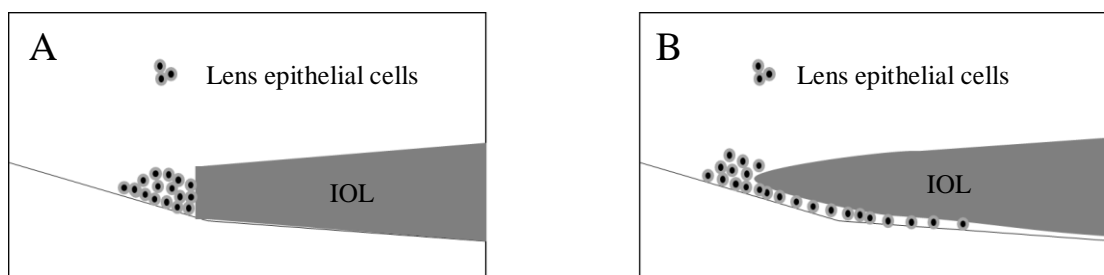

Figure 11: Preventing of LEC migration by sharp edges

A: Sharp optic edge

B: Round edge design

(adopted from Findl et al. 2009)

In case, PCO developed, it can be treated easily by Nd:YAG laser capsulotomy. Here, the capsular bag is targeted by that laser and opened by it [41]. Thereby, the vision is improved, but side effects might occur, such as lens damages. Furthermore, the laser might cause other complications such as ocular inflammation, glaucoma, retinal detachment or cystoid macular edema [45].

Therefore, different approaches were investigated to avoid PCO, such as more sophisticated lens shapes or materials. Additionally, IOLs were loaded by various drugs, in order to reduce cell migration and proliferation.

Infection and inflammation:

Besides PCO, infections and inflammations might develop after the cataract surgery. That is why eye-drops or ointments have to be applied for a specific time. Medication profiles vary between different physicians, but generally, antibiotic eye-drops need to be applied every two hours in the first 2 - 3 days and afterward, the dose gets reduced. Antibiotic medication is

stopped after 7 – 10 days, when the suture recovered completely [73–76] and the chance to develop endophthalmitis decreases. However, 0.1 – 0.3% of all treated eyes are affected by endophthalmitis [77]. Additionally, steroids or non-steroidal anti-inflammatory drugs (NSAID) such as dexamethasone and diclofenac are used for 4 weeks after the surgery, in order to avoid inflammations [31,73,75,78]. Here the application is less frequent but lasts for a longer time period.

In respect to geriatric patients, who normally undergo the cataract surgery, this frequent and extended drug administration is inconvenient and compliance decreases rapidly. This also might be a reason for increased incidences of postoperative complications throughout the last years [77].

Therefore, drug-loaded intraocular lenses, which release antibiotics and steroids with different release profiles simultaneously would be beneficial. First, it could decrease postoperative complications and secondly, the frequent unpleasant drug applications could be avoided.

1.6. Ophthalmic drug administration

1.6.1. Overview

In the European pharmacopeia, “ophthalmica” are preparations for the use at the eye. They might be liquid, semi-solid or solid and have to be applied at ocular tissues. For ophthalmica, remarkable high quality has to be guaranteed such as sterility, stability, tolerance and non-irritating characteristics [77].

The most common ocular dosage form are eye-drops. They are applied as aqueous or oily solution, emulsions or suspensions. In the case of aqueous formulations, osmolarity (225 – 430 mosmol/kg) and pH (5.5 and 10.5) has to be tuned [77]. Due to blinking, and a fast flush out from the ocular tissues, gels and other semi-solid formulations are prepared to prolong the residence time within the eye to improve bioavailability. Longer contact times are achieved by inserts and suspensions as well. Inserts are solid devices that are placed in the eyelid and release the drug over an extended time period. For suspensions, the liquid phase might be washed out fast, but the solid phase can resist in the eye and provide prolonged drug delivery.

However, the eye is an organ that is difficult to treat by drugs, due to its various barriers.

1.6.1.1. Ocular barriers and drug distribution within the eye

The eye is most probably the least artificial cleansed part of our body surface. By different mechanisms and barriers, the eye protects itself against environmental influences and remains clean and ocular physical function is retained [79]. Drugs that are applied topically on the eye have to overcome these barriers and challenges as well, resulting in low bioavailability (Figure 12) [80]. However, eye-drops are the most common ophthalmic dosage form, due to its simple administration.

Cornea and barriers in the anterior segment:

The cornea is a thin (0.5 mm) transparent collagenous structure which is the first barrier for topically applied drugs. The cornea consists of different layers of cells and is covered by a tear film. This tear film is mainly aqueous and limits hydrophobic drug diffusion whereas the cornea is a cellular structure and restricts diffusion of hydrophilic compounds. By that reverse two-layer barrier, most APIs cannot even penetrate the cornea. Furthermore, the residence time on the cornea is restricted due to solution drainage, blinking, tear turn over and induced lacrimation [79], so that topically applied solutions are removed just 15 – 30 seconds after administration [79,80]. Thus, the residence time is decreased extremely, followed by low bioavailability of < 5% for most drugs [80].

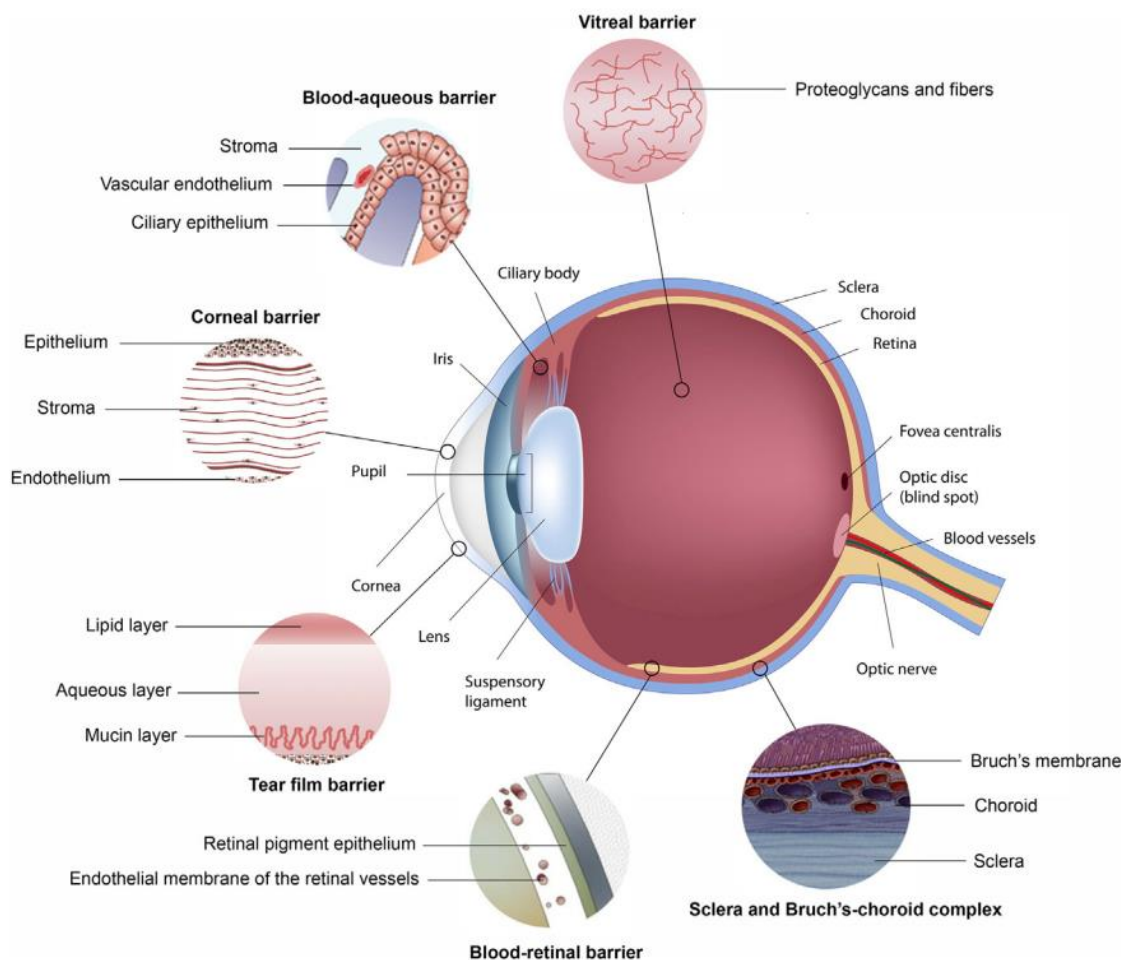

Figure 12: Physical barriers in ocular drug delivery
(adapted from Huang et al. 2017)

Besides these barriers, the conjunctiva adsorbs drugs quite well and caused by the presence of various blood capillaries and lymphatics in this tissue, the APIs are loose in the systemic circulation, followed by lowering the drug concentration at the ocular tissues [80].

Additionally, the intraocular compartments in the anterior chamber are protected by the blood-aqueous barrier (BAB). By this barrier, the transfer from the blood/plasma to the aqueous humor is restricted. These tissues consist of discrete cellular layers with tight junctions that prevent almost all hydrophilic compounds to pass.

Moreover, the aqueous humor is secreted into the posterior chamber by the ciliary body with a rate of 2.0 to 3.0 ml/min [80,81]. From there, it flows constantly towards the anterior chamber, where it is resorbed at the schlemm's canal and by the trabecular meshwork. Thus, drug from

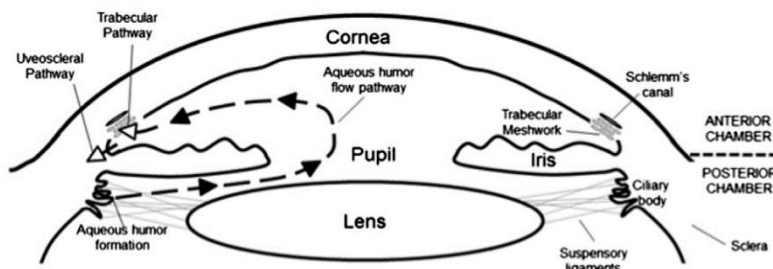

Figure 13: Aqueous humor outflow pathways
(adopted from Wallace et al. 2014)

the anterior chamber has to diffuse against the continuous drainage of the aqueous humor and therefore it is mostly rinsed and adsorbed in the anterior chamber (Figure 13) [82]. Therefore, topical instillations of drugs generally fail, when tissues in the posterior segment should be targeted.

Blood - retinal barrier:

The blood – retinal barrier (BRB) shields the ocular tissues to the systemic blood circulation. It can be divided into the inner and the outer BRB and it mainly hinders diffusion of bigger molecules from the systemic circulation into the retina [83,84]. This is the main barrier that limits systemic drug applications for ocular use because in sufficient concentrations the drugs do not reach their ophthalmic target in most cases.

Thus, the eye is a well-protected area within the human body by various barriers and drug targeting is difficult to achieve.

1.6.1.2. Routs of administration

Due to limited drug absorption of topically applied drug formulations, various other routes of administration were investigated to improve bioavailability (Figure 14) [85]. All of these alternative routes have advantages but limitations as well (Table 3) [79].

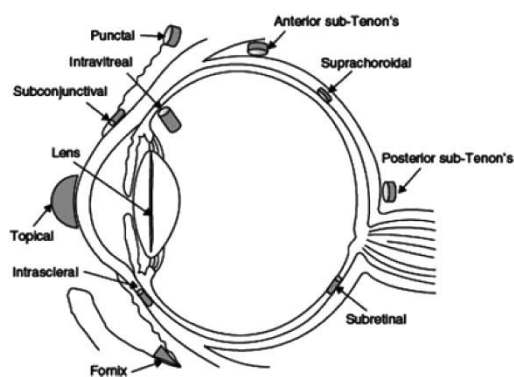

Figure 14: Scheme of various routes for ocular drug applications (adopted from Cima et al. 2014)

Table 3: Summary of some advantages and challenges of common routes for ocular drug delivery [79]

Route	Advantage	Challenge	Diseases
Topical	Compliance, non-invasive self-administrable	high tear dilute and turnover rate, various barriers, Bioavailability < 5%	keratitis, uveitis, conjunctivitis, scleritis, various others
Systemic/oral	Compliance, non-invasive self-administrable	BAB, BRB, systemic side effects, Bioavailability < 2%	inflammation of posterior parts
Intracameral	high drug doses less systemic side effects	toxic anterior segment syndrome	endophthalmitis, anesthesia
Intravitreal	direct release to vitreous and retina, circumvents BRB	retinal detachment, cataract, hemorrhage, endophthalmitis, incompliance	age-related macular degeneration, various others
Subconjunctival	depot formulations Release to anterior and posterior chamber	Conjunctival and choroidal circulation	Glaucoma, uveitis, various others
Retrolubar	low increase of intraocular pressure	Retrolubar hemorrhage, globe perforation,	Anesthesia

Systemic and topical applications persist as the most accepted dosage forms and experience high patient's acceptance, resulting in good compliance. In contrast, most of the other approaches are not for self-application and therefore quite inconvenient. However, by

intracameral or intravitreal drug administration, extended drug releases are possible which can vary between a few days to more than a couple of months.

Regarding all these challenges and disadvantages in ocular drug delivery, it would be adventurous, to have devices that deliver the drug directly at the targeted issue. Attributed to the fast wash out of topical drug instillation and the unfavorable drug distribution, followed by fast removal of active pharmaceutical compounds from the ocular tissues (Figure 15) [86], vehicles are required, which are directly at the “side of action”.

This is why different drug delivery systems were developed and investigated in order to achieve a more patient pleasant device that is able to avoid postoperative complications.

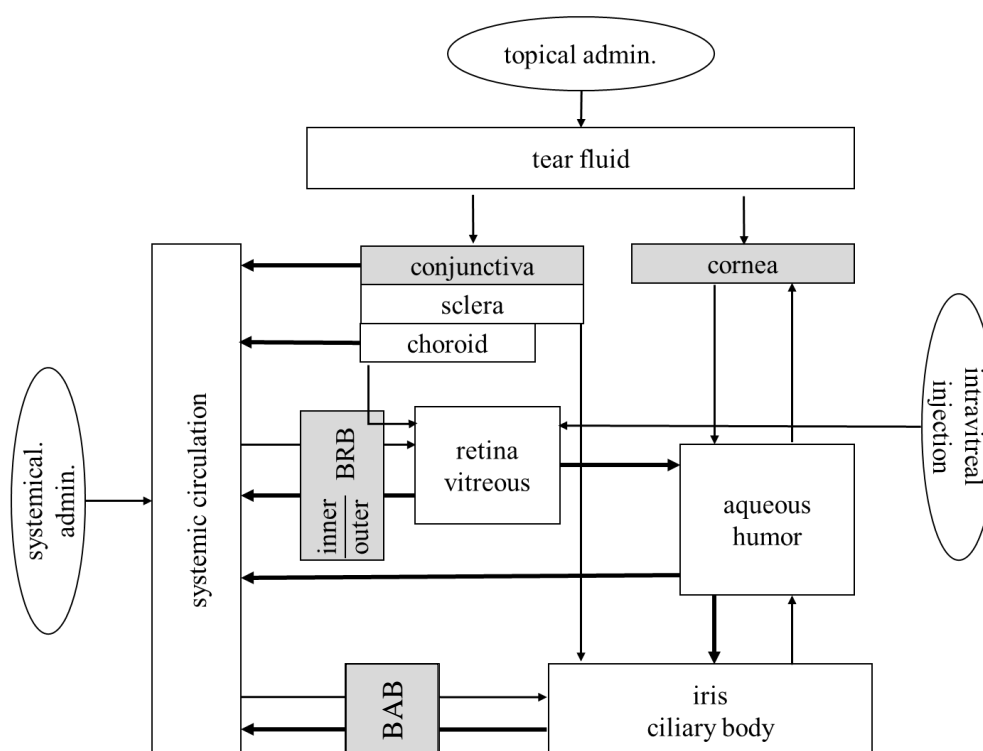

Figure 15: Drug distribution and penetration in ocular tissues after topical, systemical and intravitreal drug delivery; prominent elimination pathways are presented by bold arrows; barriers in ocular tissues have grey background
BRB: blood-retinal barrier; BAB: blood aqueous barrier
(adopted from Hornof et al. 2005)

1.6.2. Extended drug delivery to ocular tissues

In order to treat the posterior segments of the eyeball, injections are still the gold standard, however, this goes along with fast elimination, if just aqueous solutions are applied. Thus, intravitreal injections of “anti-vascular endothelial growth factor” treatments for age-related macular degeneration (AMG), have to be repeated every 4 – 6 weeks, resulting in an enormous

burden in patient's life [87]. Therefore, in previous decades, many companies tried to investigate ocular DDS, that release drugs for an extended time period with no/less side effects [87]. Here, the challenge is not to find new drugs, it is rather the goal to develop carriers/vehicles, which enables drug delivery of FDA approved drugs within the eyeball [88]. Thus, different DDS (Figure 16) [88–91] were investigated and approved by the FDA in the last years, whereas others are still in the clinical or even pre-clinical phase (Table 4) [92].

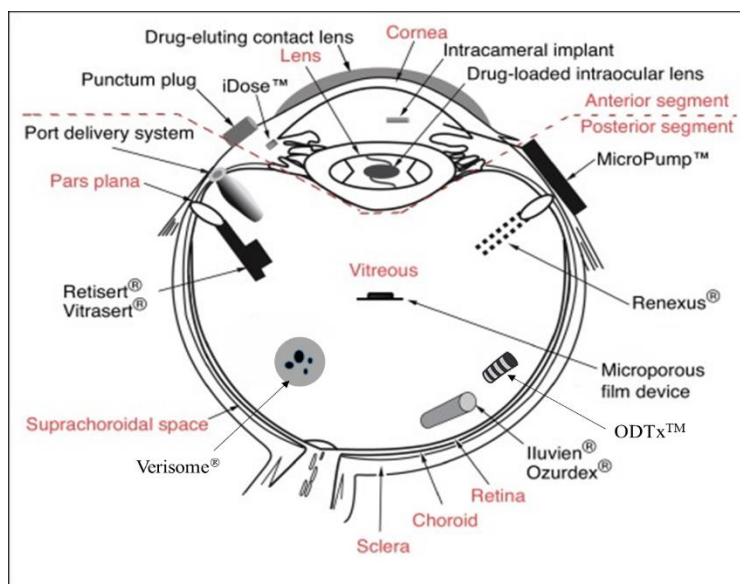

Figure 16: Schematic illustration of an eye, including a selection of various ocular drug delivery systems (adopted from Rupenthal et al. 2017)

All implants that are placed in the posterior segment of the eyeball need to be applied by professionals and in case of adverse effects, the removal is difficult and a second surgery is needed, followed by the risk of complications. Unfortunately, most of these implants are not biodegradable and therefore, a second surgery is needed anyway. Thus, Ozurdex® and other biodegradable implants are superior in comparison to the not degradable DDS [93,94]. Ozurdex® comprises PLGA and dexamethasone (700 µg) and releases the API over a period of 6 months. Other biodegradable polymers like “poly (ε-caprolactone)” are under investigation but not approved by the FDA yet [91,95].

Table 4: Ocular implantable drug delivery systems, approved by the FDA or in clinical/pre-clinical study [92]

Implant (Name)	Status	Explanation
Vitrasert	FDA approved in 1996	Non-biodegradable polymer implant, containing ganciclovir for the treatment of cytomegalovirus (CMV) retinitis. Releases drug for up to eight months
Retisert	FDA approved in 2005	Non-biodegradable polymer implant containing fluocinolone acetonide for the treatment of chronic non-infectious posterior uveitis. Releases fluocinolone for up to 2.5 years
Ozurdex (Posurdex [®])	FDA approved in 2009	First biodegradable polymer implant containing dexamethasone for the treatment of macular edema. Placed into the vitreous via a 22-gauge needle to release drug for up to six months
Iluven (Medidur [®])	FDA approved in 2014	Non-biodegradable implant containing fluocinolone acetonide for the treatment of diabetic macular edema. Inserted into the vitreous using a 25-gauge needle to release drug for up to three years
Brimonidine (intra vitreal implant)	Phase 2 clinical trials	Biodegradable implant releasing brimonidine for the treatment of dry AMD and retinitis pigmentosa for up to six months
Verisome [®]	Phase 2 clinical trials	Biodegradable DDS injected into the vitreous to form a small spherule. Can be used to deliver various types of drugs including proteins and releases drug for up to one year
Port delivery system	Phase 1 clinical trials	Non-biodegradable port delivery system (PDS) releasing ranibizumab for extended periods of time for the treatment of choroidal neovascularization. Unique design allows the system to be refilled and used again
Mini drug pump	Pre-clinical phase	Non-biodegradable system prepared from polydimethylsiloxane (PDMS) with a delivery check valve for release of a variety of drugs via an actuator based mechanism
ODTx	Pre-clinical phase	Highly impermeable laser activated non-biodegradable implant, consisting of multiple drug reservoirs, capable of delivering one or more drugs to the posterior segment of the eye to treat various conditions
ENV705 TM	Pre-clinical phase	Biodegradable implant containing bevacizumab/trehalose dispersed in a polymer matrix, capable of releasing effective therapeutic drug concentrations for up to six months

Ozurdex[®] is the most common and only FDA approved intraocular biodegradable implant. However, problems occurred such as wrong positioning of the implant and implant migration into the posterior segment of the eye [96–98]. Nevertheless, it was tried to combine the cataract surgery with an Ozurdex[®] injection in order to avoid postoperative inflammation, but it needed an additional step in the surgery and problems like implant migration persisted [97,99]. To overcome this issues, also topical inserts were investigated [94,100], but they still had limitations regarding bioavailability and even more by patient compliance.

Thus, DDS, that are attached to the intraocular lens would be highly beneficial, in order to avoid inappropriate location of implants and an additional injection step. Furthermore, the lens stays in the eye for the remaining patient’s life. Therefore, a later removal is not necessary, even when not biodegradable polymers are used.

1.7. Lenses as drug delivery systems

1.7.1. Contact lenses

Contact lenses have a long history, dating back to Leonardo da Vinci in the year 1508 A.D. More than 100 years later in 1636 A.D., René Descartes placed a liquid filled glass tube directly in contact with the cornea to improve vision. The outcome was terrible, but the name “contact lens” was born [101]. After more than 200 years, in 1887, Dr. Fick, a physician from Zurich made the first contact lens, which enabled contact lens wearers to blink. Since that time, the production technic, materials, shapes as well as the application improved a lot and contact lenses are considered as simple devices nowadays.

In the last years, contact lenses were contemplated as an ideal drug delivery system [102–105], because they are located directly at the eye, they remain at this tissues for a prolonged time and patients are used to the handling of this devices so that no additional training is required. Regarding the provided refraction correction of contact lenses, patients use it, resulting in good patients’ compliance.

Contact lenses and intraocular lenses are manufactured by similar materials and theoretically, most drug loading technics for contact lenses could be applied for intraocular lenses as well. Unfortunately, some major differences exist. The most important disparity appears in the time of application. Whereas the intraocular lens is inserted once and stays in the eye for the remaining patient’s life, mostly contact lenses are only used for 24 hours. Thus, release periods of one day or less are sufficient for contact lenses, because they can be replaced easily and a new drug-loaded lens could be administered [106–109]. Additionally, in case of negative side effects, drug delivery could be stopped immediately, by contact lens rejection. For contact lenses, it is also reasonable to use turbid lenses during the night to provide drug delivery and during the day, the device is simply removed to retain clear vision [110]. Regrettably, within the first weeks after a cataract surgery, contact lenses must not be applied on eyes. Therefore, drug-eluting contact lenses are no appropriate drug delivery devices to avoid postoperative complications, nevertheless, some approaches are adaptable to intraocular lenses.

1.7.2. Intraocular lenses

In the cataract surgery, the clouded natural lens is removed and replaced by an artificial intraocular lens. Those devices would be the perfect drug carriers because it could deliver directly at the tissues that are targeted. Since IOLs are not removed, they could be coupled with

various drug delivery systems including non-biodegradable ones and a later removal is not required. However, drug-loaded intraocular lenses are facing some specific challenges as well (Table 5).

Table 5: Benefits and challenges of drug-loaded intraocular lenses

Benefits	Challenges
- Patients compliance	- Conviction of the doctors
- Less postoperative complications	- Loading procedures
- Drug targeting	- Drug attachment to/into the IOLs
- Constant drug levels	- Sufficient drug loadings
- Prolonged release	- Prolonged release
- No systemic effects	- Transmittance of drug-loaded IOLs
- No additional surgery	- No changes in optical quality, such as refractive index, glistening, calcification
- No device removal	- Various different materials and shapes
- FDA approval as medical device is reasonable	- Stability of drug and IOLs

1.7.2.1. Approaches for producing drug-eluting IOLs

Different approaches were investigated to produce drug-loaded intraocular lenses (Figure 17) [111], however, loading methods can be divided into two main groups. Either, the drugs are loaded during the lens production or the API is incorporated or attached afterward.

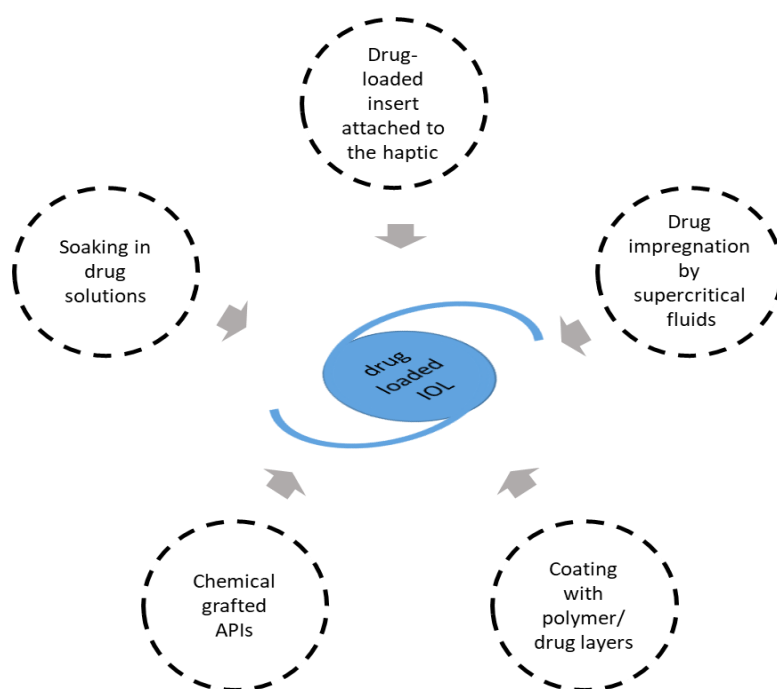

Figure 17: Loading approaches to prepare drug loaded IOL (adopted from González-Chomón et al. 2011)

So far, there is no commercialized drug-eluting intraocular lens on the market but many different formulations were already investigated in animal studies. For ophthalmics mostly, rabbits are used although there are some serious differences to the human eye. First, the blinking rate of rabbits is less, the total volume of the different compounds is different and therefore, the drug distribution is not identical to the human eye [112–114].

However, the rabbit is the most common animal model for ocular devices and benefits of drug-eluting intraocular lenses could be demonstrated (Table 6).

Table 6: Drug-loaded IOLs in experimental rabbit studies [115]

Authors	Drug and loading approach	Results
Chollet et al. [116]	Annexin V solution coating for 1 h	Less severe inflammation on the first postoperative day, and the inflammation resolved more quickly
Eperon et al. [95]	Drug delivery systems loaded with triamcinolone acetonide were threaded onto IOL haptic	On long-term observation (days 63 and 84), it significantly reduced postoperative inflammation
Garty et al. [117]	Polymers made of the mixture of norfloxacin and hydrogel were attached to IOL haptics	Sustained sufficient antibiotic concentrations for more than 4 weeks. The device was effective in treating induced intraocular infection
Kleinmann et al. [118]	IOL presoaked in solutions of gatifloxacin or moxifloxacin for 24 h	The antibiotic concentrations in presoaked IOLs group were statistically significantly higher than those in topical eye drops group for both antibiotics in all postoperative samples except moxifloxacin at 12 h
Kleinmann et al. [119]	IOL presoaked in solutions of gatifloxacin or moxifloxacin for 24 h	High concentrations of both antibiotics were found in all the samples of the eyes implanted with the presoaked IOLs
Kugelberg et al. [120]	IOL was presoaked in dexamethasone solution for 40 min	The PGE2 levels were significantly lower on day, 3 and 7 postoperatively, and the WBC count and protein were significantly lower on days 1 and 3
Liu et al. [121]	PLGA containing rapamycin was sprayed onto the edge of IOL optics	The initial appearance of PCO was much later and the wet weight of PCO was significantly lesser
Nishi et al. [122]	0.1 and 1.0% indomethacin coated IOLs	Aqueous flare intensity in eyes with 0.1% indomethacin-coated IOLs and in eyes with 1.0% indomethacin-coated IOLs was significantly less at day 2 and at day 2 and 3
Siqueira et al. [123]	IOL containing a biodegradable dexamethasone drug delivery system	It effectively delivered therapeutic concentrations of dexamethasone to the aqueous and vitreous, without acute damage to the cornea and retina
Tetz et al. [124]	IOL-bound sustained drug delivery system consisting of the carrier substance poly- DL -lactide and the drug daunorubicin	Slow release of daunorubicin reduced PCO formation by approximately 50%. Some endothelial cell loss
Tsuchiya et al. [124]	IOL immersed in 0.3 or 0.5% gatifloxacin and 0.5 or 1.5% levofloxacin solutions for 24 h	The bacterial populations in eyes were significantly smaller in the IOL group than in the control group through 3 days postoperatively. Preventive effects against endophthalmitis were similar between the IOL and intracameral groups

Abbreviations:

IOL: intraocular lens; PCO: posterior capsule opacification; PGE2: prostaglandin E2;

PLGA: poly(D, L-lactide-co-glycolide); WBC: white blood cell

As presented in the animal studies, the drug might be attached or incorporated into the lens materials by different methods and at different locations. Since, the drug could be coated on the whole device surface, or incorporated into the lens material. Additionally, small DDS could be attached to the IOLs which were prepared in a separate production step (Figure 18) [115], or in case of three-piece IOLs, the lens could be assembled by different parts, where some are drug-loaded and others not.

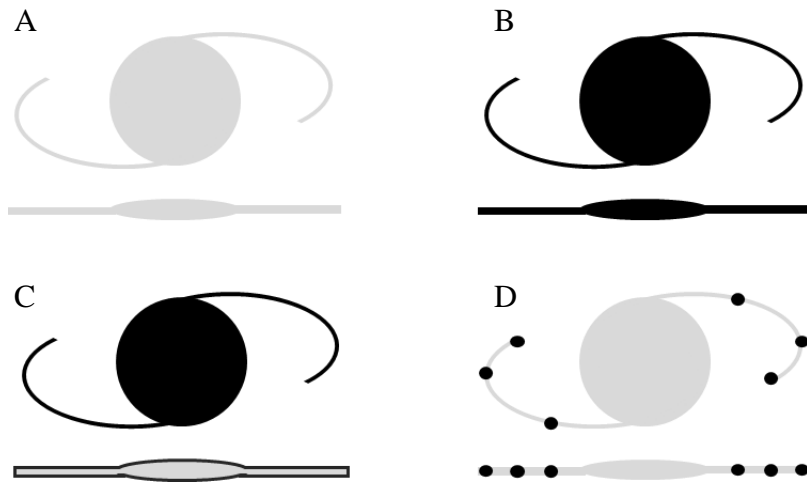

Figure 18: Possibilities for drug localization in intraocular lenses
 A: unloaded (blank) intraocular lens
 B: Surface coating of IOL
 C: Drug is incorporated in the complete polymer matrix
 D: Drug is attached at the haptic as separate DDS
 (adopted from Eibl-Lindner et al. 2015)

1.7.2.2. Inserts

A simple method to load intraocular lenses with the drug is to attach separate drug delivery systems to the haptic. Then, the optical area of the IOLs remains untouched and various production technics are reasonable (Figure 19) [95].

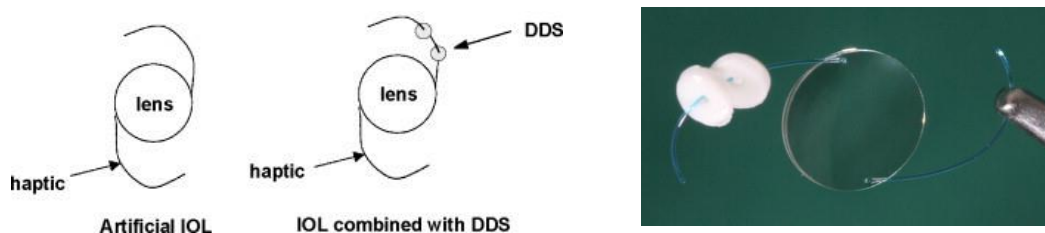

Figure 19: IOL with attached inserts
 A: Schematic illustration of an IOL, combined with separate DDS
 B: Image of an IOL, with a combination of DDSs
 (adopted from Eperon et al. 2008)

By hot melt extrusion or other technics small carriers comprising a specific amount of API could be prepared in “disc shape” with a central bore-hole to thread them on the haptic. Hence, increased drug loadings are achievable by using multiple DDS and even multiple drug loadings are reasonable, due to the combination of different API containing DDSs.

When these attachments are not biodegradable they remain in the eye and perfect biocompatibility has to be ensured [117] besides persistent device adhesion to the haptic in order to sustain a clear vision.

For ocular devices, PLGA revealed as ideal polymer for implants/inserts, due to its good biocompatibility and its decomposing properties. PLGA is an FDA approved polymer [125] and is already used in various other ocular devices such as Ozurdex[®] [126,127].

PLGA is a polymer of lactic and glycolic acid and is manufactured by the polymerization of the monomers or by ring opening polymerization of lactide and glycolide, the corresponding cyclic dimers (Figure 20). In this reaction, no water is created and longer PLGA chains can be obtained.

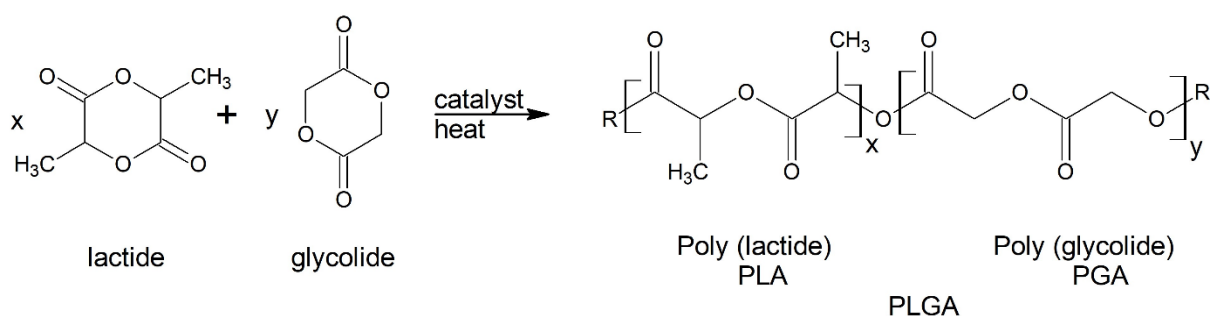

Figure 20: Synthesis of PLGA by ring opening copolymerization;
x and y represent the number of units of lactide and glycolide, respectively

PLGA (poly (D, L-lactide-co-glycolide)) decomposes by hydrolysis of ester bonds, also in absence of enzymes. The created lactic and glycolic acid are natural compounds and can be further eliminated by the body to CO₂ and H₂O by the cycle of Krebs [128]. The release period of PLGA is easy to modify by the polymer, such as the ratio of lactide and glycolide, the chain size or possible end-capping [129,130]. Also aspects like the API:polymer ratio, manufacturing process and drug localization within the DDS have impact on the drug release.

Besides PLGA, also other biodegradable polymers could be used, such as poly (orthoesters), poly (anhydrides), poly (amides), poly (esteramides), poly (phosphoester), poly(caprolactone), and chitosan [130–133]. Hyaluronic acid is present in the vitreous and could be used as the

polymer in drug delivery systems as well, but due to its water solubility, the drug release would be faster [134].

1.7.2.3. Copolymerization

Another method to prepare drug-loaded lenses is the “copolymerization” method. Lenses are prepared normally by bulk polymerization and the solidified polymers are processed to shape out lenses.

Drugs and other additives could be added to the mixture of monomers prior to polymerization and the drug is incorporated into the lens matrix by that process [105,110,135]. This is simple but major challenges have to be overcome such as solubility of the drug in the monomers and polymers to provide a homogeneous drug distribution within the finalized lenses as well as drug stability during polymerization. Thus, the drug should not have “unprotected” double bonds to avoid covalent bonding and also stability in increased temperatures during polymerization needs to be guaranteed. Furthermore, it is imperative, that the API must not have adverse effects on the final polymer matrix to retain perfect optical properties. Thus, the number of drugs, approachable by this method, is limited. However, the biggest challenge is the purification of the polymer from the remaining process residuals, without removing the active pharmaceutical ingredient [136].

1.7.2.4. Soaking

The most common method to prepare drug-loaded intraocular lenses is the soaking method [118,137–140]. In this procedure, the lenses are placed in a drug solution with specific conditions and the lens polymer function like a sponge [106,141]. During soaking, drugs might diffuse into the lens material and after the lens injection into the capsular bag, the drugs are release out of the polymer matrix again.

By this method, mostly water is used as soaking media in order to facilitate the drug loading directly before the surgery takes place. Unfortunately, just water-soluble drugs and only hydrophilic poly (meth-) acrylates are accessible by that method, caused by the low water content of the other lens types. Only hydrophilic (meth-) acrylates form hydrogels and can retain water in contents of 15 – 50%. Hydrogels are “three-dimensional“ networks, which adsorb water in large amounts but do not dissolve because they are cross-linked [58,142,143]. Regarding the soft nature and the high water content, hydrogels resemble human living tissues

better than other synthetic materials, followed by good biocompatibility [144]. Hydrogels can be prepared by many different techniques and with various characteristics, but due to the use as an intraocular lens, possibilities for polymer modifications are limited [145–147]. The most common used monomer for hydrogels is 2-hydroxyethyl methacrylate, which is also the main compound for hydrophilic intraocular lenses [147].

The mechanism of drug release in the human body depends mainly on the hydrogel characteristics and the API but in general, drug release from hydrogels can be divided into four groups: diffusion controlled, swelling controlled, chemically controlled and environmentally controlled. Since hydrophilic intraocular lenses are usually implanted as swollen hydrogels without special functional groups, the release is usually purely diffusion-controlled. When the drug diffuses to the surfaces and is released, also drug partition of the lens and the surrounding tissues needs to be taken into account, but in most cases, that is not the time-limiting step.

To improve this method and to make it assessable also for hydrophobic drugs and more hydrophobic lens materials, organic soaking media could be used [148–151] to increase the amount of dissolved drug and to increase swelling of lens materials, followed by higher drug loadings. Unfortunately, organic solvents have to be removed prior lens injection and additional production steps need to be validated. Additionally, just soaked hydrogels are flexible, due to the plasticizing effect of water. Therefore, before the lens can be injected in a folded way, rehydration needs to be performed, which could go along with a premature drug release. In order to avoid that, drug-loaded lenses were inserted in a dry condition so that lenses swelled within the eye [152], but that led to increased incisions which were needed for the lens insertion.

To avoid organic solvents during soaking procedures, supercritical carbon dioxide was used, to improve drug loading techniques [153,154]. However, in most cases, the optical quality of intraocular lenses decreased remarkably.

Therefore, soaking methods were mostly performed successfully with hydrophilic drugs and hydrogels, due to improved drug diffusion within the lens matrix as well, attributed to the high water contents. Unfortunately, the increased water uptake of hydrogels and the high water solubility of these APIs also accelerated the drug diffusion after the lens injection, resulting in very fast drug release periods of mostly just 1-2 days [118,137,138].

1.7.2.5. Coating

Coating approaches are simple methods to modify the lens surfaces and to provide drug-eluting intraocular lenses [34]. The first heparin coated lens was applied in 1979 and could reduce inflammation because the lens surface was changed from hydrophobic to hydrophilic [155,156] and therefore, less cell adhesion took place. Also, other coatings were investigated to change surface modifications such as polyethylene glycol, phosphorylcholine and pyrrolidone coatings [34]. Those very thin coatings also sustain foldability and have no adverse effects on optical properties [157], whereas thicker coatings, containing also APIs, might decrease the transparency of IOLs extremely and restrict foldability.

Many different approaches were investigated to prepare drug-eluting IOLs by coating technics [121,122,158] and most of them either coated just the haptic or like recently, the coating was applied at the complete lateral surface of the lenses [159]. The total mass of an IOL is approximately 20 mg. Therefore, when just the haptic is coated, only a very small amount of polymer and surface area is assessable for drug coatings, resulting in low drug loadings. Nevertheless, API was engaged to the haptic by API filled bore-holes, coatings or even complete entrapped DDS within the polymerized polymers [160]. In case of drug coating at the lateral surface, just commercialized hard lenses were used because coatings would prevent foldability. Thus, both approaches are reasonable but have significant limitations.

Recently (2015), a specific drug eluting member was patented that could be engaged to parts of the lens optic after lens preparation but foldability could not be retained anyway [161].

1.8. Research Objective

The objective of this research was the development of drug-loaded intraocular lenses with extended drug release.

Therefore, intraocular lens polymers needed to be prepared, which resemble commercialized IOLs. Regarding the countless different formulations on the market, IOLs were divided in hydrophilic, hydrophobic and amphiphilic (meth-) acrylic intraocular lenses and for all types, loading approaches should be investigated. All loading methods needed to be improved in respect to drug loading and release.

Attributed to the simultaneous instillation of antibiotics and steroids after a cataract surgery, dual drug loading of IOLs was desired, which would release both drugs with different release profiles at the same time.

IOLs are optical devices and perfect optical properties had to be ensured all the time such as transmittance and refractive index.

2. Materials and methods

2.1. Materials

2.1.1. Monomers & excipients for polymerization

Methacrylate:

Butyl methacrylate (BMA) (Merck KGaA, Darmstadt, Germany)

Hydroxybutyl methacrylate (HBMA) (Sigma Aldrich, St Louis, Missouri, USA)

2-Hydroxyethyl methacrylate (HEMA) (Merck KGaA, Darmstadt, Germany)

Isobutyl methacrylate (IBMA) (Alfa Aesar, Haverhill, Massachusetts, USA)

[2-(Methacryloyloxy) ethyl] trimethyl-ammonium chloride (80% (w/w) in H₂O) (Sigma Aldrich, St Louis, Missouri, USA)

Methyl methacrylate (MMA) (Merck KGaA, Darmstadt, Germany)

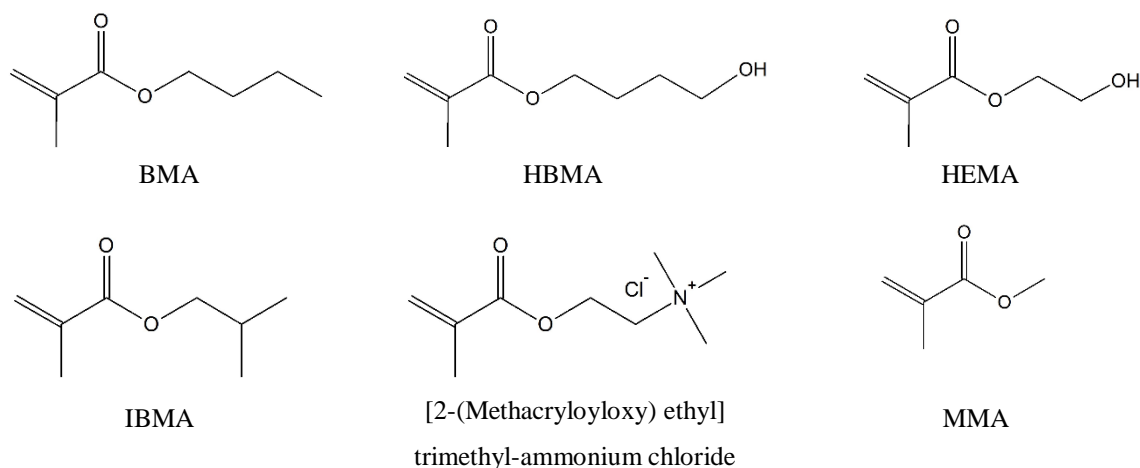

Figure 21: Methacrylates as monomers

Acrylate:

Ethyl acrylate (EA) (Merck KGaA, Darmstadt, Germany)

Ethylene glycol phenyl ether acrylate (Sigma Aldrich, St Louis, Missouri, USA)

Synonym: Phenoxy ethyl acrylate (POEA)

2-Hydroxyethyl acrylate (HEA) (Alfa Aesar, Haverhill, Massachusetts, USA)

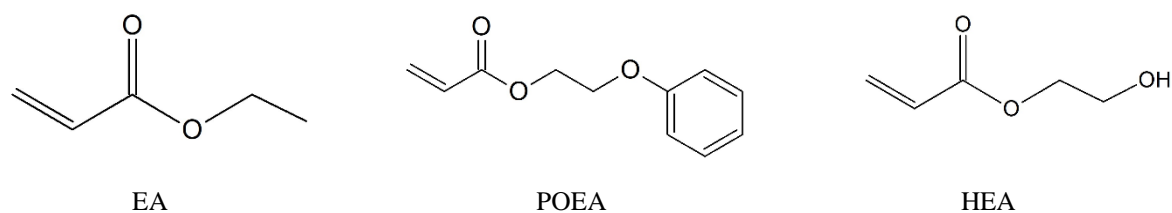

Figure 22: Acrylates as monomers

Initiator & cross-linker:

Benzoyl peroxide (BP) (Merck KGaA, Darmstadt, Germany)

Ethylene glycol dimethacrylate (EDMA) (Merck KGaA, Darmstadt, Germany)

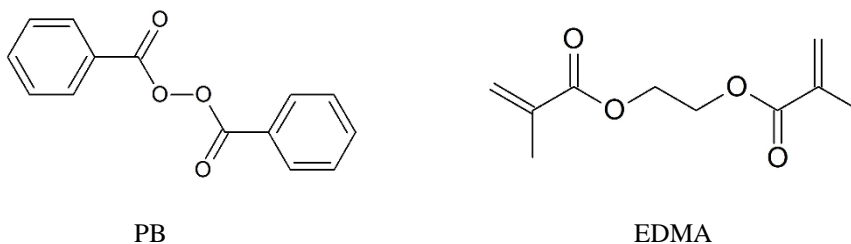

Figure 23: Thermal initiator and cross-linker for polymerization

Water:

Ultrapurified water purified by a Milli-Q[®] - apparatus (Millipore GmbH, Darmstadt, Germany)

Containers:

Crimp neck vials (Th Geyer GmbH & Co.KG, Renningen, Germany)

Flang caps with bore-hole (Carl Roth GmbH + Co KG, Karlsruhe, Germany)

Micro-centrifuge tubes with attached caps (0.65 ml) (VWR International GmbH, Dresden, Germany)

Multi[®] –Safeseal[®] Tubes, natural (2.0ml) (Carl Roth GmbH + Co KG, Karlsruhe, Germany)

2.1.2. APIs

Dexamethasone (Fagron GmbH, Barsbüttel, Germany)

Diclofenac sodium (BASF, Ludwigshafen, Germany)

Diclofenac acid was prepared by precipitation of diclofenac

Minocycline (Zhejiang Hisun Pharmaceutical Co., Ltd., Taizhou, China)

Propranolol hydrochloride (K.-W. Pfannenschmidt GmbH, Hamburg, Germany)

Risperidone (Wuxi Jida Pharmaceutical Co. Ltd, Yunnan, China)

Sodium salicylate (Merck KGaA, Darmstadt, Germany)

Theophylline (BASF, Ludwigshafen, Germany)

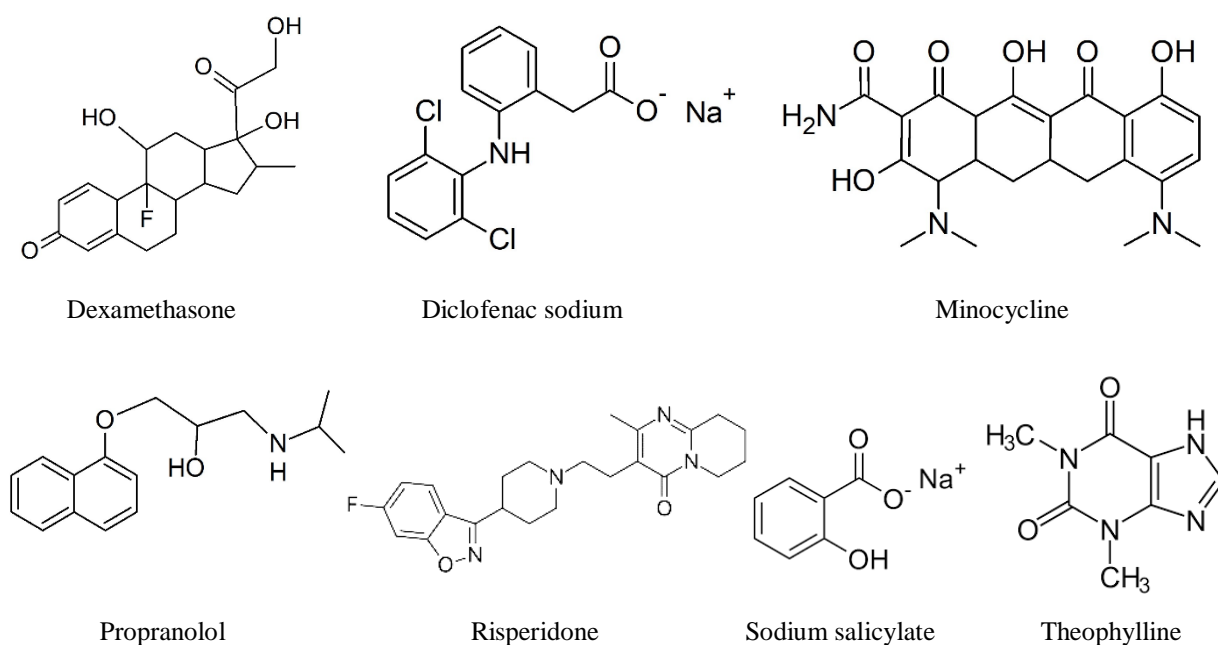

Figure 24: Chemical structures of APIs, used in this thesis

Dyes (used as model APIs)

Methylene blue (Merck KGaA, Darmstadt, Germany)

Phenol red (Merck KGaA, Darmstadt, Germany)

Quinoline yellow (Fagron GmbH, Barsbüttel, Germany)

2.1.3. Salts, to prepare artificial aqueous humor

Di-sodium hydrogen phosphate dodecahydrate (Merck KGaA, Darmstadt, Germany)

Potassium dihydrogen phosphate (Carl Roth GmbH + Co KG, Karlsruhe, Germany)

Sodium chloride (Carl Roth GmbH + Co KG, Karlsruhe, Germany)

2.1.4. Solvents

Acetone (VWR International GmbH, Dresden, Germany)

Chloroform (Carl Roth GmbH + Co KG, Karlsruhe, Germany)

Ethanol (Carl Roth GmbH + Co KG, Karlsruhe, Germany)

Ethyl acetate (Fisher Scientific GmbH, Schwerte, Germany)

Methanol (VWR International GmbH, Dresden, Germany)

n-Hexane (Merck KGaA, Darmstadt, Germany)

2 – Propanol (VWR International GmbH, Dresden, Germany)

Hydrochloric acid 0.5 N (Carl Roth GmbH + Co KG, Karlsruhe, Germany)

2.1.5. Polymers

Ethyl cellulose (Ethocel standard 45 premium, Colorcon, Dartford, Great Britain)

Poloxamer 188 (Kolliphor® P 188, BASF, Ludwigshafen, Germany)

PLGA 5050 DLG 1A (Lakeshore, Birmingham, Alabama, USA)

PLGA 502 H (Resomer RG 502 H, Evonik Industries AG, Darmstadt, Germany)

PLGA 503 H (Resomer RG 503 H, Boehringer Ingelheim Pharma KG, Ingelheim, Germany)

PLGA 504 (Resomer RG 504, Evonik Industries AG, Darmstadt, Germany)

2.1.6. Instruments

ABBE refractometer (Carl Zeiss AG, Oberkochen, Deutschland)

Axioscope optical light microscope (Carl Zeiss Jena GmbH, Jena, Germany) with image analysis software (EasyMeasure, Inteq Informationstechnik GmbH, Berlin, Germany) coupled with a xiocam 105 color camera and ZEN software (Carl Zeiss Microscopy GmbH, Jena, Germany)

Basic pH meter PB – 11 (Sartorius, Göttingen, Germany)

Balance Acculab Vic-303 (Sartorius Group, Goettingen, Germany)

Dnt DigiMicro Lab 5.0 Digital microscope (dnt Drahtlose Nachrichtentechnik, Dietzenbach, Germany)

DSC 6000 (PerkinElmer, Inc. Waltham, MA, USA)

FEI Quanta 200 scanning electron microscope (FEI, Hillsboro, USA) at 15 kV

Inkubation shaker (refrigerated incubation shaker, New Brunswick scientific GmbH, Nürnberg, Germany)

Magnetic stirrer (IKA®-Werke GmbH & Co KG, Staufen, Germany)

Mettler Toledo MX5 microbalance (Mettler Toledo, Greifensee, Switzerland)

Metrohm pH meter (Metrohm Ltd., Herisau, Switzerland)

Milli Q® (Millipore Corporation, California, USA)

Oven (Heraeus T6030, Hanau, Germany)

Osmomat 3000 (Gonotec, Berlin, Germany)

Sartorius Extended ED 124 S balance (Sartorius, Sartorius AG, Göttingen, Germany)

Steam-sterilizer S 2000 (Antonio Matachana SA, Barcelona, Spain)

Thermohygrometer Testo 625 (Testo SE & Co. KGaA, Lenzkirch, Germany)

Texture Analyser (TA.XT plus, Stable Micron Systems, Winopal Forschungsbedarf GmbH, Ahnsbeck, Germany)

UV-Vis spectrometry (Agilent HP 8453, Agilent Technologies Inc., Santa Clara, US).

Vacuum oven (Heraeus VT 5042 EKP, Hanau, Germany) coupled with a chemistry hybrid a vacuum pump (Vacuubrand GmbH, Wertheim, Germany)

2.1.7. Others

Electronic digital Calliper (Owim GmbH & Co. KG, Neckarsulm, Deutschland)

Engraving pen PMGS 12 B2 (Parkside GmbH, Dallgow-Döberitz, Germany)

Microscope slides (VWR International GmbH, Dresden, Germany)

Omnifix[®] Syringes (3ml) (B. Braun Melsungen AG, Melsungen, Germany) equipped with BD

Microlance 3 (BD, Heidelberg, Germany)

Screw caps (Carl Roth GmbH + Co KG, Karlsruhe, Germany)

Screw neck vials (20ml) (Carl Roth GmbH + Co KG, Karlsruhe, Germany)

Spray gun (Walther, Wuppertal, Germany)

Stirring bars (20mm x 6 mm) (VWR International GmbH, Dresden, Germany)

2.2. Methods

2.2.1. Lens preparation

Intraocular lenses were prepared by bulk polymerization of various monomers in different ratios. Therefore, the liquid compounds were mixed in order to get a homogeneous solution, benzoyl peroxide was added, dissolved and afterward, the whole blend was degassed for 10 minutes by purging with N₂ gas (Figure 25). In all formulations, ethylene glycol dimethacrylate was used as cross-linker and benzoyl peroxide as a thermal initiator in contents of 0.5% (w/w).

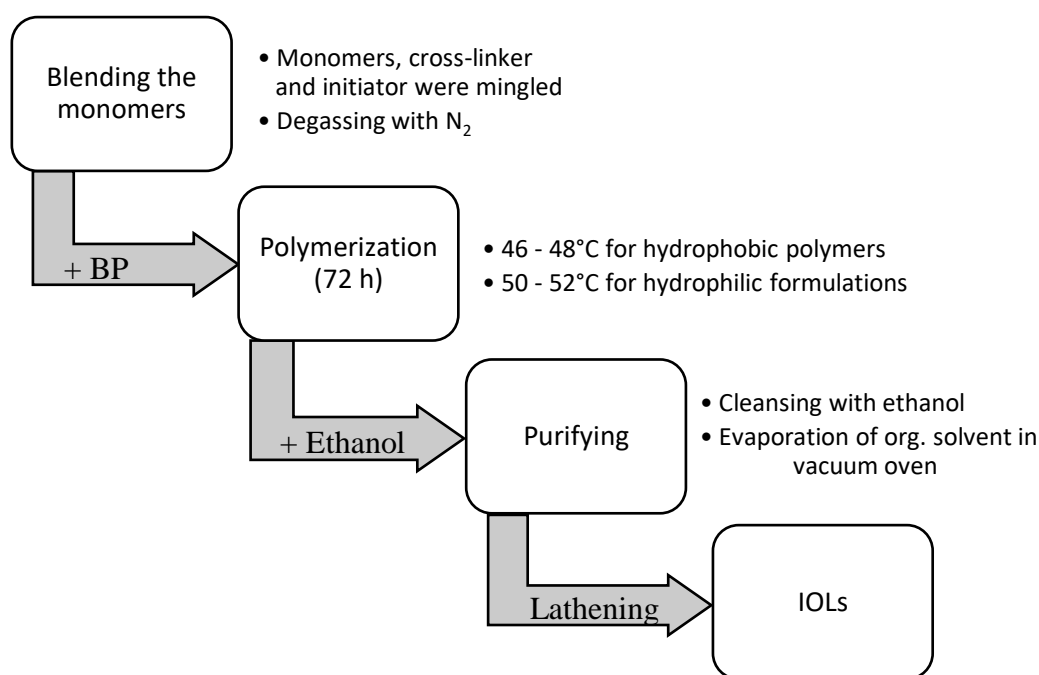

Figure 25: Intraocular lens preparation

The prepared mixture of monomers was cast into glassy crimp neck vials in case of hydrophobic compositions and micro-centrifuge tubes when the formulation was primarily hydrophilic. The polymerization containers were sealed and placed for 72 hours in a pre-warmed oven at approximately 47°C for hydrophobic and 51°C for hydrophilic polymers, respectively. These temperatures were selected accordingly to the literature [162–164]. To finish polymerization, the oven was heated to 70°C for 1 hour. The solidified polymers were stored in ethanol for 24 hours to remove remaining process residues, such as monomers, unused cross-linker, and initiator. Afterward, polymer rods were removed, remaining ethanol was dabbed off and polymer bars were dried in a vacuum oven at room temperature. The polymers were weighted regularly and taken out when no evaporation took place anymore. Hydrophobic and amphiphilic

formulations were cut to shape out lenses directly after purifying step. Hydrophilic polymers were kept immersed in purified water for 1 week, to make them soft and flexible. Then, the polymer rods were sliced into small lenses and polished. Lenses had a diameter of 6 mm, a height of approximately 0.7 mm and an average weight of 20 mg.

To produce hydrophilic lenses with an extended polymer meshwork, Milli Q[®] water was added to the liquid compounds prior to polymerization. Apart from that, polymerization and purifying were conducted as described above.

Table 7: Monomer compositions of lens formulations

Formulation	Hydrophilic (% w/w)	Hydrophobic (% w/w)
1	HEMA (100)	-
2	HEMA (80)	MMA (20)
3	HBMA (20)	BMA (10) IBM (10) EA (60)
4	HEMA (13)	POEA (17) EA (70)
5	HEA (20) HBMA (20)	BMA (19) POEA (2) EA (39)
6	-	MMA (20) EA (80)
7	-	MMA (100)
8	-	POEA (100)

Lens formulations 1 – 2 were considered as hydrophilic, formulation 3 – 5 as amphiphilic and the last three as hydrophobic polymers respectively (Table 7). Hydrophilic lenses were hard and brittle in unhydrated condition in contrast to the amphiphilic lenses which had elastic properties even in the dry state. Pure PMMA (Plexiglas) (formulation 7) is also inflexible whereas formulation 6 and 8 were foldable. Formulation 1, 2, 4, 7 and 8 are common materials in IOLs production [45,162,165].

2.2.2. Lens characterization

2.2.2.1. Chemical/physical properties

2.2.2.1.1. Water uptake

Lenses were accurately weighed, placed in flasks containing 5 ml artificial aqueous humor (phosphate buffer, pH 7.21, 13.485 g KH_2PO_4 and 85.414 g $\text{Na}_2\text{HPO}_4 \times 12 \text{H}_2\text{O}$ in 5 l purified water) which were stored in an incubation shaker (refrigerated incubation shaker, New Brunswick scientific GmbH, Nürnberg, Germany) at 37°C and 80 rpm. At predetermined time points, IOLs were removed, surfaces gently dried with absorbent tissue and re-weighed. The water uptake was calculated as follows:

$$\text{Water uptake}(\%) = \frac{W_{\text{wet}} - W_{\text{dry}}}{W_{\text{dry}}} \times 100 \quad \text{Eq 1}$$

where $W_{(\text{wet})}$ is the mass of the soaked lens and $W_{(\text{dry})}$ the mass of the initial dry lens respectively.

2.2.2.1.2. Wetting angle/ contact angle

To measure the wetting angle, lenses were located horizontally on a plane surface and one drop (3 μl) purified water was placed in the middle of the lens. Pictures of the droplets were taken 5 seconds after administration with a macroscopic camera (Inteq Informationstechnik GmbH, Berlin, Germany), equipped with an image analyses software (EasyMeasure, Inteq Informationstechnik GmbH, Berlin, Germany). The contact angle was measured between the lens and the droplet (Figure 26).

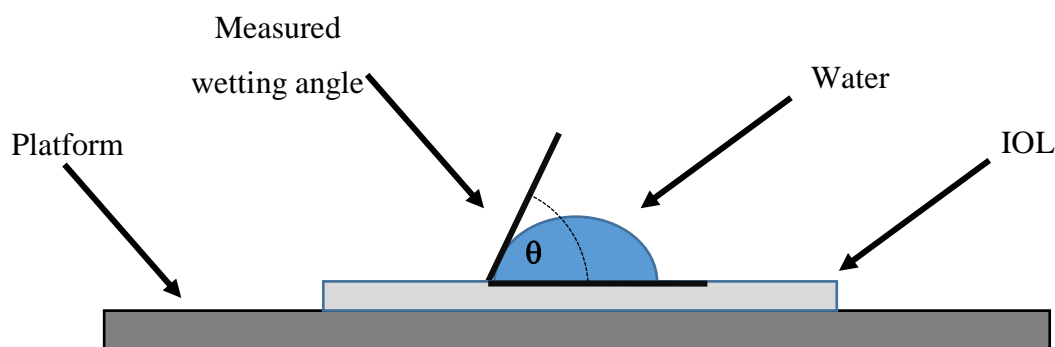

Figure 26: Contact angle measurement

2.2.2.1.3. Foldability

Since foldability is important for the injection of IOLs through small incisions within the cornea, foldability studies were performed by a texture analyzer (TA.XT, Stable Microsystems, Germany). Hence, IOLs ($n = 3$) were placed horizontally in a texture. A cylindrical probe (diameter 2 mm) touching the surface of the lens was moved downwards with a speed of 4 mm/min for a distance of 6.5 mm and the force (N) required to bend the lens was measured. When the applied force exceeded 5 N, the measurement stopped automatically (Figure 27).

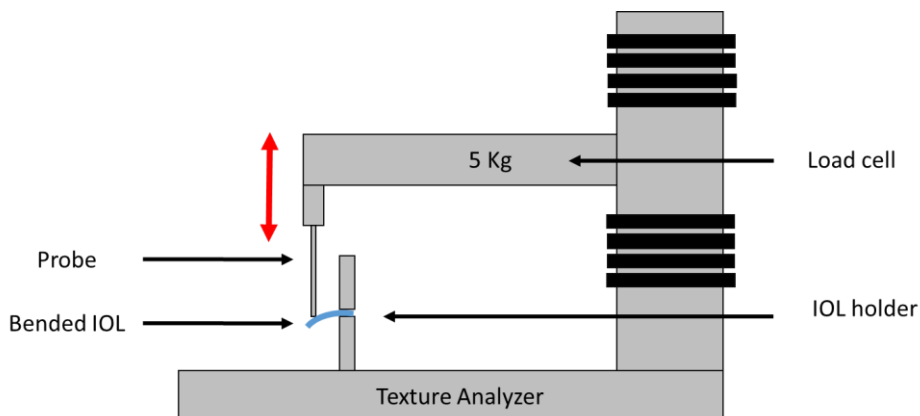

Figure 27: Schematic illustration of texture analyzer assembly to measure IOL foldability

2.2.2.1.4. Scanning electronic microscopy (SEM)

SEM pictures were recorded by FEI Quanta 200 scanning electron microscope (FEI, Hillsboro, USA) at 15 kV. That fore, lenses were dried, placed on a holder and sputtered with gold prior to recording the images. Pictures were recorded with a magnification of 1000 or 15000 times.

2.2.2.1.5. Differential scanning calorimetry (DSC)

Thermograms of lenses were recorded using a differential scanning calorimetry (DSC 6000, PerkinElmer Inc., Waltham, MA, USA). Accurately weight lenses were placed in 50 μ L aluminum pans with pierced lids. The heating rate was 10°C/min and DSC scans were recorded from 25°C to 290°C due to degrading polymer at higher temperatures. Each sample ran two cycles.

2.2.2.1.6. FT-IR

Fourier transform infrared spectra were generated with an Excalibur 3100 FTIR spectrophotometer (Varian Inc., Palo Alto, USA). Lenses, API, and recipients were placed on a horizontal ATR accessory containing a single reflection diamond crystal (Pike Miracle, Pike

Technologies, Madison, USA). 32 scans with a resolution of 4 cm⁻¹ were averaged by the supplied Varian software (Resolution Pro 4.0). A 13- point smoothing function was applied for all spectra.

2.2.2.1.7. Het-Cam test (hens egg test-chorio-allantoic membrane)

Fertilized eggs of *Gallus gallus domesticus*, cultivated variety “New Hampshire”, were incubated for 10 days in an incubation shaker (refrigerated incubation shaker, New Brunswick scientific GmbH, Nürnberg, Germany) at 37°C and approximately 62% relative humidity [166][136]. The temperature and humidity were checked externally by a thermohygrometer (Testo 625, Testo SE & Co. KGaA, Lenzkirch, Germany) and eggs were turned twice a day. At the 10th day, the eggs-shell was pared of gently by an engraving pen (PMGS 12 B2, Parkside GmbH, Dallgow-Döberitz, Germany) equipped with a circular saw and some forceps to reveal the highly vascularised chorioallantoic membrane. Lenses were placed directly on the membrane and the time of occurring hemorrhage, lysis and coagulation within 5 minutes were recorded.

2.2.2.2. Optical properties

2.2.2.2.1. Refractive index

Refractive index was analyzed by placing the lenses in a temperature controlled (37°C) ABBE refractometer (Carl Zeiss AG, Oberkochen, Deutschland). Surfaces were wetted by one drop of artificial aqueous humor and measurements were conducted.

2.2.2.2.2. Transmittance

Transmittances of lenses were investigated with a UV-Vis spectrometer (Agilent HP 8453, Agilent Technologies Inc., Santa Clara, US). The lenses were placed in a water-filled temperature controlled cuvettes, lenses were targeted by the light beam and spectra were recorded from 200 nm – 900 nm (Figure 28).

The background was recorded by the same setup, except in absence of the IOLs.

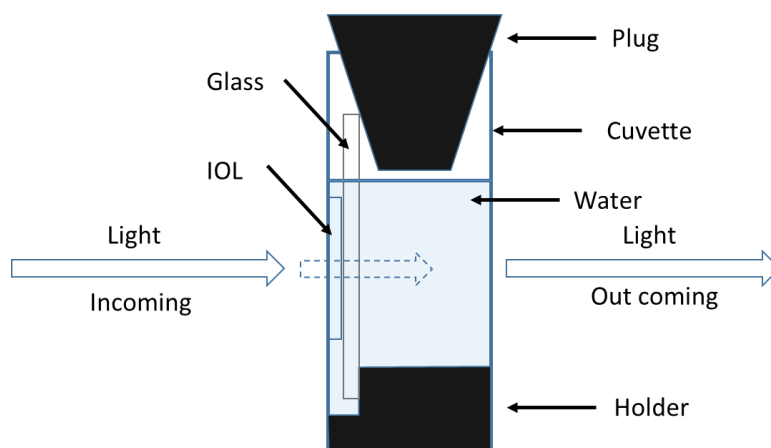

Figure 28: Lens placement in transmittance measurement

2.2.2.2.3. Glistening

Glistening is the formation of small liquid (water) filled bubbles within the lens material. Vacuoles are in the range of 1-30 μm normally [42–44,167–170]. To investigate IOLs regarding glistening, lenses were observed under a microscope (Axioscope optical light microscope, Carl Zeiss Jena GmbH, Jena, Germany) with image analysis software (EasyMeasure, Inteq Informationstechnik GmbH, Berlin, Germany) and also coupled with an xiocam 105 color camera and ZEN software (Carl Zeiss Microscopy GmbH, Jena, Germany) in normal settings as well as against dark field. Glistening could be observed at light scattering surfaces within the IOLs.

2.2.2.2.4. Morphology / Macroscopic pictures

Intraocular lenses were observed using a macroscope (Inteq Informationstechnik GmbH, Berlin, Germany). The magnification was adjusted to obtain a clear observation. The images were recorded by image analysis software (EasyMeasure, Inteq Informationstechnik GmbH, Berlin, Germany).

2.2.3. Drug loading

Different approaches are possible, to produce drug-loaded intraocular lenses [111]. All methods can be divided into two sections. At first, lenses can be loaded during production, secondly, the API is loaded into or on the lens matrix or haptic afterward.

2.2.3.1. Soaking

The soaking method is the simplest procedure to gain drug-eluting intraocular lenses. Therefore, innocent lenses are placed in a specific amount of drug solutions with define concentration and are kept immersed for a specific time. If not mentioned differently, the soaking time was set 24 hours at 37°C. When the soaking solution is water, lenses might be applied immediately after this loading procedure. If organic liquids as soaking solutions were used, a purification step had to be applied. In this case, the IOLs were removed from the soaking solvent, remaining media was dabbed off with a soft adsorbed tissue and lenses were dried in a vacuum oven (Heraeus VT 5042 EKP, Hanau, Germany) coupled with a chemistry hybrid vacuum pump (Vacuubrand GmbH, Wertheim, Germany) at room temperature. Lenses were removed, when no evaporation took place anymore. Therefore, lenses were weighted regularly and stored in a vacuum oven as long as a decrease in weight was detectable. After 144 hours the lenses were considered as dry. By this loading procedure, the lenses were cleansed from remaining monomers, initiators and unused cross-linker simultaneously.

When water was used as soaking media, also freeze drying (Alfa® 2–4 LD Plus freeze-dryer, Martin Christ Gefriertrocknungsanlagen GmbH, Osterode am Harz, Germany) could be conducted. Lenses were frozen at -80°C and the lyophilization was performed at -30°C and 0.18 mbar for 72 hours.

2.2.3.2. Copolymerization

Prior polymerization, the API was added and dissolved within the blend of monomers, cross-linker, and thermal initiator. Polymerization was carried out for the whole mixture as described in 2.1.1.

2.2.3.3. Coating

Coatings were applied in solutions or suspensions on the whole lens, the haptic or just the lateral surface of the IOLs. Coating media comprised the liquid phase, a polymer and in the majority of cases a drug.

2.2.3.3.1. IOL coating

Spray coating process for PMMA and hydrophilic lenses was conducted in a self-build rotor mini coater (Figure 29). Ethyl cellulose (6% (w/w)) and propranolol hydrochloride (3% (w/w)) were dissolved in the coating solution, comprising isopropanol (88%) and water (12). The coating solution was sprayed into a chamber, containing the lenses, with a rotating pan at the ground.

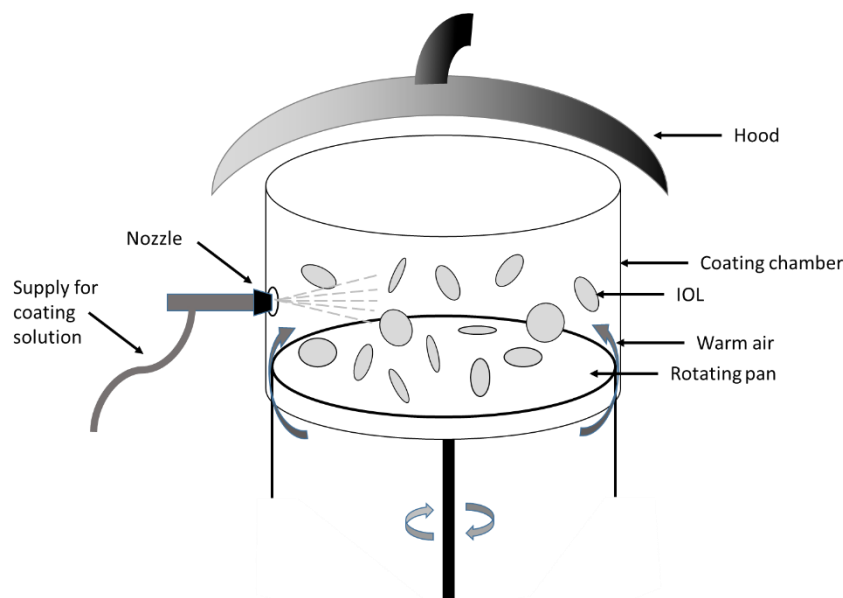

Figure 29: Self-made pan coating device

The process was performed with a batch size of 15 g, a nozzle of 1 mm, atomizing air pressure of 1.5 bar and a spray rate of 0.5 g/min. Warm air (55°C) was provided through a small slit around the twisting pan. The gained weight was calculated by the following equation.

$$\text{Weight gain (\%)} = \frac{\text{Weight of coated IOLs} - \text{Weight of uncoated IOLs}}{\text{Weight of uncoated IOLs}} \quad \text{Eq. 2}$$

2.2.3.3.2. Haptic coating

To resemble common haptic materials, PMMA fibers with a diameter of 0.5 mm and fluorocarbon fibers of 0.25 mm in diameter were coated by the same coating solution as described in 2.2.3.3.1. The coating was applied by dipping the fibers into the coating solution shortly. Prior to the next coating, drying was ensured. This procedure was performed 20 times.

2.2.3.3.3. Lateral surface coating

To avoid coating in the optical area of the lens, drug coating solutions/suspensions were applied just at the lateral surface of the lenses (Figure 30) Coating suspensions/solutions were prepared with batch sizes of 1 ml. API and PLGA were weight precisely in small vials and dispersed/dissolved in ethyl acetate. The containers were sealed with flanged caps with a borehole and a septum of rubber/ TEF.

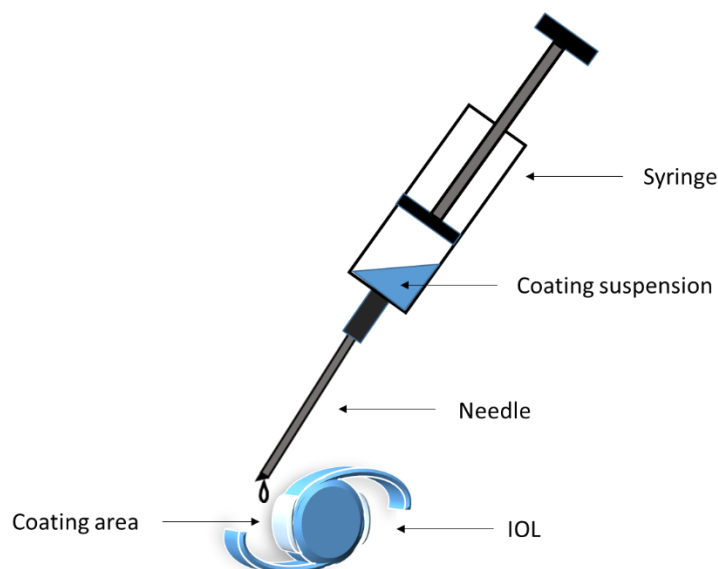

Figure 30: Schematic illustration of drop coating process

Lenses were fixed on a holder and coatings were applied drop by drop on the lateral surface of the lenses with a syringe (Omnifix® Syringes (3ml), B. Braun Melsungen AG, Melsungen, Germany) equipped with a BD Microlance 3 (BD, Heidelberg, Germany). Between dropping, drying was ensured. This procedure was executed until the desired coating level was achieved. Lenses were placed under the hood for 24 hours and afterward in the vacuum oven at room temperature to evaporate the remaining solvent.

2.2.4. Drug release

2.2.4.1. Artificial aqueous humor

To mimic the environment within the human eye for drug release, an artificial aqueous humor (pH 7.21) was prepared by using 13.485 g of potassium dihydrogen phosphate (KH_2PO_4) and 85.414 g di-sodium hydrogen phosphate dodecahydrate ($\text{Na}_2\text{HPO}_4 \times 12 \text{H}_2\text{O}$). These salts were dissolved in a 5-liter volume flask with purified water.

2.2.4.2. Sampling

In vitro drug release experiments ($n = 3$) were conducted in vials, containing 8 ml artificial aqueous media (pH 7.21), placed in a horizontal shaker at 37°C, 80 rpm. At predetermined time points, the whole media was exchanged samples withdrawn, and analyzed by UV spectrometry at the absorption maxima of the drugs (Table 8).

Table 8: Absorption maxima in UV-Vis light for drugs, used in this study

API	wavelengths [nm]
Dexamethasone	242; 266
Diclofenac sodium	276; 305
Minocycline	246; 280; 347
Propranolol hydrochloride	212; 289; 319
Risperidone	236; 266
Sodium salicylate	296; 305
Theophylline	271

When intraocular lenses were coated with PLGA, isotonic sodium chloride solution (0.9%) was used as release media [127,171–173].

2.2.4.3. Calculation of drug release

When the IOLs was just loaded by one drug (single loaded lenses), the recorded absorption from release media was converted to the amount of released drug and results were cumulated. For each drug, a calibration curve was produced and linearity was proven in the targeted range.

2.2.4.3.1. Dual wavelength method

The dual wavelength method was applied for dual loaded lenses [174]. Dexamethasone does not show any adsorption at 305 nm so that additional calibration curves for the second loaded APIs were established for this wavelength. Due to the correlation in adsorption between two wavelengths, a specific ratio was calculated for the second drugs between the adsorptions at 305 nm and 242 nm. By this method, the theoretically calculated absorption of the second chemical entity at 242 nm was subtracted from the measured adsorption at 242 nm (Figure 31). This calculated absorption was considered as absorption related to the concentration of

dexamethasone. Plotted point in release curves are either measured directly or calculated by this method.

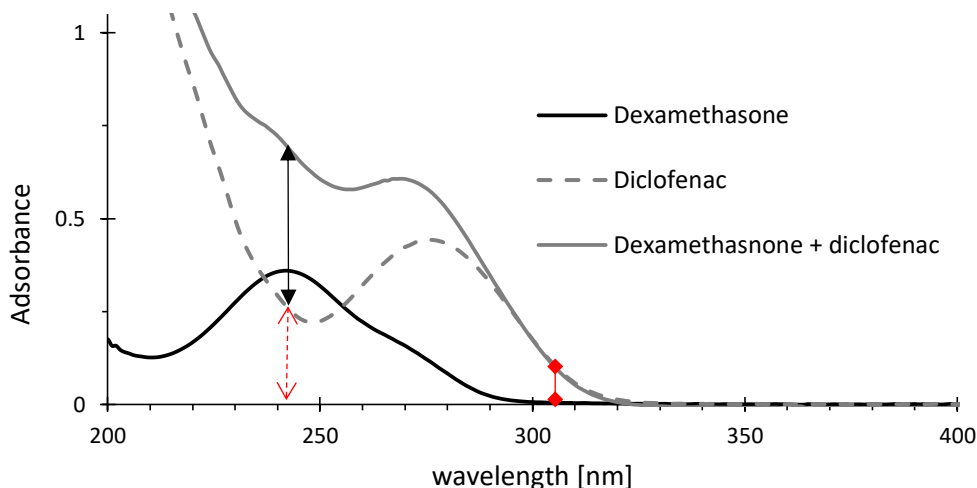

Figure 31: Dual wavelength method
(Example: Release from dexamethasone, diclofenac and dual loaded IOLs)

2.2.4.4. PH-measurement

To check pH in prepared buffers and during release, a calibrated conductometer (Basic meter PB – 11, Sartorius, Göttingen, Germany) was used. Release media was replaced every 24 hours, samples withdrawn and the pH was measured.

2.2.5. Statistical calculations

2.2.5.1. F2 factor

The differences between release profiles of different formulations were compared by using the similarity factor “ f_2 ” [175,176], as suggested by the FDA.

$$f_2 = 50 \log \left\{ \left[1 + \frac{1}{n} \sum_{t=1}^n W_t (R_t - T_t)^2 \right]^{-0.5} 100 \right\} \quad \text{Eq. 3}$$

R_t and T_t are the percentage drug dissolved at the time point t from the test formulation and the reference profile respectively; n is the complete number of sample points and w is donated to the pre-specific weights, set to 1 in this study. A f_2 value of 100 represents identical release profiles, whereby f_2 values above 50 are considered as similar (< 10% difference). Values smaller than 50 indicate differences in test and reference profiles.

2.2.5.2. Apparent diffusion coefficient

To calculate the diffusion coefficient, the following formula was used [177]:

$$\frac{M_t}{M_\infty} = 1 - \frac{32}{\pi^2} * \sum_{n=1}^{\infty} \frac{1}{q_n^2} * \exp\left(-\frac{q_n^2}{R^2} * D_{app} t\right) * \sum_{p=0}^{\infty} \frac{1}{(2p+1)^2} * \exp\left(-\frac{(2p+1)^2 * \pi^2}{H^2} * D_{app} t\right)$$

Eq. 4

where M_t is the mass of API released at time t and M_∞ is the mass of API released when time approaches infinity, R and H represent the radius and the high of the IOL respectively, n and p are real numbers and q_n represents the roots of the Bessel function of the first kind of zero order ($J_0(q_n)=0$)

Requirements to apply this equation are:

- DDS shows constant dimensions regarding the shape
- API has to be dispersed within the matrix homogeneously
- API release is controlled by diffusion
- Diffusion is constant in all directions (axial and radial)
- Sink conditions are maintained during the entire release period

In this equation, all parameters (tortuosity, drug loading, solubility), except for the intraocular lens dimensions are combined in the apparent diffusion coefficient (D_{app}). Now, when the IOL dimensions are known, a fitting for the D_{app} could be performed.

3. Results and discussion

3.1. Introduction

Intraocular lenses are the only functioning remedy for cataract nowadays. Since, Sir. Harold Ridley introduced them in 1950, they became famous and improved the life quality of millions all over the world. Regarding the variety in people, many different lens formulations and shapes were introduced and these process will continue in future, in respect to preferences of physicians (manageability) as well as to the different patients need and also due to scientific improvements in optical, quality and safety aspects.

In general, lenses can be classified by different characteristics. In this thesis, lenses were gathered in groups with respect to their hydrophilic-hydrophobic balance, the most common way to categorize them [33,45].

3.1.1. Polymerization

Intraocular lenses are usually prepared by bulk polymerization, in order to prepare polymers with excellent optical properties in absence of solvents or other process excipients. However, this process is time-consuming, due to the limited temperature range that is appropriate for this radical polymerization. In respect to the increasing viscosity of the composition by time, the heat transfer is hampered, leading to auto-acceleration of the exothermic reaction, known as “Trommsdorf effect” [178–181]. Thus, the chosen process temperature has to provide enough energy to maintain the reaction but has to be low enough to prevent rapid polymerization, which would decrease the optical quality of IOLs.

Polymers were prepared by two different approaches, either, the mixture of monomers is cast in a mold (cast molding) and the lens dummies are polymerized already in the final shape [182] or the polymerization is performed in order to get polymer rods (lathe cutting), that are drilled to blank coins, later lathed to IOLs [58]. Indifferent which approach is used, lenses have to be polished and examined before delivery.

For this study, the lathe cutting method was used mainly and lenses were lathed out from polymer rods. Therefore, the polymerization of monomer blends was carried out in sealed vials, having a diameter of 6 or 8 mm respectively. During polymerization, no decrease in container-mass was detectable, implying, that monomers did not evaporate and polymerization was conducted properly. This applied for hydrophilic compositions, polymerized in Eppendorf centrifuge tubes as well as for hydrophobic polymers, prepared in glass vials. This selection

was made in order to facilitate the removal from the containers. Hydrophilic polymers were sticky to glass whereas hydrophobic compositions could not be removed from plastic containers without rupturing the solidified composition, attributed to the same hydrophilic-hydrophobic character of the polymer and the vessel. The intermediate amphiphilic polymers were prepared in glass vials in respect to the possibility to smash the glass in small pieces which could be peeled. Hydrophilic lenses were cut after polymer rods soaked water in order to have sufficient flexibility to cut them with a sharp blade, whereas flexible hydrophobic polymers were cooled down in a freezer to make them more robust, to slice them properly. Lenses were lathed in order to prepare lenses presenting an average weight of 20 mg and a diameter of 6 mm [33,183].

3.1.2. Physical characterization of intraocular lens formulations

Different basic polymer formulations (Table 9) were prepared in order to resemble the different intraocular lenses that are commercially on the market. Formulation 1 and 2 represent hydrophilic IOLs and were manufactured from the same monomers like common IOLs that are available nowadays for the insertion into the ocular bag [152,182,184]. In contrast, formulation 3 to 5 are used as amphiphilic polymers, made of blends of hydrophilic and hydrophobic monomers. This is a common procedure to achieve flexible IOLs, having high refractive indexes and are less prone to glistening [185–187] than purely hydrophobic IOLs. Formulation 4 was suggested specifically in the literature [188], whereby the other two formulations were composed out of common monomers in ophthalmology but in ratios, that are not reported so far. Formulation 6 – 8 represent the variety of lenses, just prepared by hydrophobic monomers [45,61,64,187,189–191]. Lenses, made of pure methyl methacrylate are brittle [192], whereas formulations 6 and 8 are foldable, due to the lower T_g .

As presented (Table 9) by increasing the amount of hydrophilic monomers, the water content of soaked lenses is enhanced. Therefore, the refractive index decreased due to the less dense polymer. Furthermore, the wetting angle for dry hydrophilic lenses is smaller than for more hydrophobic IOLs, caused by the presence of hydroxyl groups in the lens surface. Water droplets that were applied on soaked lenses of formulation 1 and 2 spread immediately and no droplet was formed, attributed to the high water content in lens polymers, resulting in high hydrophilicity. Hydrophilic lenses, made of methacrylate had high glass transition temperatures (T_g) in unsoaked conditions and thereby were not foldable, due to the entanglement of polymer chains, induced by the additional methyl group in the backbone of the polymer [193].

Results and discussion

Table 9: Physical characteristics of intraocular lens formulations, (mean value \pm SD; Monomer concentrations (% (w/w)))

Formulation	Monomers	Refractive index (soaked IOL)	Wetting angle	Water uptake [%]	T_g [°C]	Foldability
Formulation 1	HEMA (100)	1.4200	20 °	54.67 \pm 1.42	98.99	just in soaked conditions
Formulation 2	HEMA (100) MMA (20)	1.4500	25 °	28.91 \pm 0.63	106.22	just in soaked conditions
Formulation 3	HBMA (20) BMA (10); IBMA (10); EA (60)	1.4750	80 °	2.03 \pm 0.34	7.63	Yes
Formulation 4	HEMA (13) POEA (17); EA (70)	1.4850	84 °	1.61 \pm 0.63	0.33	Yes
Formulation 5	HEA (20); HBMA (20) BMA (19); POEA (2); EA (39)	1.4780	87 °	4.57 \pm 0.36	10.09	Yes
Formulation 6	MMA (20); EA (80)	1.4700	45 °	0.86 \pm 0.32	- 3.29	Yes
Formulation 7	MMA (100)	1.4900	70 °	0.55 \pm 0.27	109.59	No
Formulation 8	POEA (100)	1.5550	90 °	0.52 \pm 0.36	6.18	Yes

Explanation of abbreviations for monomers:

Hydrophilic monomers: HEMA: Hydroxyethyl methacrylate; HBMA: Hydroxybutyl methacrylate; HEA: Hydroxy ethylacrylate

Hydrophobic monomers: MMA: Methyl methacrylate; BMA: Butyl methacrylate; IBM: Iso-butyl methacrylate; EA: Ethyl acrylate; POEA: Phenoxy ethylacrylate

In contrast, hydrophilic lenses, that soaked water and formed hydrogels thereby were foldable and could be applied folded into the eye, attributed to the plasticizing effect of water [194].

Amphiphilic intraocular lenses showed higher refractive indexes and the monomer selection was made in order to prepare polymers with glass transition temperatures below room temperature, to provide foldability. However, due to the higher refractive index, these lenses are subjected to glistening [35,42–44,168] in some cases, caused by the difference propagation of light in water-filled vacuoles within the polymer matrix and the polymer as itself. This became more pronounced when the difference in refractive index was increasing. These intermediate polymers were prepared in order to combine the advantages of hydrophilic and hydrophobic intraocular lenses and to eliminate the limitations of them.

Formulation 6 – 8 had the smallest water uptake, attributed to the absence of hydrophilic groups within the polymer structure. In formulation 6, methyl methacrylate was used to enhance the refractive index whereas ethyl acrylate provided flexibility to the formulation. Unfoldable methyl methacrylate (PMMA) lenses are still common in developing countries and for children, caused by financial reasons and its good long-term stability [34]. Resulting in the very small water content of pure pPOEA lenses, the refractive index is high even if no methacrylate is used for this formulation, since, foldability could be guaranteed for this composition. The measured glass transition temperatures [195] as well as refractive indexes [196] are similar to reported values and prove the suitability of the applied methods and the prepared polymers.

3.1.3. Optical properties of intraocular lenses

All polymers showed transmittances of 100% in the range of 450 nm to 800 nm, when no drug was incorporated into the lens matrix. In the range of UV light, polymers adsorbed light partially and UV blocker could be added to intensify this effect [197] concerning harmful energetic blue light that may have a devastating impact on the rods and cones, the sensory cells of the retina.

Besides this, some amphiphilic and hydrophobic materials were temperature-sensitive polymers, leading to a decrease in transmittance, when lenses were measured at temperatures lower than body temperature (37°C) (Figure 32 A). These polymers demonstrated upper critical solution temperatures (UCSTs), resulting in a reversible higher swelling at high temperatures and lower swelling at low temperatures. Specifically, above its UCSTs, polymers are more soluble and below its UCSTs, precipitation takes place [198,199] (Figure 32 B). So named “intelligent polymers” like temperature, pH and ionization sensitive polymers, are used in DDS

as vehicles to archive drug targeting, because they can be loaded in specific conditions and start to release the loaded drug when trigger conditions are present in the environment [200–202].

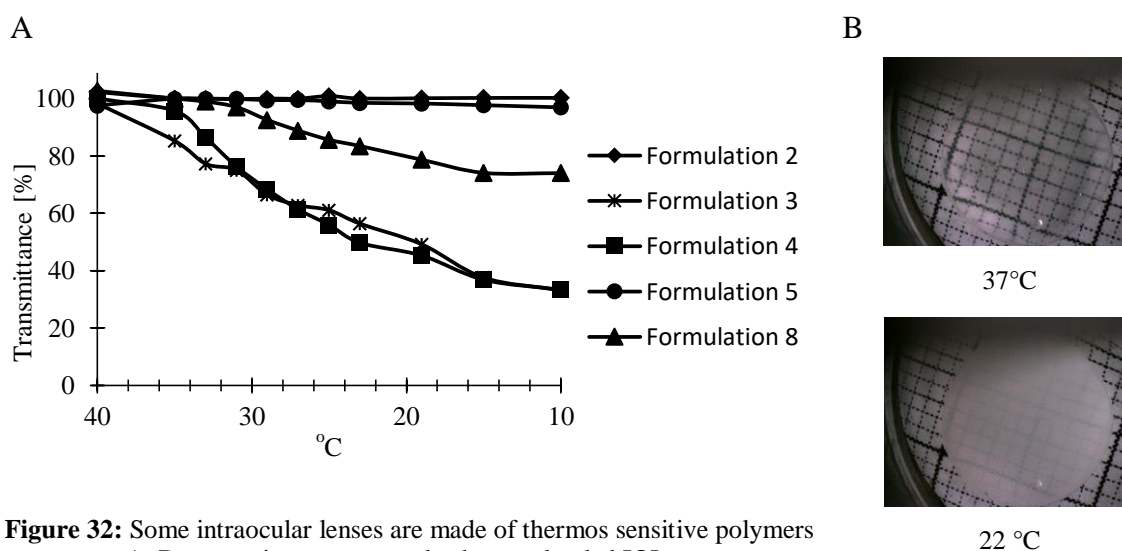

Figure 32: Some intraocular lenses are made of thermos sensitive polymers
 A: Decrease in temperature leads to a clouded IOLs
 (Transmittance values were measured at 600 nm)
 B: Images of pPOEA lens (formulation 8) at 37°C and 22°C

This also applies to hydrogels [203], but eventually, this approach did not work for IOLs. An induced temperature change is reported as the main reason for glistening [35,43], followed by a potential decrease in optical quality of the intraocular lens [42,44]. However, lenses that are injected into the eye are not exposed to temperature changes and the decrease of transmittance in lower temperatures is not critical.

3.1.4. Purification

After polymerization, the polymer still contained residuals such as monomers, unused cross-linker and initiator. Prior purification, polymers were lathed to shape out lenses in order to diminish the distance from the core to the surface. Hydrophilic IOLs were boiled in water for 1 hour to remove the water-soluble compounds whereas hydrophobic and amphiphilic polymers, were placed in organic solvents. Acetone had good cleansing capability but led to extreme swelling (400%), followed by imperfections in the polymer structure. In methanol, lenses had a mass uptake of 100% and could be purified, but methanol was rejected, due to toxicity reasons of residual methanol after evaporation. Ethanol, a less harmful [204,205] compound was used, also with respect to the general acceptance of ethanol in the preparation of drug-loaded IOLs [151].

3.1.5. Sterilization

In industry, lenses are sterilized normally by ethylenoxid [206]. To prove a simpler method, lenses of all polymers were placed in sealed vials, containing physiological saline solution and steam sterilization was conducted (15 minutes; 121 °C; 2 bar) [207]. Afterward, lenses were placed on agar plates and incubation took place for 2 weeks. For all sterilized lenses, sterility was proven whereas bacterial growth was reported for lenses that did not undergo sterilization process.

However, lenses made of pMMA changed their visual appearance and became cloudy because lenses passed the T_g during sterilization and changes in the polymer structure took place [208]. In contrast, hydrophilic lenses could be steam sterilized [209], anyhow this process is challenging for drug-loaded lenses, in respect to drug decomposition and drug release, which might take place during steam sterilization. Amphiphilic lenses showed 100% after sterilization, but due to evoked glistening, gas sterilization was superior in comparison to steam sterilization.

3.1.6. HET-CAM test

In order to check the potential risk of prepared intraocular lens formulations on the human eye, the “hen's egg test chorio allantoic membrane” [166,210] test was performed.

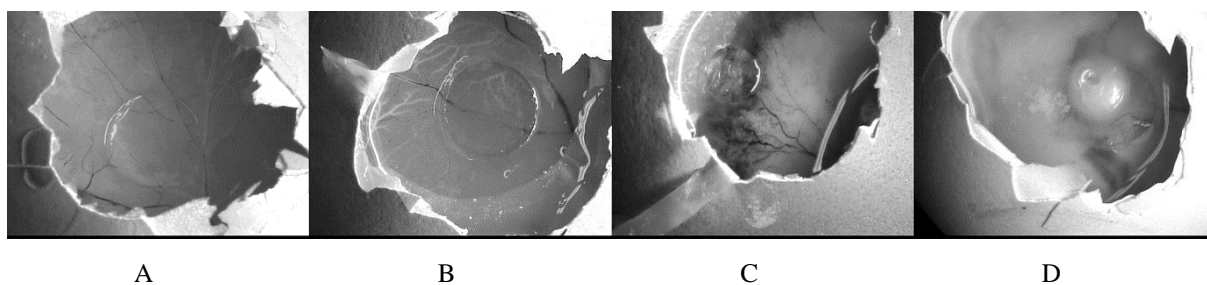

Figure 33: Vascular response in HET-CAM test

- A: No/less irritation;
- B: Lysis of blood vessels in not purified lens
- C: Hemorrhage and clotting/coagulation in not purified lens
- D: Denaturation, lens that had remaining organic solvent from cleansing step

Cleansed IOLs have no irritancy to the chorio allantoic membrane (Figure 33) and are tolerated well in contrast to IOLs that were not purified. Lenses, containing remaining process residuals were associated with lysis of blood vessels and also to hemorrhage and clotting/coagulation. Denaturation in HET-CAM test could be reported, when the organic solvent was not evaporated after cleansing, suggesting, that purification step is crucial to prepare biocompatible, not irritation IOLs. However, polymers that were treated properly could be considered as safe.

3.2. Hydrophilic lenses

3.2.1. Background

Hydrophilic intraocular lenses are made of polymerized hydrophilic monomers. Mainly, 2-hydroxyethyl methacrylate (HEMA) is used [211]. To modify the polymer properties, other monomers can be added such as methyl methacrylate in order to improve the refractive index as well as foldability properties of the lenses. This cross-linked hydrophilic polymers form hydrogels, which are three-dimensional polymer networks that swell in water until an equilibrium degree in water content is reached [65,142]. Most hydrogels are very well tolerated by the ophthalmic tissues, such as retina, choroid or corneal endothelium [115]. This biocompatibility is provided by the high percentage of water which is similar to body tissues [212,213].

In this part, different hydrogels were prepared and loaded by various methods and drugs. Formulations were modified in order to obtain the desired performance such as optical properties, foldability, drug loadings and release patterns.

3.2.2. Lens formulations

The selection of suitable compositions is crucial for the performance of drug-loaded IOLs. In general, lenses are prepared by bulk polymerization of various (meth-) acrylates in different ratios. Mixtures of 2-hydroxyethyl methacrylate (HEMA, hydrophilic) and methyl methacrylate (MMA, hydrophobic) monomers were prepared in different ratios and polymerized. These monomers are commonly used in IOL production. Therefore, biocompatibility, as well as safety, could be guaranteed by long and intensive experience through the years [45] [33].

Increasing amounts of HEMA led to more hydrophilic IOLs (Table 10) with a higher water uptake and better foldability (flexibility) which was attributed to the plasticizing effect of water. Since IOLs should be inserted into the eye in a folded manner, flexibility is important [214].

Table 10: Lens formulations and its characterization regarding refractive index, water uptake (mean \pm SD) drug loading and foldability

Formulation	MMA / HEMA [%]	Water uptake [%]	Foldability	Refractive index	Drug loading [%]
A (1)	0 / 100	54.67 \pm 1.42	Yes	1.4230	1.20
B (2)	20 / 80	28.91 \pm 0.63	Yes	1.4535	1.04
C	40 / 60	18.01 \pm 0.71	No	1.4580	1.06
D	60 / 40	10.56 \pm 0.41	No	1.4670	0.84
E	80 / 20	5.27 \pm 0.10	No	1.4790	0.55
F (7)	100 / 0	2.07 \pm 0.27	No	1.4900	0.15

Formulations were ranked in respect to the hydrophilicity and were named according to the alphabet. Numbers in brackets indicate the general labeling in this thesis, regarding materials and methods (3.2.)

The flexibility was further analysed by a texture analyser with force (N) – distance (mm) curves (Figure 34). Formulation A (1) and B (2) were flexible, whereas the formulation C, containing 40% methyl methacrylate was already too hard to be foldable. The other formulations were brittle and not flexible at all. At the beginning of IOLs, polymethyl methacrylate (formulation A (7)) was a common lens material but seldom used nowadays because it is brittle [215]. Mostly it is still used in developing countries and for children since polymethyl methacrylate can remain in the eye for long time periods, due to good long-term stability and its low cost as well [34].

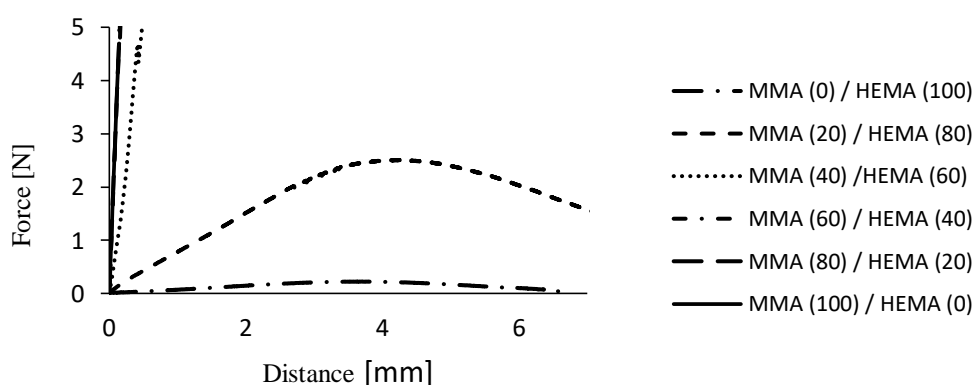
Figure 34: Foldability test of lenses, comprising MMA and HEMA in different ratios

As a consequence of the higher water uptake, the refractive index decreased at higher HEMA contents. IOLs with lower refractive index have to be made thicker to provide the appropriate diffraction within the eye. In contrast, higher HEMA contents led to increased drug loadings. This could be explained by the higher swelling in the soaking solution. Therefore, drug

diffusion within the IOLs was improved. Furthermore, the hydrophilic diclofenac had a higher tendency to diffuse into the hydrophilic polymers.

In drug release study, diclofenac from drug-loaded IOLs was released fast from pure polyhydroxyethyl methacrylate, attributed to the high water uptake and consequently the less hindered diffusion within the lenses (Figure 35). By increasing amounts of methyl methacrylate, the lenses became more hydrophobic and the API was released slower. Besides the water uptake, API – polymer interactions [216,217] that are more pronounced to hydrophobic groups became more prominent and extended the release. When the methyl methacrylate concentration in the polymer was higher than 60%, the lenses did not release the drug in a sufficient way, to be detected by UV-Vis with the necessary precision. Just in the first samples, a distinct amount of API could be detected. When the loading solvent was evaporated, it diffused to the lens surfaces and dragged drug with it. Thus, a higher drug concentration was observed on the lens surfaces.

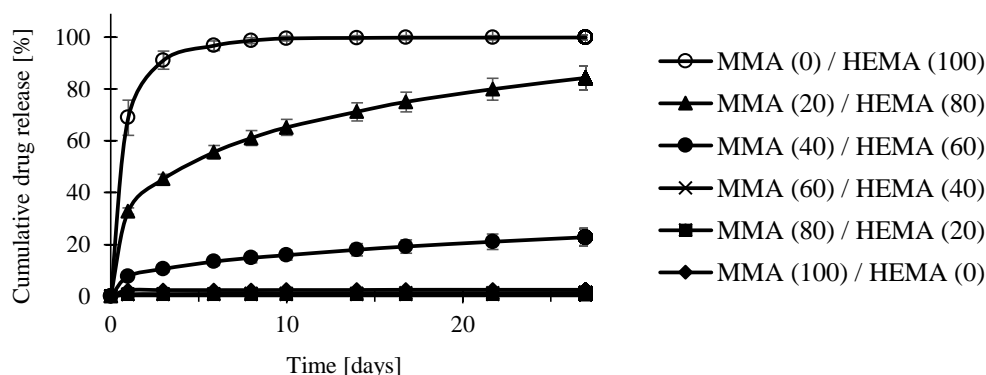

Figure 35: Diclofenac - Na release of polymers, prepared with different ratios of MMA and HEMA

Regarding foldability, drug loading and drug release patterns, formulations 1 and 2 were selected for further studies.

3.2.2.1. Polymer volume fraction

In non-porous swollen hydrogels, the mobility of compounds is determined mostly by the amount of liquid, which is present in the polymer. Flexibility, the distance between the polymer chains and interactions of compound and polymer [218] also have an impact, but less pronounced.

In hydrogels, the thermodynamic status of water is not uniform. One part of the water is strongly bound to the polymer, whereas another fraction is just weakly bound. The third part is not bound

at all, also named free or bulk water [219,220]. This free water is the guiding fraction for drug diffusion.

However, the polymer volume does not increase in the same extent as the water uptake, because water is absorbed and diffused also in small pores/holes within the hydrogel matrix without increasing polymer dimensions. The polymer volume fraction describes the amount of fluid, that can be absorbed and retained in the polymer structure [218] in total and does not distinguish the three water fractions of hydrogels. Nevertheless, it indicates how much water is present in the hydrogel and might be assessable for diffusion.

For pure polyhydroxyethyl methacrylate lenses, the polymer volume fraction was 0.65 ± 0.02 whereas, in lenses containing 20% methyl methacrylate, the polymer volume fraction was 0.76 ± 0.01 respectively. This proved, that there is more water and less polymer in hydrogels from pure pHEMA lenses in comparison to lenses, prepared with 20% methyl methacrylate as additive.

3.2.2.2. Addition of water to expand the polymer structure

To further improve the drug loading capacity of the hydrophilic polymers, water (Milli Q[®]-water) was added to the blend of monomers prior to polymerization to expand the cross-linked polymer structure [221]. By this approach, the water was mingled with the hydrophilic monomer solution and “copolymerized” within the mixture. Since water cannot be bound during the radical polymerization, it led to the formation of a wider meshwork within the finalized polymer without creating pronounced pores. This was possible because the monomers, as well as the final polymer, had high affinity to water and no separation took place during the bulk polymerization. Furthermore, bigger pores must be avoided due to the tendency of ocular epithelial cells to adsorb onto IOLs and to migrate into pores and between the interface of the IOL and the capsular bag [222] leading to posterior capsule opacification (PCO) also called “secondary cataract”. Therefore, more than 20% of water could not be added. With higher water content, pores would be created.

To assure the vacancy of pores within the lens materials, SEM analysis was carried out and images were recorded (Figure 36). The presence of pores could be excluded. Scratches on lens surfaces were due to lens cutting procedure and could be eliminated by smooth polishing of lens material.

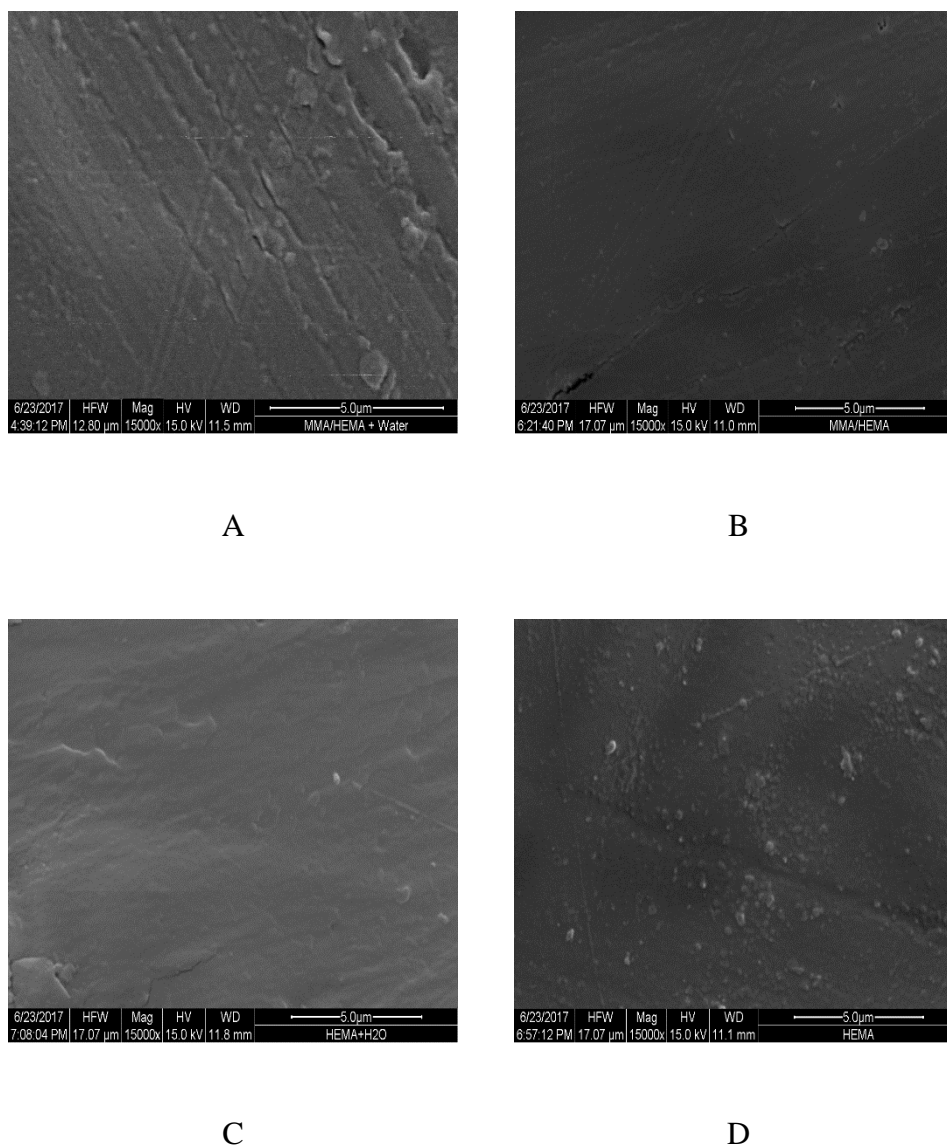

Figure 36: SEM of hydrophilic IOLs (Magnification 15000x)

- A: HEMA (80) / MMA (20) with water during polymerization
- B: HEMA (80) / MMA (20) without water during polymerization
- C: HEMA (100) with water during polymerization
- D: HEMA (100) without water during polymerization

By adding water to the blend of monomers before the polymerization took place, the total water content of the soaked polymers increased from $54.67 \pm 1.42\%$ to $65.67 \pm 1.42\%$ for pure polyHEMA formulations and from $28.91 \pm 0.63\%$ to $40.81 \pm 0.76\%$ for the formulation 2, containing 20% methyl methacrylate (Table 11). The refractive index of lenses, prepared with water in polymerization step was slightly smaller, due to a less dense polymer.

Table 11: Water uptake and refractive index of hydrophilic lenses, polymerized with water in order to expand the polymer structure (mean values \pm SD [%])

	without water		with water	
	water uptake [%]	ref index	water uptake [%]	ref index
HEMA (100) / MMA (0)	54,67 \pm 1,42	1,4230	65,67 \pm 1,42	1,4195
HEMA (80) / MMA (20)	28,91 \pm 0,63	1,4535	40,81 \pm 0,76	1,4500

3.2.3. Loading approaches

There are many different approaches to produce drug-loaded intraocular lenses [111] (Figure 37). However, all methods can be divided into two sections. First, lenses can be loaded during production, secondly, the API is loaded into or onto the lens matrix or haptic afterward.

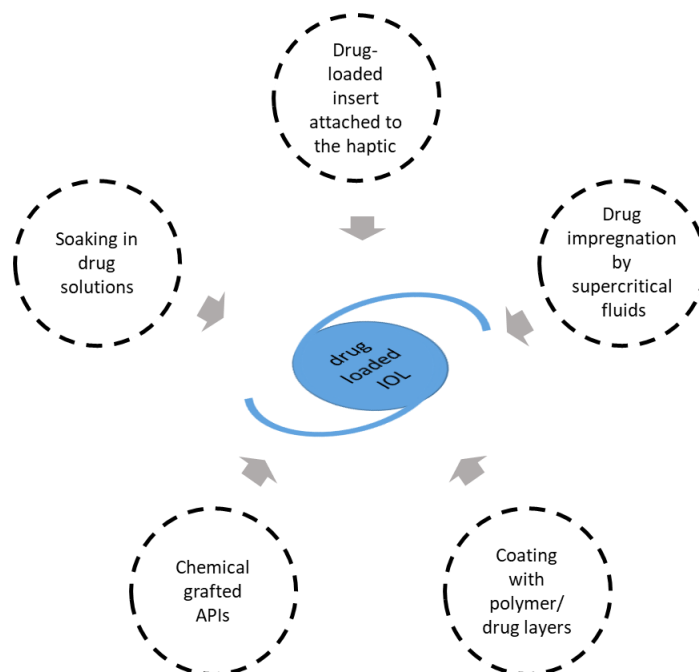

Figure 37: Approaches for producing drug loaded IOLs

3.2.3.1. Drug loading by copolymerization

Lenses that were loaded by adding drugs to the mixture of monomers prior to heating and were copolymerized had to have specific properties to be suitable for this approach. For instance, diclofenac, that was added prior polymerization prevented radical polymerization and solidification of the monomers, due to the capability of diclofenac to act as a free radical scavenger [223]. Other drugs like minocycline were not soluble within the

monomers and stability issues during polymerization occurred, resulting in discolored polymers. Hence, drugs had to be inert and stable during polymerization in order to retain the function of the API. Additionally, drugs, containing unprotected double bonds are not approachable because they would be bound covalently. In contrast, APIs that could be linked to the polymeric meshwork by ester bonds could have extended release, caused by the slow degradation of the ester [104].

Dexamethasone that was added to the blended monomers and suffered polymerization was dispersed homogeneously within the final polymer. Drug release studies were conducted with different parts of the finalized polymer and drug loading/release was similar in all samples.

In order to investigate the impact of cross-linker and added water, lenses were prepared with the double amount of cross-linker and with water (20%) in order to expand the inner structure of the polymer (Figure 38).

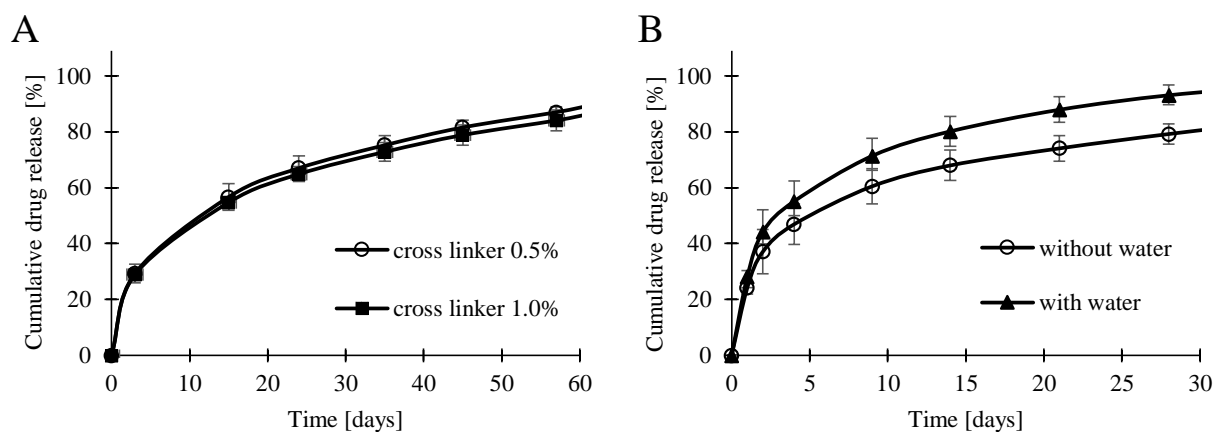

Figure 38: Dexamethasone, copolymerized with lens formulation 2, containing HEMA (80) / MMA (20)

A: Impact of the cross-linker

B: Impact of water as a polymer expanding excipient

Lenses containing 0.5% or 1.0% of cross-linker had similar release patterns (similarity factor (f_2) of 77.04) and were considered as same. In contrast, drug release from lenses prepared without and with water as expanding excipient had different release curves, indicated by an f_2 value of 44.73.

The similarities in drug release of lenses prepared with different amounts of cross-linker were due to the similar water content within the polymer. Water is the guiding factor for diffusion and in this range, the impact of the higher cross-linker amount was negligible. However, a very slightly slower release was detectable, caused by a slightly lower swelling and a marginally higher obstruction for diffusing compounds, attributed to the more cross-linked polymer. This

impact would increase when the amount of cross-linker would be raised but this would impair the foldability of lenses because the lenses would become harder or even brittle.

Water, that expanded the polymer meshwork during polymerization, increased the water content of the finalized polymer. That is the reason for the faster dexamethasone release in these lenses in comparison to IOLs, polymerized without water.

Drug concentration:

To modify the drug loading, the added API concentration prior to polymerization might be changed. Thus, a blend of monomers, containing cross-linker, initiator and 80% of hydroxyethyl methacrylate and 20% of methyl methacrylate was prepared and divided into different batches. Dexamethasone was dissolved in these batches in various concentrations and polymerization was carried out. Dexamethasone could be dissolved in this formulation up to a concentration of 2.0%. All prepared polymers were transparent and had refractive indexes in the range of 1.4510 – 1.4520.

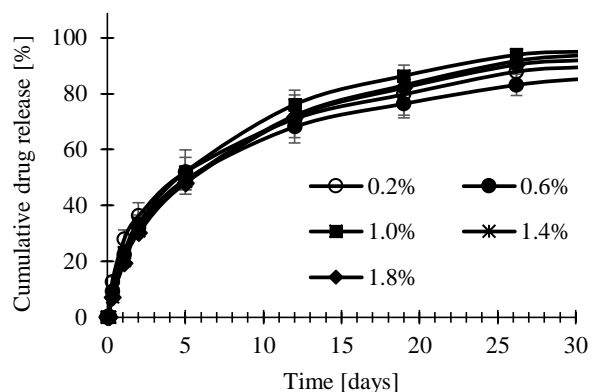

Figure 39: Formulation 2 (HEMA (80%) / MMA (20%)) copolymerized with dexamethasone in different concentrations

Polymers did not shrink or expand during polymerization. So, the drug loading of solidified dry polymers was almost the same as in the liquid blend of monomers, also suggesting that no degradation of dexamethasone took place during polymerization. This was remarkable, due to the just poorly protected double bounds of dexamethasone. However, this was confirmed by other scientists as well, who also conducted copolymerization with dexamethasone and methacrylate forming hydrogels [224,225].

Hydrogels are known to have first order release kinetics, due to the mainly diffusion driven release [177,218]. Just initially, they have a burst release, caused by drug that is located on the surfaces. Afterward, diffusion is the guiding principle and therefore independent of the drug

loading. Thus, the drug release was independent of the drug loading and could be described by Fick's second law of diffusion [218,226,227].

3.2.3.1.1. Nanoparticles

Recently, nanoparticles gained interest in all pharmaceutical areas and in ophthalmology [228] as well. Particles that are smaller than the wavelength of the visible light might appear as transparent in solutions/suspensions [229]. Thus, dexamethasone was milled in monomer solutions by glass beads (0.2 mm) for 2 hours. The solution was filtrated afterward to exclude particles bigger than 400 nm and the polymerization was carried out.

In respect to the high surface area and consequently the fast dissolving rate, release curves were similar to lenses that were loaded just by dissolved drug. The drug loading increased but lens polymers developed imperfections during polymerization (Figure 40).

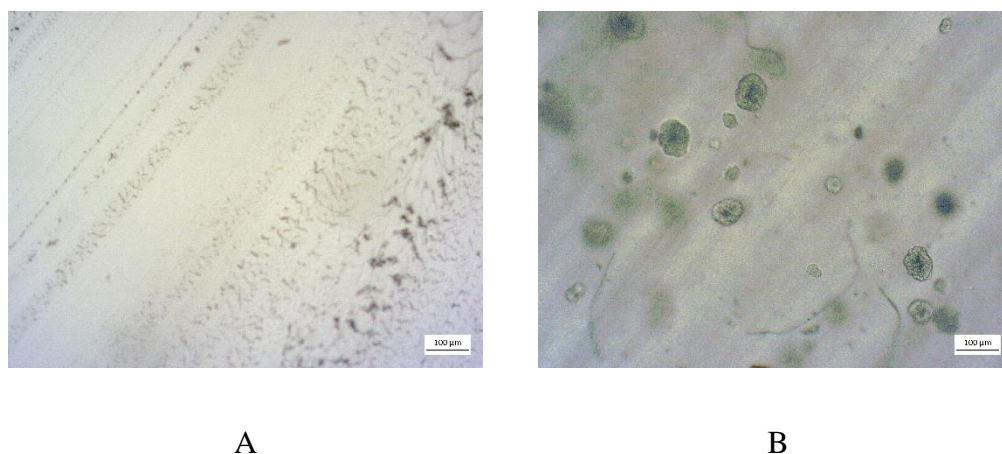

Figure 40: Microscopic images of IOLs, polymerized with dexamethasone nanoparticles after 92 h in release media
 A: Unloaded lens
 B: Lens copolymerized with dexamethasone nanoparticles

It was assumed, that dexamethasone had higher solubility in the liquid monomers than in the solidified polymer. Therefore, dexamethasone dissolved in heated monomers in the beginning and reprecipitated during polymerization. Remained nanoparticles functioned as seed crystals and bigger particles were developed. These particles caused small imperfections in polymers and therefore glistening was formed. This failures in the lens polymer structure were bigger than initial nanoparticles and decreased the optical quality of IOLs enormously.

By using appropriate surfactants, it might be possible that the nanosuspensions could be stabilised but for IOLs, the trend is to use fewer ingredients as possible. Especially for hydrophobic but also for hydrophilic lenses, the aim is to prepare polymers as pure as possible

in order to avoid light scattering in general. By using nanoparticles, this whole approach is infringed.

However, loading prior polymerization has a tremendous disadvantage. Normally, lenses are purified after polymerization in order to remove unused monomers, cross-linker and initiator. Even when polymerization was finalized with higher temperatures, small amounts of residuals were still present and might have adverse effects on delicate ophthalmic tissues. Thus, after polymerization, polymers were cleansed with organic solvents so that redundant compounds were removed [58]. By this procedure, drugs that were just physically “dissolved” within the polymer would be removed as well.

Furthermore, hydrogels are inserted in soaked conditions and therefore, they are supplied in aqueous solutions. In case of drug-loaded intraocular lenses, this could result in less stable products and in leaching API during delivery as well. This could be avoided by using saturated drug solutions, but stability would still need to be considered.

3.2.3.2. Soaking

By the soaking method, hydrophilic lenses are placed normally in aqueous drug solution for a specific time and the drug is absorbed into the lens by diffusion. For most prepared drug-loaded intraocular lenses in the literature, it is the method of choice [137–139,230] because it is simple to conduct and no modifications in the lens materials are needed. So, lenses might be placed in commercialized eye-drop solutions as soaking media, directly before the surgery takes place and no further improvements are required [118].

However, poorly water-soluble APIs cannot be loaded by this approach, due to insufficient drug concentration in the soaking solvent. Furthermore, this procedure is just accessible for hydrophilic lenses (hydrogels), which have a high amount of water in the polymer matrix that allows fast and sufficient drug diffusion. Despite, this fast diffusion also occurs in drug release studies, resulting in short releasing times. This is one of the main challenges for intraocular lenses in comparison to contact lenses. Contact lenses can be replaced frequently and drug release of 24 hours is sufficient whereas intraocular lenses are inserted once and have to elute the API for approximately a few days to one month. Thus, approved loading procedures for contact lenses cannot be transferred to intraocular lenses easily [102–105,231].

In order to improve drug loading and release of IOLs, different parameters have to be considered. This includes e.g. soaking time, drug concentration in soaking media, soaking temperature, pH during soaking, soaking solvents, the drug as itself and the lens formulation, including the amount of cross-linker, initiator and the composition of monomers in general.

3.2.3.2.1. Time

To approach the time factor, hydrophilic lenses, containing 2-hydroxyethyl methacrylate (80%) and methyl methacrylate (20%) were soaked in aqueous diclofenac – sodium (0.5%) solution for various times. The pH was set to 7.2 to mimic a potential lens insertion after soaking and to avoid crystal growth of diclofenac. Diclofenac is a non-steroidal-anti-inflammatory drug (NSAID) that is used regularly after cataract surgeries [232] in order to avoid pain, inflammations and also for induced mydriasis.

Table 12: Drug loading of IOLs; loaded with different soaking times (mean values \pm SD [%])

Soaking time [min]	Drug loading [%]
0	0.00 \pm 0.00
15	0.10 \pm 0.01
30	0.23 \pm 0.03
60	0.29 \pm 0.04
120	0.34 \pm 0.02

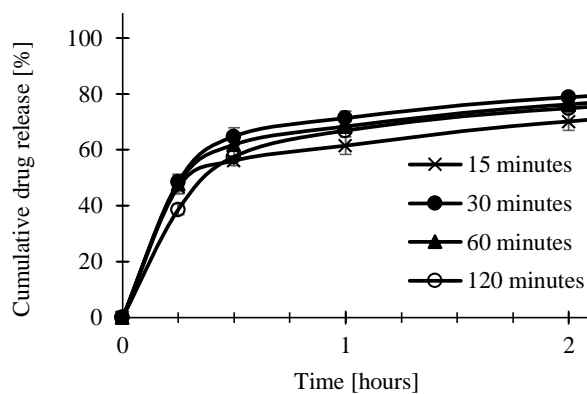

Figure 41: Drug release of IOLs; loaded with different soaking times

The drug loading could be increased by longer soaking times (Table 12) because diclofenac had more time to penetrate into the hydrogel. In the beginning, the loading is faster, due to the higher concentration gradient of lens and soaking solution. Getting closer to the equilibrium of the drug partition coefficient of lens and soaking media, loading got slower.

The release patterns were similar for all soaking times (Figure 41), due to the diffusion driven release that is concentration independent. However, a burst release, typical for hydrogels [65,218,233], took place for all lenses. The shape of intraocular lenses can be described by flat biconvex lenses, close to a thin cylinder, resulting in a very high surface area, related to the whole polymer. Thus, the pronounced initial burst release could be explained by drug, located near to the surface.

3.2.3.2.2. Concentration

When lenses were loaded in soaking media, the drugs were distributed in the lens polymer (formulation 2) and the soaking solution in respect to the partition coefficient. Thus, by increasing the drug concentration in solution, the drug loading raised in IOLs as well. In order to simulate the IOLs delivery in a drug solution, lenses were stored for 3 months in an incubation shaker at 22°C to mimic average room temperature. Various drug concentrations were chosen for diclofenac – sodium and theophylline as model APIs. The highest concentration represented a saturated solution.

Table 13: Drug loadings of IOLs; loaded for 3 months in aqueous drug solutions at 22°C with various concentrations of diclofenac sodium and theophylline
Concentration: concentration in the soaking solution
Drug loading: mean value \pm SD

Diclofenac sodium		Theophylline	
Concentration	Drug loading	Concentration	Drug loading
[%]	[%]	[%]	[%]
0.0	0.00 \pm 0.00	0.0	0.00 \pm 0.00
0.03	0.05 \pm 0.01	0.09	0.29 \pm 0.02
0.06	0.10 \pm 0.01	0.18	0.47 \pm 0.01
0.12	0.24 \pm 0.01	0.368	1.12 \pm 0.01
0.15	0.31 \pm 0.12	0.736	1.15 \pm 0.03

The drug loading increased by using higher concentrated soaking solutions as expected (Table 13). For diclofenac, the drug loading is linear correlating to the concentration in soaking solution, so a double concentration in soaking media increased the drug loading two times. Additionally, theophylline seemed to have a higher partition coefficient, regarding the higher drug loading in similar concentrated soaking solutions of diclofenac - Na and theophylline.

Lenses, loaded with theophylline did not have higher drug loadings when the drug concentration in soaking solution was close to solubility. Just in less concentrated solutions, the drug loading was correlated to the concentration in soaking media.

In literature, it is assumed, that the hydroxyl groups of the polymers are exposed to the media and trigger nucleation of calcium and phosphate within the eye [49]. This phenome was investigated recently because calcium phosphate tends to precipitate at hydrophilic lenses within the eye, named calcification [48,50,51], even when the aqueous humor is not saturated

by this salt completely. The same process could be observed in lenses that soaked in drug solutions, close to total solubility (Figure 42).

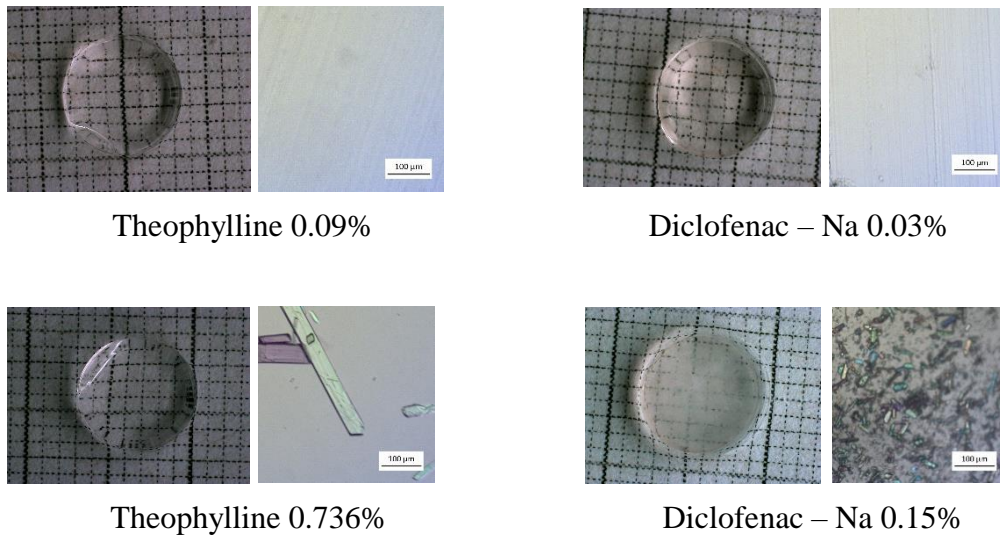

Figure 42: Chrystal formation on lens surfaces, soaked in drug solution for 3 month
Macroscopic pictures and microscopic images, using polarized light

Whereas theophylline formed a few big needle formed crystals, diclofenac precipitated in many small crystals. For lenses, loaded with higher concentrated diclofenac, crystal growth was so pronounced, that lenses became turbid and transmittance decreased remarkably. However, crystals were created just at the lens surfaces and could be removed by rinsing the IOLs with purified water. Nevertheless, precipitated drug was not dissolved anymore and thus, drug loading was not increased, owing to less concentrated soaking media.

For release study (Figure 43), all lenses were washed shortly in order to remove crystals.

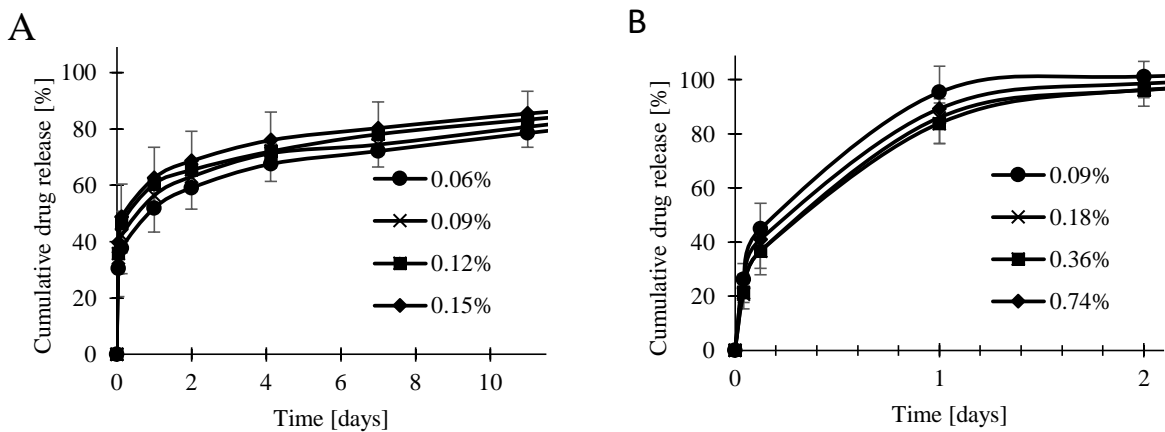

Figure 43: Drug release of IOLs, soaked for three months in aqueous drug solution with various concentrations (Values in legend represent the drug concentration in soaking solution)
A: Diclofenac sodium
B: Theophylline

This is necessary, with respect to possible micro injuries at ophthalmic tissues, caused by sharp drug particles. All formulations had an initial burst release and were transparent after drug crystals dissolved completely. The initial refractive index of diclofenac loaded lenses was 1.4600 and for theophylline loaded lenses 1.4570, respectively. In all IOLs, the refractive index decreased to 1.4505 within the first 48 hours. This change in refractive index is due to dissolved drug in the aqueous phase within the hydrogel. Thus, the refractive index of this fraction within the polymer is increased by the dissolved compounds and the total refractive index is increased as well. By time, the drug is released and the refractive index of just swollen polymers is leveled again and stable afterward. After the surgery, patients normally require glasses for reading. In respect to the time, the ocular tissues need to recover completely, goggles are prescribed approximately one month after the surgery. Additionally, the first day after surgery, the eye is wrapped and so, changed refractive index within the first hours after the surgery is not critical. In general, lenses could be supplied in aqueous drug solutions to produce API eluting IOLs, but stability issues, as well as crystal growth, has to be considered as crucial parameters. Additionally, an initial burst release will take place.

3.2.3.2.3. Temperature

In case, drug loading should be performed immediately before the surgery takes place, soaking might be accomplished at higher temperatures to improve diffusion. Therefore, lenses (formulation 2) were stored in an aqueous 0.5% diclofenac solution for 10 hours at room temperature (23°C), body temperature (37°C) and 50°C.

Table 14: Drug loading of IOLs; loaded in aqueous drug solutions, containing 0.5% diclofenac – Na, at different temperatures (mean values \pm SD [%])

Soaking temperature	Drug loading [%]
23°C	0.28 \pm 0.01
37°C	0.38 \pm 0.03
50°C	0.48 \pm 0.06

Greater drug loadings were achieved at higher temperatures (Table 14) because diffusion is improved and properly also the partition coefficient so that more drug got into the hydrogel. Nevertheless, higher temperatures than body temperature should be avoided because temperature fluctuations induce glistening [35].

3.2.3.2.4. Solvents

The drug loading by soaking depends strongly on the swelling of the polymer. If more solvent is uptaken by the polymer, also more drug might be dragged into the hydrogel matrix. Therefore different solvents were used in order to improve the drug loading. In acetone, lenses had a mass uptake of 400% and high drug loadings could be achieved. However, lenses were damaged during swelling and became less robust in the swollen state. Moreover, acetone was difficult to evaporate completely so that this solvent was rejected.

In spite of good swelling behavior with methanol (mass uptake of 100%) and robust polymers even in soaked conditions, methanol was excluded in respect to toxicological reasons [234,235]. Therefore, ethanol was used for further studies as organic solvent in respect to its general acceptance in ocular devices and its less devastating effect on the eye [204,205,236]. Furthermore, there are a few articles, intraocular lenses were soaked in ethanol [151].

Lenses (formulation 2) were kept immersed (24 hours) in blends of water and ethanol, comprising 0.5% theophylline each (Table 15).

Table 15: Swelling and drug loading of IOLs, when loading was performed with ethanol/water mixtures (drug loading: mean values \pm SD)

Ratio [%] Water / Ethanol	Swelling [%]	Drug loading [%]
100 / 0	30.62	0.92 \pm 0.02
80 / 20	49.81	0.85 \pm 0.01
60 / 40	124.07	1.01 \pm 0.01
40 / 60	205.13	1.27 \pm 0.02
20 / 80	199.07	1.24 \pm 0.02
0 / 100	98.07	1.14 \pm 0.01

Soaking solutions, comprising ethanol up to 60% increased the swelling of IOLs and drug loadings as well. By the higher solvent uptake, diffusion is less hampered by the cross-linked polymer and more drug could penetrate into the lens matrix. When the amount of ethanol got beyond 60% the drug loading of IOLs decreased again. This could be explained by the different solubility of theophylline in water (5.96 ± 0.19 mg/ml) and ethanol (2.55 ± 0.09 mg/ml). In water, and all blends that contained water, the whole drug was dissolved whereas in pure

ethanol, the drug did not dissolve completely. Thus, during soaking, partition took place, ethanol diffused into the lenses, but theophylline remained partially in the water that soaked less pronounced into the polymer matrix. In absence of water, the lens swelling decreased, because the hydrophilic formulation could not be hydrated.

All lenses had similar release profiles and remained transparent, except lenses, soaked in pure ethanol (Figure 44).

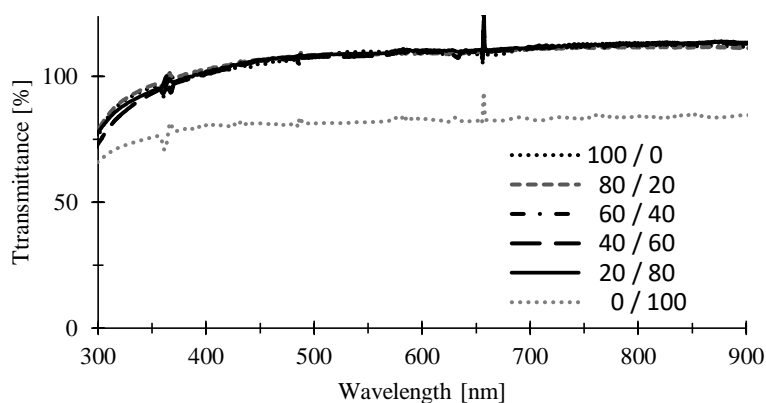

Figure 44: Transmittance of theophylline loaded IOLs; loaded with water/ethanol (legend) mixtures

In this soaking solution, crystals settled on lenses, due to the low solubility of theophylline in ethanol. During, release, crystals dissolved and IOLs became transparent again.

However, it indicates, that the right composition of soaking solvent is a crucial parameter in order to achieve the desired performance of IOLs such as swelling behavior, drug loading and transmittance.

3.2.3.2.4.1. Solvent evaporation

Organic solvents, that were used during drug loading and diffused into the polymer matrix, needed to be removed. Evaporation was performed in a vacuum oven at room temperature to avoid temperature fluctuation. Increased temperatures would accelerate evaporation but also stimulate degradation of drugs and glistening could be induced. Hydrophilic lenses, that were stored in a vacuum oven for 96 hours had weight constancy and were considered as dry.

IOLs loaded in aqueous soaking solutions could be applied immediately after this procedure but when drug loading should be prepared in advance, drying would be important in respect to stability reasons. Therefore, different drying procedures were investigated.

The purpose is to load IOLs in advance and to deliver them in dry condition so that the surgeon just needs to conduct rehydration and time-consuming drug loading procedures are not needed anymore.

3.2.3.2.4.2. Drying procedures

Freeze drying is a sophisticated drying process and is used for thermal sensitive formulations mostly. Furthermore, porous products are prepared and rehydration is fast. Thus, it was expected, that it might accelerate rehydration of lenses as well and that it is superior to vacuum drying. For all lenses, a small amount of residual water (2-5%) was desired in order to improve rehydration.

Dry lenses were not foldable and brittle [237], whereas lenses which soaked in aqueous solution were flexible, due to the plasticizing effect of water. Rehydration needed 30 minutes for freeze-dried and vacuum dried lenses as well and no advantages for freeze-dried lenses regarding rehydration time was observed. This could be explained by the not porous polymer matrix in soaked and dry conditions so that even in freeze-dried IOLs, water had to diffuse slowly into the matrix from the surfaces and could not rehydrate inner parts immediately. Freeze-drying of hydrogels is very time-consuming because the water is adsorbed more pronounced to hydrogels than in simple solutions [238–240]. Additional, lyophilisation is a drying technic, in which the sublimation starts at the surfaces and water from the inner parts have to diffuse through the already dried product, later in the process. Thus, water needs to diffuse through the un-porous dried polymer matrix and adsorbs and desorbs constantly at the hydroxyl groups of the polymer, resulting in time-consuming processes.

Furthermore, ethanol is difficult to freeze dry in respect to its low melting point (-114 °C) and consequently low vapor pressures at this temperature. Therefore lyophilisation would be assessable just for IOLs, loaded with pure aqueous drug solutions.

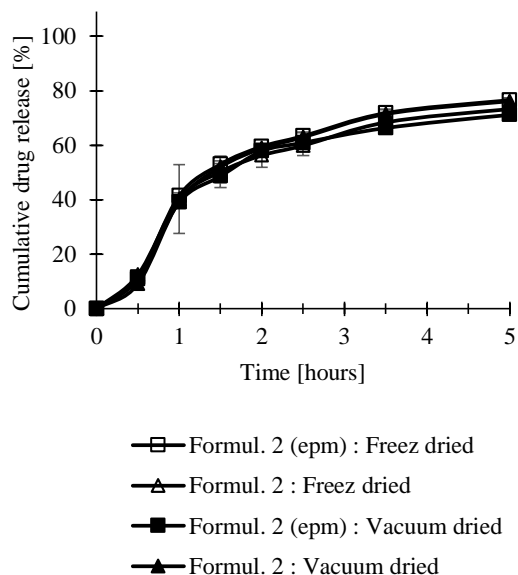

Figure 45: Drug release of dried IOLs
IOLs were loaded with diclofenac sodium in aqueous drug solutions extended polymer meshwork (epm)

In drug release study of dried IOLs (Figure 45), a pronounced lag phase was observed in the beginning and lasted for approximately 30 minutes. In this time frame, water soaked into the lens material and the flux of water was directed inwardly. As long as the water diffusion into the lens polymer was faster than the outwards directed drug diffusion, less drug release took place. After complete rehydration, the water flow nullified and the diclofenac diffusion was the main driving force for drug release. No difference between freeze-dried and vacuum dried IOLs was observed in drug release.

The only critical difference in drying process was the occurring crystal formation on IOLs which were loaded by water-soluble drugs. Whereas freeze-dried lenses had no crystals on the lens surface, on vacuum dried IOLs, crystal formation was observed.

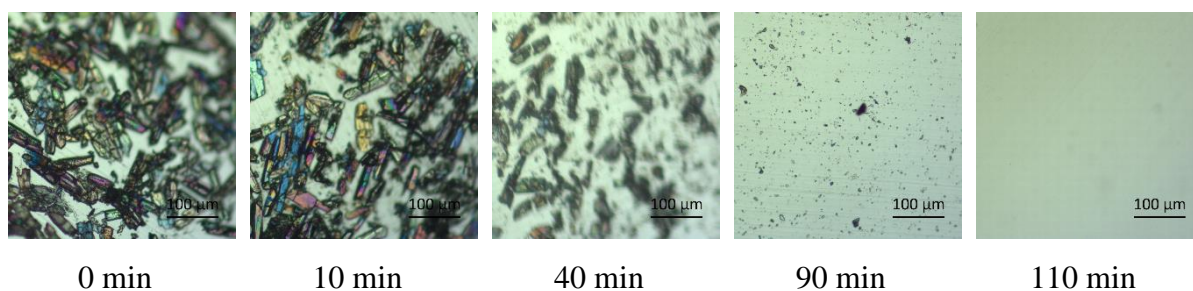

Figure 46: Crystal formation on vacuum dried lenses
IOLs were loaded in saturated aqueous diclofenac solution
In release study, crystals dissolved within 110 minutes completely

During soaking, hydroxyl groups of the polymers induced nucleation of the drug (seed crystals) [49] and in vacuum drying the diffusing liquid water dragged drug along that cumulated at the surface and crystals growth took place. These crystals dissolved in artificial aqueous humor within two hours completely (Figure 46) and transmittance of IOLs could be guaranteed. In freeze dried lenses, water was removed by sublimation from the frozen lenses and thereby, drug was not “moved” by the water. Incorporated hydrophobic drugs did not show this behaviour, because the drug was more strongly adsorbed to the polymer and the diffusing water did not perform this distinct drug transport.

For the performance of the IOLs after rehydration and in drug release study, the drying process had no influence. Therefore, vacuum drying was chosen as drying technic for all lenses, also with respect to ethanol that could be evaporated by this approach, too.

3.2.3.2.5. API

As presented in 3.2.3.2.2, for controlling the drug release, besides the polymer composition, also the API has a tremendous effect on the release. This includes solubility, size of the drug and API – polymer interactions. To investigate mainly the solubility effect, diclofenac was loaded as acid (C_s 2.37 mg/L [241]) and base (diclofenac sodium) (C_s 1.5 g/L [242]) into lenses, made of HEMA (80%) / MMA (20%) without and with water as “expanding” excipient.

Due to the different solubility, the release (Figure 47) of the salt was initially two times faster than the uncharged diclofenac. This could be explained by improved diffusion and less API-polymer interaction of the salt. Furthermore, there was just a limited amount of water available in the polymer so that just a specific amount of API was “dissolved” within the aqueous phase

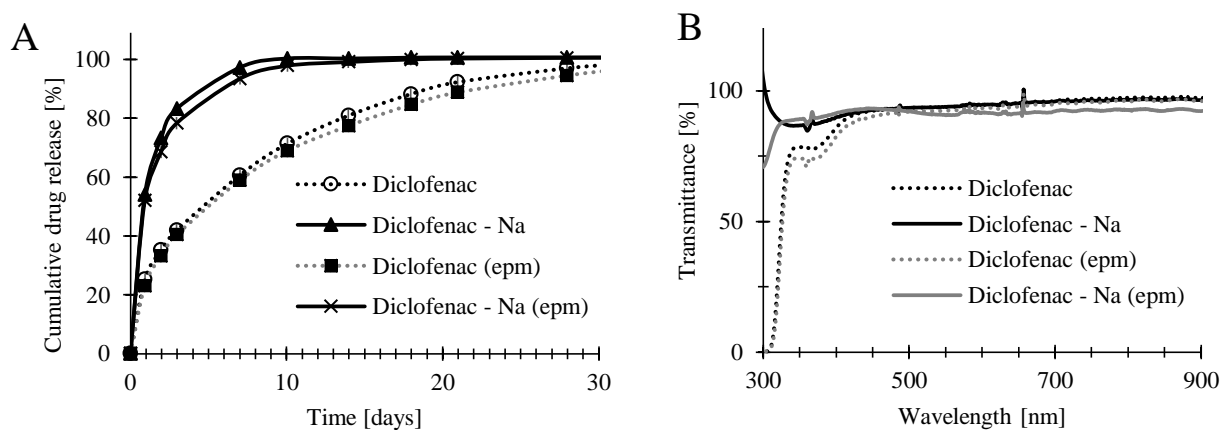

Figure 47: Lenses loaded with diclofenac (acid and salt) in IOLs containing HEMA 80 % and MMA 20 % Polymerized without and with water to obtain an extended polymer meshwork (epm)
 A: Drug release;
 B: Transmittance of lenses (2 weeks after commencing release study)

of the polymer. The other part of the drug is adsorbed onto the polymer and is not accessible for diffusion. The guiding release mechanism in hydrogels is diffusion [144,243,244] and therefore, the API has to be dissolved in the liquid phase. Furthermore, there are different types of water within the swollen hydrogels like bounded and free water [245], whereby the released API had to be dissolved within the free water, also named bulk water. The drug release of lenses, made with water in order to expand the polymer structure was just slightly faster but could be considered as similar (Figure 47 A). Besides that, hydrogels are known for first order release kinetics, due to the only diffusion guided release, as well as a burst release, in the beginning [246]. Hence, the release curves did not change by increasing or decreasing the drug loading. Adding water prior to polymerization led to a higher drug loading, due to the expanded meshwork (Table 16). Thus, in the loading step, the drugs diffused better into the lens polymer. Furthermore, the more hydrophilic salt had higher drug loadings because the polymer is also mainly hydrophilic.

Table 16: Drug loading of IOLs, loaded with diclofenac as salt and base
Lens polymer: formulation 2: HEMA (80) / MMA (20)
extended polymer meshwork (epm)

API	Formulation 2 (HEMA 80%/ MMA 20%)	Refractive index	Drug loading	
			$\mu\text{g/IOLs}$	% (w/w)
Diclofenac	-	1.4531	285.57 ± 12.42	1.42 ± 0.06
	(epm)	1.4537	324.51 ± 14.01	1.62 ± 0.02
Diclofenac sodium	-	1.4527	342.74 ± 3.95	1.71 ± 0.07
	(epm)	1.4535	380.89 ± 17.80	1.88 ± 0.09

Lenses were transparent (Figure 47 B) all the time and the refractive index was stable after one week. The decrease in transmittance (300 – 400 nm) in lenses, loaded with diclofenac (acid) is due to remaining drug within the lens matrix. Hence, the base was released completely whereas the acid was still present after 14 days and presented light absorption at this range of wavelengths. However, in the visual light (400 – 800 nm), lenses were transparent.

3.2.3.2.6. pH

Hydrogels behave differently with respect to their environment. So, factors such as pH, temperature and osmolarity play a major role in hydrogel swelling [247–249]. Besides that, also the solubility of the API might be pH dependent, which affects the loading/release.

It was tried to load diclofenac sodium in a basic solution to provide higher drug concentrations and to precipitate the drug within the lens in order to achieve a more extended release. This was performed by placing the loaded lenses in saturated acidic drug solution to form the corresponding acid within the lenses and to avoid drug leaching. Afterward, IOLs needed to be stored in a phosphate buffer (pH 7.2) to enable lens insertion.

In acid, lenses became turbid and crystals precipitated on the lens surfaces within the first few seconds. To precipitate the drug also within the lens matrix, soaking in acid needed to be prolonged for more than 30 minutes. During this time, the whole lens surfaces became covered by crystal. Drug release was slightly extended in comparison to lenses just loaded in basic drug solution but the performance was not improved strongly. It was also assumed, that formed crystals within the hydrogel might affect the polymer structure permanently which could lead to glistening. Also in respect to the different soaking media that were needed, this approach was depicted as too complex to be performed in the doctor's office directly before the surgery takes place. Nevertheless, organic solvents could be avoided and increased drug loadings with slightly extended drug release patterns were obtained.

3.2.3.2.7. Cross-linker

In polymers, the water uptake is determined by different factors, such as monomers, cross-linker and the physical/chemical environment. In more cross-linked polymers, the polymeric chains are linked more strongly and water uptake decreases (Table 17). Thus, lenses (formulation 1) which were stored in an aqueous 0.5% propranolol hydrochloride solution for 6 days (37°C) had less drug uptake when the polymers contained a higher degree of cross-linker. This long soaking time was used to ensure that drug distribution of lens polymer and soaking solution reached equilibrium. This could be proven by constant drug concentrations in soaking media.

Table 17: Drug loading and water uptake of IOLs polymerized with various amounts of cross-linker; % (w/w); mean values \pm SD

Cross-linker [%]	Drug loading [%]	Water uptake [%]
0.01%	6.12 \pm 0.02	56.67 \pm 1.32
1.00%	5.93 \pm 0.46	53.68 \pm 0.07
1.50%	5.37 \pm 0.04	52.82 \pm 0.18
5.00%	5.03 \pm 0.35	41.35 \pm 0.12

Additionally, lenses with more ethylene glycol dimethyl acrylate became more robust and a higher force was needed to fold them (Figure 48 B). Lenses, containing 5% cross-linker were difficult to bend and small cracks occurred, when IOLs were folded. While the drug loading was decreased in more cross-linked formulations, the drug release curves were similar (Figure 48 A). If more cross-linker would be added, the release would be more extended but foldability would not be provided anymore. Thus, providing a more extended release by using more cross-linker is not feasible. For marketed IOLs, a cross-linker amount of 0.1 – 5.0% is suggested, depending on the monomers and their physical/chemical properties [187,189].

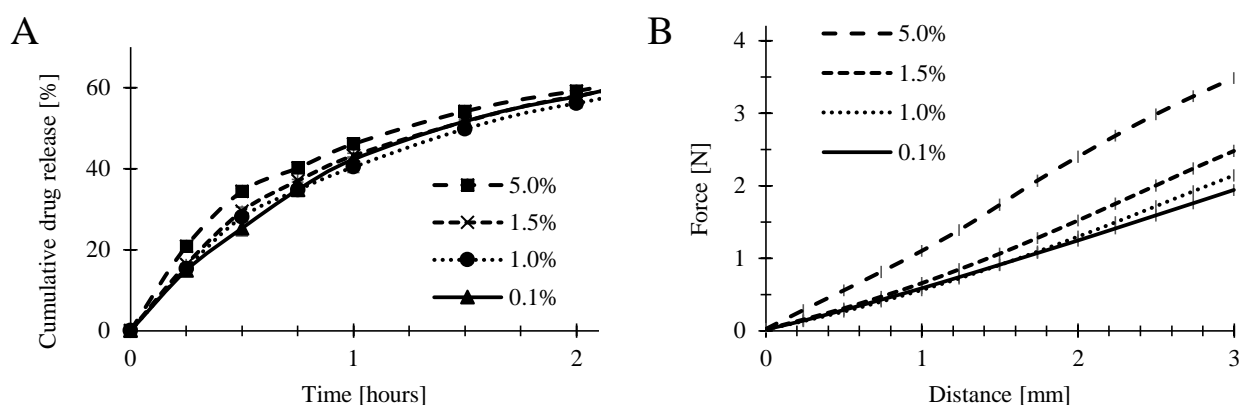

Figure 48: Lenses prepared with different amounts of cross-linker
 A: Drug release of IOLS, soaked for 6 days in 0.5% propranolol-HCl solution
 B: Force/path diagram of IOLs

3.2.3.2.8. Dyes

To prove drug distribution within the lenses, dyes (methylene blue, quinoline yellow and phenol red) were loaded as model drugs and release studies were conducted. By this approach, dye-delivery could be analyzed in the release media but by lens transmittance as well (Figure 49).

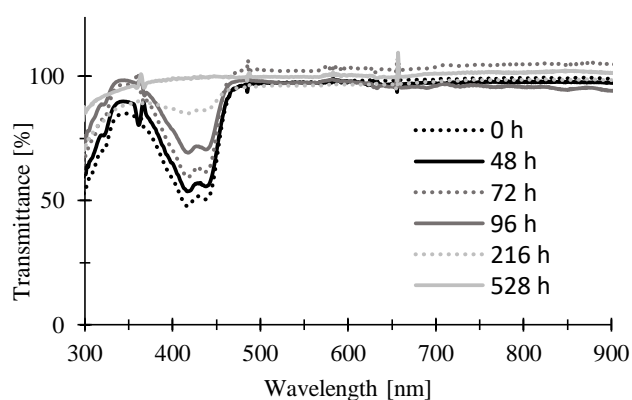

Figure 49: Transmittance of quinoline yellow loaded lens during release

Consequently, lenses were placed in the light beam of an UV-VIS spectrometer and transmittance of IOLs was recorded.

Loaded lenses were toned homogeneously in case of all dyes, suggesting that drugs are dispersed homogeneously within the lens matrix as well. During the release, lenses eluted the dyes uniformly and became clear and transparent again (Figure 50). At the end, lenses had optical characteristics as lenses that were not loaded, indicating, that the polymer matrix did not change during loading procedures and that 100% drug release could be ensured.

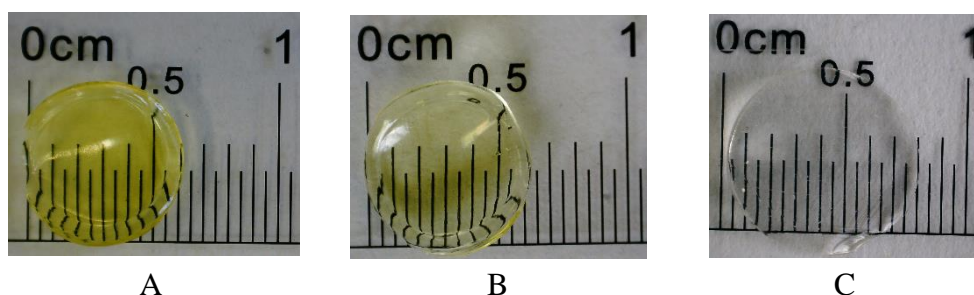

Figure 50: Lens loaded with quinoline yellow
 A: Directly after loading, before release study
 B: After 24 hours
 C: After 528 hours

3.2.4.3. Functionalized monomers

Besides the hydrophilic – hydrophobic character of monomers, drug release also could be modified by using functionalized monomers like [2-(Methacryloyloxy) ethyl] trimethyl-ammonium chloride, a permanently charged monomer, due to the quaternary ammonium group. Thus, IOLs containing charged monomers have similarities with ion exchange resins, common excipients for prolonged drug release [203,250,251]. Charged drugs, functioning as counter ions for the functionalized monomers, were loaded into the polymer. Within the eye, ions from the aqueous humor can replace drug molecules and an extended drug release takes place.

The charged monomer was supplied with some quantities of water (20%) as an inhibitor to avoid premature polymerization. To keep the amount of water in polymerization equal, for formulations containing less [2-(Methacryloyloxy) ethyl] trimethyl-ammonium chloride, corresponding amounts of water were added. As further compounds, cross-linker (0.5%), initiator (0.5%) and 2-hydroxyethyl methacrylate as monomer were used.

Lens formulations contained 0%, 2.5%, 5.0%, 7.5% and 10.0% charged monomers and were loaded by keeping them immersed in aqueous diclofenac sodium solution (0.1%) for 5 days (pH 7.2) in order to saturate the ion exchange resin. It was expected, that the negatively charged

diclofenac (deprotonated carboxyl group) would become the counter ion of the positively charged quaternary ammonium group.

Dry lenses were brittle, whereas hydrated lenses were flexible and transparent. To analyse hardness of soaked IOLs, polymers were fixed in a texture analyser and the force [N], needed to fold the lenses, was recorded. Lenses, prepared just by 2-hydroxyethyl methacrylate were foldable and had expected elastic properties. By increasing the amount of [2-(methacryloyloxy) ethyl] trimethyl-ammonium chloride to 2.5%, the polymer became more robust (Figure 51 B), because the charged functional groups repelled each other. This mechanism is similar to gels, prepared with polyacrylic acid [252,253]. With higher amounts of functionalized monomers, the polymers became more flexible again so that the formulation, containing 10% [2-(Methacryloyloxy) ethyl] trimethyl-ammonium chloride had same elastic properties than lenses, prepared just by 2-hydroxyethyl methacrylate.

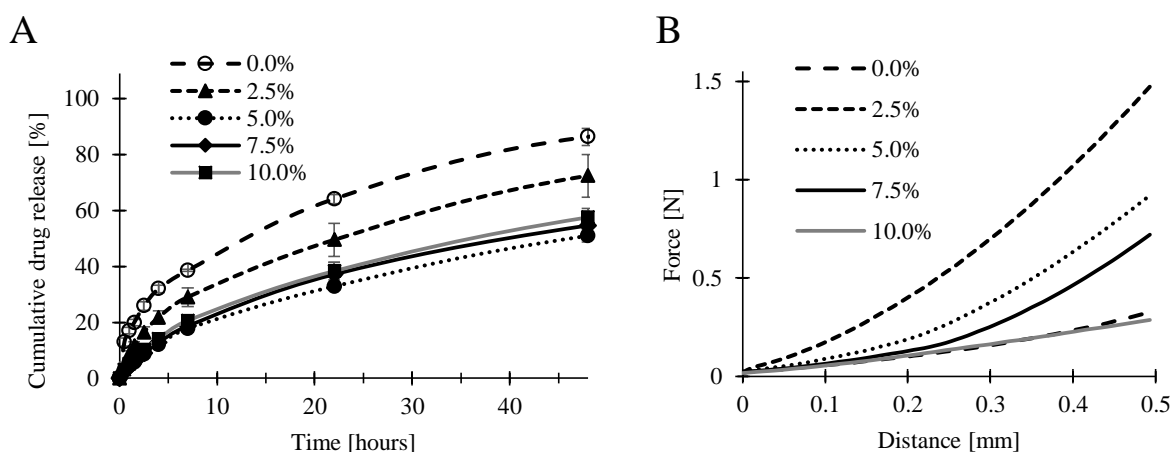

Figure 51: IOLs containing functionalized monomers

A: Drug release

B: Force/path diagram of polymers

The decrease in hardness in contrast to higher amounts of charged monomers is due to the increased water uptake (Table 18). Water functioned as a plasticizer and furthermore, by more water within the structure, the distance between the monomers was increased, followed by less strong repulsion. Resulting in the higher water uptake, the refractive index decreased as well. Homopolymers of [2-(Methacryloyloxy) ethyl] trimethyl-ammonium chloride had a water uptake of 2000% and were not robust at all. Although cross-linker was used, the formulation collapsed when touched.

Table 18: Characterization of IOLs, containing [2-(Methacryloyloxy) ethyl] trimethyl-ammonium chloride (mean values \pm SD)

Amount of charged monomer [%]	Water uptake	Drug loading [%]	Refractive index
0.0	56.95 \pm 0.60	0.15 \pm 0.00	1.4340
2.5	59.28 \pm 0.19	0.83 \pm 0.02	1.4320
5.0	73.03 \pm 0.43	1.16 \pm 0.05	1.4230
7.5	100.11 \pm 1.31	1.16 \pm 0.06	1.4125
10.0	132.45 \pm 0.99	1.06 \pm 0.01	1.4029

The release could be extended (Figure 51) when charged monomers were copolymerized within the formulation as drug loading increased as well. But on the other hand, the water uptake also increased so that the prolonging released and increased drug loading remained constant in polymers, containing more than 5% of [2-(Methacryloyloxy) ethyl] trimethyl-ammonium chloride.

3.2.4.4. Osmolarity

Recently, “intelligent polymers” (or smart polymers) gained attention in pharmaceutical technology. By this name, hydrogels are described, that adapt their behavior to various physical or chemical triggers [254–256]. Thus, scientists had created different DDS, that response to biological factors and performed advanced drug targeting [257] and used this technic for ocular devices [254] as well.

The prepared hydrogel (formulation 2), containing 2-hydroxyethyl methacrylate (80%) and methyl methacrylate (20%) had this behavior as well. The swelling was less dependent on temperature and pH, but the osmolarity changed it remarkably. Sodium salicylate is very soluble ($> 1000\text{g/L}$) [258] and was dissolved in concentrations up to 30% in water. Higher concentrated soaking solutions were not used in respect to increased viscosity. Thus, lenses were loaded in aqueous soaking solutions for 5 days, containing 0%, 5%, 10%, 20% and 30% sodium salicylate respectively. During loading, lenses swelled and the lens diameter increased (Figure 52).

Results and discussion

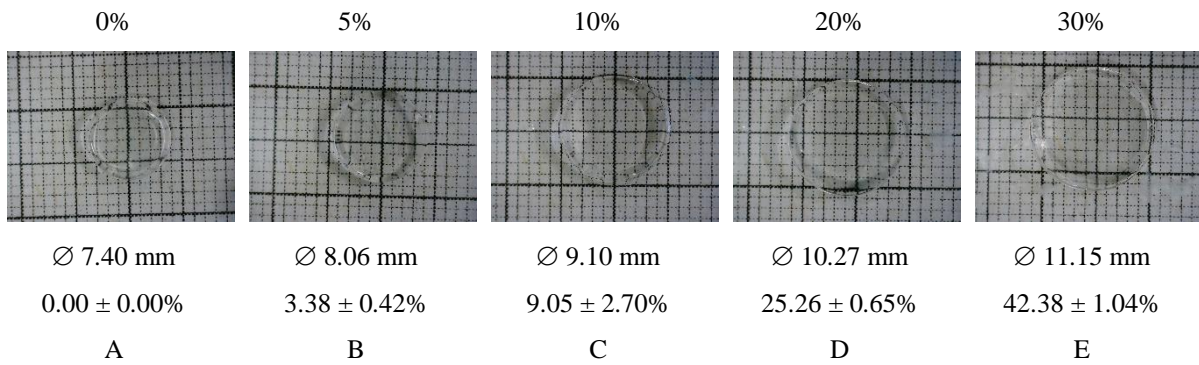

Figure 52: Lenses soaked in different concentrated aqueous sodium salicylate solutions
 Above images: sodium salicylate concentration in soaking media
 Below images: Diameter of swollen lenses and the drug loading

The loading was completed after 1 day, due to the high water content within the lens and the small drug molecule, resulting in fast diffusion. From each batch, three lenses were dried and release study was conducted with dried and undried lenses respectively (Figure 53 A). During drying, lenses decreased in size, but initial dimensions were not restored.

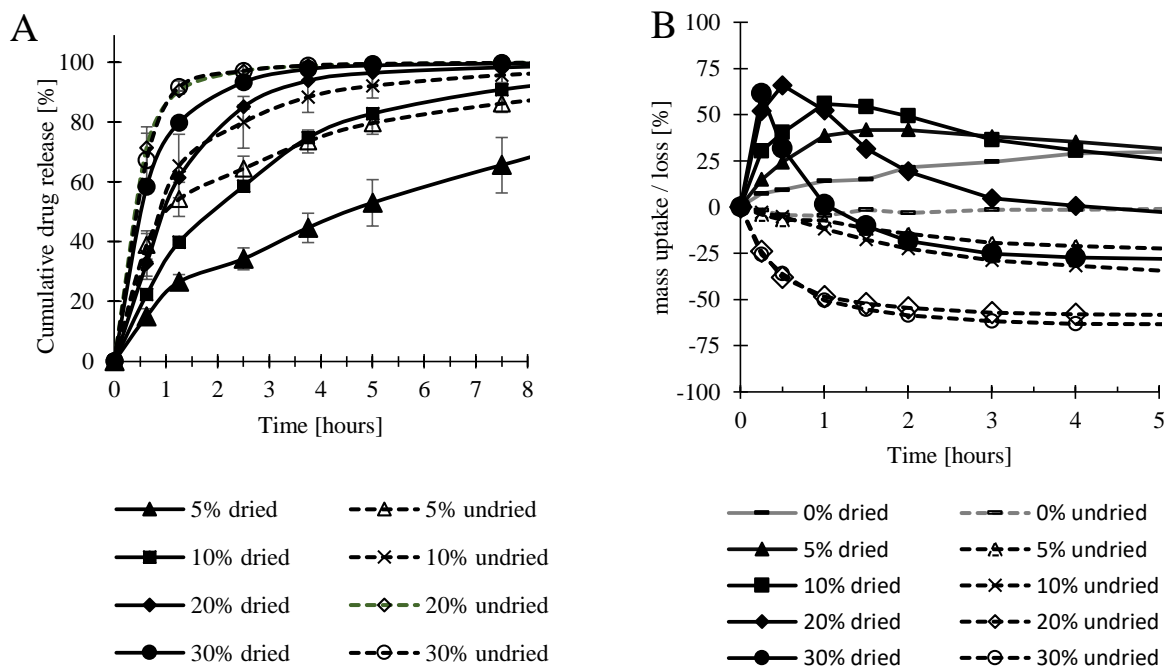

Figure 53: Osmolarity effects on drug release and IOL swelling
 Legend: [%] describe the drug concentration in soaking solution
 A: Drug release of dried and undried IOLs, loaded with sodium salicylate in various concentration
 B: Mass uptake / loss of IOLs in the first hours of drug release

As expected, dried lenses released the API slower because the water needed to diffuse in the lens matrix initially, whereas undried lenses were hydrated already. The fastest release was observed with lenses, soaked in 30% sodium salicylate. Caused by the high drug concentration

and consequently higher osmotic pressure, more water soaked into the lens and diffusion was improved. Furthermore, the concentration gradient towards the release media was increased in lenses, presenting higher drug loadings.

Undried lenses loosed weight during release study. By released API, also less water was present and consequently, the mass decreased as well as the diameter of the IOLs. Dried IOLs which soaked in 30% sodium salicylate solution, showed initial weight gain in release study with later mass decrease below the weigh prior release. In the beginning, by the high drug loading, followed by an increased osmotic pressure within the lens, water soaked in. By time, drug was released and the osmotic pressure in the lenses decreased, resulting in less water in the hydrogel. All loaded lenses had this initial mass increase but just for the highest loading, the water uptake could not compensate the mass decrease, resulted by released drug. Initial IOL size, shape and mass was restored, after complete drug release.

Normally, purely diffusion controlled drug delivery systems release drugs in first-order kinetics, which is independent of the drug loading. However, hydrogels that swell depending on the osmolarity of the environment have release kinetics that might change in respect to the drug loading even when they are known for just diffusion controlled release.

To investigate the status of API in intraocular lenses, DSC was conducted and no melting peaks for sodium salicylate were detected, proving that the drug was dispersed monomolecularly in the IOLs, also named monolithic solution [177,259].

3.2.4.5. Loading at the lateral surface

3.2.4.5.1. Loading for polymer rods

Lenses are prepared either by polymerization in the final shape (molding) or by the conventional lathe cut technology [260]. When the drug loading is performed by the soaking of intraocular lenses, the API is distributed within the whole soaked lens matrix, but it might be reasonable, to load the API just in specific areas of the lens. This would apply for APIs that affect the optical characteristics of the IOLs such as precipitating or colored drugs.

Thus, polymer rods were immersed in ethanolic sodium salicylate solution for 24 hours. Afterward, polymer rods were dried and lenses were lathed out (Figure 54 A). At the end of the loading, the core in the inner part of the rod was not swollen and still brittle.

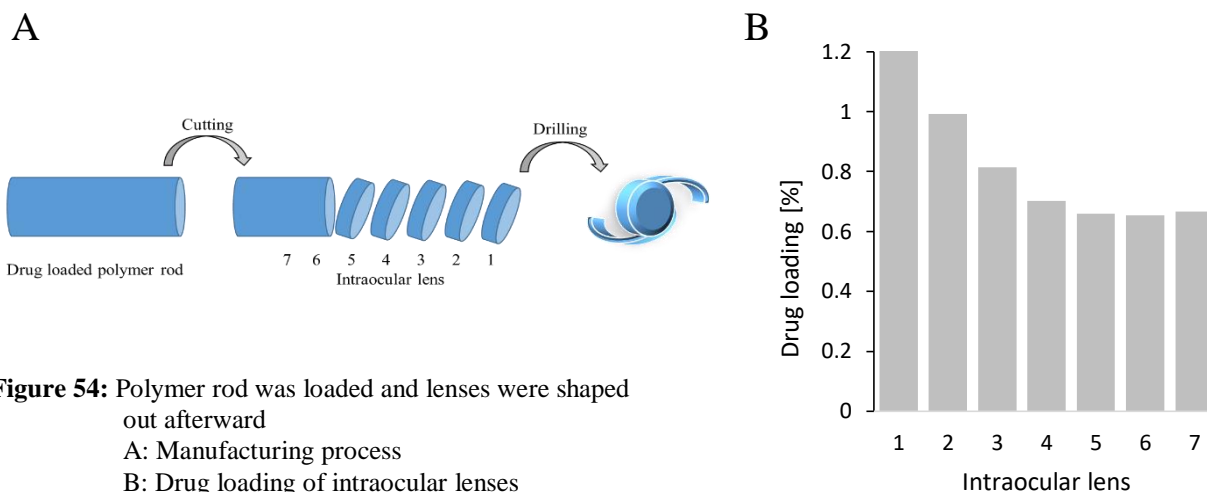

Figure 54: Polymer rod was loaded and lenses were shaped out afterward

A: Manufacturing process

B: Drug loading of intraocular lenses

When lenses were loaded by soaking methods, the solvent diffused from the surfaces into the polymer and the drug incorporation was performed in the same sequence. When soaking was limited in time and inner parts of the matrix remained unsoaked, the drug loading for lenses that were shaped out from the inner part of the polymer rod had less drug loading.

Therefore, it was assumed, that these lenses had no drug in the centre and the optical part of IOLs would not be affected by drugs. This would provide the possibility to load various drugs, also these ones that would have devastating effects on the optical quality. The diameter of the optical part of intraocular lenses has 5-7 mm [33], however, the outer rim is not needed for vision. This part is required to attach the haptic, provide stability and to avoid spherical aberrations, but it would not affect optical performance if it is not transparent.

3.2.4.5.2. Homopolymer

To achieve lateral drug loading, polymer rods were kept immersed in quinoline yellow and methylene blue solutions for 2 hours and were dried afterward. Lenses were drilled out and evaluated.

Polymer rods were completely covered by the dye, but transparency in the core was retained (Figure 55). Methylene blue was selected as a strong dye [261] and could be detected visually even in small amounts.

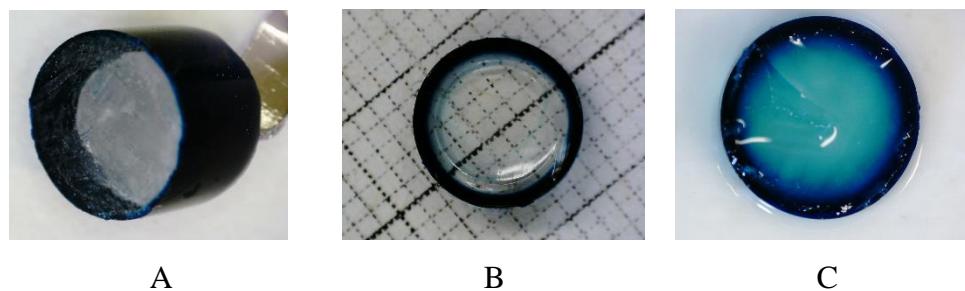

Figure 55: Lens loaded in the lateral area with methylene blue
A: Loaded polymer rod
B: Drilled intraocular lens
C: IOL in release study

Lenses were placed in vials, containing 8 ml artificial aqueous humor and release study was conducted accordingly to the general protocol. However, lenses that were transparent in the beginning became blue by time and methylene blue discolored the center of IOLs. In contrast, quinoline yellow loaded lenses remained transparent in the central part and by time, also the rim became transparent again, due to released model drug.

In order to understand the mechanism in discoloration of methylene blue loaded lenses, release study was repeated in bigger volume (60 liter) (n=1) to dilute the release media. Additionally, another batch was released in vials, containing 1 liter release media (n=3) and one unloaded IOLs was added into each vial as well. Complete media exchange was performed for both trials every 24 hours.

The lens that was released in the 60 liter container became transparent after one month and the core discolored just slightly. In comparison, the methylene blue loaded lenses that were placed in 1 liter vials became blue in the core and the unloaded lens as well. The core of both IOLs had the same color intensity. This indicated that the dye was released from the intraocular lens but diffused into the polymers again and that the discoloration of IOLs could not be attributed to methylene blue diffusion within the polymer matrix. So, partition took place twice, first, methylene blue was released from the high concentrated lateral area of the intraocular lens into the buffer and secondly from the buffer into the polymer matrix again. This happened, without a pronounced visual discoloration of the released media, suggesting, that the partition coefficient of methylene blue between lens polymer and aqueous release media is high.

Therefore, the partition coefficient for the hydrophilic IOL formulation was determined for methylene blue and drugs, used in this study (Table 19).

Table 19: Partition factor of different drugs in IOLs and artificial aqueous humor
 Lens formulation: 2-Hydroxyethyl methacrylate (80%) / Methyl methacrylate (20%)
 with and without water as expanding excipient (epm)

Model drug	without water	with water (epm)
Diclofenac sodium	13,67	18,00
Dexamethasone	17.51	13.48
Sodium salicylate	17.52	13.38
Propranolol hydrochloride	110.78	102.27
Methylene blue	625.55	532.32

The ciliary epithelium produces approximately 2.0 $\mu\text{l}/\text{min}$ (~2.9 ml/day) aqueous humor [262,263]. Therefore, the whole aqueous humor (0.2 – 0.4 ml/eye) is replaced within a few hours, however, a drug that has a strong tendency to diffuse into the lens polymer and has low permeability could cumulate in the eye and diffuse into the lens polymer again.

For all APIs (Table 19), optical properties in the inner part of laterally loaded lenses were not affected during release study and release patterns were similar to lenses in which the drug was incorporated within the whole polymer matrix. Since less polymer is assessable in lateral loaded IOLs, the drug loading decreased in comparison to lenses that were loaded completely.

3.2.4.5.3. Lateral - polymer - coating

Since drug loadings at the lateral surface avoid optical adverse effects of incorporated drugs, the drug loading capacity should be increased in order to improve this approach. Therefore, lens formulation 2, containing 2-hydroxyethyl methacrylate (80%) and methyl methacrylate (20%) was coated by formulation 1, just comprising 2-hydroxyethyl methacrylate as monomer. Therefore, prepared polymer rods (formulation 2) with a diameter of 6 mm were placed in the middle of vials (diameter of 8 mm), which were filled with the un-polymerized formulation 1. Then, polymerization, purifying and lathing process was conducted as normal. So, lens polymer 1 was polymerized as coating onto lens formulation 2. By FT-IR, it was proven, that the two different polymers were not mingled. For comparison, lenses for both formulations were also prepared separately.

For lens formulation 2, higher forces were needed to fold the lenses (Figure 56) than for polymers, just prepared by HEMA. The force that had to be applied to fold the coated lenses was between those of formulation 1 and 2 because it was a combination of them.

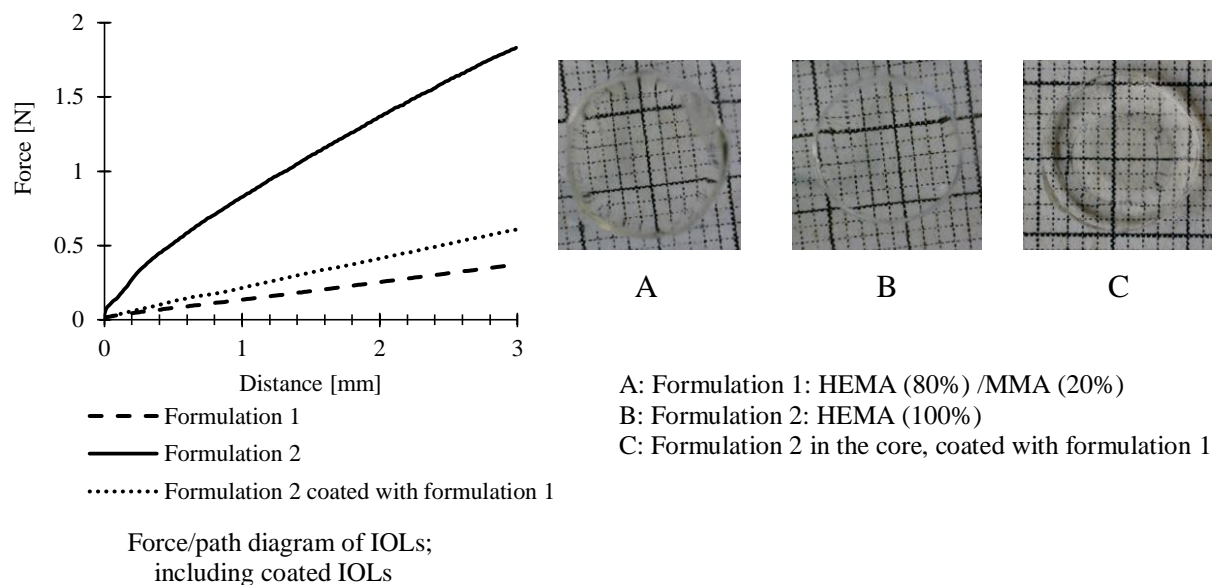

Figure 56: Hydrophilic IOLs
 Formulation 1: HEMA (80%) /MMA (20%)
 Formulation 2: HEMA (100%)

All lenses were transparent and had good optical properties (Figure 56). Attributed to the core, composed of HEMA and MMA, the refractive index of 1.4470 could be retained also for coated lenses (Figure 57 B). The drug loading for coated hydrophilic lenses in comparison to lenses from formulation 2 could be increased, due to the higher loading capacity of lens formulation 1. In release study, the formulation that just contained HEMA released the drug fast, due to the higher water content of this purely hydrophilic composition. In contrast, formulation 2 had less drug loading, but the release was more extended (Figure 57 A). In the coated formulation, these properties were combined so that advantages of formulation 2 (higher refractive index, extended release) could be combined with the advantage of formulation 1 (higher drug loading). Therefore, the coated formulation was superior to lenses, just prepared by one polymer.

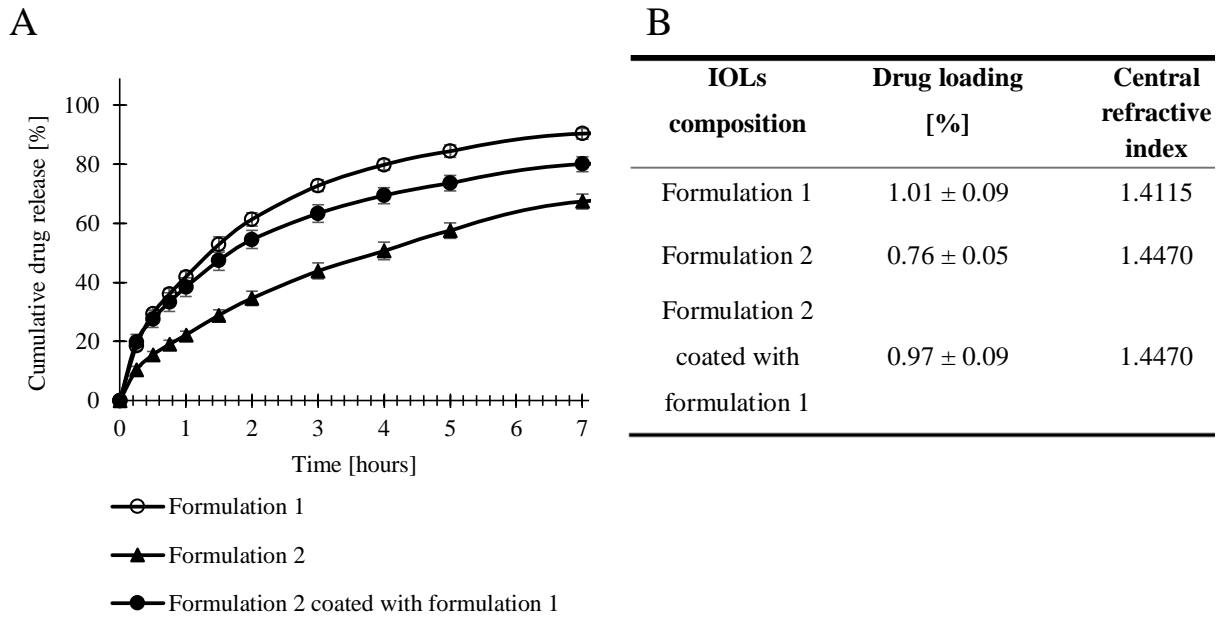

Figure 57: Hydrophilic lenses (formulation 2, coated with hydrophilic polymer (formulation 1))
 A: Drug release of IOLs; Hydrophilic polymer coating polymerized on IOLs
 B: Drug loading and refractive index

To investigate the release kinetic from IOLs, release data was plotted in a “Higuchi plot” and as drug content within the lens against the time in a semi-logarithmic diagram (Figure 58).

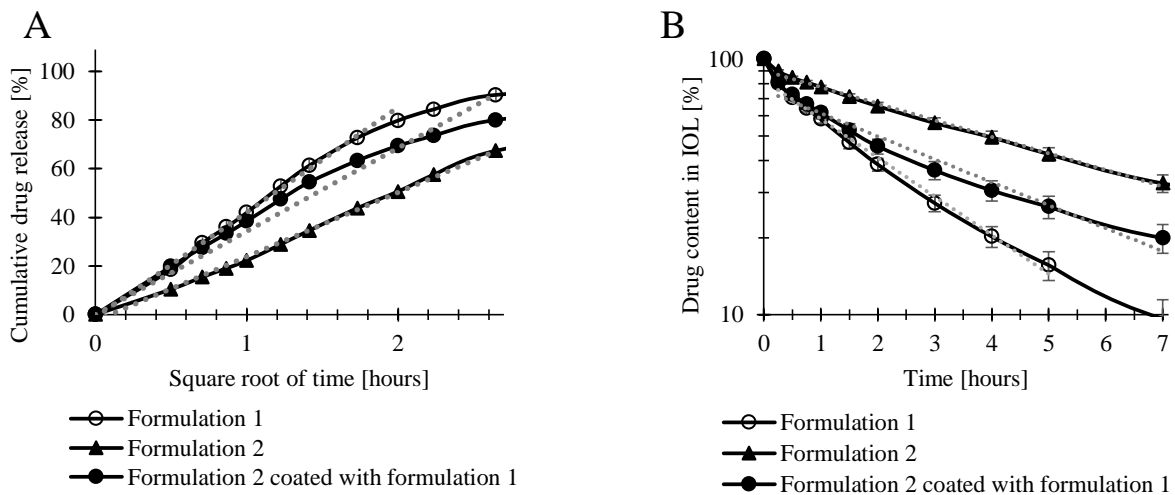

Figure 58: Evaluation of drug release kinetics
 A: Higuchi plot to prove a diffusion controlled release;
 B: Semi-logarithmic diagram of drug content in IOLs against the time

Both procedures showed almost linear curves for the drug release up to 80% for lenses, just containing one polymer formulation. The R2 values of the regression curves were close to 1, indicating, that the fitting is very well (Table 20). Therefore, by this empiric investigation, it could not be distinguished between first-order kinetics and square root of time kinetic. The drug

release became slightly slower when more than 80% of API was eluted, due to less drug within the lenses. Therefore percentage-wise, more drug was adsorbed to the polymer [217,218] and partition of free and adsorbed drug gained importance.

Table 20: R2 Values of linear regressions for Higuchi plot and semi-logarithmic release plot

	Higuchi plot	Semi-logarithmic plot
Formulation 1	0.9976	0.9966
Formulation 2	0.9969	0.9923
Formulation 2 coated with formulation 1	0.9592	0.9703

The fitting of regressions curves was worse for lenses that were coated, suggesting, that drug release was not uniform. It could be explained by the simultaneous drug release from different formulations and therefore, overlaying release patterns.

However, with this approach, the drug loading could be increased by the outer coating and the extended release could be retained by the core as well. Besides the soaking time, drug concentration and various other factors, the drug loading could be tuned by the coating level, so that more / less coating would be assessable for drug loading. Due to the inner part, the higher refractive index was retained and no spherical aberrations took place when the threshold between core and coating was not in the optical area of the lenses. Additionally, 100% transmittance was guaranteed. Attributed to the hydrophilic character of both formulations, the coating adhesion was good and no coating detachment was observed. Furthermore, soaking could be performed in aqueous drug solution and organic solvents were avoided in order to facilitate a drug loading directly prior to the surgery.

3.2.4.6. Coating

Hydrophilic lenses are simple to load by soaking methods but have fast drug release, accompanied by an initial burst release. To avoid this limitation, drug-loaded hydrophilic lenses, made of polyHEMA (drug loading: $2.03 \pm 0.24\%$) were coated with ethyl cellulose, functioning as a diffusion barrier to prolong the drug release and to minimize burst release. Lenses were coated in a pan coater system by 0.4 mg or 0.8 mg ethyl cellulose per IOLs and drug release study was conducted (Figure 59).

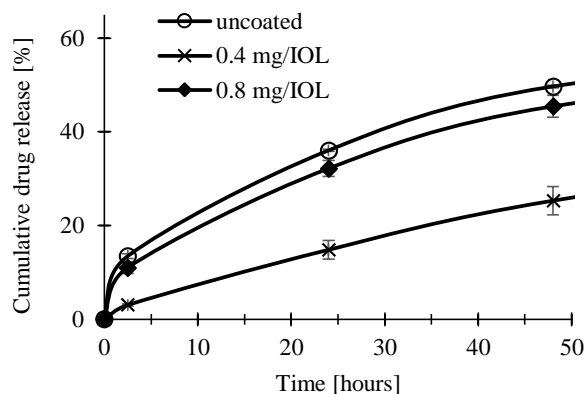

Figure 59: Drug loaded hydrophilic lenses coated with ethyl cellulose as diffusion barrier (mg gives the amount of ethyl cellulose coating per IOLs)

The coating was so thin, that the refractive index was not changed and light transmittance was still 100%, due to a complete transparent coating. But foldability of lenses could not be preserved because the brittle ethyl cellulose coating detached during bending.

Ethyl cellulose was capable to prolong the release with small coating levels, but when coating level was increased, the drug release was similar to uncoated IOLs attributed to detached coatings. This defects in adhesion were observed, even during the coating process. Swollen lenses which were coated decreased the volume attributed to evaporating water from the hydrogel resulting in changed lens size. When dry IOLs were coated, the coating stuck to the lenses, but when lenses were immersed in water, lenses swelled and the ethyl cellulose detached. So, IOLs had to be coated in swollen state very gentle at temperatures below 45°C to avoid immense water evaporation from the hydrogels.

However, when coatings level was too high, ethyl cellulose detached and did not function as diffusion barrier anymore. This could be attributed also to the different hydrophilic – hydrophobic nature of the hydrogel and ethyl cellulose.

3.2.4.7. Dual drug loading

3.2.4.7.1. Dual drug loading by rehydration

To prepare drug-eluting intraocular lenses, nowadays, hydrophilic IOLs are loaded directly before the application takes place by soaking in aqueous drug solution [65,115,137]. This method is just approachable for hydrophilic drugs that can be dissolved in high amounts in water and have the tendency to diffuse into the hydrophilic lens material. To combine the previous results with this approach, lenses were loaded with dexamethasone in ethanolic drug solution and were dried afterward. Rehydration was carried out with an aqueous sodium

salicylate solution (1% (w/w)). During the rehydration, the dexamethasone loaded lenses were additionally loaded by the sodium salicylate (C_s : > 1000 g/L) [258]. Due to the low solubility of dexamethasone (C_s : 89 mg/L) [264], it was expected that just a small amount of dexamethasone would be released into the soaking/rehydration media. Lenses were kept immersed for 1 hour, 3 hours and 5 hours at 25°C in rehydration and loading media respectively. In release study, the sodium salicylate was released fast, so that more than 90% of the API was eluted already within the first 24 hours (Figure 60) for pure pHEMA lenses (formulation 1). For lens polymers, containing 20% methyl methacrylate (formulation 2), the release was slightly slower, however, 80% was released in the same time period. With longer soaking time, the drug loading could be increased (Table 21), but the release pattern remained similar. This burst release could be explained by the small molecule size and the high water solubility of the API. In contrast, by prolonging the rehydration time within the soaking media, dexamethasone started to diffuse out and typical burst release for hydrogels took place partially already in this loading step. By this procedure, less dexamethasone would get into the eye and the initial high API concentrations within the eye would be avoided slightly. The gradually reduced release of dexamethasone at the end is desired because the dosage of steroids is tapered off to avoid side effects after the administration of steroids in general [265,266]. IOLs polymerized with water presented higher drug loadings in general but also slightly faster releases, due to the internal expanded structure of the polymer (Figure 60).

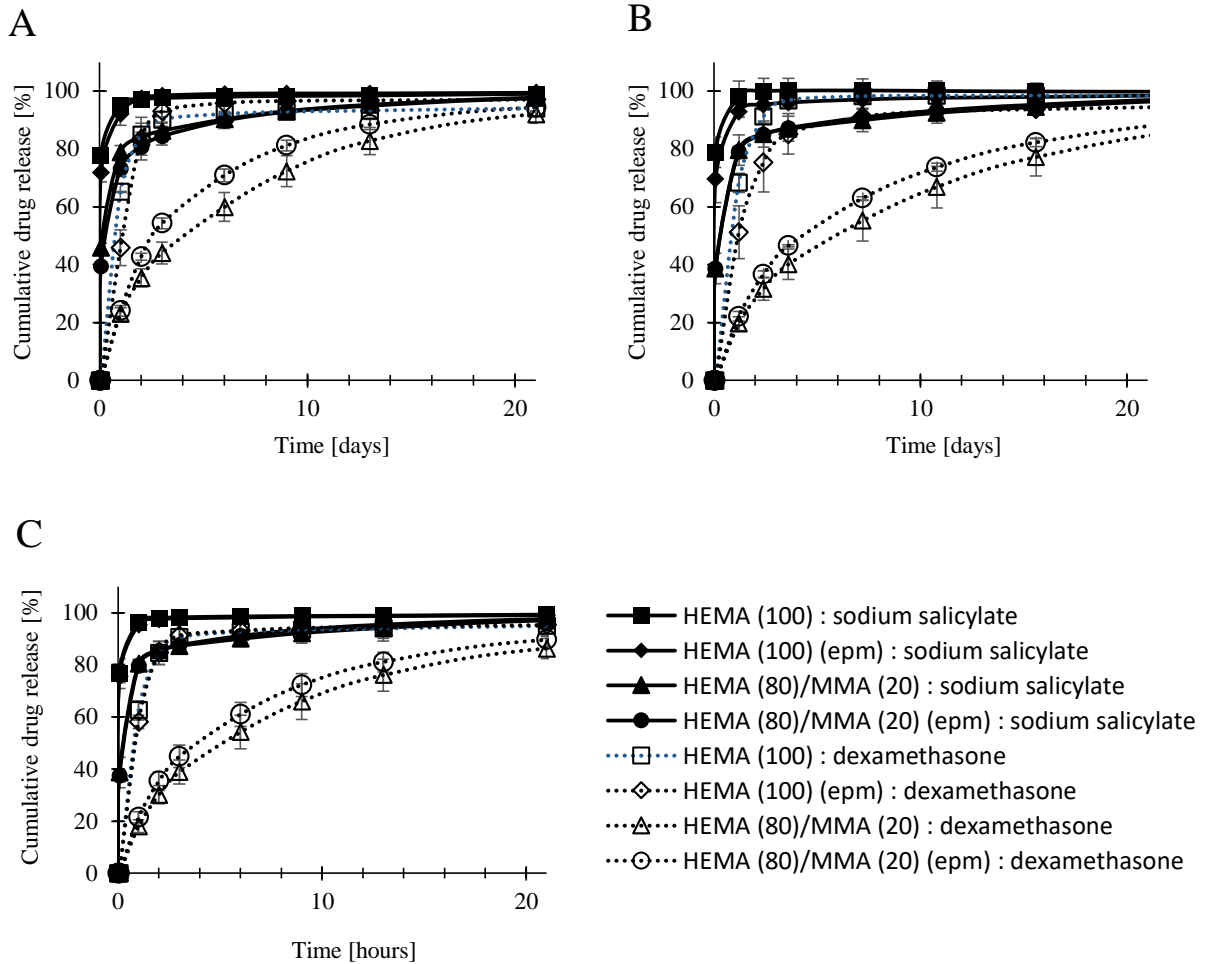

Figure 60: Drug release of dual loaded lenses, Dexamethasone was pre-loaded and sodium salicylate was loaded in rehydration step
 A: 1 hour rehydration
 B: 3 hours rehydration
 C: 5 hours rehydration

Furthermore, soaking times of more than 5 hours were not reasonable since the loading equilibrium for pure HEMA formulations was already achieved and dexamethasone release/leaching would be more distinct.

For rehydration of the lenses, 30 minutes were needed to make the lenses flexible and foldable again. Consequently, shorter loading/rehydration times for the hydrophilic API were not rational.

Results and discussion

Table 21: Drug loading for dual loaded lenses
(mean values \pm SD [%]); Polymerized without and with water to obtain an extended polymer meshwork (epm)

	API: Sodium salicylate			API: Dexamethasone		
	Rehydration/soaking			Rehydration/soaking		
	1 h	3 h	5 h	1 h	3 h	5 h
HEMA (100)	0.55 \pm 0.05	0.61 \pm 0.02	0.62 \pm 0.01	0.57 \pm 0.05	0.48 \pm 0.01	0.47 \pm 0.01
HEMA (100) (epm)	0.55 \pm 0.03	0.68 \pm 0.02	0.67 \pm 0.05	0.71 \pm 0.04	0.66 \pm 0.04	0.56 \pm 0.05
HEMA (80)/MMA (20)	0.24 \pm 0.01	0.32 \pm 0.01	0.40 \pm 0.01	0.88 \pm 0.01	0.85 \pm 0.03	0.87 \pm 0.01
HEMA (80)/MMA (20) (epm)	0.31 \pm 0.02	0.39 \pm 0.01	0.47 \pm 0.05	1.39 \pm 0.08	1.20 \pm 0.04	1.17 \pm 0.02

The refractive index of all lenses was stable after 24 hours and remained constant over 6 months (Table 22) of the testing period. Additionally, 100% light transmittance was ensured for all lenses.

Table 22: Refractive index of dual loaded lenses
(mean values \pm SD)
expanded polymer meshwork (epm)

Formulation	Refractive index
HEMA (100)	1.4245 \pm 0.0020
HEMA (100) (epm)	1.4250 \pm 0.0001
HEMA (80)/MMA (20)	1.4517 \pm 0.0002
HEMA (80)/MMA (20) (epm)	1.4533 \pm 0.0012

This approach is promising, especially, if one drug is very hydrophilic and could be loaded by soaking in aqueous media directly before the surgery takes place. In contrast, the other drug must have an extended release to avoid a prominent drug release in rehydration/loading media. Furthermore, if interactions of both drugs could not be precluded, this might be a promising method in order to load two APIs and to achieve simultaneous release, considering that both drugs are present within the lens only for a short time.

In general, if a fast release is required, a pure hydrophilic lens formulation should be selected, for a more extended release, the formulation with 20% methyl methacrylate is superior.

3.2.4.7.2. Dual drug loading in advance

In case, interactions of the APIs are not critical, it is also possible to load both drugs into the lens prior the lenses are delivered to the surgeon. By this approach, lenses are delivered in dry conditions and can be rehydrated immediately before the surgery. This leads to a more stable product due to the vacancy of water and stability issues in solutions. As relevant ophthalmic drugs, diclofenac sodium and dexamethasone were selected and loaded into lenses, made of hydroxyethyl methacrylate (80%) and methyl methacrylate (20%) in order to have an extended release. Diclofenac also might be contemplated as a model drug for an antibiotic API.

3.2.4.7.3. Rehydration procedures

Lenses were rehydrated for 30 minutes at room temperature using two different media: A) 1 ml saturated API solutions or B) 0.1 ml isotonic NaCl solution (0.9%). Isotonic saline solution is common for IOLs and the saturated drug solution was selected in order to avoid API leaching during rehydration. A reference batch C) was not rehydrated. All lenses that suffered rehydration were flexible and foldable after this treatment. Furthermore, the original shape of lenses was restored. Lenses loaded with diclofenac had the highest mass uptake (Table 23). Loaded diclofenac exerted an osmotic pressure, thereby drawing more water into the lens matrix, hence, the weight gain. Dexamethasone loadings had less impact on the osmotic pressure due to its low solubility. Thus, less water diffused into the lenses. In dual loaded lenses, the increased mass was similar to the diclofenac loaded lenses. However, in lenses soaked in 0.9% sodium chloride solution, the mass uptake was less. This could be explained by the small volume of rehydration media and the released API from the IOLs into the rehydration media. So, the osmotic pressure increased in rehydration media and less water soaked into the lenses.

Table 23: Mass uptake (mean value \pm SD (% (w/w)) during rehydration
 Rehydration in:
 A: 1 ml saturated API solution
 B: 0.1 ml 0.9% sodium chloride solution
 C: No rehydration

	A	B	C
Dexamethasone loaded	15.14 \pm 1.76	13.14 \pm 0.22	-
Diclofenac – Na loaded	49.27 \pm 3.59	23.47 \pm 1.88	-
Dual loaded	49.08 \pm 1.37	21.88 \pm 1.80	-

3.2.4.7.4. Drug loading and release study

Drug loadings of about 2% with respect to the lens mass were achieved for dexamethasone and diclofenac (Table 24). In dual loaded lenses, the complete drug loading was close to 4% (2% dexamethasone and 2% diclofenac). In lenses, rehydrated in saturated API solution, a slightly higher drug loading could be observed, because, in rehydration step, additional API was uptaken by the lenses. During rehydration step, water diffused into the lens polymer and dragged drug along with it. Because diffusion of water with dissolved API was faster than the outwards directed diffusion of the API, the amount of drug within the lens increased. The decrease in drug loading of dexamethasone in loaded lenses could be explained by the removal of dexamethasone from the surface of the lenses. Due to the limited solubility of dexamethasone in the rehydration media, there was almost no drug, which was able to be dragged into the lens.

Table 24: Drug loading in single and dual pre-loaded IOLs (mean value \pm SD % (w/w))
 A: Rehydration in saturated drug solution
 B: Rehydration in 0.1 ml 0.9% NaCl solution
 C: No rehydration

	A	B	C
Single loaded : Diclofenac sodium	2.40 \pm 0.05	2.03 \pm 0.04	2.11 \pm 0.12
Dual loaded : Diclofenac sodium	2.51 \pm 0.02	2.12 \pm 0.05	2.28 \pm 0.02
Single loaded : Dexamethasone	2.08 \pm 0.03	2.05 \pm 0.04	2.18 \pm 0.02
Dual loaded : Dexamethasone	1.92 \pm 0.02	1.96 \pm 0.01	2.01 \pm 0.01

Release curves were similar for all rehydration procedures (Figure 61). Diclofenac was released mostly in the first 3 days ($t_{80\%}$: 72 hours) in single and dual loaded lenses. This is the target time for the release of a bactericide antibiotic drug. Due to the slower diffusion and the more hydrophobic character of dexamethasone, it was released slower and ended approximately after one month ($t_{80\%}$: 16 days) in just dexamethasone loaded lenses.

In dual loaded lenses, the release pattern of diclofenac did not change, whereas, dexamethasone was released faster. This accelerated release is attributed to more osmotic active compounds within the lens which led to a higher water uptake. This enhanced the amount of dissolved dexamethasone in the lens and accelerated the diffusion of dexamethasone ($t_{80\%}$: 9 days). This is the most critical time for post-operative inflammations. A more extended release is not required, due to the potential risk of dexamethasone to increase the intraocular pressure [267].

Therefore a more extended release is not desirable. Rehydration procedure had no influence on the transmittance and final refractive index which was stable after 5 days.

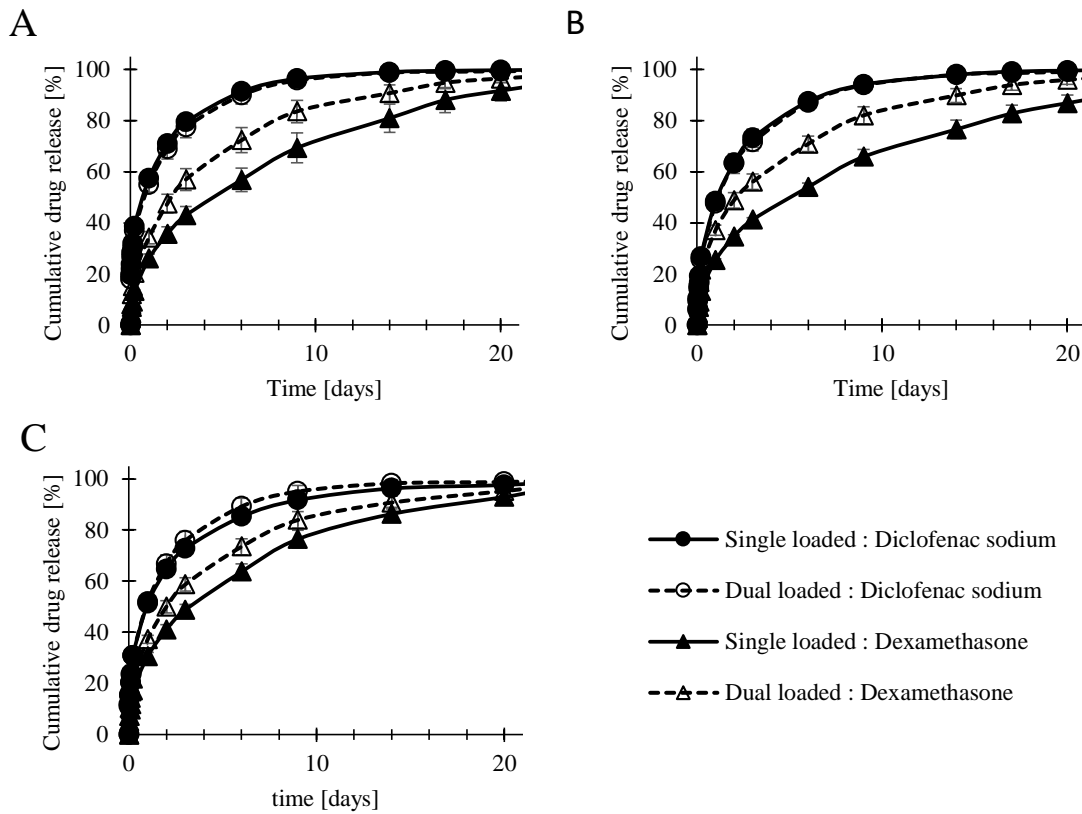

Figure 61: Drug release of single and dual pre-loaded intraocular lenses
 A: Rehydration in saturated drug solution
 B: Rehydration in 0.1 ml 0.9 % NaCl solution
 C: No rehydration

To evaluate the diffusion, the apparent diffusion coefficient (D_{app}) was calculated and compared for the different formulations (Table 25). Whereas the apparent diffusion was similar for diclofenac sodium in all formulations, dexamethasone had distinct differences. In dual loaded lenses, the D_{app} values for dexamethasone were two-fold as high as the diffusion coefficient for single loaded lenses.

Table 25: D_{app} [cm^2/s] in single and dual loaded intraocular lenses
 A: Rehydration in saturated drug solution
 B: Rehydration in 0.1 ml 0.9% NaCl solution
 C: No rehydration

	A	B	C
Single loaded : Diclofenac sodium	$1,23 \times 10^{-9}$	$8,50 \times 10^{-10}$	$8,01 \times 10^{-10}$
Dual loaded : Diclofenac sodium	$1,23 \times 10^{-9}$	$8,20 \times 10^{-10}$	$8,02 \times 10^{-10}$
Single loaded : Dexamethasone	$2,30 \times 10^{-10}$	$2,10 \times 10^{-10}$	$3,14 \times 10^{-10}$
Dual loaded : Dexamethasone	$4,00 \times 10^{-10}$	$4,00 \times 10^{-10}$	$4,51 \times 10^{-10}$

3.2.4.7.4.1. DSC – API within the lens

In DSC, the glass transitions temperatures (T_g) of lenses was detected and analysed. Besides the T_g , no other mentionable effects took place before 290°C (Figure 62), at this temperature, the polymer started to degrade. Melting peaks of dexamethasone (264°C) [264] and diclofenac (283 - 285°C) [242] were not visible, suggesting, that the API was distributed monomolecularly within the polymer. This finding is supported also by decreasing T_g s in drug-loaded lenses (Table 26). Thus, APIs had a plasticizing impact on polymers.

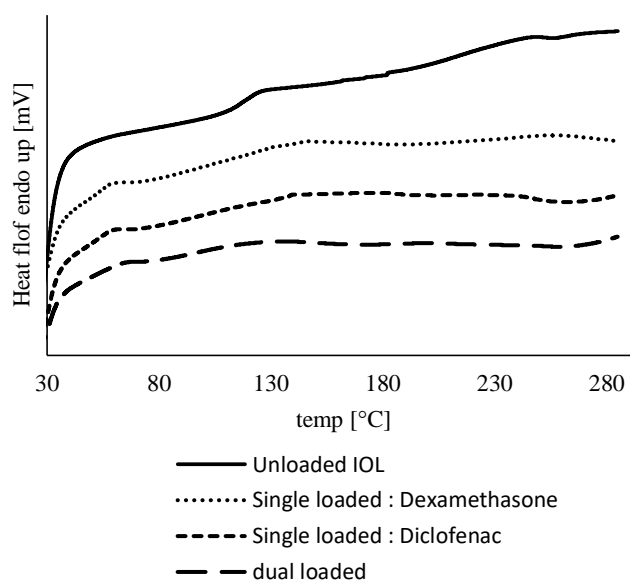

Figure 62: DSC of single and dual loaded lenses

Table 26: T_g of pre-loaded lenses

IOLs	T_g [°C]
Blank	111.99
Dexamethasone loaded	104.10
Diclofenac loaded	98.46
Dual loaded	96.00

3.2.4.7.4.2. Transmittance

All lenses presented 100% transmittance in the range of 400 nm – 800 nm upon rehydration (Figure 63), due to the absence of crystals and the formation of the monolithic solution. Transmittance was monitored at specific time points and could be guaranteed during and also post-release period, thus, indicating the absence of optical adverse effects. If required, a blue light absorbing agent could be added, to prevent the eye from high energetic light [12] as it is usually carried out for commercialized lenses. Anyway, light with wavelengths shorter than 300 nm was absorbed by the lens polymer by itself.

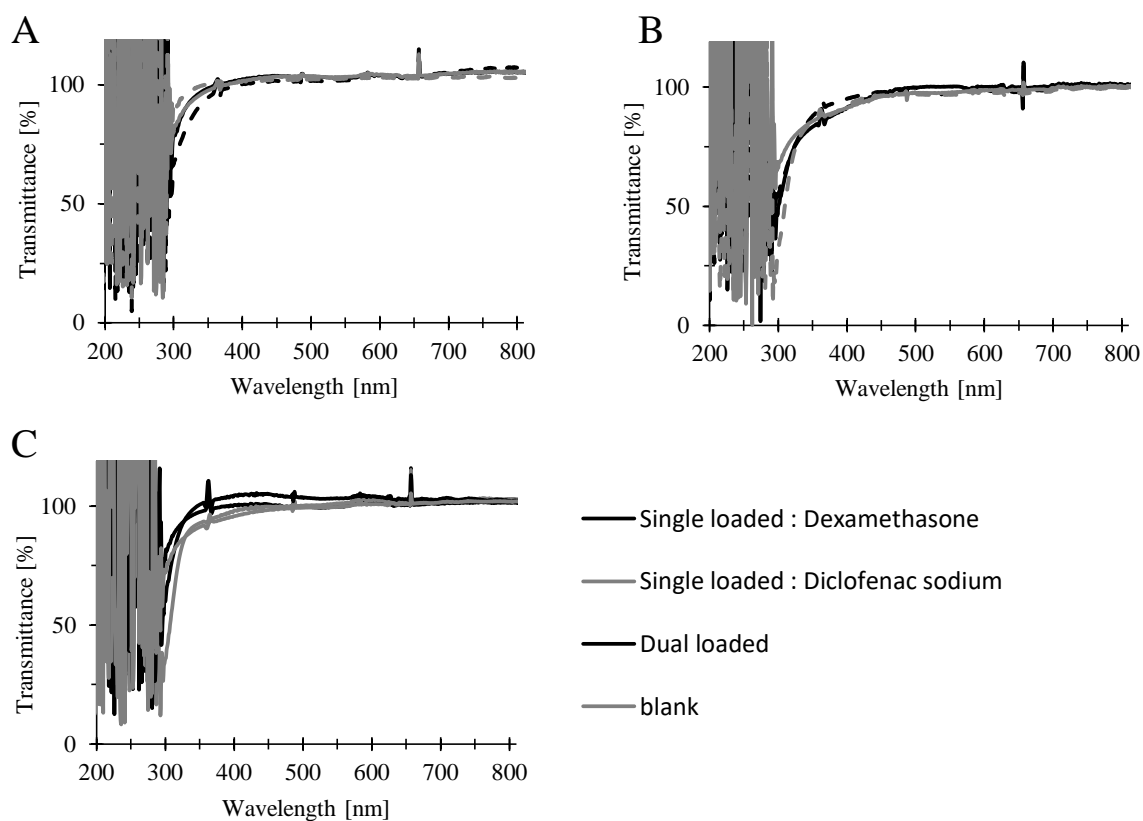

Figure 63: Transmittance of pre-loaded IOLs
A: Rehydration in 1 ml saturated drug solution;
B: Rehydration in 0.1 ml 0.9 % NaCl solution;
C: No rehydration

3.2.5. Suggested dosage form

The main challenge for drug-loaded hydrophilic intraocular lenses is the delivery in hydrated condition. This may lead to unstable formulations and the release could already start within the aqueous storage solution. Placing the hydrophilic IOLs in saturated drug solutions may prevent from leaching API but does not overcome the stability issues and the lack for hydrophobic drugs.

Therefore, it is suggested to deliver pre-loaded IOLs within a two-chamber system (Figure 64) which are separated by a delicate membrane. In the first chamber, the single, dual or multiple loaded lens is placed and kept in dry conditions.

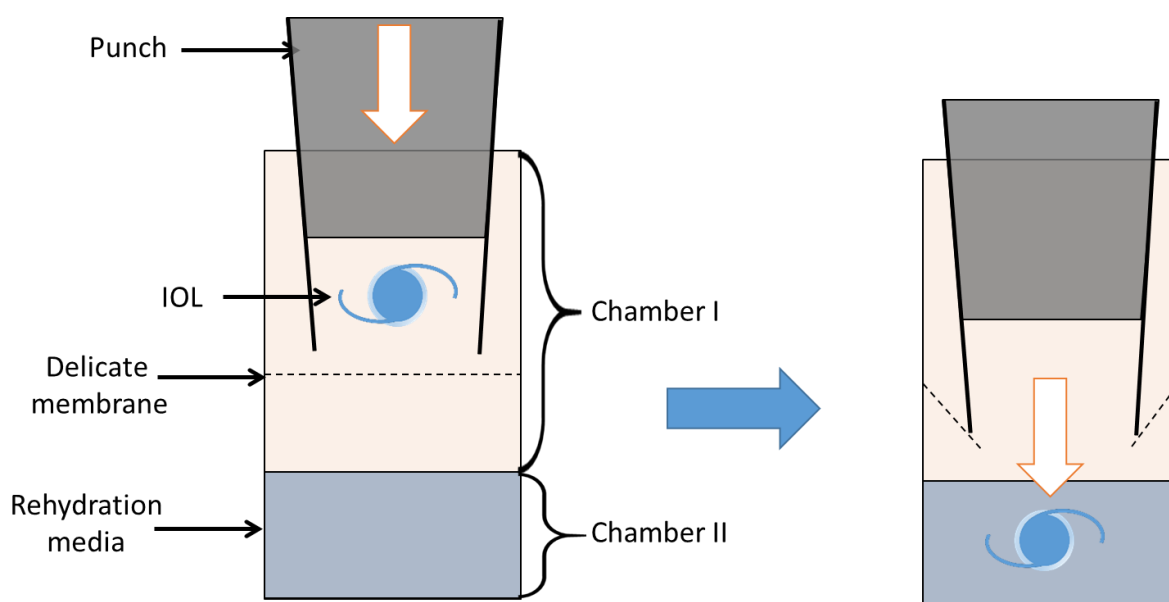

Figure 64: Suggested dosage form to supply the IOL in dry condition and to perform rehydration within one device

Shortly (30 minutes) before the surgery takes place, a punch is pressed down to crush the membrane, and the lens is delivered into the second chamber in which the rehydration media is stored. This might be a 0.9% sodium chloride solution, a drug solution or any other buffer, that is suitable for rehydrating the lens and provide the required conditions.

By this device, triggering the rehydration is fast and requires no specific qualification. Furthermore, the whole suggested device could be steam sterilized and during rehydration, unlike conventional methods, any contamination can be avoided. Additionally, this apparatus could be coupled with the injector to facilitate insertion, to decrease the chance of contamination and to sustain a sterile IOL.

3.2.6. Conclusions

Hydrophilic lenses are made of hydrogels, therefore they have high amounts of incorporated water and could be loaded by soaking methods in aqueous drug solution. Nowadays, hydrophilic lenses are mostly loaded directly before the surgery takes place but this limits the use of hydrophobic drugs.

By using organic solvents, combined with a drying step, lenses could be loaded with poorly soluble drugs as well and extended releases were possible. Also, dual drug-loaded lenses were prepared and simultaneous drug release was observed. Attributed to the need of soaked lenses to provide foldability, a specific two chamber system was suggested. By this device, the drug-loaded lens is stored in dry conditions to improve stability and rehydration is simple to perform and contaminations could be avoided. Therefore, hydrophilic lenses revealed as capable drug delivery systems to avoid postoperative complications.

3.3. Hydrophobic lenses

3.3.1. Background

Hydrophobic intraocular lenses are the most common lenses nowadays [268]. Silicones were used as hydrophobic materials in the beginning, but silicones were replaced mainly by hydrophobic acrylates and methacrylates which have the biggest market share today. Silicones have a high water contact angle (over 100°) [269] but thick optics, resulting in bigger incisions that are needed for lens injection. Additionally, silicon is difficult to handle, prone to glistening and the use of silicone oils for other ocular treatments like retinal detachment [54,55] is limited. In respect to their low market share, silicones were not examined in this thesis.

In contrast, hydrophobic acrylates have a high refractive index, are easy to handle and present the lowest posterior capsule opacification (PCO) incidence of all available lens formulations [33,45,270]. Furthermore, in case of occurring PCO, hydrophobic IOLs have better resistance during Nd:YAG laser capsulotomy [41], the medical treatment to improve vision after developed PCO.

At the beginning of IOLs, polymethyl methacrylate was a common lens material but it is seldom used nowadays because it is brittle [215]. Mostly it is still used in developing countries attributed to its low cost and for children since polymethyl methacrylate can remain in the eye for long time periods, due to good long-term stability [34].

Therefore, as hydrophobic lenses, polymethyl methacrylate as a rigid material and polyphenoxyethyl acrylate as a flexible lens polymer were prepared.

3.3.2. Lens characterization

3.3.2.1. Lens formulation and characterization

In this section, formulation 7, containing methyl methacrylate and formulation 8, consisting of phenoxyethyl acrylate (Table 27) were prepared as hydrophobic lens polymers. Both lens materials are common as intraocular lens formulations [33,165].

Table 27: Hydrophobic lens formulations, used in this section

Formulation	Hydrophilic (%, w/w)	Hydrophobic (%, w/w)
7	-	MMA (100)
8	-	POEA (100)

Homopolymers of polymethyl methacrylate (PMMA) and polyphenoxy ethylacrylate (pPOEA) were solidified during polymerization and revealed suitable properties for the use as IOLs. PMMA is a brittle material [35,193,215], due to the T_g of 109.59°C whereas pPOEA is flexible [195] and had a glass transition temperature of 6.18°C. So, PMMA was used as hydrophobic unfoldable IOLs and pPOEA represented the flexible hydrophobic lens materials. Hence, polishing of PMMA is easier, because surfaces can be smoothed easily at room temperature whereas pPOEA needed to be cooled during polishing.

Both polymers presented good optical properties. Transmittances of 100% were recorded in the center of IOLs from 400 nm to 800 nm and the refractive index was 1.4900 for PMMA and 1.5560 for pPOEA respectively, as reported in the literature [196,271]. Due to the very high refractive index of pPOEA, IOLs could be shaped quite thin while providing sufficient light refraction.

In respect to the absence of any hydrophilic groups, the hydrophobic IOLs had water uptakes of less than 1% for both formulations.

3.3.3. Drug loading by copolymerization

Dexamethasone, which was added prior to polymerization and was dissolved within the monomers, did not show sufficient release, but 100% light transmittance and a refractive index of 1.5560 could be preserved for drug loadings below 0.5%. Higher drug loadings led to turbid IOLs, caused by the low drug solubility within the polymer. By increasing the drug loading, the transmittance decreased to less than 50%. In contrast, diclofenac which was added prior polymerization prevented radical polymerization and solidification of the monomers, due to the capability of diclofenac to act as a free radical scavenger [223]. Other drugs like minocycline did not dissolve in the monomers and stability issues during polymerization occurred, resulting in discolored polymers.

Furthermore, in order to purify the lenses after polymerization from remaining monomers, cross-linker and initiator, organic solvents are used to wash out these compounds. When drugs are loaded during polymerization, this cleansing step also would remove the APIs. Therefore, this method is just applicable, when the polymerization conditions ensure very low residual concentrations that are below the acceptable threshold values.

3.3.4. Drug loading by soaking

3.3.4.1. Soaking

Contrary to copolymerization drug-loading, the soaking method separates lens preparation from drug-loading. Therefore, purification of IOLs could be conducted without the risk of removing the API from the lens matrix. Thus, purification of the IOLs was performed by immersion in organic drug solution. [36]. Hereby, residuals are washed out and the lenses are cleansed. Afterward, the organic solvent is evaporated and lenses are ready to use. During this cleansing procedure, APIs could be loaded into the polymer matrix simultaneously by using organic drug solutions as purifying agent without changing the general preparation of IOLs. In the evaporation step, the organic solvent was removed but the drug remained in the lenses.

Therefore, organic solvents were used, that led to swelling of the IOLs so that the drugs could diffuse into the lens polymer matrix. pPOEA IOLs presented higher swelling in ethyl acetate (111%) than ethanol (2%), resulting in increased drug loadings (Table 28). The drug concentration of the model drugs (propranolol hydrochloride, dexamethasone, and diclofenac sodium) in soaking media was 0.5% (m/v).

Table 28: Drug release of soaked intraocular lenses (pPOEA) (n=3; mean value \pm SD) and total drug loading

Soaking solvent : API (0.5%)	Drug loading [$\mu\text{g}/\text{IOL}$]
Ethanol : propranolol – HCl	1.93 \pm 0.82
Ethyl acetate : propranolol – HCl	9.9 \pm 2.99
Ethanol : diclofenac – Na	2.77 \pm 0.05
Ethyl acetate : diclofenac – Na	27.87 \pm 0.33
Ethanol : dexamethasone	1.14 \pm 0.17
Ethyl acetate : dexamethasone	47.30 \pm 6.22

IOLs which were loaded in organic (ethyl acetate) drug solutions and were dried afterward had a burst release, attributed to drug that was located directly on the lens surface. The hydrophilic propranolol hydrochloride was repelled by the polymer so that the drug was not incorporated into the IOL matrix. The very slow drug release of hydrophobic IOLs was due to the small water content and hydrophobic drug-polymer interactions, resulting in poor drug diffusion within the polymer matrix (Figure 65). [183,272]. Lenses loaded with ethyl acetate incorporated increased drug amounts, attributed to higher swelling. However, diffusion from the inner parts of the lens matrix to the surface was very low, resulting in an incomplete drug release.

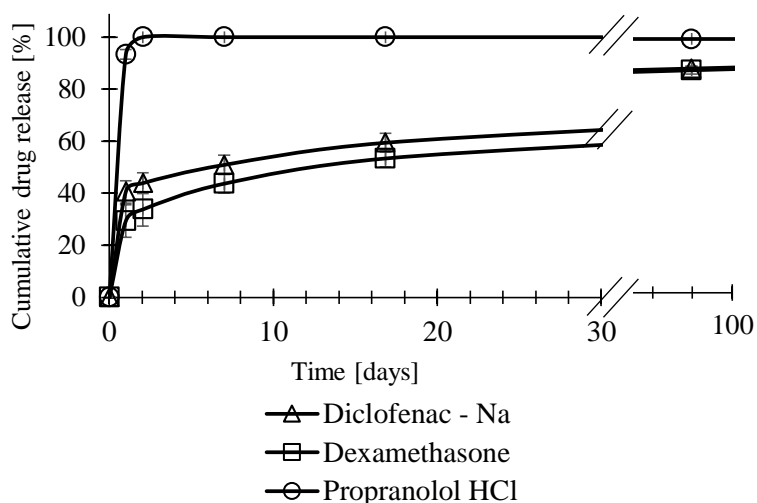

Figure 65: Drug release of pPOEA IOLs
IOLs soaked in ethyl acetate drug (0.5% (m/v)) solution for 24 h

Loaded and unloaded IOLs showed the same refraction index and 100% transmittance was ensured at this low drug-loadings. Higher concentrated soaking solutions or longer soaking times in order to increase the drug-loading led to clouded IOLs, due to drug precipitation within the IOLs. This could be explained by the low drug solubility within the lens polymers.

As a further drawback of this method, glistening was induced in lenses that soaked in ethyl acetate (Figure 66) as a result of the high degree of swelling. Glistening describes the formation of small liquid-filled vacuoles within the polymers [35], caused by imperfections in the polymer structure. During swelling and de-swelling the chain formation changed and small vacuoles were created and glistening appeared within the first three months during release study [35]. Glistening formation occurred also in IOLs which soaked in ethyl acetate without any API, therefore this effect did not depend on the drug.

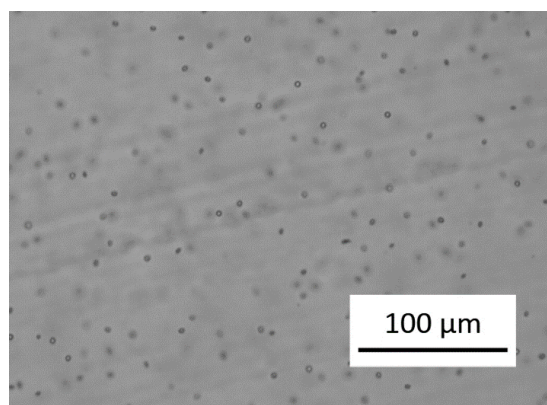

Figure 66: Glistening in pPOEA lens, after soaking in ethyl acetate

3.3.4.2. Additives to lens polymers in order to improve diffusion

Hydrophilic additives:

To improve drug release from pPOEA lenses, 20% of hydrophilic compounds like 2-hydroxyethyl acrylate (HEA) and 2-hydroxyethyl methacrylate (HEMA) were added to the monomer mixture to increase the water uptake of lenses (Table 29) and therefore to improve diffusion out of the lens matrix. For comparison reasons, one batch with 20% methyl methacrylate (MMA) as a hydrophobic additive was prepared.

Table 29: Lens formulations with hydrophilic (HEA and HEMA) and hydrophobic (MMA) additives (n=3; mean value \pm SD)

Lens formulation	Water content [%]	Refractive index	Foldability
POEA 100%	0.69 \pm 0.03	1.5550	Yes
POEA 80% + HEA 20%	2.54 \pm 0.18	1.5370	Yes
POEA 80% + HEMA 20%	2.53 \pm 0.06	1.5410	Just when hydrated
POEA 80% + MMA 20%	0.75 \pm 0.03	1.5430	No

POEA: Phenoxyethyl acrylate
 HEA: Hydroxyl ethyl acrylate
 HEMA: Hydroxyethyl methacrylate
 MMA: Methyl methacrylate

An increase in the hydrophilic character of polymers determines higher water uptake into the lens matrix, causing a reduction in refractive index, due to the less compact polymer. In general, methacrylates improve stability, whereas acrylates sustain flexibility [273], due to a missing methyl group and less tangling of polymer chains. Therefore, the addition of methyl methacrylate reduced lens flexibility. Lenses containing 20% of HEMA remained flexible in hydrated status but were not foldable in dry conditions, due to the plasticizing effect of water. The advantage, that hydrophobic IOLs can be supplied in dry state was neglected when HEMA was added.

Lenses prepared with 80% of POEA and 20% of HEA were flexible in dry and soaked conditions and increased water uptake (2.54 \pm 0.18%) could be demonstrated, 100% transmittance was ensured and glistening was less pronounced.

To prove drug incorporation and drug release, diclofenac was loaded into these lenses by soaking in acetone, ethanol or water with a diclofenac concentration of 0.1%. Diclofenac was

chosen, due to its low tendency to diffuse into the hydrophobic polymer in order to prove that 20% hydroxyethyl acrylate as additive in polymers present modified material characteristics.

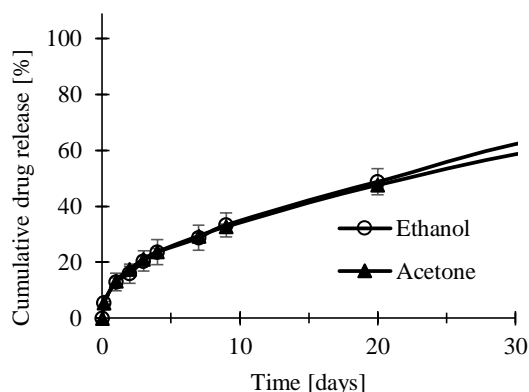

Figure 67: Drug release of pPOEA lenses, polymerized with 20% of HEA; Ethanol and acetone were used as soaking media, comprising 0.1% diclofenac sodium each.

Copolymers, containing 80% phenoxyethyl acrylate and 20% hydroxyethyl acrylate presented extended drug release from IOLs (Figure 67), but still in an insufficient manner, regarding the low drug loadings (Table 30). When water was used as soaking media, drug uptake was low and could not be detected with sufficient precision.

Table 30: Drug loading of IOLs, containing POEA (80%) and HEA (20%), soaked in organic diclofenac sodium solution (0.1%) (n=3; mean value \pm SD)

Soaking solvent	Drug loading [$\mu\text{g}/\text{IOL}$]
Ethanol	22.51 ± 15.10
Acetone	170.17 ± 17.08
Water	-

Inert additives:

With respect to insufficient improvements by incorporating hydrophilic compounds in the hydrophobic polymers, pore formers were investigated. Therefore, inert molecules were added prior to polymerization that were entrapped within the polymer. During purifying, these compounds should be removed and the space that was consumed by these additives remained

as pores within the final polymers. As pore former, ethyl cellulose and n-hexane in different amounts were added and polymerization was carried out. Hydrophilic compounds could not be used, because they were not soluble within the liquid phenoxyethyl acrylate.

Finalized polymers could be loaded in slightly higher quantities but the optical quality of IOLs was devastated (Figure 68). Ethyl cellulose could not be removed with organic solvents due to the big molecule and hampered diffusion and remained entrapped. Therefore, ethyl cellulose made lenses opaque and light transmittance decreased extremely.

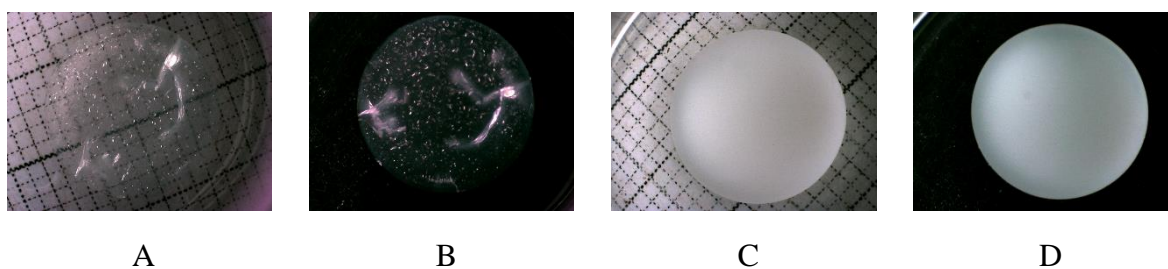

Figure 68: Lenses, prepared with pore-former in order to improve diffusion within hydrophobic IOLs
 A+B: 2.5% n-hexane as additive
 C+D: 2.5% Ethyl cellulose

For lenses, polymerized with n-hexane, the created hollow space led to severe glistening and optical quality decreased as well. By adding pore formers, polymer imperfections were more pronounced and glistening was provoked extremely. So, pore formers for hydrophobic IOLs were refused.

3.3.5. Drug loading by coating

3.3.5.1. Haptic coating

IOLs consist of the optical lens and the haptic. Haptics are like anchors that locate the lens within the eye and maintain right positioning. Thus, haptics were considered as vehicles for drug loadings, because they are not needed for vision and modifications at this part are not critical [95,117,274]. Haptics could be used as carriers and separated DDS were just attached, holes were drilled into the haptic and drug/polymer compositions were placed in these caves or the haptics were just coated [270].

In order to prove that approach, haptics were prepared, consisting of polymethyl methacrylate and fluorochinolone, typical materials for haptics [214]. These haptics were dipped in coating solution, containing water (12%) and 2-propanol (88%) as solvent and ethyl cellulose (6%) as polymer and propranolol hydrochloride (3%). Haptics were immersed for 20 times in this coating solution and drying was ensured between dip-coating steps.

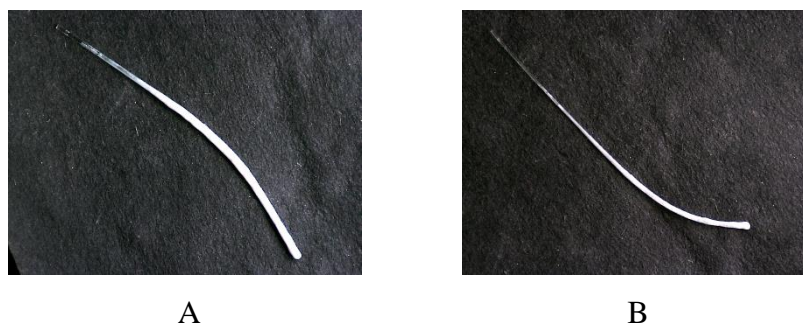

Figure 69: Coated haptics;
 A: Coated PMMA haptic
 B: Coated fluorochinolone haptic

From coated haptics (Figure 69), the drug release was independent of the haptic formulation, due to the haptic formulation independent drug delivery system (Figure 70). The drug loading could be easily adjusted by changing the coating level and further modifications for this approach are simple.

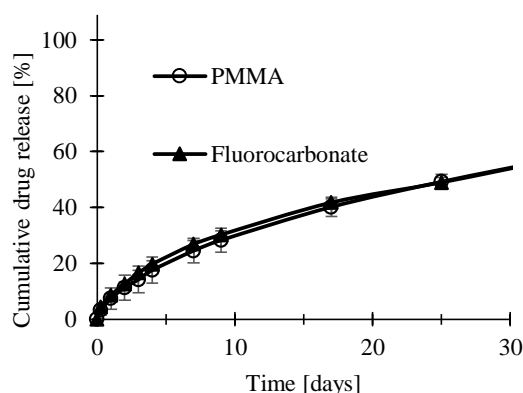

Figure 70: Drug release from coated haptics

The coating adhesion was good for polymethyl methacrylate and fluorochinolone haptics. IOLs are divided into single piece and three piece lenses [275,276]. In single piece IOLs, the lens is produced in one manufacturing step and the whole device consists of one part. In contrast, lenses and haptics are prepared in different manufacturing steps and are assembled together

afterward for three piece IOLs. Haptic-coating of IOLs is reasonable especially for these three piece lenses because the coating could be performed separately and the coated haptics are just assembled afterward.

3.3.5.2. Lens coating

Lenses which were coated with drug/polymer mixtures at the whole surface turned turbid and transmittance was ruined. Transparency was retained for pure ethyl cellulose coatings, but when drugs were incorporated, transmittance decreased (Figure 71).

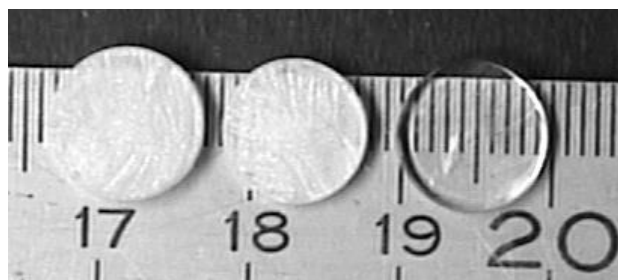

Figure 71: Coated PMMA lenses
Right lens: Uncoated lens for comparison

Therefore, it was concluded, that coatings at the lateral surface are superior in contrast to coatings that are applied on the whole lens.

3.3.5.3. Coating at the lateral area of the lens

3.3.5.3.1. Coating by polymerization

In respect to the small water content within the polymer matrix of hydrophobic polymers, these IOLs are not approachable for drug loadings by soaking methods. To overcome this issue, hydrophobic polymers were coated by a hydrophilic polymer, containing hydroxyethyl methacrylate, cross-linker and initiator (formulation 1). Therefore, hydrophobic polymer rods were prepared and then placed in bigger vials, containing the monomers for the coating. Polymerization was conducted again and a polymer rod was contained, having an inner polymer shaft of pure hydrophobic material (Figure 72) and a shell of hydrophilic compounds. Then the lenses were lathed and polished.

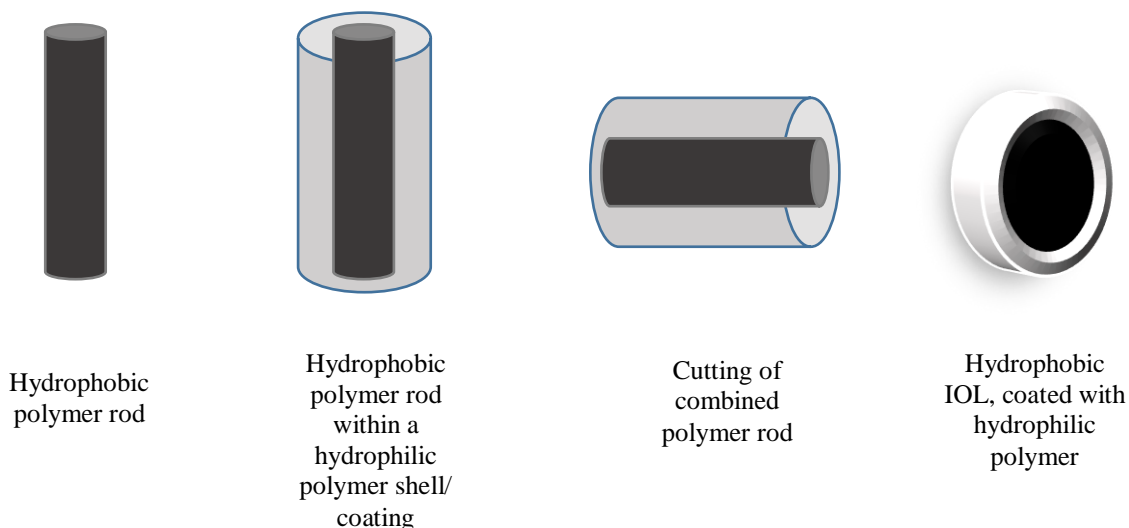

Figure 72: Coating process: Hydrophobic polymer rod was placed in hydrophilic monomers and polymerized in order to prepare hydrophobic IOLs, coated with a hydrophilic polymer shell

Attributed to the purely hydrophobic character of the inner core and the hydrophilic nature of the shell, the coating adhesion was poor and detachments occurred frequently. Furthermore, the

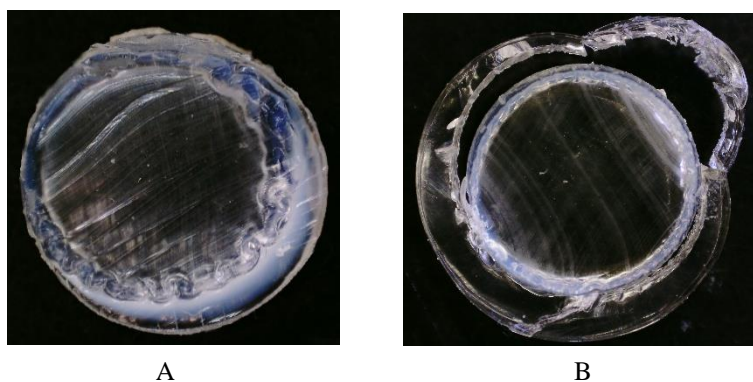

Figure 73: pPOEA lens, coated with hydrophilic polymer
 A: Clouding of coated IOL;
 B: Detachment of hydrophilic coating from the hydrophobic pPOEA IOL

hydrophilic polymer is brittle in dry conditions and needed to be hydrated to maintain foldability. While hydrating, the coating could be loaded, also by aqueous drug solutions but the advantage of applying dry IOLs was neglected.

Unfortunately, the hydrophilic coatings detached during soaking in aqueous humor, due to unequal swelling of the hydrophobic and the hydrophilic part. The hydrophobic part did not change dimensions, whereas the hydrophilic shell soaked high quantities of water and suffered size incensement, resulting in peeled coatings (Figure 73).

To improve coating adhesion, hydrophobic polymer rods were removed from their polymerization vessel before the chemical reaction finished. Thus, the material was sticky and “semi-solid” and unreacted double bonds were still present. These unfinished polymers were placed in other vials, containing hydrophilic monomers and polymerization was finished within the second vessels.

Thus, the two polymers were connected by covalent bonds and therefore, coating detachment did not occur. However, in the beginning of the second polymerization, hydrophilic monomers diffused into the “semi-solid” hydrophobic polymer partially and the interface between the two compositions became turbid. To minimize this effect, the second polymerization was performed at increased temperatures so that less time was available for diffusion, due to faster solidification, but this lead to less perfect polymers in general. Additionally, this also accelerated diffusion.

To avoid diffusion of hydrophilic monomers into the hydrophobic “semi-solid” polymer rod, the hydrophilic composition was pre-heated to trigger the polymerization. Thus, the polymerization already started and bigger molecule chains were created. The unfinished hydrophobic polymer was placed in the unfinished still liquid hydrophilic polymer and polymerization was finished. Obtained polymer rods had good optical properties. The formed bigger hydrophilic molecules could not diffuse into the “semi-solid” hydrophobic polymer rod, but regarding the incomplete polymerization in both compositions, some covalent bonds were formed, leading to appropriate coating adhesion.

Lenses were loaded in aqueous drug (sodium salicylate) solution (1%) and release study was conducted. The drug loading was $1.21 \pm 0.17\%$, related to the hydrophilic coating. In uncoated

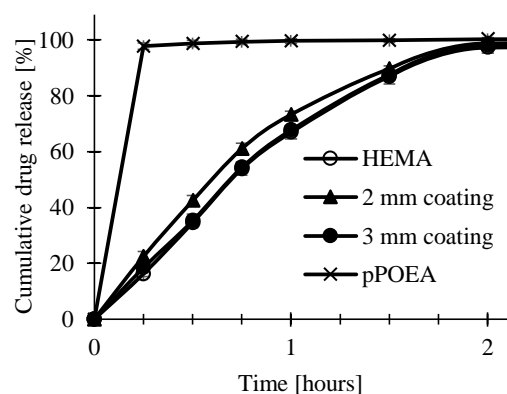

Figure 74: Drug release of coated and uncoated IOLs;
 HEMA: IOLs made of pure coating material;
 Coating level in mm;
 pPOEA: IOLs without coating

hydrophobic lenses, no drug was incorporated into the lens polymer and drug loading was less than 0.001%.

Drug release patterns were independent of coating level (Figure 74) and the amount of loaded drug could be adjusted by coating thickness. Uncoated lenses had no extended release because no drug was incorporated into the polymer matrix and the drug was “released” just from the IOL surface.

Lenses remained transparent and the high refractive index was retained in the core of the IOLs. However, with respect to the small amount of coating (app. 2-3 mg/IOL) the total drug loading is very small (app. 30 µg/IOL). Therefore, coatings with higher drug loading capacity should be prepared, regarding perfectly retained optical properties of lateral coated IOLs.

3.3.5.3.2. Coating solvents

PLGA is an FDA approved biodegradable polymer for implants and common in ophthalmic devices so that safety for this excipient could be implied [125]. PLGA decomposes in aqueous media but is not soluble within it, therefore, organic solvents were needed to apply PLGA coatings on the lateral surfaces of IOLs.

Trichloromethane is able to dissolve PLGA in large amounts, but it corroded polymethyl methacrylate since it also dissolved PMMA [277]. Thus, the polished surfaces became dull. The lateral surface is not needed for vision and therefore, this corroding effect was not critical. Also, other workgroups worked with chloroform [121]. However, ethyl acetate also dissolved PLGA, is less toxic, more friendly to the environment and did not make the IOLs dull. Therefore, ethyl acetate was used as a solvent for coating solutions/suspensions.

3.3.5.4. Coating near/at the lateral surface

3.3.5.4.1. Coating patterns

In order to maintain optical properties, IOLs were coated just on the lateral surface or on the lens, next to the lateral surface of the lenses. The coatings were either distributed over the whole lateral surface, applied punctually onto the lateral surface or at two areas.

Thicker coatings which were applied on the whole rim detached in some cases (Figure 75 A). In contrast, other coating patterns presented no dissociation from lenses (Figure 75 B and C).

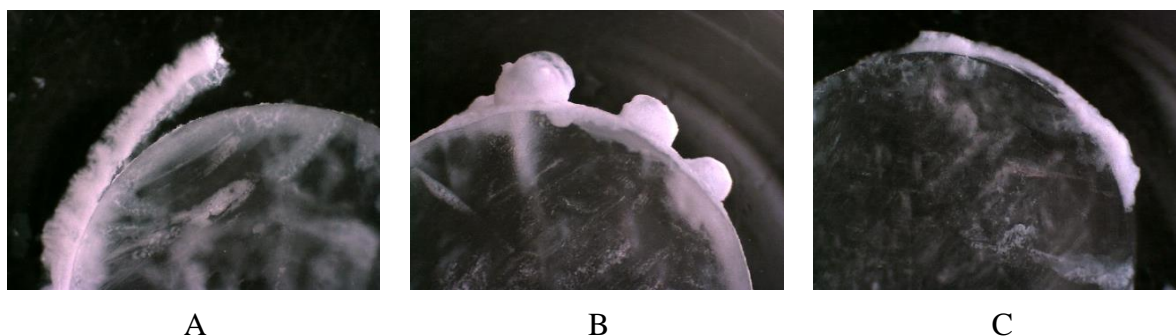

Figure 75: Lenses coated at the lateral surface;
A: Coating detachment of lenses, received complete lateral surface
B: Spot coating
C: Coating at two areas at the lateral surface

Coating adhesion was good for PMMA and pPOEA lenses. The optical characteristics remained the same and refractive index, transmittance and water uptake of lenses was not affected by this coating procedure. Furthermore, foldability of pPOEA lenses was retained, when the coating was applied just at two areas at the lateral surface since the coating was not affected by lens folding. In contrast, lenses coated at the whole outer rim were not foldable [159]. Considering practicability and time expenses for the punctual coating on the whole outer rim of the lens (Figure 75 B), the coating pattern of two areas at the lateral surface (Figure 75 C) was selected and used for further studies. To maintain a smooth interface between lens and capsular bag, coatings could be applied just at the upper part of the lateral outer rim.

3.3.5.4.2. Coating layers

Further coating modifications could be performed by different coating layers (Figure 76 A). The sub coating could be conducted by a highly concentrated drug solution/suspension including a small amount of PLGA, functioning as a glue to improve adhesion of the API to the lens. The top coating just comprised PLGA and ethyl acetate to provide a reservoir system with target release properties. Also with this approach, foldability was still possible with flexible lenses (Figure 76 B).

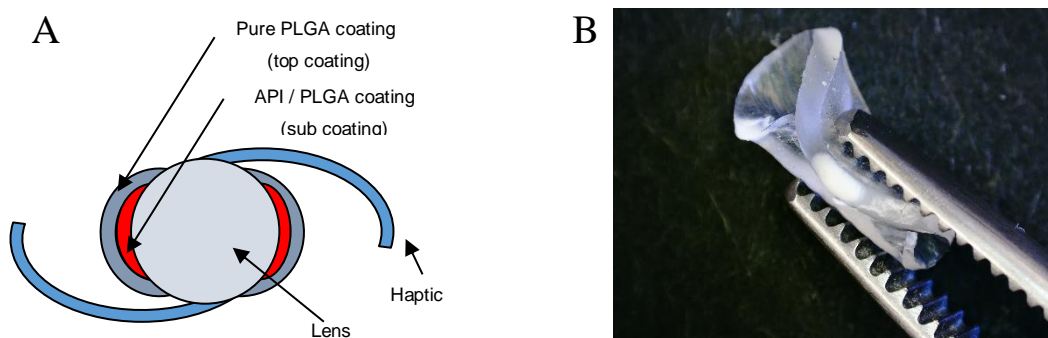

Figure 76: Coating for IOL;
A: Schematic illustration of sub- and top coating
B: Coated IOL that is folded

The frequent decrease in compliance occurs a few days after the surgery normally. Therefore, the drug release should be extended to approximately one month [126]. As mentioned, zero-order release kinetics for dexamethasone is desirable with a tapering off at the end of release [265]. A more extended release would not be requested, due to the potential increase in intraocular pressure, a known side effect of steroids [267].

For the sub coating dexamethasone, a hydrophobic drug with a solubility in ethyl acetate of 2.825 ± 0.015 mg/ml, was dispersed in a concentration of 50 mg/ml in a 5 mg/ml PLGA 502 H ethyl acetate solution. Due to the small particle size of dexamethasone (SMD: $1.10 \mu\text{m}$; VMD: $1.97 \mu\text{m}$), sedimentation was slow. The sub coating was applied to achieve a drug loading of $500 \mu\text{g}$ at each coating site. The top coating of 5% PLGA 502 H in ethyl acetate was applied in order to extend the drug release. This concentration was chosen with regard to practical aspects of viscosity and spreading of the coating solution. The top coating was applied in different amounts to investigate the impact of coating level on release extension (Figure 77 A).

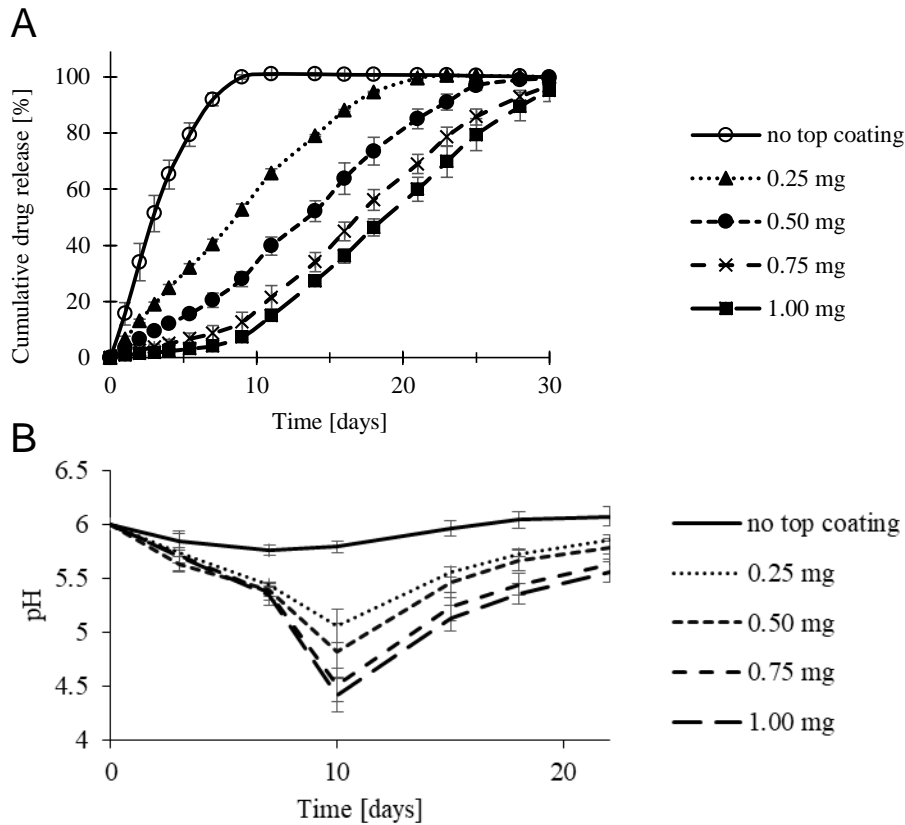

Figure 77: Effect of pure PLGA top-coating on dexamethasone release, IOL were coated with dexamethasone containing sub-coating in order to obtain a drug loading of 1 mg.
 A: Drug release
 B: pH in release media

Often, PLGA formulations present a three phasic release, owing to dissolving drug from the surface in the first phase, followed by a lag phase, attributed to PLGA swelling where also pore closures take place that is continued by the third phase, in which polymer erosion and drug diffusion take place simultaneously. This last phase is known to have zero order kinetics [44].

If no top coating was applied on the sub coating, the release was mainly driven by the dissolution of dexamethasone, caused by the very small amount of PLGA. Lenses that received a distinct amount of top coating presented a two phasic release. The missing first phase of the typical three phasic release profile of PLGA formulations was attributed to the pure PLGA top coating. In this coating layer, no/less drug was present and could not dissolve in the beginning. Thus, an initial lag time was observed and the release increased when pores were formed in the PLGA coating and drug could diffuse out. The small release in the first 5 days in the formulations with top coating was attributed to dexamethasone that dissolved in ethyl acetate during the coating process and diffused into the top coating and its surface.

A decrease in pH could be observed in the release media (Figure 77 B), caused by the hydrolytic decomposing of PLGA. The decrease in pH is naturally more pronounced in formulations, comprising higher polymer amounts, which produce higher concentrations of lactic- and glycolic acid during the degradation.

This drug loading approach has the additional advantage that lower or higher drug loadings could be achieved without modifications to the coating procedure, just by applying less or more sub coating. In release studies (Figure 78), this changed the release pattern slightly but could be adjusted easily by decreasing/increasing the top coating. Nevertheless, coatings comprising more PLGA in the API/polymer ratio presented a tri-phasic release, whereas the less drug-loaded IOLs had a faster release in the beginning. Therefore, when the ratio of ingredients was set appropriately, the release profiles could be adjusted to almost to zero-order kinetics.

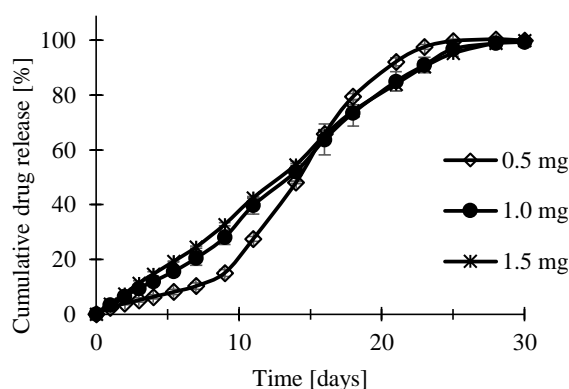

Figure 78: Effect of different drug loadings on dexamethasone release. Drug loading was tuned by different sub-coating levels. Lenses were additionally coated with 0.50 mg PLGA top-coating

3.3.5.4.2.1. Influence of release media

3.3.5.4.2.1.1. Coating layers

When drug release was conducted in artificial aqueous humor (phosphate buffer; 0.07 mol/L) instead of isotonic sodium chloride (0.9%) solution, the release of dexamethasone was extended enormously, however, 100% drug release was achieved. Besides this prolongation of drug release, also the release patterns change. Thus all coated lenses, independent of top coating level, presented a tri-phasic release profile (Figure 79 A). Lenses, with varying amounts of sub-coating, had almost identical release curves and could be considered as same (Figure 79 B).

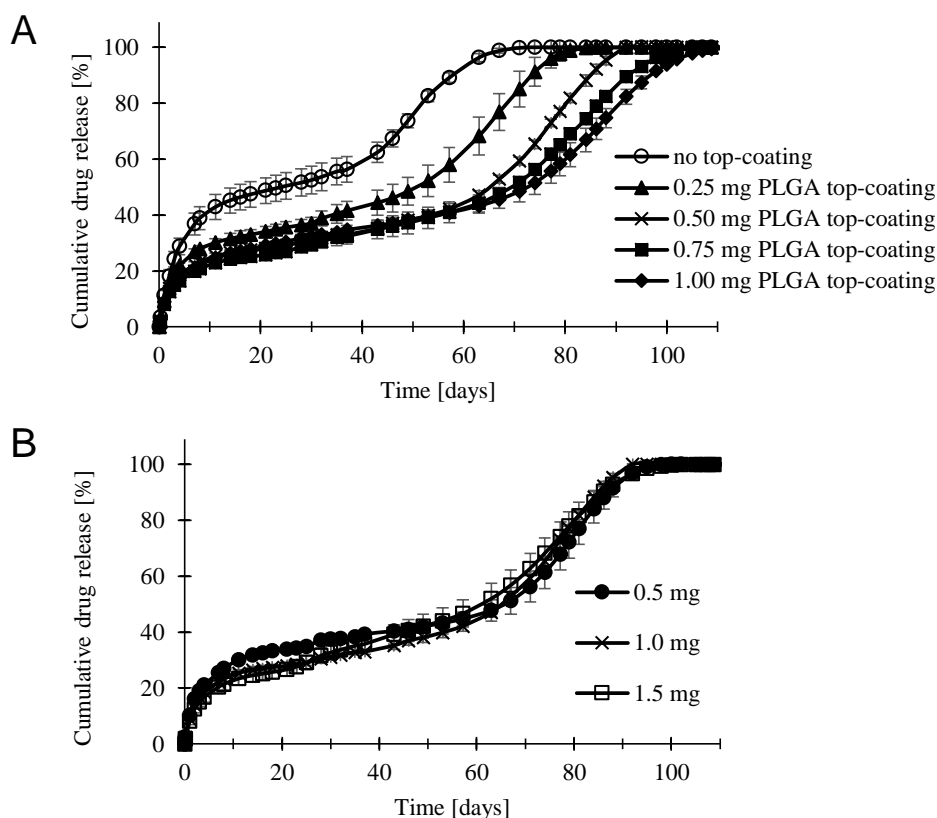

Figure 79: Dexamethasone release of drug containing sub-coating and PLGA top-coating in phosphate buffer (pH 7.21)
 A: Drug loading was 1 mg and top coating amount was varied
 B: Dexamethasone loading was varied and top coating was set 0.50 mg PLGA

It was assumed that dexamethasone phosphate and more consequently, also the dexamethasone 21-phosphate dimer was formed in buffers, comprising phosphate ions. This resulted in changed release profiles. Within the PLGA coatings, diffusion is hampered and just a small amount of water is available. The decomposing of PLGA consumes water and therefore, reactions that would create water are promoted, accordingly to the “principle of Le Chatelier” (principle of least compulsion). Additionally, by decomposing PLGA and created lactic and glycolic acid, an acidic microclimate is formed, that also would facilitate esterification. The generated dexamethasone phosphate is charged, due to the small pka value of phosphate and therefore more hydrophilic. This results in the higher initial burst release. By time, the charged dexamethasone phosphate dimer is formed but attributed to the increased molecule volume, diffusion is limited and drug release is slower.

Ozurdex[®], a commercialized ocular implant, containing 700 µg dexamethasone in a PLGA matrix was released in isotonic saline solution [171,173,278] for FDA approved released studies and also other PLGA compositions are released in this media [127,160]. Therefore, to avoid undesirable chemical reactions that have an impact on release profiles, isotonic sodium chloride solution was used as release media.

3.3.5.4.2.1.2. Pore former

In order to prove the release mechanisms, coatings with pore formers were prepared. Therefore, coatings, comprising dexamethasone (5%), PLGA 5050 DLG 1A (2.5%) and Poloxamer 188 (Kolliphor P 188[®]) in concentrations of 0%, 10% and 30% were dispersed/dissolved in ethyl acetate and applied on the lateral surfaces of IOLs. (Reason for choosing this API/PLGA ratio is presented in next section). Poloxamer 188 was selected in respect to its water solubility and its possible parenteral application [279].

Drug release was conducted in artificial aqueous humor (phosphate buffer: 0.07 mol/L) and in isotonic sodium chloride (0.9%) solution respectively. The initial pH in release media was similar, but in NaCl media, the pH decreased, due to no buffer capacity.

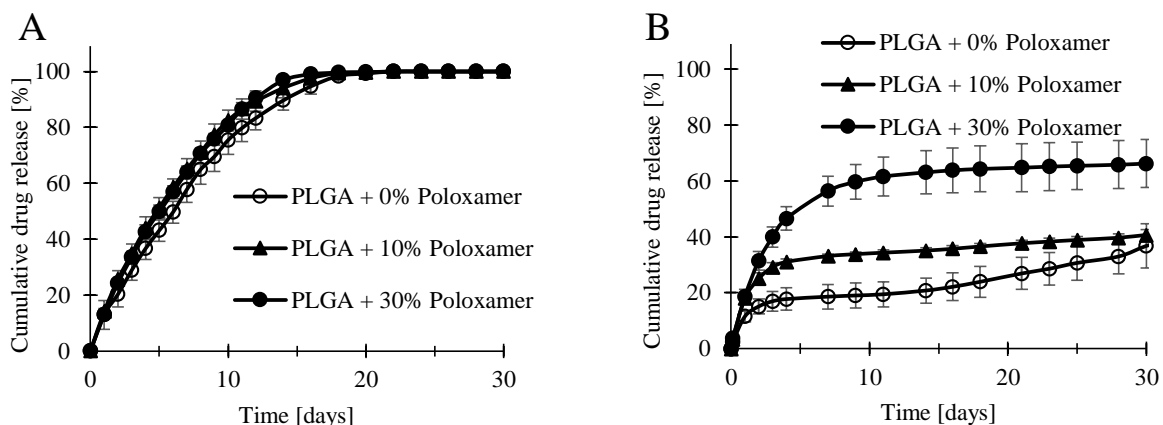

Figure 80: Drug release of IOLs, coated with dexamethasone, PLGA and Poloxamer 188. Poloxamer 188 was added as pore-former in different concentrations (% is related to the amount of PLGA)

A: 0.9% NaCl as release media

B: Phosphate buffer as release media

For drug release, it was assumed, that Poloxamer 188 is incorporated in the PLGA matrix and would dissolve and diffuse out fast in release media, resulting in pores formation. This should lead to a faster drug release [280].

In isotonic sodium chloride solution, dexamethasone release (Figure 80 A) was independent on created pores, indicating that diffusion is not the guiding release mechanism, whereas, in phosphate buffer, the initial drug release was increased remarkably for coatings, comprising poloxamer 188 (Figure 80 B).

This proved, that the release mechanism in different release media changed. Coated IOLs, which were stored in phosphate buffer had initial burst release and increasing amounts of pore formers raised this initial drug delivery, due to created hallow space within the polymer matrix. However, after approximately 10 days, pore closure took place by swollen PLGA and a lag phase with almost no drug release was observed. Complete drug release was achieved after 110 days, similar to IOLs, that were coated by sub-and top coating and were released in phosphate buffer as well. This could be explained by the restricted diffusion of created dexamethasone phosphate dimer esters. The initial phase in drug release was similar in both release media, caused by the time that was needed for esterification.

In contrast, drug release of coated lenses in sodium chloride solution was independent of created pores, suggesting, that diffusion is not the main release mechanism. The small increased release for IOLs, containing poloxamer 188 was attributed to better water diffusion within the polymer and therefore slightly faster polymer degradation.

3.3.5.4.3. Drug – polymer concentration (Drug loading)

By coating with sub-and top coating, release patterns are adjustable and modifications in the drug loading are simple. Nevertheless, for industrial scale, a simpler approach would be beneficial and a coating procedure with a single coating solution/suspensions is preferable. Thus, different API-PLGA ratios were examined (Figure 81) and desired coating patterns were achieved by using 5.0% dexamethasone and 2.5% PLGA 502 H dispersed or dissolved in ethyl acetate respectively.

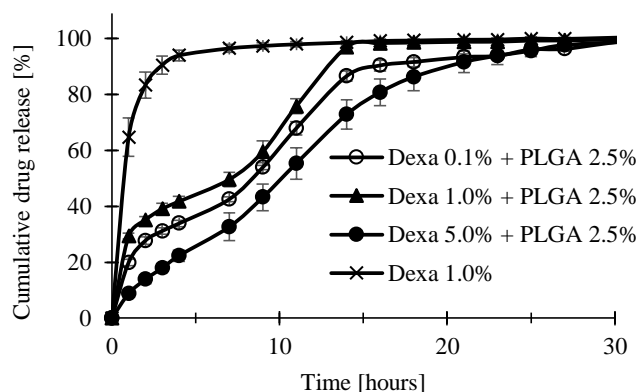

Figure 81: Drug release of IOLs, coated by different dexamethasone/PLGA ratios

Lenses, just coated with dexamethasone had a fast release in the beginning and 85% of drug recovery was achieved after 48 hours. That this release was not faster could be explained by the slow solution rate of dexamethasone. In PLGA coatings, the polymer concentration was set to 2.5%, related to the ethyl acetate and drug concentrations were modified. Dexamethasone has a solubility of 2.825 ± 0.015 mg/ml in ethyl acetate. Therefore, solid drug particles were present in coatings, containing more than 0.3% dexamethasone. Thus, the release of the coating, containing 0.1% dexamethasone was slower than coatings, comprising 10 fold more API. The undissolved dexamethasone dissolved and formed pores, which accelerated drug diffusion and therefore also release.

The coating with the highest drug loading had the most extended release, in contrast to expectations. This could be explained by the size of the coating. Whereas coatings with less drug loading spread on the lateral surface, this highly concentrated coating suspension did not spread well, followed by a proportionally small surface area, due to the higher amount of solid particles. Whereas the tri-phasic release was recognizable in the other coatings patterns, the release curve of the highest drug concentrated coating was almost linear.

In respect to manual coating, the drug loadings (Table 31) were not homogeneous, but the trend was recognizable. The total drug loading was correlating the drug concentration in the coating solution.

Table 31: Drug loading of IOLs, coated by different dexamethasone/PLGA ratios

Coating solution/suspension	Drug loading [µg/IOL]
Dexa 0.1% + PLGA 2.5%	14.74 ± 0.95
Dexa 1.0% + PLGA 2.5%	105.80 ± 16.97
Dexa 5.0% + PLGA 2.5%	570.93 ± 68.33
Dexa 1.0%	90.99 ± 11.77

3.3.5.4.4. PLGA types

To prove, that the drug release was also controlled by the PLGA and did not depend only on the dissolution rate, coatings with different PLGAs were prepared. All coating suspensions contained 2.5% PLGA and 5% dexamethasone.

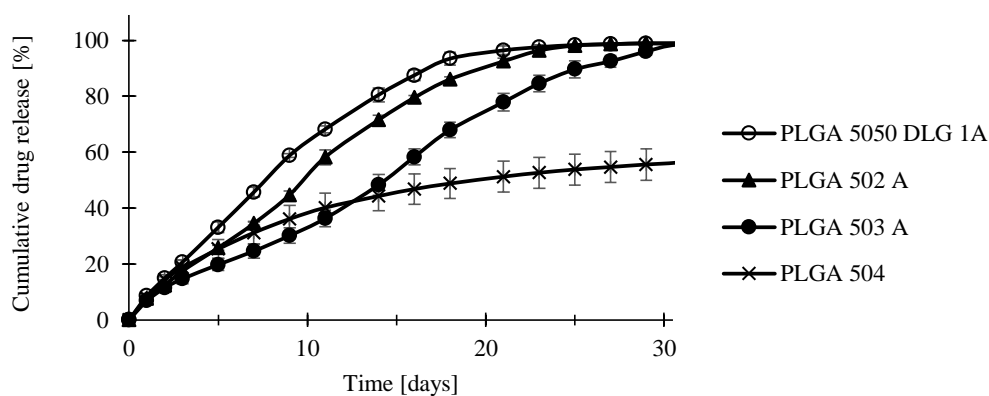

Figure 82: Drug release of coatings, containing different PLGA types

Drug release from dexamethasone coatings, prepared by various PLGAs had different release profiles, indicating that the release is also guided by the decomposition of PLGA. Whereas shorter polymer chains led to faster drug release, attributed to faster degradation, PLGA 504 with end-capped groups presented strongly extended release.

The drug loading was similar for all lenses (Table 32) and therefore, it was concluded, that the PLGA functioned as a glue but as an excipient that prolonged the release as well.

Table 32: Drug loading of IOLs, coated with different types of PLGA

PLGA	Drug loading [mg/IOL]
PLGA 5050 DLG 1A	2.23 ± 0.23
PLGA 502 H	2.03 ± 0.18
PLGA 503 H	1.83 ± 0.16
PLGA 504	2.23 ± 0.45

3.3.5.4.5. Coating level

Lenses were loaded by coating suspension, comprising 5% dexamethasone and 2.5% PLGA 502 H with different coating levels and drug release was evaluated (Figure 83). Modification of the coating level was done by changing the number of applied droplets on the lateral surfaces.

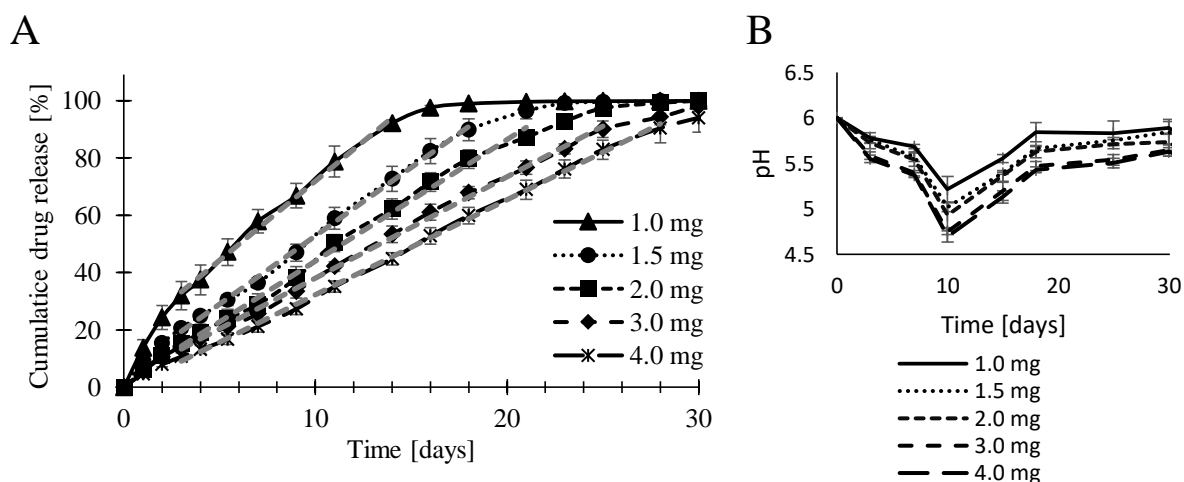

Figure 83: Intraocular lenses, coated by coating suspension containing 5% dexamethasone and 2.5% PLGA 502 H in ethyl acetate. Coating level was modified to achieve desired drug loadings
A: Release pattern
B: pH in release media during release

The drug release profiles of the coated IOLs presented a zero order kinetic. Linear regressions were performed for these formulations in the range of the third day until a drug release of 90% (Figure 83 A) and the coefficient of determination (R^2) was calculated to check the fitting of

measured data-points and linear regression (Table 33). R² values close to 1 indicate a release profile, similar to zero-order kinetic.

Table 33: Drug loading and R² values of single layer coated IOLs

Drug loading [µg/IOL]	R ²
1.0 mg	0.9952
1.5 mg	0.9979
2.0 mg	0.9932
3.0 mg	0.9980
4.0 mg	0.9986

Thicker coatings presented a slightly more extended release than lenses with lower coating levels. However, the coating level increase was not proportional to release prolongation. This is in respect to the autocatalytic effect of PLGA decomposition. That effect is especially pronounced in large PLGA particles because acids cannot diffuse out easily and glycolic and lactic acids cumulate and accelerate the polymer degradation [45]. Thus, the degradation time changed just slightly by the coating amount and the coating level could be selected mostly by the targeted drug loading.

In respect to this decomposing mechanism, degradation of PLGA is promoted in the core of the coating matrix. So, coating content plays a major role in PLGA adhesion during the release. While coatings up to 2 mg of dexamethasone were safe and did not detach from the lenses (Figure 84 A-C), coatings with higher coating amounts detached in some cases (Figure 84 D).

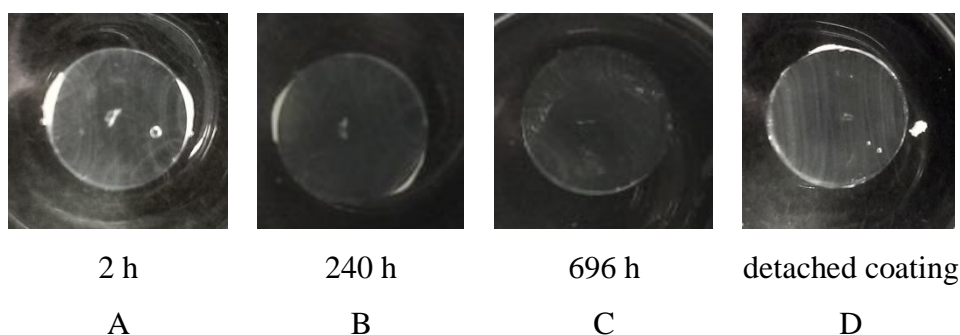

Figure 84: Images of coatings during release study;
 A-C: Coating decomposition during release study (drug loading: 2 mg)
 D: Coatings, with high coating level detached from lenses during release study (drug loading: 4 mg)

3.3.5.4.6. Morphology of dexamethasone/PLGA coatings

To get a better understanding of coating morphology, SEM pictures of dexamethasone, PLGA, and dexamethasone + PLGA coatings on the lens surface were recorded. Additionally, images were taken by a light microscope with polarized light. Pictures present either (Figure 85 A, B, C) the boundary of coating and blank lens surface or (Figure 85 D) a top-view on dexamethasone/PLGA coating.

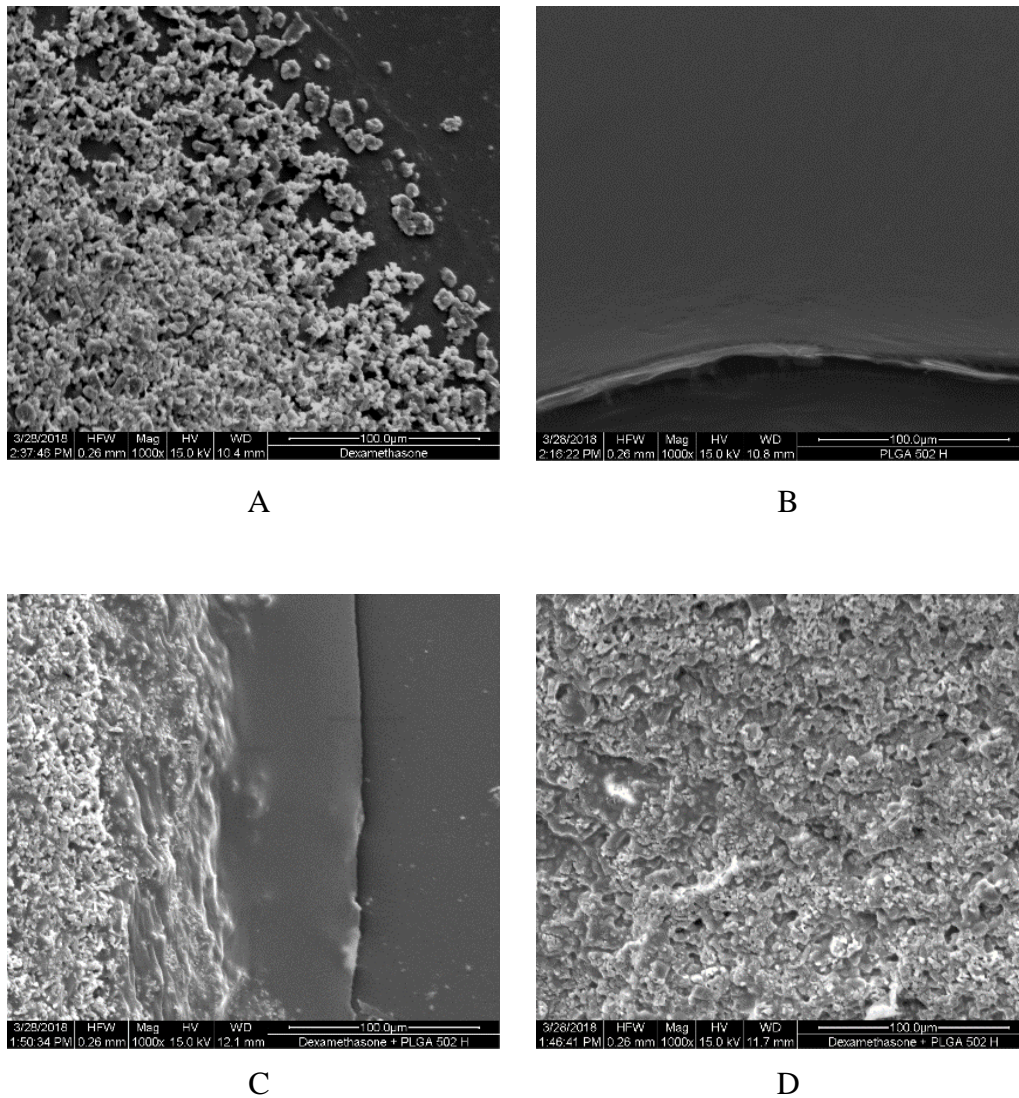

Figure 85: SEM images of coated IOLs
 A: dexamethasone
 B: PLGA 502 H
 C: dexamethasone + PLGA coating;
 D: dexamethasone + PLGA coating (top view on coating)

Dexamethasone that was coated on the lenses kept his crystalline structure in the coating dispersion (Figure 85 A) and the crystal size remained. Pure dexamethasone coatings detached fast from the lens in release studies, due to the absence of a binding compound. In contrast, pure PLGA coatings formed a smooth coating without any crystalline structures (Figure 85 B). PLGA showed good solubility in ethyl acetate and formed homogeneous closed surfaces without the need to be cured or tempered above T_g or the minimum film forming temperature (MFT) respectively as a non-porous product was achieved by slow evaporation within the preparation process. In respect to the need of a slow evaporation of ethyl acetate to get a non-porous product, drying was conducted at room temperature for 24 hours. Afterward, coated lenses were placed in a vacuum oven for another 24 hours at room temperature, to ensure complete drying. By SEM, the vacancy of pores could be proven. Coatings, containing 5% dexamethasone and 2.5% PLGA 502 H combined this features. The crystalline dexamethasone scaffold is soaked by the polymer and the matrix became robust by this (Figure 85 C and D).

Regarding this drug-polymer matrix, it could be explained, why the typical three phasic release for PLGA formulations was not observed for the IOIs, which were coated by this suspension. The second step in release mechanism is characterized normally by swelling of PLGA and consequently pore closure [44]. The diffusion is hindered and almost no drug release takes place in this phase. Specifically, this did not happen in the investigated coating matrix, due to the high drug loading and therefore the permanently new formed pores by dissolving dexamethasone and less PLGA to close all these created pores. Besides the low solubility of dexamethasone, that prolonged the release, the extended release is also accounted to the slow solution rate of the API.

The crystalline structure was also confirmed by microscopic pictures while using polarized

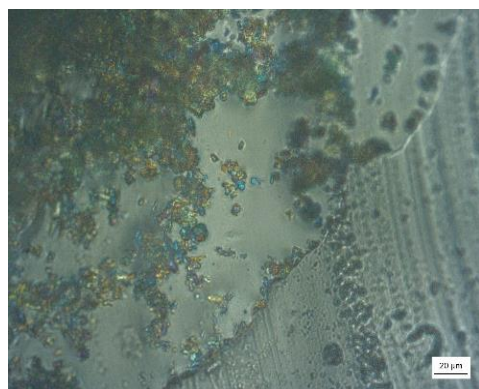

Figure 86: Microscopic image of coating, containing dexamethasone + PLGA (magnification 20x)

light. The dexamethasone crystals were clearly visible as well as the PLGA formed layer (Figure 86). Scratches on the lens surface in the right corner are due to the cutting of lenses and insufficient polishing.

For film formation, plasticizing agents are not needed but might be beneficial to improve flexibility and to sustain the coating during lens folding.

3.3.5.5. Dual drug loading by coating

By lateral surface coatings, optical properties such as high refractive index, 100% light transmittance and foldability for polyphenoxyethyl acrylate lenses was retained. The coating adhesion was good and release patterns could be modified to the patients need as drug loadings as well.

Hydrophilic / charged APIs:

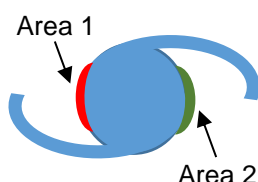

Figure 87:
IOLs with two different coating areas

In order to prepare lenses, that demonstrate simultaneous drug release of two different APIs, the two coating areas could be treated separately (Figure 87). Therefore, at one coating area, the developed dexamethasone/PLGA coating was applied and at the other location, diclofenac sodium and propranolol hydrochloride (model drugs for antibiotics) coatings were administered in same API/PLGA ratio like the dexamethasone coating (5% API / 2.5% PLGA 502 H).

Diclofenac and propranolol coatings were applied on lenses with and without dexamethasone coating at the second area to investigate possible interactions of different coatings. All coatings were prepared with drug loadings of 1mg/IOLs.

All coating had good adhesion and no detachments were observed. Dexamethasone release (Figure 88) was like expected for single and dual loaded IOLs, indicating, that coatings did not interfere.

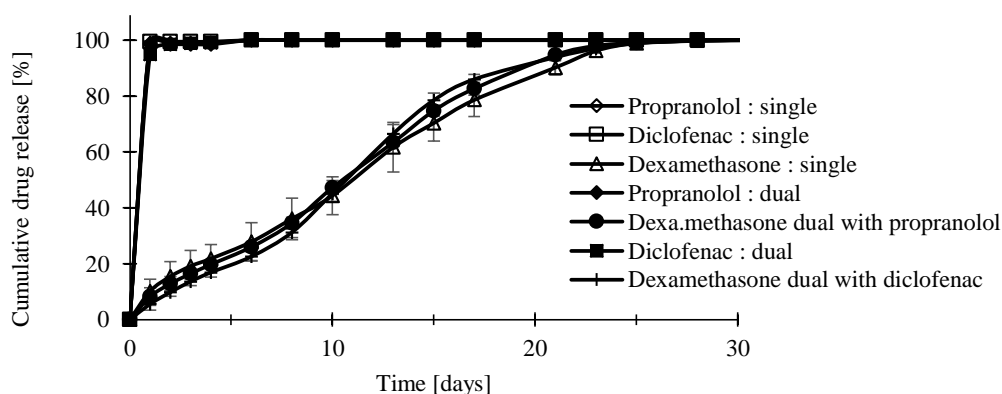

Figure 88: Drug release of single and dual coated IOLs, coated with dexamethasone, diclofenac sodium and propranolol-HCl

Diclofenac sodium (Cs 1.5 g/L) and propranolol hydrochloride (Cs 50g/L) were released within the first 24 hours, due to their higher water solubility. Both APIs were charged and therefore, diffusion into the aqueous media was fast, also attributed to the relatively small molecules [129]. After 24 hours, the diclofenac sodium and propranolol hydrochloride coatings were still present and did not detach during continued release study, but no further drug release was detectable. Nevertheless, coatings degraded by time and adverse effects were not observed.

However, for a bacterized antibiotic, short residual times are acceptable but the release should not fall below three days to ensure sufficient effect duration.

Hydrophobic API:

To improve the drug release of the fast releasing coating area, different approaches are reasonable such as, changing the API/polymer ratio, using PLGAs with modified degradation times or to use a less water-soluble drug. Thereby less dissolved drug will be within the PLGA matrix and less diffusion takes place as well. To prove this, risperidone (0.33 mg/ml) was used as a model drug for a less water-soluble antibiotic and was coated in the same API/PLGA ratio like dexamethasone at the other coating area with 1 mg drug loading each. Lenses were either coated by both coatings at the same time (dual) or just with one API (single). PLGA 5050 DLG 1A was used and shorter degradation times were expected in general.

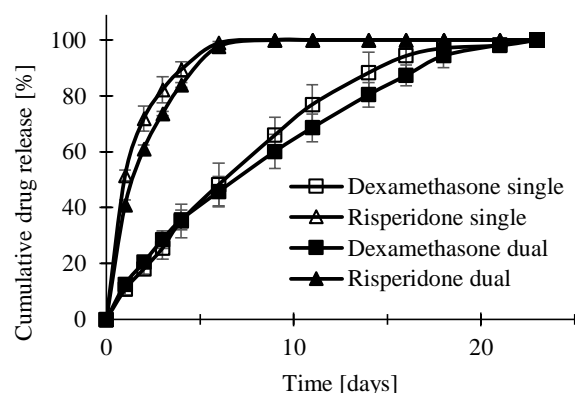

Figure 89: Drug release of IOLs, coated with risperidone and dexamethasone simultaneously and separately

For dexamethasone, drug release was slightly faster than in formulations where PLGA 502 H was used (Figure 89). However, single and dual loaded lenses had similar release profiles for

dexamethasone (similarity factor (f_2): 62.74) and for risperidone as well, so that interactions of coatings could be excluded. The slightly faster release for dual loaded lenses was explained by the more pronounced decrease of pH in release media, due to more PLGA, resulting in more created lactic and glycolic acid. However, this small change was not pivotal.

Attributed to the hydrophobic character of risperidone (Cs: 0.33 mg/ml (pH 7.4/37°C)) the release period was in the desired range and targeted drug delivery profiles were achieved. Therefore, hydrophobic antibiotics could be loaded easily onto the IOLs by separating the two coating areas and treat them differently. So, the use of different PLGAs might be reasonable and dexamethasone (glucocorticoid) could be applied with PLGA 502 H whereas the faster releasing antibiotic model drug (risperidone) could be administered with PLGA 5050 DLG 1A.

When PLGA systems contain two drugs in one matrix simultaneously, interactions might occur and release patterns of both drugs could be changed. Due to the completely different coatings, attached to one IOLs, DDS with two APIs in one polymer matrix could be avoided. Furthermore, modifications would be simple to conduct and the other API would not be affected.

Hydrophilic APIs with extended drug release:

However, most antibiotic APIs are soluble (supplied as salts) in water and thereby it is more challenging to gain extended drug release for this APIs. For bactericidal antibiotics, a drug release of a few days is sufficient in case the drug concentration could be maintained above the minimum bactericidal concentration (MBC) for this time.

Minocycline as an injectable antibiotic drug that is also used in ocular devices [281] was selected, and an extended drug delivery was desired. Minocycline has four different pka values [282] and is charged permanently at different locations of the molecule at each pH value. Therefore, an extended drug release is challenging for this drug.

To prepare dual loaded lenses, IOLs were coated with minocycline, the antibiotic drug at one coating area and dexamethasone at the other side of the IOLs (Table 34). Coatings of 1000 μg /IOLs for dexamethasone and 500 μg /IOL for minocycline per IOLs were applied. Due to the fact, that minocycline is a permanently charged drug in aqueous solution, batch III received a pure PLGA top coating for minocycline to extend drug release (Figure 90).

Table 34: Coating pattern for dual loaded/coated IOLs

Formulation	Coating area 1	Coating area 2
Batch I	Minocycline (0.5%) + PLGA 5050 DLG 1A (2.5%)	Dexamethasone (5%) + PLGA 5050 DLG 1A (2.5%)
Batch II	Minocycline (0.5%) + PLGA 502 H (2.5%)	Dexamethasone (5%) + PLGA 502 H (2.5%)
Batch III	Minocycline (0.5%) + PLGA 502 H (2.5%) + PLGA top coating (5%)	Dexamethasone (5%) + PLGA 5050 DLG 1A (2.5%)

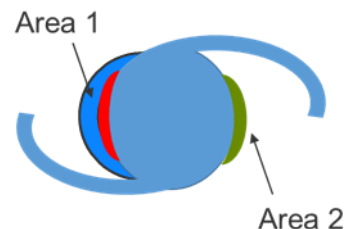

Figure 90: Dual loaded IOLs

Coating Area 1: Minocycline (Batch III with PLGA top coating)
Coating Area 2: Dexamethasone

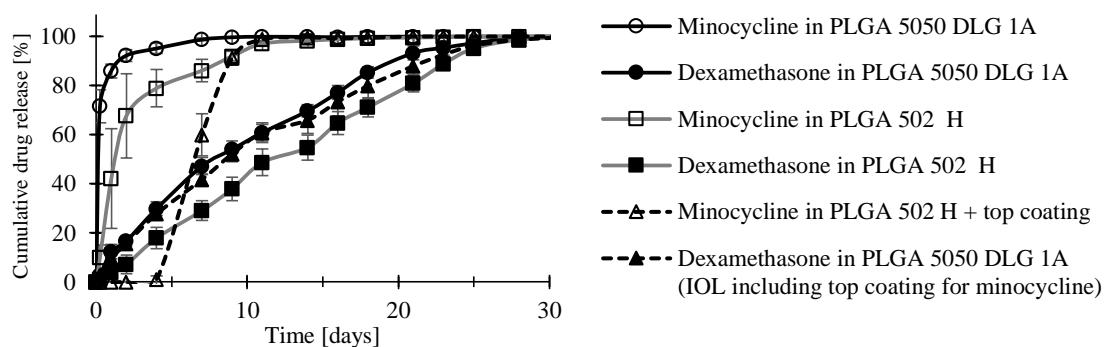

Figure 91: Release of dual loaded IOLs

One coating are was loaded by minocycline and the other one by dexamethasone

Lenses coated differently at both coating areas had a simultaneous release and the release was independent of another (Figure 91). Minocycline, a hydrophilic antibiotic had an immediate released over a few days. The PLGA matrix remained intact at the lens and did not detach after drug release but coating decomposed by time. The two different used PLGA types had different release patterns with minocycline as well as with dexamethasone, due to chain size and different degradation times. Regarding the hydrophilic nature of minocycline, the PLGA ratio was increased to prolong the release. By using PLGA 502 H in the given ratio, the desired release pattern was achieved.

Minocycline coatings that received a top coating of pure PLGA presented a prominent lag phase where no release took place. Minocycline is poorly soluble in ethyl acetate (0.263 ± 0.019 mg/ml) and did not diffuse to the upper coating layer during the coating procedure. As soon as pores were created, minocycline presented a burst release. All the required optical properties of IOLs were be retained and lenses could be considered as safe.

3.3.5.5.1. Suggestion for industrial scale

In the past, IOLs were coated by different approaches [61,121,159,283,284] but none of these techniques prevailed and became successful so far. Lens coatings on the lateral surface had advantages regarding optical properties and practicability issues. Furthermore, these lenses could be prepared on demand for the patient's need with desired drug loadings and release profiles in aseptic conditions with very precise automatic pipets [282]. Lenses could be clamped by suction cups without damaging the lenses and the location of drug administration on the lens could be conducted very accurately, also on the top of the lens, next to the lateral surface. Additionally, sterilization could be ensured by using gamma irradiation sterilization methods [285]. Further, *in vivo* studies are needed to bring this method to the market, but this approach was considered as promising for the future, especially in account to the numerous drug loading approaches for hydrophilic IOLs and the lack for hydrophobic ones, which have the biggest market share nowadays worldwide [45,286].

In respect to the approval of these lenses, a permission as a medical device is reasonable and big money intensive clinical studies could be circumvented.

3.3.6. Conclusions

Hydrophobic intraocular lenses have advantages regarding optical properties and are associated with less posterior capsule opacification. Hydrophobic acrylates soak just small amounts of water, resulting in poor drug diffusion within the polymer matrix, followed by insufficient drug release when the drug is incorporated within the polymer structure. That these lenses can be folded in dry condition facilitates the storage in absence of water, followed by better stability for attached drug delivery systems.

Coated intraocular lenses are easy to insert because the DDS is linked to the IOLs well and detachment did not occur. By coating just two small areas at the lateral surface of the intraocular lenses, foldability could be retained and advantages of hydrophobic acrylates were preserved. By choosing appropriate drug/polymer ratios, sustained drug release with zero order kinetic for dexamethasone was ensured and could be modified with respect to drug loading and drug release.

Applied coatings could be treated differently so that simultaneous drug release of glucocorticoids and antibiotics were possible and drug release/loading could be adjusted independently.

3.4. Amphiphilic lenses

3.4.1. Background

Hydrophilic and hydrophobic intraocular lenses have advantages regarding optical properties and drug loading. For instance, hydrophilic lenses show resistance to glistening, can be loaded by soaking but present fast release, whereas hydrophobic lenses provide high refractive index and prolonged release but tend to become turbid, when drugs are incorporated into the matrix.

Therefore, by using amphiphilic lenses, containing both, hydrophilic and hydrophobic monomers, advantages should be combined and disadvantages overcome.

3.4.2. Lens characterization

3.4.2.1. Lens formulations

In this part, three different lens polymers were investigated mainly (Table 35). Formulation 3 ((HBMA:BMA:IBMA:EA – 20:10:10:60, w/w) was used as a formulation, in which disadvantages of hydrophilic and hydrophobic polymers were combined, whereas formulation 4 (HEMA:POEA:EA – 13:17:70, w/w) is a commercialized amphiphilic lens polymer, that was suggested in a patent [186]. Polymer 5 (HEA:HBMA:BMA:POEA:EA – 20:20:19:2:39, w/w) represents an improved amphiphilic formulation, that combined advantages and was considered as good.

Table 35: Lens polymers, used in this section,
Formulation 3 - 5 were considered as amphiphilic
IOL - polymers

Formulation	Hydrophilic monomers [% (w/w)]	Hydrophobic monomers [% (w/w)]
2	HEMA (80)	MMA (20)
3	HBMA (20)	BMA (10) IBMA (10) EA (60)
4	HEMA (13)	POEA (17) EA (70)
5	HEA (20) HBMA (20)	BMA (19) POEA (2) EA (39)
6	-	MMA (20) EA (80)

The formulation numbering refers to the general numbering in this thesis (Materials and method 2.2.1)

3.4.3. Loading approaches

3.4.3.1. Coating

In order to archive a lateral drug depot to retain a transparent, unloaded lens core, polymer rods were coated by a drug solution (isopropanol (88%) and water (12%)), containing propranolol hydrochloride (3%) and ethyl cellulose (6%). Polymer rods were dipped in the coating solution, dried, then sliced and lenses were drilled out. Thus, prepared lenses were coated just at the outer lateral surface and lens cores remained unloaded.

In release study, lenses remained transparent and drug release was independent of the polymer types (Figure 92), including hydrophilic (formulation 2) and hydrophobic (formulation 6) lens formulations. Inner parts of the lenses were punched out and did not have any drug loading/release, proving that during coating procedure, propranolol hydrochloride did not diffuse into lens material.

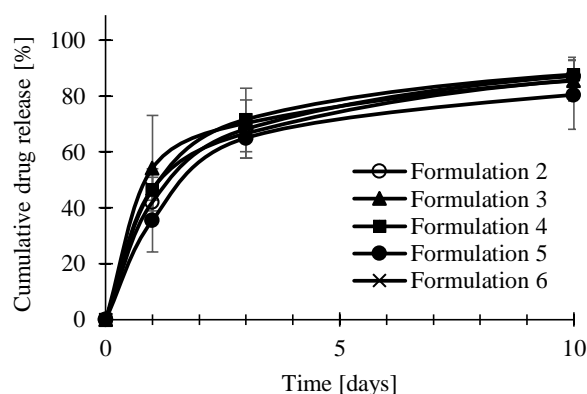

Figure 92: Drug release of lenses, coated at the lateral surface with propranolol – HCl and ethyl cellulose

In some cases, the coating detached during lens preparation and folding of flexible lenses due to low coating adhesion. This is because, ethyl cellulose is a brittle polymer [287], resulting in restricted foldability of coated lenses. Furthermore, due to the lens shape, the coating amount was low and drug loadings, higher than 100 $\mu\text{g}/\text{IOLs}$ could not be achieved.

However, lenses remained transparent, extended drug delivery was obtained and further modifications would be simple, owing to the lens polymer independent DDS. But this approach revealed as just reasonable for non-foldable IOLs.

3.4.3.2. Soaking

3.4.3.2.1. Lens formulation

With respect to the low water content within the lens matrix (formulation 3: $2.03 \pm 0.34\%$, formulation 4: $1.61 \pm 0.63\%$ and formulation 5: $4.57 \pm 0.36\%$), polymers could not be loaded in aqueous soaking solutions, therefore, organic solvents were required. Thus, lenses soaked in ethanolic 1% dexamethasone solution for 24 hours and were dried afterward in a vacuum oven for 144 hours. Foldability could be retained for dry lenses and lenses did not need rehydration prior injection. This is caused by the low glass transition temperatures (T_g) of these polymers (formulation 3: 7.63°C ; formulation 4: 0.33°C ; formulation 5: 10.09°C).

In drug release (Figure 93 A), lenses eluted dexamethasone slow and a strongly extended-release was observed.

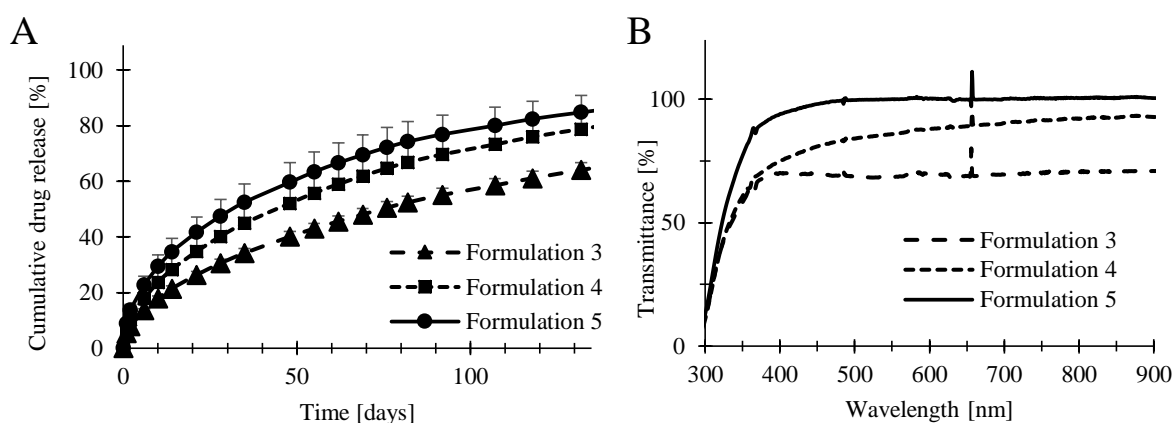

Figure 93: Amphiphilic intraocular lenses

A: Drug release study of dexamethasone loaded IOLs

B: Transmittance of dexamethasone loaded IOLs, 36 days after commencing drug release study

In amphiphilic lenses, the available water for drug diffusion is limited and therefore, leading to more extended drug release. Additionally, drug-polymer interactions got into account for drug release as well. Thus, formulation 3, having $2.03 \pm 0.34\%$ water in the lens matrix had a slower release than formulation 4, containing $1.61 \pm 0.63\%$ water.

Lenses from formulation 3 and 4 became clouded during release (Figure 93 B), due to the precipitated drug within the lens matrix. But transmittance was restored by time again, as the loaded drug was released out. Therefore, IOLs having higher initial drug loadings had less light transmittance in the beginning. In contrast, formulation 5 remained transparent and good optical

properties could be guaranteed during the whole investigation time, which is caused by higher dexamethasone solubility within the polymer matrix.

Polymers, prepared with different amounts of cross-linker had similar release profiles (Figure 94), but the drug loadings decreased in more cross-linked polymers. During soaking, the more cross-linked polymers obstructed swelling and drug diffusion and therefore, less drug was incorporated into the lens matrix (Table 36). In drug release, the main guiding characteristics are water content and drug-polymer interactions [216,217] and the amount of cross-linker had a minor impact, similar to hydrophilic IOLs.

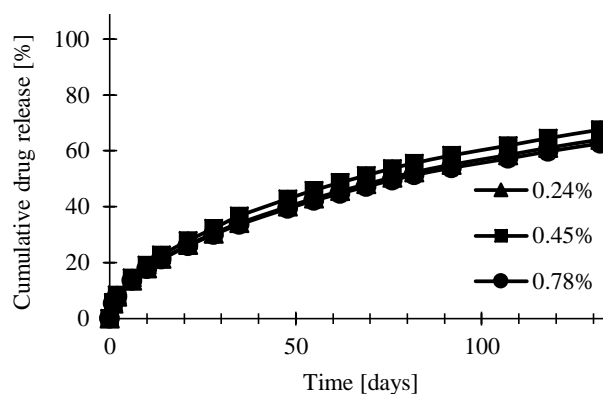

Figure 94: Effect of cross-linker
Drug release study of dexamethasone loaded IOLs;
IOLs (Formulation 3) were prepared with different
amounts of cross-linker

Incorporated water decreased the refractive index because the matrix became less dense in comparison to dry IOLs. Differences in quantities of cross-linker also changed the amount of water, that was soaked into the lens polymer, but these modifications were too small to be detected by the ABBE refractometer. In general, the refractive index is tuned by incorporated water and the selection of appropriate monomers [182].

Table 36: Drug loading and refractive index of intraocular lenses, soaked in 1% ethanolic dexamethasone solution

Formulation	Cross-linker [%]	Drug loading [%]	Refractive index
Formulation 3	0.24	3.87 ± 0.20	1.1771
	0.45	3.52 ± 0.14	1.4768
	0.78	3.03 ± 0.06	1.4769
Formulation 4	0.21	2.61 ± 0.02	1.4886
	0.45	2.56 ± 0.10	1.4886
	0.51	2.36 ± 0.05	1.4886
Formulation 5	0.21	4.44 ± 0.04	1.4852
	0.45	4.03 ± 0.10	1.4852
	0.60	3.71 ± 0.05	1.4840

3.4.3.2.2. Concentration of the soaking solution

To investigate the influence of drug loading, lenses were loaded with dexamethasone in different concentrated soaking solutions (0.25% - 2.0%) for 24 hours. For comparison reasons hydrophilic (formulation 2 (HEMA 80% and MMA 20%)) and amphiphilic lenses (formulation 5) were selected to perform release studies (Figure 95).

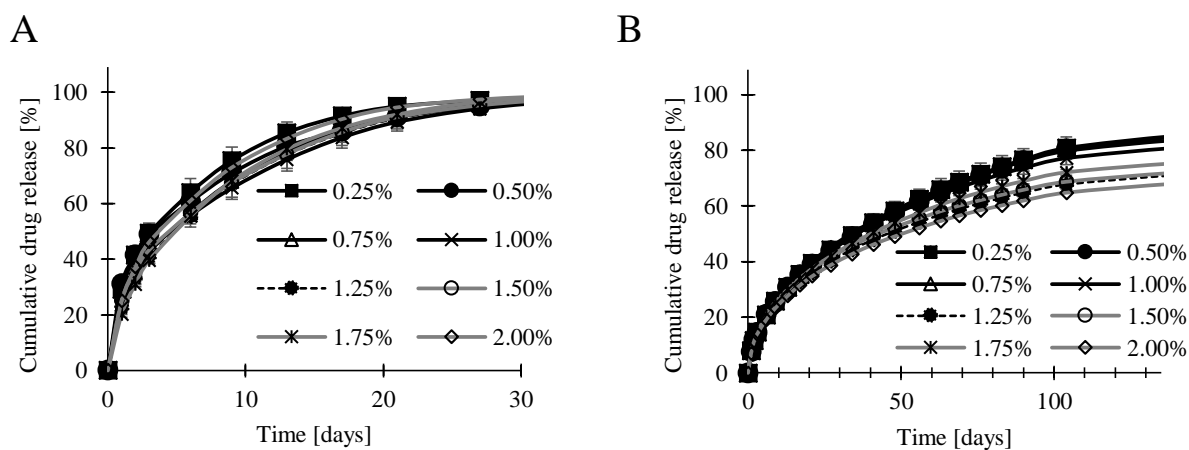

Figure 95: Drug release of lenses soaked in different concentrated ethanolic dexamethasone solutions
 A: Hydrophilic formulation (Formulation 2)
 B: Amphiphilic formulation (Formulation 5)

For amphiphilic IOLs, the drug release patterns were strongly extended in comparison to the hydrophilic polymer. 80% of drug release was achieved for hydrophilic lenses after approximately two weeks and for the amphiphilic formulation after three-four months, respectively. This could be explained by the higher water content ($28.91 \pm 0.63\%$) within the hydrogel (hydrophilic formulation) and the more pronounced hydrophobic interactions between the drug and the polymer in the amphiphilic formulation. The more prominent API-polymer interactions and the more hydrophobic character of the amphiphilic polymer increased the drug loading as well so that more drug was incorporated in that lens material (Table 37).

In hydrophilic lenses, the release was independent of the drug loading and followed first order kinetic whereas, in amphiphilic lenses, the release was more extended in IOLs which soaked in soaking solutions that had concentrations higher than 1.25%.

Table 37: Drug loading of hydrophilic (formulation 2) and amphiphilic (formulation 5) IOLs (mean values \pm SD [%])

Soaking solution [%]	Hydrophilic IOLs [%]	Amphiphilic IOLs [%]
0.00%	0.00 \pm 0.00	0.00 \pm 0.00
0.25%	0.14 \pm 0.01	1.25 \pm 0.04
0.50%	0.79 \pm 0.03	2.57 \pm 0.05
0.75%	1.82 \pm 0.07	3.97 \pm 0.16
1.00%	2.53 \pm 0.01	4.71 \pm 0.06
1.25%	3.52 \pm 0.51	5.73 \pm 0.57
1.50%	3.65 \pm 0.08	6.71 \pm 0.26
1.75%	4.17 \pm 0.04	7.16 \pm 0.21
2.00%	4.88 \pm 0.08	8.35 \pm 0.41

This contrasts with findings for hydrophilic lenses, where higher drug loadings of hydrophilic drugs accelerated the release. This was explained by more dissolved drug within the polymer matrix that increased osmotic pressure, followed by higher water uptake into the polymer matrix and therefore faster release. However, in this case, dexamethasone is poorly soluble and adsorbed to the polymer meshwork and therefore had not remarkably increased osmolarity in the bulk water of the hydrogel (hydrophilic lenses). Hence, release patterns were similar for all hydrophilic lenses.

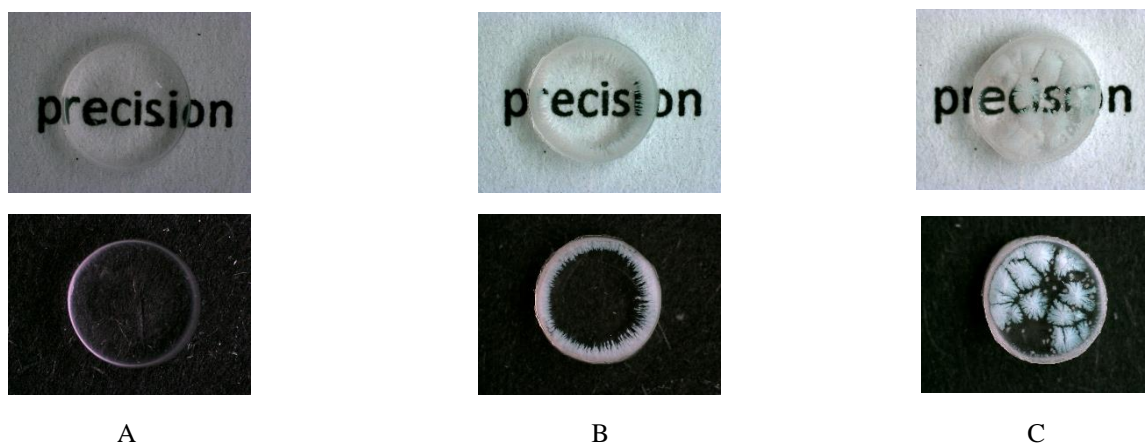

Figure 96: Macroscopic images of dexamethasone loaded amphiphilic IOLs, 140 days after commencing the release study; loaded in ...
A: Soaking solvent: 0.75%
B: Soaking solvent: 1.25%
A: Soaking solvent: 2.00%

For amphiphilic lenses, the initial release was independent of drug concentration, but the release became slower when the drug loading exceeded 5%. This is attributed to crystal formation in lenses, providing high drug loadings (Figure 96). In lenses with drug loading less than 5%, the dexamethasone was dispersed homogeneously within the polymer matrix and no crystals were observed, whereas, in higher concentrated IOLs, drug started to precipitate out and crystallized. When the drug was released from less concentrated IOLs, the drug concentration decreased, resulting in first order kinetics. In higher concentrated lenses, crystals functioned as a reservoir, so that released API was compensated by dissolved API. This could lead to a more extended release, but with respect to ocular devices, crystal formation generally should be avoided due to its side impact on vision.

The precipitated drug had adverse effects on lens transmittance so that lenses with crystal formation had decreased light transmittance (Figure 97).

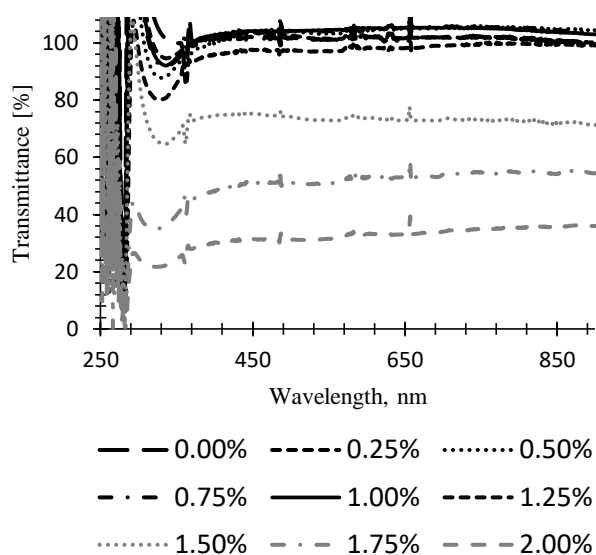

Figure 97: Transmittance of amphiphilic (formulation 5) dexamethasone loaded IOLs (140 days after release study started)

Lenses that soaked in 1.25% ethanolic dexamethasone solution had crystal formation and therefore prolonged drug release, meanwhile, almost 100% light transmittance was recorded. Dexamethasone precipitated in IOLs initially at the outer rim and crystal growth was directed towards the core. So, the core that was measured for transmittance remained transparent whereas the outer part was clouded (Figure 96 B).

To further investigate this behavior, amphiphilic lenses were loaded with ethanolic 1.00% dexamethasone solution in order to prepare transparent IOLs. The core (\varnothing 4 mm) was punched out from dried intraocular lenses and release study was conducted for the core and the lateral part separately (Figure 98).

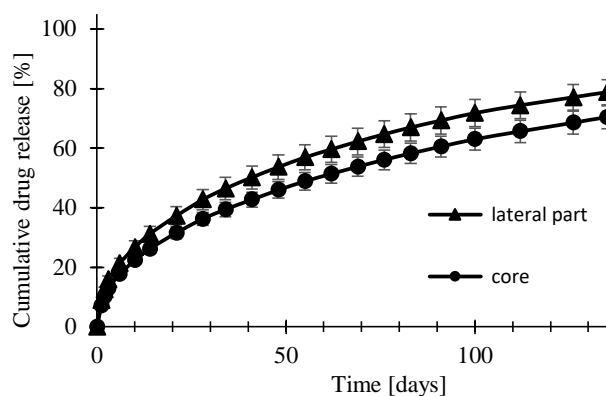

Figure 98: Drug release of dexamethasone loaded IOLs prepared of formulation 5; The inner part of lenses was punched out and release study of the core and the outer rim was conducted separately

The core and the lateral part released dexamethasone similar (Similarity factor: (f_2): 57.24) but not exactly in the same manner. The outer rim eluted the drug slightly faster, due to the increased surface area in comparison to the core. Additionally, the drug loading was higher in the lateral part (Table 38).

Table 38: Drug loading of amphiphilic lenses (formulation 5), soaked in ethanolic dexamethasone (1.00%) solution for 24 hours (mean values \pm SD [%])

Lens area	Drug loading [%]
Lateral part	4.62 \pm 0.22
Core	3.72 \pm 0.18

The increased drug loading in the lateral polymer was caused during evaporating ethanol in the vacuum oven. The swollen lenses were placed in the vacuum oven and ethanol evaporated at the surface of the polymer. Thus, the organic solvent diffused within the lens matrix towards the surfaces and dragged API along. When the ethanol evaporated, the drug remained at the lateral part of the lens and cumulated by time.

So, a higher drug loading was achieved at the outer rim and the core of the IOLs, the most critical optical part was less loaded and therefore transparent. By this, drug precipitation in the center of the lenses could be avoided and a drug reservoir was formed at the lateral polymer.

3.4.3.2.3. API

Most factors that have an impact on drug loading for hydrophilic lenses also influence amphiphilic lenses such as soaking time, drug concentration in soaking solvent and soaking temperature. In addition, drug-polymer interactions might be more pronounced in amphiphilic polymers, due to limited water content. Thus, in hydrophilic lenses, most APIs could be incorporated without affecting transmittance, either in the bulk water of the hydrogel or adsorbed to the polymer. In contrast, amphiphilic lenses showed less capability to remain transparent, therefore, drug solubility within the polymer matrix is critical.

Therefore, lenses were loaded (soaking in ethanolic drug solution for 24 hours at 37°C) with diclofenac (acid) and diclofenac sodium (salt) respectively and drug release was investigated (Figure 99).

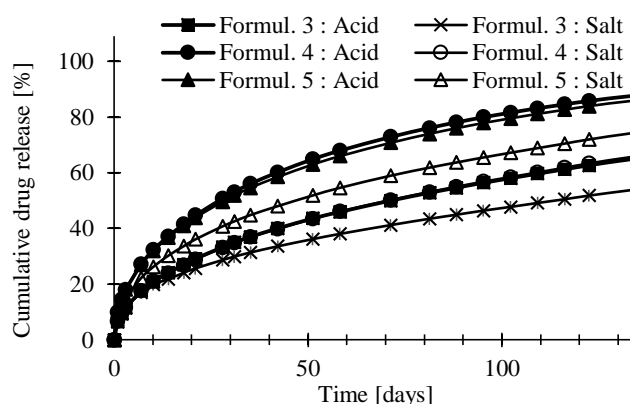

Figure 99: Drug release from amphiphilic IOLs, loaded by diclofenac (acid) and diclofenac sodium (salt)

In all formulations, the release was faster for the acid than for the deprotonated salt (Figure 99). This is in contrast to hydrophilic lenses, where the more hydrophilic diclofenac sodium was released faster. Additionally, for hydrophilic lenses, the drug loading of acid and salt was almost similar, whereas, for amphiphilic lenses, drug loadings for the more hydrophilic diclofenac sodium were lower (Table 39).

In amphiphilic polymers, the hydrophobic acid diffused better into the lens matrix and could be incorporated more easily. During soaking, partition took place. While ethanol diffused into the polymer, hydrophilic diclofenac sodium did not diffuse into the lens polymer in the same ratio. Thus, the hydrophilic API was expelled by the polymer and the drug concentration in soaking media increased slightly because ethanol was removed by soaking into the polymer. The more

hydrophobic acid diffused into the lens matrix in the same ratio with ethanol and drug concentration in soaking solution did not change during soaking. As a result, different drug loadings were achieved for corresponding acid and base. Just in formulation 5, almost the same drug loadings were obtained, suggesting, that both drugs had similar tendency to diffuse into the polymer.

Table 39: Drug loading of amphiphilic lenses, loaded with diclofenac (acid) and diclofenac sodium (salt); (mean values \pm SD [%])

Formulation	Area of IOLs	API	Drug loading [%]
Formulation 3	core	acid	3.31 \pm 0.12
	rim	acid	3.53 \pm 0.02
	core	salt	1.53 \pm 0.20
	rim	salt	1.49 \pm 0.07
Formulation 4	core	acid	2.42 \pm 0.04
	rim	acid	2.47 \pm 0.23
	core	salt	1.65 \pm 0.04
	rim	salt	1.80 \pm 0.19
Formulation 5	core	acid	3.73 \pm 0.07
	rim	acid	3.77 \pm 0.14
	core	salt	3.46 \pm 0.17
	rim	salt	3.77 \pm 0.14

When IOLs were hydrated, water soaked into the polymers and the drugs started to precipitate within the lenses. A decrease in light transmittance was observed for the acid and the salt as well, but more pronounced for the hydrophilic salt, suggesting, that the hydrophobic acid is more soluble within the polymer. However, within the first 2 weeks, the transmittance for IOLs loaded with the acid decreased as well.

Initially, different pH values were present within the IOLs, attributed to the different drugs. But this differences in pH were balanced fast, due to switching hydrogen bonds, named “Grotthuss mechanism” [288]. The Grotthuss mechanism explains, why protons have an extremely high diffusion rate. While other small ions have to diffuse by random thermal motion such as “Brownian motion”, protons do not need to diffuse as particles. The proton transfer is performed

just by switching hydrogen bonds (Figure 100). So, no particle transport is needed and differences in pH are nullified fast. By this mechanism, the initial different compounds within the IOLs became identical, and more specifically deprotonated diclofenac was formed in lenses, that were loaded with the acid form. Thus, the formed less soluble base decreased the transmittance even more pronounced than for lenses, loaded by the base initially, due to the higher drug loading.

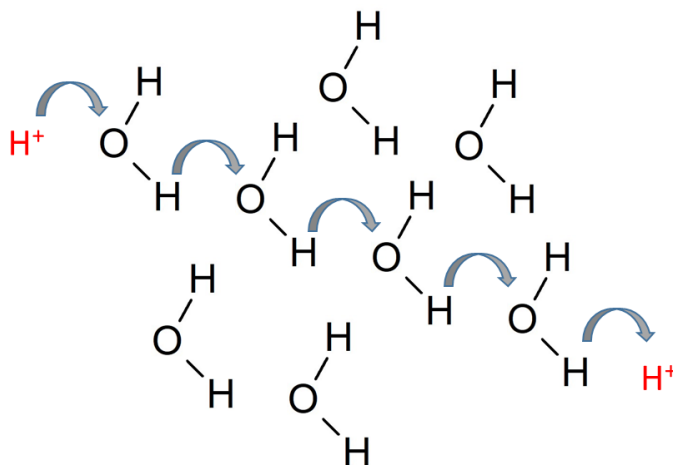

Figure 100: Grotthuss mechanism (Proton hopping)

This higher drug loading also led to the faster release of lenses loaded by acid. After two weeks solubility differences were nullified because all lenses were loaded with the water-soluble base of diclofenac. The higher drug loading in lenses, loaded by the acid initially, created a higher osmotic pressure, resulting in increased water uptake and faster release.

The drug loading in the core and the outer rim was almost identical, suggesting, that diffusing ethanol dragged just little amount of diclofenac to the surface when ethanol was evaporated. Therefore, the drug release was similar from the core and the outer part (Figure 101). This also indicated, that polymers were homogeneous and that by bulk polymerization, the polymer matrix became equal in all parts of the lenses.

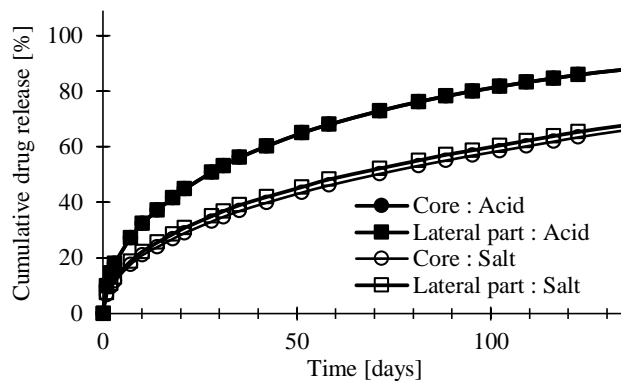

Figure 101: Drug release of the core and the lateral part of IOLs (formulation 4), loaded with diclofenac (acid) and diclofenac sodium (base)

3.4.3.2.4. Glistening

Glistening is the formation of small liquid-filled vacuoles within the lens and appears normally in hydrophobic IOLs but also may occur in other materials such as amphiphilic IOLs [42,289,290]. Glistening is associated with small imperfections in the polymer matrix that lead to bubbles in which water accumulates. Caused by the comparatively large difference in refraction of water (1.33) and the polymer, these bubbles might scatter the light and impair the optical quality of IOLs.

Amphiphilic lenses were immersed in acetone, ethanol, isopropanol, methanol, Milli Q water and aqueous 0.9% sodium chloride solution. Afterward, lenses that soaked in organic solvents were dried either in a vacuum oven at room temperature or in an oven heated to 100°C with ambient pressure. These dried lenses, along with that immersed in aqueous media were placed in artificial aqueous humor at 37°C and were observed regarding glistening formation for one year.

It turned out that glistening formation was independent of drying technic. Glistening was observed in all amphiphilic lens formulations when soaked in acetone, due to extreme swelling (~ 400%) or when organic solvents were not removed completely.

Lenses that were dried completely did not develop glistening and optical quality could be ensured. In general, glistening developed when lenses suffered temperature fluctuation, independent of soaking solvent, except acetone. This is in accordance with the literature [35,43,44,168]. Polymer swelling is temperature dependent and by swelling and de-swelling at different temperatures, polymer chains arrange differently, followed by glistening formation. However, by repeated cooling and heating, glistening was induced and formulation 3 showed

severe glistening, whereas formulation 4 developed less glistening. Formulation 5 formed just a few vacuoles within the lens matrix and was almost resistant to glistening.

Drug loadings had no impact on glistening formation.

3.4.3.2.4.1. Lens polymers optimization

Lens formulation 5 (HEA:HBMA:BMA:POEA:EA – 20:20:19:2:39, w/w) was superior to other lens formulations, regarding drug loading/release and transmittance. Therefore, it was selected for further investigations. Ethyl acrylate was considered as filler. For the other ingredients, each amount was varied to zero or doubled to investigate its impact on the final formulation (Table 40). Increased or decreased monomer amounts were compensated by ethyl acrylate. Modified lenses were loaded by soaking in ethanolic dexamethasone (1.0%) solution and drug release studies were conducted.

Table 40: Modifications of lens formulation 5 and its characteristics; (mean values \pm SD [%])

Ingredients were either:

- replaced by ethyl acetate (No), or
- the double amount of this ingredient was used (2 x)

Polymer modification	Water uptake [%]	Drug loading [%]	Refractive index	Time for unfolding [s]	Clouding
Formulation 5	4.57 \pm 0.36	4.75 \pm 0.09	1.4760	11	No
No HEA	1.99 \pm 0.64	3.52 \pm 0.18	1.4770	7	No
2 x HEA	12.76 \pm 0.57	4.73 \pm 0.06	1.4730	15	No
No HBMA	4.07 \pm 0.60	4.34 \pm 0.12	1.4745	8	No
2 x HBMA	7.92 \pm 0.75	4.14 \pm 0.34	1.4820	45	Yes
No BMA	4.99 \pm 1.65	5.09 \pm 0.14	1.4740	6	Yes
2 x BMA	4.67 \pm 0.28	3.17 \pm 0.35	1.4800	25	Yes
No POEA	4.31 \pm 0.40	4.56 \pm 0.19	1.4770	2	Yes
2 x POEA	5.36 \pm 0.64	4.46 \pm 0.12	1.4815	20	No

Formulation 5: HEA:HBMA:BMA:POEA:EA – 20:20:19:2:39, w/w

BMA: Butyl methacrylate

HEA: Hydroxyethyl acrylate

HBMA: Hydroxybutyl methacrylate

POEA: Phenoxyethyl acrylate

Monomers with hydroxyl groups have a more hydrophilic nature, leading to more water uptake in lenses, containing more hydroxyethyl acrylate or hydroxybutyl methacrylate. In contrast, lenses comprising less hydrophilic monomers had less incorporated water in the polymer matrix. Lenses containing more/less butyl methacrylate or phenoxy ethyl acrylate had similar water uptakes as the basic formulation, attributed to the unchanged ratio of hydrophilic-hydrophobic monomers.

Lenses having more hydroxyethyl acrylate had decreased refractive index, due to the higher water content, whereas polymers with double amount of hydroxybutyl methacrylate had increased refractive index, although the water uptake was higher. This is attributed to the higher content of methacrylate which provided a higher refractive index [182]. So the decreasing effect of the incorporated water was overcompensated by the higher content of methacrylate. This effect of methacrylate on light refraction was also recorded by the increased refractive index for lenses, containing more butyl methacrylate.

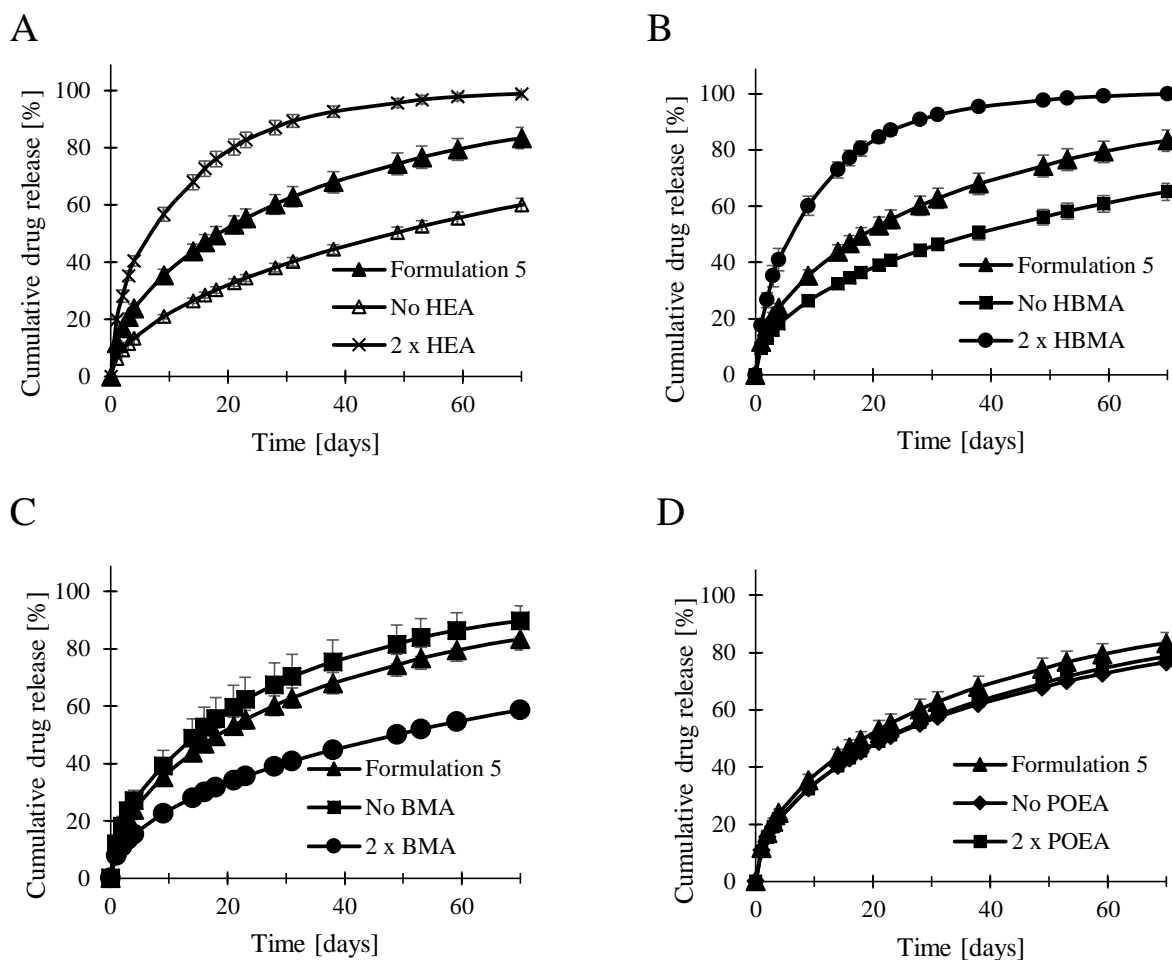

Figure 102: Drug release of dexamethasone loaded IOLs
Modifications of formulation 5
Functional monomers were either replaced by ethyl acrylate or added in double amount
A: Impact of hydroxyethyl acrylate on dexamethasone release
B: Impact of hydroxybutyl methacrylate on dexamethasone release
C: Impact of buthyl acrylate on dexamethasone release
D: Impact of phenoxyethyl acrylate on dexamethasone release

Additionally, methacrylate provides robustness to polymers attributed to the additional methyl group, resulting in more entanglement of polymer chains [182,193]. Since polymer chains slide worse to another in entangled polymers, unfolding was more time-consuming in lenses containing more monomers with steric hindrance due to longer side chains. The use of phenoxyethyl acrylate was tended to modify the unfolding. By using 2% of this monomer, the unfolding could be adjusted to approximately 10 seconds, as desired. It is fast enough regarding practicability and not too fast to have negative effects on ocular tissues [53,291,292].

In drug release study (Figure 102), IOLs containing more hydroxyethyl acrylate showed faster drug release, due to the increased water uptake, followed by improved diffusion of

dexamethasone. Additionally, the drug loading could be improved by using this monomer. This also applied for the hydrophilic hydroxybutyl methacrylate.

Butyl methacrylate prolonged the release, because of the purely hydrophobic character and the additional more expressed side chains. Phenoxyethyl acrylate did not change release patterns, also due to the small quantities.

Since ethyl acrylate was used as a filler, butyl methacrylate was needed to provide a high refractive index as hydroxybutyl methacrylate as well, caused by the refraction increasing properties of methacrylate in general. Hydroxyethyl acrylate was added to adjust water content and flexibility and phenoxyethyl acrylate to retain good unfolding properties. Therefore, all ingredients were needed in order to prepare a superior lens polymer.

3.4.3.3. Copolymerization

Lens formulation 5 was also copolymerized with dexamethasone in order to gain drug-loaded intraocular lenses. Therefore, dexamethasone was dissolved in the monomers in quantities of 0.34% and 0.66%. Higher drug loadings were not possible, because dexamethasone could not be dissolved in higher amounts. Polymers were prepared in vials, with a diameter of 10 mm. Polymer slides were punched out and drug release was performed for the outer part and the core separately. Additionally, IOLs were lathed from different parts of the prepared polymer to check drug distribution and differences in the polymer. All lenses remained transparent and refractive index was retained.

In drug release, dexamethasone was eluted in similar release patterns from lenses (similarity factor (f_2): 78.01) of different drug loadings (Figure 103), attributed to purely diffusion controlled drug release that is independent of drug loading. Drug loading and release were equal for IOLs, lathed from different areas of the polymer, proving that drug was distributed homogeneously and that polymer matrix was consistent as well. Additionally, release pattern were similar to IOLs loaded by the soaking method.

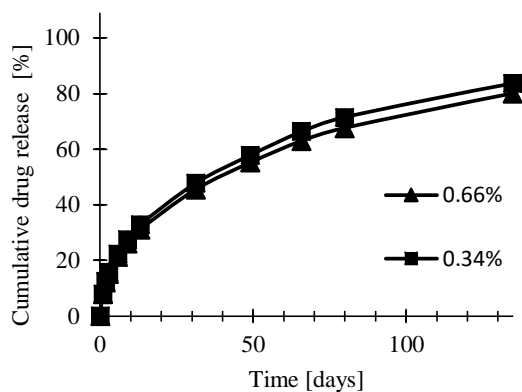

Figure 103: Drug release of dexamethasone loaded IOLs, Dexamethasone was loaded by copolymerization (formulation 5)

Drug recovery was close to 100% after one year, indicating that dexamethasone is stable during polymerization. In contrast, theophylline was recovered just to 76%, due to its degradation during radical polymerization even though monomers solidified and transparent polymers were obtained.

Nevertheless, this approach was not successful, due to remaining monomers within the formulation. With respect to the incorporated drug, no purification was performed and remaining monomers would have negative effects on ocular tissues.

3.4.3.4. Loading at the lateral surface

3.4.3.4.1. Polymers with low drug solubility

Amphiphilic IOLs have been proven to be good devices for ocular drug delivery owing to possible high drug loading and extended drug release. In addition, optical properties such as refractive index and perfect transmittance could be guaranteed for unloaded lenses. However, most amphiphilic lenses tend to become cloudy when drugs were incorporated into the lens matrix. Therefore, a lateral drug loading of IOLs would be desirable. This could provide the desired release patterns and the central part of IOLs would remain transparent.

Therefore, polymer rods soaked in ethanolic methylene blue (0.005%) solution at 37°C. Thus, the swelling front was clearly visible and could be observed easily. Lens formulation 3, 4 and 6 as a hydrophobic polymer were selected in order to investigate lateral drug loadings. It was assumed that drug loadings would tarnish the polymers, especially when hydrophilic drugs were used.

For all polymers, ethanol soaked into the polymer rods for 1 mm within two hours. This was considered as an appropriate loading area, with respect to the still existing un-soaked core that should remain unloaded.

Polymer rods of all three formulations soaked in ethanolic propranolol hydrochloride (5.0%) solution for two hours at 37°C. Then, polymer rods were gently dapped with some absorbent tissue and were stored in a vacuum oven to evaporate organic solvent for 144 hours. Next, lenses were drilled out and polished.

For all lens formulations, the total drug loading was low (Table 41), attributed to the small amount of polymer that was accessible for drug loading. This could be improved by longer soaking times, but this leads to drug diffusion to central parts as well. Additionally, drug concentration in soaking media could be increased. In amphiphilic polymers, the amount of loaded drug was equal, whereas less was loaded in the hydrophobic formulation (formulation 6). During soaking, the hydrophilic API tend to remain in the ethanol and less API diffused into the hydrophobic polymer matrix.

Table 41: Drug loading of IOLs, loaded at the lateral polymer area; (mean values \pm SD [%])

Formulation	Drug loading [$\mu\text{g}/\text{IOL}$]
Formulation 3	90.38 \pm 7.32
Formulation 4	90.02 \pm 5.35
Formulation 6	44.33 \pm 2.08

During drug release study, lenses that were just loaded at the outer rim of IOLs remained transparent in the center part and 100% of light transmittance could be guaranteed in the first month (Figure 104). The lateral part of the IOLs became turbid and light transmittance decreased to zero%. In the core, the refractive index was stable and glistening was not formed. Thus, all critical optical characteristics could be retained by this approach. By time, lenses of formulation 3 and 6 became slightly turbid in the core and transmittance decreased as well. This effect was very small in the center but more pronounced in the initial unloaded polymer next to the drug-loaded part. Delayed clouding of unloaded parts was attributed to drug diffusion within the lens. So, undirected diffusion delivered drug to the artificial aqueous humor, but also into unloaded parts of the IOLs. Therefore, the clouding decreased by increasing distance to the loaded polymer.

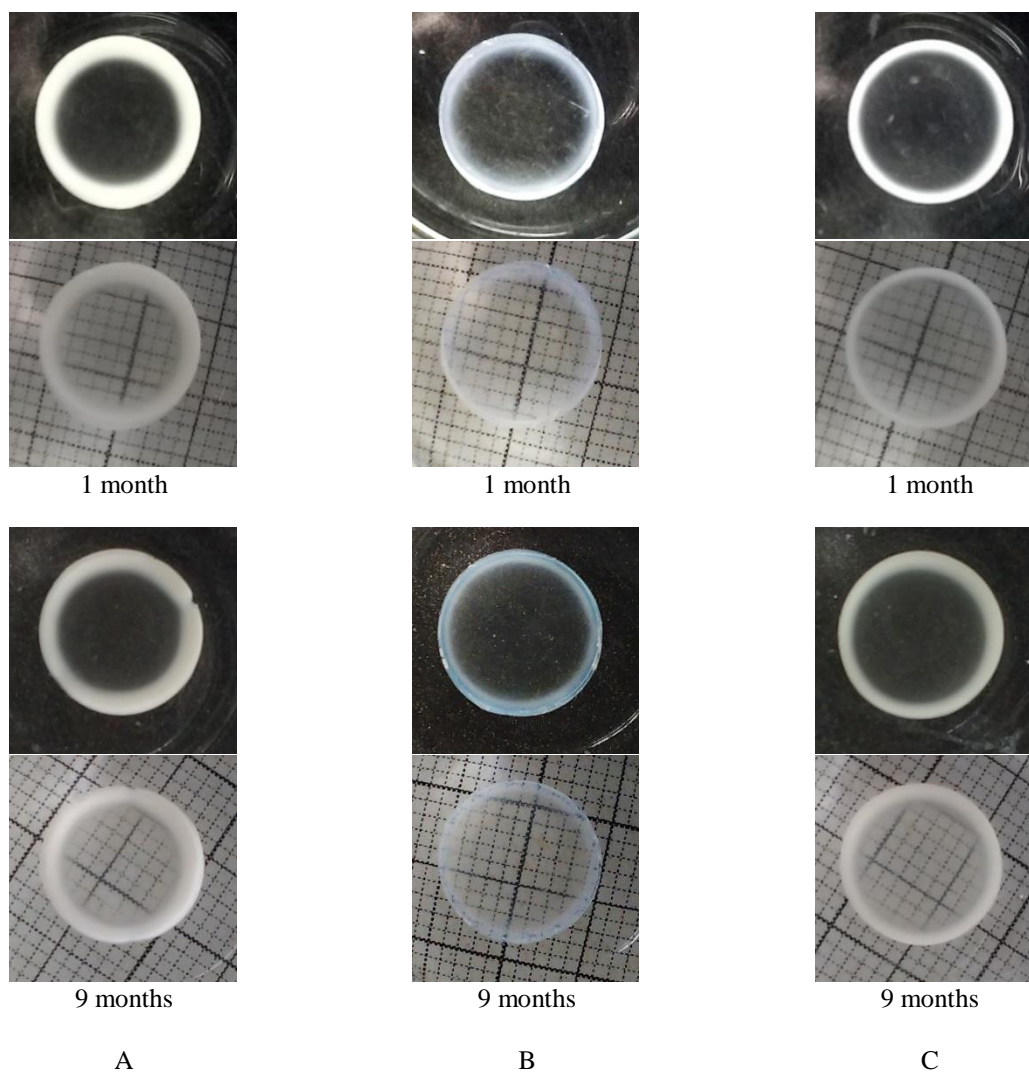

Figure 104: IOLs, loaded at the lateral area with propranolol hydrochloride, one and nine months after commencing release study
A: Formulation 3 (HBMA:BMA:IBMA:EA – 20:10:10:60, w/w)
B: Formulation 4 (HEMA:POEA:EA – 13:17:70, w/w)
C: Formulation 6 (MMA:EA – 20:80, w/w)

Formulation 4 remained completely transparent in the core, due to a higher drug solubility within the polymer matrix. This indicated that a certain drug solubility within the polymer is necessary to avoid delayed clouding.

The drug release was strongly extended (Figure 105), caused by low water content within the polymers and the amphiphilic/hydrophobic nature of these polymers. In accordance with the release of dexamethasone, formulation 4 delivered drug faster than formulation 3. The purely hydrophobic polymer (formulation 6) released propranolol hydrochloride the slowest but just slightly slower than formulation 3. Regarding the low drug loading, just lateral drug loadings for these polymer formulations were considered as insufficient.

Despite the extremely prolonged release, lenses remained turbid at the lateral surface for over 1 year. Theoretically, this is not an issue, but it was considered as a cosmetic problem.

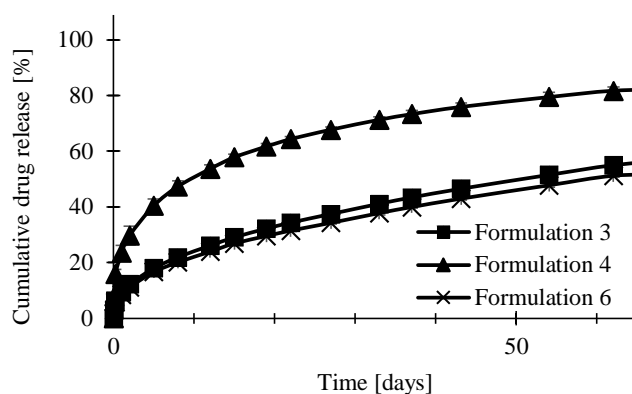

Figure 105: Drug release of IOLs, loaded with propranolol hydrochloride at the lateral area

3.4.3.4.2. Polymer with improved drug solubility

To retain 100% light transmittance of lens cores from IOLs in which drug is loaded in the lateral polymer, the drug solubility within the polymer should be high enough to prevent tarnishing of the polymer by a drug that emigrates from the loaded lateral area towards the core of the IOL. Therefore, formulation 5 was loaded laterally with ethanolic propranolol hydrochloride solution in various concentrations and with dexamethasone solution (1.25%) as well. Propranolol hydrochloride was used as a hydrophilic drug and dexamethasone as a hydrophobic drug respectively.

Drug release followed first-order kinetic for propranolol and dexamethasone as well, indicating that it is a diffusion controlled DDS (Figure 106). Caused by the higher water uptake of the polymer, drug release was faster than in other amphiphilic formulations. The hydrophobic dexamethasone was released slower in contrast to propranolol hydrochloride, due to the lower water solubility of the API and increased drug-polymer interactions [217,218].

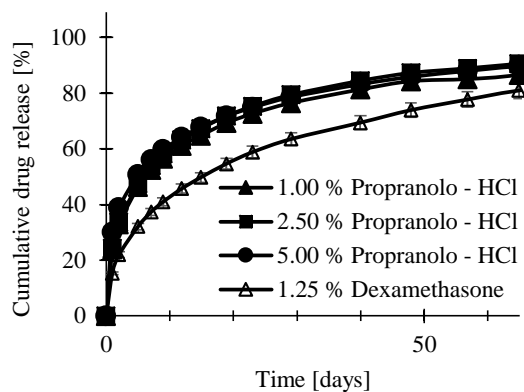

Figure 106: Drug release of lenses (formulation 5), loaded at the lateral area

The more pronounced interaction between polymer and dexamethasone also led to higher drug loadings (Table 42). In other words, similar drug loadings of propranolol hydrochloride and dexamethasone were achieved when the concentration of the hydrophilic compound was twofold higher than the dexamethasone concentration in soaking solution.

Table 42: Drug loading of IOLs, loaded at the lateral polymer (mean values \pm SD)

Soaking solution	Drug loading [$\mu\text{g}/\text{IOL}$]
1.00% propranolol - HCl	121.60 \pm 15.24
2.50% propranolol - HCl	282.15 \pm 14.92
5.00% propranolol - HCl	609.87 \pm 59.24
1.25% dexamethasone	275.03 \pm 3.61

The transmittance of IOLs was retained for all lenses in the core and the lateral part as well. Only in lenses that were loaded with the highest propranolol concentration, the outer rim turned clouded within the first days but became transparent again by time (Figure 107).

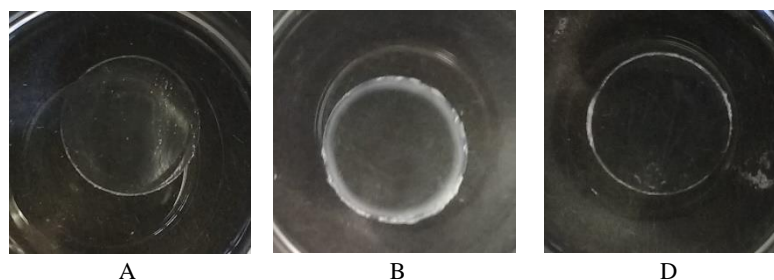

Figure 107: Images during drug release study of laterally loaded lenses; IOLs (formulation 5) were loaded by ethanolic 5% propranolol – HCL solution
A: 0 h; B: 9 days; D: 160 days

By this approach, optical properties of the inner core could be retained and drug loading did not affect the optical performance of IOLs. The incorporated drug is not located in the optical area so that even high drug loadings are reasonable, because drug precipitation within the outer lens polymer is not critical. However, a specific amount of drug should be soluble within the lens formulation to guarantee 100% light transmittance during drug release, regarding drug diffusion within the polymer matrix.

With respect to the limited amount of polymer that is available for drug loadings, potent APIs should be used to promote the desired effect.

3.4.4. Conclusions

Amphiphilic intraocular lenses presented capability to provide extended drug release with different APIs and release patterns could be adjusted by appropriate composition of polymers. Thus, amphiphilic lenses combined the advantages of hydrophilic polymers such as resistance to glistening and transparent IOLs and advantages of hydrophobic IOLs such as prolonged release, high refractive index, and foldability in dry conditions. Consequently, amphiphilic IOLs were superior to both, purely hydrophilic and purely hydrophobic IOLs regarding drug loadings.

Drug loadings just in the outer rim of IOLs sustained the optical quality of polymers in the core and drug release in desired performances was achieved. Therefore, amphiphilic lenses, that are not used so frequent nowadays could gain interest again and could be used as DDS that is close to the tissues which should be provided by drugs.

4. Summary/Zusammenfassung

4.2. English

Nowadays, the cataract surgery is the most often performed surgery worldwide and considering the demographic changes, the incidence of age-related cataract is expected to increase further. In the developing countries, cataract is still the main cause for blindness but as the health system improves, the number of cataract surgeries is steadily increasing. During the surgery, the clouded natural lens is removed and replaced by an artificial intraocular lens (IOL), which consists out of the optical part and small anchors that localize the lens within the eye, named haptic. Although postoperative complications are rare, patients have to apply eye-drops or ointments frequently (every 2 - 4 hours in the first week) due to the very poor bioavailability of topical ophthalmica. This results in low patient compliance, especially among elderly people. Different drug delivery systems (DDS) for the posterior eyeball have been investigated recently, however, none of these DDS reduced the need for additional topical drug instillations. Therefore, a better medical treatment is highly desired for patients, who have undergone a cataract operation. It has been suggested, that the inserted intraocular lenses could be used as a potential vehicle for drug delivery and would release the API directly to the targeted tissues. Furthermore, drug-eluting lenses could maintain sustained drug release. The cataract surgery and intraocular lenses have been steadily improved for almost 70 years and the development of the drug-eluting lenses is the next step in this ongoing evolution.

This research project focused on the development of drug-loaded intraocular lenses in order to avoid frequent drug administrations after cataract surgeries and to reduce postoperative complications, such as infections and inflammations. Therefore, extended drug release of antibiotics and steroids was targeted, while it was essential to preserve perfect optical properties of the IOLs. Besides the 100% light transmittance, high refractive indexes were desired as well as the flexibility of IOLs needed to be preserved in order to facilitate lens insertion in a folded manner.

In order to resemble common commercialized IOLs, various formulations of hydrophilic, hydrophobic and amphiphilic IOLs were prepared by polymerization of various acrylates and methacrylates. All prepared lenses were characterized and had comparable physical and chemical properties to the marketed IOLs.

Hydrophilic lenses were either prepared by bulk-polymerization of solely 2-hydroxyethyl methacrylate (HEMA) or in a mixture with the hydrophobic methyl methacrylate (MMA) (20%, w/w). Hydrophilic IOLs swelled in water and formed hydrogels. Thus, the refractive index of pure poly-HEMA lenses, 1.4200, was improved to 1.4500 with increasing amount of MMA in the composition due to the reduced water uptake (50% - 30%). The drug loading for hydrophilic lenses was achieved by soaking in aqueous drugs solutions and was affected by various factors such as the API solubility, the drug concentration in the soaking media, the soaking time and the lens polymer composition. To increase soaking efficiency, the soaking media was replaced by ethanol, as a low toxic organic solvent. By using ethanol as soaking solvent, increased drug loadings, also for less water-soluble drugs, were achieved. After soaking, ethanol was removed by drying in a vacuum oven, and optical properties of the drug-loaded lenses were preserved perfectly. In a dry state hydrophilic methacrylates were brittle, however, initial lens shape and flexibility were restored and ensured after lens rehydration, due to the plasticizing effect of incorporated water. Therefore, lens rehydration in biocompatible medium should be performed prior to its surgical insertion to the patient.

To prepare hydrophilic lenses, loaded with two drugs simultaneously, IOLs were soaked in ethanolic dexamethasone solution followed by drying. Further, the rehydration was performed in aqueous drug (sodium salicylate) solution and thereby, the second drug was loaded. By prolonging the rehydration from 1 hour to 5 hours, the sodium salicylate loading was increased slightly from $0.55 \pm 0.05\%$ to $0.62 \pm 0.01\%$ for pure HEMA lenses and was almost doubled from $0.24 \pm 0.01\%$ to $0.40 \pm 0.01\%$ for polymers, containing 20% MMA. However, longer soaking/rehydration times decreased the dexamethasone loading from $0.57 \pm 0.05\%$ to $0.47 \pm 0.01\%$ and from $0.88 \pm 0.01\%$ to $0.87 \pm 0.01\%$ for both formulations, due to dexamethasone release into the rehydration media. In comparison to IOLs, prepared solely by HEMA, IOLs, containing 20% of the hydrophobic methyl methacrylate, had a slower drug uptake and consequently slower release, caused by a slower drug diffusion, attributed to the lower water content. Furthermore, simultaneous drug release was observed from IOLs; the diffusion driven release of dexamethasone was strongly extended ($t_{80\%}$: 14 days) due to its low water solubility compared to the better soluble sodium salicylate ($t_{80\%}$: 1 day).

To avoid the premature drug release during rehydration, lenses were loaded in ethanolic drug solutions, containing diclofenac sodium, dexamethasone or both APIs simultaneously. Drug loadings were close to 2% for both APIs in single- and in dual-loaded lenses. After the ethanol removal, the rehydration was performed within 30 minutes in saturated aqueous drug solutions

to avoid drug release, while restoring the flexibility of the lenses. In single-loaded intraocular lenses, diclofenac sodium was released faster ($t_{80\%}$: 72 hours) than dexamethasone ($t_{80\%}$: 16 days), attributed to its higher water solubility. In dual-loaded lenses, diclofenac release rate was comparable to the single-loaded formulation, while dexamethasone release was accelerated. The additional loaded hydrophilic drug increased the osmotic pressure within the lens, causing a higher water uptake, which resulted in more dissolved dexamethasone within the water phase of the hydrogel and thereby a faster drug release. In DSC, there were no melting peaks observed in the dried drug-loaded IOLs, whereas the T_g was decreased, suggesting that drugs were monomolecularly dispersed and had plasticizing properties. Transparency of all lenses was confirmed during and after the drug release.

A specific two chamber device was suggested, in order to supply drug-loaded intraocular lenses in a dry state for improved product stability. The dried lens was stored in the first chamber, whereas the second chamber contained the rehydration/loading media. By releasing the IOL into the second chamber, the rehydration was accomplished in the same device and thus, the risk of contaminations was reduced. Therefore, hydrophilic lenses already loaded with poorly soluble drugs could be delivered to the physicians in the dry state, requiring just a short rehydration, accomplished by the same packaging device 30 minutes before the surgery.

Nowadays, hydrophobic acrylates are the most common IOL materials due to their high refractive index (1.4900 – 1.5500) and less frequent postoperative complications. Homopolymers of polymethyl methacrylate (PMMA) and polyphenoxyethyl acrylate (pPOEA) were prepared and characterized as an example of commercially available hydrophobic lenses. In contrast to hydrophilic lenses, sufficient drug loadings for hydrophobic IOLs could not be achieved by soaking in aqueous drug solutions, due to the insufficient water penetration into the lens matrix (< 0.5%). Although, higher drug loadings were achieved with organic solvents, drug release in aqueous medium was very low, due to the low drug diffusion within the lens polymers. When the polymer compositions were modified to improve the drug diffusion, the optical quality of lenses decreased extremely.

Therefore, external drug delivery systems were investigated and lenses were either coated at the lateral surface of the optical part or at the haptic. Different coating patterns were examined. When the coating was applied on the lateral surface of the IOLs, the required foldability of IOLs could be preserved and the optical parts in the center of the intraocular lenses remained untreated. Therefore, 100% light transmittance was ensured. The PLGA was used as a

biodegradable polymer for dexamethasone coatings and zero-order release kinetics for various drug loadings were successfully achieved. Furthermore, the two coating areas were divided and could be tuned for different drugs completely independently. Therefore, applied coatings were adjusted with respect to the drug solubility, the drug loading, the PLGA and the coating level in order to obtain release patterns with the desired performances. Hence, minocycline, as a model antibiotic drug was released within one week and dexamethasone as a glucocorticoid was eluted within one month, from a single IOL formulation. The coating adhesion on the hydrophobic intraocular lenses was good and after the completed PLGA degradation, these lenses had identical properties as the non-coated lenses.

Amphiphilic lenses combined the advantages of hydrophilic and hydrophobic lenses. While hydrophilic lenses could be loaded by soaking methods, hydrophobic lenses presented a higher refractive index, the drug release was more extended and foldability was provided, also in the dry state. Therefore, three different lens polymers were prepared, containing hydrophilic (hydroxyethyl methacrylate, hydroxybutyl methacrylate, and hydroxyethyl acrylate) and hydrophobic (butyl methacrylate, ethyl acrylate, isobutyl methacrylate and phenoxyethyl acrylate) monomers in different ratios. The drug loading by soaking in ethanolic dexamethasone solution was evaluated and the drug release was strongly extended ($t_{80\%}$: 190 – 240 days), due to limited water content within the polymer matrix ($2.03 \pm 0.34\%$ - $4.57 \pm 0.36\%$) and drug-polymer interactions. Dexamethasone precipitated within some lens polymers leading to decreased light transmittance. Therefore, a lens polymer composition was optimized and the ratio of monomers was tuned in order to improve the drug loadings, release patterns, the refractive index and the flexibility of intraocular lenses.

In order to ensure 100% light transmittance for IOLs which became turbid when drugs were incorporated into the polymer matrix, lenses were only loaded within the lateral rim, therefore the core of the IOL remained unloaded, and thus clear. Polymer rods were soaked for limited time periods, hence soaking media could only diffuse into the outer rim. After the solvent evaporation, the polymer rods were sliced and IOLs were drilled out. During the release study, perfect optical properties were guaranteed in the center of the IOLs, whereas the outer rim of the IOLs became turbid, attributed to the drug precipitation. Although due to the smaller amount of polymer which was drug-loaded, the total loading decreased, the extended drug release was demonstrated. For potent drugs (e.g. dexamethasone) these lateral drug loadings were sufficient to achieve therapeutic effects.

In conclusion, intraocular lenses were loaded with drugs and extended release patterns were achieved. For the different polymer compositions of intraocular lenses, diverse loading approaches were required. Hydrophilic and amphiphilic polymers could be successfully loaded by soaking, while hydrophobic acrylates required drug coatings on the lens surfaces, due to the low water content, followed by insufficient drug diffusion within the lenses. Furthermore, a specific two chamber device was suggested, to improve lens long-term stability and to avoid a premature drug release. Since drug-loaded lenses should be supplied in dry conditions to improve stability and to avoid a premature drug release, a specific two chamber device was suggested. The drug-loaded hydrophilic IOLs were stored in dry state and rehydration in a sterile environment was possible within 30 minutes. Foldability of amphiphilic and hydrophobic lenses was ensured also for unhydrated lenses. Dual loaded IOLs, presented the desired release patterns for both drugs simultaneously, thus the frequent drug administration after cataract could be avoided.

Therefore, drug-eluting intraocular lenses are very promising devices for ocular drug delivery!

4.3. Deutsch

In der heutigen Zeit ist die Kataraktoperation die am häufigsten durchgeführte Operation weltweit und angesichts des demographischen Wandels wird die Zahl der an altersbedingten Katarakt (Grauer Star) leidenden Menschen in Zukunft weiter zunehmen. In Entwicklungsländern ist Katarakt immer noch der häufigste Erblindungsgrund. Da sich das Gesundheitssystem aber auch in diesen Regionen der Welt verbessert, wird die Anzahl der Kataraktoperationen in den nächsten Jahren noch zusätzlich ansteigen. Während dieser Operation wird die getrübe, natürliche Linse entfernt und durch eine künstliche Intraokularlinse (IOL) ersetzt. Diese besteht aus dem optischen Teil und kleinen Ankern, welche die Linse im inneren des Auges fixieren und Haptik genannt werden. Obwohl postoperative Komplikationen selten sind, müssen Patienten Augentropfen oder Augensalben anwenden. Wegen der sehr schlechten Bioverfügbarkeit von topisch angewendeten Arzneimitteln am Auge, muss die Wirkstoffapplikation in den ersten Tagen sehr häufig (alle 2 bis 4 Stunden in der ersten Woche) erfolgen. Dies führt, insbesondere bei älteren Menschen, zu einer geringen Compliance. Es wurden unterschiedliche Wirkstoff-Freisetzungssysteme für den hinteren Teil des Auges entwickelt, aber keine dieser Arzneiformen reduzierte die Notwendigkeit einer zusätzlich okularen, topischen Arzneiform. Daher ist eine bessere medizinische Versorgung für Patienten, die sich einer Kataraktoperation unterziehen, sehr erwünscht. Seit einigen Jahren wird die implantierte Intraokularlinse als potentieller Träger für Arzneimittel gesehen, mit der die Wirkstoffe direkt am Zielgewebe freigesetzt werden könnten. Darüber hinaus besteht bei wirkstoffabgebenden Intraokularlinsen die Möglichkeit eine kontinuierliche Arzneimittelfreisetzung zu gewährleisten. Die Kataraktchirurgie und die Intraokularlinsen wurden seit fast 70 Jahren kontinuierlich verbessert. In diesem fortlaufendem Prozess ist die Entwicklung von wirkstofffreisetzenden Linsen nun einer der nächsten Schritte. Dieses Forschungsprojekt fokussierte sich auf die Entwicklung von wirkstoffbeladenen Intraokularlinsen, welche die häufigen Medikationen nach Kataraktoperationen vermeiden und postoperative Komplikationen, wie Infektionen und Entzündungen reduzieren sollten. Voraussetzungen dafür waren eine verlängerte Wirkstofffreisetzung von Antibiotika und Steroiden sowie die Erhaltung perfekter optischer Eigenschaften der intraokularen Linsen. Neben einer Lichtdurchlässigkeit von 100% war ein hoher Brechungsindex erwünscht. Außerdem musste die Flexibilität der IOLs erhalten bleiben, um die Implantierung der Linsen im gefalteten Zustand zu ermöglichen.

Um handelsübliche IOLs herzustellen, wurden verschiedene Formulierungen von hydrophilen, hydrophoben und amphiphilen Materialien durch Polymerisation von verschiedenen Acrylaten und Methacrylaten hergestellt. Alle hergestellten Linsen wurden charakterisiert und hatten ähnliche physikalische und chemische Eigenschaften wie die vermarkteten IOLs.

Die hydrophilen Linsen wurden entweder durch Polymerisation von reinem 2-Hydroxyethylmethacrylat (HEMA) oder in einer Mischung mit dem hydrophoben Methylmethacrylat (MMA) (20%, w/w) hergestellt. Die hydrophilen IOLs quollen in Wasser und bildeten Hydrogele. Durch Zugabe von Methylmethacrylate war die Quellung der Linsen geringer (30% anstatt 50%) und der Brechungsindex konnte im Vergleich zu reinen PolyHEMA-Linsen von 1.4200 auf 1.4500 verbessert werden. Hydrophile Linsen wurden in wässrigen Wirkstofflösungen gelagert und dadurch mit Wirkstoffen beladen. Die Arzneimittelbeladungen wurden durch verschiedene Faktoren, wie die Löslichkeit des Wirkstoffes, die Arzneistoffkonzentration im Beladungsmedium, die Einweichzeit und die Polymerzusammensetzung der Linsen modifiziert. Um die Effizienz der Beladung zu erhöhen, wurde das Einweichmedium durch Ethanol als ein organisches Lösungsmittel ersetzt. Durch die Verwendung des Ethanols als Tränklösung wurden erhöhte Wirkstoffbeladungen, auch für weniger wasserlösliche Wirkstoffe, erzielt. Das Ethanol wurde nach der Beladung in einen Vakuumofen entfernt, während die optischen Eigenschaften der wirkstoffbeladenen Linsen erhalten werden konnten. Hydrophile Methacrylate waren spröde, wurden aber im gequollenen Zustand aufgrund der weichmachenden Wirkung des eingesaugten Wassers faltbar. Daher wurde bei trockenen Linsen eine Rehydratisierung durchgeführt, um die Flexibilität und die ursprüngliche Linsenform wiederherzustellen.

Um hydrophile Linsen herzustellen, die gleichzeitig mit zwei Wirkstoffen beladen waren, wurden die IOLs in ethanolischer Dexamethasonlösung getränkt und anschließend getrocknet. Die Rehydratation wurde in wässriger Wirkstoff (Natriumsalicylat)-Lösung durchgeführt und der zweite Wirkstoff diffundiert während diesem Prozess in die Linsen. Durch die Verlängerung der Rehydratation von einer auf fünf Stunden wurde die Natriumsalicylatbeladung für reine HEMA-Linsen von $0,55 \pm 0,05\%$ auf $0,62 \pm 0,01\%$ leicht erhöht und bei Linsen, die 20% Methylacrylate enthielten, von $0,24 \pm 0,01\%$ auf $0,40 \pm 0,01\%$ fast verdoppelt. Die längeren Einweich-/Rehydratisierungszeiten verringerten jedoch die Dexamethasonbeladung von $0,57 \pm 0,05\%$ auf $0,47 \pm 0,01\%$ und von $0,88 \pm 0,01\%$ auf $0,87 \pm 0,01\%$ für beide Formulierungen, da Dexamethason bereits in dem Rehydratationsmedien freigesetzt wurde. Linsen, die 20% des hydrophoben Methylmethacrylats enthielten, hatten eine langsamere Arzneimittelaufnahme

und eine langsamere Freisetzung, bedingt durch eine langsamere Wirkstoffdiffusion, die auf den niedrigeren Wassergehalt zurückzuführen war. Die IOLs gaben gleichzeitig Natriumalicylat und Dexamethason ab und aufgrund der geringen Löslichkeit des Dexamethasons war die diffusionsgetriebene Freisetzung im Vergleich zum sehr löslichen Natriumalicylat ($t_{80\%}$: 1 Tag) stark verlängert ($t_{80\%}$: 14 Tage).

Um eine vorzeitige Wirkstofffreisetzung während der Rehydratisierung zu vermeiden, wurden die Linsen in ethanolische Arzneistofflösungen beladen, die Diclofenac-Natrium, Dexamethason oder beide Wirkstoffe gleichzeitig enthielten. Die Wirkstoffbeladungen betragen sowohl in einfach beladenen Linsen, als auch in den Linsen, die mit beiden Wirkstoffen beladen waren, jeweils ca. 2%. Nach der Entfernung des Ethanols wurde die Rehydratisierung in gesättigten Wirkstofflösungen durchgeführt, um eine vorzeitige Wirkstofffreisetzung zu vermeiden. Innerhalb von 30 Minuten wurde die Flexibilität der Linsen wiederhergestellt. In einfach beladenen Intraokularlinsen wurde Diclofenac-Natrium schneller freigesetzt ($t_{80\%}$: 72 Stunden) als Dexamethason ($t_{80\%}$: 16 Tage), was auf die höhere Löslichkeit zurückzuführen war. In Linsen, die mit beiden Wirkstoffen beladen wurden, war die Freisetzung des Diclofenacs ähnlich, aber die Dexamethasonfreisetzung war schneller, bedingt durch das Diclofenac. Der zusätzlich eingelagerte hydrophile Wirkstoff erhöhte den osmotischen Druck innerhalb der Linse. Das hatte zur Folge, dass mehr Wasser in die Linse diffundierte und gleichzeitig mehr Dexamethason in der Wasserphase des Hydrogels gelöst vorlag. Dies führte zu einer schnelleren Freisetzung. In den getrockneten arzneistoffbeladenen IOLs wurden in der DSC keine Schmelzpeaks beobachtet. Die Glasübergangstemperatur war jedoch geringer, womit bewiesen werden konnte, dass die Wirkstoffe monomolekular dispers verteilt vorlagen und Eigenschaften eines Weichmachers hatten. Alle Linsen waren während und nach der Arzneimittelfreisetzung transparent.

Eine spezielle Zweikammervorrichtung wurde vorgestellt, um arzneimittelbeladene Intraokularlinsen im trockenen Zustand ausliefern zu können. Die Stabilität der Linsen sollte dadurch verbessert werden. Die getrocknete Linse wurde in der ersten Kammer aufbewahrt, während in der zweiten Kammer das Rehydratisierungs-/Beladungsmedium vorzufinden war. In dem die IOLs von der ersten in die zweite Kammer gegeben wurde, konnte die Rehydratisierung in der gleichen Vorrichtung durchgeführt und Kontaminationen somit effektiv vermieden werden. So könnten hydrophile Linsen im Voraus durch organische Lösungsmittel mit schlecht wasserlöslichen Wirkstoffen beladen werden und Ärzte müssten die Rehydratisierung nur 30 Minuten vor der Operation starten.

Heutzutage sind hydrophobe Acrylate aufgrund ihres hohen Brechungsindex (1.4900 - 1.5500) und der weniger häufigen postoperativen Komplikationen die am häufigsten verwendeten IOL-Materialien. Als hydrophobe Linsen wurden Polymere aus reinem Polymethylmethacrylat (PMMA) und Polyphenoxyethyl acrylat (pPOEA) hergestellt und charakterisiert. Im Gegensatz zu hydrophilen Linsen konnten diese Linsen nicht durch Lagerung in wässrigen Wirkstofflösungen beladen werden, da sie nur einen sehr geringen Wassergehalt in der Linsenmatrix (< 0,5%) aufwiesen. Höhere Wirkstoffbeladungen wurden mit organischen Lösungsmitteln erreicht. Die Wirkstoffe wurden aber nicht zufriedenstellend freigesetzt, was auf die geringe Wirkstoffdiffusion in den Linsenpolymeren zurückzuführen war. Wenn die Polymerzusammensetzungen modifiziert wurden, um die Wirkstoffdiffusion zu verbessern, nahm die optische Qualität der Linsen extrem ab.

Aus diesem Grund wurden externe Systeme untersucht und die Linsen entweder an der seitlichen Oberfläche des optischen Teils oder an der Haptik beschichtet. Es wurden drei unterschiedliche Beschichtungsmuster untersucht. Durch die Beschichtung von nur zwei Bereichen an der lateralen Oberfläche der IOLs konnte die Faltbarkeit von den flexiblen IOLs erhalten werden. Da nur die äußeren Bereiche der Linsen beschichtet wurden, blieben die optischen Teile in der Mitte der Intraokularlinsen unbehandelt und eine 100%-ige Lichtdurchlässigkeit wurde sichergestellt. PLGA als ein biologisch abbaubares Polymer wurde für die Dexamethasonbeschichtungen verwendet und eine Freisetzungskinetik nullter Ordnung für die verschiedenen Wirkstoffbeladungen erfolgreich gewährleistet. Außerdem konnten die beiden Beschichtungsbereiche unterteilt und völlig unabhängig voneinander auf verschiedene Wirkstoffe abgestimmt werden. Daher wurden aufgetragene Beschichtungen in Bezug auf den Wirkstoff, das PLGA, die Arzneimittelbeladung und die Menge der Beschichtung eingestellt, um Freisetzungsprofile mit den gewünschten Charakteristika zu erhalten. Die Freisetzung von Minocyclin als Antibiotikum wurde auf circa eine Woche eingestellt, während Dexamethason als Glucocorticoid über einen Monat gleichmäßig abgegeben wurde. Die Beschichtungsadhäsion an hydrophoben Linsen war gut und nach dem PLGA-Abbau hatten diese Linsen identische Eigenschaften wie die Linsen, die nicht beschichtet waren.

Amphiphile Linsen kombinierten die Vorteile von hydrophilen und hydrophoben Linsen. Während hydrophile Linsen durch Lagerung in Wirkstofflösungen beladen werden konnten, wiesen hydrophobe Linsen einen höheren Brechungsindex auf, die Arzneimittelfreisetzung war verlängert und die Faltbarkeit war auch im trockenen Zustand gegeben. Daher wurden drei verschiedene Linsenpolymere hergestellt, die hydrophile (Hydroxyethyl methacrylat,

Hydroxybutyl methacrylat und Hydroxyethyl acrylat) und hydrophobe (Butyl methacrylat, Ethyl acrylat, Isobutyl methacrylat und Phenoxyethyl acrylat) Monomere in verschiedenen Verhältnissen enthielten. Die Wirkstoffbeladung wurde durch das Einweichen in ethanolischer Dexamethasonlösung durchgeführt und die dadurch erhaltenen Linsen wurden untersucht. Die Freisetzung ($t_{80\%}$: 190 - 240 Tage) war aufgrund des begrenzten Wassergehalts innerhalb der Polymermatrix ($2,03 \pm 0,34\%$ - $4,57 \pm 0,36\%$) und der Wechselwirkungen zwischen Wirkstoff und Polymer stark verlängert. Dexamethason fiel innerhalb einiger Linsenpolymere aus und die Licht-Durchlässigkeit nahm ab. Daher wurde eine Optimierung der Linsenpolymerzusammensetzung durchgeführt und das Verhältnis der Monomere wurde so eingestellt, dass die Arzneimittelbeladung, die Freisetzungsprofile, der Brechungsindex und die Flexibilität der Intraokularlinsen verbessert wurden.

Um eine 100%-ige Lichtdurchlässigkeit für Linsen sicherzustellen, die trübe wurden, wenn Wirkstoffe in die Polymermatrix eingearbeitet waren, wurden die Linsen nur an den Seiten beladen, sodass der Kern der IOL ungeladen blieb. Dafür wurden Polymerstäbe für begrenzte Zeiträume getränkt, sodass das Tränkmedium nur in den äußeren Rand diffundierte. Nach der Verdampfung des Lösemittels wurden die Polymerstäbe geschnitten und die IOLs ausgefräst. Aus diesem Grund konnten in den Freisetzungsstudien perfekte optische Eigenschaften in der Mitte der IOLs garantiert werden, während der äußere Rand der IOLs trüb wurde. Dies war durch den Arzneistoff bedingt, welcher dort innerhalb der Linsen ausfiel. Aufgrund der geringeren Menge an Polymer, die mit Arzneimittel beladen war, nahm die Gesamtbeladung ab. Es wurde jedoch eine verlängerte Arzneimittelfreisetzung gewährleistet. Für potente Arzneimittel (z. B. Dexamethason) sind diese lateralen Wirkstoffbeladungen vielversprechend. Für Linsen, die ihre optischen Eigenschaften unter arzneimittelbeladenen Bedingungen änderten, wurden eine ausreichende Arzneimittelbeladung erzielt und eine 100%-ige Lichtdurchlässigkeit sichergestellt.

Zusammenfassend kann gesagt werden, dass die Intraokularlinsen mit Wirkstoffen beladen und eine verlängerte Wirkstofffreisetzung erreicht werden konnte. Für die verschiedenen Polymere, die für Intraokularlinsen genutzt werden, mussten verschiedene Beladungsmethoden angewendet werden. Während die Wirkstoffe in die Linsenmatrix von hydrophilen und amphiphilen Linsen direkt eingearbeitet werden konnten, mussten hydrophobe Acrylate aufgrund des geringen Wassergehalts externe Freisetzungssysteme erhalten. Grund dafür ist, dass die Wirkstoffe wegen des geringen Wassergehaltes nur unzureichend aus den Polymeren heraus diffundierten. Da wirkstoffbeladene Linsen unter trockenen Bedingungen abgegeben

werden sollten, um die Stabilität zu verbessern und um eine vorzeitige Freisetzung zu vermeiden, wurde eine spezielle Zweikammervorrichtung entwickelt. In diesem Gefäß konnten getrocknete hydrophile IOLs gelagert werden. Die Rehydratisierung war innerhalb von 30 Minuten in einer sterilen Umgebung möglich. Die Faltbarkeit der amphiphilen und hydrophoben Linsen wurde auch für die trockenen Linsen gewährleistet. Die IOLs, die mit zwei Wirkstoffen beladen waren, zeigten die gewünschten simultanen Freisetzungsprofile für beide Arzneistoffe. Damit könnte die häufige Arzneimittelverabreichung nach den Kataraktoperationen vermieden werden.

Daher sind Wirkstofffreisetzende Intraokularlinsen vielversprechende Systeme für die Anwendung am Auge.

5. References

- [1] D.A. Atchison, Optics of the Human Eye, in: B.D. Guenther, D.G.B.T.-E. of M.O. (Second E. Steel (Eds.), Elsevier, Oxford, 2018: pp. 43–63.
- [2] G.S. Banker, C.T. Rhodes, Modern pharmaceuticals, 2002.
- [3] M. Lassaline, Chapter 17 - Disorders of the Eye and Vision, in: S.M. Reed, W.M. Bayly,. (Fourth E. Sellon (Eds.), W.B. Saunders, 2018: pp. 1139–1158.
- [4] R.A. Armstrong, R.P. Cubbidge, The Eye and Vision: An Overview, Elsevier, 2014.
- [5] Y.C. Liu, M. Wilkins, T. Kim, B. Malyugin, J.S. Mehta, Cataracts, *Lancet*. 390 (2017) 600–612.
- [6] R. Olson, Cataract Surgery From 1918 to the Present and Future-Just Imagine!, (2018) 1–4.
- [7] D. Peng, World ' s largest Science , Technology & Medicine Open Access book publisher c, *Agric. Biol. Sci. Grain Legum*. (2016).
- [8] T.R. Thrimawithana, I.D. Rupenthal, S.S. Räscher, J.C. Lim, J.D. Morton, C.R. Bunt, Drug delivery to the lens for the management of cataracts, *Adv. Drug Deliv. Rev.* (2018).
- [9] J.F. Hejtmancik, Ophthalmology: Cataracts dissolved, *Nature*. 523 (2015) 540–541.
- [10] L. Zhao, X.J. Chen, J. Zhu, Y.B. Xi, X. Yang, L.D. Hu, H. Ouyang, S.H. Patel, X. Jin, D. Lin, F. Wu, K. Flagg, H. Cai, G. Li, G. Cao, Y. Lin, D. Chen, C. Wen, C. Chung, Y. Wang, A. Qiu, E. Yeh, W. Wang, X. Hu, S. Grob, R. Abagyan, Z. Su, H.C. Tjondro, X.J. Zhao, H. Luo, R. Hou, J.J. P. Perry, W. Gao, I. Kozak, D. Granet, Y. Li, X. Sun, J. Wang, L. Zhang, Y. Liu, Y. Bin Yan, K. Zhang, Lanosterol reverses protein aggregation in cataracts, *Nature*. 523 (2015) 607–611.
- [11] L.S. Thompson, “The House of Life. Per Ankh. Magic and Medical Science in Ancient Egypt” (Israel) (Book Review), *Kentucky Folk. Rec. /*. 20 (1974) 52 NO-Kentucky folklore record /, 1974, Vol.2.
- [12] D.J. Apple, Evolution of cataract surgery and intraocular lenses (IOLs): IOL quality, *Surv. Ophthalmol.* 45 (2000).
- [13] D.J. Apple, M. Escobar-Gomez, B. Zaugg, G. Kleinmann, A.F. Borkenstein, Modern Cataract Surgery: Unfinished Business and Unanswered Questions, *Surv. Ophthalmol.* 56 (2011) S3–S53.
- [14] E. Savage-Smith, The practice of surgery in Islamic lands: myth and reality., *Soc. Hist. Med.* 13 (2000) 307–321.
- [15] J.N. Perry, R.H. Smith, I.P. Woiwod, D.R. Morse, *Origins of Neuroscience: A History*

- of Explorations into Brain Function, 38 (2001) 536–538.
- [16] B. Jay, REMEMBRANCES OF THINGS PAST Harold Ridley and the Invention of the Intraocular Lens, 40 (1994).
- [17] G. Fuller, I. Bone, Sir Harold Ridley's vision, *Curr. Opin. Neurol.* 74 (2003) 2–3.
- [18] D.J. Apple, Q. Peng, Harold Ridley Knighted, *Ophthalmology.* 107 (2000) 412–413.
- [19] C.D. Kelman, PHACOEMULSIFICATION IN THE ANTERIOR CHAMBER fication appeared in the American, (1980) 1980–1982.
- [20] H. Ridley, Intra-Ocular Acrylic Lenses - A recent development in the surgery of cataract, *Brit. J. Ophthal.* 36 (1952) 113–122.
- [21] M.E. Nordlohne, History of Intraocular Lens Implants, in: *Intraocular Implant Lens Dev. Results with Spec. Ref. to Binkhorst Lens*, Springer, Dordrecht, 2001.
- [22] D.J. Apple, N. Mamalis, K. Loftfield, J.M. Googe, L.C. Novak, D. Kavka-Van Norman, S.E. Brady, R.J. Olson, Complications of intraocular lenses. A historical and histopathological review, *Surv. Ophthalmol.* 29 (1984) 1–54.
- [23] M.C. Kincaid, N. Mamalis, D.J. Apple 1941-2011 (viaf)5496437, *Intraocular lenses : evolution, designs, complications, and pathology*, Baltimore (Md.): Williams and Wilkins, 1989.
- [24] G.U. Auffarth, D.J. Apple, Zur entwicklungsgeschichte der intraokularlinsen, *Ophthalmologie.* 98 (2001) 1017–1028.
- [25] F.T. Ellingson, Complications with the choyce mark VIII anterior chamber lens implant (uveitis-glaucoma-hyphema), *Am. Intra-Ocular Implant Soc. J.* 3 (1977) 199–201.
- [26] C.-L. Lin, A.-G. Wang, J.C.K. Chou, G. Shieh, J.-H. Liu, Heparin-surface-modified intraocular lens implantation in patients with glaucoma, diabetes, or uveitis, *J. Cataract Refract. Surg.* 20 (1994) 550–553.
- [27] S. Umezawa, K. Shimizu, Biocompatibility of surface-modified intraocular lenses, *J. Cataract Refract. Surg.* 19 (1993) 371–374.
- [28] L. Allarakhia, R.L. Knoll, R.L. Lindstrom, Soft intraocular lenses, *J. Cataract Refract. Surg.* 13 (1987) 607–620.
- [29] J. Caprioli MD, Soft Implant Lenses, *Ophthalmic Surg. /.* 17 (1986) 760 NO-Ophthalmic surgery /, 1986, Vol.17(11).
- [30] D. Lam, S.K. Rao, V. Ratra, Y. Liu, P. Mitchell, J. King, M.-J. Tassignon, J. Jonas, C.P. Pang, D.F. Chang, *Cataract*, *Nat. Rev. Dis. Prim.* 1 (2015) 15014.
- [31] S. Rowen, Preoperative and postoperative medications used for cataract surgery., *Curr. Opin. Ophthalmol.* 10 (1999) 29–35.

- [32] L. Kessel, B. Tendal, K.J. Jorgensen, D. Erngaard, P. Flesner, J.L. Andresen, J. Hjortdal, Post-cataract prevention of inflammation and macular edema by steroid and nonsteroidal anti-inflammatory eye drops: a systematic review., *Ophthalmology*. 121 (2014) 1915–1924.
- [33] R. Bellucci, An introduction to intraocular lenses: Material, optics, haptics, design and aberration, *Cataract*. 3 (2013) 38–55.
- [34] Q. Huang, G.-M. Cheng, K. Chiu, G.-Q. Wang, Surface Modification of Intraocular Lenses, *Chin. Med. J. (Engl)*. 129 (2016) 206.
- [35] M. Tetz, M.R. Jorgensen, New Hydrophobic IOL Materials and Understanding the Science of Glistenings, *Curr. Eye Res*. 40 (2015) 969–981.
- [36] L. Werner, M. Tetz, I. Feldmann, M. Bückler, Evaluating and defining the sharpness of intraocular lenses: Microedge structure of commercially available square-edged hydrophilic intraocular lenses, *J. Cataract Refract. Surg*. 35 (2009) 556–566.
- [37] O. Findl, W. Buehl, R. Menapace, S. Sacu, M. Georgopoulos, G. Rainer, Long-term Effect of Sharp Optic Edges of a Polymethyl Methacrylate Intraocular Lens on Posterior Capsule Opacification: A Randomized Trial, *Ophthalmology*. 112 (2005) 2004–2008.
- [38] O. Nishi, K. Nishi, K. Wickström, Preventing lens epithelial cell migration using intraocular lenses with sharp rectangular edges, *J. Cataract Refract. Surg*. 26 (2000) 1543–1549.
- [39] A. Shah, D.J. Spalton, C. Gilbert, A. Vasavada, J.F. Boyce, D. Minassian, H. Jayaram, D. Mabey, Effect of intraocular lens edge profile on posterior capsule opacification after extracapsular cataract surgery in a developing country, *J. Cataract Refract. Surg*. 33 (2007) 1259–1266.
- [40] D. Leaming, Practice styles and preferences of ASCRSmembers--2003 survey., *J. Cataract Refract Surg*. 30 (2004) 892–900.
- [41] A. Trinavarat, L. Atchaneeyasakul, S. Udompunturak, Neodymium:YAG laser damage threshold of foldable intraocular lenses, *J. Cataract Refract. Surg*. 27 (2001) 775–780.
- [42] B.E. Thomes, T.A. Callaghan, Re: Glistenings in hydrophobic acrylic intraocular lenses do affect visual function, *Clin. Ophthalmol*. 7 (2013) 2273–2274.
- [43] L. Xi, Y. Liu, F. Zhao, C. Chen, B. Cheng, Analysis of glistenings in hydrophobic acrylic intraocular lenses on visual performance., *Int. J. Ophthalmol*. 7 (2014) 446–451.
- [44] M. van der Mooren, L. Franssen, P. Piers, Effects of glistenings in intraocular lenses, *Biomed. Opt. Express*. 4 (2013) 1294.
- [45] O. Findl, Intraocular Lens Materials and Design, *Achiev. Excell. Cataract Surg*. (2009)

- 95–108.
- [46] S.M. Raj, A.R. Vasavada, S.R.K. Johar, V.A. Vasavada, V.A. Vasavada, Post-operative capsular opacification: a review., *Int. J. Biomed. Sci.* 3 (2007) 237–50.
- [47] A. Jorge Pde, D. Jorge, C. V Ventura, B. V Ventura, W. Lira, M.C. Ventura, M.R. Santhiago, N. Kara-Junior, Incidence of posterior capsule opacification following the implantation of a foldable hydrophilic acrylic intraocular lens: a 4 year follow-up study, *Arq Bras Oftalmol.* 77 (2014) 222–224.
- [48] A.M. Izak, L. Werner, S.K. Pandey, D.J. Apple, Calcification of modern foldable hydrogel intraocular lens designs, *Eye.* 17 (2003) 393–406.
- [49] L. Werner, Calcification of Hydrophilic Acrylic Intraocular Lenses, *Am. J. Ophthalmol.* 146 (2008) 341–343.
- [50] S.P. Gartaganis, D.G. Kanellopoulou, E.K. Mela, V.S. Panteli, P.G. Koutsoukos, Opacification of Hydrophilic Acrylic Intraocular Lens Attributable to Calcification: Investigation on Mechanism, *Am. J. Ophthalmol.* 146 (2008).
- [51] Z.M. Bodnar, P. Rozot, L. Leishman, A. Ollerton, J. Michelson, S. Plasse-Fauque, L. Werner, Calcification of a hydrophilic acrylic intraocular lens: Case report with laboratory analysis, *J. Fr. Ophtalmol.* 36 (2013) e113–e117.
- [52] W. Buehl, R. Menapace, S. Sacu, K. Kriechbaum, C. Koepl, M. Wirtitsch, M. Georgopoulos, O. Findl, Effect of a silicone intraocular lens with a sharp posterior optic edge on posterior capsule opacification, *J. Cataract Refract. Surg.* 30 (2004) 1661–1667.
- [53] M. Tehrani, H.B. Dick, B. Wolters, T. Pakula, E. Wolf, Material properties of various intraocular lenses in an experimental study, *Ophthalmologica.* 218 (2004) 57–63.
- [54] P. Sternberg, D.L. Hatchell, G.N. Foulks, M.B. Landers, The Effect of Silicone Oil on the Cornea, *Arch. Ophthalmol.* 103 (1985) 90–94.
- [55] J.L. Federman, H.D. Schubert, Complications Associated with the Use of Silicone Oil in 150 Eyes after Retina-vitreous Surgery, *Ophthalmology.* 95 (1988) 870–876.
- [56] Benz Research & Development, Intraocular Lens Materials & Manufacturing Technology 2013, (2013). http://benzrd.com/Uploads/2013_benz_manual.pdf.
- [57] M.A. Galin, L. Turkish, E. Chowchuvech, Detection, removal, and effect of unpolymerized methylmethacrylate in intraocular lenses, *Am. J. Ophthalmol.* 84 (1977) 153–159.
- [58] E. Caló, V. V. Khutoryanskiy, Biomedical applications of hydrogels: A review of patents and commercial products, *Eur. Polym. J.* 65 (2015) 252–267.
- [59] I.J.D. Mckay, W. Jordan, United States Patent 191 : US . Patent, (1988) 0–6.

- [60] F. Parra, B. Vázquez, L. Benito, J. Barcenilla, J. San Román, Foldable Antibacterial Acrylic Intraocular Lenses of High Refractive Index, *Biomacromolecules*. 10 (2009) 3055–3061.
- [61] F.J. Primus, M.D. Goldenberg, S. Hills, United States Patent (19), (1991).
- [62] A.W. Lloyd, R.G.A. Faragher, S.P. Denyer, Ocular biomaterials and implants, *Biomaterials*. 22 (2001) 769–785.
- [63] V. Sankar, T.S. Kumar, K.P. Rao, Preparation, characterisation and fabrication of intraocular lens from photo initiated polymerised Poly (methyl metacrylate), *Trends Biomater. Artif. Organs*. 17 (2004) 24–30.
- [64] I.G.E. Gore, N. Branch, T. Roman, E. Orange, K. Wayne, R.A. Gore, United States Patent (19), (1998) 1–5.
- [65] T.T. Shen, B.D. Ratner, Sustained release of antibiotic from poly(2-hydroxyethyl methacrylate) to prevent blinding infections after cataract surgery, 30 (2010) 1–15.
- [66] R. Liegl, C. Wertheimer, M. Kernt, D. Docheva, A. Kampik, K.H. Eibl-Lindner, Attenuation of human lens epithelial cell spreading, migration and contraction via downregulation of the PI3K/Akt pathway, *Graefe's Arch. Clin. Exp. Ophthalmol*. 252 (2014) 285–292.
- [67] C.J. Heatley, D.J. Spalton, A. Kumar, R. Jose, J. Boyce, L.E. Bender, Comparison of posterior capsule opacification rates between hydrophilic and hydrophobic single-piece acrylic intraocular lenses, *J. Cataract Refract. Surg*. 31 (2005) 718–724.
- [68] et al. Hollick EJ, Spalton DJ, Ursell PG, The effect of PMMA, silicone and polyacrylic lenses on posterior capsule opacification 3 years after surgery., *Ophthalmology*. 106 (1998) 49–54.
- [69] P.G. Ursell, D.J. Spalton, M. V. Pande, E.J. Hollick, S. Barman, J. Boyce, K. Tilling, Relationship between intraocular lens biomaterials and posterior capsule opacification, *J. Cataract Refract. Surg*. 24 (1998) 352–360.
- [70] E.J. Hollick, D.J. Spalton, P.G. Ursell, M. V Pande, Lens epithelial cell regression on the posterior capsule with different intraocular lens materials, *Br. J. Ophthalmol*. 82 (1998) 1182–1188.
- [71] J.C. Erie, M.H. Bandhauer, J.W. McLaren, Analysis of postoperative glare and intraocular lens design, *J. Cataract Refract. Surg*. 27 (2001) 614–621.
- [72] J.T. Holladay, A. Lang, V. Portney, Analysis of edge glare phenomena in intraocular lens edge designs¹¹Alan Lang, PhD, is an employee of Allergan. None of the other authors has a financial interest in any product or device mentioned., *J. Cataract Refract.*

- Surg. 25 (1999) 748–752.
- [73] S. Day, Post-Op Instructions for Cataract Surgery Medications (Eye Drops): Your Activities : The Normal Healing Process : Problems : Your post-operative visit is scheduled for.
- [74] B.R. LaHood, N.H. Andrew, M. Goggin, Antibiotic prophylaxis in cataract surgery in the setting of penicillin allergy: A decision-making algorithm, *Surv. Ophthalmol.* 62 (2017) 659–669.
- [75] R.M. Brown, C.W. Roberts, Preoperative and postoperative use of nonsteroidal anti inflammatory drugs in cataract surgery, *Insight - J. Am. Soc. Ophthalmic Regist. Nurses.* 21 (1996) 13–16.
- [76] M. D, Post-operative instructions for cataract patients.
- [77] C. Cunningham, J. Widder, V. Raiji, Endophthalmitis, *Disease-a-Month.* 63 (2017) 45–48.
- [78] J.H. Assam, A. Bernhisel, A. Lin, Intraoperative and postoperative pain in cataract surgery, *Surv. Ophthalmol.* 63 (2018) 75–85.
- [79] R. Gaudana, H.K. Ananthula, A. Parenky, A.K. Mitra, Ocular Drug Delivery, *AAPS J.* 12 (2010) 348–360.
- [80] D. Huang, Y.S. Chen, I.D. Rupenthal, Overcoming ocular drug delivery barriers through the use of physical forces, *Adv. Drug Deliv. Rev.* (2017).
- [81] S.S. Bhujbal, K.K. Wale, N.B. Mahale, A.D. Landage, S.F. Sayyed, S.R. Chaudhari, Ocular Drug Delivery System : a Review, 3 (2014) 320–343.
- [82] D.M. Wallace, J.E. Murphy-Ullrich, J.C. Downs, C.J. O’Brien, The role of extracellular matrix proteins in glaucoma, *Matrix Biol.* 37 (2014) 174–182.
- [83] H. Steuer, A. Jaworski, B. Elger, M. Kaussmann, J. Keldenich, H. Schneider, D. Stoll, B. Schloschauer, Functional characterization and comparison of the outer blood-retina barrier and the blood-brain barrier, *Investig. Ophthalmol. Vis. Sci.* 46 (2005) 1047–1053.
- [84] E.A. Runkle, D.A. Antonetti, The Blood-Retinal Barrier: Structure and Functional Significance, in: S. Nag (Ed.), *Blood-Brain Other Neural Barriers Rev. Protoc.*, Humana Press, Totowa, NJ, 2011: pp. 133–148.
- [85] M.J. Cima, H. Lee, K. Daniel, L.M. Tanenbaum, A. Mantzavinou, K.C. Spencer, Q. Ong, J.C. Sy, J. Santini, C.M. Schoellhammer, D. Blankschtein, R.S. Langer, Single compartment drug delivery, *J. Control. Release.* 190 (2014) 157–171.
- [86] M. Hornof, E. Toropainen, A. Urtti, Cell culture models of the ocular barriers, *Eur. J. Pharm. Biopharm.* 60 (2005) 207–225.

- [87] C.M. Eandi, C. Alovisei, U. De Sanctis, F.M. Grignolo, Treatment for neovascular age related macular degeneration: The state of the art, *Eur. J. Pharmacol.* 787 (2016) 78–83.
- [88] I.D. Rupenthal, Drug-device combination approaches for delivery to the eye, *Curr. Opin. Pharmacol.* 36 (2017) 44–51.
- [89] C.M. Christoforidis, John B; Chang, Susie; Jiang, Angela; Wang, Jillian; Cebulla, Intravitreal Devices for the Treatment of Vitreous Inflammation, *Mediators Inflamm.* 2012 (2012) 8.
- [90] A. Agent, F.D.- Gil, United States Patent [19], 61 (1996) 985–986.
- [91] S.L. Fialho, F. Behar-Cohen, A. Silva-Cunha, Dexamethasone-loaded poly(ϵ -caprolactone) intravitreal implants: A pilot study, *Eur. J. Pharm. Biopharm.* 68 (2008) 637–646.
- [92] M.N. Yasin, D. Svirskis, A. Seyfoddin, I.D. Rupenthal, Implants for drug delivery to the posterior segment of the eye: A focus on stimuli-responsive and tunable release systems, *J. Control. Release.* 196 (2014) 208–221.
- [93] J.L. Bourges, C. Bloquel, A. Thomas, F. Froussart, A. Bochot, F. Azan, R. Gurny, D. BenEzra, F. Behar-Cohen, Intraocular implants for extended drug delivery: Therapeutic applications, *Adv. Drug Deliv. Rev.* 58 (2006) 1182–1202.
- [94] S.S. Lee, P. Hughes, A.D. Ross, M.R. Robinson, Biodegradable implants for sustained drug release in the eye, *Pharm. Res.* 27 (2010) 2043–2053.
- [95] S. Eperon, L. Bossy-Nobs, I.K. Petropoulos, R. Gurny, Y. Guex-Crosier, A biodegradable drug delivery system for the treatment of postoperative inflammation, *Int. J. Pharm.* 352 (2008) 240–247.
- [96] J.I. Vela, J. Crespi, D. Andreu, Repositioning of dexamethasone intravitreal implant (Ozurdex®) migrated into the anterior chamber, *Int. Ophthalmol.* 32 (2012) 583–584.
- [97] D. Pardo-López, E. Francés-Muñoz, R. Gallego-Pinazo, M. Díaz-Llopis, Anterior chamber migration of dexametasone intravitreal implant (Ozurdex®), *Graefe's Arch. Clin. Exp. Ophthalmol.* 250 (2012) 1703–1704.
- [98] J. Coca-Robinot, B. Casco-Silva, F. Armadá-Maresca, J. García-Martínez, Accidental Injections of Dexamethasone Intravitreal Implant (Ozurdex®) into the Crystalline Lens, *Eur. J. Ophthalmol.* 24 (2014) 633–636.
- [99] M. Cordero-Coma, I. Garzo, S. Calleja, E. Galán, M. Franco, J.G. Ruíz De Morales, Preoperative cataract surgery use of an intravitreal dexamethasone implant (Ozurdex) in a patient with juvenile idiopathic arthritis and chronic anterior uveitis, *J. AAPOS.* 17 (2013) 632–634.

- [100] M.F. Saettone, L. Salminen, Ocular inserts for topical delivery, *Adv. Drug Deliv. Rev.* 16 (1995) 95–106.
- [101] J.E. Key, Development of contact lenses and their worldwide use, *Eye Contact Lens.* 33 (2007) 343–345.
- [102] L. Xinming, C. Yingde, A.W. Lloyd, S. V. Mikhalovsky, S.R. Sandeman, C.A. Howel, L. Liewen, Polymeric hydrogels for novel contact lens-based ophthalmic drug delivery systems: A review, *Contact Lens Anterior Eye.* 31 (2008) 57–64.
- [103] S. Gause, K.H. Hsu, C. Shafor, P. Dixon, K.C. Powell, A. Chauhan, Mechanistic modeling of ophthalmic drug delivery to the anterior chamber by eye drops and contact lenses, *Adv. Colloid Interface Sci.* 233 (2016) 139–154.
- [104] I.M. Carvalho, C.S. Marques, R.S. Oliveira, P.B. Coelho, P.C. Costa, D.C. Ferreira, Sustained drug release by contact lenses for glaucoma treatment - A review, *J. Control. Release.* 202 (2015) 76–82.
- [105] F.A. Maulvi, T.G. Soni, D.O. Shah, A review on therapeutic contact lenses for ocular drug delivery, *Drug Deliv.* 23 (2016) 3017–3026.
- [106] L.C. Bengani, A. Chauhan, Extended delivery of an anionic drug by contact lens loaded with a cationic surfactant, *Biomaterials.* 34 (2013) 2814–2821.
- [107] V.P. Costa, M.E.M. Braga, C.M.M. Duarte, C. Alvarez-Lorenzo, A. Concheiro, M.H. Gil, H.C. de Sousa, Anti-glaucoma drug-loaded contact lenses prepared using supercritical solvent impregnation, *J. Supercrit. Fluids.* 53 (2010) 165–173.
- [108] K.H. Hsu, B.E. Carbia, C. Plummer, A. Chauhan, Dual drug delivery from vitamin e loaded contact lenses for glaucoma therapy, *Eur. J. Pharm. Biopharm.* 94 (2015) 312–321.
- [109] Y. Yokozaki, J. Sakabe, Y. Shimoyama, Enhanced impregnation of hydrogel contact lenses with salicylic acid by addition of water in supercritical carbon dioxide, *Chem. Eng. Res. Des.* 104 (2015) 203–207.
- [110] J.B. Ciolino, T.R. Hoare, N.G. Iwata, I. Behlau, C.H. Dohlman, R. Langer, D.S. Kohane, A drug-eluting contact lens, *Investig. Ophthalmol. Vis. Sci.* 50 (2009) 3346–3352.
- [111] C. González-Chomón, A. Concheiro, C. Alvarez-Lorenzo, Drug-eluting intraocular lenses, *Materials (Basel).* 4 (2011) 1927–1940.
- [112] T. N., Vehicle effects on ophthalmic bioavailability: the influence of different polymers on the activity of pilocarpine in rabbit and man, *J. Pharm. Pharmacol.* 34 (2018) 464–466.
- [113] M.A. Watsky, M.M. Jablonski, H.F. Edelhauser, Comparison of conjunctival and corneal

- surface areas in rabbit and human, *Curr. Eye Res.* 7 (1988) 483–486.
- [114] D. Maurice, The Effect of the Low Blink Rate in Rabbits on Topical Drug Penetration, 1995.
- [115] Y.C. Liu, T.T. Wong, J.S. Mehta, Intraocular lens as a drug delivery reservoir, *Curr. Opin. Ophthalmol.* 24 (2013) 53–59.
- [116] P. Chollet, F. Malecaze, P.L. Le Toan, H. Lamche, J.L. Arné, Annexin V—coated intraocular lenses, *J. Cataract Refract. Surg.* 22 (1996) 818–824.
- [117] S. Garty, R. Shirakawa, A. Warsen, E.M. Anderson, M.L. Noble, J.D. Bryers, B.D. Ratner, T.T. Shen, Sustained antibiotic release from an intraocular lens-hydrogel assembly for cataract surgery, *Investig. Ophthalmol. Vis. Sci.* 52 (2011) 6109–6116.
- [118] G. Kleinmann, D.J. Apple, J. Chew, B. Hunter, S. Stevens, S. Larson, N. Mamalis, R.J. Olson, Hydrophilic acrylic intraocular lens as a drug-delivery system for fourth-generation fluoroquinolones, *J. Cataract Refract. Surg.* 32 (2006) 1717–1721.
- [119] G. Kleinmann, D.J. Apple, J. Chew, S. Stevens, B. Hunter, S. Larson, N. Mamalis, R.J. Olson, Hydrophilic acrylic intraocular lens as a drug-delivery system: Pilot study, *J. Cataract Refract. Surg.* 32 (2006) 652–654.
- [120] X. Li, Y. Zhao, K. Wang, L. Wang, X. Yang, S. Zhu, Cyclodextrin-containing hydrogels as an intraocular lens for sustained drug release, *PLoS One.* 12 (2017) 1–19.
- [121] H. Liu, L. Wu, S. Fu, Y. Hou, P. Liu, H. Cui, J. Liu, L. Xing, X. Zhang, Polylactide-glycolic acid and rapamycin coating intraocular lens prevent posterior capsular opacification in rabbit eyes, *Graefe's Arch. Clin. Exp. Ophthalmol.* 247 (2009) 801–807.
- [122] O. Nishi, K. Nishi, Y. Yamada, Y. Mizumoto, Effect of indomethacin-coated posterior chamber intraocular lenses on postoperative inflammation and posterior capsule opacification, *J. Cataract Refract. Surg.* 21 (1995) 574–578.
- [123] R.C. Siqueira, E. Ribeiro Filho, S.L. Fialho, L.R. Lucena, A. Maia Filho, A. Haddad, R. Jorge, I.U. Scott, A. Da Silva Cunha, Pharmacokinetic and toxicity investigations of a new intraocular lens with a dexamethasone drug delivery system: A pilot study, *Ophthalmologica.* 220 (2006) 338–342.
- [124] M.R. Tetz, M.W. Ries, C. Lucas, H. Stricker, H.E. Volcker, Inhibition of posterior capsule opacification by an intraocular-lens- bound sustained drug delivery system: An experimental animal study and literature review, *J. Cataract Refract. Surg.* 22 (1996) 1070–1078.
- [125] Z. Ghalanbor, M. Körber, R. Bodmeier, Protein release from poly(lactide-co-glycolide) implants prepared by hot-melt extrusion: Thioester formation as a reason for incomplete

- release, *Int. J. Pharm.* 438 (2012) 302–306.
- [126] H.K. Kuo, Y.H. Chen, P.C. Wu, Y.H. Kuo, The effects of Ozurdex® (dexamethasone intravitreal implant) on experimental proliferative vitreoretinopathy, *Ophthalmologica*. 233 (2015) 198–203.
- [127] R. Bhagat, J. Zhang, S. Farooq, X.-Y. Li, Comparison of the Release Profile and Pharmacokinetics of Intact and Fragmented Dexamethasone Intravitreal Implants in Rabbit Eyes, *J. Ocul. Pharmacol. Ther.* 30 (2014) 854–858.
- [128] U.D. Bret, N.S. Lakshmi, C.T. Laurencin, Biomedical Applications of Biodegradable Polymers, *J. Polym. Sci. Part B Polym. Phys.* 3 (2011) 832–864.
- [129] S. Fredenberg, M. Wahlgren, M. Reslow, A. Axelsson, The mechanisms of drug release in poly(lactic-co-glycolic acid)-based drug delivery systems - A review, *Int. J. Pharm.* 415 (2011) 34–52.
- [130] P. Gentile, V. Chiono, I. Carmagnola, P. V. Hatton, An overview of poly(lactic-co-glycolic) Acid (PLGA)-based biomaterials for bone tissue engineering, *Int. J. Mol. Sci.* 15 (2014) 3640–3659.
- [131] I. Vroman, L. Tighzert, Biodegradable Polymers, *Materials (Basel)*. 2 307–344. <http://www.mdpi.com/1996-1944/2/2/307>.
- [132] H. Kimura, Y. Ogura, Biodegradable Polymers for, 4678601 (2001) 143–155.
- [133] N. Kamaly, B. Yameen, J. Wu, O.C. Farokhzad, Degradable controlled-release polymers and polymeric nanoparticles: Mechanisms of controlling drug release, *Chem. Rev.* 116 (2016) 2602–2663.
- [134] C.S. Nickerson, J. Park, J.A. Kornfield, H. Karageozian, Rheological properties of the vitreous and the role of hyaluronic acid, *J. Biomech.* 41 (2008) 1840–1846.
- [135] C. Alvarez-Lorenzo, F. Yañez, R. Barreiro-Iglesias, A. Concheiro, Imprinted soft contact lenses as norfloxacin delivery systems, *J. Control. Release.* 113 (2006) 236–244.
- [136] N. Malakooti, C. Alexander, C. Alvarez-Lorenzo, Imprinted Contact Lenses for Sustained Release of Polymyxin B and Related Antimicrobial Peptides, *J. Pharm. Sci.* 104 (2015) 3386–3394.
- [137] E.F. Smith, A.R. Elbash, A. Schrier, P.D. Berg, I. Eid, Antimicrobial Activity of Acrylic Intraocular Lenses Soaked in Fourth Generation Fluoroquinolones, *J. Ocul. Pharmacol. Ther.* 24 (2008) 495–500.
- [138] C. González-Chomón, M.E.M. Braga, H.C. De Sousa, A. Concheiro, C. Alvarez-Lorenzo, Antifouling foldable acrylic IOLs loaded with norfloxacin by aqueous soaking and by supercritical carbon dioxide technology, *Eur. J. Pharm. Biopharm.* 82 (2012)

- 383–391.
- [139] J. Shaw, E.F. Smith, R.U. Desai, B. Enriquez, A. Schrier, Can intraocular lenses deliver antibiotics intracamerally?, *J. Ocul. Pharmacol. Ther.* 26 (2010) 587–9.
- [140] J.L. Davis, N.Y. Yi, J.H. Salmon, A.N. Charlton, C.M.H. Colitz, B.C. Gilger, Sustained-Release Celecoxib from Incubated Acrylic Intraocular Lenses Suppresses Lens Epithelial Cell Growth in an *Ex Vivo* Model of Posterior Capsule Opacity, *J. Ocul. Pharmacol. Ther.* 28 (2012) 359–368.
- [141] Y.T.Y. Wu, M. Willcox, H. Zhu, F. Stapleton, Contact lens hygiene compliance and lens case contamination: A review, *Contact Lens Anterior Eye.* 38 (2015) 307–316.
- [142] E.M. Ahmed, Hydrogel: Preparation, characterization, and applications: A review, *J. Adv. Res.* 6 (2015) 105–121.
- [143] S. Amin, S. Rajabnezhad, K. Kohli, Hydrogels as potential drug delivery systems, *Sci. Res. Essay.* 3 (2009) 1175–1183. <http://www.academicjournals.org/SRE>.
- [144] S. Simões, Modular Hydrogels for Drug Delivery, *J. Biomater. Nanobiotechnol.* 03 (2012) 185–199.
- [145] H. Chavda, C. Patel, Effect of crosslinker concentration on characteristics of superporous hydrogel, *Int. J. Pharm. Investig.* 1 (2011) 17.
- [146] M. Hamidi, A. Azadi, P. Rafiei, Hydrogel nanoparticles in drug delivery, *Adv. Drug Deliv. Rev.* 60 (2008) 1638–1649.
- [147] J.V.M. Weaver, I. Bannister, K.L. Robinson, X. Bories-Azeau, S.P. Armes, M. Smallridge, P. McKenna, Stimulus-Responsive Water-Soluble Polymers Based on 2-Hydroxyethyl Methacrylate, *Macromolecules.* 37 (2004) 2395–2403.
- [148] C.C. Peng, M.T. Burke, B.E. Carbia, C. Plummer, A. Chauhan, Extended drug delivery by contact lenses for glaucoma therapy, *J. Control. Release.* 162 (2012) 152–158.
- [149] J. Kim, A. Conway, A. Chauhan, Extended delivery of ophthalmic drugs by silicone hydrogel contact lenses, *Biomaterials.* 29 (2008) 2259–2269.
- [150] P. Paradiso, A.P. Serro, B. Saramago, R. Colaço, A. Chauhan, Controlled Release of Antibiotics from Vitamin E-Loaded Silicone-Hydrogel Contact Lenses, *J. Pharm. Sci.* 105 (2016) 1164–1172.
- [151] M. Kugelberg, K. Shafiei, I. Van Der Ploeg, C. Zetterström, Intraocular lens as a drug delivery system for dexamethasone, *Acta Ophthalmol.* 88 (2010) 241–244.
- [152] B.C. Giers, T. Tandogan, G.U. Auffarth, C.Y. Choi, F.N. Auerbach, S. Sel, C. Mayer, R. Khoramnia, Hydrophilic intraocular lens opacification after posterior lamellar keratoplasty - A material analysis with special reference to optical quality assessment,

- BMC Ophthalmol. 17 (2017) 1–10.
- [153] Y. Masmoudi, L. Ben Azzouk, O. Forzano, J.M. Andre, E. Badens, Supercritical impregnation of intraocular lenses, *J. Supercrit. Fluids*. 60 (2011) 98–105.
- [154] A. Bouledjoudja, Y. Masmoudi, M. Sergent, V. Trivedi, A. Meniai, E. Badens, Drug loading of foldable commercial intraocular lenses using supercritical impregnation, *Int. J. Pharm.* 500 (2016) 85–99.
- [155] P. Özyol, E. Özyol, F. Karel, Biocompatibility of intraocular lenses, *Türk Oftalmoloji Derg.* 47 (2017) 221–225.
- [156] M. Roesel, C. Heinz, B. Heimes, J.M. Koch, A. Heiligenhaus, Uveal and capsular biocompatibility of two foldable acrylic intraocular lenses in patients with endogenous uveitis - A prospective randomized study, *Graefe's Arch. Clin. Exp. Ophthalmol.* 246 (2008) 1609–1615.
- [157] S. Maedel, N. Hirschall, Y.-A. Chen, O. Findl, Effect of heparin coating of a foldable intraocular lens on inflammation and capsular bag performance after cataract surgery, *J. Cataract Refract. Surg.* 39 (2013) 1810–1817.
- [158] R.C. Smith, *Toward a Drug Delivery Coating for Intraocular*, (2010). <http://hdl.handle.net/1721.1/58399>.
- [159] D.W.N. Tan, S.G. Lim, T.T. Wong, S.S. Venkatraman, Sustained antibiotic-eluting intraocular lenses: A new approach, *PLoS One*. 11 (2016) 1–14.
- [160] S. Corporation, (12) Patent Application Publication (10) Pub . No . : US 2006 / 0283920 A1, 1 (2006).
<https://patents.google.com/patent/US20150209274?q=US+2015%2F0209274+A1>.
- [161] Subramanian Venkatraman, Drug eluting member, A method of attaching the same and a method of fabricating the same, A device for holding the same and a drug eluting device, 2015.
- [162] T. Ojio, Aich, Material für weiche intraokulare Linsen.
- [163] M. Le roux, Flexible IOL made of hydrophilic acrylic Material., (1997) 6.
- [164] G. Koßmehl, N. Klaus, H. Schäfer, [Synthesis and properties of poly (hydroxyethyl methacrylate) hydrogel for IOL materials]. *PubMed Commons*, 24 (1984) 17713269.
- [165] A.S. Patel, *Intraocular Lens Implants: A Scientific Perspective*, Third Edit, Elsevier, 2013.
- [166] J. Pardeike, R. Müller, HET-CAM Test, *Mod. Pharm. Technol.* (2009) 91–93.
- [167] M. Intraoular, L. Frequency, Häufigkeit , Ursachen und Verlauf von Explantationen multifokaler Intraokularlinsen,.

- [168] L. Werner, Glistenings and Surface Light Scattering in Intraocular Lenses, *J. Cataract Refract. Surg.* 36 (2010) 1398–1420.
- [169] M. Rønbeck, A. Behndig, M. Taube, A. Koivula, M. Kugelberg, Comparison of glistenings in intraocular lenses with three different materials: 12-year follow-up, *Acta Ophthalmol.* 91 (2013) 66–70.
- [170] Alcon (Novartis), Glistenings in Modern IOL Materials, Alcon (Novartis). 12 (2012) 1–8.
- [171] M. Blanda, C.A. Us, P. Alto, C.A. Us, D. Chou, United States Patent (45) Date of Patent :, 2 (2011).
- [172] P.P. Data, P. Examiner, C. Upton, (12) United States Patent (10) Patent No .: (58) Field of Classification, 2 (2006) 8–11.
- [173] R. Bhagat, C.A. Us, M. Blanda, C.A. Us, C.A. Us, D. Chou, P. Alto, C.A. Us, A. Weber, C.A. Us, P. No, G.D.D. Condino, (12) United States Patent, 2 (2015).
- [174] N.S. Abdelwahab, B.A. El-Zeiny, S.I. Tohamy, Two spectrophotometric methods for simultaneous determination of some antihyperlipidemic drugs, *J. Pharm. Anal.* 2 (2012) 279–284.
- [175] R. Stevens, V. Gray, A. Dorantes, L. Gold, L. Pham, Scientific and Regulatory Standards for Assessing Product Performance Using the Similarity Factor, f2, 2015.
- [176] S. Zhai, T. Mathew, Y. Huang, Comparison of drug dissolution profiles: a proposal based on tolerance limits, *Stat. Med.* 35 (2016) 5464–5476.
- [177] J. Siepmann, F. Siepmann, Modeling of diffusion controlled drug delivery, *J. Control. Release.* 161 (2012) 351–362.
- [178] T.J. Tulig, M. Tirrell, Toward a Molecular Theory of the Trommsdorff Effect, *Macromolecules.* 14 (1981) 1501–1511.
- [179] C. Frank, Chemical Engineering 160 / 260 Polymer Science and Engineering Lecture 13 - Polymerization Techniques - Dispersed Systems, (2001).
- [180] E. Saldívar-Guerra, E. Vivaldo-lima, HANDBOOK OF POLYMER Edited by, 2013.
- [181] A.M. North, G.A. Reed, Diffusion-controlled termination during the initial stages of free radical polymerization of methyl methacrylate, *Trans. Faraday Soc.* 57 (1961) 859.
- [182] D. Tripti, R.S. Haldar, S. Geetha, U.K. Niyogi, R.K. Khandal, Materials for intraocular lenses (IOLs): Review of developments to achieve biocompatibility, *E-Polymers.* (2009) 1–23.
- [183] J.M. Chapman, L. Cheeks, K. Green, Drug interaction with intraocular lenses of different materials, *J. Cataract Refract. Surg.* 18 (1992) 456–459.

- [184] M. Heck, R. Bodmeier, Improved Drug Loading and Release from HEMA / MMA Intraocular Lenses,.
- [185] H. Bernd, H. Eitle, MATERIAL FÜR OPHTHALMISCHE LINSEN UND VERFAHREN ZU DEREN HERSTELLUNG., EP 0 790 520 A1, 1996.
- [186] T. Ojio, K. Niwa, T. Kawaguchi, Soft intraocular lens material, (1999).
- [187] K. Niwa, Material for soft intraocular Lenses. 99102999.2, 1999.
- [188] O. Tatsuya, Material für weiche intraokulare Linsen I., DE 698 13 115 T 2, 2003.
- [189] A.E. Akinay, W.R. Laredo, Hydrophobic acrylic intraocular lens materials, US 2012/0309899 A1, 2012. <http://www.google.com/patents/US20120309899>.
- [190] P. Enzymes, United States Patent (19) 54, 96 (1973) 62–66.
- [191] F. Charles, D. Forth Worth, MATERIAL FÜR OPHTHALMISCHE LINSEN MIT HOHEM BRECHUNGSINDEX III., DE 696 25 161 T2, 1995.
- [192] T.W. Cheng, H. Keskkula, D.R. Paul, Property and morphology relationships for ternary blends of polycarbonate, brittle polymers and an impact modifier, *Polymer (Guildf)*. 33 (1992) 1606–1619.
- [193] A.E. Polymers, Methacrylic Polymers, (2006) 1–8.
- [194] P.H. Corkhill, A.M. Jolly, C.O. Ng, B.J. Tighe, Synthetic hydrogels: 1. Hydroxyalkyl acrylate and methacrylate copolymers - water binding studies, *Polymer (Guildf)*. 28 (1987) 1758–1766.
- [195] I. Polysciences, Monomers Product Guide, (2012) 1–16.
- [196] J.M. Cariou, J. Dugas, L. Martin, P. Michel, Refractive-index variations with temperature of PMMA and polycarbonate., *Appl. Opt.* 25 (1986) 334–336.
- [197] S. D. Vold, Cataract Surgery Feature Story, (2009).
- [198] Y.H. Bae, S.W. Kim, pH / Temperature-sensitive polymers for macromolecular loading and release, 28 (1994) 143–152.
- [199] A. Gandhi, A. Paul, S.O. Sen, K.K. Sen, Studies on thermoresponsive polymers: Phase behaviour, drug delivery and biomedical applications, *Asian J. Pharm. Sci.* 10 (2015) 99–107.
- [200] T.M. Don, M.L. Huang, A.C. Chiu, K.H. Kuo, W.Y. Chiu, L.H. Chiu, Preparation of thermo-responsive acrylic hydrogels useful for the application in transdermal drug delivery systems, *Mater. Chem. Phys.* 107 (2008) 266–273.
- [201] D. Schmaljohann, Thermo- and pH-responsive polymers in drug delivery, *Adv. Drug Deliv. Rev.* 58 (2006) 1655–1670.
- [202] K. Nagase, T. Okano, Thermoresponsive-polymer-based materials for temperature-

- modulated bioanalysis and bioseparations, *J. Mater. Chem. B.* 4 (2016) 6381–6397.
- [203] K. Nidhi, S. Indrajeet, M. Khushboo, K. Gauri, D.J. Sen, Hydrotropy: A promising tool for solubility enhancement: A review, *Int. J. Drug Dev. Res.* 3 (2011) 26–33.
- [204] D. Honey, C. Caylor, R. Luthi, S. Kerrigan, Comparative alcohol concentrations in blood and vitreous fluid with illustrative case studies, *J. Anal. Toxicol.* 29 (2005) 365–369.
- [205] A.W. Jones, P. Holmgren, Uncertainty in estimating blood ethanol concentrations by analysis of vitreous humour, *J. Clin. Pathol.* 54 (2001) 699–702.
- [206] N.T. Lao, R.R. Rajan, H.F. Bushar, Residual Ethylene Oxide Determination in Polymethyl Methacrylate Disks and Intraocular Lenses by Headspace Gas Analysis and N₂ MDimethylformamide Extraction, 78 (1989) 1987–1990.
- [207] J. van Doornmalen, K. Kopinga, Review of surface steam sterilization for validation purposes, *Am. J. Infect. Control.* 36 (2008) 86–92.
- [208] R. Sayano, E.P. Goldberg, INTRAOCULAR IMPLANT, 2004.
- [209] M. Olaf, (12) United States Patent, 2002.
- [210] N.P. Luepke, F.H. Kemper, The HET-CAM test: An alternative to the draize eye test, *Food Chem. Toxicol.* 24 (1986) 495–496.
- [211] J.-P. Montheard, M. Chatzopoulos, D. Chappard, 2-Hydroxyethyl Methacrylate (HEMA): Chemical Properties and Applications in Biomedical Fields, *J. Macromol. Sci. Part C Polym. Rev.* 32 (1992) 1–34.
- [212] I. Tomatsu, K. Peng, A. Kros, Photoresponsive hydrogels for biomedical applications, *Adv. Drug Deliv. Rev.* 63 (2011) 1257–1266.
- [213] T.H.E. Role, O.F. Intraocular, C.O.F. Iols, A.N. Approach, A clear vision : using hydrogels,.
- [214] R.G. Martin, J.P. Gills, D.R. Sander, Foldable Intraocular Lenses, (1993) 1–28.
- [215] R.S. Haldar, R. Chauhan, K. Kapoor, U.K. Niyogi, Development of a hydrophobic polymer composition with improved biocompatibility for making foldable intraocular lenses, *Opt. Mater. (Amst).* 36 (2014) 1165–1176.
- [216] J.M. Chapman, L. Cheeks, K. Green, Drug interaction with intraocular lenses of different materials, *J. Cataract Refract Surg.* 18 (1992) 456–459.
- [217] F. Rossi, F. Castiglione, M. Ferro, P. Marchini, E. Mauri, M. Moioli, A. Mele, M. Masi, Drug-Polymer Interactions in Hydrogel-based Drug-Delivery Systems: An Experimental and Theoretical Study, *ChemPhysChem.* 16 (2015) 2818–2825.
- [218] R. Zarzycki, Z. Modrzejewska, K. Nawrotek, U. Lek, Drug Release From Hydrogel Matrices, *Ecol. Chem. Eng. S.* 17 (2010) 117–136.

- [219] W.B. Wang, A.Q. Wang, Preparation, Swelling and Water-Retention Properties of Crosslinked Superabsorbent Hydrogels Based on Guar Gum, *Adv. Mater. Res.* 96 (2010) 177–182.
- [220] V. Gun'ko, I. Savina, S. Mikhalovsky, Properties of Water Bound in Hydrogels, *Gels.* 3 (2017) 37.
- [221] J.M. Seidel, S.M. Malmonge, Synthesis of polyHEMA hydrogels for using as biomaterials. Bulk and solution radical-initiated polymerization techniques, *Mater. Res.* 3 (2000).
- [222] F. Yañez, J.L. Gomez-Amoza, B. Magariños, A. Concheiro, C. Alvarez-Lorenzo, Hydrogels porosity and bacteria penetration: Where is the pore size threshold?, *J. Memb. Sci.* 365 (2010) 248–255.
- [223] A. Alok, J.S. Adhikari, N.K. Chaudhury, Radioprotective role of clinical drug diclofenac sodium, *Mutat. Res. Toxicol. Environ. Mutagen.* 755 (2013) 156–162.
- [224] D. Wang, S.C. Miller, X.M. Liu, B. Anderson, X.S. Wang, S.R. Goldring, Novel dexamethasone-HPMA copolymer conjugate and its potential application in treatment of rheumatoid arthritis, *Arthritis Res. Ther.* 9 (2007) 1–9.
- [225] L. Quan, F. Yuan, X. Liu, J. Huang, Y. Alnouti, D. Wang, Pharmacokinetic and Biodistribution Studies of N-(2-Hydroxypropyl)methacrylamide (HPMA) Copolymer-Dexamethasone Conjugates in Adjuvant-induced Arthritis (AA) Rat Model, *Mol. Pharm.* 7 (2011) 1041–1049.
- [226] F. Bierbrauer, Hydrogel drug delivery : Diffusion models, *Sch. Math. Appl. Stat. Univ. Wollongong, Aust.* (2005) 1–31.
- [227] H. Hezaveh, I.I. Muhamad, I. Noshadi, L. Shu Fen, N. Ngadi, Swelling behaviour and controlled drug release from cross-linked -carrageenan/NaCMC hydrogel by diffusion mechanism, *J. Microencapsul.* 29 (2012) 368–379.
- [228] M.A. Kamaledin, Nano-ophthalmology: Applications and considerations, *Nanomedicine Nanotechnology, Biol. Med.* 13 (2017) 1459–1472.
- [229] S. Soltani, P. Zakeri-Milani, M. Barzegar-Jalali, M. Jelvehgari, Comparison of different nanosuspensions as potential ophthalmic delivery systems for ketotifen fumarate, *Adv. Pharm. Bull.* 6 (2016) 345–352.
- [230] T.P. Heyrman, M.L. McDermott, J.L. Ubels, H.F. Edelhauser, Drug uptake and release by a hydrogel intraocular lens and the human crystalline lens, *J. Cataract Refract. Surg.* 15 (1989) 169–175.
- [231] E. García-Millán, M. Quintáns-Carballo, F.J. Otero-Espinar, Improved release of

- triamcinolone acetonide from medicated soft contact lenses loaded with drug nanosuspensions, *Int. J. Pharm.* 525 (2017) 226–236.
- [232] P. Monograph, VOLTAREN * OPHTHA, (2017) 1–24.
- [233] C.C. Lin, A.T. Metters, Hydrogels in controlled release formulations: Network design and mathematical modeling, *Adv. Drug Deliv. Rev.* 58 (2006) 1379–1408.
- [234] Y. Hayasaka, S. Hayasaka, Y. Nagaki, Ocular changes after intravitreal injection of methanol, formaldehyde, or formate in rabbits., *Pharmacol. Toxicol.* 89 (2001) 74–78.
- [235] G. Martin-Amat, K.E. McMartin, S.S. Hayreh, M.S. Hayreh, T.R. Tephly, Methanol poisoning: Ocular toxicity produced by formate, *Toxicol. Appl. Pharmacol.* 45 (1978) 201–208.
- [236] K. Chen, W. Hsu, Intraoperative Ethanol Treatment as an Adjuvant Therapy of Pterygium Excision, 414–421.
- [237] S. Morita, Hydrogen-bonds structure in poly(2-hydroxyethyl methacrylate) studied by temperature-dependent infrared spectroscopy, *Front. Chem.* 2 (2014) 1–5.
- [238] S. Sornkamnerd, M.K. Okajima, T. Kaneko, Tough and Porous Hydrogels Prepared by Simple Lyophilization of LC Gels, *ACS Omega.* 2 (2017) 5304–5314.
- [239] M.H. Rich, M.K. Lee, N. Marshall, N. Clay, J. Chen, Z. Mahmassani, M. Boppart, H. Kong, Water-Hydrogel Binding Affinity Modulates Freeze-Drying-Induced Micropore Architecture and Skeletal Myotube Formation, *Biomacromolecules.* 16 (2015) 2255–2264.
- [240] S. Butylina, S. Geng, K. Oksman, Properties of as-prepared and freeze-dried hydrogels made from poly(vinyl alcohol) and cellulose nanocrystals using freeze-thaw technique, *Eur. Polym. J.* 81 (2016) 386–396.
- [241] A. Fini, G. Fazio, G. Feroci, Solubility and solubilization properties of non-steroidal anti-inflammatory drugs, *Int. J. Pharm.* 126 (1995) 95–102.
- [242] Caelo, Diclofenac-Natrium, API, 2006 (2015) 1–5.
- [243] X. Lou, S. Munro, S. Wang, Drug release characteristics of phase separation pHEMA sponge materials, *Biomaterials.* 25 (2004) 5071–5080.
- [244] P.I.L. A. T. Pham, Probing the mechanisms of drug release from HPMC matrices, *Pharm. Res.* 11 (1994) 1379–1384.
- [245] E. Karadağ, Ö.B. Üzümlü, D. Saraydin, Water uptake in chemically crosslinked poly(acrylamide-co-crotonic acid) hydrogels, *Mater. Des.* 26 (2005) 265–270.
- [246] X. Huang, C.S. Brazel, On the importance and mechanism of burst release in matrix controlled drug delivery systems., *J. Control. Release.* 73 (2001) 121–136.

- [247] F. Horkay, F. Horkay, I. Tasaki, I. Tasaki, P.J. Basser, P.J. Basser, Osmotic swelling of polyacrylate hydrogels in physiological salt solutions, *Biomacromolecules*. 1 (2000) 84–90.
- [248] T.L. Porter, R. Stewart, J. Reed, K. Morton, Models of hydrogel swelling with applications to hydration sensing, *Sensors*. 7 (2007) 1980–1991.
- [249] B.E. McCarey, L.A. Wilson, pH, osmolarity and temperature effects on the water content of hydrogel contact lenses, *Eye Contact Lens*. 8 (1982) 158–167.
- [250] V. Anand, R. Kandarapu, S. Garg, Ion-exchange resins: Carrying drug delivery forward, *Drug Discov. Today*. 6 (2001) 905–914.
- [251] O. Gan, Y. Ali, R. Rodstrom, S. Hancock, Ion exchange resins for Ophthalmic Delivery, 10 (1994) 57–67.
- [252] A.J. Bron, H. Mangat, M. Quinlan, A. Foley-Nolan, P. Eustace, M. Fsadni, P. Sunder Raj, Polyacrylic Acid Gel in Patients with Dry Eyes: A Randomised Comparison with Polyvinyl Alcohol, *Eur. J. Ophthalmol*. 8 (1998) 81–89.
- [253] J.E. Elliott, M. MacDonald, J. Nie, C.N. Bowman, Structure and swelling of poly(acrylic acid) hydrogels: Effect of pH, ionic strength, and dilution on the crosslinked polymer structure, *Polymer (Guildf)*. 45 (2004) 1503–1510.
- [254] M. Fathi, J. Barar, A. Aghanejad, Y. Omid, Hydrogels for ocular drug delivery and tissue engineering, *Bioimpacts*. 5 (2015) 159–164.
- [255] M.R. Aguilar, J. San Román, Smart Polymers and their Applications, *Smart Polym. Their Appl*. 3 (2014) 1–568.
- [256] F. Puoci, M. Curcio, Smart Materials for Drug Delivery, *Smart Mater. Drug Deliv*. Vol. 2. 2 (2013) 153–179.
- [257] F. Ganji, E. Vasheghani-Farahani, Hydrogels in Controlled Drug Delivery Systems, 4 (2011) 42–55.
- [258] A. Jouyban, *Handbook of Solubility Data for Pharmaceuticals*, 2010.
- [259] J. Siepmann, F. Siepmann, Mathematical modeling of drug delivery, *Int. J. Pharm*. 364 (2008) 328–343.
- [260] D. Tripti, R.S. Haldar, S. Geetha, U. Niyogi, R.K. Khandal, Materials for intraocular lenses (IOLs): Review of developments to achieve biocompatibility, 2009.
- [261] Miodrag Belosevic, Degradation of Alizarin Yellow R using UV / H₂ O₂ Advanced Oxidation Process, *Environ. Sci. Technol*. 33 (2014) 482–489.
- [262] M. Goel, R.G. Picciani, R.K. Lee, S.K. Bhattacharya, Aqueous humor dynamics: a review., *Open Ophthalmol. J*. 4 (2010) 52–9.

- [263] A. Bergua, *Das menschliche Auge in Zahlen*, 2017.
- [264] PubChem Compound Database, PubChem Compound Database, (2018). <https://pubchem.ncbi.nlm.nih.gov/compound/dexamethasone#section=Top> (accessed April 16, 2018).
- [265] M.E. Fini, S.G. Schwartz, X. Gao, S. Jeong, N. Patel, T. Itakura, M.O. Price, F.W. Price, R. Varma, W.D. Stamer, Steroid-induced ocular hypertension/glaucoma: Focus on pharmacogenomics and implications for precision medicine, *Prog. Retin. Eye Res.* 56 (2017) 58–83.
- [266] N. Sharma, M. Kaur, T. Agarwal, V.S. Sangwan, R.B. Vajpayee, Treatment of acute ocular chemical burns, *Surv. Ophthalmol.* 63 (2017) 214–235.
- [267] U. Pleyer, P.G. Ursell, P. Rama, Intraocular Pressure Effects of Common Topical Steroids for Post-Cataract Inflammation: Are They All the Same?, *Ophthalmol. Ther.* 2 (2013) 55–72.
- [268] Medmarket Diligence, *Cataract Surgery Market Expanding , Becoming More Competitive*, (2018).
- [269] H.B. Dick, A. Frohn, A.J. Augustin, B. Wolters, T. Pakula, N. Pfeiffer, Physicochemical surface properties of various intraocular lenses, *Ophthalmic Res.* 33 (2001) 303–309.
- [270] K. H. Eibl-Lindner, C. Wertheimer, *Die Intraokularlinse als Arzneimittelträger : Stand der Forschung und Ausblick Intraocular Lens as a Drug Delivery Device : State of the Art and Future Perspective*, (2016) 172–178.
- [271] D.P. Vanderbilt, *High refractive index hydrogel compositions for ophthalmic implants*, 2004.
- [272] T.P. Heyrman, M.L. McDermott, J.L. Ubels, H.F. Edelhauser, Drug uptake and release by a hydrogel intraocular lens and the human crystalline lens, *J. Cataract Refract. Surg.* 15 (1989) 169–175.
- [273] *Methacrylic Polymers*, in: *Van Nostrand's Sci. Encycl.*, American Cancer Society, 2006.
- [274] S. Eperon, M. Rodriguez-Aller, K. Balaskas, R. Gurny, Y. Guex-Crosier, A new drug delivery system inhibits uveitis in an animal model after cataract surgery, *Int. J. Pharm.* 443 (2013) 254–261.
- [275] D.F. Chang, Single versus three piece acrylic IOLs., *Br. J. Ophthalmol.* 88 (2004) 727–728.
- [276] A.H. Bilge, U. Aykan, T. Akin, U. Unsal, The effects of three-piece or single-piece acrylic intraocular lens implantation on posterior capsule opacification, *Eur J Ophthalmol.* 14 (2004) 375–380.

- [277] D.C. Carvalheira, STUDY OF THE MECHANISMS OF THERMAL DESPOLIMERIZAÇÃO OF THE POLI (METHYL METHACRYLATE) Selection of solvent compatible with PMMA Doutor Carlos Carvalheira, (2007).
- [278] C.A. Us, M. Wendy, C.A. Us, P.- Rechtsanwälte, * EP001776091B1 *, 1 (2007).
- [279] K.H. Bauer, K.-H. Frömming, C. Führer, Lehrbuch der Pharmazeutische Technologie, 6., Wiss. Verl.-Ges., Stuttgart, 1999.
- [280] C.L. Huang, T.W.J. Steele, E. Widjaja, F.Y.C. Boey, S.S. Venkatraman, J.S.C. Loo, The influence of additives in modulating drug delivery and degradation of PLGA thin films, NPG Asia Mater. 5 (2013) e54-11.
- [281] W. Behrens-Baumann, U. Frank, T. Neß, Rationale Antibiotikatherapie in der Augenheilkunde, Ophthalmologe. 107 (2010) 323–327.
- [282] J. Comley, NANOLITRE DISPENSING – on the Point of Delivery, Drug Discov. World. li (2002).
- [283] D. Repositorium, Toward a drug delivery coating for intraocular lenses
- [284] M.A. Galin, Medicamentet coated intraocular lens, 1980.
- [285] Y. Yang, Y. Gao, X. Mei, Effects of gamma-irradiation on PLGA microspheres loaded with thienorphine, 66 (2011).
- [286] D. V. Leaming, Practice styles and preferences of ASCRS members - 2003 Survey, J. Cataract Refract. Surg. 30 (2004) 892–900.
- [287] H.C. Haas, L. Farney, C. Valle, Some properties of ethyl cellulose films, J. Colloid Sci. 7 (1952) 584–599.
- [288] N. Agmon, The Grotthuss mechanism, Chem. Phys. Lett. 244 (1995) 456–462.
- [289] B.E. Thomes, T.A. Callaghan, Evaluation of in vitro glistening formation in hydrophobic acrylic intraocular lenses, Clin. Ophthalmol. 7 (2013) 1529–1534.
- [290] H. Matsushima, M. Nagata, Y. Katsuki, I. Ota, K. Miyake, G.H.H. Beiko, A. Grzybowski, Decreased visual acuity resulting from glistening and sub-surface nano-glistening formation in intraocular lenses: A retrospective analysis of 5 cases, Saudi J. Ophthalmol. 29 (2015) 259–263.
- [291] H C Seward, Commentary Folding intraocular lenses : materials and methods, 81 (1997) 340–341.
- [292] T. Oshika, Y. Shiokawa, Effect of folding on the optical quality of soft acrylic intraocular lenses, J. Cataract Refract. Surg. 22 (1996) 1360–1364.

6. Publications and posters

Heck, M.; Bodmeier, R. (in preparation)

Dual drug-loaded foldable hydrophobic intraocular lenses with zero-order release kinetics for dexamethasone and immediate release for minocycline

Heck, M.; Bodmeier, R. (in preparation)

Dual drug-loadings for hydrophilic intraocular lenses which demonstrate extended and immediate drug release simultaneously

Heck, M.; Dashevskiy, A.; Bodmeier, R.

Extended Drug Release from Different Intraocular Lens Formulations in an Artificial Lachrymal Fluid

Poster # T3256. 2015 AAPS Annual Meeting and Exposition; Orlando, Florida, USA.

Heck, M.; Bodmeier, R.

Improved drug loading and release from HEMA/MMA intraocular lenses

Poster # 30T0400 2016 AAPS Annual Meeting and Exposition, Denver, Colorado, USA.

Heck, M.; Bodmeier, R.

Improved drug loading and release from hydrophilic intraocular lenses

Poster # 18, Tag der Pharmazie der Freien Universität Berlin, Deutschland, 01. Juli 2016

Heck, M.; Bodmeier, R.

Drug release modification of soft acrylic intraocular lenses

Poster # T 1004. 2017 AAPS Annual Meeting and Exposition, San Diego, California, USA

Heck, M.; Bodmeier, R.

Drug-coating of hydrophobic acrylic intraocular lenses

Poster # T 1005. 2017 AAPS Annual Meeting and Exposition, San Diego, California, USA

7. Curriculum vitae

Regarding data protection, the Curriculum vitae
is not offered in the online version

Begründet durch den Datenschutz ist der Lebenslauf
in der Online-Version nicht enthalten