

# AMINERGIC CONTROL OF *DROSOPHILA* BEHAVIOR

Dissertation  
to obtain the academic degree  
Doctor rerum naturalium (Dr. rer. nat.)

Submitted to the Department Biology, Chemistry, and Pharmacy  
Freie Universität Berlin

by  
Christine Damrau  
from Kaufbeuren

October 2014

---

First reviewer: Prof. Dr. Björn Brembs  
Second reviewer: Prof. Dr. Hans-Joachim Pflüger  
Date of disputation: 19<sup>th</sup> of December 2014

### **Declaration**

I hereby declare that the work presented in this thesis has been conducted independently and without inappropriate support. All sources of information are referenced. I hereby declare that this thesis has not been submitted, either in the same or a different form, to this or any other university for a degree.

---

---

## **Author contribution**

Chapter 1 is based on the following manuscript:

COMPLEX INTERACTIONS OF OCTOPAMINE AND TYRAMINE ORCHESTRATE SUGAR RESPONSIVENESS AND STARVATION RESISTANCE IN DROSOPHILA

Authors: Christine Damrau, Naoko Toshima, Sabrina Scholz-Kornehl, Martin Schwärzel, Teiichi Tanmiura, Björn Brembs, Julien Colomb

will be submitted to *The Journal of Neuroscience*

Björn Brembs, Julien Colomb and Christine Damrau discussed the experimental conception. Naoko Toshima performed the electrophysiological recordings. Sabrina Scholz-Kornehl created two mutants. Martin Schwärzel and Teiichi Tanimura supervised Sabrina Scholz-Kornehl and Naoko Toshima. Christine Damrau performed all other experiments, analyzed and illustrated the data, and wrote the manuscript. Julien Colomb and Björn Brembs provided suggestions, criticisms, and corrections.

Chapter 2 is based on the following manuscript:

SPECIFIC DOMINANCE OF THE DROSOPHILA TRH GENE IN DIFFERENT BEHAVIORAL TASKS

Authors: Christine Damrau, Björn Brembs, Julien Colomb

will be submitted to *PLOSgenetics*

Björn Brembs, Julien Colomb and Christine Damrau discussed the experimental conception. Christine Damrau performed the behavioral experiments, analyzed and illustrated the data, and wrote the manuscript. Julien Colomb and Björn Brembs provided suggestions, criticisms, and corrections.

Additional contributions by persons other than the authors are described in the Acknowledgments section of each chapter.

---

---

**CONTENT**

|   |           |
|---|-----------|
| <b>SUMMARY .....</b>  | <b>7</b>  |
| <b>ZUSAMMENFASSUNG .....</b>  | <b>8</b>  |
| <b>GENERAL INTRODUCTION .....</b>   | <b>10</b> |
| <b>Biogenic amines .....</b>  | <b>10</b> |
| Implementations in human diseases .....   | 11        |
| Role in vertebrates and invertebrates .....   | 11        |
| <b>Octopamine and tyramine .....</b>  | <b>12</b> |
| Structure and synthesis .....   | 12        |
| Octopaminergic and tyraminergeric receptors .....   | 12        |
| Octopamine and tyramine in invertebrates .....  | 13        |
| <b>Orchestration hypothesis .....</b>   | <b>14</b> |
| <b>The model organism <i>Drosophila melanogaster</i> .....</b>  | <b>16</b> |
| <b>Behavioral experiments .....</b>   | <b>17</b> |
| <br>  |           |
| <b>CHAPTER 1: COMPLEX INTERACTIONS OF OCTOPAMINE AND TYRAMINE ORCHESTRATE</b>                                 |           |
| <b>SUGAR RESPONSIVENESS AND STARVATION RESISTANCE IN <i>DROSOPHILA</i> .....</b>                              | <b>18</b> |
| <br>  |           |
| <b>Acknowledgements .....</b>   | <b>18</b> |
| <b>Abstract .....</b>   | <b>18</b> |
| <b>Introduction .....</b>   | <b>19</b> |
| <b>Methods .....</b>  | <b>20</b> |
| Fly stocks and culture .....  | 20        |
| Starvation procedure .....  | 20        |
| Survival experiments .....  | 20        |
| Sugar response test .....   | 21        |
| PER assay validation .....  | 22        |
| Carbohydrate measurement .....  | 22        |
| Electrophysiological recording .....  | 22        |
| Statistics .....  | 23        |
| <br>  |           |
| <b>Results .....</b>  | <b>24</b> |
| <i>tβh<sup>nM18</sup></i> mutants respond less to sucrose .....   | 24        |
| Physiological response to starvation is weaker in <i>tβh<sup>nM18</sup></i> compared to wild type flies ..... | 25        |
| Acute <i>tβh</i> induction rescues the sugar response phenotype .....   | 27        |
| Sensitivity of taste receptor neurons is lower in <i>tβh<sup>nM18</sup></i> mutants .....                     | 28        |
| Differential outcome of OA/TA-receptor manipulations on survival and sugar responsiveness .....               | 29        |

---

---

|   |           |
|---|-----------|
| Neuronal and non-neuronal <i>tβh</i> expression rescues PER .....   | 31        |
| <b>Discussion</b> .....   | <b>32</b> |
| OA/TA and proboscis extension response.....   | 32        |
| OA/TA and metabolism .....  | 32        |
| Acute OA/TA-effect rescues mutant sugar responsiveness .....  | 33        |
| OA/TA and gustatory receptor sensitivity.....   | 33        |
| Receptor mutant analysis uncoupled physiological from behavioral effects of starvation .....                    | 34        |
| Where is the OA/TA-action site?.....  | 34        |
| <b>Conclusions</b> .....  | <b>35</b> |
| <br>  |           |
| <b>CHAPTER 2: SPECIFIC DOMINANCE OF THE <i>DROSOPHILA</i> TBH GENE IN DIFFERENT</b>                             |           |
| <b>BEHAVIORAL TASKS .....</b>   | <b>36</b> |
| <br>  |           |
| <b>Acknowledgements</b> .....   | <b>36</b> |
| <b>Abstract</b> .....   | <b>36</b> |
| <b>Introduction</b> .....   | <b>37</b> |
| <b>Methods</b> .....  | <b>38</b> |
| Fly strains .....   | 38        |
| Fly care.....   | 38        |
| Heat protocols .....  | 39        |
| Buridan’s paradigm .....  | 39        |
| Sugar sensitivity test .....  | 39        |
| Statistics .....  | 40        |
| <b>Results</b> .....  | <b>40</b> |
| Differential dominance of <i>tβh<sup>nM18</sup></i> mutation for different behavioral parameters .....          | 40        |
| GAL4-UAS-dependent rescue had no effect .....   | 42        |
| Acute <i>tβh</i> expression affects the phenotypes differently .....  | 43        |
| Synthesis amplification of either OA or TA led to different effects in walking speed and stripe deviation ..... | 43        |
| Modulation of walking speed and stripe deviation by OA and TA was not correlated .....                          | 44        |
| <b>Discussion</b> .....   | <b>46</b> |
| Locomotion Phenotypes.....  | 46        |
| Phenotypes are differently affected by <i>tβh</i> gene dosage.....  | 46        |
| TA contributes to the phenotype in <i>tβh<sup>nM18</sup></i> mutants .....                                      | 47        |
| <i>tβh<sup>nM18</sup></i> mutation show differential dominance effects .....                                    | 48        |
| Overexpression and rescue attempts .....  | 48        |
| <b>Conclusion</b> .....   | <b>49</b> |

---

|                                 |           |
|---------------------------------|-----------|
| <b>GENERAL DISCUSSION .....</b> | <b>50</b> |
| <b>LIST OF REFERENCES .....</b> | <b>53</b> |
| <b>ACKNOWLEDGEMENTS .....</b>   | <b>65</b> |

---

## SUMMARY

The biogenic amines tyramine and octopamine are important neuromodulators involved in many physiological processes in invertebrates. They enable the modulation of behavioral output in response to internal and environmental changes.

In this study, the role of octopamine and tyramine in sugar response and locomotion was investigated by genetic modifications affecting amine levels in adult *Drosophila melanogaster*. The synthesis-mutant *tβh<sup>nM18</sup>* (tyramine-β-hydroxylase) lacking octopamine and accumulating tyramine was analyzed in two behavioral paradigms: in the proboscis extension assay to test sugar response after starvation and in the Buridan's assay to test walking speed and stripe deviation.

In the proboscis extension assay, starved *tβh<sup>nM18</sup>* mutants showed a reduced sugar response. Their hemolymph carbohydrate concentration was elevated compared to control flies and when starved to death, they survived longer. Temporally controlled rescue experiments revealed an action of the OA/TA system during sugar response, while spatially controlled rescue experiments suggested OA/TA actions inside and outside of the nervous system. Additionally, the analysis of OA- and TA-receptor mutants exhibited an involvement of both amines in the animals' physiological response to starvation.

In the Buridan's paradigm, *tβh<sup>nM18</sup>* mutants walked slower and more directed to the presented stripes. The analysis of *tβh* overexpression in mutant and wild type flies as well as in OA- and TA-receptor mutants revealed a complex interaction of both aminergic systems in the control of locomotion.

The null allele *tβh<sup>nM18</sup>* showed differential dominance effects on the three behavioral traits ranging from recessive to overdominant. The data suggested that the different neuronal networks responsible for the three phenotypes are differentially sensitive to *tβh* gene dosage.

In conclusion, the here presented data indicate a cooperation of biogenic amines on behavioral control, not only in the nervous system but also in non-neuronal tissues. The modulation of the different behavioral aspects is *tβh* dosage-dependent. The activity of the *tβh*-enzyme enables the alteration of the relative concentrations of octopamine and tyramine leading to behavioral modulation. Thus, this work provides a mechanism for behavioral plasticity achieved by amine level alterations.

## ZUSAMMENFASSUNG

Die biogenen Amine Tyramin und Octopamin sind in Invertebraten als wichtige Neuromodulatoren an unzähligen physiologischen Prozessen beteiligt. Sie ermöglichen die Modulation von Verhaltensantworten in Reaktion auf interne und externe Veränderungen.

In dieser Arbeit wurde die Rolle von Octopamin und Tyramin in der Zuckerantwort und im Laufverhalten am Modellorganismus *Drosophila melanogaster* mit Hilfe genetischer Manipulation untersucht, in Folge derer sich die relative Menge der Amine verändert.

Die Synthesemutante  $t\beta h^{nM18}$  (tyramine- $\beta$ -hydroxylase), die kein Octopamin aber einen Überschuss an Tyramin aufweist, wurde in zwei Verhaltensparadigmen getestet: im Proboscisextensionsassay (Hunger-abhängige Antwort auf Zucker) und in Buridan's Assay (Laufgeschwindigkeit und visuelle Fixation).

Im Proboscisextensionsassay zeigten gehungerte  $t\beta h^{nM18}$  Mutanten eine reduzierte Antwort auf Zucker, während die Konzentration der Kohlenhydrate in ihrer Hämolymphe im Vergleich zu Kontrollfliegen erhöht war. Des Weiteren wiesen sie eine längere Überlebensdauer ohne Futter auf. Zeitlich kontrollierte Rettungsversuche zeigten eine Aktivität des octopaminergen und tyraminergen Systems während der Antwort auf Zucker, während räumlich kontrollierte Rettungsversuche eine Aktivität des octopaminergen und tyraminergen Systems innerhalb und außerhalb des Nervensystems zeigten. Eine Analyse von Octopamin- und Tyraminrezeptoren ergab eine Beteiligung beider Amine in der physiologischen und neuronalen Reaktion auf Futterentzug.

Im Buridanparadigma zeigten  $t\beta h^{nM18}$  Mutanten eine geringere Laufgeschwindigkeit und mehr Bewegung in Richtung der präsentierten Streifen. Die Ergebnisse der  $t\beta h$ -Überexpression und der Rezeptormutanten legten eine komplexe Interaktion zwischen den aminergen Systemen zur Bewegungskontrolle dar.

Das Nullallel  $t\beta h^{nM18}$  wies differentielle Dominanzeffekte auf die drei getesteten Verhalten auf, die von rezessiv bis überdominant reichten. Die Daten lassen den Schluss zu, dass verschiedene neuronale Netzwerke für die drei Verhalten verantwortlich sind. Die Modulation von Zuckerantwort und visuelle Fixation korrelierten mit der  $t\beta h$ -Gendosis.



Zusammenfassend zeigen die hier präsentierten Daten die Zusammenarbeit zweier biogener Amine bei der Kontrolle von Verhaltensmustern, die nicht nur im Gehirn, sondern auch nicht neuronal stattfindet. Die Veränderung der relativen Mengen von Octopamin und Tyramin durch *tβh*-Induktion ist ein möglicher Mechanismus für die Verhaltensmodulation, der durch Stress ausgelöst werden könnte. Diese Modulation wird von der *tβh*-Genexpression beeinflusst.

## GENERAL INTRODUCTION

Behavioral plasticity is fundamental for an organism's ability to adapt to internal and environmental changes. It is achieved by the modulation of the underlying nervous system, mainly through the regulation of the action of biogenic amines. How the modulation is processed in detail is mostly unclear. This thesis addresses the underlying mechanism of aminergic modulation of behavioral phenotypes in adult *Drosophila melanogaster*. I will give an introduction about biogenic amines in vertebrates and invertebrates, then describe known roles of the insect amines octopamine and tyramine, and present *Drosophila* as a model organism. In two chapters, the results are given in form of manuscripts. First, the feeding-related behavior sugar response and the physiological effects of starvation are examined. Second, the modulation of the locomotion-related behaviors stripe fixation and walking speed is investigated. The main findings were, that disruption in amine synthesis differentially affects different behavioral traits; and that amines are not only active in neuronal but also in non-neuronal tissues. At the end of the thesis, implications of this research are discussed.

### Biogenic amines

Biogenic amines act as neurotransmitter, neuromodulator and neurohormone (Evans, 1980). A neurotransmitter is a messenger released from a neuron that diffuses across the synaptic cleft and affects one or two postsynaptic neurons, a muscle cell, or another effector cell. A neuromodulator is a messenger released from a neuron into the central nervous system or periphery. It affects groups of neurons or effector cells expressing the appropriate receptors. The release is either local or more widespread. It often acts via second messengers and can produce long-lasting effects. A neurohormone is a messenger released by neuroendocrine cells into the hemolymph and exerts its effects on distant peripheral targets. Neurohormonal effects are difficult to distinguish from neuromodulator ones in the extent of its action (Burrows, 1996).

**Implementations in human diseases**

Biogenic amines have a great impact on the organism such that many human disorders were related to alterations in the regulation of biogenic amines. The psychiatric disorder of depression for example is linked to a dysregulation of the amines dopamine, norepinephrine and serotonin in the hippocampus, cerebral cortex, nucleus accumbens, amygdala and hypothalamus (Schildkraut, 1965; Coppen, 1967; Nestler and Carlezon, 2006). Parkinson's disease underlies a degeneration of dopaminergic neurons in the substantia nigra in the midbrain (Hirsch et al., 1988). The gradually shrinking neuronal volume leads to severe locomotor defects and non-motor symptoms like dementia and depressive mood (reviewed in Shulman et al., 2011). Not only diseases are related to biogenic amines, but also the action mechanism of drugs of abuse or therapeutics. Amphetamines for example bind to endogenous receptors of dopamine, norepinephrine and serotonin (Bunzow et al., 2001) whereas cocaine inhibits their reuptake after release (Volkow et al., 1997). Similarly to cocaine, methylphenidate (ritaline) used in attention deficit hyperactivity disorder treatment inhibits amines' reuptake (Volkow et al., 1999).

**Role in vertebrates and invertebrates**

Biogenic amines perform similar tasks in vertebrate and invertebrate nervous systems. For example circadian rhythm and sleep are similarly regulated in a wake- or sleep-promoting manner by serotonin, dopamine and norepinephrine in mammals (Saper et al., 2005) and insects (Livingstone and Tempel, 1983; reviewed in Crocker and Sehgal, 2010). Furthermore, the fight or flight response is a common vertebrate and invertebrate adaption to particularly energy demanding or stressful situations. It includes adjustment processes in various organs and behavioral aspects. For example, aggressive potential is enhanced obtained by changing titers of serotonin and norepinephrine in mammals (Olivier, 2004) and crickets (Stevenson et al., 2000). Cardiovascular activity and heart rate increase by histamine and catecholamines release into the vertebrate brain (Tangri et al., 1989; Singewald and Philippu, 1996) and the invertebrate hemolymph (Kling and Schipp, 1987; Zornik et al., 1999).

## Octopamine and tyramine

### Structure and synthesis

One of the most abundant biogenic amine in invertebrates is octopamine (systematic name: 4-(2-amino-1-hydroxy-ethyl)phenol). Its biological precursor is tyramine (systematic name: 4-(2-aminoethyl)phenol). Octopamine (OA) and tyramine (TA) were first discovered in the salivary glands of the *Octopus vulgaris* (Erspamer and Boretti, 1951) and are the invertebrate counterparts of norepinephrine (David and Coulon, 1985). TA is synthesized from the amino acid tyrosine by the enzyme tyrosine-decarboxylase (Tdc, Livingstone and Tempel, 1983); OA is synthesized from TA by the enzyme tyramine- $\beta$ -hydroxylase (*t $\beta$ h*, Wallace, 1976; see Figure 1). OA is only generated in nervous tissues (Monastirioti et al., 1995) whereas TA is also generated in non-neuronal cells (Blumenthal, 2003).

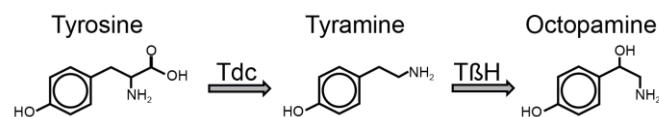

**Figure 1: Octopamine and tyramine synthesis.**

The starting material is the amino acid tyrosine synthesized from the essential amino acid phenylalanine. The tyrosine-decarboxylase (Tdc) converts tyrosine into the biogenic amine tyramine. Tyramine is converted into octopamine by the tyramine- $\beta$ -hydroxylase (T $\beta$ H). The synthesis pathway is simplified; co-substrates and co-products are not illustrated.

### Octopaminergic and tyraminergetic receptors

OA and TA are independent messenger molecules that act via G protein-coupled receptors. The here presented classification is based on structural and signaling similarities between cloned *Drosophila* OA receptors and vertebrate adrenergic receptors (see Figure 2; Evans and Maqueira, 2005; Farooqui, 2012).

First, there are two types of octopaminergic receptors which cause calcium and cyclic adenosine monophosphate (cAMP) level change: the Oct $\beta$ R class shares sequence identity with vertebrate  $\alpha$ 1-adrenergic receptors. This receptor class is highly OA-responsive and causes mainly calcium increase but also cAMP increase to a smaller extent (Han et al., 1998; Balfanz et al., 2005). The Oct $\beta$ R class shares sequence identity with vertebrate  $\beta$ -adrenergic receptors. Those receptors elicit exclusively cAMP increase (Maqueira et al., 2005).

Second, there are three types of tyraminergetic receptors: The Oct-TyrR class shares sequence identity with vertebrate  $\alpha$ 2-adrenergic receptors. This receptor class causes agonist-dependent signaling. TA preferentially binds to the receptor to reduce cAMP, whereas OA preferentially binds to the receptor to increase calcium (Saudou et al., 1990; Robb et al., 1994; Kutsukake et al., 2000). The TyrRII class is specifically responsive to TA and causes exclusively calcium increase (Cazzamali et al., 2005; Bayliss et al., 2013). A third TA receptor class was very recently characterized (Bayliss et al., 2013). The TyrRIII class seems neither to be agonist- nor signaling-specific. TA coupling reduces cAMP and increases calcium but to a smaller extent. OA or dopamine coupling reduces cAMP to a smaller extent compared to TA. OA coupling increases calcium with the same potency as TA but only at higher concentrations.

In the thesis, I refer to the common receptor terms used at flybase: TyrRI referred to honoka, TyrRII is referred to TyrR, TyrRIII is referred to TyrRII.

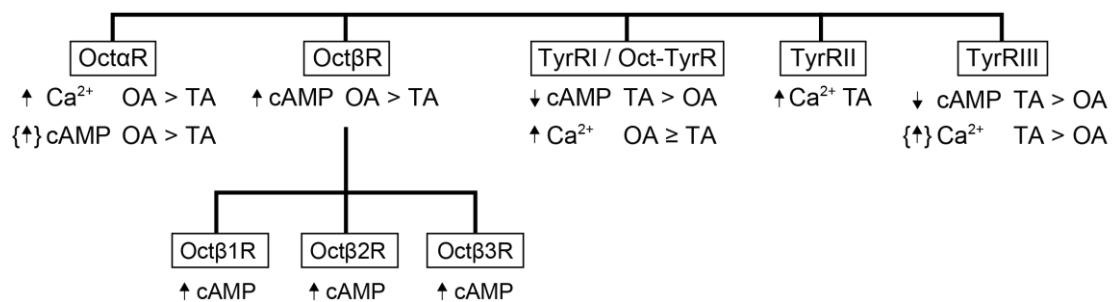

**Figure 2: Classification of octopaminergic and tyraminergetic receptors.**

The classification is based on functional, phylogenetical and structural similarities. Oct $\alpha$ R and Oct $\beta$ R are structurally related to vertebrate  $\alpha$ - and  $\beta$ -adrenergic receptors, respectively and more efficient after OA-binding. TyrRI affects cAMP and Ca<sup>2+</sup> levels differently if coupled with OA or TA. TyrRII are TA-specific. TyrRIII was very recently discovered and is separated from TyrRI and TyrRII due to its pharmacological properties.

Abbreviations: Ca<sup>2+</sup>, calcium; cAMP, cyclic adenosine monophosphate; ↑, increase; ↓, decrease. Oct, octopamine; R, receptor; Tyr, tyramine.

## Octopamine and tyramine in invertebrates

TA and OA are involved in a plethora of regulatory mechanisms and modulate almost every physiological process. TA is for example involved in olfaction (Kutsukake et al., 2000) and mediates proboscis extension response altered by odor exposure (Nisimura et al., 2005; Ishida and Ozaki, 2012). In the Malpighian tubules TA stimulates both urine production and transepithelial chloride conductance as a diuretic (Blumenthal, 2003, 2009).

OA affects insect flight: octopaminergic neurons innervate locust flight muscles (Whim and Evans, 1988) and regulate flight initiation and maintenance in flies (Brembs et al., 2007), whereby OA stimulates carbohydrate catabolism during take-off but tend to decrease muscle glycolysis during prolonged locust flight (Mentel et al., 2003). OA also acts on walking initiation (Rosenberg et al., 2007), sleep (Crocker and Sehgal, 2008, 2010) and arousal (Arnesen and Olivo, 1988; Bacon et al., 1995); it is demonstrated in anatomical studies that OA levels increase with stress (Gruntenko et al., 2004; Kononenko et al., 2009) in the hemolymph (Davenport and Evans, 1984). In cockroach, OA stimulates carbohydrate metabolism in the fat body (Park and Keeley, 1998). Octopaminergic neurons innervate proprioceptors in the locust (Ramirez and Orchard, 1990; Bräunig and Eder, 1998). Furthermore, social behavior like aggression can be enhanced by octopamine signaling (Zhou et al., 2008). OA appeared necessary for olfactory (Schwaerzel et al., 2003; Schroll et al., 2006) and visual reward learning (Unoki et al., 2006) and is able to replace the reinforcement signal in honeybee associative olfactory learning (Hammer, 1993). After amine depletion, OA injection in honeybees can restore proboscis extension (Braun and Bicker, 1992). Finally, OA was detected to affect hemocytes in *Drosophila* immune system (Baines et al., 1992).

TA and OA often affect the same processes in concert. For example, OA and TA have opposite effects on muscle contraction (Ormerod et al., 2013) and on larval crawling (Saraswati et al., 2004; Fussnecker et al., 2006; Selcho et al., 2012). Sperm release requires OA and TA (Avila et al., 2012), and ethanol attraction is mediated by TA/OA neurons (Schneider et al., 2012). For insect ovulation, OA is an important signal in oviduct muscles (Orchard and Lange, 1985), the Oamb receptor is necessary for ovulation (Lee et al., 2009) whereas TA seems to be needed to deposit the eggs (Cole et al., 2005).

### **Orchestration hypothesis**

In order to explain how only one messenger molecule can be involved in such a tremendous number of different processes, the orchestration hypothesis was proposed (Sombati and Hoyle, 1984). The orchestration hypothesis assumes that the activation of specific subsets of modulatory neurons generates a specific behavior. While general release of the excitatory modulator substance will increase the probability of the occurrence of any behavior, which behavior will in fact appear

depends on which modulatory neurons are most strongly active at the time. The activity of a so called command neuron causes the execution of a motor pattern whereas the modulatory neuron controls the performance. How the two types of neurons could be possibly connected is illustrated in Figure 3.

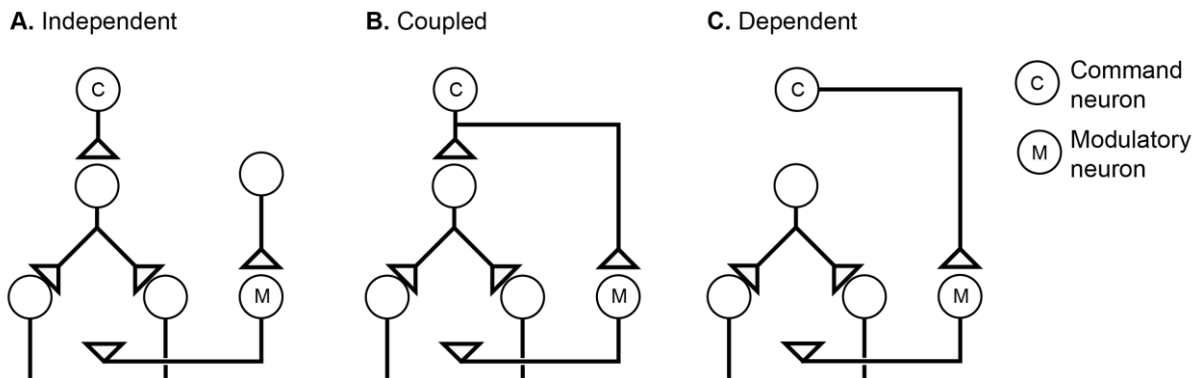

**Figure 3: Orchestration hypothesis.**

The three different possible connections between command and modulatory neuron to perform behavioral output suggested by Sombati and Hoyle (1984). **A.** The independent modulation is provided by a command neuron acting independently of the modulatory neuron on the behavioral output. **B.** The coupled modulation includes one command neuron that not only activates the behavioral output but also the modulatory neuron. **C.** The dependent mechanism includes a behavioral output system independent from a command neuron that directly activates the modulatory neuron.

More recent research on motor behavior of fly larva (Saraswati et al., 2004), honeybee (Fussnecker et al., 2006), and locust (Rillich et al., 2013) suggests that a synergy of several amines rather than single ones determine motor output. Central pattern generators consisting of excitatory and inhibitory neurons produce rhythmic activity in motor neurons to generate motor patterns like walking, flying and swimming (reviewed in Marder et al., 2005). Octopamine and other amines apparently modulate the central pattern generators responsible for walking and flying (Sombati and Hoyle, 1984; Claassen and Kammer, 1986; Buhl et al., 2008; Rillich et al., 2013).

**The model organism *Drosophila melanogaster***

*Drosophila melanogaster* was suggested as a genetic model system more than 100 years ago (reviewed in Bellen et al., 2010) by William Castle (Castle et al., 1906). First experiments in flies were performed by Thomas Morgan to investigate inheritance (Morgan, 1910, 1911). Many nowadays famous mutants were discovered over the years and have been related to various aspects of neuroscience. Mutations in *Notch* for example were implemented in developmental mechanisms (Poulson, 1950) as well as homeotic genes (Lewis, 1978), *period* was characterized as an important signal in the circadian rhythm (Konopka and Benzer, 1971), and the first learning and memory mutant was identified (Dudai et al., 1976). In *Drosophila*, somatic crossing over was investigated (Weinstein, 1918) and X-rays were discovered to be mutagenic (Poulson, 1950).

*Drosophila* as a model system offers many advantages: it exhibits a short generation time and simple maintenance under lab conditions. Its minimal brain complexity of around 100,000 neurons simplifies the work for neurobiologists. The greatest advantage however is the genetic tool box. Examples for such manipulation tools are P-element-mediated transformations (Rubin and Spradling, 1982) and the FLIP/FRT recombination (Golic and Lindquist, 1989). The most widely used tool is the GAL4-UAS system (Brand and Perrimon, 1993) which offers the opportunity to express certain genes or block neuronal activity in the tissue of choice. GAL4 is a transcription factor extracted from yeast and repressed by GAL80 (Perlman and Hopper, 1979). The GAL4-transcription factor binds to the upstream activating sequence (UAS) and activates the expression of the inserted gene of interest if both elements, the GAL4 and the UAS, are expressed in the same cell (Figure 4A). Temporal (McGuire et al., 2003) or spatial (Suster et al., 2004) control of gene expression can be achieved by coexpressing GAL80 (Figure 4B). Another common technique to express a gene of interest is the usage of a temperature-sensitive promoter (Clos et al., 1990). The binding of a heat shock protein to the promoter is most affine at high temperatures (Figure 4C) which enables temporally controlled transcription of the attached gene of interest.



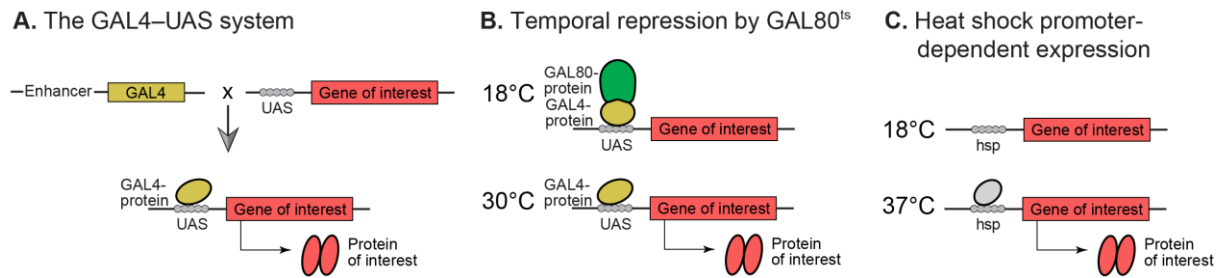

**Figure 4: Common techniques to manipulate gene expression in *Drosophila*.**

**A. GAL4-UAS system:** The transcription factor GAL4 is dependent on the expression site of the enhancer. The upstream activating sequence UAS is linked to the gene of interest. If the GAL4-driver and the UAS-line are crossed, both elements are present in the progeny and the gene of interest is expressed in all the cells where the enhancer is expressed. **B. GAL80<sup>ts</sup> repressor:** The GAL4 expression can be repressed by GAL80. Here, the function of the temperature-dependent GAL80<sup>ts</sup> is illustrated. GAL80<sup>ts</sup> binds the GAL4 to prevent it from DNA-binding. At increased temperature, GAL80<sup>ts</sup> is deactivated and gene transcription is started. **C. Heat shock promoter-dependent expression:** The gene of interest can be cloned downstream of a temperature-sensitive promoter. Whenever the fly is heat shocked the gene of interest is expressed.

## Behavioral experiments

In this study, the involvement of TA and OA is investigated in the three behavioral traits walking speed, fixation behavior and sugar response. The inner state of the animal and environmental changes can modulate these behaviors: hungry flies walk longer distances (Meunier et al., 2007) and respond stronger to sugar (Colomb et al., 2009). Fixation behavior depends on the behavioral state of either walking (Chiappe et al., 2010), flying (Süver et al., 2012) or resting. Environmental changes like different food qualities (Colomb et al., 2009) or light conditions (Osorio et al., 1990) also modify the flies' behavioral output.

In the following two chapters, the effects of OA and TA on locomotion and sugar response are presented. Starvation-induced sugar response is investigated in a locomotion-independent proboscis extension assay. In this context, OA and TA effects on metabolism and gustatory receptor neurons are discovered. Additionally, the locomotion behavior in the Buridan's paradigm (Bülthoff et al., 1982) is determined with focus on walking speed and stripe deviation as a measure of fixation behavior.

## CHAPTER 1: COMPLEX INTERACTIONS OF OCTOPAMINE AND TYRAMINE ORCHESTRATE SUGAR RESPONSIVENESS AND STARVATION RESISTANCE IN *DROSOPHILA*

<sup>1</sup>Christine Damrau, <sup>2</sup>Naoko Toshima, <sup>1</sup>Sabrina Scholz-Kornehl, <sup>1</sup>Martin Schwärzel,  
<sup>2</sup>Teiichi Tanimura, <sup>3</sup>Björn Brembs\*, <sup>1</sup>Julien Colomb

<sup>1</sup>Freie Universität Berlin, Fachbereich Biologie-Chemie-Pharmazie, Institut für Biologie, Neurobiologie, Königin-Luise-Straße 28-30, 14195 Berlin, Germany <sup>2</sup>Kyushu University, Division of Biological Sciences, Graduate School of Systems Life Sciences, Hakozaki, Fukuoka 812-8581, Japan <sup>3</sup>University of Regensburg, Institute of Zoology – Neurogenetics, Universitätsstraße 31, 93040 Regensburg, Germany

\*Author of correspondence (bjoern@brembs.net)

### Acknowledgements

We are grateful to DFG for funding, to Henrike Scholz, Hiromu Tanimoto, Andreas Thum, and Amita Seghal for providing flies, to Dennis Pauls for sharing methodology of hemolymph extraction, to Edward Blumenthal for sharing data prior to publication, to Hildegard Hopp, Julia Sigl, Lucie Dieterich and Victoria Antemann for technical assistance.

### Abstract

Octopamine (OA) and its precursor tyramine (TA) are neurotransmitters operating in many different neuronal and physiological processes. We investigated the role of those two transmitters in *Drosophila* sugar responsiveness. Tyrosine- $\beta$ -hydroxylase (*t $\beta$ h*) mutants are unable to convert TA into OA. Starved mutants show a reduced sugar response and their hemolymph sugar concentration is elevated compared to control flies. When starved to death, they survive longer. Temporally controlled rescue experiments revealed an action of the OA/TA system during the sugar response, while spatially controlled rescue experiments suggest actions also outside of the nervous system. Additionally, the analysis of four OA- and four TA-receptor mutants suggests an involvement of both receptor types in the animals' physiological and neuronal response to starvation. These results complement the pharmacological investigations in *Apis mellifera* described in our companion paper (Buckemüller et al., in preparation).

## Introduction

Biogenic amines are important modulators of the nervous system. For instance, most antidepressants act on norepinephrine, dopamine, and serotonin production or reuptake (Coppen, 1967; Muscat et al., 1990). In invertebrates, octopamine (OA), structurally related to norepinephrine (David and Coulon, 1985), and its precursor tyramine (TA) act as neurotransmitters, -hormones, and -modulators on many, if not all, physiological processes (reviews: Roeder, 2005; Farooqui, 2012), among others on locomotion regulation (Saraswati et al., 2004; Brembs et al., 2007), aggression (Baier et al., 2002; Hoyer et al., 2008; Zhou et al., 2008), feeding behavior (Long and Murdock, 1983; Nisimura et al., 2005), mobilization of energy metabolites (Mentel et al., 2003) and, upstream of dopamine, on appetitive olfactory learning (Hammer, 1997; Schwaerzel et al., 2003; Burke et al., 2012; Liu et al., 2012).

Different stressors can modify the OA/TA system by enhancing *tβh* expression (Châtel et al., 2013), subsequently increasing OA levels (Kononenko et al., 2009), which, in turn, releases triglycerides and carbohydrates into the hemolymph (Woodring et al., 1989).

Upon starvation, behavior and metabolism are modified. General activity and arousal is enhanced (Connolly, 1966; Bell et al., 1985; Lee and Park, 2004) as well as food sensitivity (Moss and Dethier, 1983; Simpson et al., 1991; Colomb et al., 2009) correlated with an increase in sugar receptor neuron sensitivity and gene expression (Amakawa, 2001; Meunier et al., 2007; Nishimura et al., 2012). Several neuropeptides have been already identified to play a role (review: Nässel and Winther, 2010): NPF and dopamine as motivation signals (Krashes et al., 2009; Root et al., 2011), and dopamine as modulator of starvation-induced sugar response for short starvation periods (Inagaki et al., 2012).

Here, we investigated the involvement of the OA/TA system on starvation-dependent modulation of sugar responsiveness and metabolism. We measured the proboscis extension response and recorded sensillar response before and after starvation. Metabolism changes were quantified by carbohydrate measurements in fed and starved flies and by survival under starvation conditions.

## Methods

### Fly stocks and culture

*tβh<sup>nM18</sup>* (Monastirioti et al., 1996; FBal0061578), *oamb* (Han et al., 1998; OctαR, *oamb<sup>286</sup>* FBti0038368, *oamb<sup>584</sup>* FBti0038361), *honoka* (Kutsukake et al., 2000; Oct-TyrR, FBal0104701), *hsp-tβh* (Schwaerzel et al., 2003; FBal0152162) and w+;;UAS-*tβh* (Monastirioti, 2003; FBti0038601) were obtained from Henrike Scholz, Cologne; Hiromu Tanimoto, Martinsried; Andreas Thum, Konstanz; and Amita Seghal, Chevy Chase. Mutants that deleted large stretches of genomic DNA coding for the Octβ2R (CG6989; FBgn0038063) were generated by remobilization of FRT-containing P-elements, i.e. f05679 and f07155 excised 17,539 bp giving rise to deletion mutant *Octβ2R<sup>Δ3.22</sup>*; f00021 and f01537 excised 33,489 bp resulting in *Octβ2R<sup>Δ4.3</sup>*. Deletions were confirmed by genomic PCR. *TyrR<sup>f05682</sup>* (CG7431<sup>f05682</sup>, FBal0184987), *TyrRII<sup>Δ29</sup>* (CG16766, FBgn0038541) and *TyrRII-TyrR<sup>Δ124</sup>* were kindly provided prior to publication by Edward Blumenthal, Milwaukee (Zhang and Blumenthal, in preparation). Receptor mutants and their respective control lines were outcrossed for at least six generations into CS background.

Flies were kept on standard cornmeal/molasses-food in a 12/12 h light/dark cycle (light on at 8:00 hrs) at 60% relative humidity and 25°C except for *hsp-tβh* which were raised at 18°C without humidity control and except for flies used in electrophysiological experiments (see Electrophysiological recording).

### Starvation procedure

Newly hatched to one day old flies were collected and transferred to fresh food vials. The following day, between 16:00 and 19:00 hrs, 20 to 30 flies of mixed gender were transferred into starvation vials (68 ml, Greiner bio-one, Frickenhausen, Germany) by a fly aspirator. The starvation vial contained a cotton pad moistened with 2.5 to 3 ml of Evian® water. If not otherwise indicated, starvation was performed at 25°C and 60% relative humidity and lasted for 20 h.

### Survival experiments

Newly hatched to one day old flies were collected and transferred to fresh food vials. The following day, flies were briefly CO<sub>2</sub>-anesthetized and sorted by gender and genotype. At 17:00 hrs, around 20 female flies were transferred into a starvation vial (see Starvation procedure). Dead flies were counted every 3 h and not removed.

---

Daily counting sessions were repeated from 9:00 to 18:00 hrs, until all flies were found dead.

For the survival rescue attempt, fly vials with eggs were stored in an incubator without humidity control and heated up every 4 h to 37°C for 30 min until hatching. Temperature in between heat shocks ranged from 25 to 30°C. Hatched flies were collected and transferred to fresh food vials and kept in the incubator with continuing heat shocks every 4 h.

### **Sugar response test**

Newly hatched to one day old flies were collected and transferred to fresh food vials. The following day, they were starved as described (see Starvation procedure). Four hours before the end of the starvation period, female flies (if not stated otherwise) were briefly immobilized by cold-anesthesia. Their head and thorax were glued to a triangle-shaped copper hook (0.05 mm in diameter) using a UV sensitive glue (3M ESPE, Sinfony Indirect Lab Composite, Minneapolis, USA). Animals were then kept individually in small chambers (14 mm in diameter x 28 mm in height, custom-made) with *ad libitum* access to water until the test. *hsp-tβh* flies were glued before receiving the heat shock.

Tests were performed between 12:00 and 16:00 hrs. Using forceps, we transferred flies by their hook and fixed them to a magnetic clamp, which was then attached to a rack. This treatment established free movement of the flies' tarsi and proboscis and was a modification from a previously described PER assay (Scheiner et al., 2004) in order to prevent unnecessary stress and pressure on the abdomen of the flies. A group of six to eight flies was tested in parallel. A filter paper soaked with sucrose solution was presented for 5 s to all six tarsi but not the proboscis. Seven different concentrations (0, 0.1%, 0.3%, 0.6%, 1%, 3%, and 30%) were presented in series with an inter-stimulus interval of 80 s. The proboscis extension response was recorded. Finally, the proboscis was stimulated by 30% sucrose solution. Flies not responding to this last stimulation or responding to the first stimulation (water only) were discarded from the analysis.

For the first sugar response rescue attempt (Fig. 4A), flies were starved at 18°C and put into an incubator without humidity control and heated up to 37°C for 30 to 45 min. After the heat shock, flies were kept in a 25°C incubator with humidity control for 3 h until testing. For the second rescue attempt (Fig. 4B), the first heat shock was given

with beginning of starvation every 23 h for 45 min until one day before testing. Temperature in between heat shocks was 18°C.

### **PER assay validation**

As a positive control for the locomotion-independent sugar response assay, we tested the sugar response of wild type flies starved for 14 h versus 21 h (Colomb et al., 2009). There was a statistically significant increase in sugar response with the longer starvation regime ( $p = 0.041$ , Wilcoxon rank sum test,  $n = 48$ ; Damrau et al., 2014). We thus conclude that the assay is sensitive enough for detecting slight differences in sugar responsiveness.

### **Carbohydrate measurement**

Newly hatched to one day old flies were collected and transferred to fresh food vials. The following day at 17:00 hrs, 20 flies of mixed gender were either transferred into starvation vials (see Starvation procedure) or kept in the food vials. After 20 h, approximately 40 female flies per group were cold-anesthetized, pierced through the thorax by the tip of a dissecting needle (0.5 mm in diameter), and collected on ice within a sieve composed of two tubes. The hemolymph was centrifuged out of the fly into the bottom tube at 4°C. 0.5  $\mu$ l of the extracted hemolymph was transferred by a capillary (0.5  $\mu$ l, Hirschmann Laborgeraete, Eberstadt, Germany) into 19.5  $\mu$ l PBS (see Damrau et al., 2013). Trehalose and glucose content in the hemolymph was measured according to the protocols provided by the manufacturer (Sigma Aldrich, Seelze, Germany). 10  $\mu$ l of the hemolymph-PBS mixture were added to 30  $\mu$ l citric acid buffer (135 mM, pH 5.7 at 37°C) and 10  $\mu$ l of a trehalase enzyme solution (Sigma Aldrich, 3% in citric acid buffer). After incubation overnight at 37°C, 50  $\mu$ l of Tris buffer were added. 80  $\mu$ l of the resulting solution were added to 156.8  $\mu$ l Glucose oxidase and 3.2  $\mu$ l o-Dianisidine (Glucose Assay Kit, Sigma Aldrich) and incubated for 30 min at 37°C. Finally, 160  $\mu$ l of 33% sulfuric acid were added. Absorbance at 540nm was measured for the resulting solution using a nanoDrop® (nanoDrop Technologies, Wilmington, USA) spectrometer.

### **Electrophysiological recording**

Flies were raised on cornmeal-yeast-glucose-agar medium under a 12/12 h light/dark cycle (lights on at 06:00 hrs) at 25°C. Newly hatched to one day old flies were collected and transferred into a vial containing Kimwipe paper soaked with 100 mM glucose for

---

one to two days as previously described (Zhang et al., 2010). Starved flies were kept in a vial containing Kimwipe paper soaked with Evian® water for 20 h before testing. Electrophysiological recordings from I-type labellar chemosensilla were done by the tip-recording method, as previously described (Hodgson et al., 1955; Hiroi et al., 2002). Briefly, the proboscis was fixed at the base of the labellum. A glass capillary filled with *Drosophila* Ringer solution served as an indifferent electrode. 100 mM sucrose solution for stimulation contained 1 mM KCl as electrolyte. The recorded signals were digitized and analyzed using the custom software dbWave (Marion-Poll, 1995, 1996). Action potentials were detected by a visually-adjusted threshold set across the digitally filtered signal. The total number of spikes within 1 second was counted.

### Statistics

Figures and statistical analyses were performed in R (<http://r-project.org>). If not stated otherwise, data are illustrated as boxplots representing the median (line), the 25% and 75% quartiles (boxes), the data within 1.5 times the interquartile range (whiskers), and data outside that range (outliers, depicted as points).

The sugar response score was calculated as the sum of all positive responses over the seven sucrose presentations and therefore ranges from 0 to 7 (Total PER).

For survival measurement, the mean proportion of animals still alive was calculated over time. The LD50 for each tested group, i.e. the time point at which 50% of the flies were dead, was estimated using MASS-package in R.

Hemolymph carbohydrate content was read from a calibration curve showing the absorbance of standard glucose/ trehalose solutions that were treated identically to hemolymph. Change in sugar content was calculated as

$$(\text{intensity}_{\text{starved}} - \text{intensity}_{\text{fed}}) / (\text{intensity}_{\text{starved}} + \text{intensity}_{\text{fed}}).$$

The significance level of statistical tests was set to 0.05. Depending on data distribution, we used parametric (Welch Two-Sample t-Test or two-way ANOVA followed by TukeyHSD post hoc test) or non-parametric (Wilcoxon rank sum test or paired Wilcoxon rank sum test with Bonferroni correction) tests as depicted in the figure legends.

## Results

### *tβh<sup>nM18</sup>* mutants respond less to sucrose

First, we explored the involvement of OA and TA in the modulation of sugar responsiveness. We used *tβh<sup>nM18</sup>* mutant flies that lack OA and accumulate TA (Monastirioti et al., 1996), tethered them to a hook glued between head and thorax and tested their proboscis extension response to a serial dilution of sucrose after 20 h of starvation. The proportion of flies extending the proboscis increased with increasing sucrose concentration to reach almost 90% (Fig. 1A). *tβh<sup>nM18</sup>* mutant flies responded almost 40% less than their control (Fig. 1A). The sum of all positive responses over the 7 sucrose presentations was significantly different (Wilcoxon rank sum test,  $p = 2 \cdot 10^{-12}$ , Fig. 1B). These results suggest that *tβh*-expressing and consequently that OA and TA play a crucial role in controlling sugar responses under starvation conditions.

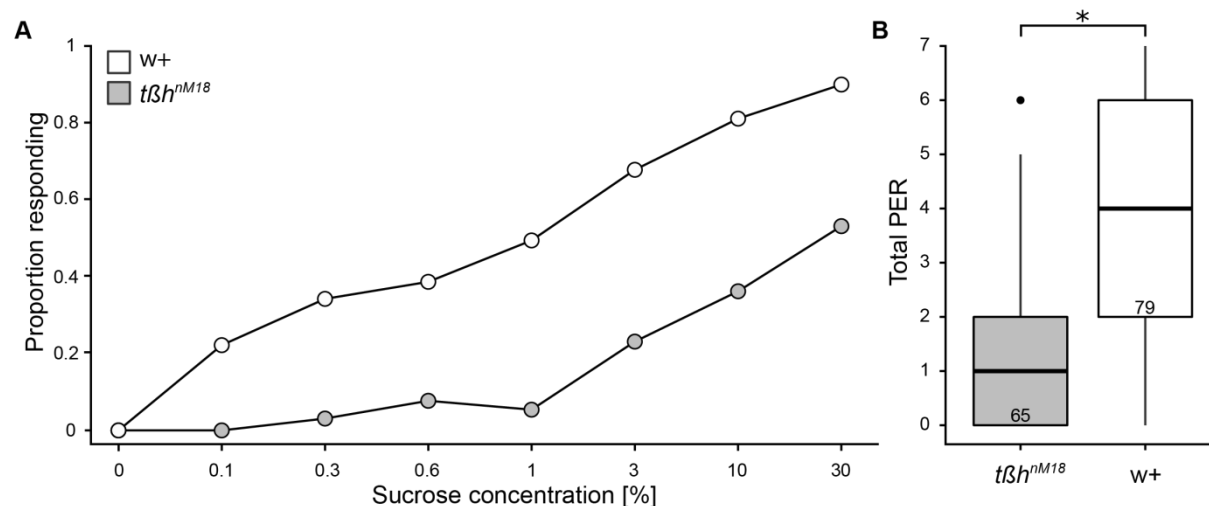

**Fig. 1:** *tβh<sup>nM18</sup>* mutant flies show a reduced sugar response compared to wild type flies after 20 h of starvation.

Proboscis extension response was measured in wild type ( $n = 79$ , white) and mutant flies ( $n = 65$ , grey). **A.** Fraction of flies that responded to several concentrations of sucrose. Data points indicate the mean. **B.** For each fly, we calculated a response score corresponding to the total number of all positive responses over the seven sugar presentations. This score is depicted in boxplots representing the median (bar), the 75%- and 25%-quartiles (box) and data within 1.5 times the interquartile range (whiskers). Data outside 1.5 times the interquartile range are considered as outliers (black dots). Numbers inside the boxes indicate sample sizes. The asterisk denotes significant difference between genotypes (Wilcoxon rank sum test,  $p < 0.05$ ).



## Physiological response to starvation is weaker in *tβh<sup>nM18</sup>* compared to wild type flies

In order to determine whether *tβh<sup>nM18</sup>* mutants might be less affected by starvation, we compared carbohydrate content (trehalose plus glucose) in the hemolymph of starved and fed flies. To this end, the hemolymph was extracted and all glucose and trehalose was enzymatically converted into spectrometrically measurable glucose. Trehalose is the “blood-sugar” in insects (Thompson, 2003) and is degraded under starvation conditions (Isabel et al., 2005; Meunier et al., 2007). Starvation treatment reduced the carbohydrate content in both, mutants and wild type flies (ANOVA: starvation  $p = 4 \times 10^{-6}$ ,  $F = 27.449$ , genotype  $p = 0.14$ ,  $F = 2.261$ , starvation x genotype  $p = 0.189$ ,  $F = 1.777$ , Fig. 2A). The change in carbohydrate level after starvation was significantly smaller in *tβh* mutants compared to wild type controls (Welch Two Sample t-Test,  $p = 0.0497$ , Fig. 2B).

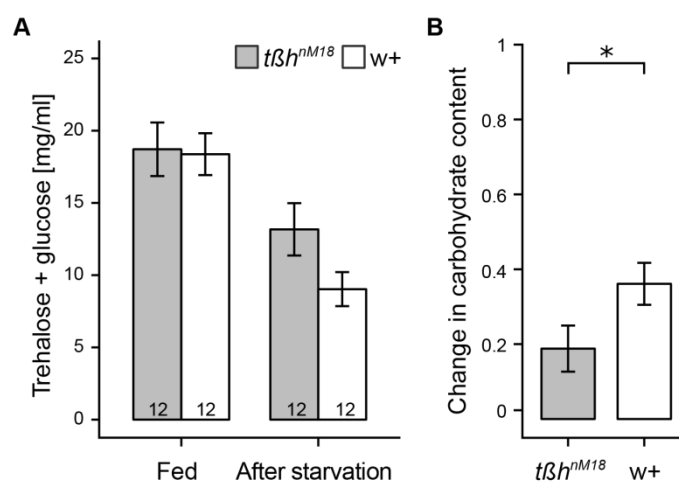

**Fig. 2: Change in hemolymph glucose and trehalose after starvation is smaller in *tβh<sup>nM18</sup>* mutants than in wild type.**

The trehalose and glucose content was measured in the hemolymph of fed and 20 h starved mutant (grey) and wild type (white) flies. **A.** The concentration of trehalose and glucose in hemolymph is calculated from the glucose absorbance at 540nm and shown as mean  $\pm$  SEM. Numbers in bars indicate sample size. **B.** The glucose absorbance in starved animals was normalized to the absorbance in fed animals for each genotype. The change in absorbance after starvation is shown as mean  $\pm$  SEM (Welch Two Sample t-Test,  $n = 12$ ,  $p < 0.05$ ).

As a second measure of starvation resistance, we recorded survival rate under starvation conditions with *ad libitum* access to water. As expected from their increased sugar content,  $t\beta h^{nM18}$  mutants survived longer than wild type controls (Wilcoxon rank sum test,  $p = 0.039$ , Fig. 3). The prolonged survival cannot be due to remaining eggs in the ovaries of  $t\beta h$  mutants (Partridge et al., 1987; Monastirioti, 2003) since we found the same survival effect on male  $t\beta h$  mutants (Fig. 7) and  $t\beta h$ -expression in mutant background did rescue egg-laying but not the survival phenotype (unpublished observations). Our experiments show that  $t\beta h^{nM18}$  mutants are less affected by starvation compared to wild type.

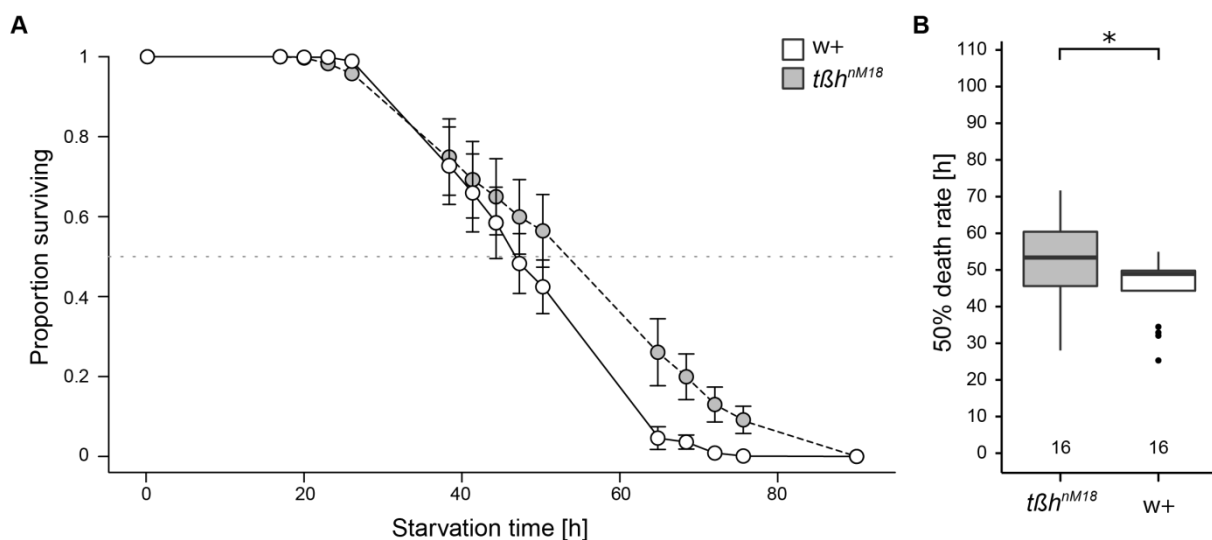
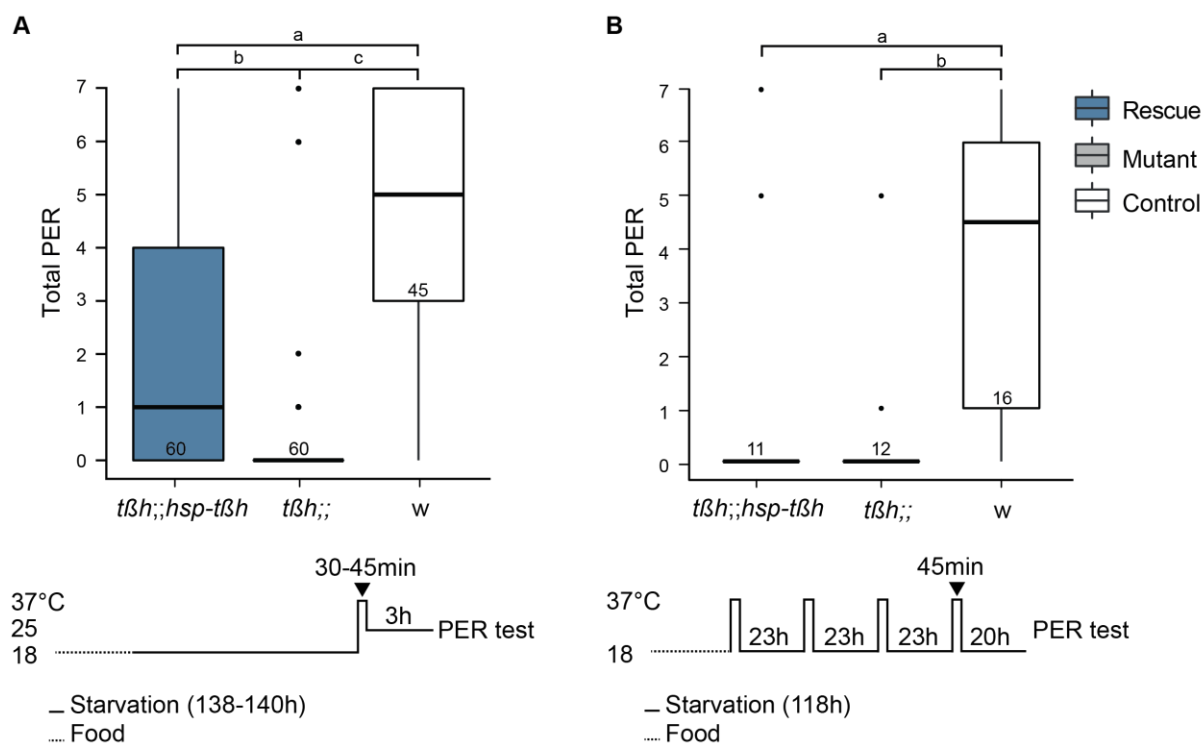

**Fig. 3:  $t\beta h^{nM18}$  mutants survive longer under starvation conditions.**

Survival under starvation conditions was determined by counting dead flies in vials containing either mutants ( $n = 16$ , grey) or wild type flies ( $n = 16$ , white) every 3 h at daytimes. **A.** Proportion of living animals per vial is depicted over time in mean  $\pm$  SEM ( $n = 16$ ). **B.** The time point of 50% death rate (LD50) is depicted as boxplots. The asterisk indicates significant difference between genotypes (Wilcoxon rank sum test,  $p < 0.05$ ). Numbers beneath boxes indicate sample size.

### Acute *tβh* induction rescues the sugar response phenotype

In order to rescue the *tβh*<sup>nM18</sup> mutant sugar response phenotype, we induced ubiquitous *tβh* expression in the mutant background at different time points by means of the heat-induced construct *hsp-tβh*. With heat shock-induced *tβh* expression 3 h before testing, we found an increase in the mutants' sugar response (paired Wilcoxon rank sum test, <sup>a</sup>p = 6\*10<sup>-5</sup>, <sup>b</sup>p = 0, <sup>c</sup>p = 4\*10<sup>-12</sup>, Fig. 4A). With heat shock-induced *tβh* expression exclusively during the starvation period, we did not find a rescue of the *tβh* mutant phenotype (paired Wilcoxon rank sum test with bonferroni correction, <sup>a</sup>p = 0.008, <sup>b</sup>p = 0, <sup>hsp-tβh x tβh</sup>p = 1, Fig. 4B). Those data indicate an acute role of the OA/TA system during sugar response.



**Fig. 4: *tβh* induction immediately before testing increases sucrose response in mutants.**

Total number of proboscis extension responses of wild type flies (white), mutants (grey), and mutants with *hsp-tβh* construct (blue) represented as boxplots. **A.** Temperature-induced ubiquitous expression of the *tβh* gene increases the sucrose responsiveness when expression is induced 3 h before testing. **B.** Inducing *tβh*-expression once a day during starvation but not before the test does not rescue the mutants' sucrose response phenotype. Small numbers within graph indicate sample sizes, small letters denote significant difference between groups (paired Wilcoxon rank sum test, p < 0.05)

### Sensitivity of taste receptor neurons is lower in *tβh<sup>nM18</sup>* mutants

OA is known to modulate different kinds of receptors in insects (Kass et al., 1988; Ramirez and Orchard, 1990; Pophof, 2000). In order to test a potential role of OA on gustatory receptor sensitivity we recorded the response of labellar sensilla to 100 mM sucrose of fed and starved flies by the tip-recording method (Hodgson et al., 1955; Hiroi et al., 2002). We found a decreased sensillar response to sucrose stimulation after starvation in *tβh<sup>nM18</sup>* mutants, compared to wild type controls (Fig. 5A, Wilcoxon rank sum test,  $p = 0.008$ ). The increase of spiking rate after starvation seems to underlie great genetic variation since different wild types exhibit different phenotypes (Fig. 5B, Wilcoxon rank sum test,  $^{w1118}p = 0.039$ ,  $^{CantonS}p = 0.001$ ; (Meunier et al., 2007; Inagaki et al., 2012; Nishimura et al., 2012).

Those data indicate a role of the OA/TA system in the starvation-dependent modulation of receptor potentials.

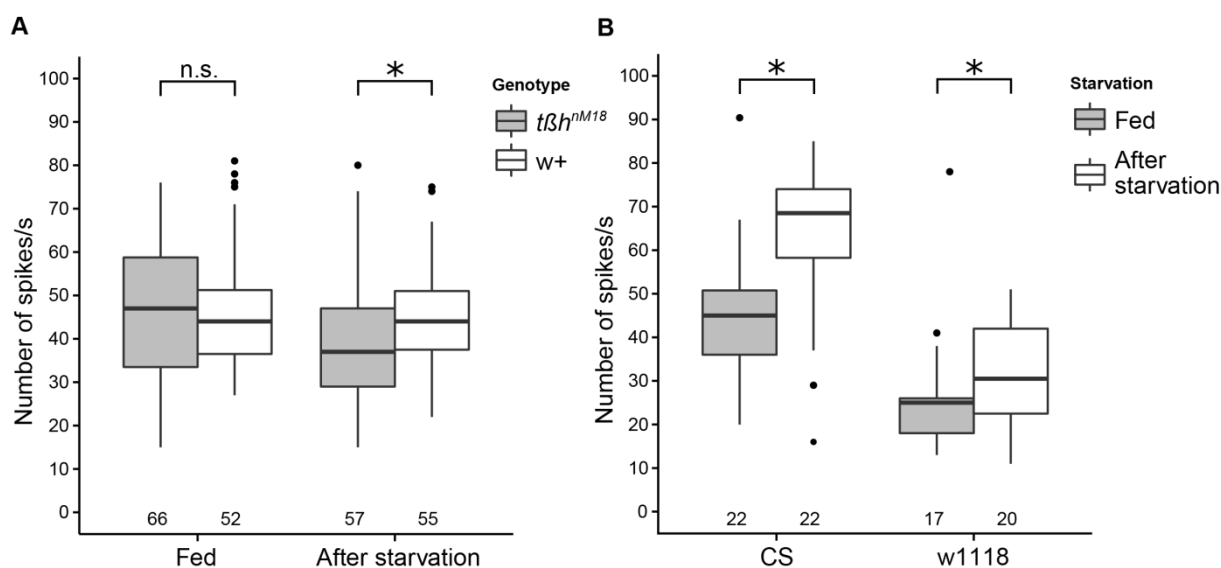

**Fig. 5: Effect of starvation on taste neuron sensitivity.**

Electrophysiological recording from different gustatory sensilla on the labellum **A.** in sated and starved *tβh<sup>nM18</sup>* mutants (grey) and controls (white) and **B.** in sated (white) and starved (grey) wild type flies. Extracellular action potentials within 1 s after stimulation onset were counted and plotted as boxplots. Numbers represent the sample size of the recorded sensilla; asterisks indicate statistical differences between groups (Wilcoxon rank sum test,  $p < 0.05$ ).

## Differential outcome of O/TA-receptor manipulations on survival and sugar responsiveness

Because the *tβh* mutation leads to increased TA and decreased OA levels (Monastirioti et al., 1996), we performed additional experiments to disentangle the relative importance of each amine in the regulation of survival and sugar response. We tested published and novel mutants for several OA- and TA-receptors in our PER and survival under starvation conditions assays (Fig. 6, Table 1).

*TyrR*<sup>f05682</sup> was generated by piggyback transposition (Thibault et al., 2004), real-time PCR revealed a 100-fold decrease of mRNA transcript (Zhang and Blumenthal, submitted). *TyrRII*<sup>Δ29</sup> and the double mutant *TyrRII-TyrR*<sup>Δ124</sup> are deletion mutants of 13567316-13576610 and the entire region 13567316-13579400, respectively. *TyrRII* has low mRNA transcript levels such that quantification of mutant levels is not possible (Zhang and Blumenthal, submitted). *Octβ2R*<sup>Δ3.22</sup> and *Octβ2R*<sup>Δ4.3</sup> are deletion mutants of 17,539 bp and 33,489 bp, respectively. Deletions were confirmed by genomic PCR. *oamb* and *honoka* were described elsewhere (Han et al., 1998; Kutsukake et al., 2000).

The two TA-receptor mutants *TyrR*<sup>f05682</sup> and *honoka* showed a decreased sugar response (Wilcoxon rank sum test with correction for multiple measurements, *TyrR*<sup>f05682</sup> *p* = 0.003, *honoka* *p* = 0.012) and an increased survival (*TyrR*<sup>f05682</sup> *p* = 0.002, *honoka* *p* = 0.009) comparable to *tβh*<sup>nM18</sup> mutants. Interestingly, the two phenotypes could be decorrelated indicated by the differential behavioral outcome of the tested receptors: *Octβ2R* and the double mutant *TyrRII-TyrR*<sup>Δ124</sup> show an increase in survival (*Octβ2R*<sup>Δ3.22</sup> *p* = 0.001, *Octβ2R*<sup>Δ4.3</sup> *p* = 0.021, *TyrRII-TyrR*<sup>Δ124</sup> *p* = 0.015) and a normal sugar response (*Octβ2R*<sup>Δ3.22</sup> *p* = 0.825, *Octβ2R*<sup>Δ4.3</sup> *p* = 0.06), while *TyrRII*<sup>Δ29</sup> shows normal survival (*p* = 0.354) and a decrease in sugar response (*p* = 0.007). Finally, the *oamb* mutants showed no phenotype at all (survival: *oamb*<sup>286</sup> *p* = 0.397, *oamb*<sup>584</sup> *p* = 0.867; sugar response: *oamb*<sup>286</sup> *p* = 0.506, *oamb*<sup>584</sup> *p* = 0.388), in contrast to a previously published report (Erion et al., 2012). The receptor mutant data suggest that flies can exhibit a wild type survival simultaneously with a lower sugar response (*TyrRII*<sup>Δ29</sup>), or a higher survival simultaneously with a wild type sugar response (*Octβ2R*<sup>Δ3.22</sup> and *Octβ2R*<sup>Δ4.3</sup>). This indicates that starvation affects sugar responsiveness and survival via different pathways.

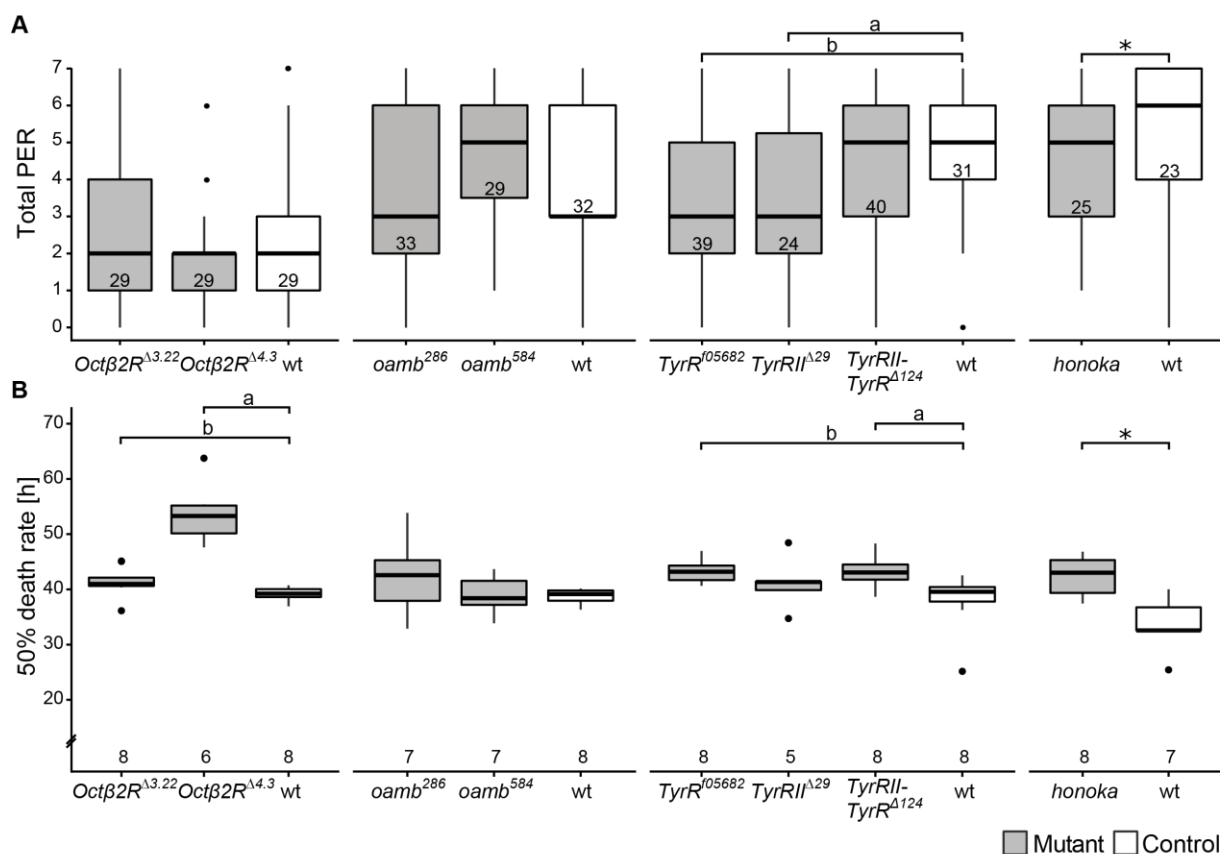

**Fig. 6: TA- and OA-receptor mutants are differently affected in survival and sucrose response.**

Female TA or OA-receptor mutants (grey) and their respective genetic background control (white) are tested in sucrose response (A) or survival (B). **A.** The total number of proboscis extensions to sucrose in *Octβ2R<sup>Δ3.22</sup>* and *Octβ2R<sup>Δ4.3</sup>* is later. Neither of the *oamb* mutants shows a change in survival. *TyrR<sup>f05682</sup>*, *honoka*, and the double mutant *TyrRII-TyrR<sup>Δ124</sup>* survive longer. *TyrRII<sup>Δ29</sup>* is not affected. Small numbers within graph indicate sample sizes, small letters or asterisks indicate significant difference between regarding receptor mutant and the control (Wilcoxon rank sum test,  $p < 0.05$ ).

**Table 1: TA- and OA-receptor mutants are differently affected in survival and sugar response.**

Horizontal arrows indicate no effect. Arrows indicate significant difference to respective control and illustrate the trend of the data.

|                     |                                   | Survival | Sugar response |
|---------------------|-----------------------------------|----------|----------------|
| <b>TA-receptors</b> | <i>TyrR<sup>f05682</sup></i>      | ↑        | ↓              |
|                     | <i>TyrRII<sup>Δ29</sup></i>       | —        | ↓              |
|                     | <i>TyrRII-TyrR<sup>Δ124</sup></i> | ↑        | —              |
|                     | <i>honoka</i>                     | ↑        | ↓              |
| <b>OA-receptors</b> | <i>oamb<sup>286</sup></i>         | —        | —              |
|                     | <i>oamb<sup>584</sup></i>         | —        | —              |
|                     | <i>Octβ2R<sup>Δ3.22</sup></i>     | ↑        | —              |
|                     | <i>Octβ2R<sup>Δ4.3</sup></i>      | ↑        | —              |

### Neuronal and non-neuronal *tβh* expression rescues PER

OA and TA act both inside and outside of the nervous system, functioning as either a neurotransmitter or -hormone in insects (Cole et al., 2005). Thus, we explored whether the sugar response phenotype of *tβh* mutants was a result of alterations in neurons inside or outside of the brain or in non-neuronal cells. For this experiment, we expressed UAS-*tβh* in *tβh<sup>nm18</sup>* mutant males driven by different GAL4-lines. We found a significant increase in sugar response compared to the respective mutant control when we used the ubiquitous Actin-promoter (Wilcoxon rank sum test,  $p = 0.016$ , Fig. 7), the pan-neuronal nSyb-promoter ( $p = 0.013$ , Fig. 7), or the non-neuronal Tdc1-GAL4 driver (Cole et al., 2005) ( $p = 0.028$ , Fig. 7). In contrast, *tβh* expression in subsets of OA/TA neurons in thoracic nerve cord and the brain by using either Tdc2- or NP7088-GAL4 did not significantly affect the mutants' response ( $Tdc2$   $p = 0.098$ ,  $NP7088$   $p = 0.58$ , Fig. 7) in contrast to a previous report (NP7088-Gal4, Scheiner et al., 2014). These results indicate that *tβh* expression induced in neurons in the central nervous system as well as in non-neuronal cells is sufficient to enhance the sugar responsiveness of *tβh<sup>nm18</sup>* mutant flies.

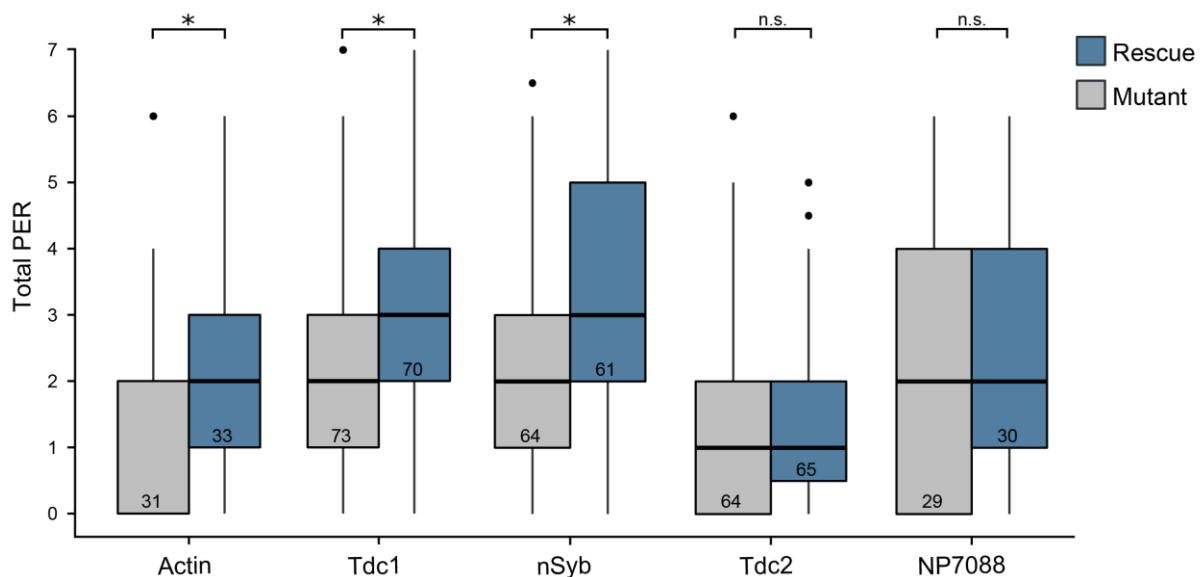

**Fig. 7: Spatial rescues of the *tβh<sup>nm18</sup>* mutant.**

Total number of proboscis extensions of GAL4-controls (grey) and the same GAL4-lines expressing UAS-*tβh* (blue), both in *tβh* mutant background, illustrated as boxplots. *tβh* expression in mutant background could increase the sugar response when expressed using Actin-GAL4, Tdc1-GAL4, and nSyb-GAL4 but not when expressed using Tdc2-GAL4 or NP7088-GAL4. Small numbers in boxes indicate sample sizes. Asterisks denote significant difference between mutant and rescue group (Wilcoxon rank sum test,  $p < 0.05$ ).

---

## Discussion

We used genetic alterations of OA and TA to elucidate the role of OA and TA in survival and sugar responsiveness of fruit flies. Our data suggest complex and multiple central and peripheral actions of these amines on physiology and behavior.

### OA/TA and proboscis extension response

The *tβh<sup>nM18</sup>* mutant proboscis extension response to sucrose after 20 h of starvation was reduced compared to controls. Previous studies did not report a sugar sensitivity phenotype of the *tβh<sup>nM18</sup>* and *oamb<sup>286</sup>* mutants (Schwaerzel et al., 2003; Kim et al., 2013), probably because the T-maze assay they were using is lacking sensitivity (Colomb et al., 2009). Alternatively, the phenotype might not be visible in this assay because of the locomotion phenotype of *tβh<sup>nM18</sup>* mutants (Saraswati et al., 2004; Fox et al., 2006; Koon et al., 2011; Damrau et al., in preparation). Indeed, a role of OA and TA in sugar sensitivity has been demonstrated before in *Drosophila* (Scheiner et al., 2014) and *Apis mellifera* (Buckemüller et al., in preparation) using locomotion-independent assays. Because appetitive conditioning is dependent on prior starvation, these data suggest that previous reports on the role of OA during appetitive conditioning (Schwaerzel et al., 2003; Kim et al., 2013) may have to be re-evaluated.

### OA/TA and metabolism

Sugar response is dependent on starvation (Colomb et al., 2009; Damrau et al., 2014a). A decreased sugar response as found in *tβh<sup>nM18</sup>* mutants could be due to a decreased sensitivity to our starvation treatment. Corroborating this hypothesis, we found that the levels of carbohydrates in the hemolymph of *tβh<sup>nM18</sup>* mutant flies are higher after starvation than in control flies. Since trehalose constitutes the energy store of a fly and its hemolymph concentration reflects starvation level (Thompson, 2003), it is reasonable to argue that the mutant flies were affected less by the starvation treatment than the controls even though they were deprived of food for the same amount of time. This interpretation is also supported by longer survival of *tβh<sup>nM18</sup>* mutants under starvation conditions, a result which was recently reproduced (Damrau et al., 2012; Scheiner et al., 2014). Complementing our analysis in flies, injection of the OA-receptor antagonist epinastine in honeybees also prolonged



---

survival (Buckemüller et al., in preparation). Taken together, these results suggest that the absence of OA-signaling saves the mutant animal's energy, making them less sensitive to starvation, a conclusion in line with previous reports on the role of OA in triglyceride (Woodring et al., 1989; Erion et al., 2012) and carbohydrate (Blau et al., 1994; Park and Keeley, 1998) metabolism.

### **Acute OA/TA effect rescues mutant sugar responsiveness**

From the results thus far, one would expect that increasing *tβh* synthesis would increase sugar response and decrease hemolymph carbohydrates.

Our temporal rescue experiments revealed that *tβh* expression exclusively during starvation and not the test did not increase the PER (Fig. 4B). We performed the complementary experiment showing that acute *tβh* expression is sufficient to increase the PER (Fig. 4A) even if *tβh* was not available during starvation, i.e., hemolymph carbohydrate levels have been high during the entire starvation time until the day before testing. This result suggests that the decrease of carbohydrate levels is not the only starvation-induced alteration that leads to a normal PER but that probably a second OA/TA-dependent mechanism has to be engaged during test. In addition to the internal state that is altered by starvation, the likelihood to extend the proboscis or the sensory input, or both may be modified.

### **OA/TA and gustatory receptor sensitivity**

We recorded from taste sensilla in order to test whether the sensory input from sugar stimuli was altered in *tβh<sup>nm18</sup>* mutant flies and found that *tβh<sup>nm18</sup>* mutants showed a lower sensillar response to sucrose than control flies after 20 h of starvation (Fig. 5A). In fact, one can even observe a decrease in the spike frequency of the sensilla in the mutants, while the spike frequency of the control animals remained constant. Starvation can lead to an increased sensitivity of the gustatory receptors (Meunier et al., 2007; Nishimura et al., 2012), and OA/TA is able to modulate sensory neuron activity (Braun and Bicker, 1992; Erber and Kloppenburg, 1995; Kloppenburg and Erber, 1995; Pophof, 2000; de Haan et al., 2012). Here, control flies increased their proboscis extension (Fig. 1) but not their sensillar sensitivity (Fig. 5A) after starvation. That indicates that the sensillar sensitivity is not the only modulated pathway by the

---

OA/TA system. We rather think that there has to be a second OA/TA-independent pathway that underlies genetic variance.

### **Receptor mutant analysis uncoupled physiological from behavioral effects of starvation**

The *tβh* enzyme converts TA into OA such that *tβh<sup>nM18</sup>* mutants not only lack OA but also accumulate TA (Monastirioti et al., 1996). To disentangle the roles of the two amines, we tested known and newly generated OA- or TA-receptor mutants in our assays (Fig. 6). Our companion paper (Buckemüller et al., in preparation) demonstrates a PER reduction after OA-receptor antagonist injection in starved honeybees. However, we find no effect of the tested OA-receptor mutations on sugar response, suggesting an exclusive contribution of other OA-receptors, e.g. Octβ3R which was found to be involved in larval feeding response (Zhang et al., 2013).

Our results show that flies can exhibit starvation resistance comparable to the wild type controls but with a lower sugar response (*TyrRI<sup>A24</sup>*), or a higher starvation resistance than wild type controls but with a normal sugar response (*Octβ2R<sup>A3.22</sup>* and *Octβ2R<sup>A4.3</sup>*). These findings strongly suggest that starvation resistance and sugar response are not mediated by the same OA/TA cells and receptors, but by different sub-populations. In addition, the data show that both OA and TA play a role in starvation-induced sugar response. The performance trend of OA- and TA-receptor mutants goes into the same direction, such that they are probably not counteracting each other, as previously suggested for crawling behavior (Saraswati et al., 2004).

### **Where is the O/TA action site?**

In order to define responsible cells contributing to the behavioral response to sucrose and the metabolic response to starvation, we rescued *tβh* in different O/TA subsets inside or outside the nervous system, using the GAL4-UAS system (Fig. 7). The Tdc1-GAL4-driver is *tβh*-negative (Monastirioti et al., 1995) and expresses non-neuronally e.g. in the crop and the hind gut (Cole et al., 2005; Chintapalli et al., 2007; Blumenthal, 2009). Driving the UAS-*tβh* expression by Tdc1-GAL4 rescues the *tβh<sup>nM18</sup>* mutant phenotype. Because OA-action in non-*tβh* cells is unlikely this rescue is probably due to decreased TA-levels, indicating a role of non-neuronal, TA-specific cells in peripheral tissues on eliciting a wild type-like PER. TA-signaling may be

involved in mediating the metabolic signal of starvation in non-neuronal tissues is probably independent of the OA/TA system in the brain acting on receptor sensitivity.

## **Conclusions**

Taken together with the experiments from our accompanying paper (Buckemüller et al., in preparation), our results suggest that the OA/TA system is involved in both the physiological and the behavioral changes that follow starvation, and that these changes are regulated independently. They also show that the behavioral change is not only due to a modulation of the taste neuron activity and to action of TA-specific cells in peripheral organs, but to a more central effect is additionally in play.

## CHAPTER 2: SPECIFIC DOMINANCE OF THE *DROSOPHILA* *tβh* GENE IN DIFFERENT BEHAVIORAL TASKS

<sup>1</sup>Christine Damrau, <sup>2</sup>Björn Brembs\*, <sup>1</sup>Julien Colomb

<sup>1</sup>Freie Universität Berlin, Fachbereich Biologie-Chemie-Pharmazie, Institut für Biologie, Neurobiologie, Königin-Luise-Straße 28-30, 14195 Berlin, Germany

<sup>2</sup>University of Regensburg, Institute of Zoology – Neurogenetics, Universitätsstraße 31, 93040 Regensburg, Germany

\*Author of correspondence (bjoern@brembs.net)

### Acknowledgements

We are grateful to DFG for funding, to Henrike Scholz, Hiromu Tanimoto, Andreas Thum, Sabrina Scholz-Kornehl and Amita Seghal for providing flies, to Edward Blumenthal for sharing data prior to publication, to Hildegard Hopp, Yasmine Graf, Julia Sigl, Lucie Dieterich and Luise Krüger for technical assistance, and to the workshop of Freie Universität Berlin for building the machines.

### Abstract

The biogenic amine octopamine (OA) and its precursor tyramine (TA) are involved in controlling a plethora of different physiological and behavioral processes. The tyramine-β-hydroxylase (*tβh*) gene codes for the enzyme catalyzing the last synthesis step from TA to OA in *Drosophila*. Here, we report differential dominance (from recessive to overdominant) of the putative null *tβh*<sup>nM18</sup> allele in two behavioral measures in Buridan's paradigm (walking speed and stripe deviation) and a proboscis extension assay (sugar response after starvation). The analysis of *tβh* overexpression in mutant and wild type flies as well as in OA- and TA-receptor mutants revealed a complex interaction of both aminergic systems in the control of locomotion. Our analysis suggests that the different neuronal networks responsible for the three phenotypes show different sensitivity to *tβh* gene dosage.

---

## Introduction

Insect locomotion has been intensively investigated in electrophysiological studies in locusts, cockroaches and crickets. The biogenic amine octopamine (OA) structurally and functionally related to the vertebrate's noradrenaline (David and Coulon, 1985) was shown to play an important role in initiation and maintenance of motor programs (Sombati and Hoyle, 1984; Baudoux et al., 1998; Duch et al., 1999; Ridgel and Ritzmann, 2005; Gal and Libersat, 2010).

OA targets comprise both neurons (Bräunig and Eder, 1998) and muscles (Orchard and Lange, 1985; Bräunig, 1997). In skeletal muscles, OA was shown to act not only on the muscle tension (Evans and O'Shea, 1977) and relaxation rate (Evans and Siegler, 1982), but also on its metabolism: As a neurohormone being released into the hemolymph, it mobilizes lipids and stimulates glycolysis (Blau et al., 1994; Candy et al., 1997).

OA is synthesized from the neuromessenger tyramine (TA) by tyramine- $\beta$ -hydroxylase (*t $\beta$ h*, Wallace, 1976). In *Drosophila*, the *t $\beta$ h<sup>nM18</sup>* mutant has proved to be an important tool to understand the role of TA and OA in egg laying (Monastiriotti et al., 1996), aggression (Zhou et al., 2008), flight (Brembs et al., 2007), and sugar responsiveness (Damrau et al., submitted). In *Drosophila* larval locomotion, both *iav* mutants lacking OA and TA (O'Dell and Burnet, 1988) and *t $\beta$ h<sup>nM18</sup>* mutants lacking OA and accumulating TA (Saraswati et al., 2004; Koon et al., 2011; Selcho et al., 2012) crawl slower. Interestingly, TA and OA have opposite effects on larval muscle contraction (Ormerod et al., 2013) and crawling behavior (Saraswati et al., 2004; Fussnecker et al., 2006). Locomotion in fly adults was much less studied and results are conflicting: *Tdc<sup>RO54</sup>* mutants lacking OA and TA exhibited reduced locomotor activity (Hardie et al., 2013) whereas a TA receptor mutant (Kutsukake et al., 2000) and the *t $\beta$ h<sup>nM18</sup>* mutant showed normal locomotor activity in one study (Hardie et al., 2013), while other studies showed a locomotion defect for *t $\beta$ h<sup>nM18</sup>* mutants (Scholz, 2005; Wosnitza et al., 2013).

Since OA is involved in almost every physiological process (Roeder, 2005), we conclude that the *t $\beta$ h* gene has pleiotropic effects. Those are evolutionary relevant by maintenance of genetic variability in the population (Turelli and Barton, 2004; Lawson et al., 2011). Pleiotropic loci often exhibit differential dominance (Klingenberg et al., 2001) and dominance effects can correlate with gene dosage for example by leading to differential sensitivity of cells to gene deletions (Gergen and Wieschaus, 1986).

Here, we examine the effect of the *tβh<sup>nM18</sup>* mutation in adult walking behavior in the Buridan's paradigm (Bülthoff et al., 1982; Colomb et al., 2012). Additional to walking speed, the fixation of the fly towards two opposite stripes was measured. Fixation of such visual cues is suggested to be a taxis behavior dependent on motion sensitivity. Fixation is indeed increased at higher contrast conditions (Osorio et al., 1990; Riemensperger et al., 2011). Interestingly, the sensitivity of the motion-sensitive cells was shown to increase when the fly is walking (Chiappe et al., 2010) or flying, the latter effect was suggested to be OA dependent (Suver et al., 2012).

## Methods

### Fly strains

*tβh<sup>nM18</sup>* (Monastirioti et al., 1996; FBal0061578), *oamb* (Han et al., 1998; OctαR, *oamb<sup>286</sup>* FBti0038368, *oamb<sup>584</sup>* FBti0038361), *honoka* (Kutsukake et al., 2000; Oct-TyrR, FBal0104701), *hsp-tβh* (Schwaerzel et al., 2003; FBal0152162), *Octβ2R<sup>A3.22</sup>* and *Octβ2R<sup>A4.3</sup>* (Damrau et al., 2014; CG6989, FBgn0038063), and *w+;;UAS-tβh* (Monastirioti, 2003; FBti0038601) were obtained from Henrike Scholz, Cologne; Hiromu Tanimoto, Martinsried; Andreas Thum, Konstanz; Martin Schwärzel, Berlin; and Amita Seghal, Chevy Chase. *TyrR<sup>f05682</sup>* (CG7431<sup>f05682</sup>, FBal0184987), *TyrRII<sup>Δ29</sup>* (CG16766, FBgn0038541) and *TyrRII-TyrR<sup>Δ124</sup>* were kindly provided prior to publication by Edward Blumenthal, Milwaukee. Receptor mutants and their respective control lines were outcrossed for at least six generations into CS background.

### Fly care

Flies were kept on standard cornmeal/molasses-food in a 12/12 h light/dark cycle at 60% relative humidity and 25°C except for *hsp-tβh* and *elaV-GAL4;tub-GAL80* crosses which were kept at 18°C without humidity control.

After hatching, experimental flies were collected into new food vials for two days. The day before testing, flies were CO<sub>2</sub>-anesthetized, sorted by gender (females except for *UAS-tβh* experiments), and their wings were clipped at two thirds of their length. If not stated otherwise, animals recovered in the food vials overnight. Individuals were captured using a fly aspirator and transferred into the experimental setup.

### **Heat protocols**

*hsp-t3h* flies were heat shocked for 30-45 min at 37°C with 3-4 h recovery time at 25°C before testing. *elaV-GAL4;tub-GAL80;UAS-Tdc2* flies were heated at 33°C overnight with 30 min recovery time at RT before testing.

### **Buridan's paradigm**

We used the Buridan's setup to test fly locomotion, details are described in Colomb et al. (2012). Briefly, two black opposite stripes (30 mm in width and 320 mm in height) were positioned 293 mm from the center of a platform (117 mm in diameter) surrounded by water and illuminated with bright white light from behind. The centroid position of the fly was recorded by custom tracking software (BuriTrack, <http://buridan.sourceforge.net>). If a fly jumped out of the platform, it was returned by a brush, and the tracker was restarted. All data are obtained from 5 min of uninterrupted walk or the first 5 min of a 15 min walk.

Data were analyzed using CeTrAn v.4 (<https://github.com/jcolomb/CeTrAn/releases/tag/v.4>) as previously described in Colomb et al. (2012). Briefly, walking speed was measured in traveled distance over time. A median was calculated for the progression of one experiment; the mean of all medians is reported in the graphs. Speeds exceeding 50 mm/s are considered to be jumps and are not included in the median speed calculation (Colomb et al., 2012). Stripe deviation acted as a metric for fixation behavior. It corresponds to the angle between the velocity vector and a vector pointing from the fly position towards the center of the front stripe. (for details see Colomb et al., 2012). The platform inside the arena was cleaned with 70% ethanol after each experiment to minimize nonspecific effects.

### **Sugar sensitivity test**

Sugar response was measured as described elsewhere (Damrau et al., in preparation). Briefly, flies were starved for 20 h with Evian® water. Immobilized by cold-anesthesia, a triangle-shaped copper hook was glued to head and thorax. 3 h later, the hook was attached to a rack so that free movement of flies' tarsi and proboscis was enabled. A filter paper soaked with sucrose solution was presented to all the tarsi. The proboscis extension response to a serial dilution of sucrose (0, 0.1%, 0.3%, 0.6%, 1%, 3% and 30%) was recorded. The total number of the fly's responses to all sucrose stimulations of increasing concentration was calculated (Scheiner et al., 2004). Finally, the proboscis was stimulated by 30% sucrose

---

solution. Flies not responding to proboscis stimulation or responding to the first stimulation (water only) were discarded from the analysis.

### Statistics

The mean walking speed was calculated out of medians (see Buridan's paradigm) and plotted with the standard error of the mean. Sucrose response and stripe deviation are exhibited as boxplots representing the median (bar), the 25%-75% quantiles, data within (whiskers) and outside (outliers as black dots) the 1.5 times interquartile range IQR. Statistical analyses were performed in R. Walking speed data followed normal distribution whereas stripe deviation did not (Shapiro-Wilk test of normality,  $p < 0.05$ ) so that we used the parametric Two-way ANOVA followed by TukeyHSD post hoc test and Welch Two-Sample t-Test, respectively, or non-parametric paired Wilcoxon rank sum test with bonferroni-correction and Wilcoxon rank sum test, respectively. The p-value was additionally corrected for two repeated measurements of data achieved from Buridan's paradigm. Sample size of each group is indicated within the graphs.

## Results

### Differential dominance of $t\beta h^{nM18}$ mutation for different behavioral parameters

We examined the effects of the  $t\beta h^{nM18}$  mutation at different zygosityes in two assays. We analyzed walking behavior in Buridan's assay (Bülthoff et al., 1982; Colomb et al., 2012), reporting the median speed and the stripe deviation parameters; as well as sugar response after 20 h of starvation in a proboscis extension assay (Damrau et al., in preparation).

While homozygous mutants showed a phenotype for the three parameters, heterozygotes showed the opposite phenotype for walking speed (Fig. 1A), an intermediate phenotype for stripe deviation (Fig. 1B) and a mutant phenocopy for sugar response (Fig. 1C).

To exclude that these effects were due to specificity of the W+ genetic background, we repeated the locomotion experiment with flies on a different genetic background. We examined  $t\beta h$  hemizygous mutant and control males resulting from a cross with another wild type background. We found the same walking speed and stripe



deviation phenotypes for *tβh* mutants in the *W+/CantonS*-background ( $p < 0.05$ ,  $n = 34$ , Welch Two-Sample t-Test for speed, Wilcoxon rank sum test for stripe deviation; Damrau et al., 2014).

Thus, we demonstrated that *tβh* plays a role in locomotion behavior and sugar response of adult *Drosophila* and that the heterozygous *tβh<sup>nM18</sup>* mutation differentially affects the three behavioral traits.

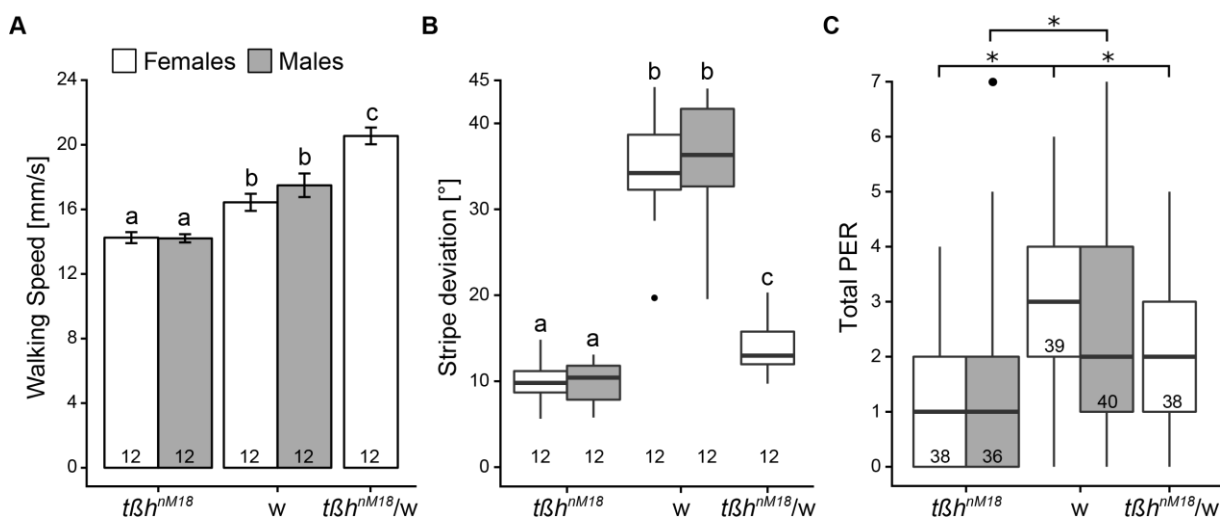

**Fig. 1: Differential dominance of *tβh<sup>nM18</sup>* mutation for different phenotypes.**

Homo-, hetero- and hemizygous *tβh* mutant and their control were tested in Buridan's paradigm and the sugar sensitivity test. **A**. Median walking speed during Buridan's experiment. Homozygous *tβh<sup>nM18</sup>* mutants walk slower than the wild type control, whereby heterozygous mutants walk faster than wild type (two-way ANOVA followed by TukeyHSD post hoc test,  $p < 0.05$ ). Hemizygous mutant males walk slower than wild type males (Welch Two-Sample t-Test,  $p < 0.05$ ). **B**. Stripe deviation, a measure of stripe fixation during walking, is reduced in homozygous *tβh<sup>nM18</sup>* mutants compared to heterozygous mutants and wild type (paired Wilcoxon rank sum test with bonferroni correction for repeated measurement,  $p < 0.05$ ) as well as in hemizygous males compared to their wild type control (Wilcoxon rank sum test,  $p < 0.05$ ). **C**. The total number of proboscis extension response to a serial dilution of sucrose after 20 h of starvation was calculated. Homozygous and hemizygous *tβh<sup>nM18</sup>* mutants respond less to sucrose compared to the wild type control; heterozygous mutants respond less than wild type and not differently from homozygous mutants. Significant differences are tested by paired Wilcoxon rank sum test with bonferroni correction ( $p < 0.05$ ).

In **A**, bars and error bars indicate mean and standard error of the mean. In **B** and **C**, the Tukey boxplots represent the median (bar), 25%-75% quartiles (boxes), and total data range (whiskers) excluding outliers outside of the 1.5 times the interquartile range (points). Numbers within graphs indicate sample size. Bars and boxes labeled with different letters are statistically significantly different, asterisks indicate statistically significant differences.

## GAL4-UAS-dependent rescue had no effect

According to standard procedures and similarly to the successful attempt for the sugar phenotype (Damrau et al., in preparation), we tried to rescue the *tβh* phenotype by driving UAS-*tβh* in different cells in *tβh* mutant males. Surprisingly, neither the ubiquitous expression by Actin-GAL4, nor the pan-neuronal expression by nSyb-GAL4, nor the expression in TA/OA subsets by Tdc2- or NP7088-GAL4 or in TA non-neuronal cells by Tdc1-GAL4 could rescue the mutant phenotypes in walking speed or stripe deviation (Fig. 2). The score of the rescue group was indeed worse than the mutant control groups, whose phenotypes were sometimes at wild type levels.

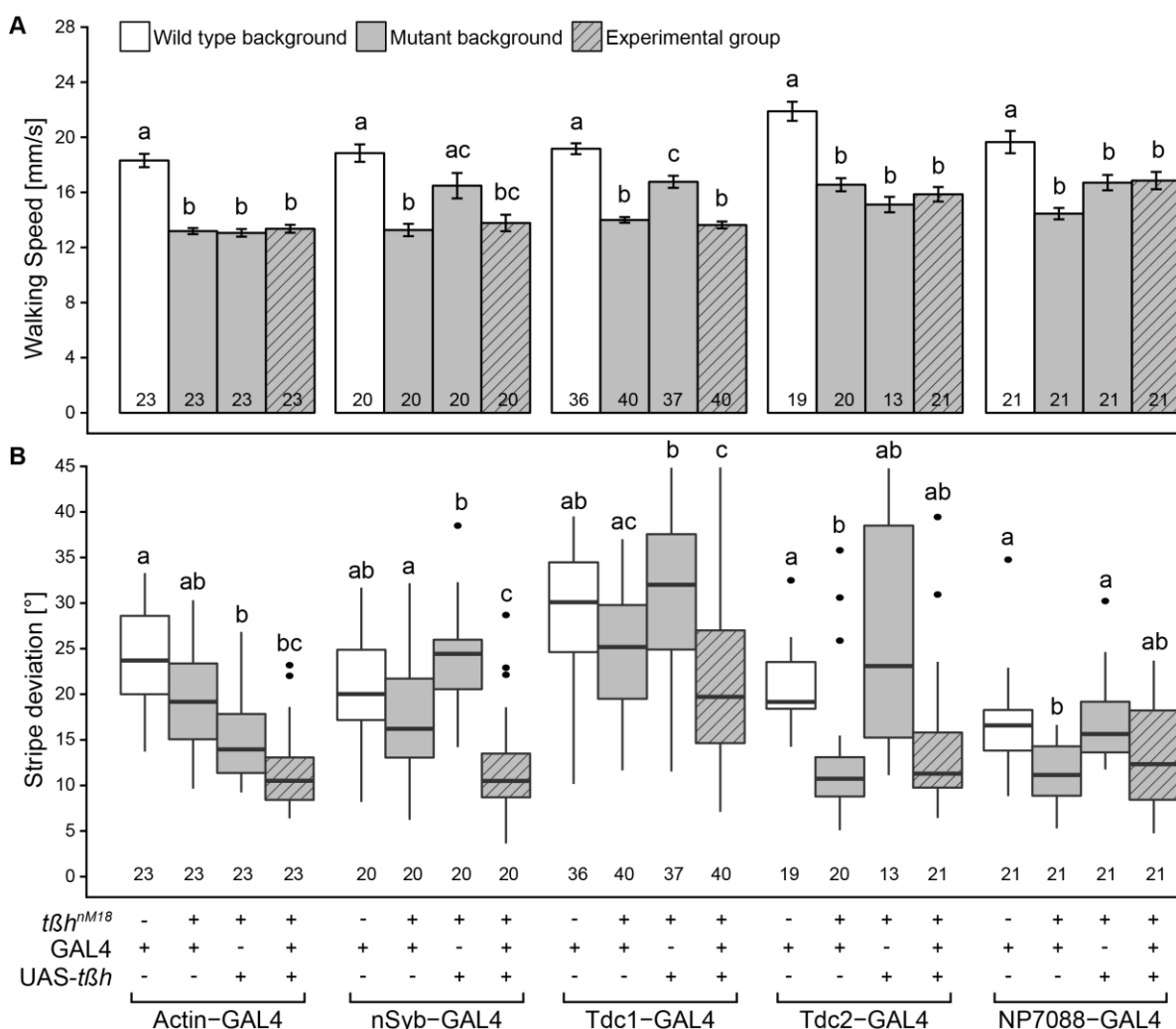
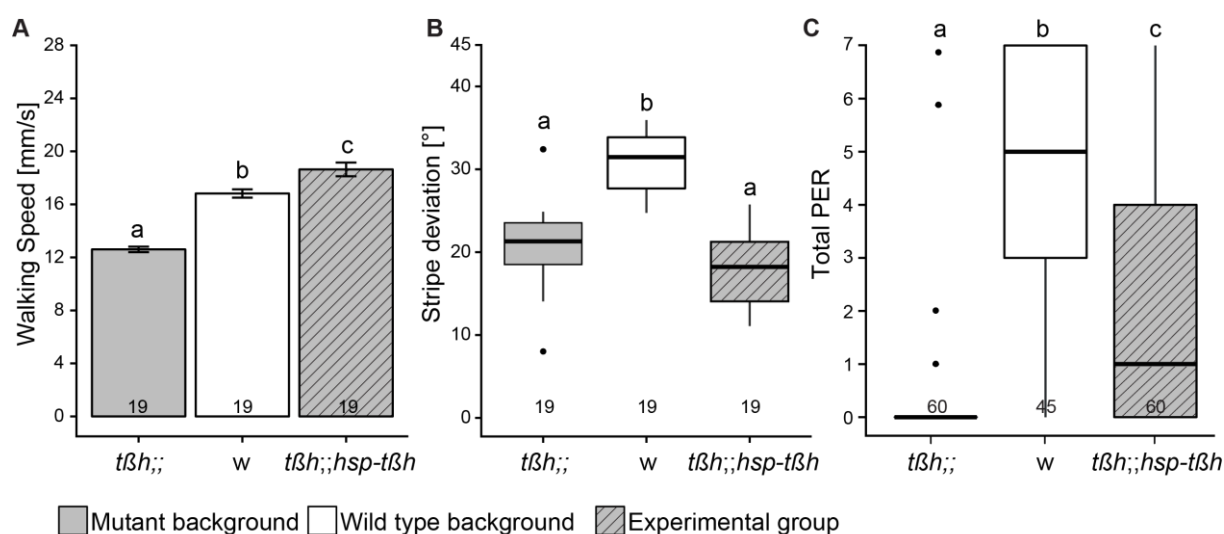

**Fig. 2: GAL4-UAS-dependent *tβh* expression cannot rescue the mutant locomotion phenotypes.**

**A.** Median walking speed cannot be rescued by heterozygous GAL4-UAS-dependent *tβh* expression in mutants. All groups are different from the wild type control, except for the UAS-*tβh* control in the nSyb experiment (two-way ANOVA with TukeyHSD post hoc test and correction for multiple measurements,  $p < 0.05$ ). **B.** Stripe deviation performance is already increased by the presence of the GAL4- or the UAS-construct. Ubiquitous Actin-GAL4 or pan-neuronal nSyb-GAL4 expression worsens the phenotype compared to the control lines (paired Wilcoxon rank sum test with bonferroni correction,  $p < 0.05$ ).

### Acute *tβh* expression affects the phenotypes differently

Next, we used ubiquitous temporally controlled rescue experiments by expressing *tβh* in homozygous *tβh* mutant females under the control of the heat shock promoter *hsp-tβh* (Schwaerzel et al., 2003). A heat shock was induced for 45 min at 37°C and flies were allowed to recover for 3 h. After this treatment, rescue flies walked faster than controls (Fig. 3A), while their stripe deviation performance was not affected (Fig. 3B) and their sugar response was slightly but significantly improved (Fig. 3C, from Damrau et al. (in preparation)).



**Fig. 3: Acute and ubiquitous *tβh* expression rescues walking speed and sugar response but not stripe deviation.**

*tβh* expression was induced with a heat shock 3 h before the test. **A.** Median walking speed is increased beyond wild type levels after *tβh* induction (two-way ANOVA followed by TukeyHSD post hoc test,  $p < 0.05$ ,  $F = 69.8$ ). **B.** Stripe deviation is not affected by *tβh* induction. **C.** Sugar response is increased by *tβh* expression, but does not reach wild type levels (paired Wilcoxon rank sum test with bonferroni correction,  $p < 0.05$ , data already published in Damrau et al. (in preparation)). Explanation for bars, Tukey boxplots, numbers and letters is identical to Fig. 1.

### Synthesis amplification of either OA or TA led to different effects in walking speed and stripe deviation

In order to differentiate failed rescue to putative overexpression effects which could explain the absence of rescue in previous experiment, we manipulated the expression of the *tβh* and Tdc enzymes (tyrosine decarboxylase synthesizes TA from tyrosine) in wild type animals (Fig. 4). While *tβh* overexpression should lead to OA production and a decrease in TA titers, the Tdc overexpression should lead to TA production and probably an increase in OA titres. We overexpressed UAS-*Tdc2*

using the *elaV-GAL4;tub-GAL80<sup>ts</sup>* driver while we overexpressed *tβh* using the heat-inducible promoter as described above. *Tdc2*-overexpression (Fig. 4C) but not *tβh*-overexpression (Fig. 4A) led to decreased walking speed. *tβh*-overexpression led to decreased stripe deviation (Fig. 4B). The *Tdc2*-overexpression experiment on stripe deviation cannot be interpreted because of the difference in the score of the control groups (Fig. 4D).

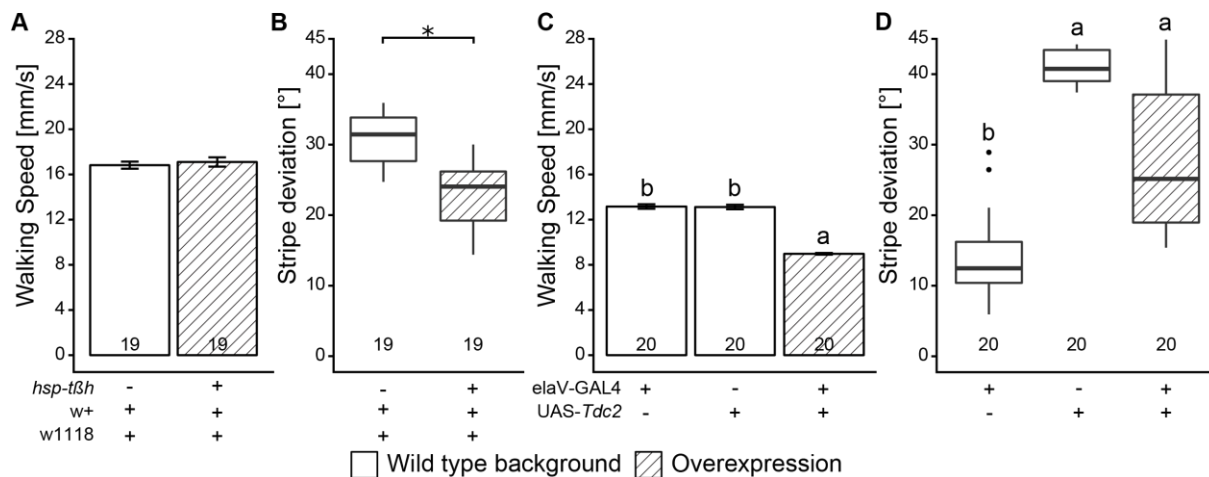

**Fig. 4: Acute overexpression of TA and OA synthesis enzymes in wild type background affects flies' behavior in the Buridan's experiment.**

**A.** Median walking speed is not affected when *tβh* is overexpressed in wild type 3 h before testing via *hsp-tβh* (Welch Two-Sample t-Test,  $p < 0.05$ ). **B.** In contrast, stripe deviation is reduced when *tβh* is overexpressed (Wilcoxon rank sum test with correction for multiple measurements,  $p < 0.05$ ). **C.** Median walking speed is reduced after overexpression of *Tdc2* (two-way ANOVA followed by TukeyHSD post hoc test,  $p < 0.05$ ). **D.** The two parental controls show very different stripe deviation behavior, which prevents the interpretation of the performance of the overexpression group (paired Wilcoxon rank sum test with bonferroni correction,  $p < 0.05$ ). Explanation for bars, Tukey boxplots, numbers and letters is identical to Fig. 1.

### Modulation of walking speed and stripe deviation by OA and TA was not correlated

To specifically affect the signaling of only one of the amines, we manipulated the OA/TA system on the receptor level and examined several OA and TA receptor mutants.

We tested two alleles for each of two OA receptors *Oamb* and *Octβ2R*, as well as one allele for the three TA receptors *honoka*, *TyrR* and *TyrRII*, and a double receptor mutant for *TyrR* and *TyrRII*. We created mutants for the *Octβ2R* using recombination of FRT-containing P-elements (Parks et al., 2004) and received the unpublished TA

receptor mutants from Edward Blumenthal (Zhang and Blumenthal, in preparation) created by a similar method. While walking speed was affected in seven mutants (Fig. 5A, only *TyrRII*<sup>Δ29</sup> mutation had no effect), the stripe deviation was affected only in the two TA receptor mutants *TyrR*<sup>f05682</sup> and *honoka* (Fig. 5B). Interestingly, the double mutant *TyrRII-TyrR*<sup>Δ124</sup> showed no phenotype.

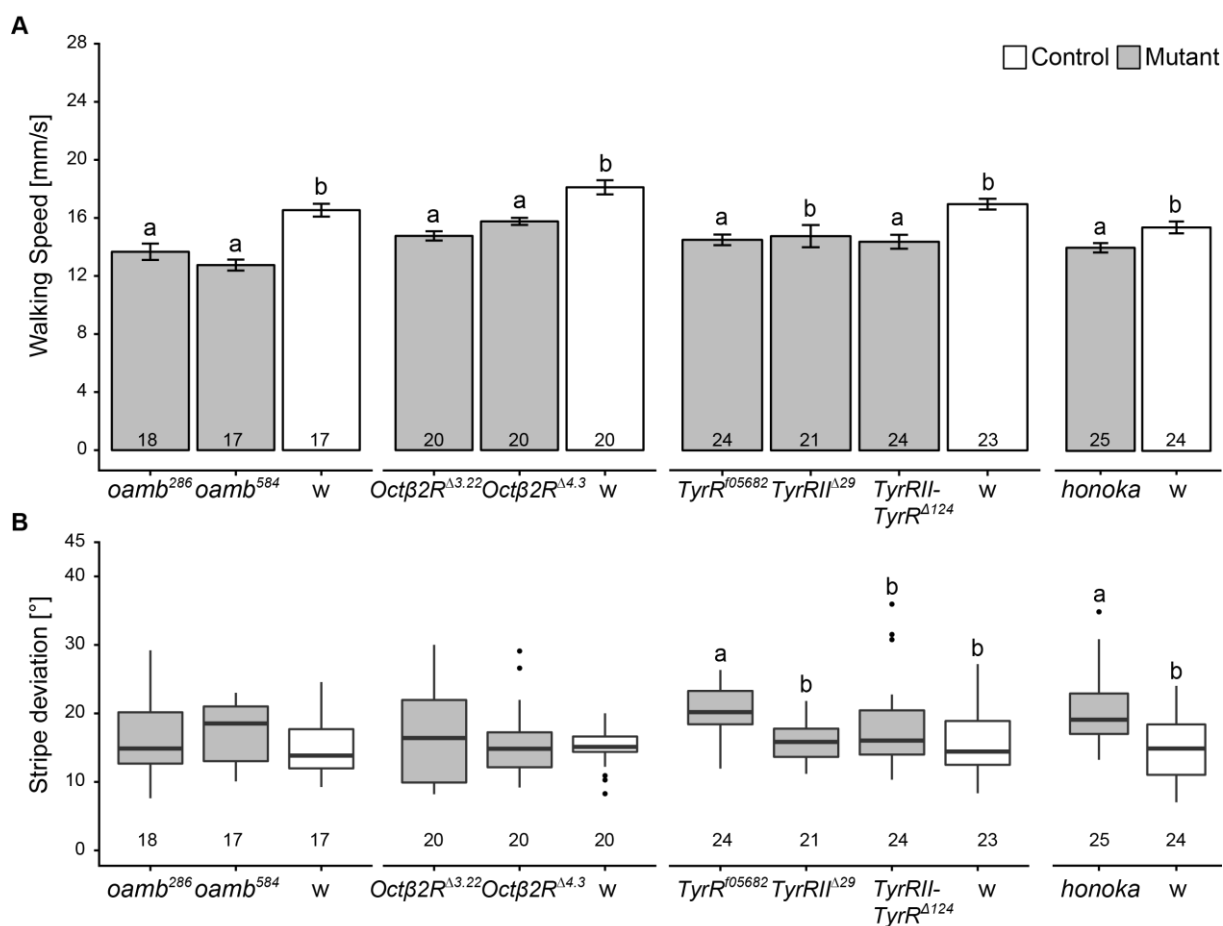

**Fig. 5: Performance of flies mutant for TA and OA receptors in the Buridan's paradigm.**

**A.** *oamb*<sup>286</sup>, *oamb*<sup>584</sup>, *Octβ2R*<sup>Δ3.22</sup>, *Octβ2R*<sup>Δ4.3</sup>, *honoka*, *TyrR*<sup>f05682</sup>, and the double mutant *TyrRII-TyrR*<sup>Δ124</sup> walk slower than their respective controls, while *TyrRII*<sup>Δ29</sup> walking speed appeared at wild type level (Welch Two-Sample t-Test with correction for multiple measurements,  $p < 0.05$ ). **B.** Stripe deviation is not affected in OA receptor mutants. In *TyrR*<sup>f05682</sup> and *honoka*, stripe deviation is significantly enhanced. Significant differences between control and the respective receptor mutant are calculated by Wilcoxon rank sum test with correction for multiple measurements ( $p < 0.05$ ). Explanation for bars, Tukey boxplots, number and letters is identical to Fig. 1.

---

## Discussion

### Locomotion Phenotypes

OA and TA are important neuromodulators in the insect nervous system. However, their modulation of locomotion behaviors in adult *Drosophila* is not well understood. We demonstrated that *tβh* levels are necessary for both how fast and in which direction flies are walking in the Buridan's experiment. In absence of the *tβh* gene, flies walk slower and more directed to the stripes than control flies independently of their gender (Fig. 1) or genetic background (Damrau et al., 2014b). This latter test is important, since fixation scores were shown to highly depend on flies genetic background (Colomb and Brembs, 2014; Fig. 4D). Acute and ubiquitous expression of *tβh* affected both walking speed and stripe fixation (Fig. 3, Fig. 4), confirming that those *tβh* effects are specific.

### Phenotypes are differently affected by *tβh* gene dosage

We described three phenotypes of *tβh<sup>nm18</sup>* mutant flies: reduction in walking speed, in stripe deviation performance and in sugar response after starvation. The phenotypes were differently affected by the modulation of *tβh* expression: the results of testing heterozygous (Fig. 1), spatially (Fig. 2, Damrau et al., in preparation) as well as temporally restricted rescued (Fig. 3) and overexpressed flies (Fig. 4) are summarized according to the respective *tβh* gene dosage resulting in a performance curve (Fig. 6). Since statistical differences did not always reflect relative performance score differences and since sugar response tests were conducted according to different protocols, we reported the mean or median result normalized to wild type and mutant controls for each experiment. The curve shape suggests that the actual overall *tβh* gene dosage is a crucial determinant in control of the tested behavioral traits. The stripe deviation and sugar response phenotype both seem to be tight to a particular *tβh* dosage (peaking at wild type dosage), whereas walking speed is generally enhanced by *tβh* expression with no direct correlation between gene dosage and performance level because of the performance peak at heterozygous state. The different sensitivity to *tβh* dosage of the different phenotypes is probably representative for the sensitivity of the neuronal networks involved.

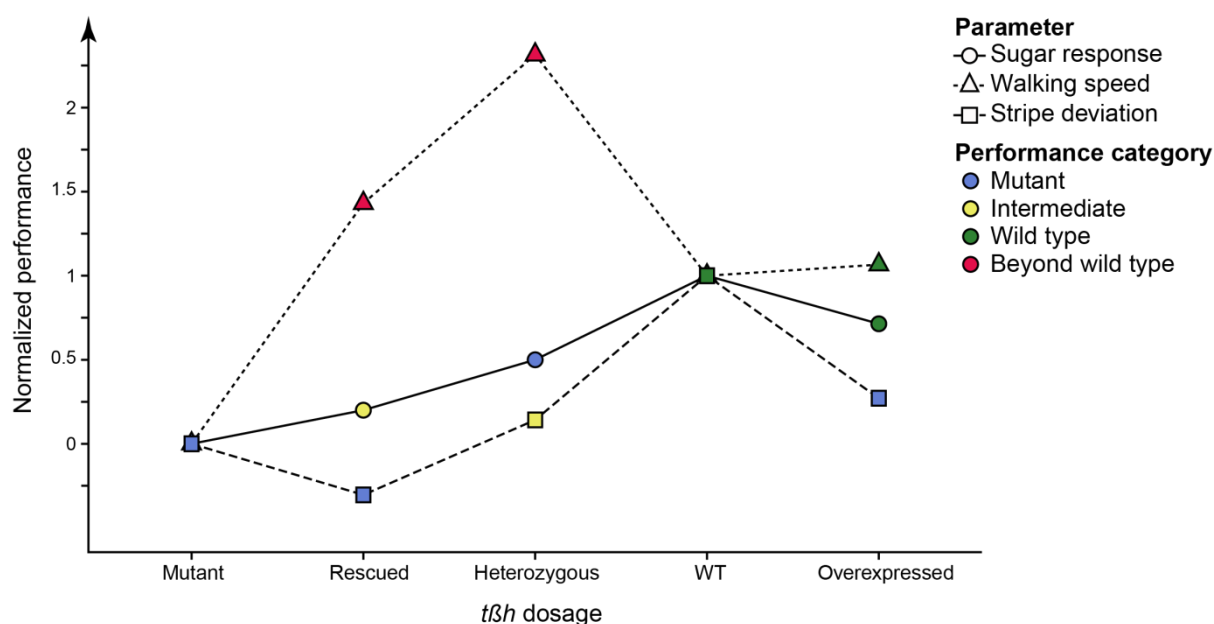

**Fig. 6: Summary of phenotypical performance according to the *tβh* gene dosage.**

Mean or median results were normalized to the performance of wild type and mutant controls for each experiment and depicted on the y-axis. The order on the x-axis reflects the number of gene copies, whereby the position of the rescue and heterozygote experiment was set arbitrarily. The color code indicates that the performance of the group is not statistically different from mutant (blue) or wild type (green), or that it is statistically different from both (yellow), or that it is significantly stronger than wild type (pink).

### TA contributes to the phenotype in *tβh<sup>nM18</sup>* mutants

Manipulating *tβh* expression modifies the balance of OA and TA in opposite directions (Monastirioti et al., 1996). Therefore, the *tβh* dosage dependency may be derived by the alteration of a fine balance between relative TA and OA concentrations. In *Drosophila* larvae, it was suggested that the relative increase in OA levels but not the absolute endogenous amount is important for regulation of starvation-induced locomotion (Koon and Budnik, 2012). Overexpression of the Tdc2 enzyme should increase both OA and TA concentrations. Under these conditions, flies walked slower (Fig. 4). This would suggest that the increase in TA concentration is a major element in the *tβh<sup>nM18</sup>* mutant walking speed phenotype. However, all tested OA and TA receptor mutants showed a decreased walking speed, supporting an action for both OA and TA on that behavioral trait. The interaction between the two neuromodulators seems however to be more complex than a simple balance as suggested for larval locomotion (Saraswati et al., 2004).

---

For the stripe deviation phenotype, TA receptor mutants showed a phenotype opposite from *tβh<sup>nM18</sup>* mutants (Fig. 5). Although we have not tested all known OA receptors (Farooqui, 2012), considering the TA receptor and other data on stripe deviation, this suggests that TA may act independently of OA on this behavioral trait with an increased TA activity leading to a better stripe fixation.

### ***tβh<sup>nM18</sup>* mutation show differential dominance effects**

Additionally to dosage-dependency, the analysis of the tested heterozygous mutants revealed differential dominance of the *tβh<sup>nM18</sup>* mutation for different behavioral traits (Fig. 1). Pleiotropic alleles often show differential dominance (Ehrich et al., 2003; Kenney-Hunt and Cheverud, 2009) accompanied by overdominance in some traits (Klingenberg et al., 2001; Cheverud et al., 2004; Lawson et al., 2011). Due to their homozygous sterility (Monastirioti et al., 1996) *tβh* mutant flies were kept in heterozygous state for several years. It is therefore possible that those flies were selected for fitness at heterozygous state. Additionally, since walking speed depends on multiple variables, a combination of recessive and dominant effects of the *tβh<sup>nM18</sup>* allele on these variables may result in the overdominant phenotype, as was proposed for morphological phenotypes (Klingenberg et al., 2001; Ehrich et al., 2003; Kenney-Hunt and Cheverud, 2009).

### **Overexpression and rescue attempts**

Rescuing a gene only in one subset of neurons using the GAL4-UAS system is a common approach to decipher neuronal sufficiency (Brand and Perrimon, 1993; Zars et al., 2000; Zhou et al., 2008). The sugar response phenotype was rescued by ubiquitous *tβh* expression (Damrau et al., in preparation) whereas the locomotion phenotypes were not (Fig. 2). The failed rescue might be due to *tβh* overexpression during development which may have deteriorating and unexpected effects as reported for the *dunce* (van Swinderen et al., 2009) and the *radish* gene (van Swinderen and Brembs, 2010).

On the other hand, acute *tβh* expression efficiently affected sugar response and walking speed in mutant and wild type (Fig. 6). If the ectopic effects of expressing *tβh* in usually non-OA cells played a major role, any ectopic expression, either in wild type or in mutants, should show the same trend on behavioral performance. Instead, the performances differ between *tβh* expression in mutants (Fig. 3) and wild type (Fig. 4). We can therefore exclude that ectopic expression affects sugar response



and walking speed. Since stripe deviation was not affected by any rescue attempt, we cannot exclude ectopic effects on it, though.

### **Conclusion**

We found differential dominance of the *tβh*<sup>nM18</sup> mutation in sugar response and stripe fixation with an overdominance effect for walking speed. Interestingly, the commonly used genetic approaches to narrow down the functionality of *tβh* on cellular level did not work in the locomotion-related behaviors, probably because the *tβh* dosage is crucial. Therefore, our data indicate a modulatory effect derived by enzymatic activity leading to an alteration of relative aminergic amounts.

## GENERAL DISCUSSION

Behavioral output underlies great plasticity depending on environmental and internal changes. These changes and the resulting behavior are mainly mediated by neuromodulators of the nervous system. Among neuromodulators is the group of biogenic amines that also act as neurotransmitters and neurohormones involved in almost every physiological process (Evans, 1980). Often, the same modulator is involved in a plethora of different processes (Libersat and Pflueger, 2004; Roeder, 2005). In order to explain how this can be achieved, Sombati and Hoyle (1984) originated the orchestration hypothesis. It implies the recruitment of only a certain cellular subset from one modulator network to trigger a certain behavior.

This study strongly supports the orchestration hypothesis. The OA/TA-dependent modulation of several behavioral parameters was investigated in adult *Drosophila melanogaster* using advanced genetic manipulations. Mutants with altered amine levels were examined in starvation-dependent parameters, walking speed and stripe fixation while walking. The data are extensive enough to allow speculations about the assignment of cellular OA/TA subsets to the tested behavioral tasks.

First, my colleagues and I found that starvation-induced sugar response is regulated by both, neuronal and non-neuronal OA/TA cells. Results of behavioral experiments (Chapter 1) and the respective GAL4-expression patterns (Busch et al., 2009; Schneider et al., 2012) suggest a role of OAergic and TAergic neurons in the antennal lobe, the protocerebrum and the thoracic ganglion, exclusive from the Tdc2-GAL4 expression pattern. Additionally, non-neuronal TA-specific cells are involved in sugar response, maybe those localized in the crop and the hind gut (Cole et al., 2005; Chintapalli et al., 2007; Blumenthal, 2009).

Second, we tested walking speed in the Buridan's paradigm (Chapter 2). Walking underlies muscular activity known to be modulated by OA/TA (Nagaya et al., 2002; Ormerod et al., 2013). OAergic neurons in the thoracic ganglion innervate skeletal muscles such as leg muscles (Monastirioti et al., 1995; Bräunig, 1997) and are involved in forward locomotion of *Drosophila* larvae (Selcho et al., 2014). Therefore, it is speculative but likely that those OAergic neurons modulate walking speed by changing muscular dynamics.

Third, stripe fixation is a complex trait depending on visual perception (Osorio et al., 1990; Riemensperger et al., 2011). OA is displayed as a modulator of the visual

system (Erber and Kloppenburg, 1995; Kloppenburg and Erber, 1995), expressed in motion-sensitive neurons (Stern et al., 1995; Stern, 2009; Suver et al., 2012). TA receptors are expressed in the optic lobes (Kutsukake et al., 2000). We found that OA-less and TA-enhanced flies and TA-receptor mutants are affected in stripe deviation. Therefore, it is speculated that OA/TA action on the visual system may contribute to the stripe fixation phenotype.

Further experiments have to be performed to confirm the cellular responsibilities in the different behavioral traits. More insight may be given by the limitation of genetic alteration to fewer neurons by use of *tsh*-GAL80 (Fasano et al., 1991; Clyne and Miesenböck, 2008) or Split GAL4 (Luan et al., 2006), or timely restricted rescue attempts by use of temperature-sensitive GAL80<sup>ts</sup> (McGuire et al., 2003), by the immunohistochemical determination of the expression pattern of the tested receptors, or molecular analysis of aminergic levels in hemolymph and brain by high-pressure liquid chromatography.

The presented data enable speculations about the involvement of specific OA/TA cells in the different behavioral parameters we tested. Therefore, we suggest that different modulatory neurons are active during distinct behaviors supporting the orchestration hypothesis and explaining how only one modulator can trigger several processes.

Instead of the activation of only distinct subsets, the OA/TA system may work on a more comprehensive basis. It was suggested that release of OA into the hemolymph has an arousal function to transform neuronal circuits from a passive into a dynamic state (Evans and Siegler, 1982). This is not only restricted to leg or flight muscles (Evans and Siegler, 1982; Whim and Evans, 1988) but may include more general effects on peripheral and central nervous system (Orchard et al., 1993), for example as a wake-promoting signal in *Drosophila* (Crocker and Sehgal, 2008). In response to different kinds of stressors, *tβh* expression increases (Châtel et al., 2013), TA-only cells become OA-positive (Kononenko et al., 2009), and OA is released into the hemolymph (Davenport and Evans, 1984, 2008). It may be assumed that the starvation treatment (Chapter 1) is similarly stressful for the flies as wing cutting and the tests in Buridan's paradigm (Chapter 2). Due to this stress, OA may be released such that behavioral output is changed. Mutants with altered amine levels would not be able to signal such stress. That may result in reduction of all the phenotypes in the *tβh*<sup>nM18</sup> mutant. Since also TA-receptor mutants are affected in several parameters,

TA is probably involved in the arousal system as previously suggested in *Caenorhabditis elegans* (Pirri et al., 2009) and flies (Crocker and Sehgal, 2008).

In conclusion, this thesis is a contribution to decipher the mechanisms underlying the modulation of complex behavioral repertoires. The broadly conceived approach included the use of several different genetic modifications, quantification of metabolic effects, and electrophysiological techniques. It allowed direct comparison of results obtained from different behavioral paradigms. We show a non-neuronal effect of TA in a neuronal context and demonstrated differential dominance effects of the *tβh<sup>nM18</sup>* allele. Other studies will consider our findings on developmental effects of *tβh*. The studies of the OA/TA effect on locomotion and starvation-related behavior in adult *Drosophila* lay a fundamental basis for future systematic research on the role of aminergic systems in stress response, both at a neuronal and a systemic level.

**LIST OF REFERENCES**

- Amakawa T (2001) Effects of age and blood sugar levels on the proboscis extension of the blow fly *Phormia regina*. *J Insect Physiol* 47:195–203.
- Arnesen SJ, Olivo RF (1988) The Effects of Serotonin and Octopamine on Behavioral Arousal in the Crayfish. *Comp Biochem Physiol* 9:259–263.
- Avila FW, Bloch Qazi MC, Rubinstein CD, Wolfner MF (2012) A requirement for the neuromodulators octopamine and tyramine in *Drosophila melanogaster* female sperm storage. *Proc Natl Acad Sci U S A* 109:4562–4567.
- Bacon JP, Thompson KSJ, Stern M (1995) Identified Octopaminergic Neurons Provide an Arousal Mechanism in the Locust Brain. *J Neurophysiol* 74:2739–2743.
- Baier A, Wittek B, Brembs B (2002) *Drosophila* as a new model organism for the neurobiology of aggression? *J Exp Biol* 205:1233–1240.
- Baines D, DeSantis T, Downer RGH (1992) Octopamine and 5-Hydroxytryptamine enhance the Phagocytic and Nodule Formation Activities of Cockroach (*Periplaneta americana*) Haemocytes. *J Insect Physiol* 38:905–914.
- Balfanz S, Strünker T, Frings S, Baumann A (2005) A family of octopamine receptors that specifically induce cyclic AMP production or Ca<sup>2+</sup> release in *Drosophila melanogaster*. *J Neurochem* 93:440–451.
- Baudoux S, Duch C, Morris OT (1998) Coupling of Efferent Neuromodulatory Neurons to Rhythmical Leg Motor Activity in the Locust. *J Neurophysiol* 79:361–370.
- Bayliss A, Roselli G, Evans PD (2013) A comparison of the signalling properties of two tyramine receptors from *Drosophila*. *J Neurochem* 125:37–48.
- Bell WJ, Tortorici C, Roggero RJ, Kipp LR, Tobin TR (1985) Sucrose-stimulated searching behaviour of *Drosophila melanogaster* in a uniform habitat: modulation by period of deprivation. *Anim Behav* 33:436–448.
- Bellen HJ, Tong C, Tsuda H (2010) 100 years of *Drosophila* research and its impact on vertebrate neuroscience: a history lesson for the future. *Nature* 464:514–523.
- Blau C, Wegener G, Candy DJ (1994) The effect of octopamine on the glycolytic activator fructose 2,6-bisphosphate in perfused locust flight muscle. *Insect Biochem Mol Biol* 24:677–683.
- Blumenthal EM (2003) Regulation of chloride permeability by endogenously produced tyramine in the *Drosophila* Malpighian tubule. *Am J Physiol Cell Physiol* 284:C718–28.
- Blumenthal EM (2009) Isoform- and cell-specific function of tyrosine decarboxylase in the *Drosophila* Malpighian tubule. *J Exp Biol* 212:3802–3809.
- Brand AH, Perrimon N (1993) Targeted gene expression as a means of altering cell fates and generating dominant phenotypes. *Development* 118:401–415.

- Braun G, Bicker G (1992) Habituation of an Appetitive Reflex in the Honeybee. *J Neurophysiol* 67:588–598.
- Bräunig P (1997) The peripheral branching pattern of identified dorsal unpaired median (DUM) neurones of the locust. *Cell Tissue Res* 290:641–654.
- Bräunig P, Eder M (1998) Locust Dorsal Unpaired Median (DUM) Neurones Directly Innervate and Modulate Hindleg Proprioceptors. *J Exp Biol* 201:3333–3338.
- Brembs B, Christiansen F, Pflüger HJ, Duch C (2007) Flight initiation and maintenance deficits in flies with genetically altered biogenic amine levels. *J Neurosci* 27:11122–11131.
- Buhl E, Schildberger K, Stevenson PA (2008) A muscarinic cholinergic mechanism underlies activation of the central pattern generator for locust flight. *J Exp Biol* 211:2346–2357.
- Bülthoff H, Götz KG, Herre M (1982) Recurrent Inversion of Visual Orientation in the Walking Fly, *Drosophila melanogaster*. *J Comp Physiol* 148:471–481.
- Bunzow JR, Sonders MS, Arttamangkul S, Harrison LM, Zhang GE, Quigley DI, Darland T, Suchland KL, Pasumamula S, Kennedy JL, Olson SB, Magenis RE, Amara SG, Grandy DK (2001) Amphetamine, 3,4-Methylenedioxymethamphetamine, Lysergic Acid Diethylamide, and Metabolites of the Catecholamine Neurotransmitters Are Agonists of a Rat Trace Amine Receptor. *Mol Pharmacol* 60:1181–1188.
- Burke CJ, Huetteroth W, Oswald D, Perisse E, Krashes MJ, Das G, Gohl D, Silies M, Certel S, Waddell S (2012) Layered reward signalling through octopamine and dopamine in *Drosophila*. *Nature* 492:433–437.
- Burrows M (1996) *The Neurobiology of an Insect Brain*. Oxford Scholarship Online.
- Busch S, Selcho M, Ito K, Tanimoto H (2009) A map of octopaminergic neurons in the *Drosophila* brain. *J Comp Neurol* 513:643–667.
- Candy DJ, Becker A, Wegener G (1997) Coordination and Integration of Metabolism in Insect Flight. *Comp Biochem Physiol* 117B:497–512.
- Castle WE, Carpenter FW, Clark AH, Mast SO, Barrows WM (1906) The Effects of Inbreeding, Cross-Breeding, and Selection upon the Fertility and Variability of *Drosophila*. *Proc Am Acad Arts Sci* 41:731–786.
- Cazzamali G, Klaerke DA, Grimmelikhuijzen CJP (2005) A new family of insect tyramine receptors. *Biochem Biophys Res Commun* 338:1189–1196.
- Châtel A, Murillo L, Bourdin CM, Quinchard S, Picard D, Legros C (2013) Characterization of tyramine  $\beta$ -hydroxylase, an enzyme upregulated by stress in *Periplaneta americana*. *J Mol Endocrinol* 50:91–102.
- Cheverud JM, Ehrich TH, Vaughn TT, Koreishi SF, Linsey RB, Pletscher LS (2004) Pleiotropic effects on mandibular morphology II: differential epistasis and genetic variation in morphological integration. *J Exp Zool B Mol Dev Evol* 302:424–435.

- Chiappe ME, Seelig JD, Reiser MB, Jayaraman V (2010) Walking modulates speed sensitivity in *Drosophila* motion vision. *Curr Biol* 20:1470–1475.
- Chintapalli VR, Wang J, Dow JAT (2007) Using FlyAtlas to identify better *Drosophila melanogaster* models of human disease. *Nat Genet* 39:715–720.
- Claassen DE, Kammer AE (1986) Effects of octopamine, dopamine, and serotonin on production of flight motor output by thoracic ganglia of *Manduca sexta*. *J Neurobiol* 17:1–14.
- Clos J, Westwood JT, Becker PB, Wilson S, Lambert K, Wu C (1990) Molecular cloning and expression of a hexameric *Drosophila* heat shock factor subject to negative regulation. *Cell* 63:1085–1097.
- Clyne JD, Miesenböck G (2008) Sex-specific control and tuning of the pattern generator for courtship song in *Drosophila*. *Cell* 133:354–363.
- Cole SH, Carney GE, McClung CA, Willard SS, Taylor BJ, Hirsh J (2005) Two functional but noncomplementing *Drosophila* tyrosine decarboxylase genes: distinct roles for neural tyramine and octopamine in female fertility. *J Biol Chem* 280:14948–14955.
- Colomb J, Brembs B (2014) Sub-strains of *Drosophila* Canton-S differ markedly in their locomotor behavior. *F1000Research* 176:1–11.
- Colomb J, Kaiser L, Chabaud M, Preat T (2009) Parametric and genetic analysis of *Drosophila* appetitive long-term memory and sugar motivation. *Genes Brain Behav* 8:407–415.
- Colomb J, Reiter L, Blaszkiewicz J, Wessnitzer J, Brembs B (2012) Open source tracking and analysis of adult *Drosophila* locomotion in Buridan's paradigm with and without visual targets. *PLoS One* 7:e42247.
- Connolly KJ (1966) Locomotor Activity in *Drosophila* as a Function of Food Deprivation. *Nature* 209:224.
- Coppen A (1967) The Biochemistry of Affective Disorders. *Br J Psychiatry* 113:1237–1264.
- Crocker A, Sehgal A (2008) Octopamine regulates sleep in *Drosophila* through protein kinase A-dependent mechanisms. *J Neurosci* 28:9377–9385.
- Crocker A, Sehgal A (2010) Genetic analysis of sleep. *Genes Dev* 24:1220–1235.
- Damrau C, Brembs B, Colomb J (2012) Survival of *tβh* mutants. *Biog Amin homepage* Available at: <http://biogeneamine.fu-berlin.de/?p=380>.
- Damrau C, Brembs B, Colomb J (2013) Haemolymph extraction of adult *Drosophila*. *figshare* Available at: [http://figshare.com/articles/Haemolymph\\_extraction/650602](http://figshare.com/articles/Haemolymph_extraction/650602).
- Damrau C, Brembs B, Colomb J (2014a) *Drosophila* sugar response is increased by starvation duration and sucrose concentration in a locomotion-independent proboscis extension test. *figshare* Available at: <http://dx.doi.org/10.6084/m9.figshare.1162437>.

- 
- Damrau C, Colomb J, Brembs B (2014b) tßh mutant flies walk slower and deviate less from stripes in Buridan's paradigm. figshare Available at: [http://figshare.com/articles/t\\_h\\_mutant\\_flies\\_walk\\_slower\\_and\\_deviate\\_less\\_from\\_stripes\\_in\\_Buridan\\_s\\_paradigm\\_/1162439](http://figshare.com/articles/t_h_mutant_flies_walk_slower_and_deviate_less_from_stripes_in_Buridan_s_paradigm_/1162439).
- Davenport AP, Evans PD (1984) Stress-induced changes in the octopamine levels of insect haemolymph. *Insect Biochem* 14:135–143.
- Davenport AP, Evans PD (2008) Changes in haemolymph octopamine levels associated with food deprivation in the locust, *Schistocerca gregaria*. *Physiol Entomol* 3:269 – 274.
- David J-C, Coulon J-F (1985) Octopamine in Invertebrates and Vertebrates. A Review. *Prog Neurobiol* 24:141–185.
- De Haan R, Lee Y-J, Nordström K (2012) Octopaminergic modulation of contrast sensitivity. *Front Integr Neurosci* 6:55.
- Duch C, Mentel T, Pflüger HJ (1999) Distribution and activation of different types of octopaminergic DUM neurons in the locust. *J Comp Neurol* 403:119–134.
- Dudai Y, Jan Y-N, Byers D, Quinn WG, Benzer S (1976) dunce, a mutant of *Drosophila* deficient in learning. *Proc Natl Acad Sci U S A* 73:1684–1688.
- Ehrich TH, Vaughn TYT, Koreishi SF, Linsey RB, Pletscher LS, Cheverud JM (2003) Pleiotropic Effects on Mandibular Morphology I . Developmental Morphological Integration and Differential Dominance. *J Exp Zool* 79:58–79.
- Erber J, Kloppenburg P (1995) The modulatory effects of serotonin and octopamine in the visual system of the honey bee (*Apis mellifera* L.). *J Comp Physiol A* 176:111–118.
- Erion R, DiAngelo JR, Crocker A, Sehgal A (2012) Interaction between sleep and metabolism in *Drosophila* with altered octopamine signaling. *J Biol Chem* 287:32406–32414.
- Erspamer V, Boretti G (1951) Identification and characterization, by paper chromatography, of enteramine, octopamine, tyramine, histamine and allied substances in extracts of posterior salivary glands of octopoda and in other tissue extracts of vertebrates and invertebrates. *Arch Int Pharmacodyn Ther* 88:296–332.
- Evans PD (1980) Biogenic Amines in the Insect Nervous System. *Adv In Insect Phys* 15:317–473.
- Evans PD, Maqueira B (2005) Insect octopamine receptors: a new classification scheme based on studies of cloned *Drosophila* G-protein coupled receptors. *Invert Neurosci* 5:111–118.
- Evans PD, O'Shea M (1977) An octopaminergic neurone modulates neuromuscular transmission in the locust. *Nature* 270:257–259.
- Evans PD, Siegler MV. S (1982) Octopamine mediated relaxation of maintained and catch tension in locust skeletal muscle. *J Physiol*:93–112.
-



- Farooqui T (2012) Review of octopamine in insect nervous systems. *Open access insect physiol* 4:1–17.
- Fasano L, Röder L, Coré N, Alexandre E, Vola C, Jacq B, Kerridge S (1991) The gene *teashirt* is required for the development of *Drosophila* embryonic trunk segments and encodes a protein with widely spaced zinc finger motifs. *Cell* 64:63–79.
- Fox LE, Soll DR, Wu C-F (2006) Coordination and modulation of locomotion pattern generators in *Drosophila* larvae: effects of altered biogenic amine levels by the tyramine beta hydroxylase mutation. *J Neurosci* 26:1486–1498.
- Fussnecker BL, Smith BH, Mustard JA (2006) Octopamine and tyramine influence the behavioral profile of locomotor activity in the honey bee (*Apis mellifera*). *J Insect Physiol* 52:1083–1092.
- Gal R, Libersat F (2010) A wasp manipulates neuronal activity in the sub-esophageal ganglion to decrease the drive for walking in its cockroach prey. *PLoS One* 5:e10019.
- Gergen JP, Wieschaus E (1986) Dosage requirements for runt in the segmentation of *Drosophila* embryos. *Cell* 45:289–299.
- Golic KG, Lindquist S (1989) The FLP recombinase of yeast catalyzes site-specific recombination in the *Drosophila* genome. *Cell* 59:499–509.
- Gruntenko N, Chentsova NA, Bogomolova EV, Karpova EK, Glazko GV, Faddeeva NV, Monastiriotti M, Rauschenbach IY (2004) The effect of mutations altering biogenic amine metabolism in *Drosophila* on viability and the response to environmental stresses. *Arch Insect Biochem Physiol* 55:55–67.
- Hammer M (1993) An identified neuron mediates the unconditioned stimulus in associative olfactory learning in honeybees. *Nature* 366:59–63.
- Hammer M (1997) The neural basis of associative reward learning in honeybees. *Trends Neurosci* 20:245–252.
- Han K-A, Millar NS, Davis RL (1998) A novel octopamine receptor with preferential expression in *Drosophila* mushroom bodies. *J Neurosci* 18:3650–3658.
- Hardie SL, Zhang JX, Hirsh J (2013) Trace Amines Differentially Regulate Adult Locomotor Activity, Cocain Sensitivity, and Female Fertility in *Drosophila melanogaster*. *Dev Neurobiol* 1:1396–1405.
- Hiroi M, Marion-Poll F, Tanimura T (2002) Differentiated Response to Sugars among Labellar Chemosensilla in *Drosophila*. *Zoolog Sci* 19:1009–1018.
- Hirsch E, Graybiel AM, Agid YA (1988) Melanized dopaminergic neurons are differentially susceptible to degeneration in Parkinson's disease. *Nature* 334:345–348.
- Hodgson ES, Lettvin JY, Roeder KD (1955) Physiology of a Primary Chemoreceptor Unit. *Science* (80- ) 122:417–418.

- 
- Hoyer SC, Eckart A, Herrel A, Zars T, Fischer S a, Hardie SL, Heisenberg M (2008) Octopamine in male aggression of *Drosophila*. *Curr Biol* 18:159–167.
- Inagaki HK, Ben-Tabou de-Leon S, Wong AM, Jagadish S, Ishimoto H, Barnea G, Kitamoto T, Axel R, Anderson DJ (2012) Visualizing neuromodulation in vivo: TANGO-mapping of dopamine signaling reveals appetite control of sugar sensing. *Cell* 148:583–595.
- Isabel G, Martin J-R, Chidami S, Veenstra J a, Rosay P (2005) AKH-producing neuroendocrine cell ablation decreases trehalose and induces behavioral changes in *Drosophila*. *Am J Physiol Regul Integr Comp Physiol* 288:R531–8.
- Ishida Y, Ozaki M (2012) Aversive odorant causing appetite decrease downregulates tyrosine decarboxylase gene expression in the olfactory receptor neuron of the blowfly, *Phormia regina*. *Naturwissenschaften* 99:71–75.
- Kass L, Pelletier JL, Renninger GH, Barlow Jr. RB (1988) Efferent neurotransmission of circadian rhythms in *Limulus* lateral eye. II. Intracellular recordings in vitro. *J Comp Physiol A* 164:95–105.
- Kenney-Hunt JP, Cheverud JM (2009) Differential dominance of pleiotropic loci for mouse skeletal traits. *Evolution* 63:1845–1851.
- Kim Y-C, Lee H-G, Lim J, Han K-A (2013) Appetitive learning requires the alpha1-like octopamine receptor OAMB in the *Drosophila* mushroom body neurons. *J Neurosci* 33:1672–1677.
- Kling G, Schipp R (1987) Effects of Biogenic Amines and Related Agonists and Antagonists on the Isolated Heart of the Common Cuttlefish *Sepia officinalis* L. *Comp Biochem Physiol* 87:251–285.
- Klingenberg CP, Leamy LJ, Routman EJ, Cheverud JM (2001) Genetic architecture of mandible shape in mice: effects of quantitative trait loci analyzed by geometric morphometrics. *Genetics* 157:785–802.
- Kloppenborg P, Erber J (1995) The modulatory effects of serotonin and octopamine in the visual system of the honey bee (*Apis mellifera* L.). *J Comp Physiol A* 176:119–129.
- Kononenko NL, Wolfenbergh H, Pflüger H-J (2009) Tyramine as an independent transmitter and a precursor of octopamine in the locust central nervous system: an immunocytochemical study. *J Comp Neurol* 512:433–452.
- Konopka RJ, Benzer S (1971) Clock mutants of *Drosophila melanogaster*. *Proc Natl Acad Sci U S A* 68:2112–2116.
- Koon AC, Ashley J, Barria R, DasGupta S, Brain R, Waddell S, Alkema MJ, Budnik V (2011) Autoregulatory and paracrine control of synaptic and behavioral plasticity by octopaminergic signaling. *Nat Neurosci* 14:190–199.
- Koon AC, Budnik V (2012) Inhibitory control of synaptic and behavioral plasticity by octopaminergic signaling. *J Neurosci* 32:6312–6322.
-

- Kutsukake M, Komatsu A, Yamamoto D, Ishiwa-Chigusa S (2000) A tyramine receptor gene mutation causes a defective olfactory behavior in *Drosophila melanogaster*. *Gene* 245:31–42.
- Lawson HA, Cady JE, Partridge C, Wolf JB, Semenkovich CF, Cheverud JM (2011) Genetic effects at pleiotropic loci are context-dependent with consequences for the maintenance of genetic variation in populations. *PLoS Genet* 7:e1002256.
- Lee G, Park JH (2004) Hemolymph sugar homeostasis and starvation-induced hyperactivity affected by genetic manipulations of the adipokinetic hormone-encoding gene in *Drosophila melanogaster*. *Genetics* 167:311–323.
- Lee H-G, Rohila S, Han K-A (2009) The octopamine receptor OAMB mediates ovulation via Ca<sup>2+</sup>/calmodulin-dependent protein kinase II in the *Drosophila* oviduct epithelium. *PLoS One* 4:e4716.
- Lewis EB (1978) A gene complex controlling segmentation in *Drosophila*. *Nature* 176:565–570.
- Libersat F, Pflueger H-J (2004) Monoamines and the Orchestration of Behavior. *Bioscience* 54:17–25.
- Liu C, Plaçais P-Y, Yamagata N, Pfeiffer BD, Aso Y, Friedrich AB, Siwanowicz I, Rubin GM, Preat T, Tanimoto H (2012) A subset of dopamine neurons signals reward for odour memory in *Drosophila*. *Nature* 488:512–516.
- Livingstone MS, Tempel BL (1983) Genetic dissection of monoamine neurotransmitter synthesis in *Drosophila*. *Nature* 303:67–70.
- Long TF, Murdock LL (1983) Stimulation of blowfly feeding behavior by octopaminergic drugs. *Proc Natl Acad Sci U S A* 80:4159–4163.
- Luan H, Peabody NC, Vinson CR, White BH (2006) Refined spatial manipulation of neuronal function by combinatorial restriction of transgene expression. *Neuron* 52:425–436.
- Maqueira B, Chatwin H, Evans PD (2005) Identification and characterization of a novel family of *Drosophila* beta-adrenergic-like octopamine G-protein coupled receptors. *J Neurochem* 94:547–560.
- Marder E, Bucher D, Schulz DJ, Taylor AL (2005) Invertebrate central pattern generation moves along. *Curr Biol* 15:R685–99.
- Marion-Poll F (1995) Object-oriented approach to fast display of electrophysiological data under MS-windows. *J Neurosci Methods* 63:197–204.
- Marion-Poll F (1996) Display and analysis of electrophysiological data under Windows. *Entomol Exp Appl* 80:116–119.
- McGuire SE, Le PT, Osborn AJ, Matsumoto K, Davis RL (2003) Spatiotemporal rescue of memory dysfunction in *Drosophila*. *Science* 302:1765–1768.

- 
- Mentel T, Duch C, Stypa H, Wegener G, Müller U, Pflüger H-J (2003) Central modulatory neurons control fuel selection in flight muscle of migratory locust. *J Neurosci* 23:1109–1113.
- Meunier N, Belgacem YH, Martin J-R (2007) Regulation of feeding behaviour and locomotor activity by takeout in *Drosophila*. *J Exp Biol* 210:1424–1434.
- Monastirioti M (2003) Distinct octopamine cell population residing in the CNS abdominal ganglion controls ovulation in *Drosophila melanogaster*. *Dev Biol* 264:38–49.
- Monastirioti M, Gorczyca M, Rapus J, Eckert M, White K, Budnik V (1995) Octopamine immunoreactivity in the fruit fly *Drosophila melanogaster*. *J Comp Neurol* 356:275–287.
- Monastirioti M, Linn CE, White K (1996) Characterization of *Drosophila* Tyramine  $\beta$ -Hydroxylase Gene and Isolation of Mutant Flies Lacking Octopamine. *J Neurosci* 16:3900–3911.
- Morgan TH (1910) Sex limited inheritance in *Drosophila*. *Science* (80- ) 32:120–122.
- Morgan TH (1911) An attempt to analyze the constitution of the chromosomes on the basis of sex-limited inheritance in *Drosophila*. *J Exp Zool* 11:365–413.
- Moss CF, Dethier VG (1983) Central nervous system regulation of finicky feeding by the blowfly. *Behav Neurosci* 97:541–548.
- Muscat R, Sampson D, Willner P (1990) Dopaminergic Mechanism of Imipramine Action in an Animal Model of Depression. *Biol Psychiatry* 28:223–230.
- Nagaya Y, Kutsukake M, Chigusa SI, Komatsu A (2002) A trace amine, tyramine, functions as a neuromodulator in *Drosophila melanogaster*. *Neurosci Lett* 329:324–328.
- Nässel DR, Winther AME (2010) *Drosophila* neuropeptides in regulation of physiology and behavior. *Prog Neurobiol* 92:42–104.
- Nestler EJ, Carlezon WA (2006) The mesolimbic dopamine reward circuit in depression. *Biol Psychiatry* 59:1151–1159.
- Nishimura A, Ishida Y, Takahashi A, Okamoto H, Sakabe M, Itoh M, Takano-Shimizu T, Ozaki M (2012) Starvation-induced elevation of taste responsiveness and expression of a sugar taste receptor gene in *Drosophila melanogaster*. *J Neurogenet* 26:206–215.
- Nisimura T, Seto A, Nakamura K, Miyama M, Nagao T, Tamotsu S, Yamaoka R, Ozaki M (2005) Experiential effects of appetitive and nonappetitive odors on feeding behavior in the blowfly, *Phormia regina*: a putative role for tyramine in appetite regulation. *J Neurosci* 25:7507–7516.
- O'Dell K, Burnet B (1988) The effects on locomotor activity and reactivity of the hypoactive and inactive mutations of *Drosophila melanogaster*. *Heredity (Edinb)* 61:199–207.
- Olivier B (2004) Serotonin and aggression. *Ann N Y Acad Sci* 1036:382–392.
- Orchard I, Lange AB (1985) Evidence for octopaminergic modulation of an insect visceral muscle. *J Neurobiol* 16:171–181.
-

- Orchard I, Ramirez J-M, Lange AB (1993) A Multifunctional Role For Octopamine in Locust Flight. *Annu Rev Entomol* 38:227–249.
- Ormerod KG, Hadden JK, Deady LD, Mercier AJ, Krans JL (2013) Action of octopamine and tyramine on muscles of *Drosophila melanogaster* larvae. *J Neurophysiol* 110:1984–1996.
- Osorio D, Srinivasan MV, Pinter RB (1990) What causes edge fixation in walking flies? *J Exp Biol* 149:281–292.
- Park JH, Keeley LL (1998) The effect of biogenic amines and their analogs on carbohydrate metabolism in the fat body of the cockroach *Blaberus discoidalis*. *Gen Comp Endocrinol* 110:88–95.
- Parks AL et al. (2004) Systematic generation of high-resolution deletion coverage of the *Drosophila melanogaster* genome. *Nat Genet* 36:288–292.
- Partridge L, Green A, Fowler K (1987) Effects of egg-production and of exposure to males on female survival in *Drosophila melanogaster*. *J Insect Physiol* 33:745–749.
- Perlman D, Hopper JE (1979) Constitutive Synthesis of the GAL4 Protein, a Galactose Pathway Regulator in *Saccharomyces cerevisiae*. *Cell* 16:89–95.
- Pirri JK, McPherson AD, Donnelly JL, Francis MM, Alkema MJ (2009) A tyramine-gated chloride channel coordinates distinct motor programs of a *Caenorhabditis elegans* escape response. *Neuron* 62:526–538.
- Pophof B (2000) Octopamine modulates the sensitivity of silkworm pheromone receptor neurons. *J Comp Physiol A* 186:307–313.
- Poulson DF (1950) Histogenesis, organogenesis and differentiation in the embryo of *Drosophila melanogaster*. In: Hafner Publishing Co Ltd, Wiley, New York.
- Ramirez J-M, Orchard I (1990) Octopaminergic Modulation of the Forewing Stretch Receptor in the Locust *Locusta Migratoria*. *J Exp Biol* 149:255–279.
- Ridgel AL, Ritzmann RE (2005) Effects of neck and circumoesophageal connective lesions on posture and locomotion in the cockroach. *J Comp Physiol A Neuroethol Sens Neural Behav Physiol* 191:559–573.
- Riemensperger T, Isabel G, Coulom H, Neuser K, Seugnet L, Kume K, Iché-Torres M, Cassar M, Strauss R, Preat T, Hirsh J, Birman S (2011) Behavioral consequences of dopamine deficiency in the *Drosophila* central nervous system. *Proc Natl Acad Sci U S A* 108:834–839.
- Rillich J, Stevenson PA, Pflueger H-J (2013) Flight and walking in locusts-cholinergic co-activation, temporal coupling and its modulation by biogenic amines. *PLoS One* 8:e62899.

- Robb S, Cheek TR, Hannan FL, Haii LM, Midgley JM, Evansl PD (1994) Agonist-specific coupling of a cloned *Drosophila* octopamine/tyramine receptor to multiple second messenger systems. *EMBO J* 13:1325–1330.
- Roeder T (2005) Tyramine and octopamine: ruling behavior and metabolism. *Annu Rev Entomol* 50:447–477.
- Rosenberg LA, Glusman JG, Libersat F (2007) Octopamine partially restores walking in hypokinetic cockroaches stung by the parasitoid wasp *Ampulex compressa*. *J Exp Biol* 210:4411–4417.
- Rubin GM, Spradling a C (1982) Genetic transformation of *Drosophila* with transposable element vectors. *Science* 218:348–353.
- Saper CB, Scammell TE, Lu J (2005) Hypothalamic regulation of sleep and circadian rhythms. *Nature* 437:1257–1263.
- Saraswati S, Fox LE, Soll DR, Wu C-F (2004) Tyramine and octopamine have opposite effects on the locomotion of *Drosophila* larvae. *J Neurobiol* 58:425–441.
- Saudou F, Amlaiky N, Plassat J-L, Borrelli E, R. H (1990) Cloning and characterization of a *Drosophila* tyramine receptor. *EMBO* 9:3611–3617.
- Scheiner R, Sokolowski MB, Erber J (2004) Activity of cGMP-dependent protein kinase (PKG) affects sucrose responsiveness and habituation in *Drosophila melanogaster*. *Learn Mem* 11:303–311.
- Scheiner R, Steinbach A, Claßen G, Strudthoff N, Scholz H (2014) Octopamine indirectly affects proboscis extension response habituation in *Drosophila melanogaster* by controlling sucrose responsiveness. *J Insect Physiol*.
- Schildkraut JJ (1965) The Catecholamine Hypothesis of Affective Disorders: A Review of Supporting Evidence. *Am J Psychiatry* 122:509–522.
- Schneider A, Ruppert M, Hendrich O, Giang T, Ogueta M, Hampel S, Vollbach M, Büschges A, Scholz H (2012) Neuronal basis of innate olfactory attraction to ethanol in *Drosophila*. *PLoS One* 7:e52007.
- Scholz H (2005) Influence of the biogenic amine tyramine on ethanol-induced behaviors in *Drosophila*. *J Neurobiol* 63:199–214.
- Schroll C, Riemensperger T, Bucher D, Ehmer J, Völler T, Erbguth K, Gerber B, Hendel T, Nagel G, Buchner E, Fiala A (2006) Light-induced activation of distinct modulatory neurons triggers appetitive or aversive learning in *Drosophila* larvae. *Curr Biol* 16:1741–1747.
- Schwaerzel M, Monastirioti M, Scholz H, Friggi-Grelin F, Birman S, Heisenberg M (2003) Dopamine and octopamine differentiate between aversive and appetitive olfactory memories in *Drosophila*. *J Neurosci* 23:10495–10502.

- Selcho M, Pauls D, El Jundi B, Stocker RF, Thum AS (2012) The role of octopamine and tyramine in *Drosophila* larval locomotion. *J Comp Neurol* 520:3764–3785.
- Selcho M, Pauls D, Huser A, Stocker RF (2014) Characterization of the octopaminergic and tyraminerbic neurons in the central brain of *Drosophila* larvae.
- Shulman JM, De Jager PL, Feany MB (2011) Parkinson's disease: genetics and pathogenesis. *Annu Rev Pathol* 6:193–222.
- Simpson SJ, James S, Simmonds MSJ, Blaney WM (1991) Variation Selection in Chemosensitivity and the Control Behaviour in the Locust of Dietary. *Appetite* 17:141–154.
- Singewald N, Philippu A (1996) Involvement of biogenic amines and amino acids in the central regulation of cardiovascular homeostasis. *Trends Pharmacol Sci* 17:356–363.
- Sombati S, Hoyle G (1984) Generation of specific behaviors in a locust by local release into neuropil of the natural neuromodulator octopamine. *J Neurobiol* 15:481–506.
- Stern M (2009) The PM1 neurons, movement sensitive centrifugal visual brain neurons in the locust: anatomy, physiology, and modulation by identified octopaminergic neurons. *J Comp Physiol A Neuroethol Sens Neural Behav Physiol* 195:123–137.
- Stern M, Thompson KSJ, Zhou P, Watson DG, Midgley JM, Gewecke M, Bacon JP (1995) Octopaminergic neurons in the locust brain: morphological, biochemical and electrophysiological characterisation of potential modulators of the visual system. *J Comp Physiol A* 177:611–625.
- Stevenson PA, Hofmann HA, Schoch K, Schildberger K (2000) The fight and flight responses of crickets depleted of biogenic amines. *J Neurobiol* 43:107–120.
- Suster ML, Seugnet L, Bate M, Sokolowski MB (2004) Refining GAL4-driven transgene expression in *Drosophila* with a GAL80 enhancer-trap. *Genesis* 39:240–245.
- Suver MP, Mamiya A, Dickinson MH (2012) Octopamine neurons mediate flight-induced modulation of visual processing in *Drosophila*. *Curr Biol* 22:2294–2302.
- Tangri KK, Gupta GP, Vrat S (1989) Role of histamine receptor in mesencephalic nucleus dorsalis raphe in cardiovascular regulation. *Arch Pharmacol* 339:557–563.
- Thibault ST et al. (2004) A complementary transposon tool kit for *Drosophila melanogaster* using P and piggyBac. *Nat Genet* 36:283–287.
- Thompson SN (2003) Trehalose – The Insect “ Blood ” Sugar. *Adv In Insect Phys* 31:205–285.
- Turelli M, Barton NH (2004) Polygenic variation maintained by balancing selection: pleiotropy, sex-dependent allelic effects and G x E interactions. *Genetics* 166:1053–1079.

- 
- Unoki S, Matsumoto Y, Mizunami M (2006) Roles of octopaminergic and dopaminergic neurons in mediating reward and punishment signals in insect visual learning. *Eur J Neurosci* 24:2031–2038.
- Van Swinderen B, Brembs B (2010) Attention-like deficit and hyperactivity in a *Drosophila* memory mutant. *J Neurosci* 30:1003–1014.
- Van Swinderen B, McCartney A, Kauffman S, Flores K, Agrawal K, Wagner J, Paulk A (2009) Shared visual attention and memory systems in the *Drosophila* brain. *PLoS One* 4:e5989.
- Volkow ND, Wang G, Fowler JS, Fischman M, Foltin R, Abumrad NN, Gatley SJ, Logan J, Wong C, Gifford A, Hitzemann R, Pappas N (1999) Methylphenidate and Cocaine Have a Similar in vivo Potency to Block Dopamine transporters in the Human Brain. *Life Sci* 65:7–12.
- Volkow ND, Wang G-J, Fischman MW, Foltin RW, Fowler JS, Abumrad NN, Vitkun S, Logan J, Gatley SJ, Pappas N, Hitzemann R, Shea CE (1997) Relationship between subjective effects of cocaine and dopamine transporter occupancy. *Nature* 386:827–830.
- Wallace BG (1976) The biosynthesis of octopamine - characterization of lobster tyramine beta-hydroxylase. *J Neurochem* 26:761–770.
- Weinstein A (1918) Coincidence of Crossing Over in *Drosophila* (*Ampelophila*). *Genetics* 3:135–172.
- Whim MD, Evans PD (1988) Octopaminergic Modulation of Flight Muscle in the Locust. *J Exp Biol* 134:247–266.
- Woodring JP, McBride LA, Fields P (1989) The role of octopamine in handling and exercise-induced hyperglycaemia and hyperlipaemia in *Acheta domesticus*. *J Insect Physiol* 35:613–617.
- Wosnitza A, Bockemühl T, Dübbert M, Scholz H, Büschges A (2013) Inter-leg coordination in the control of walking speed in *Drosophila*. *J Exp Biol* 216:480–491.
- Zars T, Fischer M, Schulz R, Heisenberg M (2000) Localization of a Short-Term Memory in *Drosophila*. *Science* (80- ) 288:672–675.
- Zhang B, Freeman MR, Waddell S (2010) *Drosophila* Neurobiology: A Laboratory Manual. Cold Spring Harbor: Cold Spring Harbor Laboratory Press.
- Zhang T, Branch A, Shen P (2013) Octopamine-mediated circuit mechanism underlying controlled appetite for palatable food in *Drosophila*. *Proc Natl Acad Sci U S A* 110:15431–15436.
- Zhou C, Rao Y, Rao Y (2008) A subset of octopaminergic neurons are important for *Drosophila* aggression. *Nat Neurosci* 11:1059–1067.
- Zornik E, Paisley K, Nichols R (1999) Neural transmitters and a peptide modulate *Drosophila* heart rate. *Peptides* 20:45–51.
-



---

## ACKNOWLEDGEMENTS

Mein Dank geht an

Prof. Dr. Björn Brembs, der mir die Arbeit in seinem Labor ermöglicht hat mit der Freiheit, das zu forschen, was mich am meisten interessiert.

Dr. Julien Colomb für seine unerschütterliche Geduld zu erklären, zuzuhören, zu beruhigen, und zu diskutieren. Er hatte immer ein offenes Ohr und wir waren ein tolles Team!

Hildegard Hopp, meiner Ghetto-Sister, für ihr herzliches Willkommen, fürs Mutmachen und ihren steten Beistand im und ums Labor.

Marc-Nicolas Rentinck und Ben Beuster für die Hilfe am Anfang. Yasmine Graf, Julia Sigl, Lucie Dieterich, Luise Krüger, Victoria Antemann, Madeleine-Marie Gilles und Denise Bock für ihre Ausdauer an den Maschinen und die fröhliche Zusammenarbeit.

Dr. Hiromu Tanimoto, weil er sich gerne Zeit nimmt wissenschaftliches und unwissenschaftliches zu besprechen.

Andreas Kirbach für R-Instruktionen, Kickermatches und Musikoffenbarungen.

Dr. Marco Schubert für seine Ausdauer an einem never-rewarding Projekt.

Dr. Gérard Leboulle für seine Toleranz im Molekularlabor und Hilfe beim trouble shooting.

Sabrina Scholz-Kornehl für die produktive Zusammenarbeit und das ein oder andere Feierabendbier.

Dr. Jessica Erdmann, die immer gleiche Manuskriptversionen gelesen und Daten wieder und wieder diskutiert hat. Und für ihre Freundschaft.

Meinen Eltern für ihr Vertrauen und meinen Schwestern für die Hilfe beim Kampf gegen den Drachen.

Und vor allen möchte ich Patrick Wolter danken für seine unermüdliche Aufbauleistung, sein Durchhaltevermögen über die Jahre und dafür, dass er immer da war.

---