

Synthetic Oligosaccharides as Tools to Investigate Bacterial Capsular Polysaccharides and Teichoic Acids

Inaugural-Dissertation

to obtain the academic degree

Doctor rerum naturalium (Dr. rer. nat.)

Submitted to the Department of Biology, Chemistry and Pharmacy

of Freie Universität Berlin

by

Fei-Fei Xu

January, 2018

The work in this dissertation was performed between August 2014 and November 2017 under the supervision of Prof. Dr. Peter H. Seeberger in the Department of Biomolecular Systems, Max Planck Institute of Colloids and Interfaces, and the Department of Biology, Chemistry and Pharmacy, Freie Universität Berlin.

1st Reviewer: Prof. Dr. Peter H. Seeberger

2nd Reviewer: Prof. Dr. Kevin Pagel

Date of defense: 18th May, 2018

Declaration

This is to certify that the entire work in this thesis has been carried out by Fei-Fei Xu. The assistance and help received during the course of investigation have been fully acknowledged.

22.05.2018, Berlin

(Date, Place)

(Signature)

Acknowledgement

Firstly, I would like to express my sincere gratitude to Prof. Dr. Peter H. Seeberger for his guidance and support over the past three and half years. I have been always feeling lucky to work in this interdisciplinary research environment which is a prerequisite in realizing this thesis.

I am grateful to Dr. Clancy L. Pereira, my former group leader, for all the fruitful discussions and encouragement. His invaluable advice helped me a lot at various stages of my research. I would like to thank Dr. Marilda P. Lisboa and Dr. Ju Yuel Baek as my mentors for their precious instructions in the lab, Dr. Maria Bräutigam for the German translation of the summary.

I would like to thank Prof. Dr. Kevin Pagel for kindly agreeing to review this thesis.

I am thankful to my collaborators: Prof. Dr. Thilo Stehle, Interfaculty Institute of Biochemistry, Universität Tübingen; Eike Mucha and Prof. Dr. Kevin Pagel, Fritz-Haber-Institut der Max-Planck-Gesellschaft and Institute of Chemistry and Biochemistry, Freie Universität Berlin. I would also like to thank Bruna Mara Silva Seco and Katrin Sellrie for the immunological evaluation studies.

I would like to thank Olaf Niemeyer and Eva Settels for their technical support. A special thanks goes to Dorothee Böhme, for all the organizational support during my stay at the department.

I thank all the members of the Department of Biomolecular Systems of Max Planck Institute of Colloids and Interfaces, especially all the members in vaccine group, not only for their invaluable help in the lab, but also for the wonderful time out of the lab. This experience has been unforgettable to me and I will always cherish it.

Foremost, I would like to express my gratefulness to my family members and my friends. Words cannot express the feelings that I have for my parents for their constant, unconditional support. I would not be here without you.

Thank all of you!

List of publications:

A) Scientific publications

1. **Xu, F.-F.**; Pereira, C. L.; Seeberger, P. H. 1,3-Dibromo-5,5-dimethylhydantoin as promoter for glycosylations using thioglycosides. *Beilstein J. Org. Chem.* **2017**, *13*, 1994–1998.
doi:10.3762/bjoc.13.195
2. **Xu, F.-F.**; Seco, B., Pereira, C. L.; Seeberger, P. H. Development of semisynthetic glycoconjugate vaccine candidates against *Streptococcus pneumoniae* serotype 14. *Cell Chem. Bio.* In preparation.
3. Lisboa, M. P.; Khan, N.; Martin, C.; **Xu, F.-F.**; Reppe, K.; Geissner, A.; Govindan, S.; Witzenrath, M.; Pereira, C. L.; Seeberger, P. H., Semisynthetic glycoconjugate vaccine candidate against *Streptococcus pneumoniae* serotype 5. *Proc. Natl. Acad. Sci. USA* **2017**, *114*, 11063-11068.
doi: 10.1073/pnas.1706875114

B) Scientific conferences

1. Ringberg conference, Germany, 7th -11th September, 2015: “Synthesis of Trimer of D-Ribitol-5-phosphate and its Binding Mode with Glycosyltransferase TarP” (Oral presentation)

Table of Contents

Table of Contents	1
List of abbreviations	5
Summary	9
Zusammenfassung	13
Chapter 1	17
Introduction	17
1.1 Cell surface polysaccharides of Gram-positive bacteria	17
1.2 Capsular polysaccharide-based vaccines	19
1.2.1 Polysaccharide vaccines	20
1.2.2 Glycoconjugate vaccines	20
1.2.3 Semisynthetic glycoconjugate vaccines	22
1.2.4 Rational design of semisynthetic glycoconjugate vaccines	23
1.3 Oligosaccharide synthesis	25
1.3.1 Glycosylation reaction	25
1.3.2 Glycosyl donors	26
1.3.3 Reaction conditions	27
1.3.4 Solid-phase oligosaccharide synthesis	28
1.3.5 Automated glycan assembly (AGA)	30
1.4 Objectives of this thesis	32
Chapter 2	35
Development of semisynthetic glycoconjugate vaccine candidates against <i>Streptococcus pneumoniae</i> serotype 14	35
2.1 Introduction	35
2.1.1 <i>Streptococcus pneumoniae</i>	35
2.1.2 Vaccines against <i>S. pneumoniae</i>	36

2.1.3 <i>S. pneumoniae</i> serotype 14	37
2.1.4 Bridging systems in carbohydrates.....	38
2.1.5 Bridging repeating units (RUs) as novel glycoconjugate vaccine candidates against ST-14.....	42
2.2 Results and discussion.....	43
2.2.1 Synthetic strategy	43
2.2.2 Preparation of building blocks.....	44
2.2.3 Assembly of oligosaccharide derivatives	46
2.2.4 Antigenic evaluation.....	49
2.2.5 Immunological evaluation of the glycoconjugates in mice	51
2.3 Conclusion.....	57
2.4 Experimental section.....	57
2.4.1 Chemistry experiments	57
2.4.2 Biochemistry experiments	85
Chapter 3	89
Synthesis of D-ribitol-5-phosphate trimer and X-ray crystallographic analysis of its interaction with the TarP glycosyltransferase	89
3.1 Introduction.....	89
3.1.1 Teichoic acids of Gram-positive bacteria.....	89
3.1.2 Structure of wall teichoic acids	90
3.2 Results and discussion.....	93
3.2.1 Retrosynthetic analysis.....	93
3.2.2 Synthesis of D-ribitol 5-phosphate trimer (70).....	94
3.2.3 Interaction of glycosyltransferase TarP and synthetic WTA fragment.....	96
3.3 Conclusion.....	97
3.4 Experimental section.....	97
Chapter 4	105

1,3-Dibromo-5,5-dimethylhydantoin as promoter for glycosylations using thioglycosides	105
4.1 Introduction.....	105
4.1.1 Thioglycosides and promoters.....	105
4.1.2 1,3-Dibromo-5,5-dimethylhydantoin (DBDMH).....	106
4.2 Results and discussion.....	107
4.2.1 Optimization of glycosylation conditions.....	107
4.2.2 1,2- <i>Trans</i> glycosylation.....	108
4.2.3 1,2- <i>Cis</i> glycosylation.....	109
4.2.4 Automated glycan assembly using DBDMH.....	112
4.2.5 Hydrolysis of glycosyl selenide with DBDMH.....	113
4.3 Conclusion.....	114
4.4 Experimental section.....	114
4.4.1 Preparation of building blocks.....	114
4.4.2 General glycosylation procedure.....	119
4.4.3 1,2- <i>Trans</i> glycosylation.....	119
4.4.4 1,2- <i>Cis</i> glycosylation.....	129
4.4.5 Solid-phase automated glycan assembly.....	132
4.4.6 Hydrolysis of glycosyl selenide.....	134
Chapter 5	137
Catching elusive glycosyl oxocarbenium ions via cold-ion infrared spectroscopy ..	137
5.1 Introduction.....	137
5.1.1 Glycosyl oxocarbenium ions.....	137
5.1.2 Cold-ion infrared spectroscopy and its experimental setup.....	139
5.2 Results and discussion.....	141
5.2.1 Design of monosaccharide library.....	141
5.2.2 Synthesis of monosaccharides.....	142

5.2.3 Cold-ion infrared spectra	145
5.3 Conclusion.....	146
5.4 Experimental section.....	146
Chapter 6	165
Conclusion and outlook	165
7 Appendix	169
7.1 Introduction.....	169
7.2 Results and discussion.....	170
7.3 Experimental section.....	171
References	178

List of abbreviations

ABD	Antithrombin III binding domain
AGA	Automated glycan assembly
APC	Antigen-presenting cell
AT-III	Antithrombin III
BAIB	Bis(acetoxy)iodobenzene
BCR	B cell receptor
BSA	Bovine serum albumin
CMPI	2-Chloro-1-methylpyridinium iodide
CPS	Capsular polysaccharide
CRM197	Non-toxic mutant of diphtheria toxoid
CsF	Cesium fluoride
DABCO	1,4-Diazabicyclo[2.2.2]octane
DBDMH	1,3-Dibromo-5,5-dimethylhydantoin
DCC	<i>N,N'</i> -Dicyclohexylcarbodiimide
DCM	Dichloromethane
DDQ	2,3-Dichloro-5,6-dicyano-1,4-benzoquinone
DHAP	2,4-Dihydroxyacetophenone
DIPEA	<i>N,N</i> -Diisopropylethylamine
DMAP	4-Dimethylaminopyridine
DMF	Dimethylformamide
DMSO	Dimethyl sulfoxide
DMT	4,4'-Dimethoxytrityl

DMTST	Dimethyl(thiomethyl)sulfonium triflate
DT	Diphtheria toxoid
ELISA	Enzyme-linked immunosorbent assay
ELLA	Enzyme-linked lectin assays
Fmoc	9-Fluorenylmethyloxycarbonyl
GMP	Good manufacturing practice
GroP	Glycerol phosphate
GT	Glycosyltransferase
HATU	1-[Bis(dimethylamino)methylene]-1 <i>H</i> -1,2,3-triazolo[4,5- <i>b</i>]pyridinium 3-oxid hexafluorophosphate
Hib	<i>Haemophilus influenzae</i> type b
HOBt	Hydroxybenzotriazole
HPLC	High-performance liquid chromatography
HRMS	High resolution mass spectrometry
IDCP	Iodonium dicollidine perchlorate
IDCTf	Iodonium dicollidine triflate
IPD	Invasive pneumococcal disease
IRMPD	Infrared multiple photon dissociation
Lev	Levulinoyl
LPS	Lipopolysaccharide
LTA	Lipoteichoic acid
MALDI-TOF MS	Matrix-assisted laser desorption/ionization-time of flight mass spectrometry
MFI	Mean fluorescence intensity
MHC	Major histocompatibility complex
MRSA	Methicillin-resistant <i>Staphylococcus aureus</i>

NAP	2-Naphthylmethyl
NBS	<i>N</i> -Bromosuccinimide
NIS	<i>N</i> -Iodosuccinimide
PBS	Phosphate buffered saline
PCV	Pneumococcal conjugate vaccine
PG	Peptidoglycan
PMB	4-Methoxybenzyl ether
Pn14PS	Capsular polysaccharide of <i>S. pneumoniae</i> serotype 14
PPV	Pneumococcal polysaccharide vaccine
PyBOP	Benzotriazol-1-yl-oxytripyrrolidinophosphonium hexafluorophosphate
RboP	Ribitol phosphate
rhMMR	Relevant human macrophage mannose receptor
RU	Repeating unit
SDS-PAGE	Sodium dodecyl sulfate polyacrylamide gel electrophoresis
SEM	Scanning electron microscope
SFC	Supercritical fluid chromatography
ST-14	<i>S. pneumoniae</i> serotype 14
TA	Teichoic acid
TBAF	Tetrabutylammonium fluoride
TBD	Thrombin-binding domain
TCA	Trichloroacetyl
TDS	<i>Tert</i> -Butyldimethylsilyl ether
TEA	Triethylamine
TEMPO	(2,2,6,6-Tetramethylpiperidin-1-yl)oxyl

List of abbreviations

Tf	Trifluoromethanesulfonyl
THF	Tetrahydrofuran
TLC	Thin-layer chromatography
TMS	Trimethylsilyl
Tol	Toluene
Ts	Tosyl
TT	Tetanus toxoid
WGA	Wheat germ agglutinin
WTA	Wall teichoic acid

Summary

Bacterial polysaccharides represent a diverse range of macromolecules that include peptidoglycans (PGs), lipopolysaccharides (LPSs), teichoic acids (TAs) and capsular polysaccharides (CPSs). Their functions range from structural cell-wall components, important virulence factors, to permitting the bacterium to survive in harsh environments. Identifying and harnessing their structural and functional features of bacterial polysaccharides offers excellent opportunities for developing new vaccines and diagnostics in the fight against severe infectious diseases, such as sepsis, pneumonia, anthrax and tuberculosis.

As major virulence factors, CPSs which consist of repeating units (RUs) have been investigated to confer immunological protection against the pathogens. To date, several licensed vaccines based on isolated CPSs are available against pathogenic bacteria such as *Streptococcus pneumoniae*. One major obstacle in current vaccine manufacture is the isolation and purification of pure CPSs from pathogens on sufficient scale. As the pertinent immunogenic epitopes comprise only part of the polysaccharides, synthetic oligosaccharides with defined structures have emerged as an attractive option with the potential to understand glycan immunology and rationally engineer efficacious vaccines. In the first part of this work, a unique design aspect was considered to develop novel semisynthetic glycoconjugate vaccine candidates wherein RUs were bridged using an aliphatic spacer via an amide linkage (Figure 1), thereby eliminating the laborious and challenging glycosidic linkage formation. The branched tetrasaccharide RU of CPS from *S. pneumoniae* serotype 14 (ST-14), which was reported as the smallest core structure required to induce specific antibodies, has been chosen as the target to synthesize spacer bridged oligosaccharide derivatives. These synthetic CPS fragment derivatives were conjugated to carrier protein CRM197 to obtain vaccine candidates against ST-14. The immunological evaluation of these novel glycoconjugates was carried out in mice.

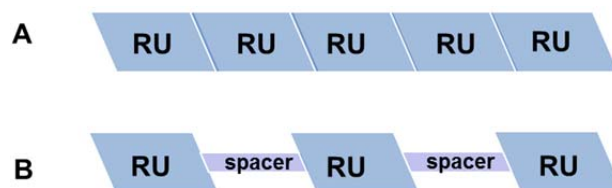

Figure 1: Schematic structure of (A) natural capsular oligosaccharide and (B) spacer bridged RUs.

Along with CPSs, TAs are also viable targets that can be used to fight against disease caused by Gram-positive bacteria. The most common repeating units of wall teichoic acids (WTAs) are glycerol-phosphate (GroP) or ribitol-phosphate (RboP). The hydroxyls of GroP and RboP are usually tailored with cationic D-alanine esters and monosaccharides, commonly glucose or *N*-acetylglucosamine. Particularly, nearly all the RboP units in *Staphylococcus aureus* contain *O*-GlcNAc. In order to better understand their roles and functions, a fragment of WTA, trimer of RboP, was synthesized to decipher their biosynthesis process in the second part of this work. The synthetic fragment was soaked into the TarP glycosyltransferase, which has been recently discovered to modify RboP with *O*-GlcNAc in *S. aureus*, to characterize their binding domain (Figure 2). Site-directed mutagenesis experiments of TarP revealed critical residues (D181, R159 and Y152) for enzyme activity.

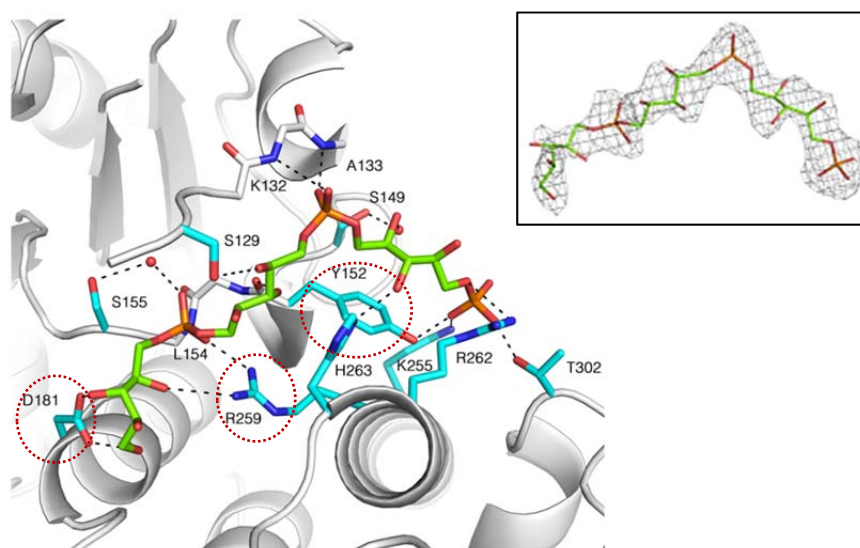

Figure 2: Interaction of active site residues of TarP with synthetic trimer of RboP. OMIT map of synthetic trimer of RboP (contoured at 3σ) is provided (Inset).

Access to large amounts of well-defined oligosaccharides is a prerequisite for understanding their roles in biological process of the pathogen, thereby combating the harmful bacteria. Despite the progress that has been made in carbohydrate chemistry, still very little is known about controlling glycosylation reactions as the reaction conditions, which are developed for one substrate, are not amenable or general enough for others as would be in

the case of peptide and oligonucleotide synthesis. Efforts have been made from two different angles in order to better understand the whole process of glycosylation reaction in this work. The inexpensive reagent, 1,3-dibromo-5,5-dimethylhydantoin (DBDMH), has been demonstrated to be a powerful promoter for the activation of thioglycosides both in solution and in automated glycan assembly on solid phase in *Chapter 4* (Figure 3). A variety of glycosyl donors containing diverse protecting groups have been investigated with promising results, while the stereoselectivity follows reported trends. Compared with *N*-iodosuccinimide (NIS), which is a common method for thioglycoside activation, this promoter is readily available, highly soluble, and shelf-stable.

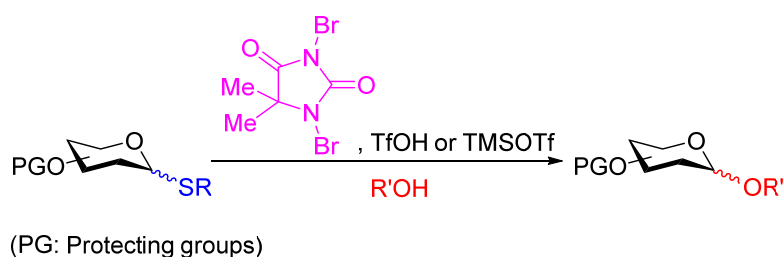

Figure 3: 1,3-Dibromo-5,5-dimethylhydantoin (DBDMH) as promoter for thioglycosides.

Along the same line, *Chapter 5* gives an insight into the mechanism behind glycosylation reaction in depth by catching glycosyl cations using ultra-cold infrared spectroscopy. It is generally accepted that the reaction involves oxocarbenium ions as intermediate, which, however, have not been observed yet. To get empirical evidence for the mechanism, a library of monosaccharide donors with different protecting-group patterns has been synthesized to generate and characterize their glycosyl cations by cold-ion infrared spectroscopy. Thus, if one understands the process of glycosylation on a molecular level, a universal method might be able to be developed, which could immensely facilitate the development of the glycosciences.

Zusammenfassung

Zu den bakteriellen Polysacchariden gehört eine Vielzahl an Makromolekülen, unter anderem Peptidoglycane (PG), Lipopolysaccharide (LPS), Teichonsäuren (TA) und Kapselpolysaccharide (CPS). Diese können zum Beispiel als strukturelle Komponenten der Zellwand oder als wichtige Virulenzfaktoren dienen oder dem Bakterium ein Überleben auch unter schwierigen Bedingungen ermöglichen. Können die strukturellen und funktionalen Eigenschaften der bakteriellen Polysaccharide identifiziert und nutzbar gemacht werden, bietet dies exzellente Möglichkeiten zur Entwicklung neuer Impfstoffe und diagnostischer Hilfsmittel im Kampf gegen Infektionskrankheiten wie Sepsis, Pneumonie, Anthrax und Tuberkulose.

CPSs sind als wichtige Virulenzfaktoren, die aus sich wiederholenden Einheiten (repeating units, RUs) aufgebaut sind, besonders interessant für die Impfstoffentwicklung. Derzeit sind mehrere Impfstoffe gegen pathogene Bakterien wie *Streptococcus pneumoniae*, die auf isolierten CPSs basieren, auf dem Markt. Eine große Hürde für die moderne Impfstoffherstellung ist dabei die Isolierung und Aufreinigung der CPSs von Krankheitserregern in hinreichendem Maßstab. Da nur ein Teil der Polysaccharide eines Bakteriums auch relevante und immunogene Epitope darstellen, gewinnen synthetische Oligosaccharide mit definierter Struktur an Bedeutung. Diese können als eine attraktive Grundlage dienen, die Immunologie der Glycane besser zu verstehen und effiziente Impfstoffe zu entwickeln. Im ersten Teil der vorliegenden Arbeit wurden RUs eines Polysaccharids unter Zuhilfenahme eines aliphatischen Spacers über Amidbindungen verknüpft (Abbildung 1). Dieses neuartige Design erlaubt die Entwicklung semisynthetischer Glykokonjugat-Impfstoffe und umgeht dabei die aufwändigen und anspruchsvollen Glycosylierungsreaktionen. Als erstes Zielmolekül für die Synthese dieser über einen Spacer verknüpften Polysaccharide wurde die aus einem Tetrasaccharid bestehende, verzweigte RU des CPS von *S. pneumoniae* Serotyp 14 (ST-14), die als kleinste notwendige Struktur, um die Bildung spezifischer Antikörper auszulösen, identifiziert wurde, ausgewählt. Diese synthetischen CPS Fragment-Derivate wurden an das Carrier-Protein CRM197 gebunden, um Impfstoff-Kandidaten zu enthalten. Die immunologische Testung dieser neuartigen Glykokonjugate wurde in Mäusen durchgeführt.



Abbildung 1: Schematische Struktur der (A) natürlichen Kapselpolysaccharide und (B) der über Spacer verknüpfte RUs.

Neben CPSs gehören auch TAs zu den interessanten Zielstrukturen, die genutzt werden können, um von Gram-positiven Bakterien verursachte Krankheiten zu bekämpfen. Die in Wandteichonsäuren (WTAs) am häufigsten vorkommenden sich wiederholenden Einheiten bestehen aus Glycerinphosphat (GroP) und Ribitphosphat (RboP). Die Hydroxygruppen von GroP und RboP sind in den meisten Fällen mit kationischen D-Alaninestern und Monosacchariden, häufig Glucose oder *N*-Acetylglucosamin, bestückt. Besonders die RboP Einheiten in *Staphylococcus aureus* enthalten fast alle *O*-GlcNAc. Im zweiten Teil dieser Arbeit wurde ein WTA-Fragment, ein Trimer von RboP, synthetisiert, um die Funktion der WTAs genauer zu erforschen und um die Biosynthese zu entschlüsseln. Durch Soaking wurden Protein-Liganden-Kristalle von dem synthetisierten Fragment und TarP-Glycosyltransferase, welche in *S. aureus* RboP mit *O*-GlcNAc modifiziert, erhalten, wodurch die Bindungsdomäne des Proteins charakterisiert werden konnte (Abbildung 2). Darüber hinaus konnten durch zielgerichtete Mutagenese-Experimente mit TarP die für die enzymatische Aktivität entscheidenden Aminosäuren identifiziert werden.

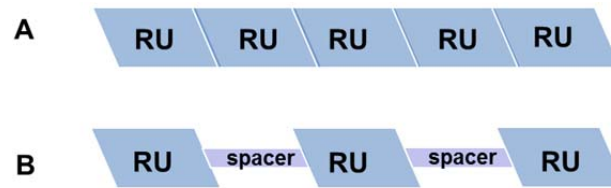

Abbildung 2: Interaktion der Aminosäurereste im aktiven Zentrum von TarP mit dem synthetischen RboP-Trimer. OMIT Map des synthetischen RboP-Trimers (Konturlevel: 3σ) ist verzeichnet (Inset).

Eine Grundvoraussetzung, um die Rolle von Glycanen in biologischen Prozessen weiter erforschen zu können und damit pathogenen Bakterien etwas entgegen setzen zu können, ist Zugang zu definierten Oligosacchariden in größeren Mengen. Auch wenn auf dem Gebiet der Kohlenhydratchemie in der Vergangenheit viele Erfolge erzielt wurden, sind die genauen Mechanismen, wie Glycosylierungen beeinflusst werden können, nicht vollständig geklärt. So können Reaktionsbedingungen, die für ein Substrat optimiert wurden, nicht generell auf andere übertragen werden, wie das in der Peptid- und Oligonucleotid-Synthese der Fall ist. In der vorliegenden Arbeit wurden zwei Ansätze verfolgt, um Einsicht in den Glycosylierungs-Prozess zu gewinnen. In *Kapitel 4* wird gezeigt, dass das kostengünstige 1,3-Dibrom-5,5-dimethylhydantoin (DBDMH) sowohl in der Flüssigphasensynthese als auch in der automatisierten Festphasensynthese erfolgreich als leitungsstarker Promoter für die Aktivierung von Thioglycosiden eingesetzt werden kann (Abbildung 3). Verschiedene Glycosylbausteine, die mit unterschiedlichen Schutzgruppen ausgestattet wurden, zeigten bei Aktivierung mit DBDMH vielversprechende Ergebnisse, während die Stereoselektivität der Reaktionen den in der Literatur bekannten Tendenzen entsprach. Verglichen mit *N*-Iodsuccinimid (NIS), das häufig zur Aktivierung von Thioglycosiden eingesetzt wird, ist dieser Promoter leicht zugänglich, sehr gut löslich und auch bei Raumtemperatur stabil in Lösung.

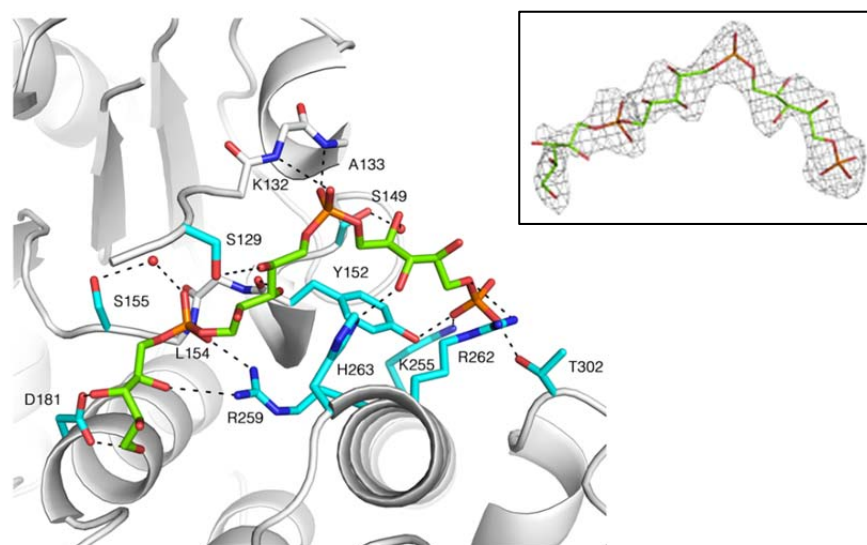

Abbildung 3: 1,3-Dibrom-5,5-dimethylhydantoin (DBDMH) als Promoter für Thioglycoside.

In ähnlicher Weise gibt *Kapitel 5* weitere Einsichten in den Mechanismus, der Glycosylierungen zugrunde liegt, indem mittels Kaltionen-Spektroskopie IR-Spektren von Glycosylkationen aufgezeichnet wurden. Es wird generell angenommen, dass bei diesen Reaktionen intermediär Oxocarbenium-Ionen entstehen, dies konnte bis jetzt allerdings nicht nachgewiesen werden. Um die Existenz dieser Kationen empirisch zu beweisen, wurde ein Satz an Monosacchariden, die alle unterschiedliche Schutzgruppen tragen, syntheti-

siert und in Glycosylkationen überführt und diese dann mittels Kaltionen-Spektroskopie charakterisiert. Kann auf diese Weise der Prozess der Glycosylierungsreaktion auf molekularer Ebene aufgeklärt werden, könnte dies die Entwicklung einer universalen Methode ermöglichen und so Kohlenhydratchemie in Zukunft deutlich erleichtern.

Chapter 1

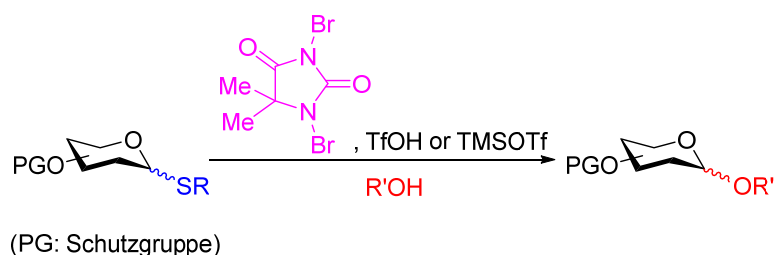
Introduction

1.1 Cell surface polysaccharides of Gram-positive bacteria

Surface polysaccharides, such as lipopolysaccharides (LPSs), capsular polysaccharides (CPSs) and teichoic acids (TAs), represent the predominant structures on bacterial cell envelopes, and they are often important players in the interactions between pathogens, their hosts and the environment. The role of these glycan moieties in symbiosis, pathogenesis, biofilm formation, cell-cell interactions and evasion of the immune response¹⁻⁴ is just beginning to be understood. The structures and compositions of cell envelopes are quite diverse between different bacterial species. This dissertation focuses on surface polysaccharides of Gram-positive bacteria.

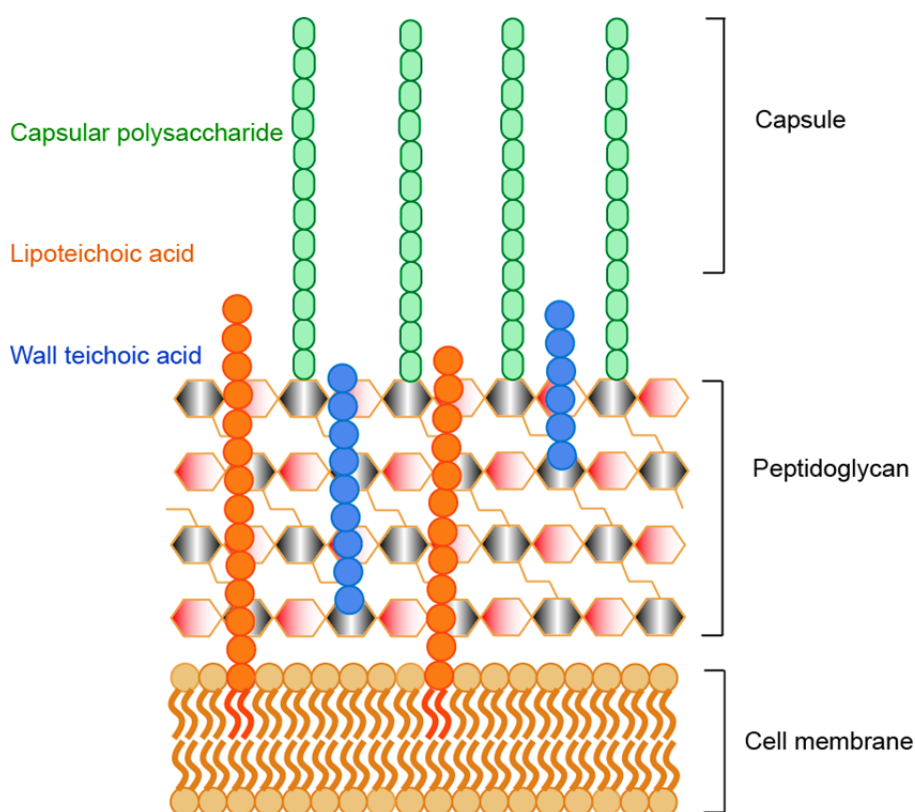

Figure 1.1: Schematic representation of cell surface of Gram-positive bacteria.

The Gram-positive cell wall (Figure 1.1), layered on top of cytoplasmic membrane, is mainly composed of a 20-80 nm thick layer of peptidoglycans (PGs). TAs (discussed further in *Chapter 4*) are anionic glycopolymers: lipoteichoic acids (LTAs) are anchored by lipids in the cytoplasmic membrane, while wall teichoic acids (WTAs) are covalently linked to PGs.

CPSs are lying outside the cell wall of bacteria. In the early 1920s, Heidelberger reported the purification of the soluble specific substance from pneumococcus-capsular polysaccharide.⁵ Thanks to advances in structural biochemistry and carbohydrate chemistry, many CPSs have been chemically characterized.³ The molecular compositions of CPSs, which are made of either monosaccharides^{6, 7} or from repeating units (RUs) normally consisting of two to six sugar residues, vary extensively between organisms and even between strains within a single species (Figure 1.2).⁸⁻¹¹

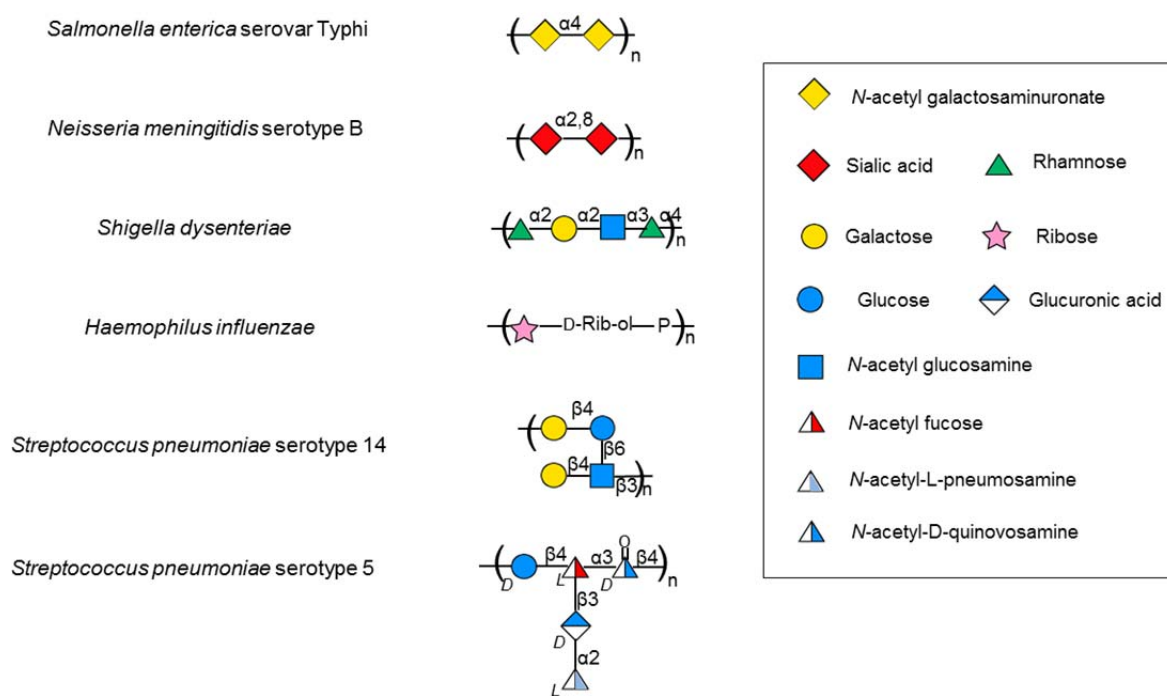

Figure 1.2: Capsular polysaccharide repeating units associated with particular species of bacteria. In fact, CPSs can be found in both Gram-positive (*S. pneumoniae*) and Gram-negative (*S. typhi*, *N. meningitides*, *S. dysenteriae* and *H. influenzae*) bacteria.

1.2 Capsular polysaccharide-based vaccines

It is well established that CPSs are major virulence factors. Immunity against their components confers protection against the pathogens. The CPS structural diversities, such as variations in RU composition, ring forms, glycosidic linkage positions and anomeric configurations, contribute to differences in the immune response to these polysaccharides.

Early in 1920s and 1930s, the immunological properties of bacterial CPSs were observed.^{12, 13} It was evident that vaccination with pneumococcal capsular polysaccharides could elicit persistent antibody-mediated immunity to reduce the carrier rate of bacteria of the same types as in the vaccine.¹⁴ Despite these key discoveries, the advent of chemotherapeutics and antibiotics during the same period had dampened enthusiasm for developing vaccines. In 1970s, the steady increase in antibiotic resistance has indicated that antibiotics alone will not be able to eradicate pathogenic bacteria, which has catalyzed a renewed interest in carbohydrate vaccine development against a wide range of pathogens. Advances in immunology with delineation of B and T lymphocyte responses, and the role of T lymphocytes for immunological memory, as well as the structural elucidation of various surface polysaccharides have made possible the development of capsular polysaccharide-based vaccines. Several licensed vaccines based either on purified CPSs or on their glycoconjugates are commercially available (Table 1.1).¹⁵

Indication	Vaccine	Manufacturer (Trade name)
<i>Haemophilus influenzae</i> type b (Hib)	Glycoconjugate, polysaccharide with tetanus toxoid (TT)	Sanofi Pasteur (ActHIB); GlaxoSmithKline Biologicals (Hiberix)
	Diphtheria toxoid (DT), TT and acellular pertussis adsorbed, inactivated poliovirus and Hib-TT conjugate vaccine	Sanofi Pasteur (Pentacel)
	Hib conjugate (meningococcal protein conjugate)	Merck & Co (PedvaxHIB)
	Hib conjugate (meningococcal protein conjugate) and hepatitis B (recombinant) vaccine	Merck & Co (Comvax)
<i>Neisseria meningitidis</i> A, C, Y and W-135	Glycoconjugate, meningococcal polysaccharide with DT	Sanofi Pasteur (Menactra)
	Meningococcal polysaccharide	Sanofi Pasteur (Menomune-A/C/Y/W-135)
<i>Salmonella typhi</i>	Vi capsular polysaccharide	Sanofi Pasteur (TYPHIM Vi)
<i>Streptococcus pneumoniae</i> 4, 6B, 9V, 14, 18C, 19F and 23F	Pneumococcal polysaccharide 7-valent-CRM197 conjugate	Wyeth Pharmaceuticals (Prenvar)
<i>Streptococcus pneumoniae</i> 1, 2, 3, 4, 5, 6B, 7F, 8, 9N, 9V, 10A, 11A, 12F, 14, 15B, 17F, 18C, 19F, 19A, 20, 22F, 23F and 33F	Pneumococcal polysaccharide, 23-valent	Merck & Co (Pneumovax 23)

Table 1.1: Licensed CPS-based vaccines. CRM197: non-toxic mutant of DT. (Reprinted from ref. 15)

1.2.1 Polysaccharide vaccines

Capsular polysaccharide vaccines are a unique type of inactivated subunit vaccines composed of long chains of sugar molecules isolated from pathogens. In 1983, the first polysaccharide vaccine, PneumoVax (Merck & Co.), was commercially launched. This vaccine was composed of capsular polysaccharides isolated from 14 pneumonia serotypes, while the current incarnation includes 23 out of approximately 95 known serotypes.^{16, 17} This vaccine induces protection against almost 90% of infections in adults. But in high-risk groups (children under two year-old, the elderly and immunocompromised people), polysaccharide vaccines generally elicit poor antibody response and could not induce adequate protection.¹⁸

The poor antibody response to polysaccharides is largely attributed to the T-cell independent immune response. Highly repetitive polysaccharide antigen units are recognized by antigen-presenting cells (APCs), including B cells, dendritic cells and macrophages. After recognition by an APC, these polysaccharides are endocytosed, depolymerized into smaller molecules ($\approx 10\text{-}15$ kDa) and presented on the surface of APCs for B-cell recognition¹⁹, causing B-cell receptors (BCRs) to crosslink and begin production of IgM antibodies (Abs). Without activation of CD4⁺ helper T cells^{3, 20}, the immune responses are less robust, short-lived and primarily consist of IgM Abs, with minimal IgG class switching. Therefore, the inability of polysaccharides to induce the activation of the adaptive immune machinery is a major impediment to their use in pure form.

1.2.2 Glycoconjugate vaccines

In the early 1980s, isolated CPSs from pathogens were conjugated to carrier proteins²¹⁻²³ inspired by the hapten-carrier protein conjugation strategy^{24, 25} to recruit CD4⁺ T cells for antibody responses. Over the past 20 years, several glycoconjugates (Table 1.1) have been introduced into clinical use³ and they have played an enormous role in preventing

infectious diseases caused by highly virulent pathogens such as *H. influenzae*, *N. meningitidis* and *S. pneumoniae*.²⁶

Inactivated bacterial toxoids, such as denatured diphtheria toxoid (DT) and tetanus toxoid (TT), and the non-toxic DT mutant CRM197 are widely used carrier proteins due to their potency to induce T cell activation.²⁷ Recognition of the glycan moiety by BCRs followed by internalization, the glycoconjugates are depolymerized into smaller peptides or glycopeptides. These fragments are then loaded onto major histocompatibility complex (MHC) class II molecules and transported to the surface of the APC. The glycopeptide-MHCII complex can be recognized by the $\alpha\beta$ -T cell receptors (TCRs) of CD4⁺ T cells, which induce cellular and cytokine-mediated signals, thereby prompting a significant enhancement in the immune response with promotion of polysaccharide-specific IgM-to-IgG class switching, long-lived responses, leading to immunogenicity in children and the elderly (Figure 1.3).^{28, 29}

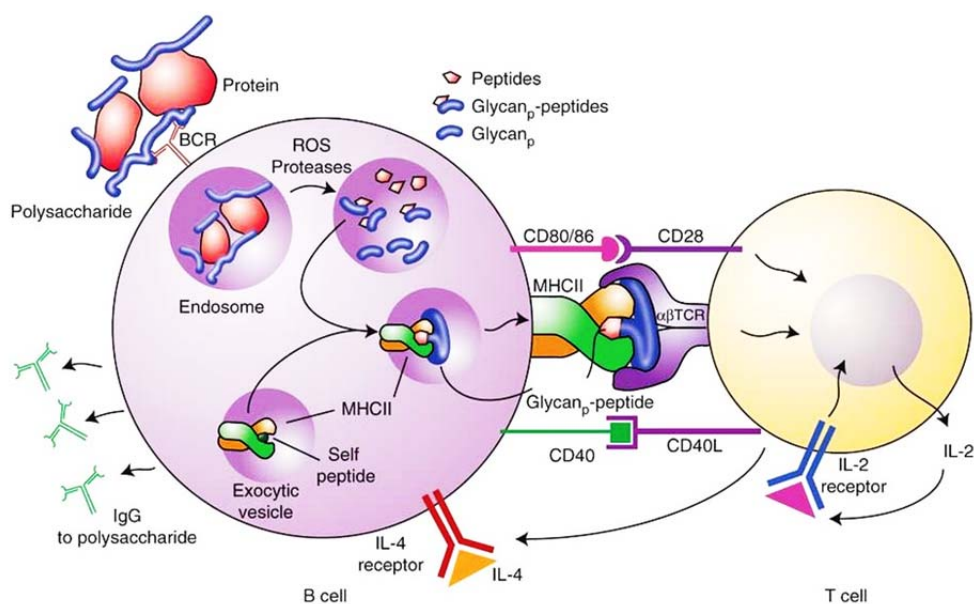

Figure 1.3: T-cell dependent immune response to glycoconjugates. ROS: Reactive oxygen species. IL-2 and IL-4 are cytokines. (Reprinted from ref. 28)

However, there are certain disadvantages in current glycoconjugate vaccine manufacture. One major obstacle is the process of isolation and purification of pure CPSs from pathogens in sufficient scale.^{30, 31} Co-isolated impurities such as other cellular polysaccharides are frequently found in CPS preparation, but their implications on the immune system are

1.2.4 Rational design of semisynthetic glycoconjugate vaccines

Compared with isolated polysaccharides, synthetic oligosaccharides are much smaller in size. Therefore, an important step toward the design of an effective synthetic glycoconjugate vaccine is the determination of the right antigenic epitopes that lead to the production of antibodies which are specific and protect the host from the pathogen.³⁸

Glycan arrays,³⁹⁻⁴² which enable the rapid and sensitive detection of interactions between glycans and antibodies, are used for elucidation of oligosaccharide epitopes. Minute amounts of multiple synthetic glycans, which usually harbor an amino group at the reducing end, are immobilized on glass slides functionalized with *N*-hydroxysuccinimide ester via covalent linkages. After incubation with antibody-containing sample, specific antibody-glycan binding events can be detected by incubation with a fluorescence-labeled secondary antibody.⁴³⁻⁴⁵ The fluorescence intensities of different spots are quantitatively determined for relative binding evaluation (Figure 1.5).⁴⁶ With this experimental setup, glycan arrays containing a library of pathogenic glycan substructures can be used to detect antibodies binding to certain structural motifs and thereby identify the immunodominant epitopes.

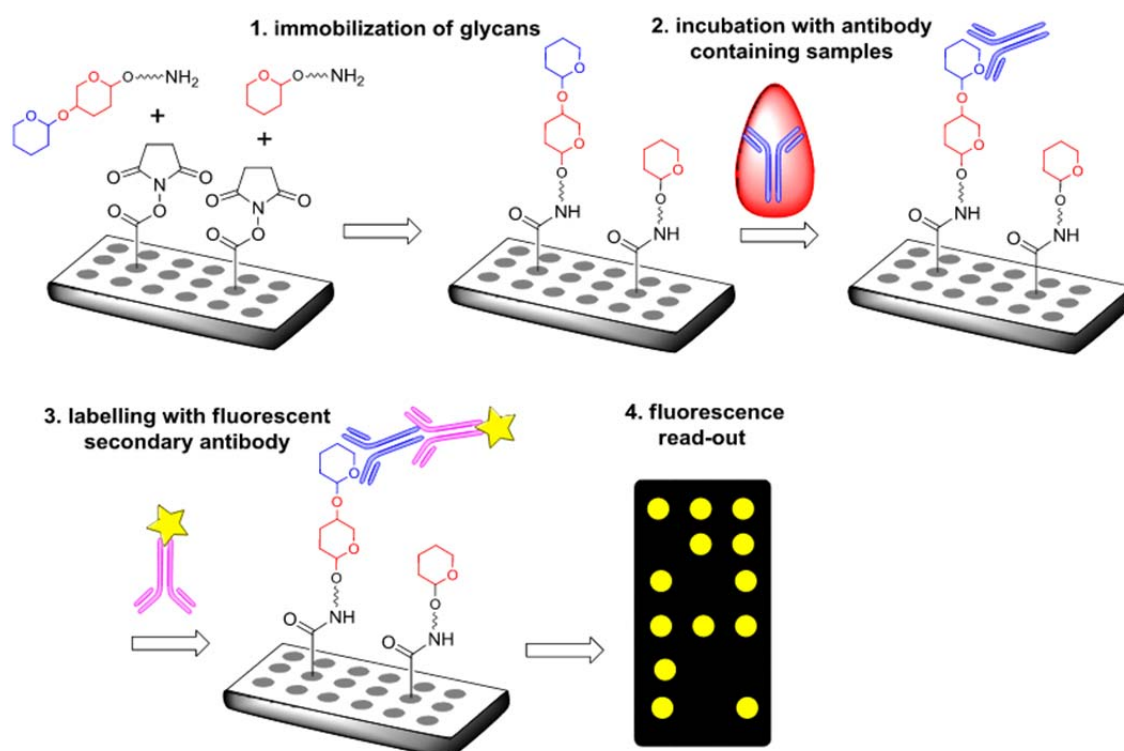
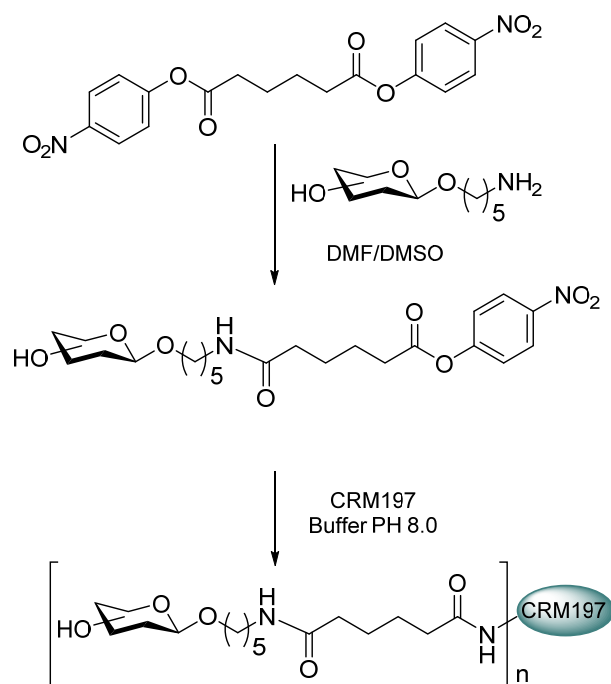

Figure 1.5: Work-flow of glycan arrays for glycan-antibody binding detection. (Reprinted from ref. 46)

After uncovering the glycotopes, the specific oligosaccharides will be conjugated to the carrier protein to produce semisynthetic glycoconjugate vaccine candidates.⁴⁷⁻⁴⁹ One of the most efficient coupling methods for preparation of glycoproteins involves the use of homobifunctional reagents,⁵⁰⁻⁵³ such as adipate 4-nitro phenyl diester (Scheme 1.1), which fulfil the following demands:

- (i) chemoselective reaction of the linker with an oligosaccharide should work without affecting unprotected hydroxyl groups;
- (ii) the activated intermediate should be sufficiently stable to permit purification of the activated oligosaccharide;
- (iii) coupling of activated oligosaccharide with proteins should proceed with good to high efficiency.



Scheme 1.1: Conjugation reaction for the preparation of glycoconjugates using *p*-nitro phenyl ester.

The glycoconjugates are prepared, formulated with adjuvants such as $\text{Al}(\text{OH})_3$ or AlPO_4 ,⁵⁴ and injected into mice or rabbits for immunological evaluation. The immune responses against the conjugates are assessed using glycan arrays and enzyme-linked immunosorbent assays (ELISA). Antibody-mediated opsonic activity and challenge long-term memory response study are further carried out to verify the functional abilities of the generated antibodies (Figure 1.6).⁵⁵

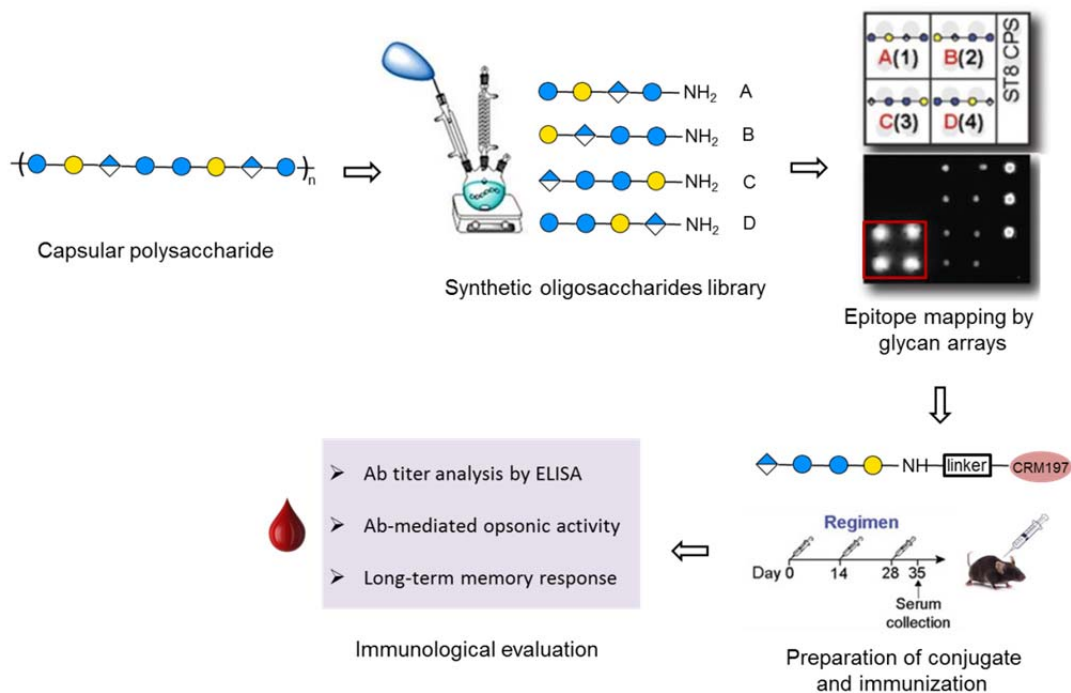

Figure 1.6: Major steps involved in preparation and evaluation of synthetic glycoconjugate vaccines.⁵⁶ Ab: antibody. (Summarized from ref. 56)

1.3 Oligosaccharide synthesis

Access to large amounts of well-defined oligosaccharides is a prerequisite for further biological studies and currently posing the major bottleneck in the advancement of the entire carbohydrate research field.

1.3.1 Glycosylation reaction

Glycosylation is the most important and the most challenging reaction in carbohydrate chemistry. It involves the reaction between a glycosyl donor and a glycosyl acceptor, in the presence of an activator or promoter, to form a glycosidic bond. Upon activation of the glycosyl donor by the promoter, departure of the leaving group results in the formation of a glycosyl cation which gets stabilized via an oxacarbenium ion intermediate. The nucleophile, glycosyl acceptor can then attack either from the top or the bottom face to form the glycosidic bond, leading to the formation of either α or β anomeric linkages (Scheme 1.2).

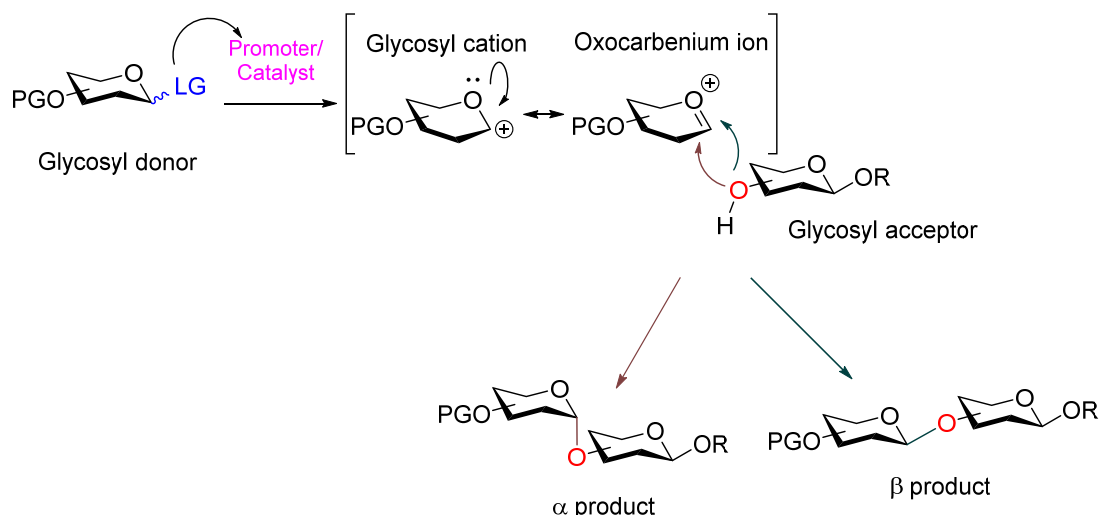

Scheme 1.2: General outline of glycosylation. LG: leaving group; PG: protecting group.

Though conceptually extremely simple, the glycosylation reaction has been frustrating chemists since Koenigs and Knorr⁵⁷ developed the first chemical glycosylation reaction at the beginning of 20th century. Three major challenges are:

- (i) regioselectivity, that is, which hydroxyl group of the glycosyl acceptor will react as the nucleophile;
- (ii) stereoselectivity, that is, whether the newly formed glycosidic linkage is α or β ;
- (iii) efficiency, that is, hydroxyl groups are not good nucleophiles. Particularly secondary hindered hydroxyl groups often result in moderate yields.

Many factors, such as glycosyl donors, promoters, protecting-group patterns and reaction conditions, determine the outcome of a glycosylation reaction.

1.3.2 Glycosyl donors

a. Leaving groups

Various types of glycosyl donors bearing different leaving groups have been developed during last few decades (Figure 1.7),^{58, 59} such as glycosyl halides^{57, 60-62}, thioglycosides⁶³, glycosyl imidates⁶⁴, alkenyl glycosides⁶⁵, alkynyl glycosides⁶⁶, glycosyl phosphites⁶⁷ or phosphates⁶⁸ and glycols⁶⁹. Among all these donors, thioglycosides are versatile glycosyl-

ating agents which are commonly used in oligosaccharide synthesis due to their accessibility, stability, compatibility with various reaction conditions, and orthogonality to other donors.^{63, 70-73}

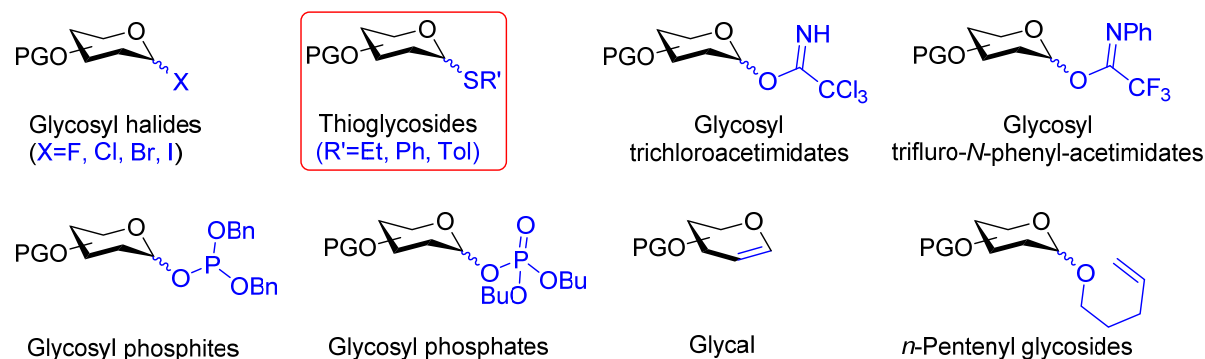

Figure 1.7: Common glycosyl donors.

b. Protecting groups

Neighboring ester-type protecting groups at C-2 position of glycosyl donors, known as participating groups⁷⁴⁻⁷⁶, have been developed to assist in the formation of 1,2-*trans* glycosides (Figure 1.8). And protecting groups at C-3, C-4 or C-6 may also affect the stereoselectivity by means of participation⁷⁷, H-bond mediated aglycone delivery⁷⁸, steric hindrance⁷⁹ or electron withdrawal.⁸⁰

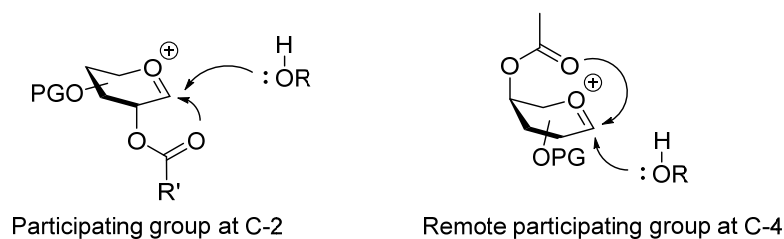

Figure 1.8: Participating groups at C-2 and C-4 positions.

1.3.3 Reaction conditions

a. Temperature

Since the α -glycoside is thermodynamically favored due to the anomeric effect, it is predominantly formed at higher temperature. And kinetically controlled glycosylations at lower temperatures generally favor β -glycoside formation.⁸¹

b. Solvent effects

The effect of solvents on the selectivity of the glycosylation reaction has been widely studied.⁸²⁻⁸⁴ Ether type solvents such as diethyl ether, tetrahydrofuran or dioxane lead to the preferential formation of the equatorial intermediate, yielding α -glycosides.⁸⁵ And if the reactions are performed in acetonitrile, the nitrilium cation formed in situ exclusively adopts an axial orientation, allowing for the stereoselective formation of β -glycosides.⁸⁶

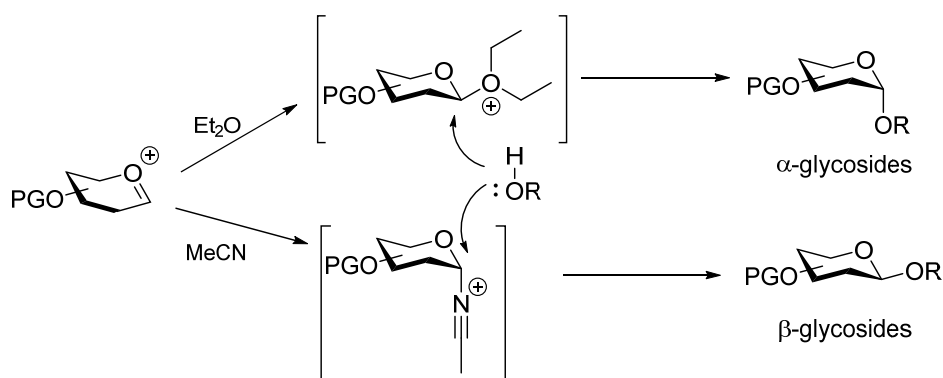

Scheme 1.3: Solvent effects.

1.3.4 Solid-phase oligosaccharide synthesis

Compared with solution-phase synthesis, solid-phase oligosaccharide synthesis holds great advantages as it allows for removal of the excess reagents and other reaction by-products by simple washing of the resin, thereby reducing the number of purification steps.

Several key issues have to be considered when contemplating the development of solid-supported synthesis of oligosaccharides.^{59, 87} The polymer support and the linker for its attachment to the sugar need to be planned very carefully so that it can withstand the reaction conditions used for protecting-group manipulations, while at the same time, it should be labile so that it can be cleaved when required. The overall synthetic strategy could be

accomplished by attaching the reducing or non-reducing end of the sugar to the solid polymeric support, leaving the growing end subjected to glycosylations. Moreover, stereospecific and high-yielding glycosylation reactions are required for rational design of solid-support-based oligosaccharide synthesis.

Initial attempts at solid-phase oligosaccharide synthesis in the early 1970s met with little success owing to the limited glycosylation methods.⁸⁸ It was not explored intensively until much later, when smarter strategies were attempted in 1990s by Danishefsky and co-workers (Scheme 1.4).⁸⁹⁻⁹³ Firstly, glycal **2** was attached to the solid support **1** via a 6-*O*-diphenyl arylsilane linker which could be readily cleaved by treatment with tetrabutylammonium fluoride (TBAF). Then **3** was treated with dimethyldioxirane **4** to convert the double bond into 1,2-anhydro-sugar **5** as glycosyl donor. Disaccharide **6** was prepared by coupling of **5** and glycal acceptor **2** activated with zinc chloride. Tetrasaccharide **12** was obtained by repetition of this procedure in 32% yield.

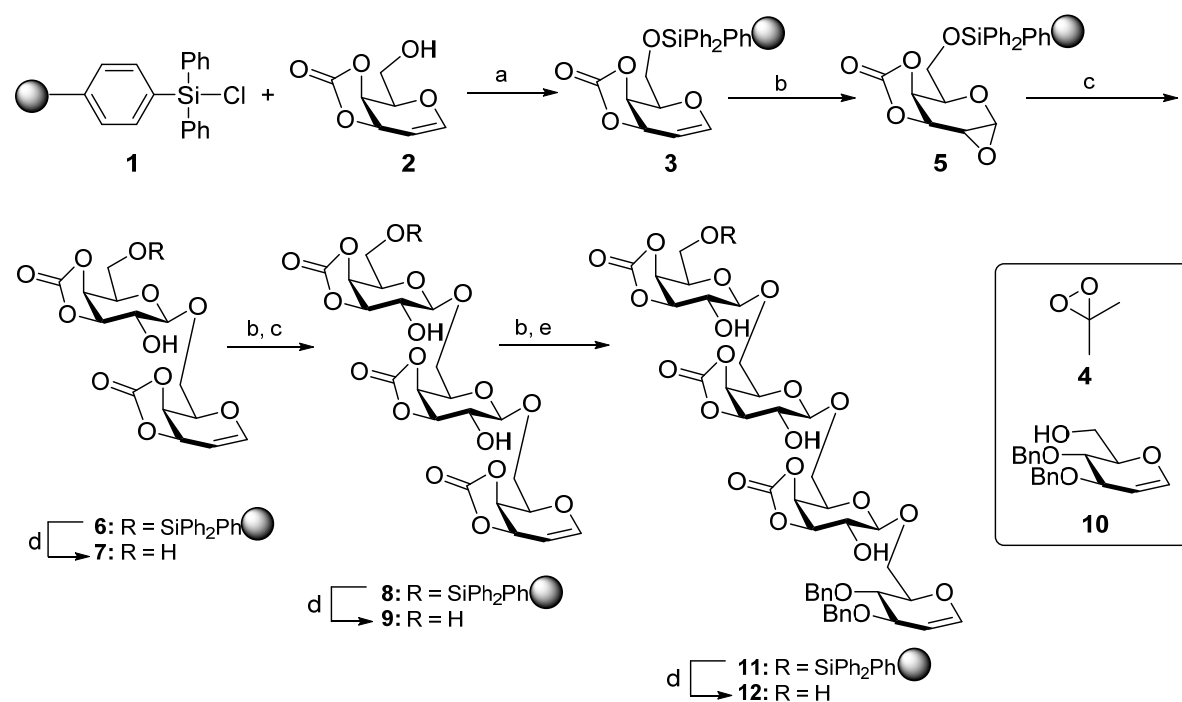

Scheme 1.4: Synthesis of oligosaccharides with glycals on polystyrene copolymer through a silyl ether linker.⁹³ Reagents: a) DIPEA, CH₂Cl₂; b) **4**, CH₂Cl₂; c) **2**, ZnCl₂, THF; d) TBAF, acetic acid, THF; e) **10**, ZnCl₂, THF.

1.3.5 Automated glycan assembly (AGA)

Building on solid-phase oligosaccharide synthesis, the first automated oligosaccharide synthesizer reengineered from a peptide synthesizer was introduced in 2001.⁹⁴ Seeberger and co-workers carried out the automated synthesis of oligosaccharides by using glycosyl trichloroacetimidates and glycosyl phosphates as glycosylating agents through a simple coupling-deprotection cycle (Scheme 1.5). This modified synthesizer was used to assemble oligosaccharides as large as dodecasaccharide **18** (Scheme 1.6) about 20 times faster than conventional methods. The oligosaccharides were then cleaved as *n*-pentenyl glycosides from the octenediol-functionalized resin **13**. However, the octenediol linker was not compatible with the electrophile required to activate thioglycosides.

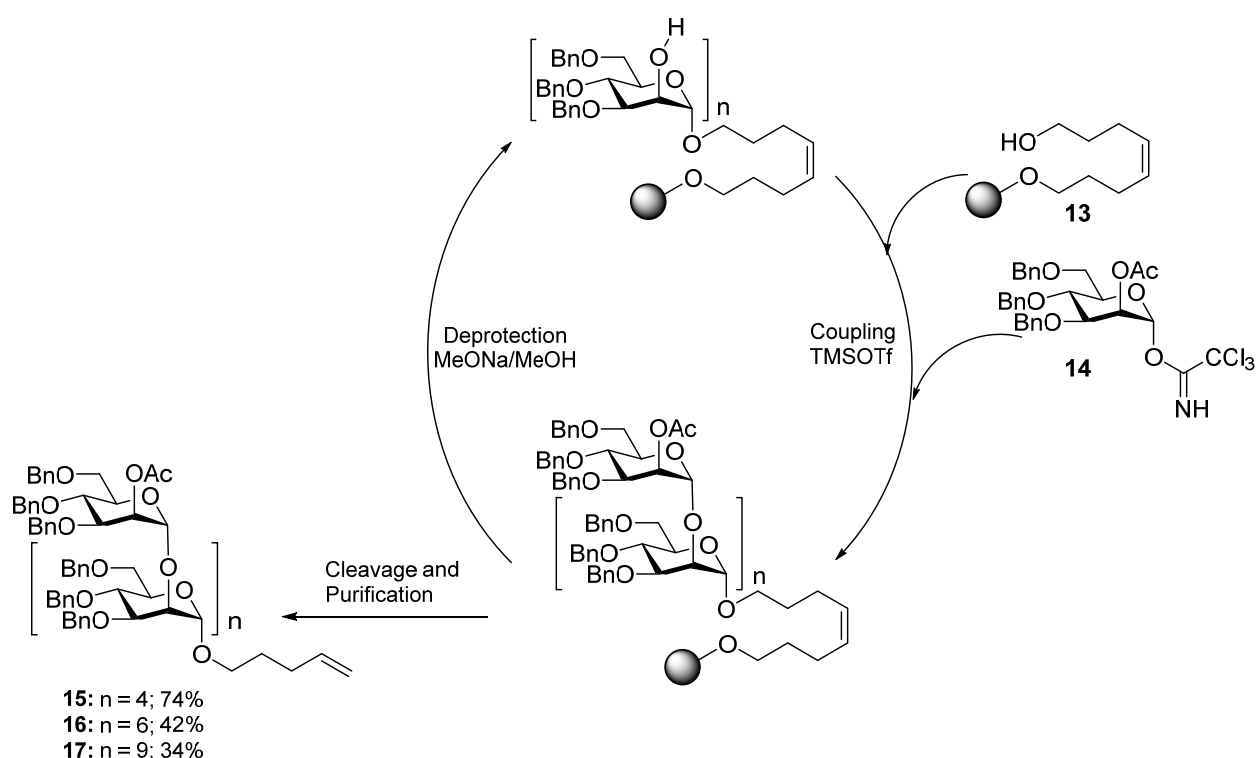

Scheme 1.5: Automated glycan assembly using trichloroacetimidates. Glycosylation conditions: 25 μ mol of resin (83 mg, 0.30 mmol/g loading); 10 equiv. donor **14** (160 mg); 0.5 equiv. TMSOTf (1 mL, 0.0125 M TMSOTf in CH_2Cl_2) repeated two times for 30 min each. Deprotection conditions: 10 equiv. NaOMe (0.5 mL, 0.5 M NaOMe in MeOH) in 5 mL of CH_2Cl_2 repeated two times for 30 min each.

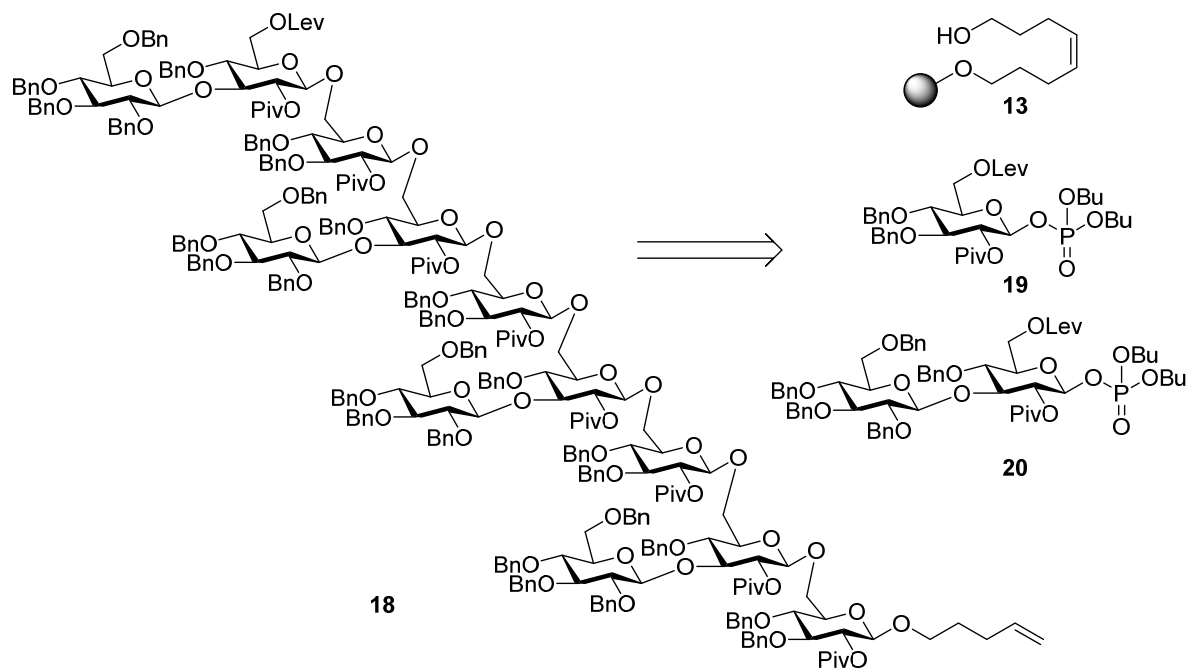

Scheme 1.6: Dodecamer phytoalexin elicitor β -glucan. Glycosylation conditions: 25 μ mol resin (83 mg, 0.30 mmol/g loading); 5 equiv. donor **19** or **20** (90 and 170 mg, respectively); 5 equiv. TMSOTf (1 mL, 0.125 M TMSOTf in CH_2Cl_2) repeated two times for 15 min each at -15°C . Deprotection conditions: 4 mL, 0.25 M N_2H_4 in pyridine/acetic acid (3:2) repeated two times for 15 min each at 15°C .

Since the introduction of AGA in 2001, many aspects of the synthetic process have been systematically improved. The commercially available Glyconeer 2.1 automated glycan synthesizer, which is equipped with various essential gadgets that facilitated the controlled delivery of reagents using syringe-pump and computerized temperature control ranging from -50°C to 90°C , has been developed.⁹⁵ Resin functionalized with a photolabile nitrobenzyl-ether-based linker **21**, which could be cleaved in a continuous-flow photoreactor, has been applied to AGA.⁹⁶ This linker can accommodate an increasing variety of anomeric leaving groups, which makes thioglycosides currently as the most common donors used in AGA. After photocleavage, glycans with a free amine group at the reducing end are delivered, which can be easily used for further functionalization. With this optimized set-up, a 50mer polymannoside **23** has been rapidly assembled using AGA (Scheme 1.7), demonstrating an option to access biopolymers for material applications.⁹⁷

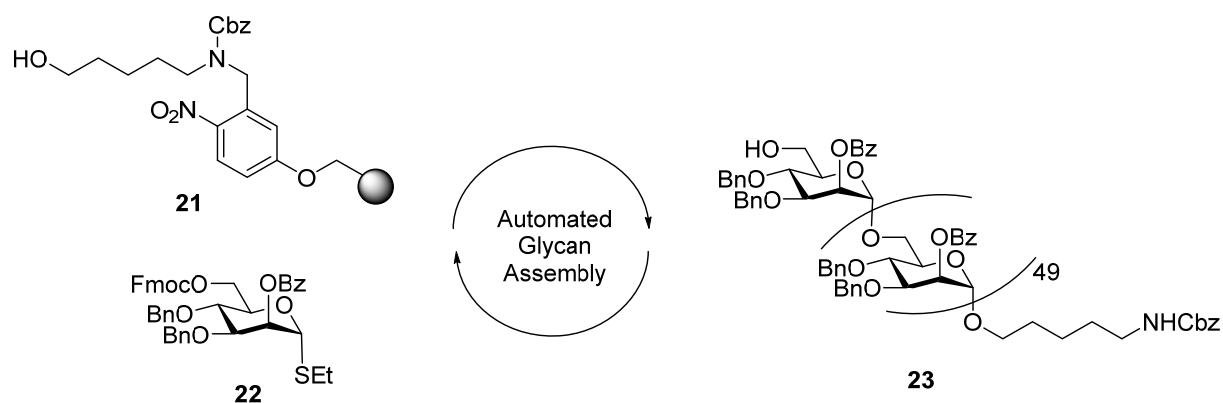

Scheme 1.7: AGA of a 50mer polymannoside 23.

1.4 Objectives of this thesis

Given the importance of polysaccharides in various fields of relevance, CPS and teichoic acid from pathogenic bacteria were chosen as targets to better understand their roles in biological process of the pathogen and as possible solutions to combat the harmful bacteria.

Using the tool of organic chemistry, various oligosaccharides derived from *S. pneumoniae* serotype 14 (ST-14) and *S. aureus* were synthesized. In the case of ST-14, an important epitope, the branched tetrasaccharide RU, was chosen as a target molecule. Since glycosylation reactions are difficult and making higher oligomers is still challenging, a unique design aspect was considered wherein the known protective epitope was bridged using an aliphatic spacer via an amide linkage, thereby eliminating the formation of glycosidic linkages between repeating units. Since glycans are presented as multivalent cross-linking ligands to B cells, the flexible spacer should facilitate the presentation of the protective epitopes to elicit better immune response. A series of oligosaccharide derivatives were synthesized and immunological evaluated to test the proposed hypothesis in Chapter 2.

Considering the issues encountered in controlling bacterial infection, there has been far less success in the case of pathogens like *P. aeruginosa*, *H. pylori*, *C. jejuni*, *S. aureus* and others. The current rate of microbial resistance is also not helping either. Since a giv-

en pathogen can have many virulence factors, it is important to find the right antigen that can be used to fight against the disease caused by the pathogen. Along with CPSs, LPSs, teichoic acids and proteins are also viable targets. In order to better understand their roles and functions, one needs to have some basic tools to first decipher their targets. *Chapter 3* deals with the chemical synthesis of wall teichoic acid fragment from *S. aureus* to understand their role in defining the binding site with glycosyltransferase TarP.

Even after decades of development in the field of carbohydrate chemistry, still very little is known about controlling glycosylation reactions as the reaction conditions, which are developed for one substrate, are not amenable or general enough for others as would be in the case of peptide and oligonucleotide synthesis. In order to better understand the whole process of glycosylation, a promoter is developed for both solution and solid phase oligosaccharide synthesis in *Chapter 4*. Along the same line, *Chapter 5* gives an insight into the mechanism behind glycosylation in-depth using ultra-cold infrared spectroscopy, for which a library of different monosaccharide substrates was synthesized and studied. Thus, if one understands the process of glycosylation on a molecular level, a universal method might be able to be developed, which would immensely facilitate the advancement of glycoscience field.

Chapter 2

Development of semisynthetic glycoconjugate vaccine candidates against *Streptococcus pneumoniae* serotype 14

2.1 Introduction

2.1.1 *Streptococcus pneumoniae*

S. pneumoniae are lancet-shaped, gram-positive bacteria that colonize the mucosal surfaces of the upper respiratory tract, causing severe invasive pneumococcal diseases (IPDs) like pneumonia, septicemia, meningitis and otitis media.⁹⁸⁻¹⁰¹ Pneumonia is the most common form of IPDs and accounts for 18% of child deaths in developing countries (Figure 2.1), making it the leading cause of death among young children.¹⁰²

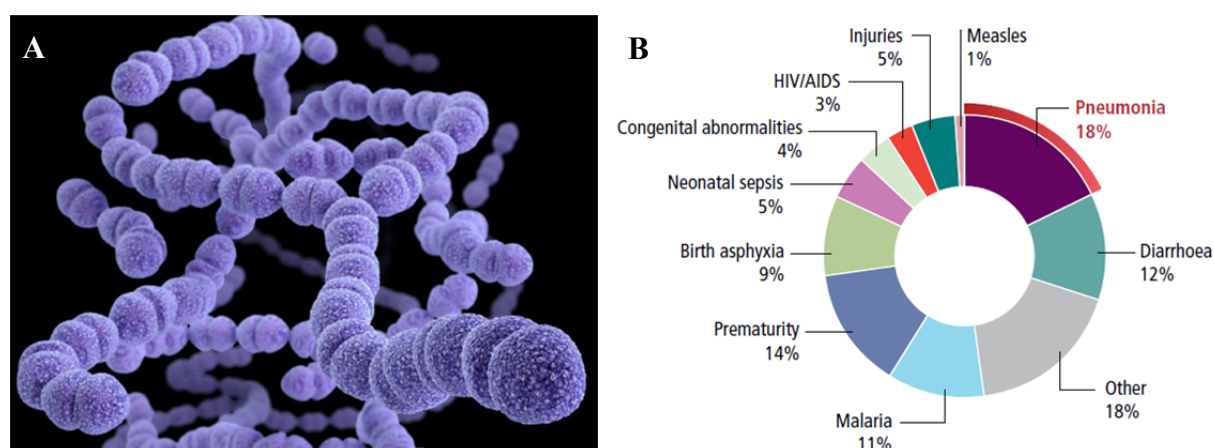

Figure 2.1: (A) *S. pneumoniae* under scanning electron microscope (SEM); (B) Causes of under-five child deaths in low-income countries (WHO, World Health Statistics 2012).

Capsular polysaccharides (CPSs) on the surface of *S. pneumoniae* are composed of multiple repeating units of up to eight sugar residues.¹⁰³ More than 95 serotypes have been identified based on different chemical structures of CPS.¹⁰⁴ The prevailing serotypes vary with geography and age as well as over time, but fortunately, globally, about 20 serotypes are associated with more than 80% of IPDs occurring in all age groups, and 13 most

common serotypes cause approximately 75% of IPDs in children.^{105, 106} Many studies have demonstrated that capsular polysaccharides are well known major virulence factors¹⁰⁷⁻¹⁰⁹ and antibodies against these structures are essential for protection against pneumococcal disease.¹¹⁰

2.1.2 Vaccines against *S. pneumoniae*

Currently two types of vaccines are commercially available: pneumococcal polysaccharide vaccine (PPV) and pneumococcal conjugate vaccine (PCV).¹¹¹ These vaccines are based on natural capsular polysaccharides, purified from bacterial cultures. The multivalent PPV contains 23 serotypes of purified capsular polysaccharides, which is currently licensed for use in adults and children older than two years old. This vaccine was shown to be moderately effective in adults but not in young children and immunocompromised patients.

Table 2.1: Commercially available vaccines against *S. pneumoniae*.

Vaccine	Serotypes in Pneumococcal Vaccines
PPV-23	1, 2, 3, 4, 5, 6B, 7F, 8, 9N, 9V, 10A, 11A, 12F, 14, 15B, 17F, 18C, 19A, 19F, 20, 22F, 23F, 33F
PCV-7 ^a	4, 6B, 9V, 14, 18C, 19F, 23F
PCV-10	1, 4, 5, 6B, 7F, 9V, 14, 18C, 19F, 23F
PCV-13	1, 3, 4, 5, 6A, 6B, 7F, 9V, 14, 18C, 19 A, 19F, 23F

^aPCV-7 is no longer available.

In early 2000, CPSs were conjugated to carrier protein CRM197. This polysaccharide-protein conjugate vaccine targeting seven pneumococcal serotypes was licensed in USA for use in young children (Prenar[®], PCV-7). This vaccine proved a success in significantly preventing IPDs in children younger than two years old. Large scale introduction of PCV-7 has resulted in an overall decline in IPDs. Two more pneumococcal conjugate vaccines, PCV-10 and PCV-13 (Table 2.1), have been developed later to cover more serotypes.

2.1.3 *S. pneumoniae* serotype 14

S. pneumoniae serotype 14 (ST-14) is a common serotype in human population and frequently infects young children.¹¹²⁻¹¹⁵ According to a global study, it accounted for 12-29% of IPDs in children worldwide (Figure 2.2).¹⁰⁶

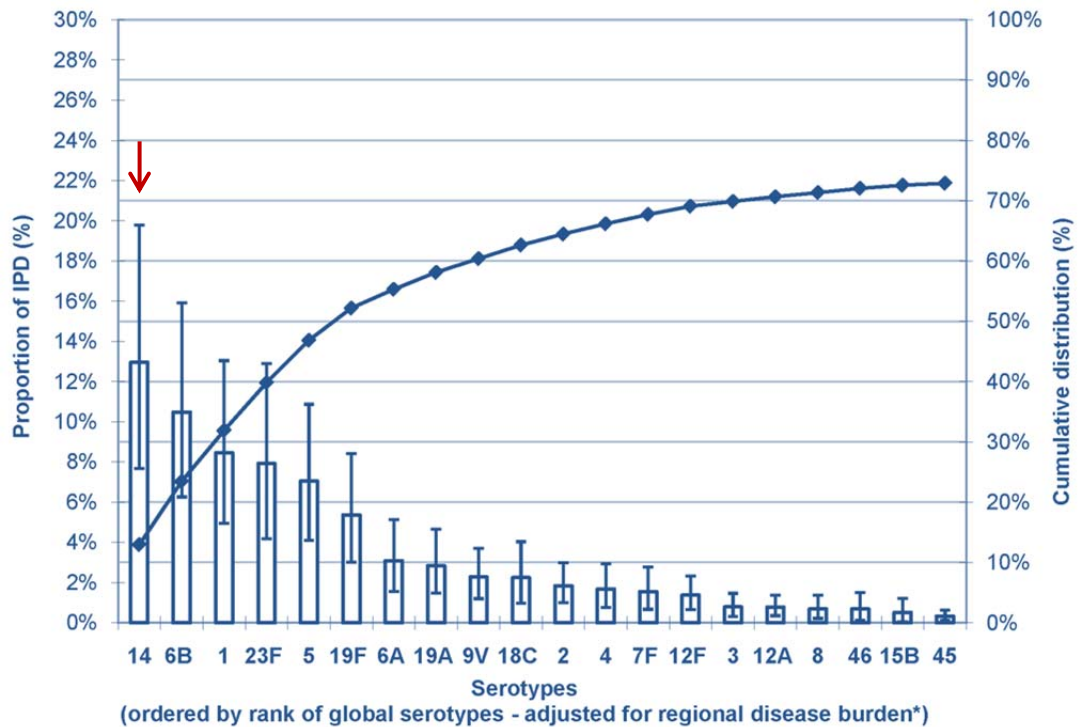

Figure 2.2: Proportion of IPDs in young children due to the most common serotypes globally. Error bars indicate the 95% confidence interval for the proportion of IPDs due to each of the 21 serotypes. Cumulative line indicates the cumulative proportion of IPDs due to the 21 serotypes. *Adjusted for regional incidence of cases. (Reprinted from ref. 106)

Capsular polysaccharide of ST-14 (Pn14PS) consists of a branched tetrasaccharide repeating unit (RU) (Figure 2.3).¹¹⁶ Pn14PS and its depolymerized oligosaccharide fragments conjugated to a carrier protein have been reported to produce specific anti-Pn14PS antibodies in mice.¹¹⁷⁻¹¹⁹ The branched tetrasaccharide Gal-Glc-(Gal)-GlcNAc was described as the smallest core structure required to induce Pn14PS-specific antibodies. Thus, this epitope could be a promising candidate for a semisynthetic glycoconjugate vaccine candidate against infections caused by ST-14.¹²⁰⁻¹²³ Based on these established data, this antigenic tetrasaccharide has been used in the rational design of synthetic carbohydrate-based vaccine.^{54, 124-127}

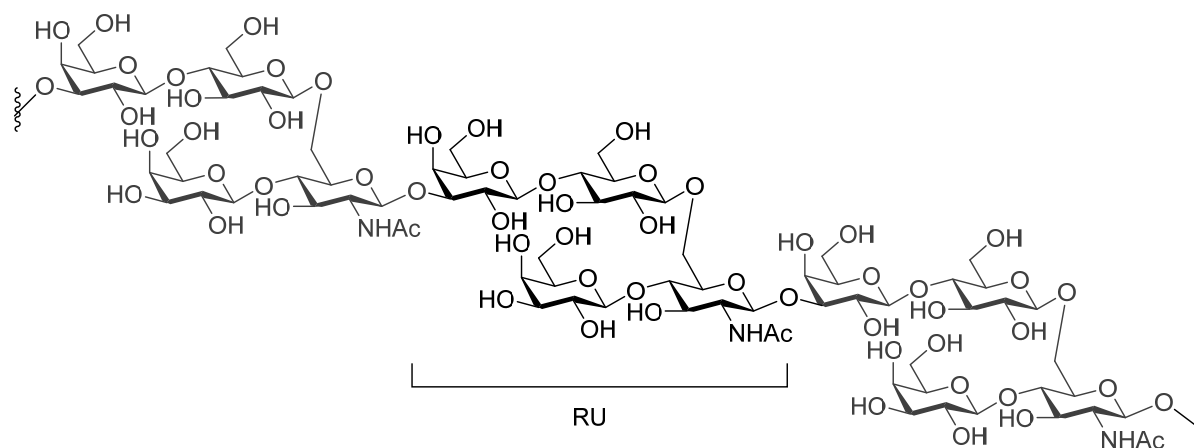

Figure 2.3: Structure of capsular polysaccharide of *S. pneumoniae* serotype 14 (Pn14PS).

2.1.4 Bridging systems in carbohydrates

a. Bridging systems in the synthesis of oligosaccharide analogues

The synthesis of oligosaccharides is laborious and challenging, requiring an extensive use of orthogonal protecting groups and strictly anhydrous condition in glycosylation reaction, which makes it still far from routine, both in solution and in solid phase.⁸⁷ Therefore, it is frequently desirable to design compounds that mimic carbohydrates associated with important biological events so that it can be prepared in a simpler and more efficient way.¹²⁸⁻¹³¹

One successful application of this strategy was achieved through click chemistry.¹³²⁻¹³⁴ The triazole ring has been used to synthesize high-mannose oligosaccharide analogues by replacement of some of the inner monosaccharide residues (Figure 2.4-B), which represents a very significant simplification compared with classical glycosylation methods.^{130, 135} These pseudo-mannose derivatives displayed binding affinities towards mannose-specific lectins ConA and biomedically relevant human macrophage mannose receptor (rhMMR) that reproduces the trends encountered for the natural counterparts in enzyme-linked lectin assays, with binding potencies that also rivaled those of their respective natural partners (Figure 2.4-C).

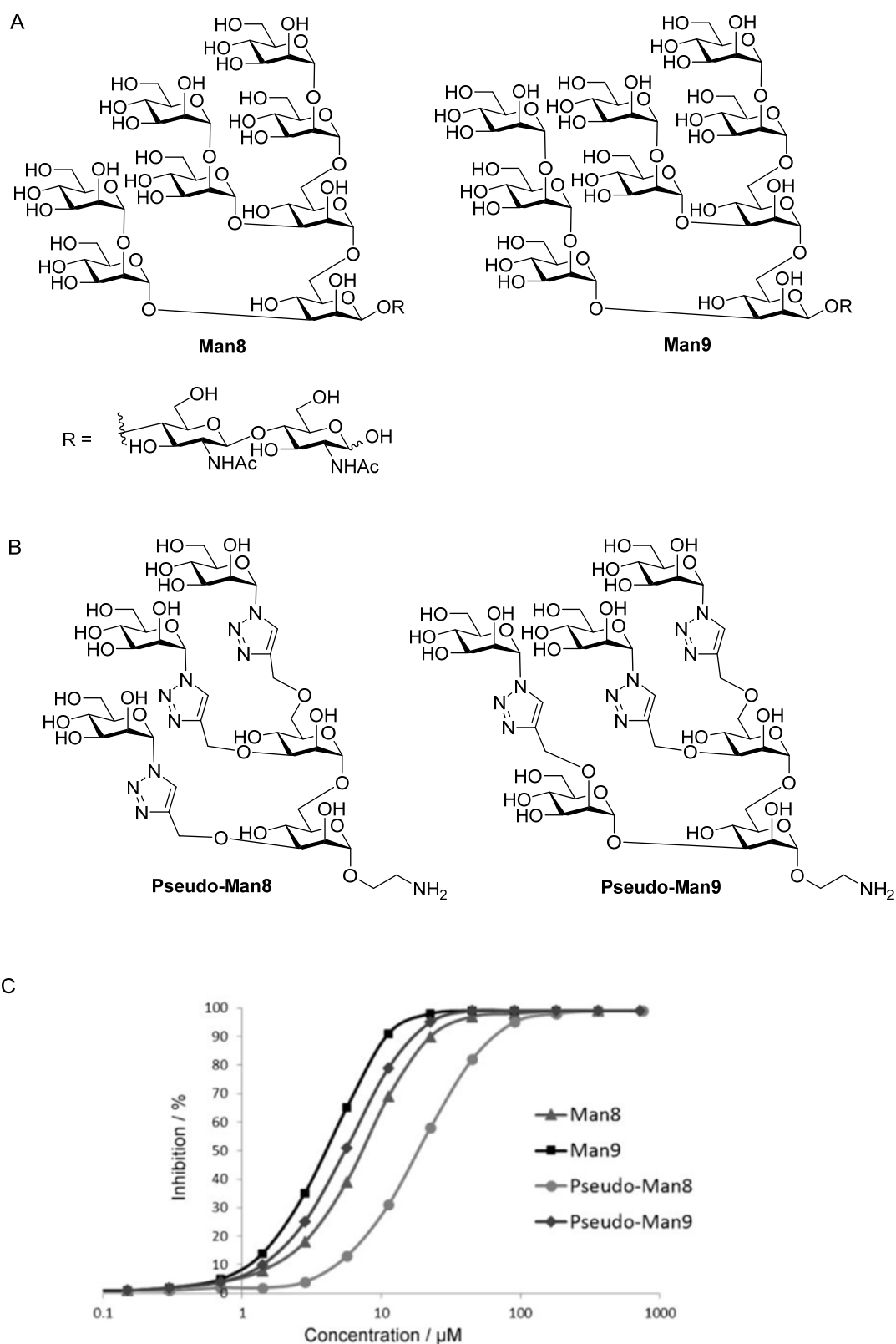

Figure 2.4: (A) Structure of high-mannoses glycans **Man8** and **Man9**; (B) Structure of targeted “high-mannose” type oligosaccharides mimics **Pseudo-Man8** and **Pseudo-Man9**; (C) Enzyme-linked lectin assays (ELLA)¹³⁰ for the inhibition of rhMMR binding to yeast mannan by increasing concentrations of the **Pseudo-Man8** and **Pseudo-Man9** in comparison with the natural high-mannose glycans **Man8** and **Man9**.

b. Using bridging systems in divalent or multivalent glycan binding

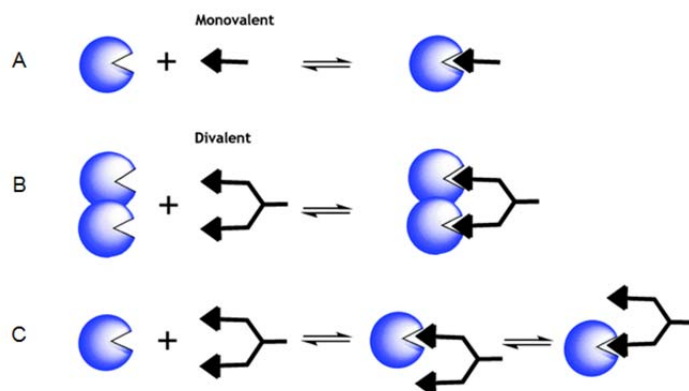

Figure 2.5: Protein-carbohydrate interaction: (A) monovalent binding; (B) a divalent binding via a chelation mechanism; (C) a divalent ligand binding via a statistical rebinding mechanism. (Reprinted from ref. 141)

Glycans tend to bind weakly to their complementary proteins. Stronger binding is often achieved by the use of multiple interactions by multivalent carbohydrates. Two main mechanisms of multivalent enhancement^{136, 137} seem to be operative: chelation (Figure 2.5-B), in cases binding sites can be bridged by a multivalent ligand, and statistical rebinding (Figure 2.5-C), in cases where this is not possible. To aim for chelation, architectures and spacers with different flexibility and lengths have been studied to bridge lectin binding sites. Strong effects of several orders of magnitude were observed with systems which are capable of bridging binding sites (Figure 2.6).¹³⁸⁻¹⁴⁰

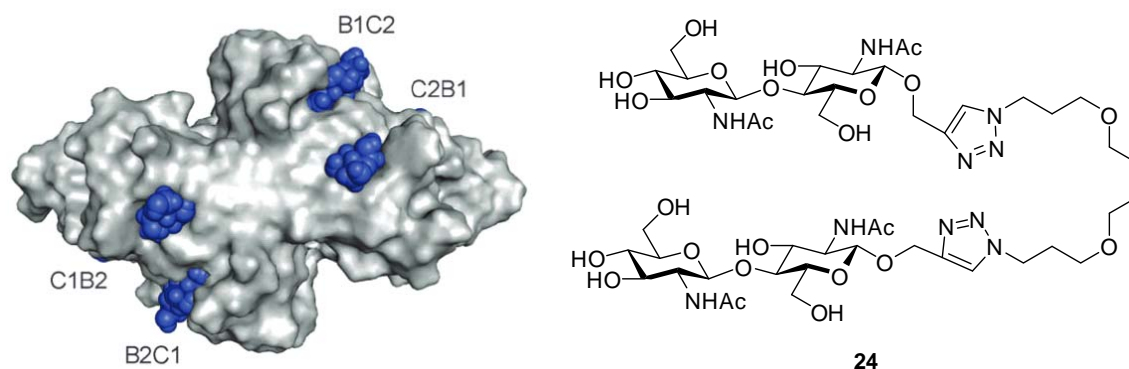
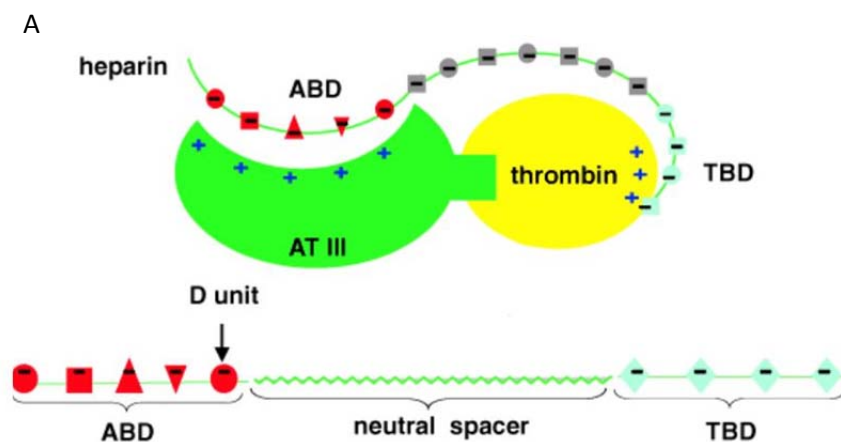

Figure 2.6: X-ray structure of wheat germ agglutinin (WGA) dimer in complex with GlcNAc (PDB-ID:2UVO). Visible are the four binding sites. Reported divalent chitobiose **24**¹⁴¹ has a binding potency that is 500-fold per chitobiose moiety higher than that of chitobiose with WGA.

In the case of heparin, investigations of isolated heparin fragments revealed that the heparin fragment should be approximately 18 monosaccharides long to show inhibitory activity against thrombin.¹⁴² A model of the ternary antithrombin III (AT-III)/heparin/thrombin complex¹⁴³ has been identified based on the crystal structure of AT-III and thrombin, which clearly shows that both AT-III and thrombin bind to the same heparin chain (Figure 2.7-A). Six to eight sulfated monosaccharides in the bridge region do not interact with the proteins. Based on this model, a flexible noncarbohydrate spacer was used to bridge an AT-III-binding domain (ABD) with a thrombin-binding domain (TBD) to get novel antithrombotics. This heparin-like derivative (Figure 2.7-B), which comprises a non-glycosaminoglycan pentasaccharide as the ABD and a persulfated maltotriose moiety as the TBD connected through a spacer of about 50 atoms in length, did indeed display substantial antithrombotic activity (140 U/mg; heparin 160 U/mg).¹⁴⁴ This concept offered the advantage of simplified chemistry compared to the synthesis of an oligosaccharide comprising about 20 monosaccharides. Structure-activity relationships were studied by alterations with spacer both in length and rigidity.^{145, 146}



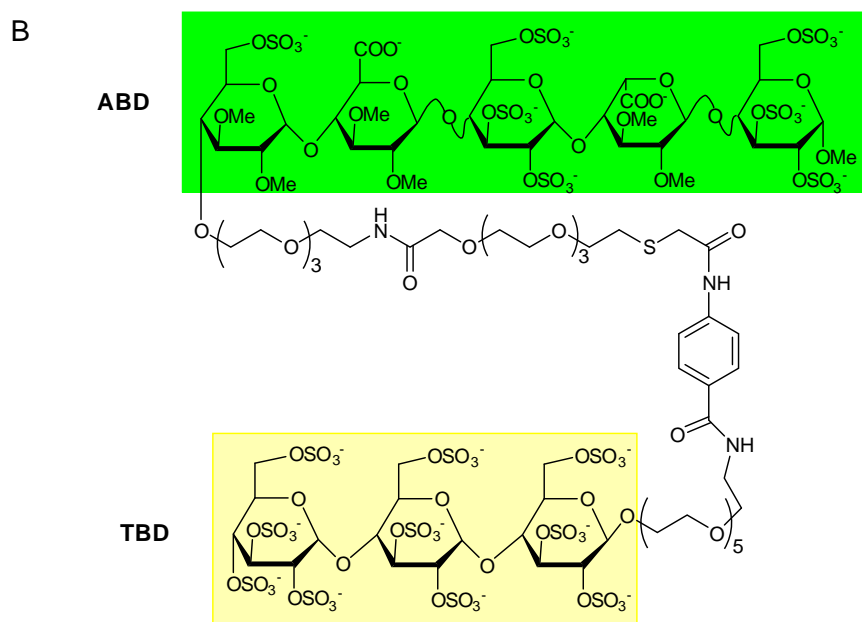

Figure 2.7: (A) Schematic model of the AT-III/heparin/thrombin complex. Novel antithrombotics was designed based on the binding domain. (Modified from ref. 146) (B) The derivative, comprising an AT-III-binding domain (ABD) and a sulfated trisaccharide as the thrombin-binding domain (TBD) connected through a flexible spacer, shows substantial antithrombin activity.

2.1.5 Bridging repeating units (RUs) as novel glycoconjugate vaccine candidates against ST-14

As capsular polysaccharides consist of multiple RUs of up to eight sugar residues, the synthesis and application of glycoconjugate vaccines against these infections are seriously restricted by the difficulty in preparing target oligosaccharides which usually contain at least one RU. A spacer is proposed to bridge RUs in order to simplify the synthesis of glycoconjugate vaccines (Figure 2.8). Moreover, since the binding mechanism between polysaccharides and BCRs is not clear, bridging repeating units might enhance the binding affinity with BCRs, therefore inducing a better immune response.

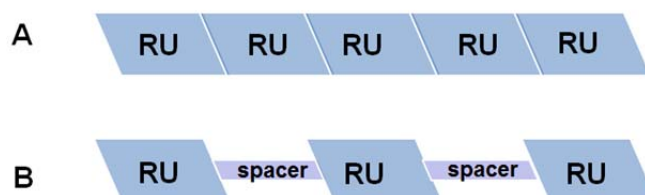
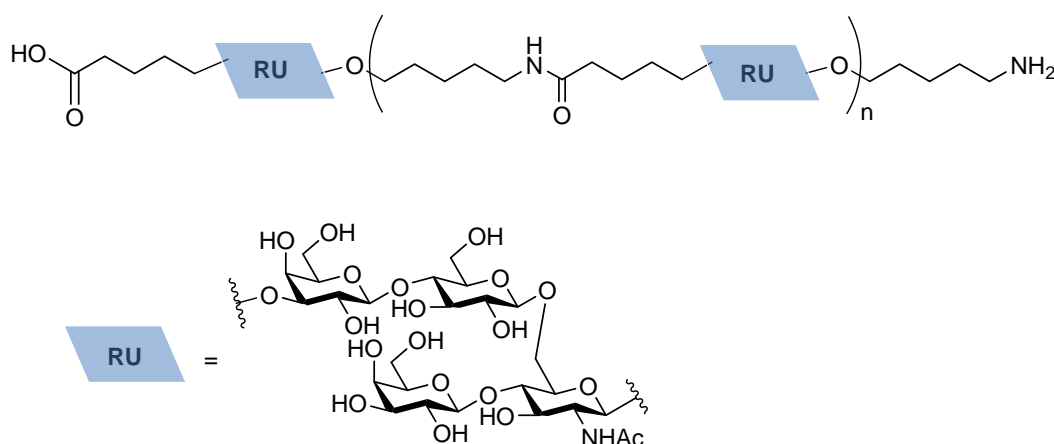

Figure 2.8: Schematic structure of (A) natural capsular oligosaccharide and (B) spacer bridged RUs.

The well-studied branched tetrasaccharide, RU of Pn14PS, was chosen as the target to synthesize spacer bridged oligosaccharide derivatives, which will be conjugated to carrier protein CRM197 to obtain experimental vaccine candidates against ST-14 (Figure 2.9). A ten-carbon aliphatic spacer was chosen based on the usage of an aliphatic spacer that bridges CPSs or oligosaccharides to carrier protein in the commercial glycoconjugate vaccines thereby preventing issues pertaining to toxicity and immunogenicity.

**Figure 2.9:** Proposed structures of spacer bridged ST-14 capsular oligosaccharide derivatives.

2.2 Results and discussion

2.2.1 Synthetic strategy

To prepare monovalent derivative **25**, spacer bridged divalent derivative **26** and trivalent derivative **27**, tetrasaccharide unit **28** with linkers both at the reducing end and non-reducing end was designed, while tetrasaccharide **28** will be assembled by linear combination of linker **29**, building blocks **30**,¹⁴⁷ **31**, **32**,¹⁴⁸ and **33**. Tetrasaccharide **34**, which could be prepared by similar strategy with building block **35**¹⁴⁹ instead of **33**, were envisioned as control group.

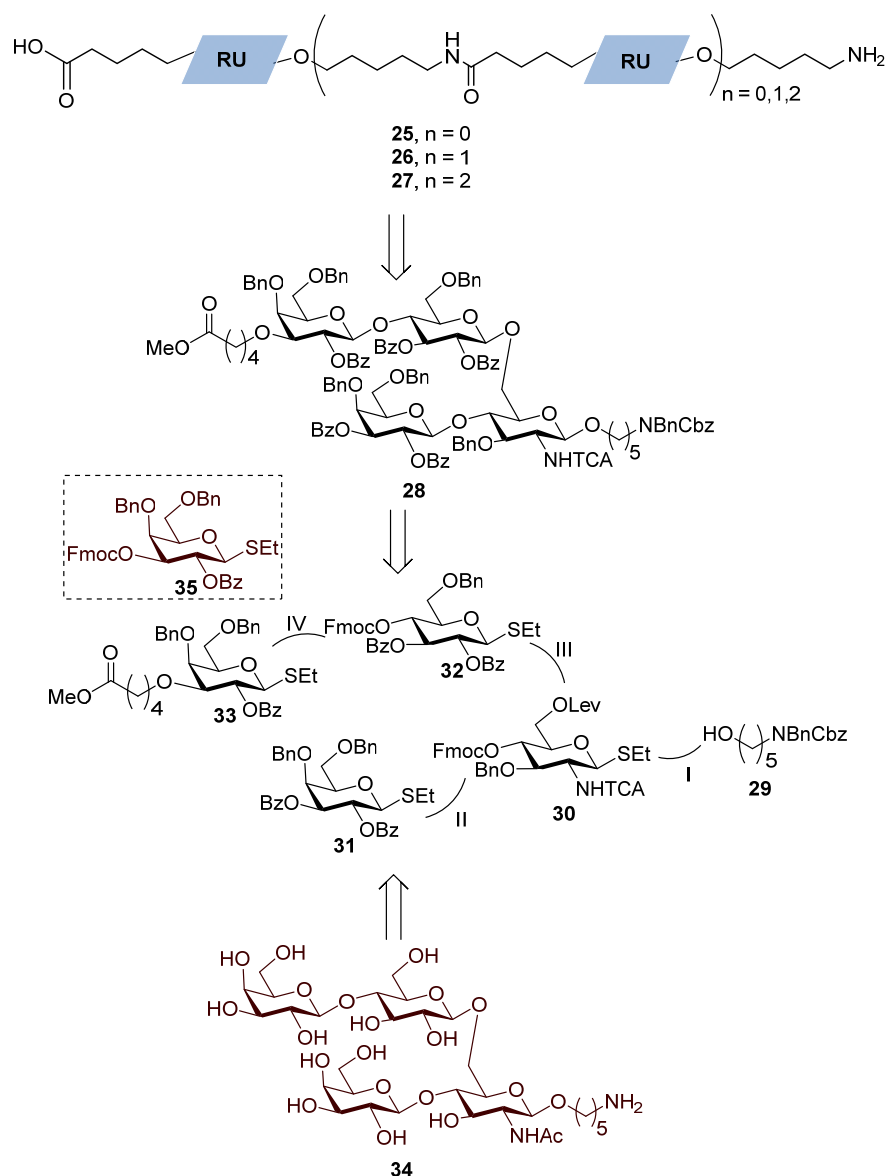

Scheme 2.1: Retrosynthetic analysis of capsular oligosaccharide derivatives **25**, **26**, **27** and **34**.

2.2.2 Preparation of building blocks

Glucosamine building block **30**, glucosyl **32** and galactosyl **35** were synthesized by following the reported procedures.¹⁴⁷⁻¹⁴⁹

The synthesis of building block **31** commenced with ethyl 4,6-*O*-benzylidene-1-thio- β -D-galactopyranoside **36** (Scheme 2.2). Treatment of **36** with benzoic anhydride in the presence of 4-dimethylaminopyridine (DMAP) produced **37**. Regioselective opening of the 4,6-*O*-benzylidene acetal gave the corresponding C-6 hydroxyl **38** in low yields due to

problems with the purchased reagent borane in THF. Therefore, a different strategy was applied. Diol **36** was protected with 2-naphthylmethyl (NAP) group to afford **39**. After removal of benzylidene acetal with ethanethiol catalyzed by tosylic acid, **40** was obtained in 96% yield. Subsequent benzylation of **40** followed by cleavage of NAP group using 2,3-dichloro-5,6-dicyano-1,4-benzoquinone (DDQ) and benzylation afforded **31**.

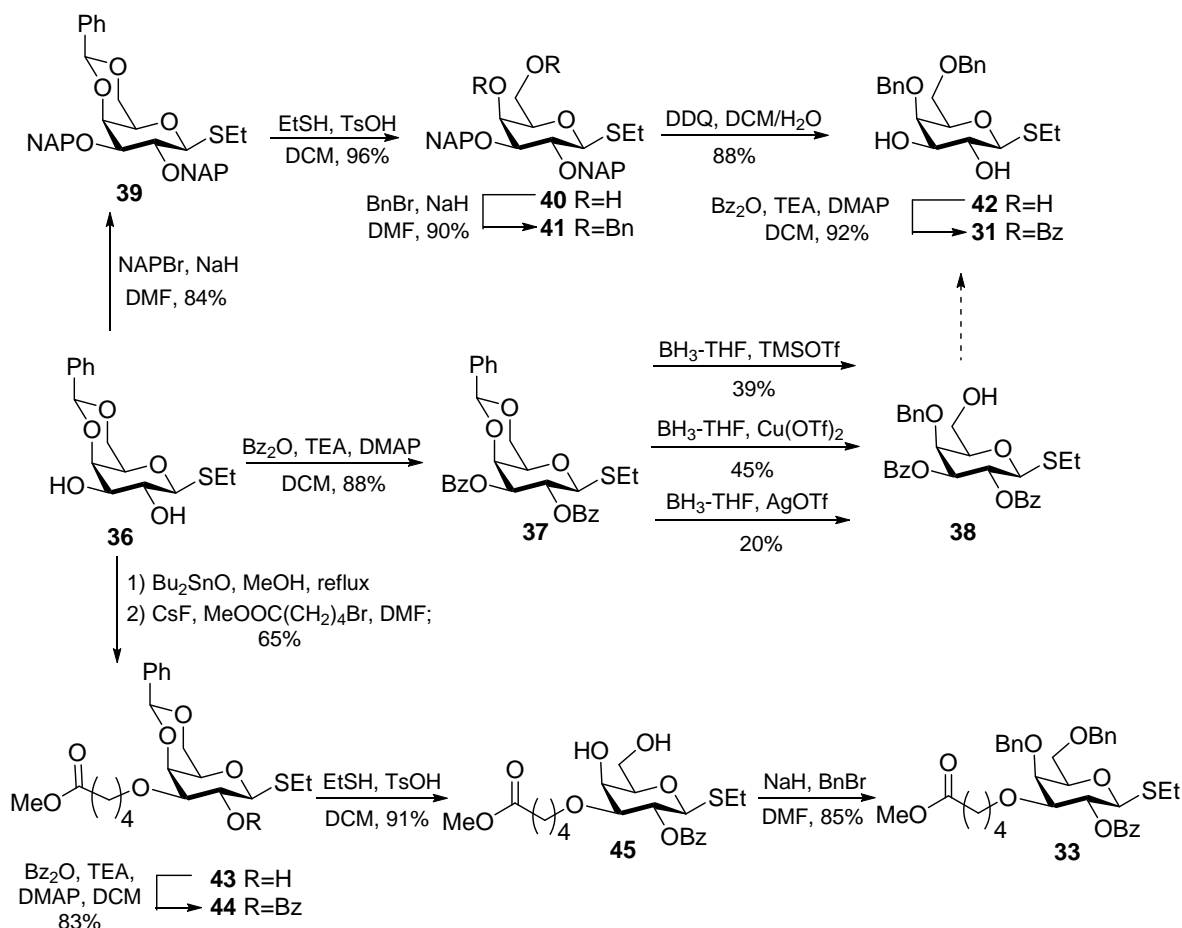

Scheme 2.2: Synthesis of building blocks **31** and **33**.

Synthesis of non-reducing-end galactose **33** was achieved in four steps from **36**. 5-Methoxy-5-oxopentyl group was regioselectively installed at the C-3 position of diol **36** using tin-mediated method to afford **43**. Esterification of the free hydroxyl group of **43** was accomplished with benzoic anhydride, giving **44**. Building block **33** was then obtained after cleavage of benzylidene acetal followed by benzylation.

2.2.3 Assembly of oligosaccharide derivatives

With four building blocks in hand, the stage was set to access tetrasaccharide **28**. The protected amino-linker was introduced at the reducing end by glycosylation of **29** and thioglycoside **30** promoted by *N*-iodosuccinimide (NIS) in the presence of triflic acid (TfOH), affording **46**. Removal of temporary fluorenylmethyloxycarbonyl (Fmoc) protecting group gave compound **47**, which was further reacted with galactose **31**, thus obtaining the fully protected disaccharide **48**. Cleavage of levulinoyl (Lev) group with hydrazine hydrate yielded compound **49** as acceptor, which was then glycosylated with building block **32** to furnish trisaccharide **50**. Deprotection of Fmoc group followed by coupling with thioglycoside **33** produced tetrasaccharide **28** (Scheme 2.3).

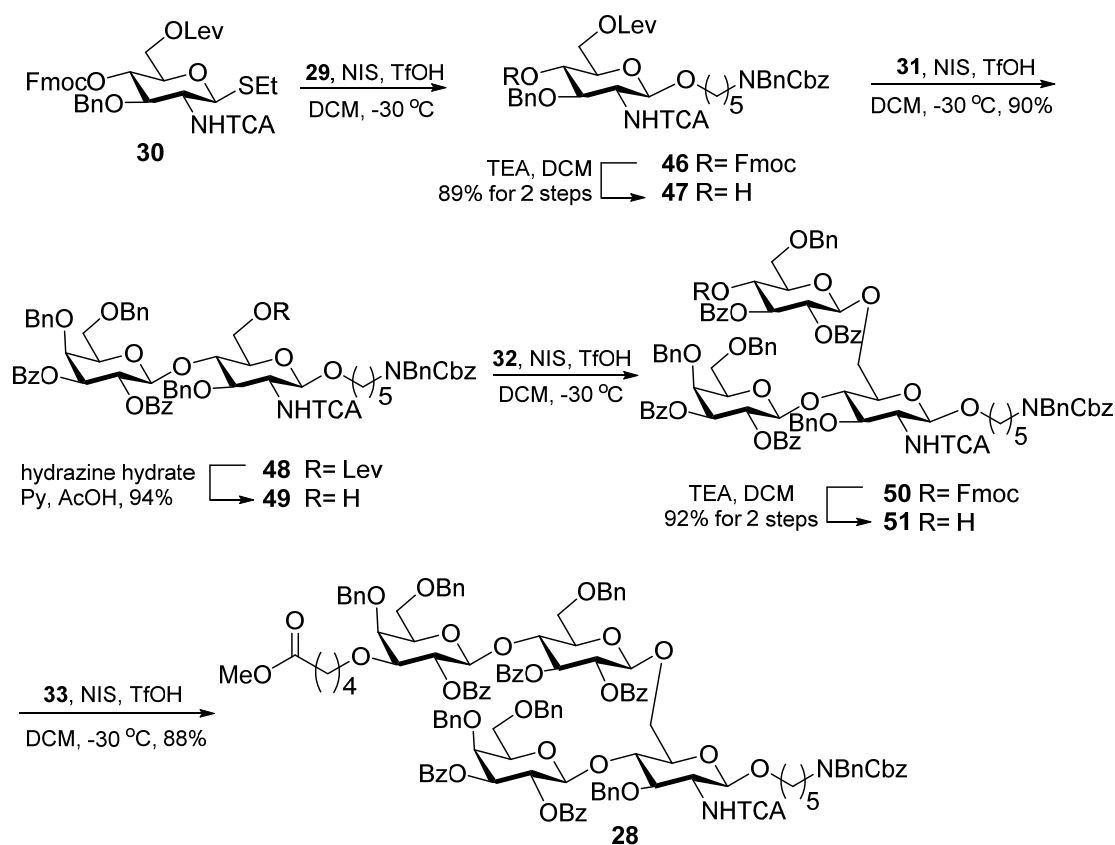
Scheme 2.3: Synthesis of tetrasaccharide **28**.

The methyl ester at the non-reducing end of **28** was cleaved with 10% sodium hydroxide aqueous solution followed by addition of excessive sodium methoxide to remove all the benzoyl groups to give compound **52**. Subsequent hydrogenolysis catalyzed by palladium on carbon produced tetrasaccharide **25**.

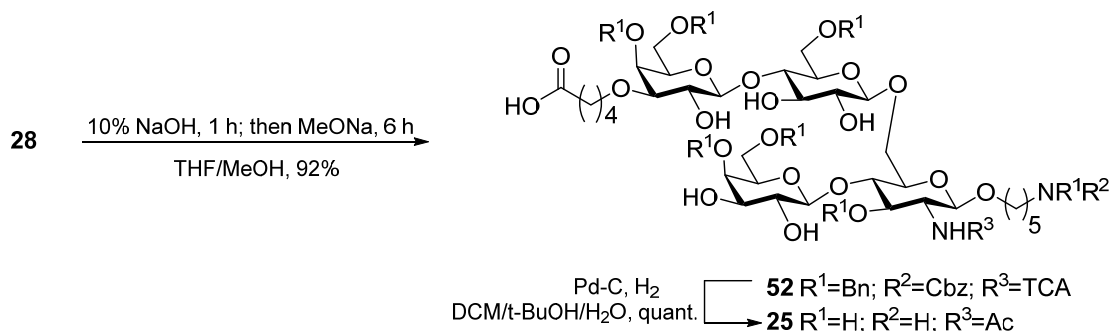
Scheme 2.4: Fully deprotection of tetrasaccharide **28** to obtain **25**.

Treatment of tetrasaccharide **28** with palladium on carbon under hydrogen yielded compound **53** with a free amino group at the reducing end. Among many reported coupling reagents for amide bond formation^{150, 151}, 1-[bis(dimethylamino)methylene]-1*H*-1,2,3-triazolo[4,5-*b*]pyridinium 3-oxid hexafluorophosphate¹⁵² (HATU) was chosen to catalyze the reaction of **52** and **53** in the presence of triethylamine. However, unexpected peaks were observed in MALDI-TOF used to monitor the reaction. Instead, benzotriazol-1-yl-oxytripyrrolidinophosphonium hexafluorophosphate (PyBOP) together with *N,N*-diisopropylethylamine (DIPEA) led to the spacer bridged divalent derivative **54** in 80% yield.

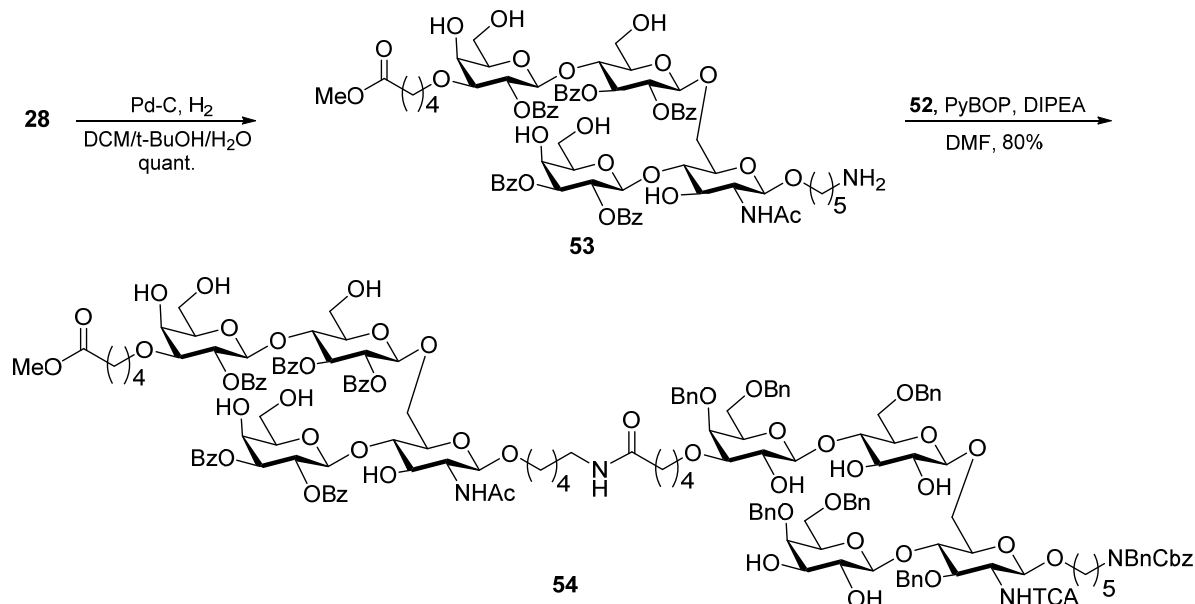

Scheme 2.5: Synthesis of divalent RU of ST-14.

Removal of all the ester and ether protecting groups of **54** using the same procedure as compound **28** yielded deprotected divalent derivative **26** (Scheme 2.6).

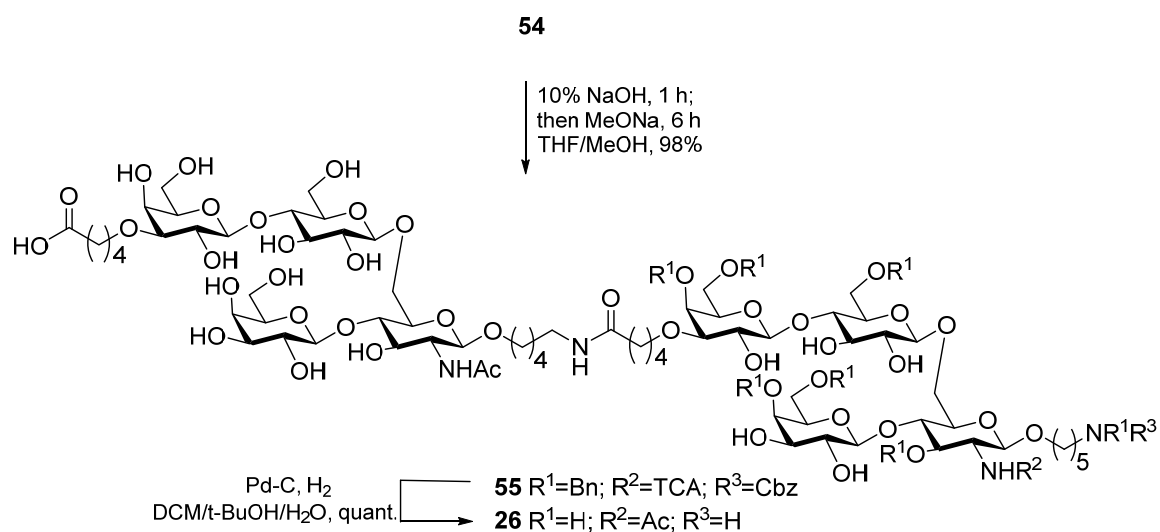

Scheme 2.6: Synthesis of fully deprotected divalent RU of ST-14.

Coupling of compounds **55** and **53** afforded **56** with PyBOP as coupling reagent. Global deprotection of **56** gave the spacer bridged trivalent derivative **27**.

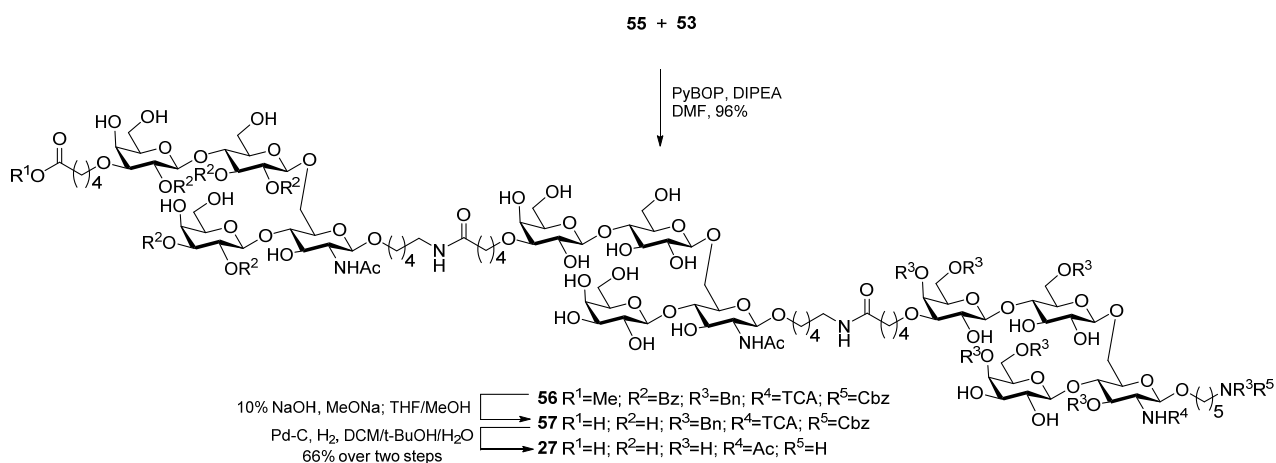

Scheme 2.7: Synthesis of fully deprotected trivalent RU of ST-14.

Tetrasaccharide **58** was prepared by glycosylation of trisaccharide **51** and galactose building block **35** activated with NIS/TfOH. Removal of Fmoc, benzoyl and benzyl protecting groups yielded fully deprotected tetrasaccharide **34**.

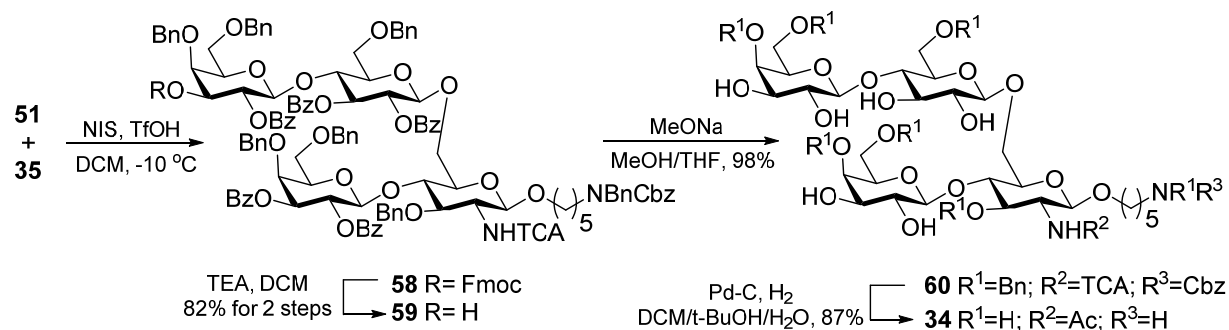

Scheme 2.8: Synthesis of tetrasaccharide **34**.

2.2.4 Antigenic evaluation*

Glycan microarrays served as the tool to evaluate the affinities of these synthetic oligosaccharide derivatives with antibodies against Pn14PS. Tetrasaccharide **34**, oligosaccharide derivatives **25**, **26**, **27** and native Pn14PS were covalently immobilized on glass slides (Figure 2.10-A). After incubation with a human reference serum mixture (WHO007, pooled sera from 287 patients vaccinated with Pneumovax-23 valent CPSs), the bound antibodies were detected using fluorescent labeled secondary antibodies (Alexa Fluor 647 goat anti-human IgG H+L, Invitrogen). The pattern (Figure 2.10-B) showed that antibodies in the human reference serum were cross-reactive against all the synthetic glycan derivatives. Among all the synthetic structures, divalent derivative **26** showed the strongest binding affinity (Figure 2.10-C).

* Glycan array analysis and immunization study in mice were performed by Bruna Mara Silva Seco.

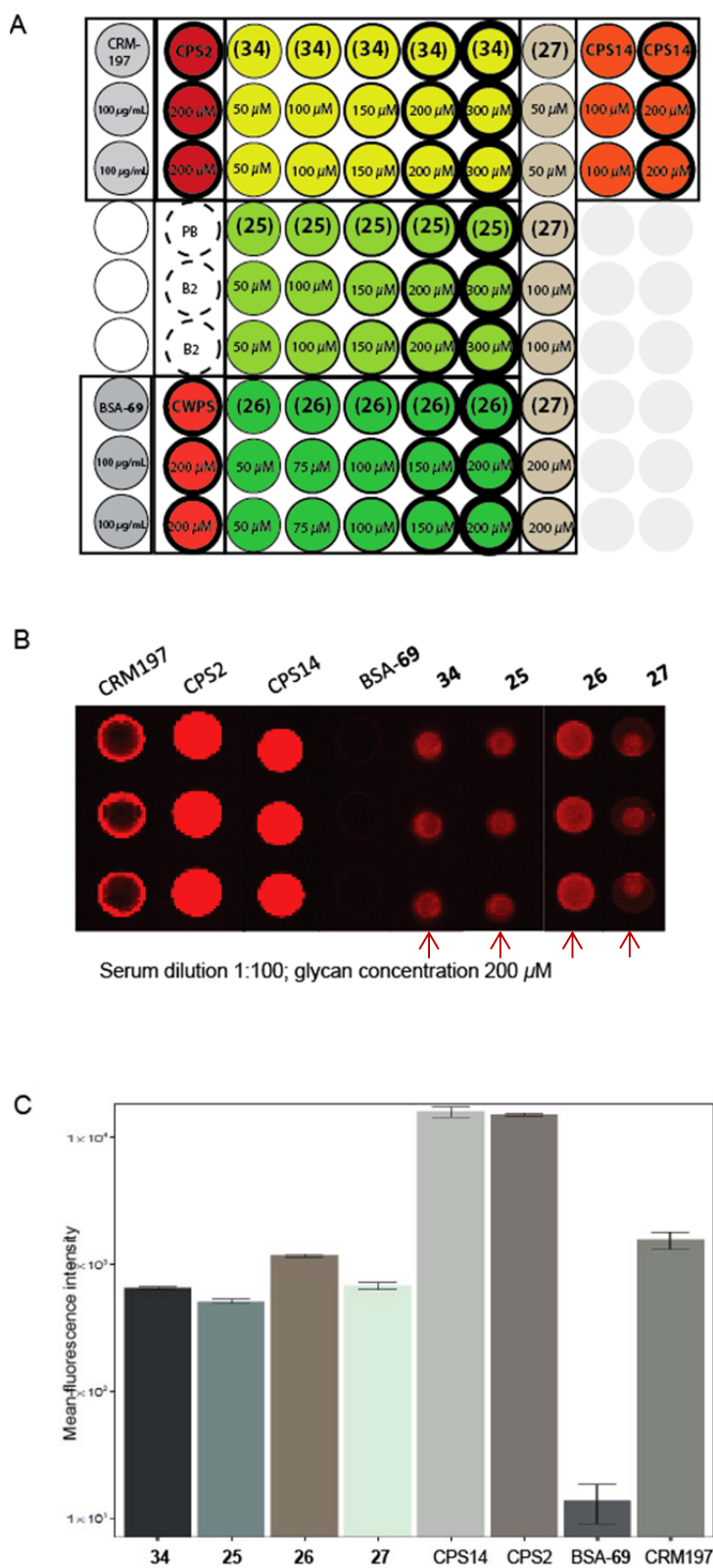
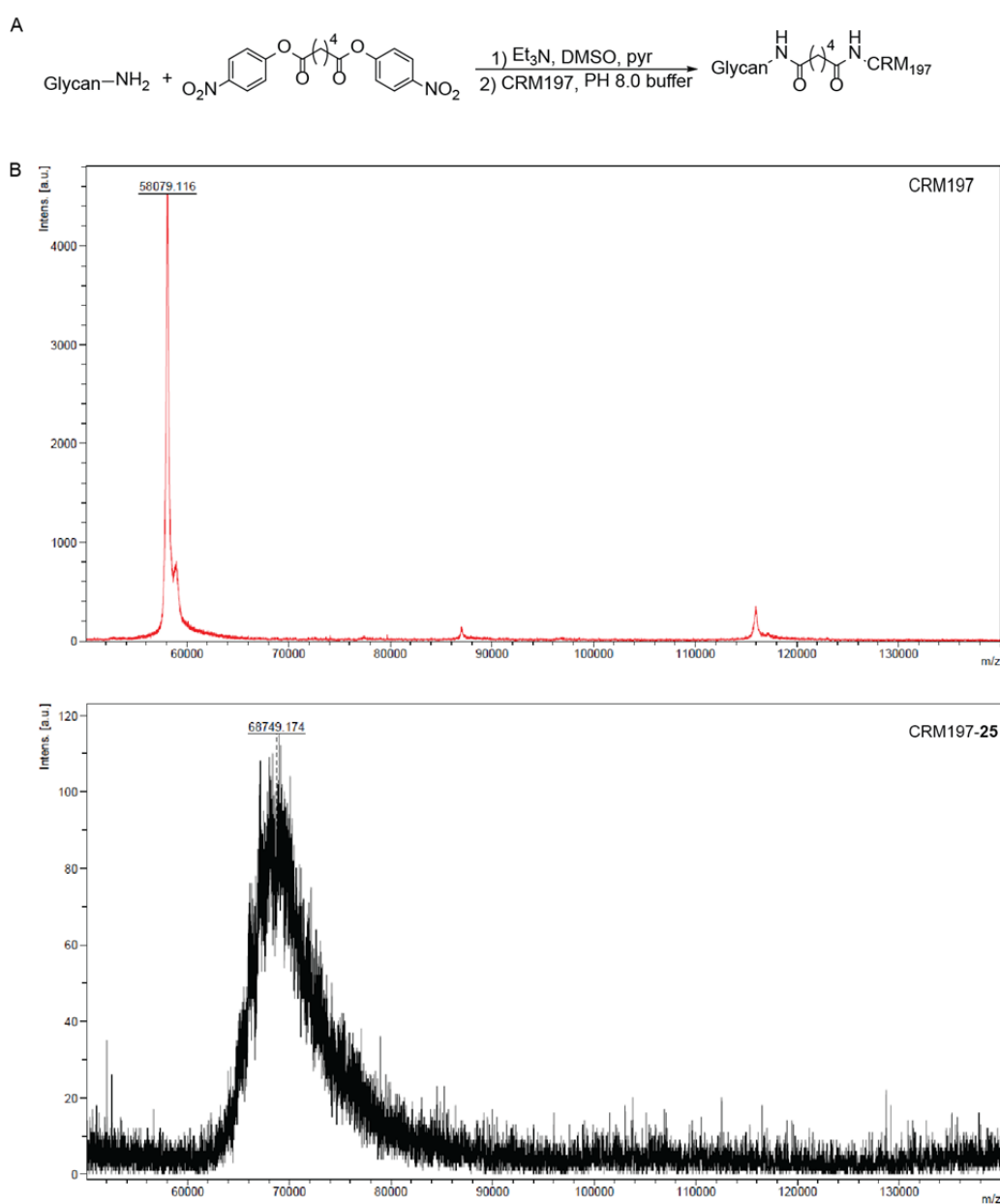
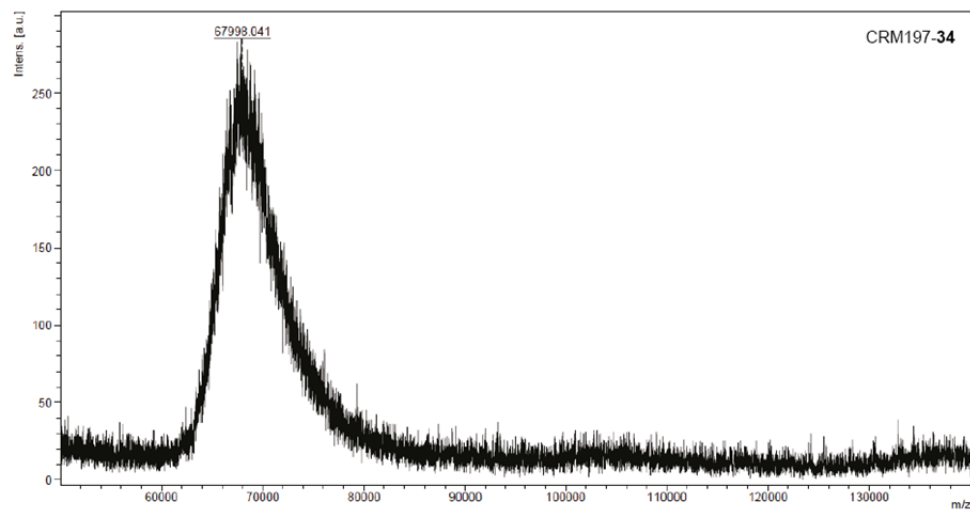
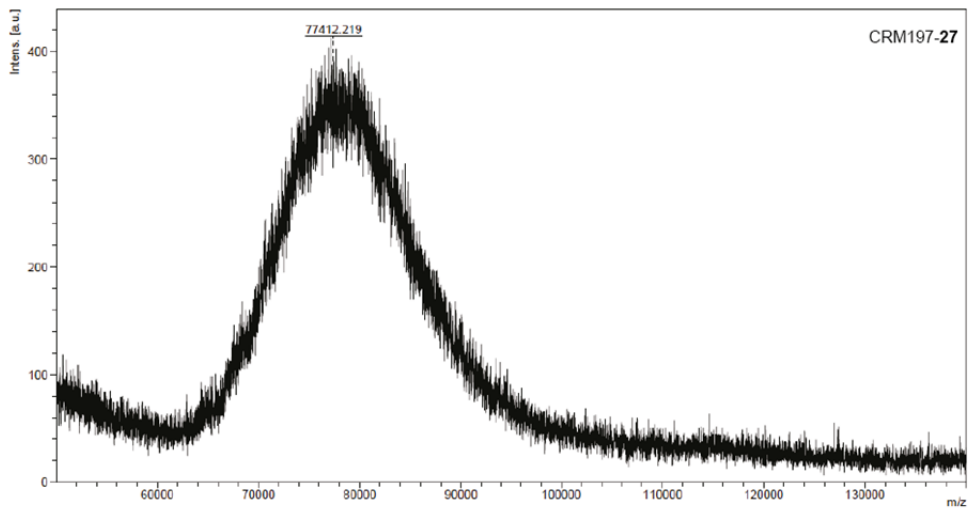
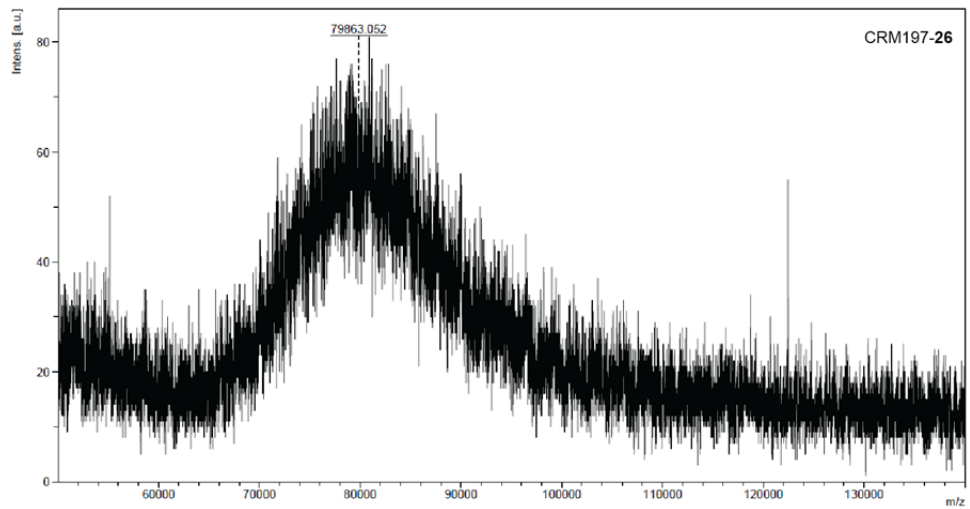

Figure 2.10: Evaluation of the antigenicity of synthetic structures using glycan microarray assays. (A) Microarray printing pattern. (B) Printed slides were incubated with a human reference serum mixture (dilution 1:100). The bound antibodies were detected using fluorescent labeled secondary antibodies. (C) Mean fluorescence intensities (MFI) of the microarrays assay. Data are represented as mean \pm SD of triplicate determinations.

2.2.5 Immunological evaluation of the glycoconjugates in mice

All synthetic glycans **25**, **26**, **27** and **34** were conjugated to carrier protein CRM197 using homobifunctional reagent, adipate 4-nitro phenyl diester,⁵³ under mild conditions (Figure 2.11-A). The resulting glycoconjugates contained 10.2, 11, 7 and 10.8 glycans, respectively, as calculated by matrix-assisted laser desorption/ionization-time of flight mass spectrometry (MALDI-TOF MS) (Figure 2.11-B) and confirmed by sodium dodecyl sulfate polyacrylamide gel electrophoresis (SDS-PAGE) (Figure 2.11-C).





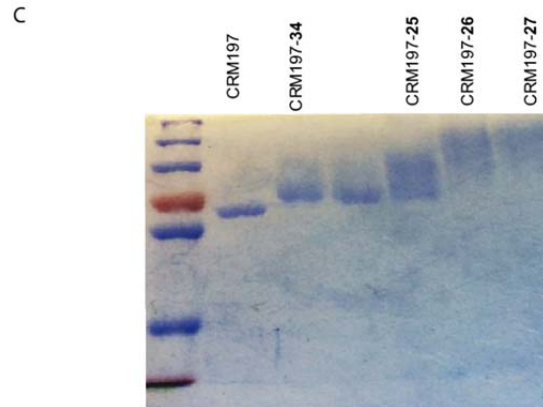

Figure 2.11: (A) Preparation of glycoconjugates. (B) Characterization of the conjugates with MALDI-TOF and (C) SDS-PAGE.

To test the immunogenicity of these conjugates, five female C57BL/6 mice per group were each immunized subcutaneously three times (days 0, 14 and 28) with 100 μ L of conjugates CRM197-25, CRM197-26, CRM197-27 and CRM197-34. Each dose contained 1 μ g sugar antigen and aluminum hydroxide which was used as adjuvant. Three mice in control group received only PBS with aluminum hydroxide. Sera were collected every week (Figure 2.12-A) and analyzed using glycan arrays with fluorescent labeled goat anti-mouse secondary antibodies for detection.

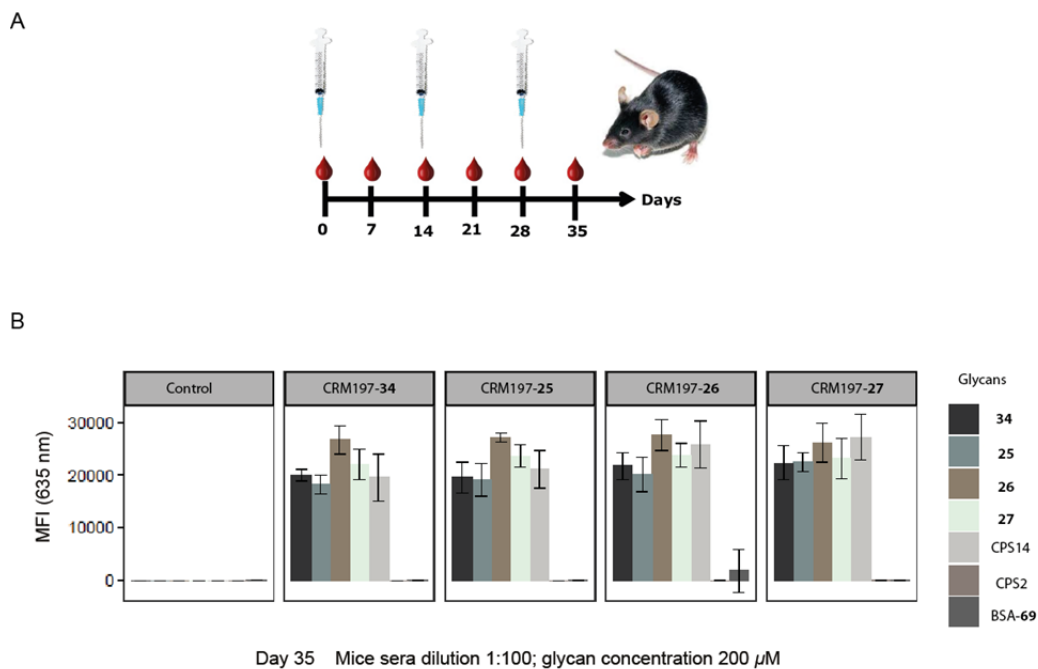
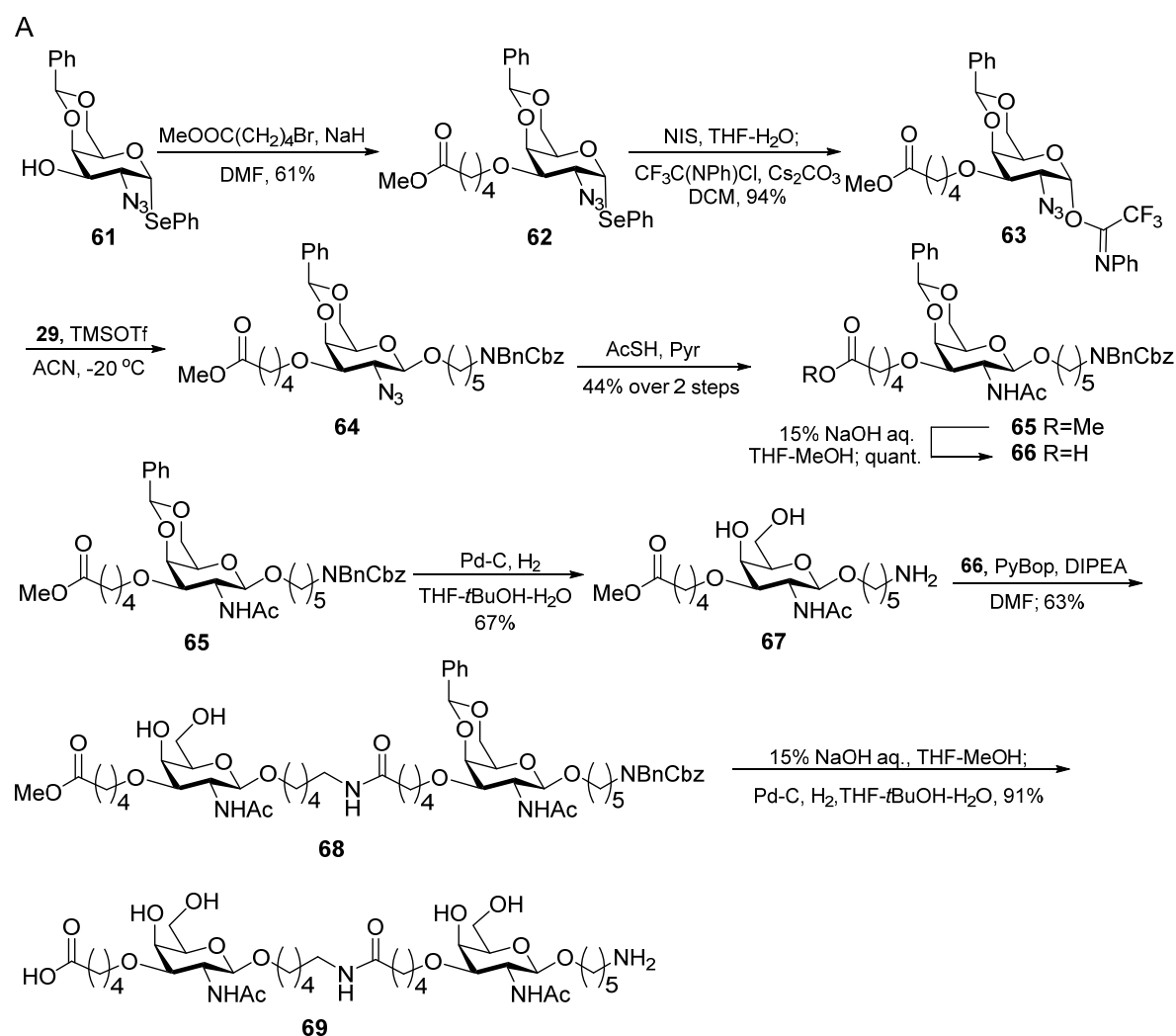

Figure 2.12: Analysis of antibody titers in sera using glycan arrays. (A) Immunization schedule of mice. (B) Antibody titers analysis of sera (day 35) using glycan arrays. MFI: mean fluorescence intensity.

A spacer dummy conjugate BSA-**69** was synthesized and printed on the slides for glycan array assay to detect antibodies against the spacer (Figure 2.10-A). The synthesis of **69** commenced with phenyl 2-azido-2-deoxy-4,6-*O*-benzylidene-1-seleno- α -D-galactopyranoside¹⁵³ **61** (Figure 2.13-A). 5-Methoxy-5-oxopentyl group was installed at the C-3 position to obtain **62**, which was treated with NIS in the presence of water followed by 2,2,2-trifluoro-*N*-phenylacetimidoyl chloride and cesium carbonate to afford imidate **63**. Glycosylation of **63** and linker **29** activated by TMSOTf produced **64**, of which the azide group was converted into acetamino group with thioacetic acid in pyridine to give **65**. Methyl ester was hydrolyzed to yield **66** with a free carboxyl group, while hydrogenation of **65** resulted **67** containing amino group. Coupling of **67** and **66** with PyBOP furnished **68**, which was fully deprotected to give **69**. The conjugation of **69** and BSA was achieved using bifunctional *p*-nitrophenyladipate (Figure 2.13-B) and characterized with MALDI-TOF (Figure 2.13-C).



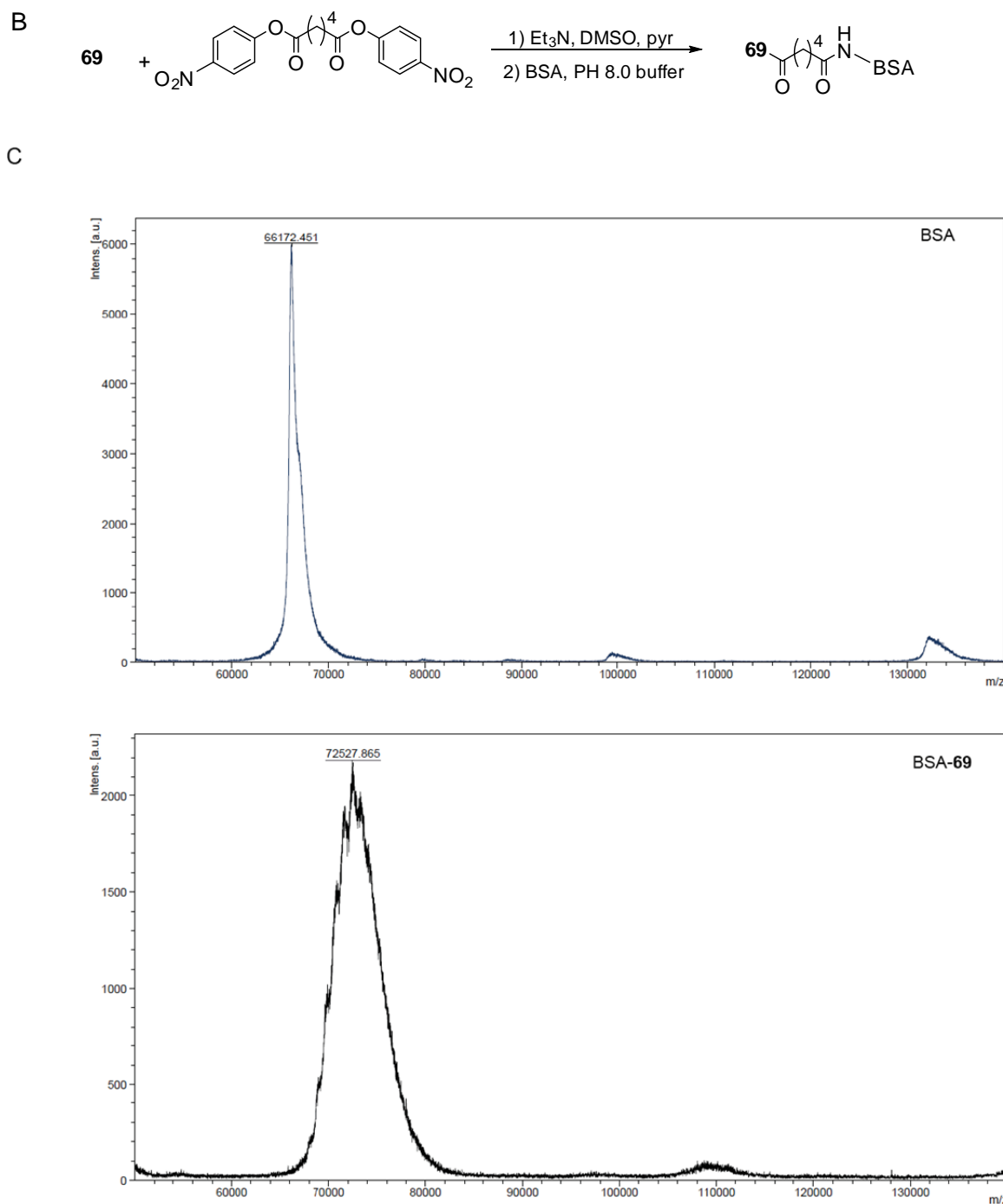

Figure 2.13: Synthesis of the dummy conjugate BSA-69 and its characterization by MALDI-TOF MS. The conjugate contains 7 glycans. BSA: bovine serum albumin.

The glycan array analysis (Figure 2.12-B) shows that all the test groups produced very high antibody titers against both the synthetic oligosaccharide derivatives as well as Pn14PS, while no humoral immune response was observed in the control group. None of the conjugates induced the production of detectable amounts of antibodies against the aliphatic spacer.

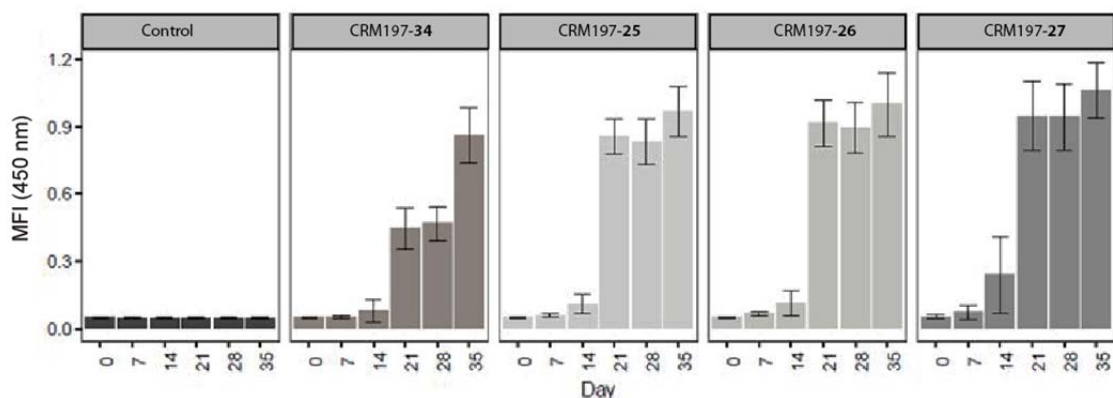

Figure 2.14: Analysis of antibody titers in sera using ELISA (sera dilution 1:500). MFI: mean fluorescence intensity.

The Pn14PS-specific antibody response raised by the conjugates was further detected by ELISA (Figure 2.14). 96-Well microtiter plates were coated with 10 $\mu\text{g/mL}$ of Pn14PS prior to incubation with mice sera. The ELISA data suggested that all three spacer bridged oligosaccharide derivative conjugates induced very high titers of CPS-specific antibodies. Interestingly, the specific antibody response raised against these derivatives were significantly higher ($p < 0.001$) after only two immunizations (days 21-28) when compared with tetrasaccharide RU only. The antibody titers of all the groups were still at a high level on day 156 after initial immunization (Figure 2.15).

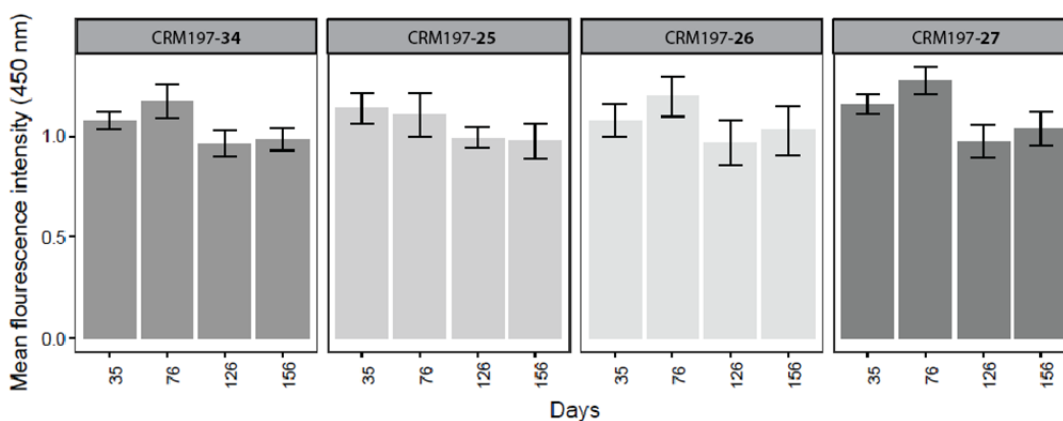

Figure 2.15: Analysis of long-term antibody titers in sera using ELISA (sera dilution 1:500).

2.3 Conclusion

Mono-, di- and trivalent derivatives **25**, **26** and **27** of Pn14PS were rapidly synthesized by using the strategy of bridging RUs with a ten-carbon aliphatic spacer through amide formation. All three oligosaccharide derivatives were then conjugated with carrier protein CRM197 as novel semisynthetic glycoconjugate vaccine candidates against ST-14.

The conjugates formulated with adjuvant aluminum hydroxide were immunological evaluated in mice. Both glycan array and ELISA analysis of the immune sera demonstrated that the aliphatic spacer did not decrease the antigenicity and immunogenicity. Interestingly, the specific Pn14PS antibody response raised against these derivatives were significantly higher after only two immunizations when compared with the branched tetrasaccharide RU only.

In a broader sense, this strategy reported in this chapter is of relevance for the future design of semisynthetic glycoconjugate, making the synthesis of carbohydrate antigens simpler and more efficient. Furthermore, fine adjustment of the spacer might help to decipher the interaction between glycan epitopes and recognition receptors on APCs.

2.4 Experimental section

2.4.1 Chemistry experiments

Chemicals were purchased as reagent grade and used without further purification unless stated otherwise. Anhydrous solvents were obtained from Waters Dry Solvent systems. Reactions were monitored by thin-layer chromatography (TLC) analysis, which was visualized by UV light (254 nm) and TLC sugar stain (1% (v/v) 3-methoxyphenol, 30% (v/v) sulfuric acid in ethanol). Flash column chromatography was performed on Kieselgel 60 with 230-400 mesh (Sigma-Aldrich, St. Louis, USA). ¹H-NMR, ¹³C-NMR spectra were recorded on a 400 or 600 MHz Varian or Bruker spectrometer at room temperature. Chemical shifts (in ppm) were calibrated with the solvent residual peak. Coupling constants (*J*) are reported in Hertz (Hz). Optical rotations (OR) were measured with a Schmidt & Haensch UniPol L 1000 at 589 nm and concentration (c) expressed in g/100

mL. High resolution mass spectrometry (HRMS) was performed by Waters Xevo Q-ToF mass spectrometer.

Ethyl 3-*O*-benzyl-4-*O*-fluorenylmethoxycarbonyl-6-*O*-levulinyl-2-deoxy-2-trichloroacetamino-1-thio- β -D-glucopyranoside (30)

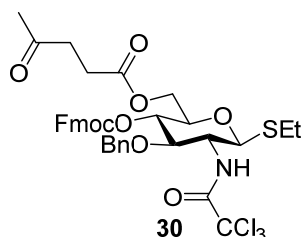

^1H NMR (400 MHz, CDCl_3) δ 7.68 (dd, $J = 7.5, 3.7$ Hz, 2H), 7.63 – 7.41 (m, 2H), 7.36 – 7.26 (m, 2H), 7.24 – 7.19 (m, 2H), 7.15 – 7.05 (m, 5H), 6.86 (d, $J = 7.7$ Hz, 1H), 4.98 (d, $J = 10.3$ Hz, 1H), 4.84 (dd, $J = 9.9, 9.0$ Hz, 1H), 4.54 (s, 2H), 4.42 (dd, $J = 10.5, 6.8$ Hz, 1H), 4.31 – 4.09 (m, 5H), 3.69 (ddd, $J = 10.0, 5.2, 2.8$ Hz, 1H), 3.56 (td, $J = 10.1, 7.9$ Hz, 1H), 2.73 – 2.58 (m, 4H), 2.56 – 2.49 (m, 2H), 2.09 (s, 3H), 1.28 – 1.12 (m, 3H).

NMR data was in accordance with previously reported values.¹⁴⁷

Ethyl 2,3-di-*O*-benzoyl-6-*O*-benzyl-4-*O*-fluorenylmethoxycarbonyl-1-thio- β -D-glucopyranoside (32)

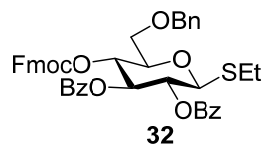

^1H NMR (400 MHz, CDCl_3) δ 7.96 (d, $J = 7.5$ Hz, 2H), 7.87 (d, $J = 7.5$ Hz, 2H), 7.71 (d, $J = 7.4$ Hz, 2H), 7.51 (t, $J = 7.3$ Hz, 1H), 7.48 – 7.21 (m, 16H), 7.17 (t, $J = 7.5$ Hz, 1H), 5.80 (t, $J = 9.4$ Hz, 1H), 5.49 (t, $J = 9.6$ Hz, 1H), 5.23 (t, $J = 9.7$ Hz, 1H), 4.76 (d, $J = 10.1$ Hz, 1H), 4.61 (d, $J = 12.1$ Hz, 1H), 4.56 (d, $J = 12.0$ Hz, 1H), 4.30 – 4.17 (m, 1H), 4.08 (t, $J = 8.9$ Hz, 1H), 4.01 – 3.90 (m, 2H), 3.74 (s, 2H), 2.87 – 2.68 (m, 2H), 1.28 (t, $J = 7.5$ Hz, 3H); ^{13}C NMR (101 MHz, CDCl_3) δ 165.8, 165.3, 154.2, 143.4, 143.1, 141.3,

141.2, 137.9, 133.4, 130.0 (2C), 129.3, 128.9, 128.5, 128.4, 127.9, 127.8, 127.2, 125.3, 125.1, 120.0, 83.9, 74.5, 73.8, 73.5, 70.6, 70.4, 69.1, 46.6, 24.4, 15.0.

NMR data was in accordance with previously reported values.¹⁴⁸

Ethyl 2-*O*-benzoyl-4,6-di-*O*-benzyl-3-*O*-(9-fluorenylmethoxycarbonyl)-1-thio- β -D-galactopyranoside (35)

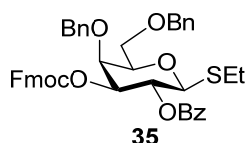

¹H NMR (400 MHz, CDCl₃) δ 8.08 – 8.00 (m, 2H), 7.68 (m, 2H), 7.58 – 7.48 (m, 1H), 7.48 – 7.27 (m, 16H), 7.11 (m, 2H), 5.75 (t, $J = 9.9$ Hz, 1H), 5.07 (dd, $J = 10.0, 3.0$ Hz, 1H), 4.79 (d, $J = 11.5$ Hz, 1H), 4.60 (d, $J = 9.9$ Hz, 1H), 4.51 (d, $J = 11.8$ Hz, 2H), 4.46 (d, $J = 11.7$ Hz, 1H), 4.30 (dd, $J = 10.4, 7.2$ Hz, 1H), 4.21 (dd, $J = 10.4, 7.8$ Hz, 1H), 4.14 (d, $J = 3.1$ Hz, 1H), 4.06 (t, $J = 7.4$ Hz, 1H), 3.82 (t, $J = 6.5$ Hz, 1H), 3.72 – 3.62 (m, 2H), 2.74 (m, 2H), 1.23 (t, $J = 7.5$ Hz, 3H).

NMR data was in accordance with previously reported values.¹⁴⁹

Ethyl 4,6-*O*-benzylidene-3-*O*-(methyl 5-pentanoate)-1-thio- β -D-galactopyranoside (43)

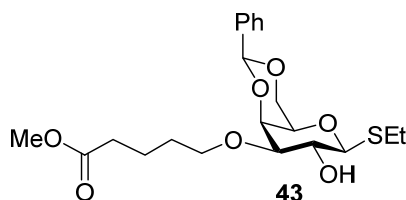

Bu₂SnO (5.2 g, 20.8 mmol) was added to a solution of compound **36** (5.0 g, 16.0 mmol) in MeOH (80 mL) and the mixture was heated to 80 °C overnight. The reaction mixture was concentrated under vacuum which was then dried azeotropically twice with toluene. The crude was dissolved in anhydrous DMF (80 mL) followed by the addition of methyl

5-bromopentanoate (2.8 mL, 19.2 mmol) and CsF (3.7 g, 24.0 mmol). The reaction was stirred at 60 °C overnight, quenched with water and extracted with DCM. The organic layer was washed with aqueous saturated NaHCO₃ solution, brine, dried over Na₂SO₄, filtered and concentrated. The crude was purified by flash column chromatography using 50% ethyl acetate in hexanes to afford compound **43** (4.4 g, 10.2 mmol, 64%) as a white foam.

¹H NMR (400 MHz, CDCl₃) δ 7.52 – 7.42 (m, 2H), 7.37 – 7.29 (m, 3H), 5.51 (s, 1H), 4.35 (t, *J* = 10.5 Hz, 2H), 4.31 (d, *J* = 3.4 Hz, 1H), 4.02 (d, *J* = 11.1 Hz, 1H), 3.96 (t, *J* = 9.3 Hz, 1H), 3.75 – 3.64 (m, 1H), 3.63 (s, 3H), 3.59 – 3.50 (m, 1H), 3.46 (s, 1H), 3.37 (dd, *J* = 9.2, 3.3 Hz, 1H), 2.87 – 2.78 (m, 1H), 2.77 – 2.67 (m, 1H), 2.60 (s, 1H), 2.32 (t, *J* = 7.0 Hz, 2H), 1.75 – 1.61 (m, 4H), 1.32 (t, *J* = 7.4 Hz, 3H); ¹³C NMR (101 MHz, CDCl₃) δ 174.0, 137.8, 128.9, 128.1, 126.3, 101.2, 85.2, 81.2, 72.9, 70.2, 69.5, 68.7, 67.7, 51.5, 33.6, 29.1, 22.9, 21.6, 15.3; HRMS (ESI) calcd for C₂₁H₃₀O₇SNa [M+Na]⁺ 449.1604; found: 449.1604.

Ethyl 2-*O*-benzoyl-4,6-*O*-benzylidene-3-*O*-(methyl 5-pentanoate)-1-thio-β-D-galactopyranoside (44)

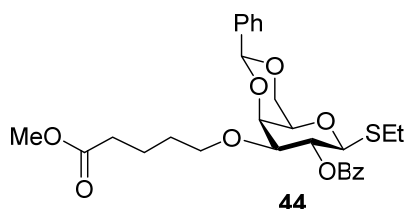

To a solution of compound **43** (1.44 g, 3.38 mmol) in DCM (15 mL) were added Bz₂O (1.15 g, 5.06 mmol), TEA (1.4 mL, 10.13 mmol) and DMAP (82.5 mg, 0.68 mmol). The reaction mixture was stirred for 3 h at room temperature. After the starting material disappeared, the reaction was quenched with saturated aqueous NaHCO₃ solution. The aqueous layer was washed three times with DCM. The combined organic layer was washed with brine solution, dried over Na₂SO₄, filtered and concentrated *in vacuo*. The residue was purified by flash column chromatography with 30% ethyl acetate in hexanes to get compound **44** (1.48 g, 2.79 mmol, 83%) as a white foam.

^1H NMR (400 MHz, CDCl_3) δ 8.03 (d, $J = 7.3$ Hz, 2H), 7.60 – 7.47 (m, 3H), 7.47 – 7.28 (m, 5H), 5.63 (t, $J = 9.7$ Hz, 1H), 5.55 (s, 1H), 4.57 (d, $J = 9.8$ Hz, 1H), 4.42 – 4.29 (m, 2H), 4.05 (d, $J = 12.3$ Hz, 1H), 3.70 – 3.59 (m, 2H), 3.53 (s, 4H), 3.42 (dt, $J = 9.4, 5.8$ Hz, 1H), 3.00 – 2.83 (m, 1H), 2.81 – 2.67 (m, 1H), 2.15 – 2.04 (m, 2H), 1.54 – 1.40 (m, 4H), 1.26 (t, $J = 7.5$ Hz, 3H); ^{13}C NMR (101 MHz, CDCl_3) δ 173.9, 165.2, 137.7, 132.9, 130.1, 129.7, 129.0, 128.3, 128.2, 126.4, 101.3, 82.8, 79.7, 73.5, 70.2, 69.4, 69.2, 68.7, 51.4, 33.4, 28.9, 22.6, 21.4, 14.8; HRMS (ESI) calcd for $\text{C}_{28}\text{H}_{34}\text{O}_8\text{SNa}$ $[\text{M}+\text{Na}]^+$ 553.1866; found: 553.1874.

Ethyl 2-*O*-benzoyl-3-*O*-(methyl 5-pentanoate)-1-thio- β -D-galactopyranoside (45)

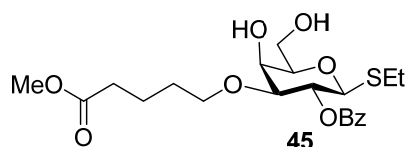

Ethanethiol (0.8 mL, 11.3 mmol) and TsOH (14.3 mg, 76 μmol) were added to a solution of compound **44** (200 mg, 0.38 mmol) in DCM (5 mL). The reaction mixture was stirred for 1 h. After the starting material disappeared, the reaction was quenched with triethylamine and concentrated. The residue was purified by flash column chromatography with 75% EA/Hex to give compound **45** (152 mg, 0.34 mmol, 91%) as a colorless oil.

^1H NMR (400 MHz, CDCl_3) δ 8.03 (d, $J = 7.8$ Hz, 2H), 7.56 (t, $J = 7.2$ Hz, 1H), 7.44 (t, $J = 7.6$ Hz, 2H), 5.44 (t, $J = 9.7$ Hz, 1H), 4.52 (d, $J = 10.0$ Hz, 1H), 4.16 (d, $J = 2.9$ Hz, 1H), 4.00 (dd, $J = 11.7, 6.8$ Hz, 1H), 3.83 (dd, $J = 11.8, 4.5$ Hz, 1H), 3.69 – 3.60 (m, 2H), 3.59 – 3.52 (m, 4H), 3.48 – 3.36 (m, 1H), 2.84 – 2.61 (m, 2H), 2.39 (brs, 2H), 2.12 (t, $J = 6.6$ Hz, 2H), 1.61 – 1.38 (m, 4H), 1.21 (t, $J = 7.4$ Hz, 3H); ^{13}C NMR (101 MHz, CDCl_3) δ 173.8, 165.4, 133.1, 129.8, 129.7, 128.4, 83.5, 80.9, 78.4, 70.0, 69.5, 67.2, 62.6, 51.5, 33.4, 29.1, 23.6, 21.3, 14.8.

Ethyl 2-*O*-benzoyl-4,6-di-*O*-benzyl-3-*O*-(methyl 5-pentanoate)-1-thio- β -D-galactopyranoside (33)

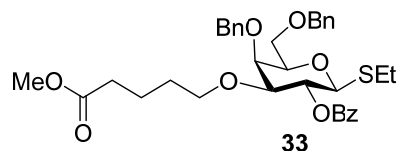

Benzyl bromide (160 μ L, 1.36 mmol) and sodium hydride (54.2 mg, 1.36 mmol, 60% wt) were added to a solution of compound **45** (150 mg, 0.34 mmol) in DMF (4 mL) at 0 °C. The reaction mixture was stirred for 30 min at room temperature and quenched by acetic acid. The mixture was diluted with DCM and then washed with saturated aqueous NaHCO₃ solution and brine. The organic layer was dried over Na₂SO₄, filtered and concentrated. The residue was purified by flash column chromatography with 30% ethyl acetate in hexanes to obtain compound **33** (181 mg, 0.29 mmol, 85%) as a white solid.

¹H NMR (400 MHz, CDCl₃) δ 8.04 (d, J = 7.5 Hz, 2H), 7.55 (t, J = 7.4 Hz, 1H), 7.43 (t, J = 7.6 Hz, 2H), 7.30 (dt, J = 11.0, 7.5 Hz, 10H), 5.59 (t, J = 9.7 Hz, 1H), 4.95 (d, J = 11.7 Hz, 1H), 4.58 (d, J = 11.7 Hz, 1H), 4.51 (d, J = 9.9 Hz, 1H), 4.44 (q, J = 11.7 Hz, 2H), 4.00 (d, J = 2.0 Hz, 1H), 3.73 – 3.57 (m, 4H), 3.53 (d, J = 7.1 Hz, 4H), 3.45 – 3.32 (m, 1H), 2.80 – 2.59 (m, 2H), 2.10 (t, J = 6.9 Hz, 2H), 1.57 – 1.36 (m, 4H), 1.20 (t, J = 7.4 Hz, 3H); ¹³C NMR (101 MHz, CDCl₃) δ 173.8, 165.4, 138.6, 137.8, 133.0, 130.1, 129.7, 128.4, 128.3, 128.2, 128.0, 127.8, 127.5, 110.0, 83.7, 82.7, 77.5, 74.4, 73.6, 73.1, 70.4, 70.3, 68.5, 51.4, 33.4, 29.3, 23.7, 21.4, 14.8; HRMS (ESI) calcd for C₃₅H₄₂O₈SNa [M+Na]⁺ 645.2492; found: 645.2521.

Ethyl 4,6-*O*-benzylidene-2,3-di-*O*-(2-naphthylmethyl)-1-thio- β -D-galactopyranoside (**39**)

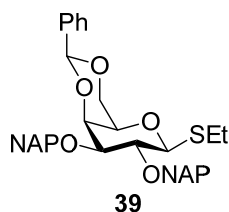

Sodium hydride (768 mg, 19.2 mmol, 60% wt) was added to a solution of compound **36** (2.0 g, 6.40 mmol) in DMF (20 mL) and THF (20 mL) at 0 °C. The reaction mixture was stirred for 15 min at room temperature followed by the addition of 2-

bromomethylnaphthalene (4.3 g, 19.2 mmol). The reaction mixture was stirred for 3 h and quenched with saturated aqueous NH_4Cl solution and extracted with DCM. The aqueous layer was washed three times with DCM. The combined organic layer was washed with brine, dried over Na_2SO_4 , filtered and concentrated. The residue was purified by flash column chromatography using 30% ethyl acetate in hexanes to give compound **39** (3.2 g, 5.4 mmol, 84%) as a pale yellow solid.

^1H NMR (400 MHz, CDCl_3) δ 7.88 – 7.72 (m, 7H), 7.66 (d, $J = 7.8$ Hz, 1H), 7.61 – 7.33 (m, 11H), 5.48 (s, 1H), 5.09 (d, $J = 10.4$ Hz, 1H), 5.02 (d, $J = 10.4$ Hz, 1H), 4.98 – 4.87 (m, 2H), 4.46 (d, $J = 9.6$ Hz, 1H), 4.29 (d, $J = 12.3$ Hz, 1H), 4.18 (d, $J = 3.4$ Hz, 1H), 4.02 – 3.89 (m, 2H), 3.66 (dd, $J = 9.2, 3.4$ Hz, 1H), 3.33 (s, 1H), 2.95 – 2.81 (m, 1H), 2.81 – 2.67 (m, 1H), 1.33 (t, $J = 7.4$ Hz, 3H); ^{13}C NMR (101 MHz, CDCl_3) δ 138.0, 136.1, 135.9, 133.4, 133.3, 133.2, 129.2, 128.4, 128.3, 128.2, 128.1, 128.0, 127.8, 127.7, 127.1, 126.7, 126.7, 126.6, 126.3, 126.1, 126.0, 125.9, 101.7, 84.6, 81.1, 75.9, 74.2, 72.0, 69.9, 69.5, 24.0, 15.2.

Ethyl 2,3-di-*O*-(2-naphthylmethyl)-1-thio- β -D-galactopyranoside (**40**)

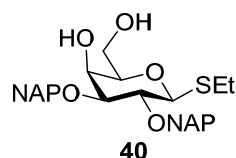

Ethanethiol (11 mL, 151 mmol) and TsOH (191 mg, 1 mmol) were added to a solution of compound **39** (2.98 g, 5.03 mmol) in DCM (30 mL). The reaction mixture was stirred for 1 h. After the starting material disappeared, the reaction was quenched with triethylamine and concentrated. The residue was purified by flash column chromatography with 70% ethyl acetate in hexanes to afford compound **40** (152 mg, 0.34 mmol, 91%) as a colorless oil.

^1H NMR (400 MHz, CDCl_3) δ 7.90 – 7.72 (m, 7H), 7.68 (d, $J = 7.8$ Hz, 1H), 7.54 (d, $J = 9.4$ Hz, 1H), 7.50 – 7.39 (m, 5H), 5.07 (d, $J = 10.5$ Hz, 1H), 4.94 (d, $J = 10.6$ Hz, 1H), 4.88 (q, $J = 11.9$ Hz, 2H), 4.46 (d, $J = 9.7$ Hz, 1H), 4.09 (d, $J = 3.0$ Hz, 1H), 3.95 (dd, $J = 11.8, 6.6$ Hz, 1H), 3.83 – 3.72 (m, 2H), 3.62 (dd, $J = 9.0, 3.2$ Hz, 1H), 3.52 – 3.43 (m,

1H), 2.88 – 2.66 (m, 2H), 2.28 (s, 2H), 1.32 (t, $J = 7.4$ Hz, 3H); ^{13}C NMR (101 MHz, CDCl_3) δ 135.7, 135.1, 133.4, 133.3, 133.2, 128.6, 128.2, 128.1, 128.0, 127.8 (2C), 127.1, 126.9, 126.5, 126.4, 126.3, 126.1, 126.0, 125.9, 85.4, 82.1, 78.0, 77.9, 76.0, 72.4, 67.7, 62.9, 25.1, 15.3; HRMS (ESI) calcd for $\text{C}_{30}\text{H}_{32}\text{O}_5\text{SNa}$ $[\text{M}+\text{Na}]^+$ 527.1862; found: 527.1866.

Ethyl 4,6-di-*O*-benzyl-1-thio- β -D-galactopyranoside (**42**)

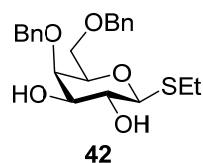

Sodium hydride (1.07 g, 26.8 mmol, 60%) was added to a solution of compound **40** (3.38 g, 6.70 mmol) in DMF (10 mL) and THF (10 mL) at 0 °C. The reaction was stirred for 15 min at room temperature followed by the addition of benzyl bromide (3.19 mL, 26.8 mmol). After 3 h, the reaction was quenched with aqueous saturated NH_4Cl solution and extracted three times with ethyl acetate. The combined organic layer was washed with brine, dried over Na_2SO_4 , filtered and concentrated. The residue was purified by flash column chromatography with 20% ethyl acetate in hexanes to give compound **41** (3.65 g, 5.33 mmol, 80%) as white solid. Then compound **41** was dissolved in DCM (30 mL) and H_2O (6 mL) followed by the addition of DDQ (6.08 g, 26.8 mmol) at 0 °C. The mixture was slowly warmed to room temperature and stirred for 1 h. The reaction mixture was quenched with water, extracted three times with DCM. The combined organic layer was washed with brine, dried over Na_2SO_4 , filtered and concentrated. The residue was purified by flash column chromatography using 30% ethyl acetate in hexanes to obtain compound **42** (1.92 g, 4.76 mmol, 71%) as a white solid.

^1H NMR (400 MHz, CDCl_3) δ 7.40 – 7.26 (m, 10H), 4.73 (d, $J = 11.7$ Hz, 1H), 4.68 (d, $J = 11.7$ Hz, 1H), 4.52 (d, $J = 11.8$ Hz, 1H), 4.47 (d, $J = 11.8$ Hz, 1H), 4.29 (d, $J = 9.4$ Hz, 1H), 3.92 (d, $J = 3.1$ Hz, 1H), 3.72 – 3.63 (m, 4H), 3.63 – 3.57 (m, 1H), 2.80 – 2.65 (m, 2H), 2.63 (s, 1H), 2.51 (s, 1H), 1.30 (t, $J = 7.4$ Hz, 3H); ^{13}C NMR (100 MHz, CDCl_3) δ 138.6, 138.0, 128.7, 128.6, 128.2, 128.1 (3C), 86.5, 77.8, 76.4, 75.6, 75.4, 73.8, 71.2, 68.7, 24.8, 15.6.

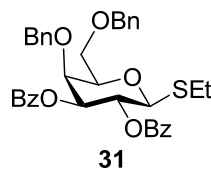
Ethyl 2,3-di-O-benzoyl-4,6-di-O-benzyl-1-thio- β -D-galactopyranoside (31)

To a solution of compound **42** (0.81 g, 1.99 mmol) in DCM (5 mL) were added Bz₂O (1.36 g, 5.99 mmol), triethylamine (2.2 mL, 15.98 mmol) and DMAP (48.8 mg, 0.40 mmol). The reaction was stirred for 3 h at room temperature and quenched by aqueous saturated NaHCO₃ solution. The aqueous layer was extracted three times with DCM. The combined organic layer was washed with brine, dried over Na₂SO₄, filtered and concentrated *in vacuo*. The residue was purified by flash column chromatography with 30% ethyl acetate in hexanes to give compound **31** (1.1 g, 1.79 mmol, 90%) as a white foam.

¹H NMR (400 MHz, CDCl₃) δ 8.04 – 7.89 (m, 4H), 7.58 – 7.44 (m, 2H), 7.43 – 7.19 (m, 14H), 5.92 (t, *J* = 10.0 Hz, 1H), 5.43 (dd, *J* = 10.0, 3.0 Hz, 1H), 4.79 – 4.69 (m, 2H), 4.57 – 4.52 (m, 2H), 4.48 (d, *J* = 11.8 Hz, 1H), 4.29 (d, *J* = 2.6 Hz, 1H), 3.95 (t, *J* = 6.6 Hz, 1H), 3.77 – 3.63 (m, 2H), 2.89 – 2.68 (m, 2H), 1.28 (t, *J* = 7.5 Hz, 3H); HRMS (ESI) calcd for C₃₆H₃₆O₇SNa [M+Na]⁺ 635.2074; found: 635.2097.

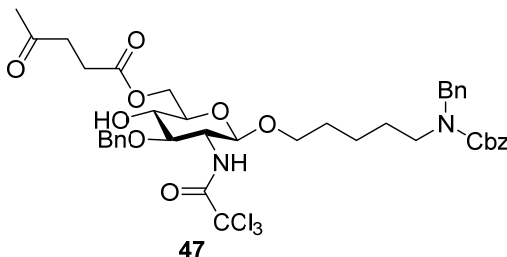
N-Benzyl-N-benzoyloxycarbonyl-5-pentyl 3-O-benzyl-6-O-levulinyl-2-deoxy-2-trichloroacetamino- β -D-glucopyranoside (47)

Monosaccharide **30** (500 mg, 0.64 mmol) and linker **29** (315 mg, 0.97 mmol) were mixed and co-evaporated three times with anhydrous toluene. Pre-activated molecular sieves AW-300 and anhydrous DCM (5 mL) were added and the mixture was stirred at room

temperature for 20 min. The mixture was cooled down to $-10\text{ }^{\circ}\text{C}$ and NIS (215 mg, 0.97 mmol) followed by triflic acid ($8.6\ \mu\text{L}$, 0.097 mmol) were added. The reaction mixture was stirred at $-10\text{ }^{\circ}\text{C}$ for 1.5 h. The reaction was quenched with saturated aqueous NaHCO_3 solution and 10% $\text{Na}_2\text{S}_2\text{O}_3$ solution. The aqueous layer was extracted three times with DCM. The combined organic layer was washed with brine, dried over Na_2SO_4 , filtered and concentrated in *vacuo* to give crude compound **46**. The crude was then dissolved in DCM (5 mL) followed by the addition of TEA (1 mL), the reaction mixture was stirred for 2 hours at room temperature. The solvent was removed and the residue was purified by flash column chromatography with 15% acetone in toluene to yield compound **47** (468 mg, 0.57 mmol, 89%) as a white foam.

^1H NMR (400 MHz, CDCl_3) δ 7.37 – 7.15 (m, 15H), 5.19 (d, $J = 14.4$ Hz, 2H), 4.92 – 4.75 (m, 3H), 4.59 (d, $J = 12.1$ Hz, 1H), 4.50 (s, 2H), 4.25 (d, $J = 12.1$ Hz, 1H), 4.08 (q, $J = 10.2$ Hz, 1H), 3.92 – 3.79 (m, 1H), 3.64 – 3.56 (m, 1H), 3.55 – 3.36 (m, 3H), 3.22 (m, 2H), 3.04 (d, $J = 12.5$ Hz, 1H), 2.80 (t, $J = 6.5$ Hz, 2H), 2.63 (t, $J = 5.9$ Hz, 2H), 2.21 (s, 3H), 1.53 (m, 4H), 1.28 (m, 2H); ^{13}C NMR (101 MHz, CDCl_3) δ 207.1, 173.6, 162.1, 156.8, 156.3, 138.1, 137.9, 137.0, 136.8, 128.7, 128.7, 128.6, 128.3, 128.2, 128.1, 128.0, 127.4, 127.3, 99.5, 92.6, 79.3, 79.2, 75.0, 74.0, 71.1, 70.1, 67.3, 63.4, 58.7, 50.6, 50.4, 47.3, 46.2, 38.1, 30.0, 29.0, 28.1, 27.4, 23.5, 23.3; HRMS (ESI) calcd for $\text{C}_{40}\text{H}_{47}\text{O}_{10}\text{N}_2\text{Cl}_3\text{Na}$ $[\text{M}+\text{Na}]^+$ 845.2167; found: 845.2214.

***N*-Benzyl-*N*-benzyloxycarbonyl-5-pentyl 2,3-di-*O*-benzoyl-4,6-di-*O*-benzyl- β -D-galactopyranosyl-(1 \rightarrow 4)-3-*O*-benzyl-6-*O*-levulinyl-2-deoxy-2-trichloroacetamino- β -D-glucopyranoside (**48**)**

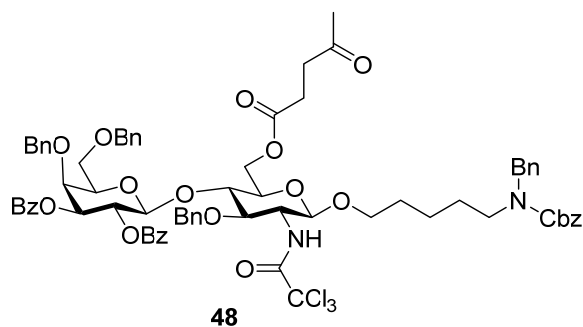

Both monosaccharides **47** (84 mg, 0.102 mmol) and **31** (75 mg, 0.123 mmol) were mixed and co-evaporated three times using anhydrous toluene. Pre-activated molecular sieves AW-300 and anhydrous DCM (3 mL) were added and the reaction mixture was stirred at room temperature for 20 min. Then the mixture was cooled down to -30 °C and NIS (34.5 mg, 0.153 mmol) followed by triflic acid (1.5 μ L, 0.016 mmol) were added. The reaction mixture was stirred at -10 °C for 1.5 h. The reaction was quenched with triethylamine. The mixture was extracted with saturated aqueous NaHCO₃ solution. The combined organic layer was washed with brine solution, dried over Na₂SO₄, filtered and concentrated in *vacuo*. The residue was purified by flash column chromatography with 15% acetone in toluene to give compound **48** (126 mg, 0.092 mmol, 90%) as a white foam.

¹H NMR (400 MHz, CDCl₃) δ 7.95 (d, J = 7.5 Hz, 2H), 7.86 (d, J = 7.4 Hz, 2H), 7.47 – 7.38 (m, 2H), 7.36 – 7.04 (m, 30H), 5.78 (dd, J = 10.3, 7.9 Hz, 1H), 5.44 (dd, J = 10.5, 2.9 Hz, 1H), 5.07 (d, J = 8.8 Hz, 2H), 4.94 (d, J = 10.8 Hz, 1H), 4.82 (d, J = 7.9 Hz, 1H), 4.64 (d, J = 11.3 Hz, 2H), 4.55 (d, J = 10.9 Hz, 1H), 4.38 (d, J = 11.0 Hz, 3H), 4.31 (d, J = 11.9 Hz, 1H), 4.27 – 4.14 (m, 3H), 4.11 – 4.03 (m, 1H), 4.01 – 3.91 (m, 2H), 3.87 (t, J = 7.8 Hz, 1H), 3.68 – 3.54 (m, 1H), 3.46 (t, J = 8.5 Hz, 2H), 3.42 – 3.31 (m, 2H), 3.24 – 3.02 (m, 3H), 2.84 – 2.71 (m, 1H), 2.62 – 2.44 (m, 2H), 2.41 – 2.30 (m, 1H), 2.14 (s, 3H), 1.48 – 1.30 (m, 4H), 1.18 – 1.05 (m, 2H); ¹³C NMR (101 MHz, CDCl₃) δ 206.7, 172.6, 165.9, 165.5, 138.2, 138.1, 138.0, 133.4, 133.3, 130.1, 130.0, 129.4, 129.3, 128.7, 128.6, 128.5 (2C), 128.4, 128.3, 128.2, 128.1, 128.0, 127.9, 127.8, 127.7, 127.3, 100.8, 99.5, 75.3, 74.8, 74.6, 74.5, 73.5, 70.9, 68.0, 67.3, 62.7, 60.5, 38.1, 30.0, 28.1, 21.2, 14.4; HRMS (ESI) calcd for C₇₄H₇₇O₁₇N₂Cl₃Na [M+Na]⁺ 1395.4175; found: 1395.4107.

***N*-Benzyl-*N*-benzyloxycarbonyl-5-pentyl 2,3-di-*O*-benzoyl-4,6-di-*O*-benzyl- β -D-galactopyranosyl-(1 \rightarrow 4)-3-*O*-benzyl-2-deoxy-2-trichloroacetamino- β -D-glucopyranoside (49)**

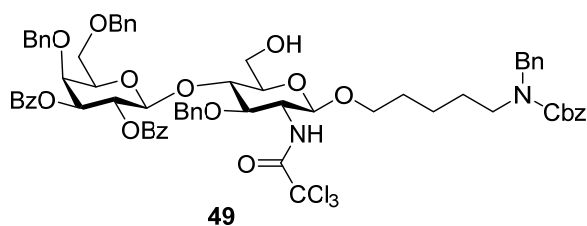

To a solution of compound **48** (30.6 mg, 0.022 mmol) in DCM (3 mL) was added a mixture of pyridine (0.06 mL) and acetic acid (0.04 mL) followed by the addition of hydrazine hydrate (2 μ L, 0.045 mmol) at room temperature. The reaction was stirred for 4 h and diluted with ethyl acetate, quenched with acetone and poured into water. The aqueous layer was washed three times with ethyl acetate. The combined organic layer was washed with brine, dried over Na_2SO_4 , filtered and concentrated. The residue was purified by flash column chromatography with 30% acetone in hexanes to afford compound **49** (26.8 mg, 0.021 mmol, 94%) as a white foam.

^1H NMR (400 MHz, CDCl_3) δ 7.98 (d, $J = 7.5$ Hz, 2H), 7.92 (d, $J = 7.5$ Hz, 2H), 7.54 – 7.44 (m, 2H), 7.41 – 7.02 (m, 30H), 5.84 (dd, $J = 10.3, 8.1$ Hz, 1H), 5.36 (dd, $J = 10.5, 2.9$ Hz, 1H), 5.13 (d, $J = 9.4$ Hz, 2H), 5.03 (d, $J = 10.5$ Hz, 1H), 4.88 (d, $J = 7.1$ Hz, 1H), 4.81 – 4.67 (m, 2H), 4.59 (d, $J = 10.6$ Hz, 1H), 4.51 – 4.40 (m, 3H), 4.35 (d, $J = 11.8$ Hz, 1H), 4.29 – 4.17 (m, 2H), 4.02 (d, $J = 8.4$ Hz, 1H), 3.94 (t, $J = 8.4$ Hz, 1H), 3.88 – 3.78 (m, 1H), 3.77 – 3.60 (m, 3H), 3.54 (t, $J = 8.5$ Hz, 1H), 3.48 – 3.31 (m, 3H), 3.31 – 3.08 (m, 4H), 1.53 – 1.34 (m, 4H), 1.24 – 1.09 (m, 2H); ^{13}C NMR (101 MHz, CDCl_3) δ 165.9, 165.3, 138.1, 138.0, 133.5, 133.4, 130.0, 129.8, 129.5, 129.2, 128.7, 128.6, 128.6, 128.5, 128.4, 128.3 (2C), 128.0, 127.9 (2C), 127.8, 127.7, 127.6, 127.4, 100.9, 99.5, 77.7, 76.5, 75.5, 75.3, 75.0, 74.6, 74.4, 73.6, 73.6, 71.0, 69.9, 67.8, 67.3, 60.9, 58.3, 50.4, 47.2, 29.1, 27.3, 23.3; HRMS (ESI) calcd for $\text{C}_{69}\text{H}_{71}\text{O}_{15}\text{N}_2\text{Cl}_3\text{Na}$ $[\text{M}+\text{Na}]^+$ 1297.3805; found: 1297.3794.

***N*-Benzyl-*N*-benzyloxycarbonyl-5-pentyl 2,3-di-*O*-benzoyl-6-*O*-benzyl- β -D-glucopyranosyl-(1 \rightarrow 6)-4-*O*-(2,3-di-*O*-benzoyl-4,6-di-*O*-benzyl- β -D-galactopyranosyl)-3-*O*-benzyl-2-deoxy-2-trichloroacetamino- β -D-glucopyranoside (51)**

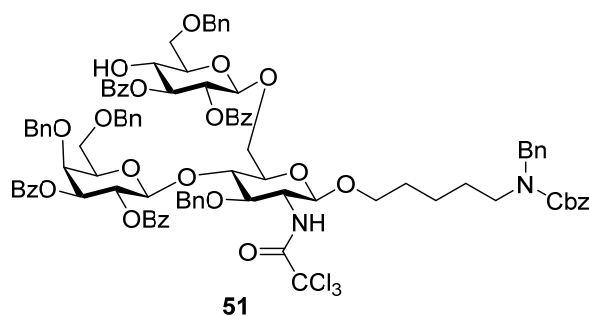

Disaccharide **49** (240 mg, 0.188 mmol) and thioglycoside **32** (168 mg, 0.226 mmol) were mixed and co-evaporated three times using anhydrous toluene. Pre-activated molecular sieves AW-300 and anhydrous DCM (5 mL) were added and the mixture was stirred for 20 min at room temperature. The mixture was cooled down to $-10\text{ }^{\circ}\text{C}$ and NIS (83 mg, 0.367 mmol) followed by triflic acid ($3.3\text{ }\mu\text{L}$, 0.037 mmol) were added. The reaction was stirred at $-10\text{ }^{\circ}\text{C}$ for 1.5 h and quenched with saturated aqueous NaHCO_3 solution and 10% $\text{Na}_2\text{S}_2\text{O}_3$ solution. The aqueous layer was extracted three times with DCM. The combined organic layer was washed with brine, dried over Na_2SO_4 , filtered and concentrated *in vacuo* to give crude compound **50**. The crude was dissolved in DCM (5 mL) followed by the addition of TEA (1 mL), the reaction mixture was stirred for 2 h at room temperature. The solvent was removed and the residue was purified by flash column chromatography with 15% acetone in toluene to afford compound **51** (300.1 mg, 0.173 mmol, 92%) as a white foam.

^1H NMR (600 MHz, CDCl_3) δ 8.04 – 7.99 (m, 2H), 7.97 – 7.92 (m, 4H), 7.79 (d, $J = 7.3$ Hz, 2H), 7.51 – 7.43 (m, 4H), 7.39 – 7.03 (m, 39H), 5.73 (t, $J = 11.0$ Hz, 1H), 5.47 – 5.33 (m, 3H), 5.14 (d, $J = 24.6$ Hz, 2H), 4.78 (t, $J = 12.7$ Hz, 1H), 4.74 – 4.65 (m, 2H), 4.63 – 4.51 (m, 4H), 4.48 – 4.35 (m, 5H), 4.30 (d, $J = 11.1$ Hz, 1H), 4.17 (d, $J = 2.5$ Hz, 1H), 4.00 – 3.90 (m, 3H), 3.85 – 3.75 (m, 4H), 3.70 (dd, $J = 14.6, 7.3$ Hz, 1H), 3.63 (s, 1H), 3.47 – 3.38 (m, 3H), 3.28 (s, 1H), 3.13 (m, 2H), 2.92 (m, 1H), 1.47 – 1.22 (m, 4H), 1.18 – 1.03 (m, 2H); ^{13}C NMR (150 MHz, CDCl_3) δ 167.1, 165.8, 165.6, 165.3, 138.1, 138.0, 133.5, 130.1, 130.0, 129.8, 129.4, 129.2, 128.7 (3C), 128.6 (3C), 128.57, 128.4, 128.3, 128.0, 127.9 (4C), 127.8, 127.7, 127.3, 101.4, 100.5, 99.7, 78.2, 76.4, 75.2, 74.3, 73.9, 73.5, 73.3, 71.3, 70.9, 70.3, 67.8, 67.3, 56.2, 50.4, 47.3, 46.3, 29.2, 27.5, 23.5; HRMS (ESI) calcd for $\text{C}_{96}\text{H}_{95}\text{O}_{22}\text{N}_2\text{Cl}_3\text{Na}$ $[\text{M}+\text{Na}]^+$ 1757.5341; found: 1757.5238.

***N*-Benzyl-*N*-benzyloxycarbonyl-5-pentyl 2-*O*-benzoyl-4,6-di-*O*-benzyl-3-*O*-(methyl 5-penanoate)- β -D-galactopyranosyl-(1 \rightarrow 4)-2,3-di-*O*-benzoyl-6-*O*-benzyl- β -D-glucofuranosyl-(1 \rightarrow 6)-4-*O*-(2,3-di-*O*-benzoyl-4,6-di-*O*-benzyl- β -D-galactopyranosyl)-3-*O*-benzyl-2-deoxy-2-trichloroacetamino- β -D-glucopyranoside (28)**

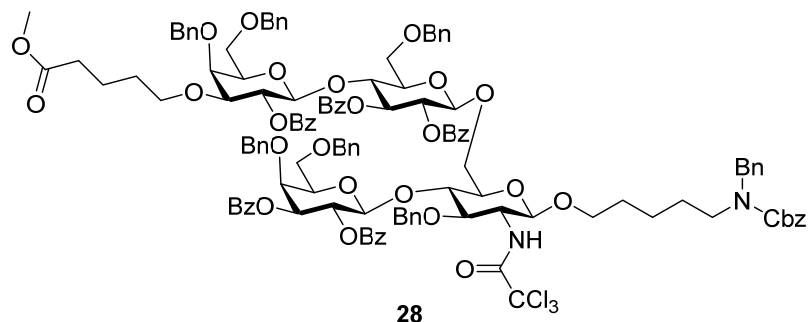

Both trisaccharides **51** (258 mg, 0.149 mmol) and monosaccharide **33** (130 mg, 0.208 mmol) were mixed and co-evaporated three times with anhydrous toluene. Pre-activated molecular sieves AW-300 and anhydrous DCM (6 mL) were added and the reaction mixture was stirred at room temperature for 20 min. Then the mixture was cooled down to -30 °C and NIS (65.2 mg, 0.290 mmol) followed by triflic acid (2.6 μ L, 0.019 mmol) were added. The reaction mixture was stirred at -10 °C for 1.5 h and quenched with triethylamine. The mixture was extracted with aqueous saturated NaHCO₃ solution. The combined organic layer was washed with brine, dried over Na₂SO₄, filtered and concentrated *in vacuo*. The residue was purified by flash column chromatography with 15% acetone in toluene to afford compound **28** (301 mg, 0.131 mmol, 88%) as a white foam.

¹H NMR (400 MHz, CDCl₃) δ 8.06 – 7.94 (m, 6H), 7.91 – 7.86 (m, 2H), 7.82 – 7.77 (m, 2H), 7.60 – 7.15 (m, 61H), 5.74 (dd, *J* = 10.4, 7.9 Hz, 1H), 5.51 (t, *J* = 9.4 Hz, 1H), 5.45 (dd, *J* = 10.1, 8.0 Hz, 1H), 5.39 (dd, *J* = 10.5, 3.0 Hz, 1H), 5.33 (dd, *J* = 9.7, 7.9 Hz, 1H), 5.18 (d, *J* = 11.2 Hz, 2H), 4.87 (d, *J* = 11.7 Hz, 1H), 4.78 (d, *J* = 9.4 Hz, 1H), 4.70 (d, *J* = 11.4 Hz, 1H), 4.63 – 4.53 (m, 3H), 4.53 – 4.45 (m, 4H), 4.40 (m, 3H), 4.33 – 4.26 (m, 2H), 4.23 (d, *J* = 12.1 Hz, 1H), 4.18 (d, *J* = 2.8 Hz, 1H), 4.13 – 4.05 (m, 3H), 3.94 (dd, *J* = 10.4, 5.1 Hz, 1H), 3.86 – 3.80 (m, 2H), 3.78 – 3.72 (m, 2H), 3.72 – 3.61 (m, 2H), 3.60 – 3.44 (m, 9H), 3.41 – 3.35 (m, 1H), 3.35 – 3.26 (m, 3H), 3.23 – 3.09 (m, 3H), 2.98 – 2.82 (m, 3H), 2.09 (t, *J* = 7.0 Hz, 2H), 1.49 – 1.36 (m, 6H), 1.33 – 1.25 (m, 2H), 1.19 – 1.01

(m, 2H); ^{13}C NMR (152 MHz, CDCl_3) δ 173.8, 165.8, 165.5, 165.4, 165.3, 164.9, 139.0, 138.4, 138.0 (2C), 133.9, 133.4, 133.3, 133.2, 132.6, 130.6, 130.1, 130.0, 129.9 (2C), 129.7, 129.6, 129.5, 129.2, 128.9, 128.7, 128.6 (2C), 128.5, 128.3, 128.2 (3C), 128.0, 127.9 (3C), 127.8, 127.7, 127.4, 101.3, 101.1, 100.6, 99.6, 81.5, 75.3, 75.2, 74.5, 74.4, 74.2, 73.5, 73.4, 73.3, 73.2, 73.0, 72.7, 72.5, 72.0, 70.8, 70.2, 68.0, 67.6, 67.2, 67.2, 53.9, 51.5, 33.5, 29.4, 29.3, 21.5; HRMS (ESI) calcd for $\text{C}_{129}\text{H}_{131}\text{O}_{30}\text{N}_2\text{Cl}_3\text{K}$ $[\text{M}+\text{K}]^+$ 2334.7493; found: 2334.7359.

***N*-Benzyl-*N*-benzyloxycarbonyl-5-pentyl 4,6-di-*O*-benzyl-3-*O*-(5-pentanoate acid)- β -D-galactopyranosyl-(1 \rightarrow 4)-6-*O*-benzyl- β -D-glucopyranosyl-(1 \rightarrow 6)-3-*O*-benzyl-4-*O*-(4,6-di-*O*-benzyl- β -D-galactopyranosyl)-2-deoxy-2-trichloroacetamino- β -D-glucopyranoside (**52**)**

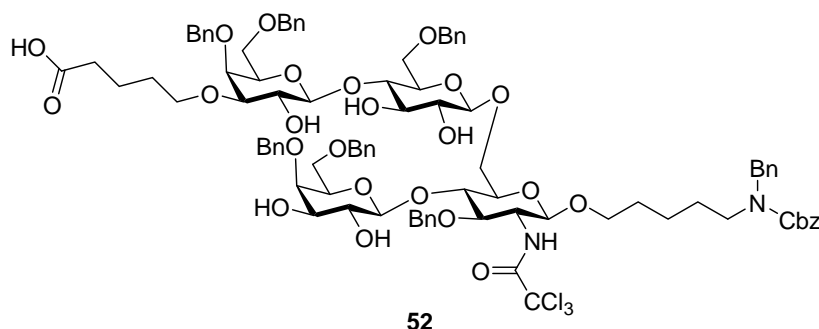

To a solution of tetrasaccharide **28** (27 mg, 0.012 mmol) in THF (2 mL) and MeOH (2 mL), 15% aqueous NaOH solution (100 μL) was added. The reaction mixture was stirred for 1 h until the starting material disappeared. Then excessive MeONa (50 mg) was added. The reaction mixture was stirred for another 5 h, quenched with Amberlite H^+ , filtered and concentrated. The residue was purified by flash column chromatography with 5% MeOH in DCM (0.5% AcOH) to afford compound **52** (19.4 mg, 0.011 mmol, 92%) as a white solid.

^1H NMR (600 MHz, CDCl_3) δ 8.13 – 6.85 (m, 40H), 5.14 (d, J = 23.4 Hz, 2H), 4.95 (d, J = 10.7 Hz, 1H), 4.84 (brs, 1H), 4.78 (d, J = 11.7 Hz, 1H), 4.72 (d, J = 11.7 Hz, 1H), 4.60 – 4.49 (m, 6H), 4.48 – 4.42 (m, 3H), 4.39 – 4.34 (m, 2H), 4.31 (d, J = 11.8 Hz, 1H), 4.24 – 4.17 (m, 3H), 4.09 (brs, 1H), 3.96 (d, J = 8.3 Hz, 1H), 3.90 – 3.69 (m, 8H), 3.64 (s, 1H), 3.62 – 3.37 (m, 16H), 3.29 (s, 2H), 3.23 – 3.10 (m, 4H), 3.06 – 3.00 (m, 1H), 2.35 (s, 3H),

2.04 (s, 1H), 1.61 (brs, 2H), 1.52 – 1.39 (m, 4H), 1.27 – 1.17 (m, 4H); ^{13}C NMR (150 MHz, CDCl_3) δ 161.8, 156.3, 138.8, 138.3, 138.0, 137.9, 137.6, 128.7, 128.6, 128.5 (2C), 128.4, 128.3, 128.2, 128.1, 128.0, 127.9 (3C), 127.8, 127.7, 127.3, 104.2, 103.8, 103.3, 103.2, 103.1, 99.4, 99.3, 82.9, 78.3, 76.1, 75.7, 75.2, 75.0, 74.6, 74.3, 74.1, 73.9, 73.8, 73.7, 73.5, 73.2, 73.1, 72.4, 70.8, 70.4, 70.1, 69.8, 69.1, 68.8, 68.6, 68.3, 68.0, 67.3, 58.2, 54.9, 50.7, 50.4, 49.8, 47.3, 47.0, 46.3, 46.1, 45.3, 43.6, 29.8, 29.4, 28.1, 27.5, 23.5, 23.3, 21.8; HRMS (ESI) calcd for $\text{C}_{93}\text{H}_{109}\text{O}_{25}\text{N}_2\text{Cl}_3\text{Na}$ $[\text{M}+\text{Na}]^+$ 1783.6255; found: 1783.6334.

5-Aminopentyl 3-O-(5-penanoate acid)- β -D-galactopyranosyl-(1 \rightarrow 4)- β -D-glucopyranosyl-(1 \rightarrow 6)-4-O-(β -D-galactopyranosyl)-2-deoxy-2-acetamino- β -D-glucopyranoside (25)

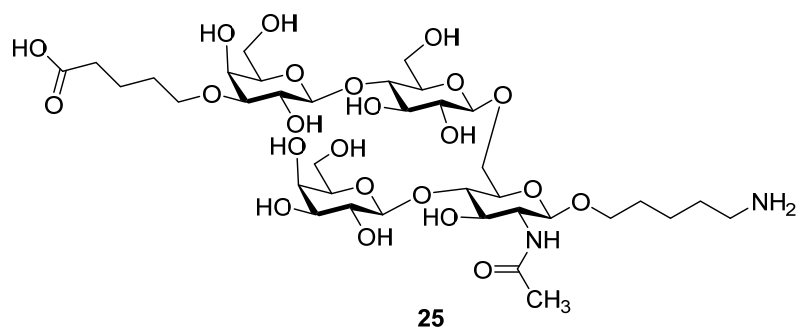

To a solution of compound **52** (5 mg, 2.84 μmol) in $\text{DCM}/t\text{-butanol}/\text{H}_2\text{O}$ (2/4/1, 2.1 mL), an excess amount of Pd-C was added. The reaction was stirred at room temperature under hydrogen for 24 h. After completion, the mixture was filtered to give compound **25** (2.5 mg, 2.84 μmol , quant.) as a white solid.

^1H NMR (600 MHz, D_2O) δ 4.57 (d, $J = 8.0$ Hz, 1H), 4.54 (d, $J = 7.8$ Hz, 2H), 4.47 (d, $J = 7.7$ Hz, 1H), 4.29 (d, $J = 10.3$ Hz, 1H), 4.16 (s, 1H), 4.02 – 3.94 (m, 2H), 3.94 – 3.87 (m, 2H), 3.85 – 3.66 (m, 15H), 3.63 – 3.52 (m, 5H), 3.45 (dd, $J = 10.0, 3.1$ Hz, 1H), 3.40 – 3.34 (m, 1H), 3.02 – 2.96 (m, 2H), 2.23 – 2.20 (m, 2H), 2.04 (s, 3H), 1.71 – 1.58 (m, 8H), 1.44 – 1.36 (m, 2H); ^{13}C NMR (152 MHz, D_2O) δ 177.0, 105.5, 105.0, 103.8, 83.0, 80.9, 80.5, 77.9, 76.9, 76.1, 75.2, 75.1, 72.8, 72.6, 71.9, 71.2, 70.0, 67.6, 63.7, 63.7, 62.6, 57.7, 41.9, 39.8, 31.2, 30.7, 28.9, 24.9, 24.7; HRMS (ESI) calcd for $\text{C}_{36}\text{H}_{65}\text{O}_{23}\text{N}_2$ $[\text{M}+\text{H}]^+$ 893.3979; found: 893.4137.

5-Aminopentyl 2-*O*-benzoyl-3-*O*-(methyl 5-penanoate)- β -D-galactopyranosyl-(1 \rightarrow 4)-2,3-di-*O*-benzoyl- β -D-glucopyranosyl-(1 \rightarrow 6)-4-*O*-(2,3-di-*O*-benzoyl- β -D-galactopyranosyl)-2-deoxy-2-acetamino- β -D-glucopyranoside (53)

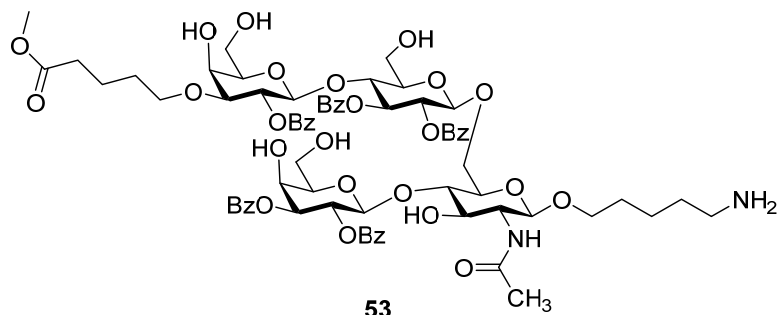

To a solution of compound **28** (26.8 mg, 11.7 μ mol) in DCM/*t*-butanol/ H_2O (2/4/1, 2.1mL), an excess amount of Pd-C was added. The reaction mixture was stirred for 24 h at room temperature under hydrogen. After completion, the mixture was filtered to give compound **53** quantitatively.

1H NMR (600 MHz, CD_3OD) δ 8.16 (d, $J = 7.4$ Hz, 2H), 8.11 (d, $J = 7.3$ Hz, 2H), 7.99 (d, $J = 7.5$ Hz, 2H), 7.93 (t, $J = 7.2$ Hz, 4H), 7.70 (t, $J = 6.8$ Hz, 2H), 7.63 (t, $J = 7.6$ Hz, 2H), 7.61 – 7.47 (m, 6H), 7.44 – 7.35 (m, 5H), 5.51 (dd, $J = 10.2, 8.0$ Hz, 1H), 5.38 – 5.28 (m, 2H), 5.09 (t, $J = 8.0$ Hz, 1H), 4.90 – 4.87 (m, 1H), 4.67 (d, $J = 8.0$ Hz, 1H), 4.29 (d, $J = 8.1$ Hz, 1H), 4.05 (t, $J = 9.4$ Hz, 1H), 4.02 (d, $J = 2.8$ Hz, 1H), 3.97 (d, $J = 2.9$ Hz, 1H), 3.95 (d, $J = 7.9$ Hz, 1H), 3.85 (d, $J = 10.2$ Hz, 1H), 3.78 – 3.74 (m, 1H), 3.69 – 3.54 (m, 8H), 3.52 (s, 3H), 3.46 – 3.40 (m, 3H), 3.38 – 3.32 (m, 3H), 3.30 – 3.24 (m, 2H), 3.19 (dd, $J = 10.7, 5.9$ Hz, 1H), 2.98 – 2.86 (m, 3H), 2.31 (d, $J = 9.3$ Hz, 1H), 2.12 – 2.05 (m, 2H), 1.95 (s, 3H), 1.69 – 1.62 (m, 2H), 1.58 – 1.53 (m, 2H), 1.50 – 1.40 (m, 6H); ^{13}C NMR (150 MHz, CD_3OD) δ 175.6, 173.5, 167.6, 167.1, 166.9, 166.8, 166.5, 135.6, 135.1, 134.6, 134.5, 134.3, 131.2, 131.1, 130.9 (3C), 130.8, 130.7, 130.6, 130.4, 130.3, 129.9, 129.5, 129.4, 102.9, 102.7, 102.5, 102.0, 82.4, 81.3, 76.9, 76.7, 76.6, 75.4, 74.5, 74.1, 74.0, 73.4, 73.1, 71.7, 70.2, 70.0, 68.5, 67.5, 66.3, 61.8, 61.1, 60.2, 56.2, 51.9, 40.7, 34.2, 30.0, 29.6, 27.9, 24.0, 23.0, 22.6; HRMS (ESI) calcd for $C_{72}H_{87}O_{28}N_2$ $[M+H]^+$ 1427.5440; found: 1427.5452.

Protected divalent derivative (54)

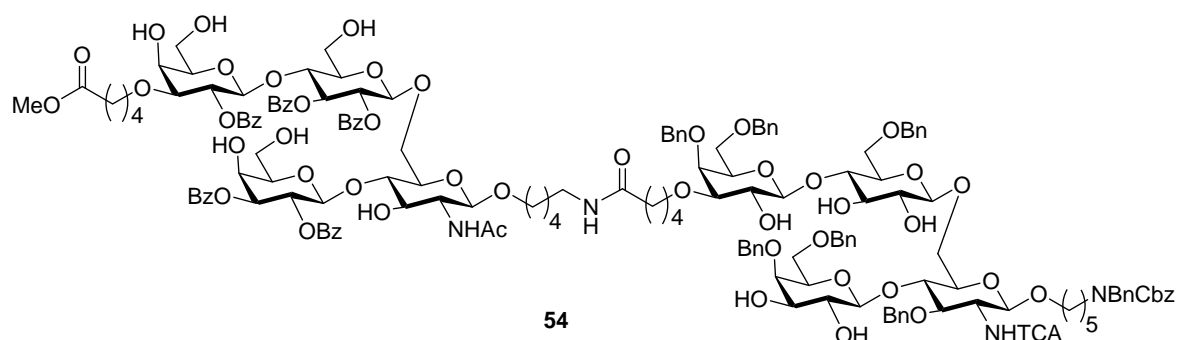

Both compound **53** (16.7 mg, 11.7 μmol) and **52** (17.2 mg, 9.77 μmol) were dissolved in DMF (3 mL) followed by the addition of PyBOP (5.6 mg, 15.1 μmol) and DIPEA (0.2 mL). Then the reaction was stirred for 4 h at room temperature. The solvent was removed under vacuum and the residue was purified by flash column chromatography with 8% MeOH in dichloromethane to give **54** (24.7 mg, 7.8 μmol , 80%) as a white foam.

^1H NMR (700 MHz, CD_3OD) δ 8.23 – 7.87 (m, 11H), 7.74 – 7.47 (m, 12H), 7.45 – 7.21 (m, 41H), 7.10 (t, $J = 7.5$ Hz, 1H), 5.56 – 5.31 (m, 2H), 5.25 – 5.04 (m, 4H), 4.96 (d, $J = 11.4$ Hz, 1H), 4.71 – 4.41 (m, 14H), 4.34 – 4.19 (m, 4H), 4.14 – 3.99 (m, 6H), 3.95 – 3.50 (m, 39H), 3.49 – 3.41 (m, 5H), 3.37 (s, 3H), 3.31 – 3.11 (m, 9H), 2.24 (t, $J = 7.6$ Hz, 2H), 2.14 – 2.06 (m, 2H), 1.98 – 1.91 (m, 3H), 1.80 – 1.63 (m, 5H), 1.47 (m, 15H); HRMS (ESI) calcd for $\text{C}_{165}\text{H}_{193}\text{Cl}_3\text{O}_{52}\text{N}_4\text{Na}_2$ $[\text{M}+2\text{Na}]^{2+}$ 1606.5715; found: 1606.5713.

Partly protected divalent derivative (**55**)

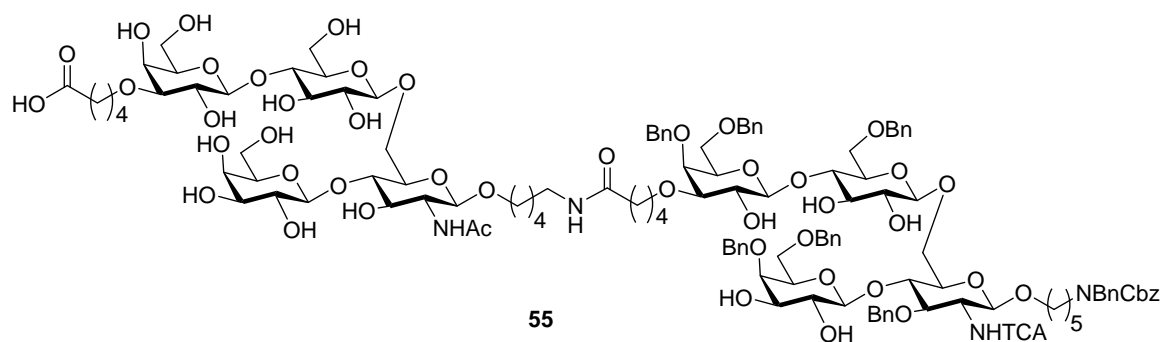

To a solution of **54** (8.7 mg, 2.74 μmol) in THF and MeOH (v/v=1/1, 2 mL), 15% NaOH solution (100 μL) was added. The reaction mixture was stirred for 1 h until starting material disappeared. Then excessive MeONa (30 mg) was added. The reaction was stirred for another 5 h, quenched with Amberlite H⁺, filtered concentrated under vacuum. The residue was purified by size exclusion chromatography with 30% MeOH in chloroform to give compound **55** (7.1 mg, 2.69 μmol , 98%).

¹H NMR (400 MHz, CD₃OD) δ 7.49 – 6.99 (m, 40H), 5.14 (d, $J = 11.8$ Hz, 2H), 5.07 (d, $J = 10.2$ Hz, 1H), 4.99 – 4.92 (m, 1H), 4.82 (d, $J = 11.2$ Hz, 2H), 4.64 – 4.35 (m, 16H), 4.32 – 4.15 (m, 4H), 4.13 – 3.38 (m, 52H), 3.28 – 3.09 (m, 6H), 2.25 (m, 4H), 1.95 (s, 3H), 1.70 (m, 8H), 1.50 (m, 8H), 1.40 – 1.27 (m, 4H); ¹³C NMR (101 MHz, CD₃OD) δ 176.0, 173.4, 140.5, 140.5, 140.3, 140.1, 139.8, 139.8, 139.3, 139.2, 138.1, 138.0, 129.6, 129.5, 129.4, 129.4, 129.3, 129.2, 129.2, 129.2, 129.2, 129.0, 129.0, 128.9, 128.8, 128.7, 128.4, 105.1, 105.0, 104.8, 104.6, 104.5, 104.2, 102.9, 102.7, 102.3, 101.4, 86.0, 83.9, 83.6, 83.0, 82.7, 81.2, 80.8, 80.4, 79.6, 79.5, 78.8, 78.7, 77.7, 77.0, 76.8, 76.4, 76.2, 76.0, 75.7, 75.3, 74.8, 74.7, 74.6, 74.5, 74.4, 74.3, 74.1, 73.9, 73.4, 73.1, 72.7, 72.1, 71.7, 71.5, 70.6, 70.4, 70.1, 69.9, 68.6, 67.5, 66.9, 65.1, 62.6, 62.5, 62.0, 58.3, 56.7, 55.7, 40.3, 36.8, 36.7, 30.6, 30.2, 30.1, 24.4, 24.3, 24.2, 23.9, 23.4, 23.1, 14.6, 12.9; HRMS (ESI) calcd for C₁₂₉H₁₇₂Cl₃O₄₇N₄Na [M+H+Na]²⁺ 1328.5072; found: 1328.5741.

Divalent derivative (26)

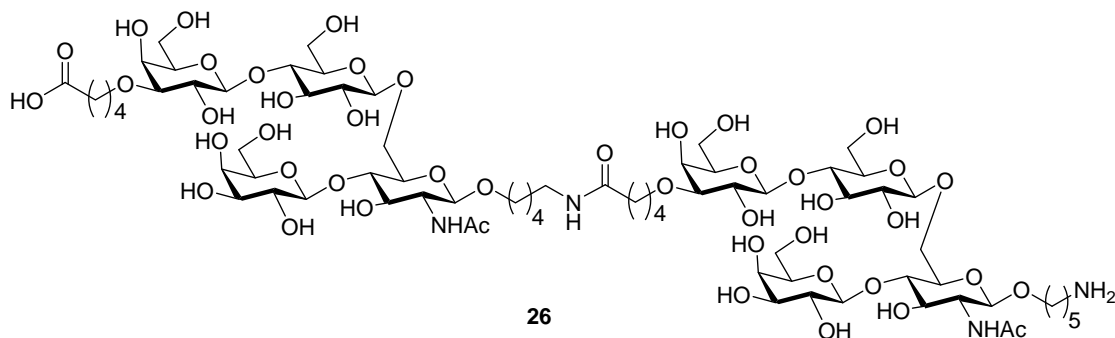

To a solution of compound **55** (7 mg, 2.66 μmol) in DCM/*t*-butanol/H₂O (2/4/1, 2.1 mL), an excess amount of Pd-C was added. The reaction mixture was stirred for 24 h at room temperature under hydrogen. After completion, the mixture was filtered to give compound **26** (4.6 mg, 2.66 μmol) quantitatively as a white solid.

^1H NMR (700 MHz, D_2O) δ 4.53 – 4.45 (m, 6H), 4.40 (d, $J = 7.8$ Hz, 2H), 4.23 (d, $J = 10.8$ Hz, 2H), 4.09 (dd, $J = 7.2, 2.8$ Hz, 2H), 3.96 – 3.80 (m, 9H), 3.78 – 3.60 (m, 30H), 3.56 – 3.46 (m, 10H), 3.41 – 3.37 (m, 2H), 3.32 (t, $J = 8.3$ Hz, 2H), 3.14 – 3.08 (m, 2H), 2.94 – 2.89 (m, 2H), 2.21 (t, $J = 7.2$ Hz, 2H), 2.17 – 2.12 (m, 2H), 1.97 (s, 6H), 1.62 – 1.50 (m, 14H), 1.47 – 1.42 (m, 2H), 1.37 – 1.31 (m, 2H), 1.30 – 1.24 (m, 2H); ^{13}C NMR (175 MHz, D_2O) δ 183.6, 176.6, 174.4, 174.3, 102.9, 102.7, 102.4, 101.2, 101.1, 80.4, 78.3, 77.9, 75.3, 75.3, 74.7, 74.3, 73.5, 72.7, 72.5, 72.3, 70.9, 70.4, 70.2, 70.0, 69.3, 69.1, 68.6, 67.4, 65.0, 61.1, 60.0, 55.1, 39.3, 39.2, 37.2, 35.5, 28.7, 28.2, 28.1, 27.9, 26.4, 22.5, 22.3, 22.1, 22.0; HRMS (ESI) calcd for $\text{C}_{72}\text{H}_{126}\text{O}_{45}\text{N}_4\text{Na}$ $[\text{M}+\text{Na}]^+$ 1789.7592; found: 1789.7497.

Protected trivalent derivative (**56**)

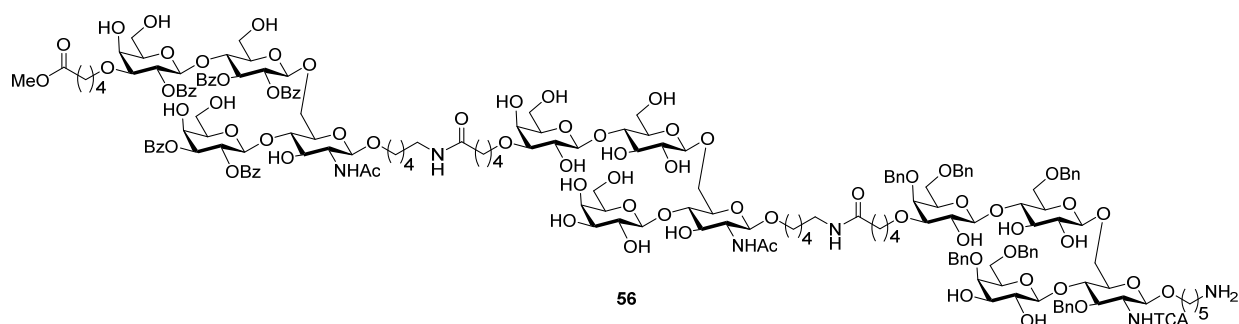

Both compound **53** (2.5 mg, 1.73 μmol) and **55** (3.8 mg, 1.44 μmol) were dissolved in DMF (1 mL) followed by the addition of PyBOP (2.2 mg, 4.3 μmol) and DIPEA (1.5 μL , 8.6 μmol). The reaction mixture was stirred for 2 h at room temperature. The solvent was removed under high vacuum and the residue was purified by size exclusion chromatography with 50% MeOH in chloroform to afford the compound **56** (5.6 mg, 1.4 μmol , 96%).

^1H NMR (700 MHz, CD_3OD) δ 8.24 – 7.89 (m, 9H), 7.75 – 7.08 (m, 56H), 5.54 (t, $J = 9.1$ Hz, 1H), 5.36 (t, $J = 9.5$ Hz, 2H), 5.18 – 5.08 (m, 7H), 4.71 – 4.40 (m, 26H), 4.27 – 4.20 (m, 4H), 4.12 – 3.53 (m, 77H), 3.19 – 3.14 (m, 4H), 2.27 – 2.19 (m, 4H), 2.13 – 2.06 (m, 2H), 1.96 (s, 6H), 1.81 – 1.69 (m, 6H), 1.60 – 1.43 (m, 18H), 1.38 – 1.32 (m, 6H); ^{13}C NMR (176 MHz, CD_3OD) δ 174.8, 174.6, 174.2, 172.0, 139.1, 138.7, 138.4, 138.0,

136.7, 129.9, 129.7, 129.5, 129.4, 129.3, 128.9, 128.6, 128.2, 128.0, 128.0, 127.9, 127.8, 127.8, 127.6, 127.6, 127.5, 127.4, 127.3, 127.0, 103.7, 103.6, 103.5, 103.1, 102.8, 101.5, 101.3, 101.2, 101.1, 100.9, 100.5, 82.5, 81.6, 79.9, 79.5, 79.1, 77.2, 75.6, 75.5, 75.1, 74.8, 74.6, 74.5, 74.3, 74.2, 74.0, 73.5, 73.3, 73.2, 73.1, 73.0, 72.7, 72.0, 71.3, 70.7, 70.3, 70.1, 69.1, 69.0, 68.7, 68.6, 67.2, 65.5, 64.9, 61.1, 60.7, 59.6, 55.3, 50.5, 38.9, 35.5, 35.4, 32.9, 29.2, 28.8, 28.6, 23.0, 22.5, 22.4, 21.7, 21.2; MALDI-TOF MS calcd for $C_{201}H_{255}Cl_3O_{74}N_6Na [M+Na]^+$ 4064.533; found: 4064.444.

Trivalent derivative (27)

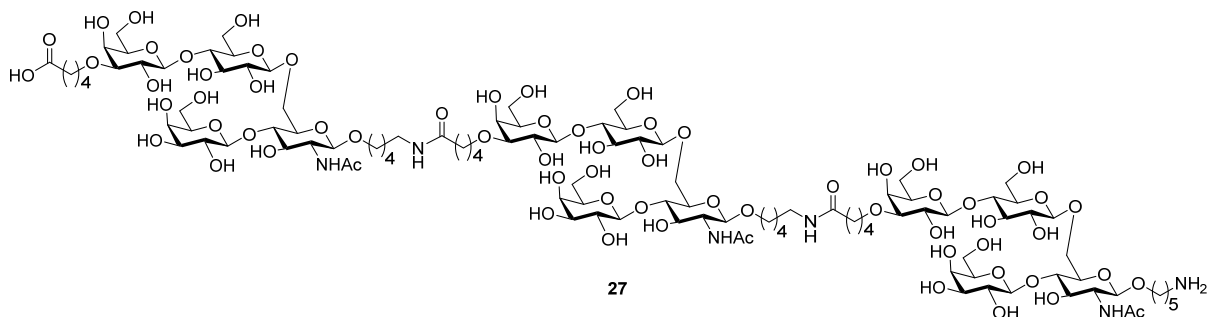

To a solution of tetrasaccharide **56** (3 mg, 0.74 μmol) in THF and MeOH (v/v=1/1, 2 mL), aqueous 15% NaOH solution (30 μL) was added. The reaction mixture was stirred for 1 h until starting material disappeared. Then excessive MeONa (30 mg) was added. The reaction mixture was stirred for another 5 h, quenched with Amberlite H^+ , filtered and concentrated under vacuum. The residue was dissolved in a mixture of *t*-butanol/ H_2O (v/v=1/1, 1 mL) followed by the addition of an excess amount of Pd-C. The reaction was stirred for 24 h at room temperature under hydrogen. The mixture was filtered to give compound **27** (1.3 mg, 0.49 μmol , 66%) as a white solid.

1H NMR (400 MHz, D_2O) δ 4.56 – 4.49 (m, 9H), 4.47 – 4.43 (m, 3H), 4.30 – 4.25 (m, 2H), 4.17 – 4.09 (m, 3H), 3.99 – 3.95 (m, 4H), 3.92 – 3.89 (m, 5H), 3.82 – 3.66 (m, 51H), 3.59 – 3.51 (m, 14H), 3.45 – 3.40 (m, 4H), 3.39 – 3.35 (m, 3H), 3.15 (t, $J = 6.5$ Hz, 4H), 2.25 (t, $J = 7.3$ Hz, 4H), 2.20 – 2.17 (m, 2H), 2.01 (s, 9H), 1.61 – 1.47 (m, 22H), 1.35 – 1.25 (m, 8H); ^{13}C NMR (176 MHz, D_2O) δ 183.7, 176.6, 174.4, 160.9, 102.9, 102.7, 102.4, 101.2, 80.4, 78.3, 77.8, 75.3, 74.7, 74.3, 73.5, 72.7, 72.5, 72.3, 70.9, 70.4, 70.0, 69.3, 69.1, 68.6, 67.4, 65.0, 61.1, 60.1, 55.1, 39.2, 37.2, 35.5, 28.7, 28.2, 27.9, 22.5, 22.3,

22.2, 22.1; HRMS (ESI) calcd for $C_{108}H_{190}O_{67}N_6$ $[M+2H]^{2+}$ 1321.5816; found: 1321.5756.

***N*-Benzyl-*N*-benzyloxycarbonyl-5-pentyl 2-*O*-benzoyl-4,6-di-*O*-benzyl- β -D-galactopyranosyl-(1 \rightarrow 4)-2,3-di-*O*-benzoyl-6-*O*-benzyl- β -D-glucopyranosyl-(1 \rightarrow 6)-4-*O*-(2,3-di-*O*-benzoyl-4,6-di-*O*-benzyl- β -D-galactopyranosyl)-3-*O*-benzyl-2-deoxy-2-trichloroacetamino- β -D-glucopyranoside (**59**)**

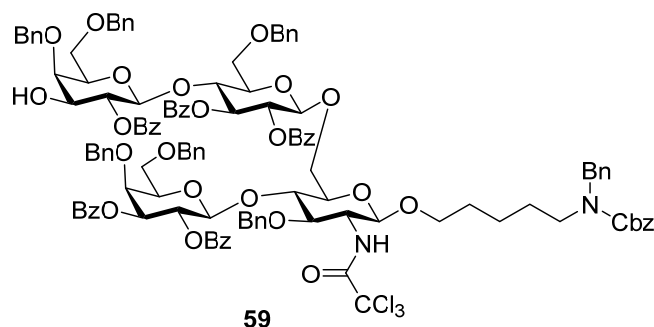

Trisaccharide **51** (17 mg, 9.8 μ mol) and monosaccharide **35** (22 mg, 29 μ mol) were mixed and co-evaporated three times using anhydrous toluene. Pre-activated molecular sieves AW-300 and anhydrous DCM (3 mL) were added and the mixture was stirred at room temperature for 20 min. The mixture was cooled down to -10 $^{\circ}$ C and NIS (10 mg, 44 μ mol) followed by triflic acid (0.4 μ L, 5 μ mol) were added. The reaction was stirred at -10 $^{\circ}$ C for 1 h and quenched with saturated aqueous $NaHCO_3$ solution and 10% $Na_2S_2O_3$ solution. The aqueous layer was washed three times with DCM. The combined organic layer was washed with brine, dried over Na_2SO_4 , filtered and concentrated in *vacuo* to give crude compound **58**. Then the crude was dissolved in DCM (3 mL) followed by the addition of TEA (1 mL), the reaction mixture was stirred for 2 h at room temperature and the solvent was removed. The residue was purified by flash column chromatography with 15% acetone in toluene to yield compound **59** (18.4 mg, 8.4 μ mol, 86%) as a white foam.

1H NMR (600 MHz, $CDCl_3$) δ 7.93 (d, J = 7.6 Hz, 2H), 7.91 – 7.80 (m, 6H), 7.68 (d, J = 7.7 Hz, 2H), 7.53 – 6.80 (m, 55H), 5.64 (d, J = 8.0 Hz, 1H), 5.40 (t, J = 9.3 Hz, 1H), 5.32 – 5.22 (m, 2H), 5.11 – 5.01 (m, 3H), 4.70 (s, 1H), 4.60 (d, J = 11.4 Hz, 1H), 4.54 – 4.30 (m, 11H), 4.25 – 4.17 (m, 3H), 4.10 – 3.99 (m, 4H), 3.85 (dd, J = 10.3, 4.9 Hz, 1H), 3.79 – 3.55 (m, 7H), 3.52 – 3.25 (m, 9H), 3.12 – 3.00 (m, 3H), 2.93 – 2.80 (m, 2H), 2.72 (t, J =

9.2 Hz, 1H), 1.38 – 1.21 (m, 4H), 1.07 – 0.96 (m, 2H); ^{13}C NMR (150 MHz, CDCl_3) δ 166.2, 165.8, 165.5, 165.4, 165.3, 138.3, 138.2, 138.0 (2C), 137.8, 133.8, 133.5, 133.4 (2C), 132.7, 130.5, 130.0 (3C), 129.9, 129.8, 129.7, 129.5, 129.3, 129.2, 128.8, 128.7, 128.6 (4C), 128.5, 128.4, 128.3, 128.2, 128.0 (2C), 127.9 (2C), 127.8, 127.7, 127.6, 127.5, 127.3, 101.3, 100.7, 100.5, 99.6, 78.2, 76.2, 75.2 (2C), 74.6, 74.3 (2C), 73.6, 73.4 (2C), 73.2 (2C), 73.0, 72.8, 72.0, 70.9, 69.4, 68.7, 67.9, 67.7, 67.3, 67.0, 56.4, 50.4, 47.3, 46.3, 29.8, 27.5, 23.4; HRMS (ESI) calcd for $\text{C}_{123}\text{H}_{121}\text{Cl}_3\text{O}_{28}\text{N}_2\text{Na}$ $[\text{M}+\text{Na}]^+$ 2203.7041; found: 2203.6987.

5-Aminopentyl β -D-galactopyranosyl-(1 \rightarrow 4)- β -D-glucopyranosyl-(1 \rightarrow 6)-4-O-(β -D-galactopyranosyl)-2-deoxy-2-acetamino- β -D-glucopyranoside (34)

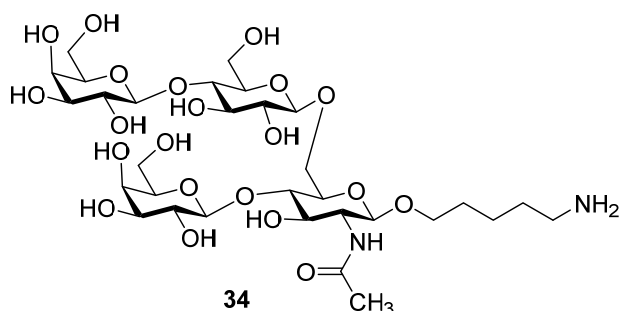

To a solution of tetrasaccharide **59** (13 mg, 5.96 μmol) in THF and MeOH (3 mL, v/v=1/1), excessive NaOMe (30 mg) was added. The reaction was stirred for 5 h, quenched with Amberlite H^+ , filtered and concentrated under vacuum. The residue was purified by flash column chromatography with 5% MeOH in DCM to give compound **60** (9.7 mg, 5.84 μmol , 98%) as white solid. To a solution of compound **60** (9.7 mg, 5.84 μmol) in DCM/*t*-butanol/ H_2O (2/4/1, 2.1 mL), an excess amount of Pd-C was added. Then the reaction was stirred for 24 h at room temperature under hydrogen. After completion, the mixture was filtered to give compound **34** (4.0 mg, 5.1 μmol , 87%) as a white solid.

^1H NMR (400 MHz, D_2O) δ 4.54 (d, J = 8.1 Hz, 1H), 4.51 (d, J = 7.8 Hz, 2H), 4.43 (d, J = 7.7 Hz, 1H), 4.27 (d, J = 10.0 Hz, 1H), 3.98 – 3.50 (m, 24H), 3.40 – 3.32 (m, 1H), 2.97 (t, J = 7.5 Hz, 2H), 2.01 (s, 3H), 1.70 – 1.55 (m, 4H), 1.43 – 1.33 (m, 2H); ^{13}C NMR (100 MHz, D_2O) δ 174.4, 102.9, 102.7, 102.3, 101.2, 78.3, 77.7, 75.3, 75.2, 74.6, 74.2, 73.4,

72.6, 72.4, 72.2, 70.9, 70.2, 68.5, 67.3, 61.0, 60.0, 55.0, 39.3, 28.0, 26.3, 22.1, 22.0; HRMS (ESI) calcd for C₃₁H₅₇O₂₁N₂ [M+H]⁺ 793.3454; found: 793.3425.

Phenyl 2-azido-2-deoxy-4,6-*O*-benzylidene-3-*O*-(methyl 5-pentanoate)-1-seleno- α -D-galactopyranoside (62)

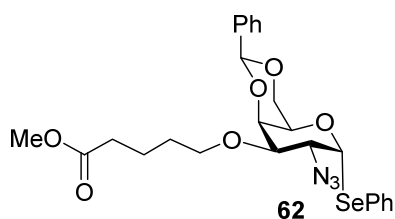

Sodium hydride (20 mg, 0.50 mmol, 60% wt) was added to a solution of phenyl 2-azido-2-deoxy-4,6-*O*-benzylidene-1-seleno- α -D-galactopyranoside **61** (144 mg, 0.33 mmol) in DMF (4 mL) at 0 °C, followed by the addition of methyl methyl 5-bromopentanoate (72 μ L, 0.50 mmol). The reaction was stirred for 2 h at room temperature, quenched with saturated aqueous NH₄Cl and extracted three times with ethyl acetate. The combined organic layer was washed with brine, dried over Na₂SO₄, filtered and concentrated. The residue was purified by flash column chromatography with 20% ethyl acetate in hexanes to afford compound **62** (110 mg, 0.20 mmol, 61%) as a colorless oil.

¹H NMR (400 MHz, CDCl₃) δ 7.62 – 7.53 (m, 2H), 7.54 – 7.47 (m, 2H), 7.41 – 7.32 (m, 3H), 7.28 – 7.26 (m, 3H), 6.03 (d, *J* = 5.2 Hz, 1H), 5.60 (s, 1H), 4.41 (dd, *J* = 3.4, 1.1 Hz, 1H), 4.33 (dd, *J* = 10.3, 5.2 Hz, 1H), 4.16 (dd, *J* = 12.8, 1.9 Hz, 1H), 4.13 – 4.05 (m, 2H), 3.75 (dt, *J* = 8.9, 6.1 Hz, 1H), 3.65 (s, 4H), 3.57 (dt, *J* = 8.8, 5.9 Hz, 1H), 2.36 (t, *J* = 7.2 Hz, 2H), 1.83 – 1.66 (m, 4H); ¹³C NMR (101 MHz, CDCl₃) δ 174.1, 137.6, 133.9, 129.3, 129.2, 128.8, 128.3, 127.8, 126.3, 101.1, 85.7, 78.2, 72.3, 69.4, 68.6, 65.3, 59.8, 51.7, 33.7, 29.2, 21.7; HRMS (ESI) calcd for C₂₅H₂₉O₆N₃SeNa [M+Na]⁺ 570.1113; found: 570.1127.

***N*-Phenyltrifluoroacetimidate 2-azido-2-deoxy-4,6-*O*-benzylidene-3-*O*-(methyl 5-pentanoate)- α -D-galactopyranoside (63)**

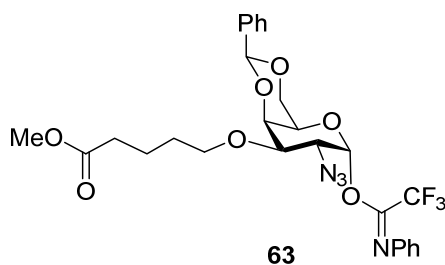

To a solution of monosaccharide **62** (98 mg, 0.18 mmol) in THF/H₂O (3.6 mL, v/v=5/1) was added NIS (121 mg, 0.54 mmol) at 0 °C. The reaction was stirred for 2 h at room temperature, then diluted with DCM and washed with 10% aq. Na₂S₂O₃ solution. The organic layer was dried over Na₂SO₄, filtered and concentrated to get crude hemi-acetal. The crude was dissolved in DCM (4 mL) followed by the addition of (*E*)-2,2,2-trifluoro-*N*-phenylacetimidoyl chloride (85 μL, 0.538 mmol) and Cs₂CO₃ (175 mg, 0.538 mmol) at 0 °C. After 2 h, the reaction mixture was filtered and concentrated. The residue was purified by flash column chromatography with 22% ethyl acetate in hexanes (1% triethylamine) to give imidate **63** (98.6 mg, 0.17 mmol, 94%) as a colorless oil.

¹H NMR (400 MHz, CDCl₃) δ 7.67 – 7.47 (m, 2H), 7.42 – 7.35 (m, 3H), 7.34 – 7.27 (m, 2H), 7.19 – 7.05 (m, 1H), 6.85 (d, *J* = 7.8 Hz, 2H), 5.58 (s, 1H), 4.40 – 4.24 (m, 2H), 4.06 (d, *J* = 13.0 Hz, 2H), 3.73 (dd, *J* = 7.1, 5.9 Hz, 1H), 3.64 (s, 3H), 3.56 (dd, *J* = 6.7, 5.7 Hz, 1H), 3.38 (s, 1H), 2.36 (t, *J* = 7.1 Hz, 2H), 1.82 – 1.64 (m, 4H); ¹³C NMR (101 MHz, CDCl₃) δ 174.1, 143.5, 137.5, 129.3, 128.9, 128.4, 126.4, 124.5, 119.5, 101.2, 79.3, 71.7, 69.3, 69.0, 67.5, 61.0, 51.7, 33.7, 29.1, 21.7; HRMS (ESI) calcd for C₂₇H₂₉F₃O₇N₄Na [M+Na]⁺ 601.1880; found: 601.1876.

***N*-Benzyl-*N*-benzyloxycarbonyl-5-pentyl 2-acetamino-2-deoxy-4,6-*O*-benzylidene-3-*O*-(methyl 5-pentanoate)-β-*D*-galactopyranoside (**65**)**

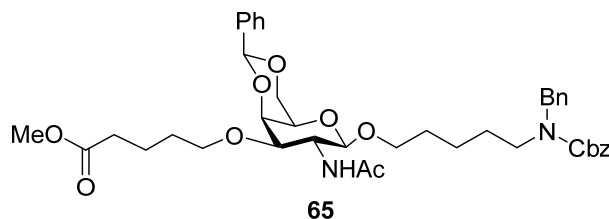

The imidate **63** (82.4 mg, 0.14 mmol) and *N*-(benzyl)-benzyloxycarbonyl-5-aminopentanol **5** (93 mg, 0.28 mmol) were co-evaporated twice with toluene and dried under vacuum. The residue was dissolved in acetonitrile (4 mL) and cooled to -20 °C. Trimethylsilyl trifluoromethanesulfonate (3 μ L, 14.2 μ mol) was added and the reaction was stirred for 1 h. The reaction was quenched with triethylamine and concentrated under vacuum to give crude **64**. The residue was dissolved in pyridine (4 mL), and thioacetic acid (1 mL) was added. The reaction was stirred for 72 h at room temperature. The reaction was concentrated under vacuum and purified by flash column chromatography with 50-80% ethyl acetate in hexanes to afford compound **65** (45 mg, 0.061 mmol, 44% over two steps) as a colorless oil.

^1H NMR (600 MHz, CDCl_3) δ 7.49 (d, $J = 6.9$ Hz, 2H), 7.41 – 7.20 (m, 12H), 7.15 (d, $J = 7.4$ Hz, 1H), 5.54 (s, 1H), 5.15 (d, $J = 21.5$ Hz, 2H), 5.09 (d, $J = 8.3$ Hz, 1H), 4.48 (d, $J = 13.1$ Hz, 2H), 4.30 (d, $J = 12.3$ Hz, 2H), 4.25 (d, $J = 3.4$ Hz, 1H), 4.06 (dd, $J = 12.4, 1.8$ Hz, 1H), 3.85 (d, $J = 31.5$ Hz, 1H), 3.66 (dt, $J = 9.1, 5.8$ Hz, 1H), 3.61 (s, 3H), 3.46 – 3.16 (m, 6H), 2.30 (t, $J = 7.5$ Hz, 2H), 1.89 (s, 3H), 1.69 – 1.63 (m, 2H), 1.61 – 1.48 (m, 6H), 1.34 – 1.25 (m, 2H); HRMS (ESI) calcd for $\text{C}_{41}\text{H}_{52}\text{O}_{10}\text{N}_2\text{Na}$ $[\text{M}+\text{Na}]^+$ 755.3514; found: 755.3552.

5-Aminopentyl 2-acetamino-2-deoxy-3-O-(methyl 5-pentanoate)- β -D-galactopyranoside (67)

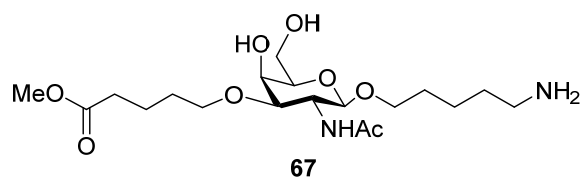

The compound **65** (10.3 mg, 0.014 mmol) was dissolved in a mixture of THF/*t*-butanol/ H_2O (4/2/1, 2.1mL) followed by the addition of excess amount of Pd-C. The reaction was stirred for 20 h at room temperature under hydrogen. Then the reaction mixture was filtered to give compound **67** (4 mg, 9.5 μ mol, 67%) as a colorless oil.

^1H NMR (400 MHz, D_2O) δ 4.31 (d, $J = 8.6$ Hz, 1H), 3.99 (d, $J = 3.1$ Hz, 1H), 3.81 – 3.58 (m, 5H), 3.55 (s, 3H), 3.51 – 3.44 (m, 3H), 3.38 – 3.23 (m, 2H), 2.84 (t, $J = 7.7$ Hz,

2H), 2.27 (t, $J = 7.3$ Hz, 2H), 1.87 (s, 3H), 1.55 – 1.44 (m, 8H), 1.32 – 1.21 (m, 2H); ^{13}C NMR (151 MHz, D_2O) δ 177.2, 174.2, 101.5, 78.7, 75.0, 69.9, 68.9, 64.4, 61.5, 61.0, 52.0, 51.2, 39.3, 33.2, 28.0, 28.0, 27.8, 26.3, 22.1, 20.9; HRMS (ESI) calcd for $\text{C}_{19}\text{H}_{37}\text{O}_8\text{N}_2$ $[\text{M}+\text{H}]^+$ 421.2544; found: 421.2529.

***N*-Benzyl-*N*-benzyloxycarbonyl-5-pentyl 2-acetamino-2-deoxy-4,6-*O*-benzylidene-3-*O*-(5-pentanoate acid)- β -D-galactopyranoside (**66**)**

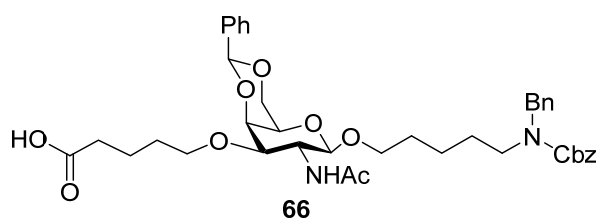

To a solution of **65** (7.9 mg, 0.011 mmol) in THF and MeOH (2 mL, v/v=1/1), aqueous 15% NaOH solution (100 μL) was added. The reaction mixture was stirred for 4 h, quenched by Amberlite H^+ , filtered and concentrated under vacuum. The residue **66** was used directly in the next step.

Protected divalent of *N*-acetyl-galactosamine (68**)**

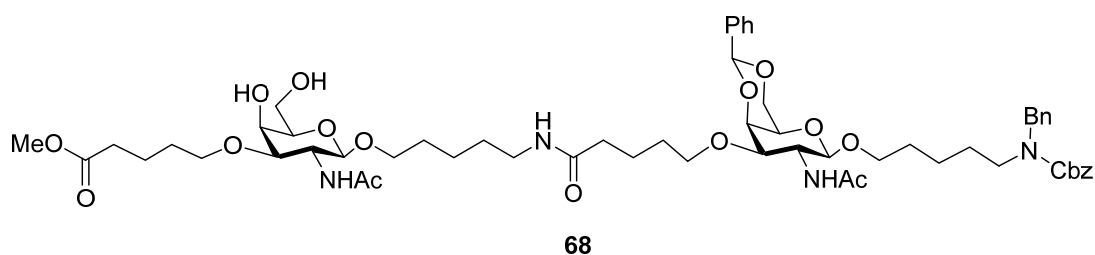

To a solution of crude **66** (11 μmol) and compound **67** (4 mg, 9.5 μmol) in DMF (2 mL), PyBOP (8 mg, 15.5 μmol) was added followed by the addition of DIPEA. The reaction was stirred for 2 h at room temperature. The solvent was removed *in vacuo*. The residue was purified by flash column chromatography using 7-9% methanol in dichloromethane to afford compound **68** (6.7 mg, 6 μmol , 63%) as a colorless oil.

^1H NMR (400 MHz, CD_3OD) δ 7.56 – 7.46 (m, 5H), 7.37 – 7.20 (m, 10H), 5.63 (s, 1H), 5.16 (d, $J = 13.6$ Hz, 2H), 4.51 (s, 3H), 4.45 – 4.34 (m, 2H), 4.18 (q, $J = 12.3$ Hz, 2H), 4.06 – 3.99 (m, 2H), 3.94 (t, $J = 9.6$ Hz, 1H), 3.86 (dt, $J = 9.4, 6.1$ Hz, 2H), 3.77 – 3.70 (m, 4H), 3.64 (s, 3H), 3.61 (dd, $J = 11.2, 3.2$ Hz, 1H), 3.51 – 3.42 (m, 5H), 3.38 (dd, $J = 11.5, 4.0$ Hz, 2H), 3.24 (d, $J = 8.6$ Hz, 2H), 3.08 (t, $J = 6.6$ Hz, 2H), 2.34 (t, $J = 7.4$ Hz, 2H), 2.17 (t, $J = 7.4$ Hz, 2H), 1.95 (s, 6H), 1.71 – 1.46 (m, 16H), 1.39 – 1.32 (m, 4H); ^{13}C NMR (176 MHz, CD_3OD) δ 176.0, 175.8, 173.5, 139.7, 129.9, 129.6, 129.1, 129.0, 128.7, 128.4, 128.1, 127.6, 126.9, 118.8, 111.6, 103.1, 102.7, 102.3, 80.9, 79.5, 78.8, 76.6, 73.5, 70.4, 70.2, 70.2, 70.1, 69.9, 68.1, 66.1, 62.6, 53.0, 52.8, 52.0, 40.3, 36.7, 34.5, 30.3, 30.2, 30.2, 30.0, 24.5, 24.2, 24.1, 23.2, 23.1, 22.8; HRMS (ESI) calcd for $\text{C}_{59}\text{H}_{84}\text{O}_{17}\text{N}_4\text{Na}$ $[\text{M}+\text{Na}]^+$ 1143.5724; found: 1143.5760.

Divalent of *N*-acetyl-galactosamine (69)

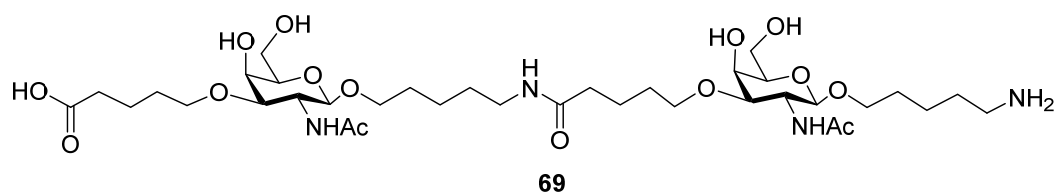

To a solution of compound **68** (6.5 mg, 5.8 μmol) in THF and MeOH (2 mL, v/v=1/1), an aqueous 15% NaOH solution (100 μL) was added. The reaction mixture was stirred overnight, quenched with Amberlite H^+ , filtered and concentrated *in vacuo*. The residue was then dissolved in a mixture of THF/*t*-butanol/ H_2O (1/2/1, 2.1 mL) followed by the addition of excess amount of Pd-C. The reaction mixture was stirred for 20 h at room temperature under hydrogen. The reaction mixture was filtered to give compound **69** (4.2 mg, 5.3 μmol , 91%) as a colorless oil.

^1H NMR (600 MHz, D_2O) δ 4.32 (d, $J = 8.6$ Hz, 2H), 3.99 (d, $J = 3.1$ Hz, 2H), 3.80 – 3.72 (m, 3H), 3.69 – 3.60 (m, 4H), 3.52 – 3.43 (m, 4H), 3.37 – 3.29 (m, 3H), 3.05 – 3.01 (m, 2H), 2.85 (t, $J = 7.7$ Hz, 2H), 2.57 (t, $J = 6.4$ Hz, 2H), 2.44 (t, $J = 6.0$ Hz, 2H), 2.24 (t, $J = 7.3$ Hz, 2H), 2.11 (t, $J = 7.4$ Hz, 2H), 1.88 (s, 3H), 1.87 (s, 3H), 1.75 – 1.66 (m, 4H), 1.59 – 1.34 (m, 12H), 1.30 – 1.24 (m, 2H), 1.20 (tt, $J = 7.7, 4.6$ Hz, 2H); ^{13}C NMR (151 MHz, D_2O) δ 179.2, 176.4, 174.1, 101.5, 101.5, 81.7, 78.7, 75.0, 75.0, 70.1, 69.9, 69.0,

68.9, 64.5, 64.4, 61.5, 61.0, 51.2, 39.3, 39.2, 35.4, 33.8, 28.2, 28.1, 28.0, 28.0, 27.9, 27.8, 26.3, 22.4, 22.2, 22.1, 22.1, 22.0, 21.1, 20.7, 20.7, 20.0, 19.6, 18.2; HRMS (ESI) calcd for $C_{36}H_{67}O_{15}N_4$ $[M+H]^+$ 795.4597; found: 795.4612.

2.4.2 Biochemistry experiments

Glycan array printing

Briefly, synthetic oligosaccharides and commercial pneumococcal polysaccharides were dissolved in 50 mM sodium phosphate buffer (PH 8.5) and spotted to *N*-hydroxysuccinimide activated hydrogel coated glass slides (CodeLink slides; Surmodics) using an S3 robotic non-contact microarray printer. Repetitive printing patterns were used as outlined in section 2.2.4. Slides were incubated in a humidified chamber overnight and quenched with 100 mM ethanolamine and 50 mM sodium phosphate (PH 9.0) for 1 h at room temperature. Slides were washed with water, dried by centrifugation and stored at 4 °C until use.

General procedure for glycan array analysis

Slides were blocked by incubation with 1% bovine serum albumin (BSA) in phosphate buffered saline (PBS) (1% BSA-PBS) for at least 30 min at room temperature. Slides were washed twice with PBS and dried by centrifugation. A 64-well incubation grid (Grace Biolabs) was applied to the slide. Dilutions of anti-ST14 mouse or human sera in 1% BSA-PBS were applied to the wells and incubated for 1 h at 37 °C in a humid and dark chamber. Wells were washed three times with PBS containing 0.1% Tween-20 (PBS-T). Secondary antibody dilutions in 1% BSA-PBS were applied to the wells and incubated for 1 h at 37 °C in a humid and dark chamber. The following secondary antibodies were used: goat anti-mouse IgG H+L AlexaFluor 635 (Thermo Fisher Scientific Invitrogen) and goat anti-human IgG H+L AlexaFluor 635 (Thermo Fisher Scientific Invitrogen). Wells were washed twice with PBS-T and once with PBS. The incubation grid was removed and the slides were rinsed with water and dried by centrifugation. Slides were scanned using a GenePix 4300A microarray scanner (Molecular Devices, Sunnyvale, CA, USA) and evaluated using GenePix Pro 7.2 (both

Molecular Devices). The photomultiplier tube (PMT) voltage was adjusted such that scans were free of saturation signals and the wavelength was chosen based on the secondary antibody used.

Preparation of glycoconjugates

Bis(*p*-nitrophenyl adipate) (4 mg, 10 μ mol) was added to a solution of oligosaccharide (1 μ mol) in a mixture of dimethylsulfoxide/pyridine (8/1, 180 μ L), followed by the addition of triethylamine (5 μ L). The reaction was stirred for 6 h at room temperature. Then the solvent was removed by lyophilization overnight. The residue was triturated with chloroform (3 \times 1 mL) and dichloromethane (3 \times 1 mL), transferred to a 1.8 mL type I class A glass vial using dimethylsulfoxide (150 μ L) and lyophilized.

CRM197 (1 mg) was washed with autoclaved water (3 \times 500 μ L) and phosphate buffer 0.1 M pH 8.0 (3 \times 500 μ L) by dialysis using a centrifugal filter (10 KDa MWCO, Merck Milipore), concentrated 100 μ L and transferred to the vial with activated oligosaccharide.

The reaction mixture was stirred for 18 h at room temperature, transferred to a centrifugal filter and washed with phosphate buffer 0.1 M pH 8.0 (3 \times 400 μ L) and autoclaved water (3 \times 400 μ L). A 10 μ L sample was taken for analysis before washing the mixture with phosphate buffered saline (2 \times 400 μ L).

The average molecular size of the conjugates was characterized by Matrix-assisted laser desorption/ionization (MALDI) analysis using 2,4-dihydroxyacetophenone (DHAP) as matrix. The conjugates were prepared in 6 \times SDS-PAGE sample loading dye and was resolved on 10% SDS-PAGE. The electrophoresis was carried out at 120 V and 25 mA for 90 min in electrode buffer and then the gel was soaked in PageBlue protein staining solution.

Immunization of mice

Four groups of five female 6-8 week-old C57BL/6 mice were immunized subcutaneously with each glycoconjugates (1 μ g of oligosaccharide antigen per dose) mixed with aluminum hydroxide as adjuvant (Brenntag, Mülheim, Germany). The control group was composed of three female 6-8 week-old C57BL/6 mice and received only PBS with aluminum hydroxide. On day 14 and 28, mice received a booster immunization with the

same formulation. Mice were bled via tail weekly, using glass micro hematocrit capillary of 100 μL . The antibody titers in sera were measured using ELISA and glycan microarrays.

ELISA analysis

High binding 96-well polystyrene microtiter plates (Corning, USA) were coated overnight at 4 °C with 10 $\mu\text{g}/\text{mL}$ of Pn14PS in PBS, PH 7.2 (50 μL per well). The plates were washed three times with PBS-T and blocked with 1% FCS in PBS for 1 h at room temperature. After three-time washings with PBS-T, the plate was incubated with each individual mouse serum at different dilutions in duplicate or triplicate for 1 h at room temperature. The plates were washed four to five times with PBS-T and incubated with horseradish peroxidase (HRP) conjugated goat anti-mouse IgG antibodies (Sigma-Aldrich, USA), then washed thoroughly with PBS-T. The absorbance was recorded at 450 nm using an ELISA reader (Infinite® 200 NanoQuant, Tecan, Switzerland).

Chapter 3

Synthesis of D-ribitol-5-phosphate trimer and X-ray crystallographic analysis of its interaction with the TarP glycosyltransferase

3.1 Introduction

3.1.1 Teichoic acids of Gram-positive bacteria

The cell wall of Gram-positive bacteria which surrounds the cytoplasmic membrane is a complex of different biopolymers, consisting of peptidoglycans, polysaccharides, teichoic acids (TAs) and (glyco)proteins.¹⁵⁴ TAs,¹⁵⁵⁻¹⁵⁷ including wall teichoic acids (WTAs) and lipoteichoic acids (LTAs), are phosphate-rich glycopolymers. WTAs are usually linked to peptidoglycans,¹⁵⁸ while LTAs anchor into cytoplasmic membrane through glycolipids¹⁵⁹ (Figure 3.1). WTAs are highly abundant in cell walls of Gram-positive pathogens. In certain bacteria such as *Bacillus subtilis*, the total mass of WTAs constitutes up to 60% of the cell wall.¹⁶⁰ Due to their polyanionic nature and their abundance, teichoic acids play various roles in bacterial physiology.¹⁶¹⁻¹⁶⁵ They are involved in regulation of ion homeostasis inside the cell wall, in modulating autolytic activity and in controlling cell division and morphogenesis. TAs are also crucial for bacteria host interactions since their D-alanylation protects bacteria against cationic antimicrobial peptides. Moreover, TAs influence bacterial adhesion to abiotic surfaces and to host cells.

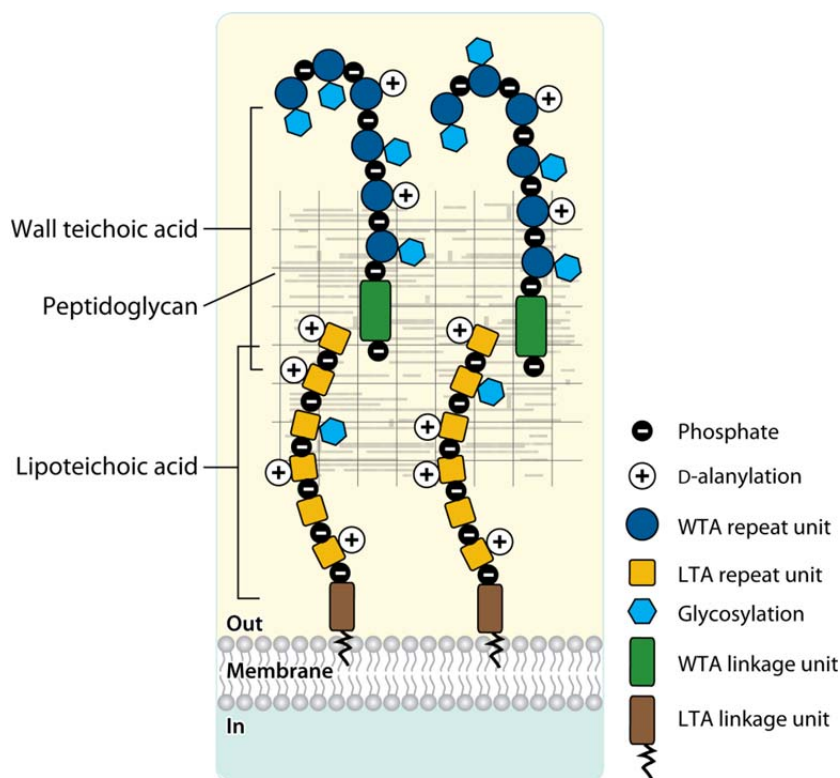

Figure 3.1: Schematic representation of teichoic acid polymers on Gram-positive bacteria cell wall.¹⁵⁶
(Reprinted from Ref 156)

3.1.2 Structure of wall teichoic acids

The structure of WTA polymer can be divided into two components (Figure 3.1): a disaccharide linkage unit and a main chain polymer composed of phosphodiester-linked polyol repeating units. The disaccharide linkage unit, which is highly conserved across bacterial species, consists of *N*-acetylmannosamine ($\beta 1 \rightarrow 4$) *N*-acetylglucosamine 1-phosphate with one or two glycerol 3-phosphate (GroP) units attached to the C-4 position of ManNAc (Figure 3.2-A).^{158, 166, 167} The anomeric phosphate of the linkage unit is covalently attached to peptidoglycan via a phosphodiester bond to the C-6 position of *N*-acetylmuramic acid (MurNAc), while the phosphodiester-linked polyol repeating units extend from the GroP end of the linkage unit.

The most common repeating units for WTA main chains are glycerol-phosphate or ribitol-phosphate (RboP),^{166, 168, 169} but the unit structures can be highly diverse^{170, 171} (Figure 3.2-B). Additional WTA structural diversity arises from the presence of

substituents attached to the repeating units. The hydroxyls of the GroP and RboP repeating units can be tailored with cationic D-alanine esters¹⁷² and monosaccharides, commonly glucose or *N*-acetylglucosamine.¹⁷³⁻¹⁷⁵ Nearly all of the RboP repeating units in *S. aureus* contain *O*-GlcNAc modifications.¹⁷⁶ Depending on the bacterial strain, the anomeric configuration of the glycosidic linkage can be exclusively α , exclusively β or a mixture of the two.¹⁷⁷

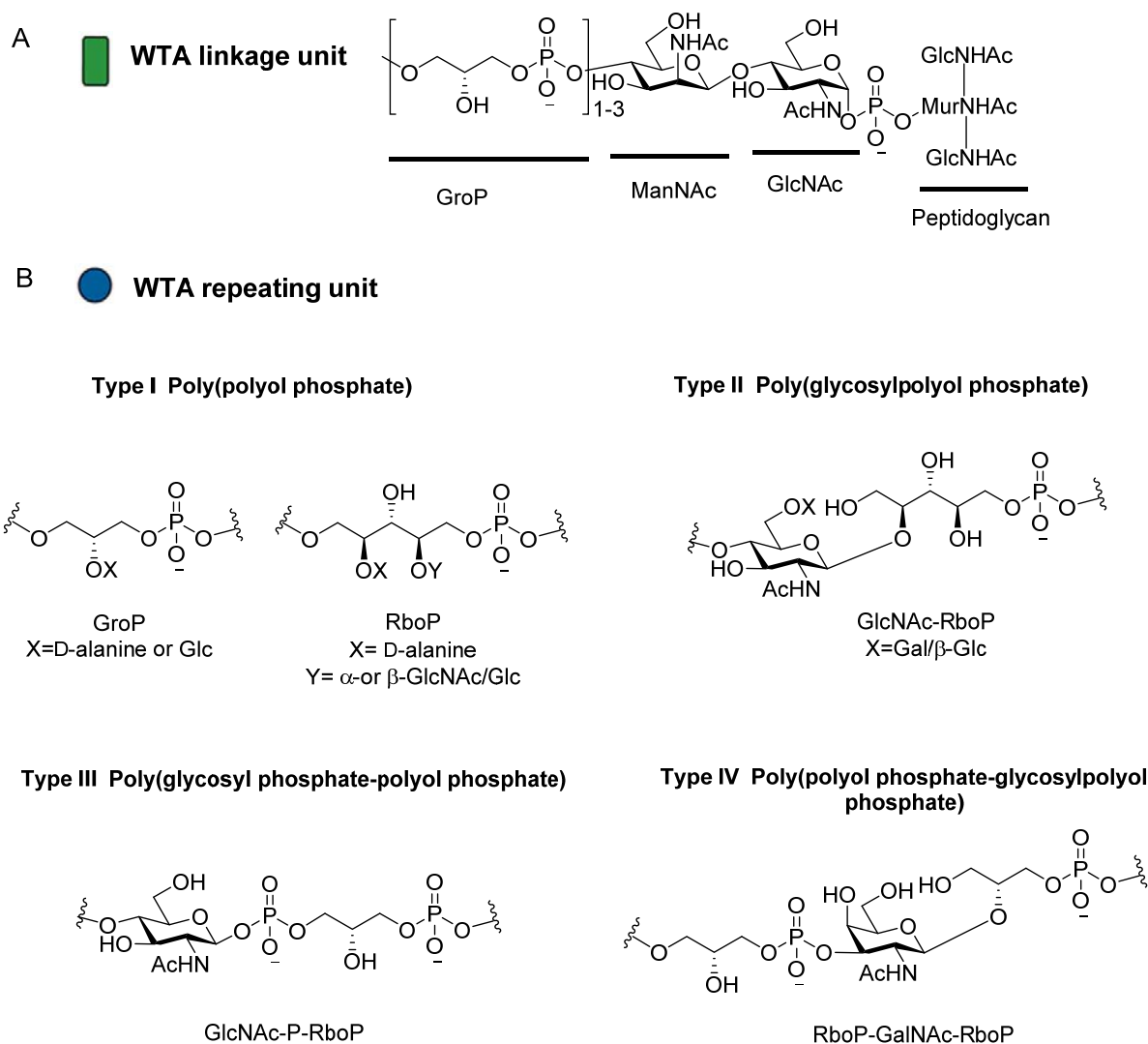

Figure 3.2: WTAs share a common linkage unit but exhibit structural diversity in their repeating units.¹⁷⁸ (A) WTA linkage unit. (B) Four different classes of WTA repeating units.

During WTA biosynthesis, the monosaccharides are connected via WTA glycosyltransferases (GTs) inside the cell after polymer synthesis is complete prior to WTA export to the cell surface.¹⁷⁹ In the past few years, several WTA GTs have been

identified. TagE modifies WTAs in *B. subtilis* with α -glucose using UDP-glucose as a donor substrate. In *S. aureus*, glycosyltransferases TarM¹⁸⁰⁻¹⁸² and TarS¹⁸³ have been reported to attach α -O-GlcNAc and β -O-GlcNAc residues to RboP of WTAs (Figure 3.3).

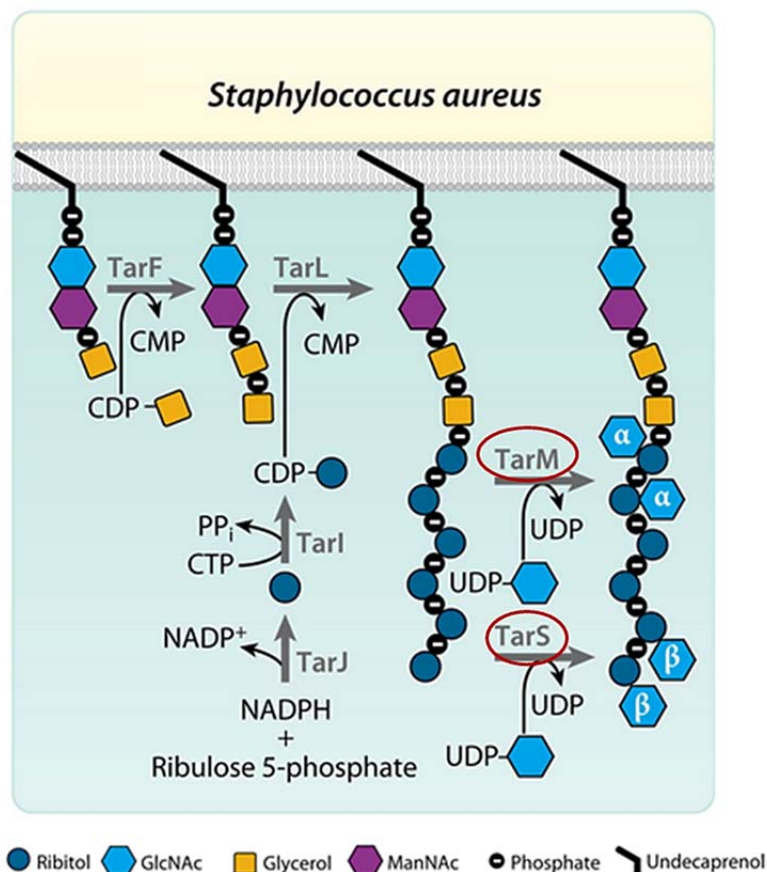

Figure 3.3: WTAs biosynthesis in *S. aureus*. Glycosyltransferases TarS and TarM are responsible for β -O-GlcNAcylation and α -O-GlcNAcylation.¹⁵⁶ (Reprinted from Ref 156)

Glycosyltransferase TarP has been recently discovered to modify poly(RboP)-WTA with GlcNAc in *S. aureus*. To understand the mechanism of this process, a fragment of main chain of WTA (Figure 3.4), trimer of RboP **70**, will be synthesized to study its interaction with TarP.

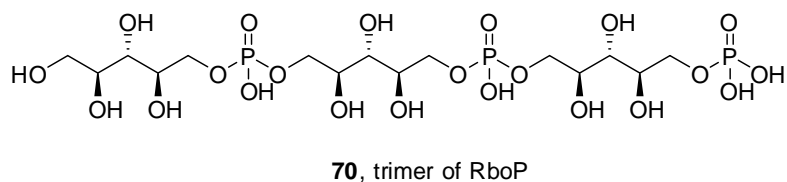
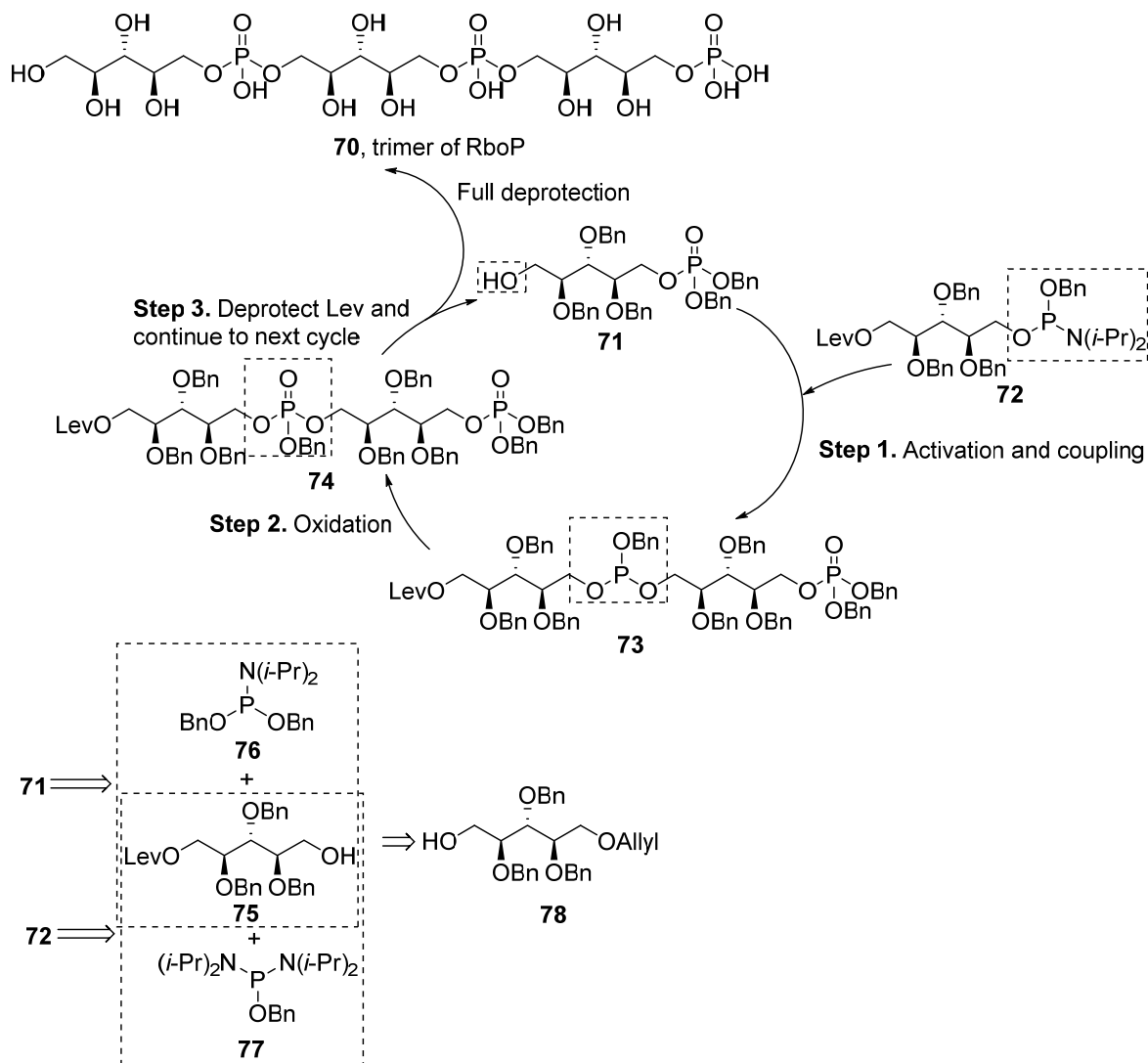

Figure 3.4: Structure of trimer of RboP **70**.

3.2 Results and discussion

3.2.1 Retrosynthetic analysis



Scheme 3.1: Retrosynthetic analysis of the target compound **70**. Lev: levulinoyl; *i*-Pr: *iso*-propyl.

The phosphoramidite method¹⁸⁴⁻¹⁸⁶, originally developed for solid-phase oligonucleotide synthesis¹⁸⁷ and adopted by van Boom and co-workers for the synthesis of a broad range of phosphodiester-linked oligomers of carbohydrates,¹⁸⁵ was chosen to install the phosphodiester bonds. Using this strategy, ribitol phosphoramidite **72** with a levulinoyl (Lev) group was devised to couple with ribitol derivative **71** to obtain phosphite triester **73**, which could be further oxidized to yield **74**. The temporary protecting Lev group of **74** was then selectively removed to continue one more cycle followed by full deprotection

to get trimer of RboP. Both ribitol derivatives **71** and **72** will be synthesized starting with commercial available compound **78**. In order to minimize the number of deprotection steps, benzyl ether was selected to protect all the other hydroxyls.

3.2.2 Synthesis of D-ribitol 5-phosphate trimer (**70**)

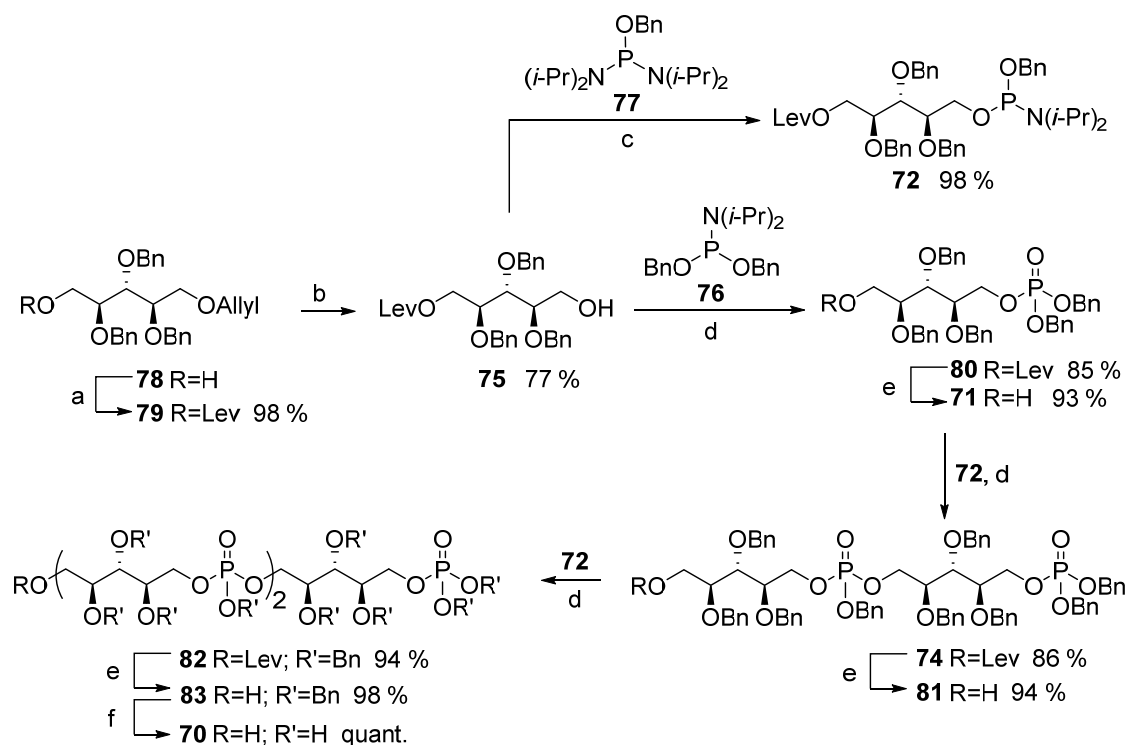

Scheme 3.2: Synthesis of fragment **70**. Conditions: a) LevOH, DMAP, DCC, DCM, 3 h; b) Pd(PPh₃)₄, 1,3-dimethylbarbituric acid, MeOH, 40 °C, 24 h; c) diisopropylammonium tetrazolide, DCM, 2 h; d) *1H*-tetrazole, MeCN, 2 h then *t*-BuOOH, 1 h; e) hydrazine hydrate, pyr, AcOH, DCM, 4 h; f) Pd-C, H₂, EtOAc/MeOH/H₂O, 24 h.

The primary alcohol of compound **78** was converted into a levulinoyl ester using levulinic acid and *N,N'*-dicyclohexylcarbodiimide (DCC). Next, the allyl group of **79** was removed with tetrakis(triphenylphosphine)palladium to afford compound **75**. Primary alcohol of **75** was reacted with phosphine derivative **77**¹⁸⁸ in the presence of diisopropylammonium tetrazolide¹⁸⁹ to obtain phosphoramidite **72**, confirmed by ³¹P-NMR (Figure 3.5-A). At the same time, coupling of **75** with dibenzyl *N,N*-diisopropylphosphoramidite **76** catalyzed by *1H*-tetrazole followed by oxidation using *tert*-butyl hydroperoxide furnished ribitol phosphate **80**. Cleavage of the temporary Lev protecting group of **80** with

hydrazine hydrate resulted in ribitol phosphate **71** (Figure 3.5-B), which was coupled with phosphoramidite **72** and then oxidized with *tert*-butyl hydroperoxide to afford the dimer of D-ribitol-5-phosphate **74**. After removal of the Lev group, dimer **81** was coupled with phosphoramidite **72** using the same conditions as above to obtain trimer **82**. Subsequent removal of the Lev group and hydrogenolysis of **83** to remove all the benzyl groups yielded the WTA fragment **70**.

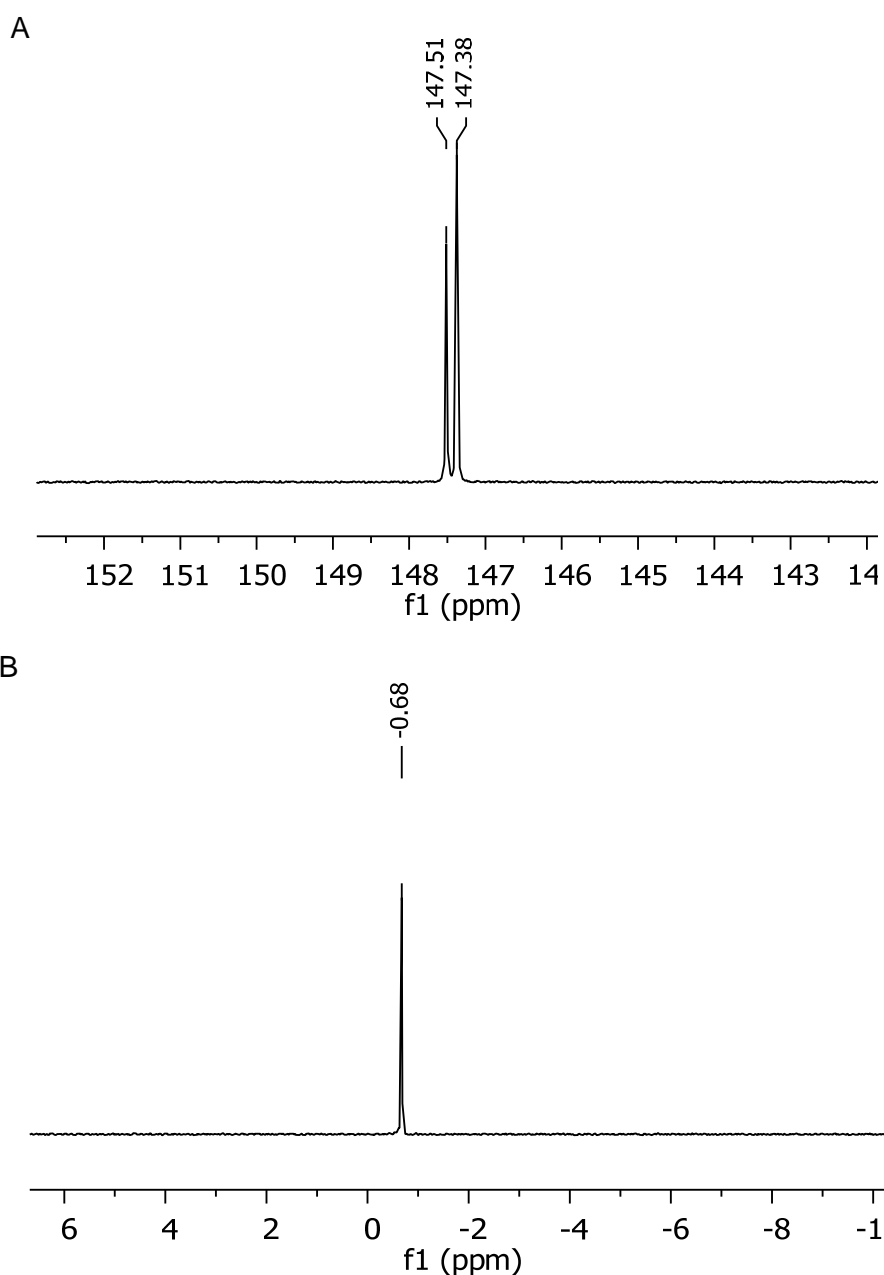
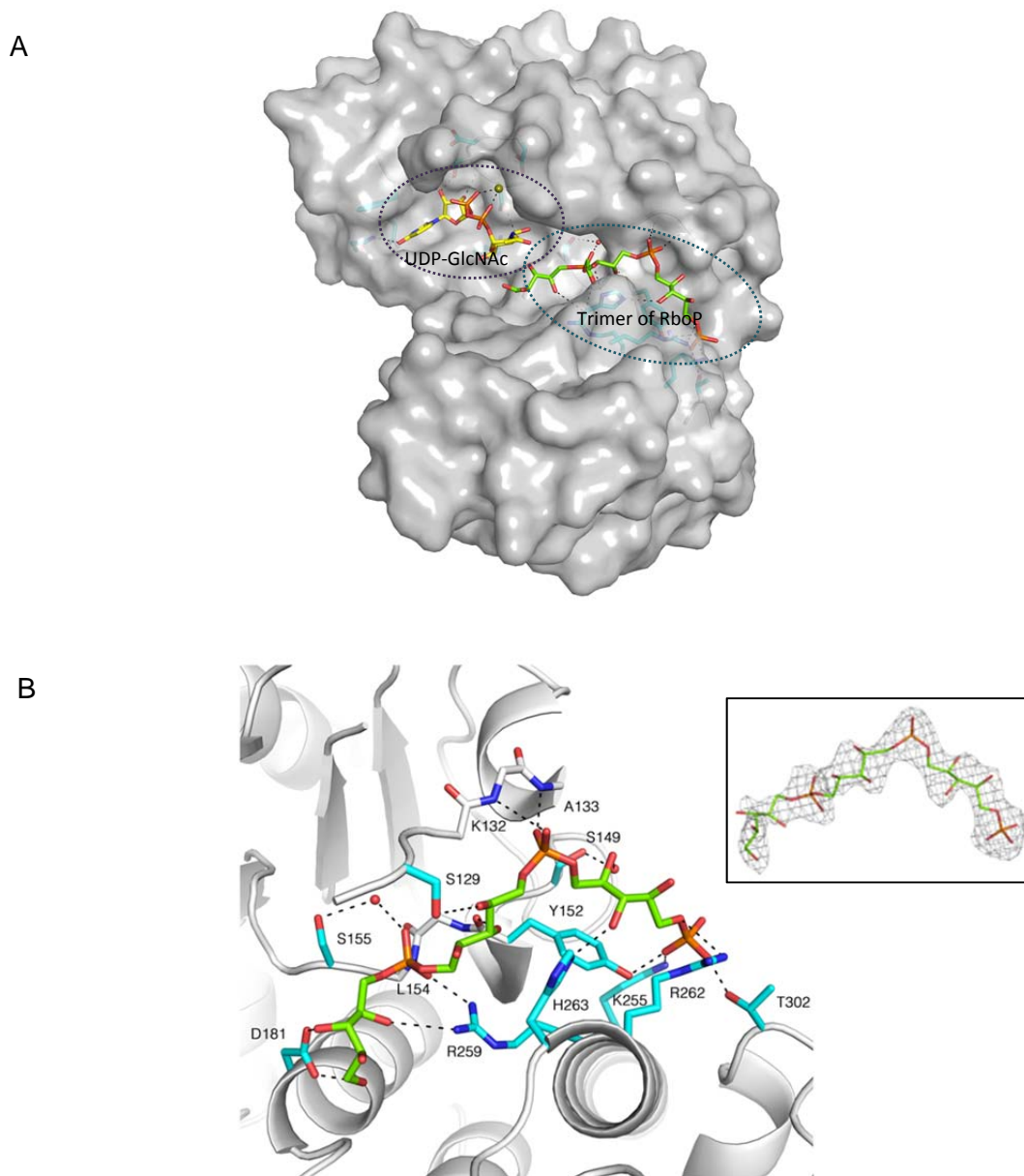

Figure 3.5: (A) ³¹P-NMR of phosphoramidite **72** (rotamers: $\delta = 147.51$ ppm, 147.38 ppm); (B) ³¹P-NMR of phosphate triester **71** ($\delta = -0.68$ ppm).

3.2.3 Interaction of glycosyltransferase TarP and synthetic WTA fragment[‡]

Synthetic WTA fragment, trimer of RboP **70**, and UDP-GlcNAc were incubated with glycosyltransferase TarP followed by co-crystallization of the complex to characterize the substrate binding domain (Figure 3.6-A). The WTA fragment moiety rests in a pocket formed by residues D181, R259, Y152, H263, K255, R262, K132 and A133 (Figure 3.6-B).



[‡] These experiments were performed by group of Prof. Thilo Stehle, Interfaculty Institute of Biochemistry, Universität Tübingen, Germany.

Figure 3.6: (A) Ternary complex structure of TarP and WTA fragment **70** and UDP-GlcNAc; (B) Interaction of active site residues of TarP with synthetic trimer of RboP. OMIT map of synthetic trimer of RboP **70** (contoured at 3σ) is provided (Inset).

To obtain insight into the catalytic mechanism and assess the validity of the observed interactions, several of the amino acids that lie in close proximity to the bound WTA fragment were mutated and the enzymatic activities of the mutants were analyzed by colorimetric assays¹⁸² in each case (Table 3.1). Residue Asp-181, which is closer to the binding pocket of UDP-GlcNAc, is clearly the most important residue for catalysis, as its mutation to alanine essentially renders TarP inactive.

Table 3.1: Design of TarP mutations and catalytic activity of mutants.

	Protein	Activity (% of wildtype)
	TarP	100
Mutation	R262A	97.3
	H263A	81.9
	R259A	10.1
	D181A	1.0
	Y152A	44.0
	K255A	99.2

3.3 Conclusion

A WTA fragment, trimer of RboP **70**, was rapidly synthesized through phosphoramidite method. This synthetic molecule was then soaked into glycosyltransferase TarP to characterize the binding domain. Structure-guided mutagenesis experiments of TarP identified critical residues for enzyme activity.

3.4 Experimental section

5-O-Allyl-2,3,4-tri-O-benzyl-1-O-levulinoyl-D-ribitol (**79**)

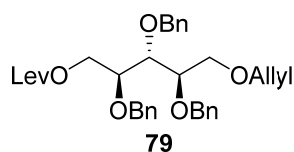

To a solution of commercially available 5-*O*-allyl-2,3,4-tri-*O*-benzyl-D-ribitol **78** (463 mg, 1.0 mmol) in dichloromethane (5 mL) was added DMAP (12 mg, 0.1 mmol), levulinic acid (0.2 mL, 2.0 mmol) and DCC (310 mg, 1.5 mmol). After stirring for 3 h at room temperature, the reaction was filtered and concentrated *in vacuo*. The residue was purified by flash column chromatography using 15% ethyl acetate in hexanes to afford compound **79** (549 mg, 0.98 mmol, 98%) as a colorless oil.

$[\alpha]_D^{25}$ -12.5 (c 5.44, CHCl₃); ¹H NMR (400 MHz, CDCl₃) δ 7.39 – 7.17 (m, 15H), 5.88 (ddt, $J = 17.2, 10.9, 5.5$ Hz, 1H), 5.25 (ddd, $J = 17.2, 3.3, 1.6$ Hz, 1H), 5.15 (ddd, $J = 10.4, 2.9, 1.3$ Hz, 1H), 4.75 – 4.66 (m, 3H), 4.65 – 4.56 (m, 3H), 4.42 (dd, $J = 12.0, 2.7$ Hz, 1H), 4.22 (dd, $J = 12.0, 5.8$ Hz, 1H), 3.95 (dt, $J = 5.5, 1.4$ Hz, 2H), 3.92 – 3.80 (m, 3H), 3.71 – 3.65 (m, 1H), 3.61 (dd, $J = 10.5, 5.1$ Hz, 1H), 2.67 (t, $J = 6.7$ Hz, 2H), 2.55 – 2.47 (m, 2H), 2.14 (s, 3H); ¹³C NMR (101 MHz, CDCl₃) δ 206.6, 172.7, 138.6, 138.4, 138.3, 134.9, 128.4, 128.2, 128.1, 128.0, 127.7 (2C), 127.6, 117.0, 78.3, 78.2, 77.3, 73.9, 72.6, 72.4, 72.3, 69.8, 64.1, 38.0, 30.0, 28.1; HRMS (ESI) calcd for C₃₄H₄₀O₇Na [M+Na]⁺ 583.2672; found: 583.2621.

2,3,4-Tri-*O*-benzyl-1-*O*-levulinoyl-D-ribitol (**75**)

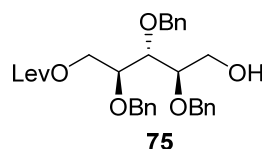

Tetrakis(triphenylphosphine)palladium (113 mg, 0.098 mmol) and 1,3-dimethylbarbituric acid (612 mg, 3.92 mmol) were added to a solution of compound **79** (549 mg, 0.98 mmol) in MeOH (4 mL) at room temperature. The reaction was stirred for 24 h at 40 °C. The solvent was removed *in vacuo* and the residue was dissolved with dichloromethane and extracted with saturated aq. NaHCO₃ solution. The organic layer was washed with brine, dried over Na₂SO₄, filtered and concentrated. The residue was purified by flash column

chromatography with 30% ethyl acetate in hexanes to give **75** (392 mg, 0.75 mmol, 77%) as a pale yellow oil.

$[\alpha]_D^{25}$ -4.16 (c 1.54, CHCl₃); ¹H NMR (400 MHz, CDCl₃) δ 7.42 – 7.25 (m, 15H), 4.72 (s, 2H), 4.69 – 4.59 (m, 4H), 4.46 (dd, *J* = 11.9, 2.3 Hz, 1H), 4.24 (dd, *J* = 12.0, 5.6 Hz, 1H), 3.89 (d, *J* = 3.9 Hz, 2H), 3.80 – 3.68 (m, 3H), 2.71 (t, *J* = 6.6 Hz, 2H), 2.55 (t, *J* = 6.6 Hz, 2H), 2.17 (s, 3H); ¹³C NMR (101 MHz, CDCl₃) δ 206.6, 172.7, 138.0 (2C), 137.9, 128.6 (2C), 128.5, 128.3, 128.2, 128.1, 128.0 (2C), 127.9, 78.7, 78.6, 77.2, 74.1, 72.4, 72.2, 63.9, 61.3, 38.0, 30.0, 28.0; HRMS (ESI) calcd for C₃₁H₃₆O₇Na [M+Na]⁺ 543.2359; found: 543.2340.

Benzyl (2,3,4-tri-*O*-benzyl-1-*O*-levulinoyl-5-*D*-ribityl) *N,N*-diisopropylphosphoramidite (**72**)

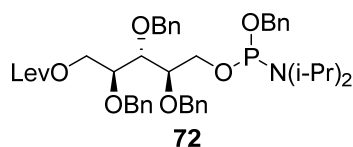

Benzylxy[bis(diisopropylamino)]phosphine **77**¹⁸⁸ (109 mg, 0.32 mmol) and diisopropylammonium tetrazolide¹⁸⁹ (41 mg, 0.24 mmol) were added to a solution of **75** (84 mg, 0.16 mmol) in dichloromethane (3 mL) at room temperature. After stirring for 2 h, the reaction mixture was poured into saturated aq. NaHCO₃ solution. The organic layer was washed with brine, dried over Na₂SO₄, filtered and concentrated. The residue was purified by flash column chromatography using 20% ethyl acetate in hexanes (1% triethylamine) to afford compound **72** (121 mg, 0.158 mmol, 98%) as a colorless oil.

¹H NMR (400 MHz, CDCl₃) δ 7.61 – 6.93 (m, 20H), 4.83 – 4.49 (m, 8H), 4.40 (d, *J* = 11.9 Hz, 1H), 4.28 – 4.15 (m, 1H), 4.06 – 3.74 (m, 5H), 3.66 (m, 2H), 2.71 – 2.60 (m, 2H), 2.50 (dt, *J* = 8.4, 4.3 Hz, 2H), 2.13 (s, 3H), 1.20 – 1.15 (m, 12H); ¹³C NMR (101 MHz, CDCl₃) δ 206.5, 172.6, 138.5 (2C), 138.2, 128.2 (2C), 128.1, 128.0, 127.9, 127.8 (2C), 127.6, 127.5, 127.4, 127.2, 127.1, 126.9, 126.8, 78.8, 78.7, 78.3, 78.1, 77.3, 73.7, 72.4, 72.1, 65.3, 65.1, 64.2, 63.0, 62.8, 43.1, 43.0, 37.9, 29.9, 27.9, 24.8, 24.7, 24.6; ³¹P NMR (162 MHz, CDCl₃) δ 147.51, 147.38.

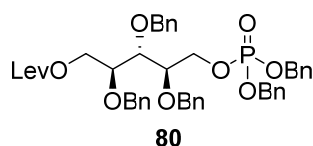
Dibenzyl (2,3,4-tri-*O*-benzyl-1-*O*-levulinoyl-5-*D*-ribityl) phosphate (80)

Dibenzyl *N,N*-diisopropylphosphoramidite **76** (0.82 mL, 2.44 mmol) was slowly added to a solution of compound **75** (980 mg, 1.87 mmol) in acetonitrile (10 mL) at 0 °C followed by the addition of *1H*-tetrazole (5.4 mL, 0.45 M in acetonitrile). The reaction was stirred for 2 h and *tert*-butyl hydroperoxide (0.7 mL, 5.5 M in decane) was added. The reaction mixture was stirred for additional 1 h. The solvent was removed under vacuum and the residue was dissolved in dichloromethane, washed with saturated aq. NaHCO₃ solution and brine. The organic layer was dried over Na₂SO₄, filtered and concentrated. The residue was purified by flash column chromatography with 30% ethyl acetate in hexanes to yield compound **80** (1.25 g, 1.60 mmol, 85%) as a colorless oil.

$[\alpha]_D^{25}$ -4.01 (c 2.30, CHCl₃); ¹H NMR (400 MHz, CDCl₃) δ 7.61 – 6.96 (m, 25H), 4.99 (t, *J* = 8.4 Hz, 4H), 4.70 – 4.51 (m, 6H), 4.42 – 4.30 (m, 2H), 4.24 – 4.14 (m, 2H), 3.89 – 3.82 (m, 2H), 3.82 – 3.74 (m, 1H), 2.67 (t, *J* = 6.6 Hz, 2H), 2.51 (t, *J* = 6.6 Hz, 2H), 2.16 (s, 3H); ¹³C NMR (101 MHz, CDCl₃) δ 206.6, 172.7, 138.1, 137.9, 136.0, 135.9, 128.7, 128.6 (2C), 128.5 (2C), 128.4, 128.2, 128.1, 128.0 (2C), 127.9 (2C), 127.8 (2C), 77.7, 77.6, 77.0, 73.8, 72.6, 72.4, 69.3 (d, *J* = 2.0 Hz), 69.3 (d, *J* = 2.0 Hz), 66.9 (d, *J* = 6.0 Hz), 63.8, 38.0, 29.9, 28.0; ³¹P NMR (162 MHz, CDCl₃) δ -0.69; HRMS (ESI) calcd for C₄₅H₄₉O₁₀PK [M+K]⁺ 819.2700; found: 819.2625.

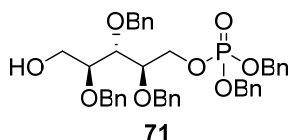
Dibenzyl (2,3,4-tri-*O*-benzyl-5-*D*-ribityl) phosphate (71)

To a solution of compound **80** (1.15 g, 1.47 mmol) in dichloromethane (15 mL) was added a mixture of pyridine (3.6 mL) and acetic acid (2.4 mL) followed by hydrazine hydrate (140 μL, 2.93 mmol) at room temperature. After stirring for 4 h, the reaction was

quenched with acetone and diluted with ethyl acetate. The organic layer was washed with saturated aq. NaHCO₃ solution, brine, dried over Na₂SO₄, filtered and concentrated. The residue was purified by flash column chromatography using 30% ethyl acetate in hexanes to afford compound **71** (931 mg, 1.36 mmol, 93%) as a colorless oil.

$[\alpha]_D^{25}$ -5.91 (c 1.06, CHCl₃); ¹H NMR (400 MHz, CDCl₃) δ 7.51 – 7.21 (m, 25H), 5.00 (t, *J* = 7.2 Hz, 4H), 4.69 – 4.60 (m, 3H), 4.59 – 4.50 (m, 3H), 4.38 – 4.29 (m, 1H), 4.25– 4.17 (m, 1H), 3.88 – 3.81 (m, 2H), 3.73 – 3.63 (m, 3H); ¹³C NMR (101 MHz, CDCl₃) δ 138.0, 137.9, 137.8, 136.0(d, *J* = 2.0 Hz, 1C), 135.9 (d, *J* = 2.0 Hz, 1C), 128.7, 128.6, 128.5 (3C), 128.4, 128.2, 128.1, 128.0, 127.9 (2C), 127.8, 78.7, 78.3, 77.9 (d, *J* = 8.0 Hz), 74.1, 72.5, 72.1, 69.4 (d, *J* = 4.0 Hz), 69.3 (d, *J* = 3.0 Hz), 66.9 (d, *J* = 5.0 Hz), 61.3; ³¹P NMR (162 MHz, CDCl₃) δ -0.68; HRMS (ESI) calcd for C₄₀H₄₃O₈PNa [M+Na]⁺ 705.2593; found: 705.2572.

D-Ribitol-5-phosphate dimer (74)

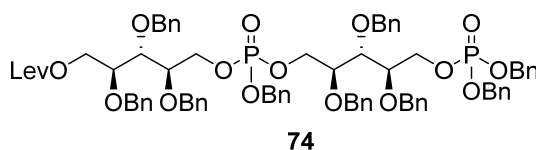

lH-Tetrazole (0.8 mL, 0.45 M in MeCN) was added to a solution of compound **71** (79.1 mg, 0.116 mmol) and compound **72** (114.0 mg, 0.150 mmol) in dichloromethane (5 mL) at room temperature. The reaction was stirred for 2 h followed by the addition of an excess amount of *tert*-butyl hydroperoxide (42 μL, 5.5 M in decane). The reaction mixture was stirred for additional 1 h, diluted with dichloromethane, washed with saturated aq. NaHCO₃ solution twice and brine. The organic layer was dried over Na₂SO₄, filtered and concentrated. The residue was purified by flash column chromatography using 25-30% acetone in hexanes to yield compound **74** (135.1 mg, 99.7 μmol, 86%) as a colorless oil.

$[\alpha]_D^{25}$ -5.55 (c 1.67, CHCl₃); ¹H NMR (400 MHz, CDCl₃) δ 8.11 – 6.50 (m, 45H), 5.04 – 4.87 (m, 6H), 4.75 – 4.41 (m, 12H), 4.42 – 4.08 (m, 8H), 3.92 – 3.70 (m, 6H), 2.66 (t, *J* = 6.5 Hz, 2H), 2.49 (t, *J* = 6.5 Hz, 2H), 2.14 (s, 3H); ¹³C NMR (101 MHz, CDCl₃) δ 206.4,

172.5, 138.0, 137.8, 135.8 (2C), 135.7 (2C), 128.5 (2C), 128.4 (3C), 128.3 (2C), 128.1, 128.0 (2C), 127.9 (4C), 127.8 (5C), 127.7 (3C), 127.6 (2C), 77.7, 77.6, 77.5, 77.0, 76.9, 73.8, 73.7, 72.5 (3C), 72.4 (2C), 72.2 (2C), 69.2 (3C), 69.1, 69.0, 66.8, 66.7, 66.6, 63.7, 37.8, 29.8, 27.8; ^{31}P NMR (162 MHz, CDCl_3) δ -0.33, -0.58, -0.69; HRMS (ESI) calcd for $\text{C}_{78}\text{H}_{84}\text{O}_{17}\text{P}_2\text{K}$ $[\text{M}+\text{K}]^+$ 1393.4821; found: 1393.4815.

De-levulinated-D-ribitol-5-phosphate dimer (81)

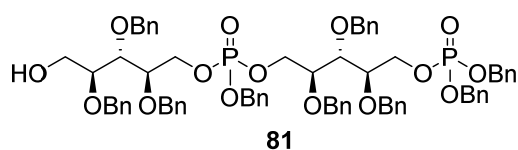

To a solution of compound **74** (302.0 mg, 0.223 mmol) in dichloromethane (4 mL) was added a mixture of pyridine (0.54 mL) and acetic acid (0.36 mL) followed by the addition of hydrazine hydrate (22 μL , 0.446 mmol) at room temperature. After stirring for 4 h, the reaction mixture was quenched with acetone and diluted with ethyl acetate. The organic layer was washed with saturated aq. NaHCO_3 solution, brine, dried over Na_2SO_4 , filtered and concentrated. The residue was purified by flash column chromatography with 30% acetone in hexanes to give compound **81** (262.2 mg, 0.209 mmol, 94%) as a colorless oil.

$[\alpha]_D^{25}$ -8.76 (c 1.09, CHCl_3); ^1H NMR (400 MHz, CDCl_3) δ 8.03 – 6.68 (m, 45H), 5.06 – 4.86 (m, 6H), 4.71 – 4.43 (m, 12H), 4.39 – 4.14 (m, 6H), 3.94 – 3.57 (m, 9H); ^{13}C NMR (101 MHz, CDCl_3) δ 138.0, 137.9 (2C), 136.0, 135.9, 128.7, 128.6, 128.4, 128.2, 128.1, 128.0 (2C), 127.9, 127.8 (2C), 78.9, 78.8, 78.4, 77.8, 77.6, 74.1, 73.9, 72.6, 72.5, 72.1, 69.3, 67.0, 61.2; ^{31}P NMR (162 MHz, CDCl_3) δ -0.39, -0.54, -0.72; HRMS (ESI) calcd for $\text{C}_{73}\text{H}_{78}\text{O}_{15}\text{P}_2\text{Na}$ $[\text{M}+\text{Na}]^+$ 1279.4714; found: 1279.4772.

Protected D-ribitol-5-phosphate trimer (82)

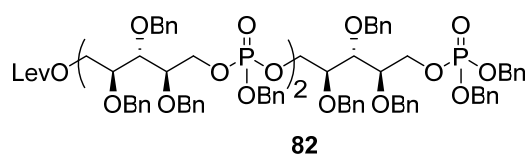

1H-Tetrazole (0.8 mL, 0.45 M in acetonitrile) was added to a solution of compound **81** (147.0 mg, 0.117 mmol) and compound **72** (115.0 mg, 0.152 mmol) in dichloromethane (5 mL) at room temperature. The reaction was stirred for 2 h followed by the addition of an excess amount of *tert*-butyl hydroperoxide (42 μ L, 5.5 M in decane). The reaction was stirred for additional 1 h, diluted with dichloromethane, washed twice with saturated aq. NaHCO₃ solution and brine. The organic layer was dried over Na₂SO₄, filtered and concentrated. The residue was purified by flash column chromatography with 25-30% acetone in hexanes to get compound **82** (212.1 mg, 0.110 mmol, 94%) as a colorless oil.

$[\alpha]_D^{25}$ -4.67 (c 1.53, CHCl₃); ¹H NMR (400 MHz, CDCl₃) δ 7.95 – 6.70 (m, 65H), 5.01 – 4.82 (m, 8H), 4.66 – 4.36 (m, 18H), 4.36 – 4.09 (m, 12H), 3.83 – 3.71 (m, 9H), 2.64 (t, *J* = 6.5 Hz, 2H), 2.47 (t, *J* = 6.6 Hz, 2H), 2.13 (s, 3H); ¹³C NMR (101 MHz, CDCl₃) δ 206.4, 172.5, 137.9, 137.8, 135.8, 135.7, 128.5 (3C), 128.4 (3C), 128.3 (2C), 128.0 (3C), 127.9 (2C), 127.8 (4C), 127.7 (3C), 127.6, 77.7, 77.6, 77.2, 73.7, 72.4, 72.3, 72.2, 69.2, 69.1 (2C), 66.8, 63.7, 37.8, 29.8, 27.8; ³¹P NMR (162 MHz, CDCl₃) δ -0.33, -0.61, -0.64, -0.72; HRMS (ESI) calcd for C₁₁₁H₁₁₉O₂₄P₃Na [M+Na]⁺ 1951.7202; found: 1951.7176.

De-levulinated-D-ribitol-phosphate trimer (**83**)

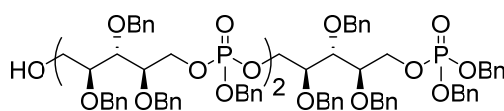

83

To a solution of compound **82** (190.2 mg, 98 μ mol) in dichloromethane (2 mL) was added a mixture of pyridine (0.24 mL) and acetic acid (0.16 mL) followed by the addition of hydrazine hydrate (10 μ L, 0.197 mmol) at room temperature. After stirring for 2 h, the reaction was quenched with acetone and diluted with ethyl acetate. The organic layer was washed with saturated aq. NaHCO₃ solution, brine, dried over Na₂SO₄, filtered and concentrated. The residue was purified by flash column chromatography using 30% acetone in hexanes to afford compound **83** (176.3 mg, 96 μ mol, 98%) as a colorless oil.

$[\alpha]_D^{25}$ -2.46 (c 1.20, CHCl₃); ¹H NMR (400 MHz, CDCl₃) δ 8.02 – 6.49 (m, 65H), 5.04 – 4.81 (m, 8H), 4.68 – 4.06 (m, 29H), 3.86 – 3.53 (m, 11H); ¹³C NMR (101 MHz, CDCl₃) δ

138.0, 137.9, 137.8, 136.0, 135.9, 128.7, 128.6 (3C), 128.5 (3C), 128.4, 128.2 (2C), 128.1 (2C), 128.0 (3C), 127.9 (2C), 127.8 (4C), 78.9, 78.8, 78.3, 77.4, 74.1, 73.9, 72.6, 72.5, 72.1, 69.3 (4C), 69.2, 67.0, 61.2; ^{31}P NMR (162 MHz, CDCl_3) δ -0.33, -0.38, -0.54, -0.64, -0.72; HRMS (ESI) calcd for $\text{C}_{106}\text{H}_{114}\text{O}_{22}\text{P}_3$ $[\text{M}+\text{H}]^+$ 1831.7015; found: 1831.6918.

D-Ribitol-5-phosphate trimer (70)

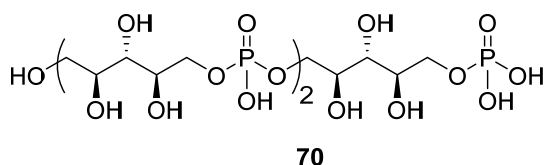

Excess amount of 10 % Pd-C was added to a solution of compound **83** (145 mg, 79 μmol) in a mixture of EtOAc/MeOH/ H_2O (5/2/1, 5.6 mL). The reaction was stirred for 36 h under hydrogen atmosphere at room temperature. The mixture was filtered to yield compound **70** (51.9 mg, 79 μmol , quant.) as a colorless oil.

$[\alpha]_{\text{D}}^{25}$ +6.27 (c 3.82, H_2O); ^1H NMR (400 MHz, D_2O) δ 4.27 – 4.11 (m, 1H), 3.96 – 3.67 (m, 10H), 3.66 – 3.48 (m, 7H), 3.48 – 3.37 (m, 3H); ^{13}C NMR (101 MHz, D_2O) δ 77.6, 72.0, 71.9, 71.8, 71.4, 71.3, 70.8, 70.7, 70.6, 70.5, 70.4, 66.7, 62.2, 62.1, 60.4; ^{31}P NMR (162 MHz, D_2O) δ 0.85, 0.23, -0.65; HRMS (ESI) calcd for $\text{C}_{15}\text{H}_{35}\text{O}_{22}\text{P}_3\text{Na}$ $[\text{M}+\text{Na}]^+$ 683.0731; found: 683.0733.

Chapter 4

1,3-Dibromo-5,5-dimethylhydantoin as promoter for glycosylations using thioglycosides[§]

4.1 Introduction

4.1.1 Thioglycosides and promoters

Thioglycosides are versatile glycosyl donors that are commonly used in oligosaccharide assembly due to their accessibility, stability, compatibility with various reaction conditions, and orthogonality to other donors.^{63, 70-73} Different electrophilic/thiophilic reagents have been developed as promoters to activate thioglycoside donors (Table 4.1).^{58, 72, 190-201}

Table 4.1: Current promoters for thioglycosides.

Promoters for Thioglycosides	
Heavy metal-based promoters	Hg(OAc) ₂ , ⁶³ HgCl ₂ , ²⁰² PhHgOTf ²⁰³
Alkylating promoters	MeOTf, ²⁰⁴ MeI ²⁰⁵
Sulfonium-based promoters	DMTST, ²⁰⁶ MeSOTf, ²⁰⁷ Me ₂ S ₂ /Tf ₂ O, ¹⁹⁶ MeSBr, PhSOTf ²⁰⁸
Halonium-based promoters	NBS, ¹⁹¹ IDCP, ²⁰⁹ IDCTf, ²¹⁰ NIS/TfOH, ¹⁹⁰ ICl or IBr/AgOTf ¹⁹³
Novel promoters	Single electron transfer with Ru or Ir catalysts ¹⁹⁸

However, most of these activators are expensive and toxic.^{63, 200, 211} Poor solubility complicates the use of some promoters during automated glycan assembly,^{94, 153, 212, 213} while the instability of some activators in solution requires them to be freshly prepared prior to use.²¹⁴⁻²¹⁶

[§] **Xu, F.-F.**; Pereira, C. L.; Seeberger, P. H. *Beilstein J. Org. Chem.* **2017**, *13*, 1994–1998. doi:10.3762/bjoc.13.195

4.1.2 1,3-Dibromo-5,5-dimethylhydantoin (DBDMH)

DBDMH, a white to pale-brown powder, is readily soluble in most organic solvents, including dichloromethane. It can be easily prepared by the reaction of 5,5-dimethylhydantoin **85** with bromine in the presence of sodium hydroxide, while 5,5-dimethylhydantoin could be obtained through Bucherer-Bergs reaction, starting from acetone, potassium cyanide and ammonium carbonate (Scheme 4.1).²¹⁷

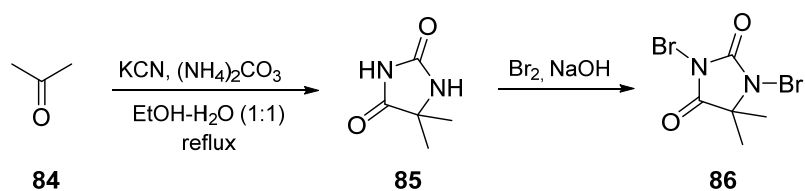

Scheme 4.1: Preparation of 1,3-dibromo-5,5-dimethylhydantoin **86**.

DBDMH is sold under the trade name Brom-55 and used as swimming pool sanitizer, as industrial brominating agent for ethylene propylene diene monomer rubber to improve ozone resistance, as additive in plastics to promote photodegradation and as a fungicide to preserve fresh fruits.²¹⁸

In synthetic chemistry, DBDMH acts as a thiophilic activator in the conversion of dithioacetals to the corresponding *O,O*-acetals (Scheme 4.2),²¹⁹⁻²²¹ as well as in the synthesis of heparin mimetics.²²²

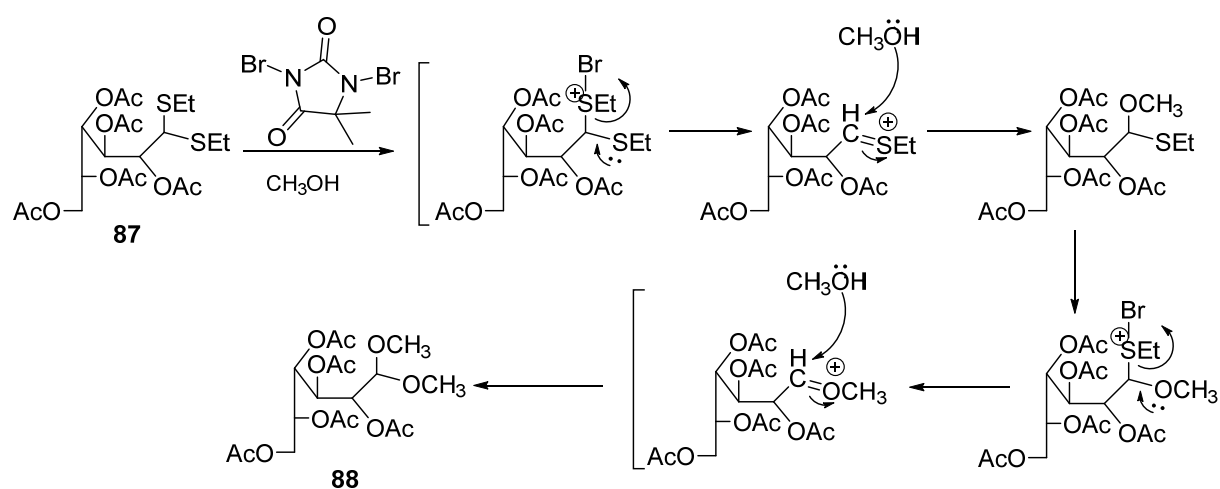

Scheme 4.2: Conversion of dithioacetal **87** to *O,O*-acetal **88** in the presence of DBDMH.

Herein, DBDMH was considered as a readily available promoter for glycosylations involving thioglycosides due to its advantages in price, solubility and stability.

4.2 Results and discussion

4.2.1 Optimization of glycosylation conditions

Initially, the capability of DBDMH to activate thioglycoside **35**¹⁴⁹ in order to glycosylate the primary hydroxyl present in D-glucose acceptor **89**²²³ was explored without any additives (Table 4.2, entry 1). This initial experiment furnished disaccharide **90**, albeit in modest yield (43%). When TfOH or TMSOTf (10 mol%) were added as co-promoter, the yield increased to more than 90% (Table 4.2, entries 2 and 3). Next, the amount of the reagent required for activation was studied (Table 4.2, entries 3-5). Substoichiometric amounts of DBDMH (0.7 equiv) in the presence of co-promoter suffice to produce disaccharide efficiently. The DBDMH/TfOH activation system is temperature insensitive as it furnishes product from -78 °C to room temperature, although most disaccharide **90** is formed at -40 °C (Table 4.2, entries 3, 6-9).

Table 4.2: Optimization of glycosylation conditions using DBDMH as promoter.

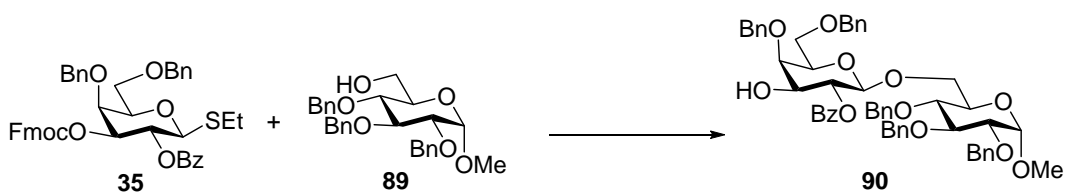

Entry ^a	DBDMH (equiv ^b)	Co-promoter (10 mol% ^b)	T (°C)	Yield ^c (%)
1	0.7	—	-40	43
2	0.7	TMSOTf	-40	93
3	0.7	TfOH	-40	92
4	0.5	TfOH	-40	85
5	1.0	TfOH	-40	94
6	0.7	TfOH	-78	83
7	0.7	TfOH	-20	87

8	0.7	TfOH	0	88
9	0.7	TfOH	r.t	79

^aReaction conditions: donor (51 μ mol), acceptor (43 μ mol), dichloromethane; quenched with triethylamine. Fmoc protecting group was cleaved during the quenching process in the presence of triethylamine.

^bEquivalents calculated relative to the amount of donor. ^cOnly isolated yields are reported.

4.2.2 1,2-*Trans* glycosylation

The scope of the new activation system was investigated by using a variety of glycosyl donors **30**, **32**, **35**, **37** and **91-94**^{147, 148, 224-226} containing C-2 participating groups to ensure 1,2-*trans* glycoside formation (Table 4.3). Each glycosylating agent was reacted with D-glucose acceptors **89** (Table 4.3, entries 1-8) and **95**²²⁷ (Table 4.3, entries 9-16) with free hydroxyl group at C-6 and C-4 position, respectively. The DBDMH/TfOH system activates glycosyl donors including monosaccharides of different configurations (D-gluco **32** and **91**, D-galacto **35** and **37**, D-manno **92**, L-rhamno **93**), amino sugar **30** and uronic acid **94**. All thioglycosides reacted equally well, irrespective of their aglycons (SEt or STol). This promoter is compatible with most commonly used protecting groups, except some electron-rich groups like 4-methoxybenzyl ethers that may be partly brominated under these conditions.²²⁸

Table 4.3: 1,2-*Trans* glycosylation activated by DBDMH with a variety of substrates.

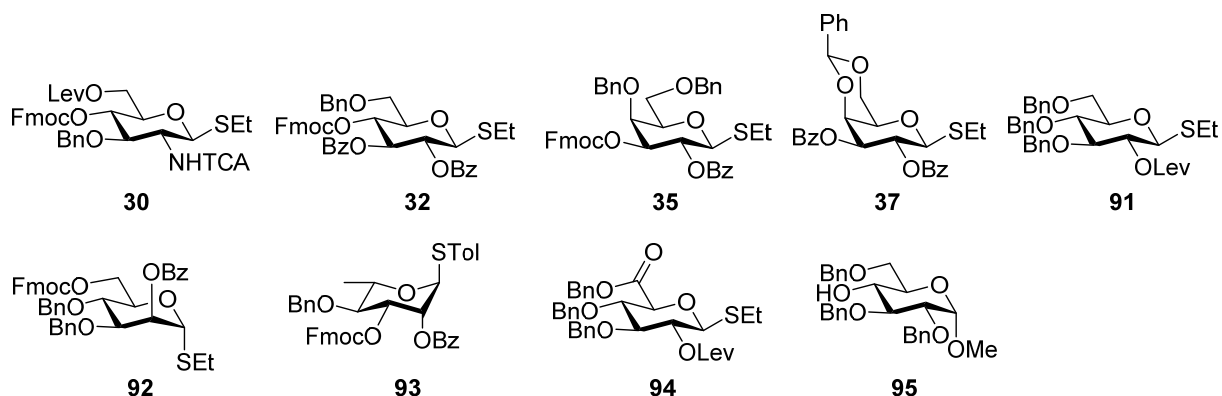

Entry ^a	Donor	Acceptor	Yield ^b (%)	Entry ^a	Donor	Acceptor	Yield ^b (%)
1	30	89	91	9	30	95	60
2	32	89	98	10	32	95	87
3	35	89	92	11	35	95	88
4	37	89	95	12	37	95	88
5	91	89	94	13	91	95	89
6	92	89	96	14	92	95	89
7	93	89	91	15	93	95	86
8	94	89	39	16	94	95	45

^aAll reactions were carried out at -40 °C in dichloromethane with 0.7 equiv DBDMH and 10 mol% TfOH as promoter. ^bOnly isolated yields are reported.

4.2.3 1,2-*Cis* glycosylation

To probe the scope of DBDMH/TfOH-mediated 1,2-*cis* glycosylation, perbenzylated galactosyl donor **96**²²⁹ (Table 4.4, entries 1-4) and galactosyl donor **97**⁷⁷ (Table 4.4, entries 5 and 6) as well as glucosyl donor **98** (Table 4.4, entries 7 and 8) were reacted with acceptor **89** in the presence of DBDMH. Electron-rich ('armed') thioglycosides²⁰⁹ are more readily activated as the reaction of perbenzylated donor **96** in dichloromethane at -78 °C afforded disaccharide with excellent yield but low stereoselectivity. The α/β ratio, determined by supercritical fluid chromatography (SFC), shifted significantly toward the α isomer with ether⁸⁵ and toward the β isomer when acetonitrile²³⁰ was used as co-solvent (Figure 4.1). With all these donors, the α -stereoselectivity increased at higher temperature (Figure 4.2).²³¹ Galactosyl donor **97**, containing a remote participating group at C-4 position, produced disaccharide with better α -selectivity.^{77, 212}

Table 4.4: 1,2-*Cis* glycosylation activated by DBDMH.

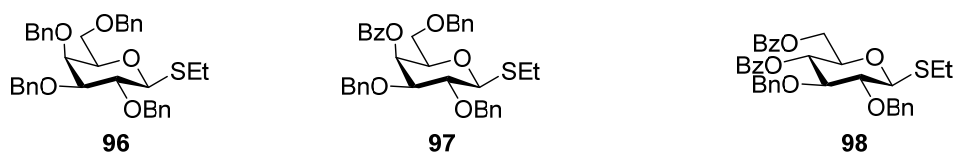

Entry ^a	Donor	Acceptor	Solvent	T (°C)	Yield ^b (%)	α/β ratio ^c
1	96	89	DCM/Et ₂ O ^d	-78	94	1:1.4
2	96	89	DCM	-78	94	1:2.7
3	96	89	DCM/MeCN ^d	-78	93	1:11.7
4	96	89	DCM	-40	67	1:1.3
5	97	89	DCM	-78	72	4.6:1
6	97	89	DCM	-40	50	11.8:1
7	98	89	DCM	-78	76	1:1.1
8	98	89	DCM	-40	69	1:1

^aAll reactions were carried out with 0.7 equiv DBDMH and 10 mol% TfOH as promotor. ^bOnly isolated yields are reported. ^cSFC was used to determine α/β ratio. ^dThe ratio of solvents is 2:1 (v/v).

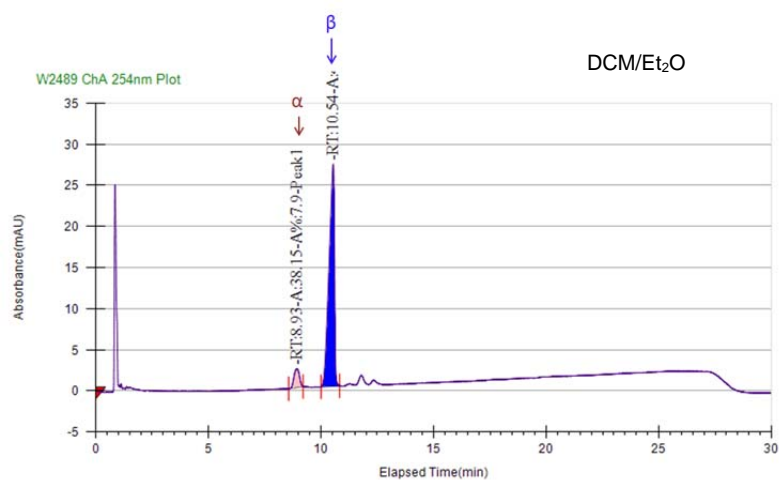

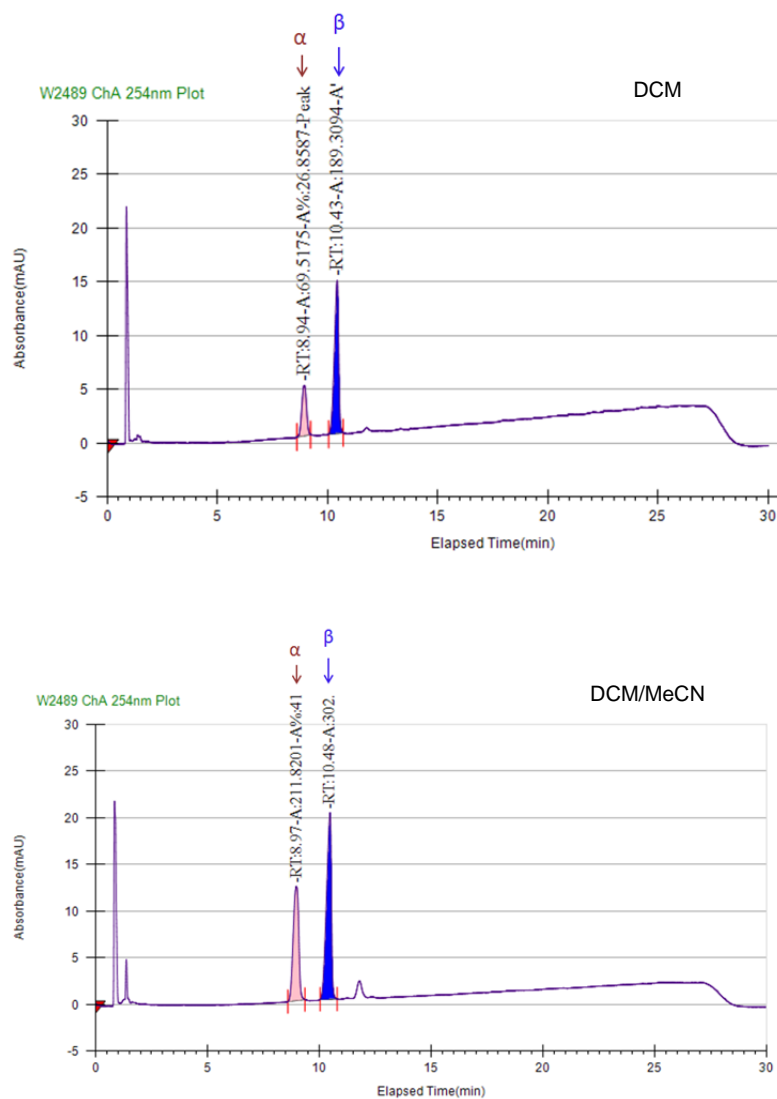
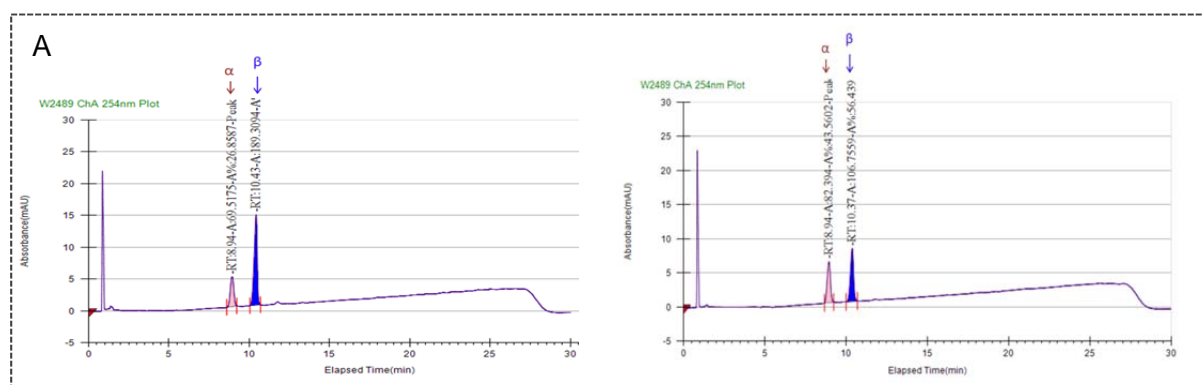

Figure 4.1: Analytical SFC to determine α/β ratio to illustrate solvent effects in glycosylations (Table 4.4, entries 1-3). Silica-2EP analytical column was used when using SFC. *iso*-propanol was used for the mobile phase.



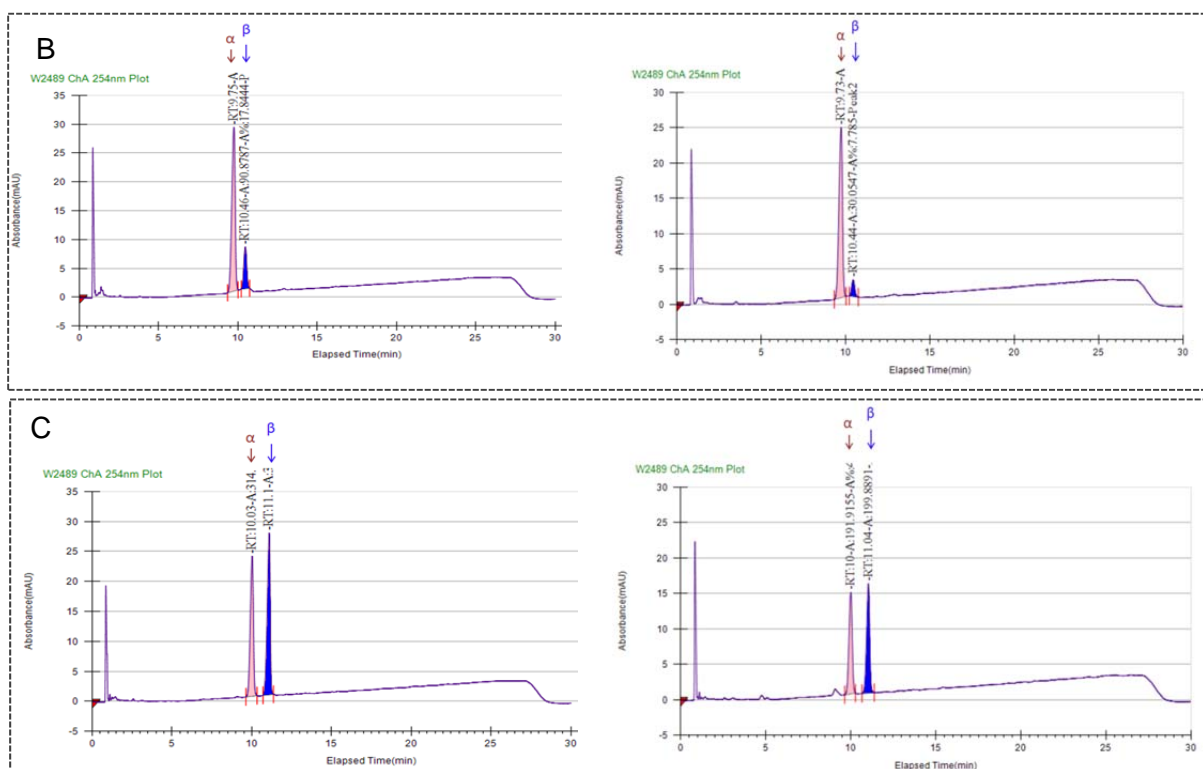
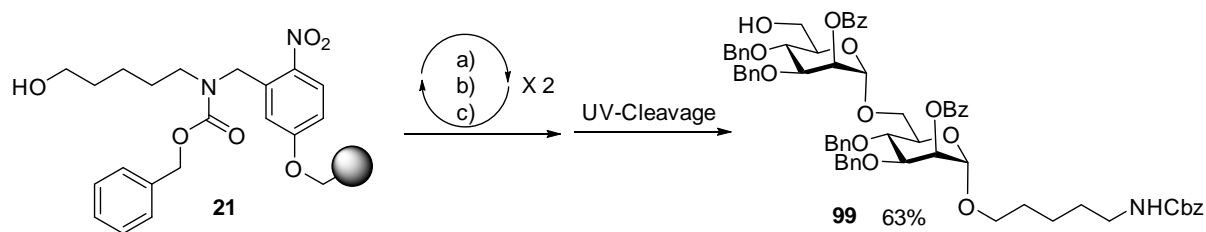

Figure 4.2: Analytical SFC to determine α/β ratio to illustrate temperature effect in glycosylations: (A) Table 4.4, entries 2 and 4; (B) Table 4.4, entries 5 and 6; (C) Table 4.4, entries 7 and 8.

4.2.4 Automated glycan assembly using DBDMH

Automated glycan assembly (AGA) is the most rapid means to access complex oligosaccharides.^{94, 232} *N*-iodosuccinimide (NIS), together with TfOH, are currently used as the activation system for thioglycosides on such instruments. But the synthesizer could get clogged due to the low solubility of NIS in dichloromethane. To avoid this issue, dioxane has been used as co-solvent, which, however, could make stereoselectivity problematic.

To assess the suitability of highly soluble DBDMH as promotor in AGA, disaccharide **99** was synthesized in the presence of co-promoter TMSOTf using functionalized resin **21**⁹⁶ as solid support (Scheme 4.3). After two coupling cycles with building block **92**, the disaccharide was cleaved from the solid support using a continuous-flow photoreactor as described previously.⁹⁶ The analytical HPLC of the crude (Figure 4.3) showed a single peak. After purification, disaccharide **99** was obtained in 63% yield.



Scheme 4.3: DBDMH as promotor in AGA. Modules: (a) acidic wash; (b) glycosylation using DBDMH/TMSOTf, **92**; (c) Fmoc deprotection.

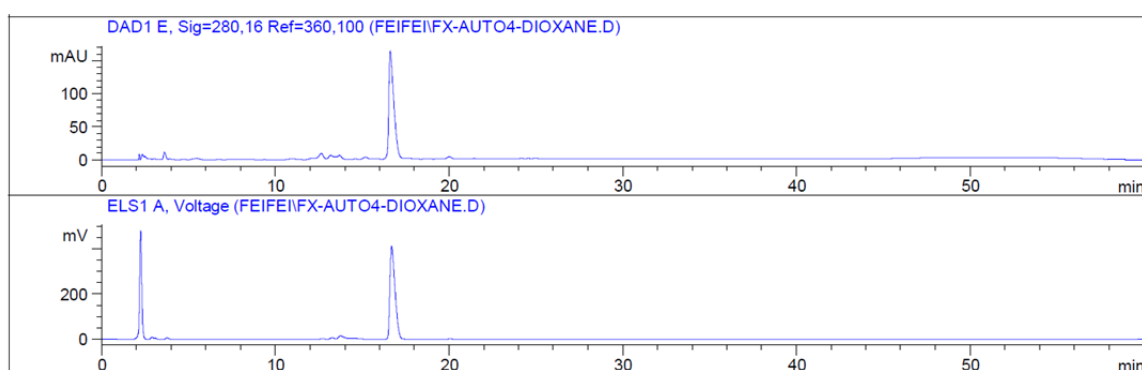
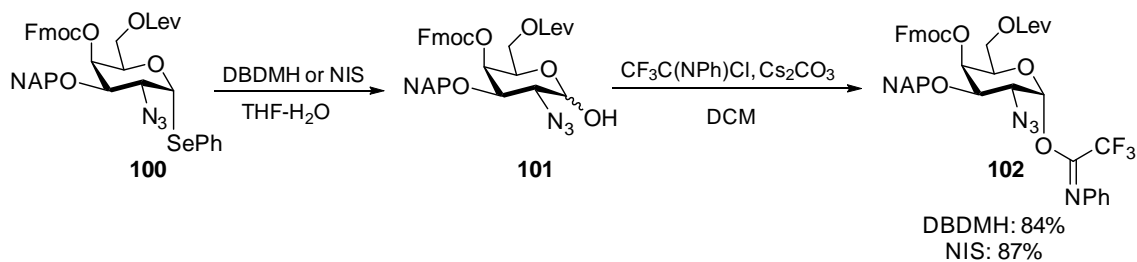

Figure 4.3: Analytical HPLC of the crude disaccharide **99** after UV-cleavage. Column: YMC-Diol-300-NP $5\mu\text{m}$ (150×4.60 mm); mobile phase: ethyl acetate and hexanes.

4.2.5 Hydrolysis of glycosyl selenide with DBDMH

Moreover, DBDMH performs as well as NIS in activating phenyl selenoglycoside **100** in the presence of water to furnish hemi-acetal **101** *en route* to glycosyl imidate **102** (Scheme 4.4).



Scheme 4.4: Hydrolysis of glycosyl selenide **100** with DBDMH.

4.3 Conclusion

The inexpensive reagent DBDMH has been demonstrated to be a powerful promoter for activation of thioglycosides both in solution and in automated glycan assembly on solid phase. A variety of substrates containing diverse protecting groups have been investigated with promising results, while the stereoselectivity of the reactions follows reported trends. Compared with NIS, which is a common method for thioglycoside activation, this promoter is readily available, highly soluble, and shelf-stable.

4.4 Experimental section

4.4.1 Preparation of building blocks

Ethyl 3-*O*-benzyl-6-*O*-levulinoyl-4-*O*-(9-fluorenylmethoxycarbonyl)-2-*N*-trichloroacetyl-1-thio- β -D-glucosaminopyranoside (30)

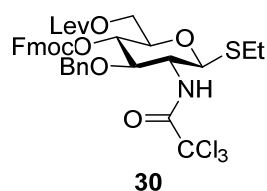

^1H NMR (400 MHz, CDCl_3) δ 7.68 (dd, $J = 7.5, 3.7$ Hz, 2H), 7.63 – 7.41 (m, 2H), 7.36 – 7.26 (m, 2H), 7.24 – 7.19 (m, 2H), 7.15 – 7.05 (m, 5H), 6.86 (d, $J = 7.7$ Hz, 1H), 4.98 (d, $J = 10.3$ Hz, 1H), 4.84 (dd, $J = 9.9, 9.0$ Hz, 1H), 4.54 (s, 2H), 4.42 (dd, $J = 10.5, 6.8$ Hz, 1H), 4.31 – 4.09 (m, 5H), 3.69 (ddd, $J = 10.0, 5.2, 2.8$ Hz, 1H), 3.56 (td, $J = 10.1, 7.9$ Hz, 1H), 2.73 – 2.58 (m, 4H), 2.56 – 2.49 (m, 2H), 2.09 (s, 3H), 1.28 – 1.12 (m, 3H).

NMR data was in accordance with previously reported values.¹⁴⁷

Ethyl 2,3-di-*O*-benzoyl-4,6-*O*-benzylidene-1-thio- β -D-galactopyranoside (37)

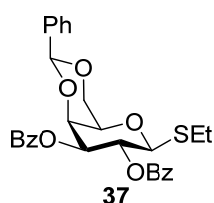

^1H NMR (600 MHz, CDCl_3) δ 8.02 – 7.93 (m, 4H), 7.56 – 7.46 (m, 4H), 7.42 – 7.33 (m, 7H), 5.96 (t, $J = 9.9$ Hz, 1H), 5.54 (s, 1H), 5.40 (dd, $J = 10.0, 3.5$ Hz, 1H), 4.74 (d, $J = 9.9$ Hz, 1H), 4.63 (dd, $J = 3.6, 1.0$ Hz, 1H), 4.42 (dd, $J = 12.4, 1.6$ Hz, 1H), 4.10 (dd, $J = 12.4, 1.7$ Hz, 1H), 3.73 (s, 1H), 2.95 (dq, $J = 12.2, 7.4$ Hz, 1H), 2.81 (dq, $J = 12.2, 7.5$ Hz, 1H), 1.31 (t, $J = 7.5$ Hz, 3H).

NMR data was in accordance with previously reported values.²²⁴

Methyl 2,3,4-tri-*O*-benzyl- α -D-glucopyranoside (**89**)

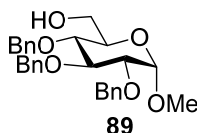

^1H NMR (400 MHz, CDCl_3) δ 7.39 – 7.26 (m, 15H), 4.99 (d, $J = 10.9$ Hz, 1H), 4.89 (d, $J = 11.0$ Hz, 1H), 4.86 – 4.78 (m, 2H), 4.68 – 4.63 (m, 2H), 4.56 (d, $J = 3.5$ Hz, 1H), 4.01 (t, $J = 9.2$ Hz, 1H), 3.77 (dd, $J = 11.7, 2.6$ Hz, 1H), 3.72 – 3.61 (m, 2H), 3.56 – 3.46 (m, 2H), 3.37 (s, 3H).

NMR data was in accordance with previously reported values.²²³

Ethyl 3,4,6-tri-*O*-benzyl-2-*O*-levulinoyl-1-thio- β -D-glucopyranoside (**91**)

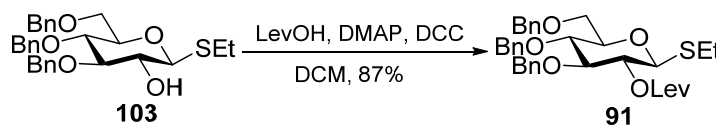

To a solution of ethyl 3,4,6-tri-*O*-benzyl-1-thio- β -D-glucopyranoside²³³ **103** (184 mg, 0.37 mmol) in dichloromethane (4 mL) was added levulinic acid (75 μL , 0.74 mmol) followed by DMAP (45 mg, 0.37 mmol) and *N,N'*-Dicyclohexylcarbodiimide (DCC, 153 mg, 0.74 mmol). The reaction mixture was stirred for 4 h at room temperature. The reaction was then diluted with dichloromethane and washed with saturated aq. NaHCO_3 solution. The organic layer was dried over Na_2SO_4 , filtered and concentrated. The residue was purified by flash column chromatography to afford **91** (191 mg, 0.32 mmol, 87%) as a white solid.

$[\alpha]_D^{25}$ -5.88 (c 1.97, CHCl_3); $^1\text{H NMR}$ (400 MHz, CDCl_3) δ 7.38 – 7.29 (m, 13H), 7.20 (dd, $J = 7.2, 2.4$ Hz, 2H), 5.11 – 5.01 (m, 1H), 4.82 (d, $J = 10.9$ Hz, 2H), 4.76 (d, $J = 11.4$ Hz, 1H), 4.63 (d, $J = 12.1$ Hz, 1H), 4.61 – 4.55 (m, 2H), 4.39 (d, $J = 10.0$ Hz, 1H), 3.82 – 3.68 (m, 4H), 3.53 (ddd, $J = 7.7, 4.4, 2.2$ Hz, 1H), 2.82 – 2.63 (m, 4H), 2.62 – 2.47 (m, 2H), 2.19 (s, 3H), 1.29 (t, $J = 7.4$ Hz, 3H); $^{13}\text{C NMR}$ (101 MHz, CDCl_3) δ 206.3, 171.7, 138.3, 138.2, 138.0, 128.5 (3C), 128.1, 128.0 (2C), 127.8, 127.7, 84.4, 83.5, 79.5, 77.9, 75.3, 75.2, 73.5, 72.2, 68.9, 38.0, 30.0, 28.2, 24.0, 15.1; HRMS (ESI) calcd for $\text{C}_{34}\text{H}_{40}\text{O}_7\text{SNa}$ $[\text{M}+\text{Na}]^+$ 615.2387; found: 615.2401.

Ethyl 2-*O*-benzoyl-3,4-di-*O*-benzyl-6-*O*-(9-fluorenylmethoxycarbonyl)-1-thio- α -D-mannopyranoside (92)

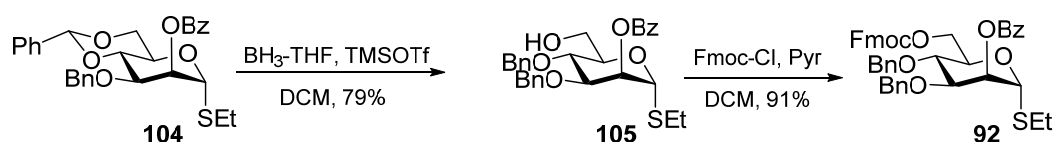

To a solution of ethyl 2-*O*-benzoyl-3-*O*-benzyl-4,6-*O*-benzylidene-1-thio- α -D-mannopyranoside **104**²³⁴ (592 mg, 1.17 mmol) in dichloromethane (5 mL) was added 1M solution of BH_3 -THF (5.8 mL, 5.85 mmol) followed by trimethylsilyl trifluoromethanesulfonate (TMSOTf, 32 μL , 0.17 mmol). The reaction mixture was stirred for 2 h at room temperature. Triethylamine was then added to quench the reaction followed by addition of MeOH. The reaction mixture was concentrated and purified by flash column chromatography to give ethyl 2-*O*-benzoyl-3,4-di-*O*-benzyl-1-thio- α -D-mannopyranoside **105** (470 mg, 0.92 mmol, 79%) as a colorless oil.

9-Fluorenylmethyl chloroformate (446 mg, 1.72 mmol) and pyridine (0.28 mL, 3.44 mmol) were added to a solution of **105** (437 mg, 0.86 mmol) in dichloromethane (5 mL). The reaction mixture was stirred overnight at room temperature, diluted with dichloromethane and quenched with 1M aq. HCl solution. The organic layer was extracted, dried over Na_2SO_4 , filtered and concentrated. The residue was purified by flash column chromatography to afford **92** (570 mg, 0.78 mmol, 91%) as a white foam.

$[\alpha]_D^{25} +41.97$ (c 1.16, CHCl_3); $^1\text{H NMR}$ (400 MHz, CDCl_3) δ 8.16 (dt, $J = 8.2, 1.1$ Hz, 2H), 7.80 (dd, $J = 7.6, 1.1$ Hz, 2H), 7.70 – 7.61 (m, 2H), 7.60 – 7.53 (m, 1H), 7.49 – 7.40 (m, 4H), 7.38 – 7.29 (m, 12H), 5.75 (dd, $J = 3.0, 1.6$ Hz, 1H), 5.46 (d, $J = 1.6$ Hz, 1H), 4.96 (d, $J = 10.9$ Hz, 1H), 4.82 (d, $J = 11.2$ Hz, 1H), 4.65 (d, $J = 10.9$ Hz, 1H), 4.60 (d, $J = 11.2$ Hz, 1H), 4.56 – 4.47 (m, 2H), 4.45 – 4.40 (m, 2H), 4.40 – 4.33 (m, 1H), 4.29 (t, $J = 7.5$ Hz, 1H), 4.09 (dd, $J = 9.1, 2.9$ Hz, 1H), 4.02 (t, $J = 7.5$ Hz, 1H), 2.80 – 2.59 (m, 2H), 1.33 (t, $J = 7.4$ Hz, 3H); $^{13}\text{C NMR}$ (101 MHz, CDCl_3) δ 165.7, 155.3, 143.6, 143.4, 141.4, 138.0, 137.6, 133.4, 130.1, 129.9, 128.6 (2C), 128.5, 128.3, 128.0 (3C), 127.3, 125.4, 125.3, 120.2, 82.7, 78.8, 75.4, 74.1, 71.7, 70.7, 70.3, 70.1, 66.9, 46.9, 25.8, 15.1.; HRMS (ESI) calcd for $\text{C}_{44}\text{H}_{42}\text{O}_8\text{SNa}$ $[\text{M}+\text{Na}]^+$ 753.2493; found: 753.2503.

***p*-Tolyl 2-*O*-benzoyl-4-*O*-benzyl-3-*O*-(9-fluorenylmethoxycarbonyl)-1-thio- α -L-rhamnopyranoside (**93**)**

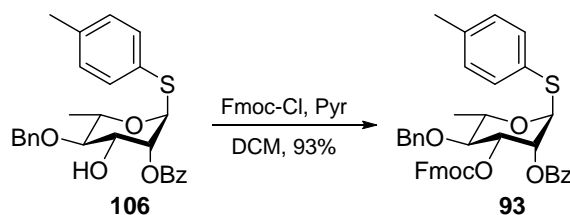

9-Fluorenylmethyl chloroformate (559 mg, 2.16 mmol) and pyridine (0.23 mL, 2.88 mmol) were added to a solution of *p*-tolyl 2-*O*-benzoyl-4-*O*-benzyl-1-thio- α -L-rhamnopyranoside **106**²³⁵ (669 mg, 1.44 mmol) in dichloromethane (6 mL). The reaction mixture was stirred overnight at room temperature. The reaction was then diluted with dichloromethane and quenched with 1M aq. HCl solution. The organic layer was extracted, dried over Na_2SO_4 , filtered and concentrated. The residue was purified by flash column chromatography to afford **93** (932 mg, 1.34 mmol, 93%) as a white foam.

$[\alpha]_D^{25} -46.86$ (c 0.93, CHCl_3); $^1\text{H NMR}$ (400 MHz, CDCl_3) δ 8.17 – 7.98 (m, 2H), 7.74 (ddd, $J = 7.7, 2.3, 1.1$ Hz, 2H), 7.67 – 7.60 (m, 1H), 7.55 (ddd, $J = 7.6, 2.1, 1.0$ Hz, 2H), 7.49 (t, $J = 7.8$ Hz, 2H), 7.42 – 7.30 (m, 9H), 7.23 (td, $J = 7.5, 1.1$ Hz, 1H), 7.19 – 7.11 (m, 3H), 5.89 (dd, $J = 3.2, 1.7$ Hz, 1H), 5.49 (d, $J = 1.6$ Hz, 1H), 5.29 (dd, $J = 9.7, 3.2$ Hz, 1H), 4.88 (d, $J = 11.1$ Hz, 1H), 4.71 (d, $J = 11.1$ Hz, 1H), 4.61 – 4.51 (m, 1H), 4.42 (dq, $J = 9.4, 6.2$ Hz, 1H), 4.33 – 4.24 (m, 2H), 3.76 (t, $J = 9.5$ Hz, 1H), 2.33 (s, 3H), 1.43 (d, $J =$

6.1 Hz, 3H); ^{13}C NMR (101 MHz, CDCl_3) δ 165.6, 154.3, 143.7, 143.2, 141.4, 141.3, 138.3, 137.9, 133.6, 132.7, 130.1 (2C), 129.7 (2C), 128.6 (2C), 128.1, 128.0 (2C), 127.9, 127.3, 127.2, 125.5, 125.2, 120.1 (2C), 86.2, 78.8, 76.8, 75.4, 72.1, 70.4, 69.1, 46.8, 21.3, 18.1; HRMS (ESI) calcd for $\text{C}_{42}\text{H}_{38}\text{O}_7\text{SNa}$ $[\text{M}+\text{Na}]^+$ 709.2230; found: 709.2238.

Benzyl (ethyl 3,4-di-*O*-benzyl-2-*O*-levulinoyl-1-thio- β -D-glucopyranosid)uronate (94)

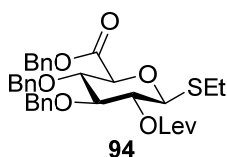

^1H NMR (400 MHz, CDCl_3) δ 7.52 – 7.17 (m, 13H), 7.16 – 7.00 (m, 2H), 5.16 (s, 2H), 5.05 (t, $J = 9.5$ Hz, 1H), 4.76 (d, $J = 11.4$ Hz, 1H), 4.73 – 4.63 (m, 2H), 4.45 (d, $J = 10.7$ Hz, 1H), 4.40 (d, $J = 10.0$ Hz, 1H), 3.95 (d, $J = 9.7$ Hz, 1H), 3.89 (t, $J = 9.2$ Hz, 1H), 3.68 (t, $J = 8.9$ Hz, 1H), 2.80 – 2.57 (m, 4H), 2.57 – 2.39 (m, 2H), 2.15 (s, 3H), 1.22 (t, $J = 7.4$ Hz, 3H).

NMR data was in accordance with previously reported values.²²⁶

Methyl 2,3,6-tri-*O*-benzyl- α -D-glucopyranoside (95)

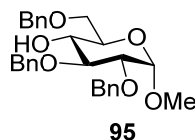

^1H NMR (400 MHz, CDCl_3) δ 7.40 – 7.26 (m, 15H), 5.01 (d, $J = 11.4$ Hz, 1H), 4.78 (d, $J = 12.1$ Hz, 1H), 4.74 (d, $J = 11.4$ Hz, 1H), 4.66 (d, $J = 12.1$ Hz, 1H), 4.63 (d, $J = 3.5$ Hz, 1H), 4.59 (d, $J = 12.2$ Hz, 1H), 4.54 (d, $J = 12.2$ Hz, 1H), 3.79 (t, $J = 9.1$ Hz, 1H), 3.74 – 3.66 (m, 3H), 3.61 (t, $J = 9.1$ Hz, 1H), 3.54 (dd, $J = 9.5, 3.5$ Hz, 1H), 3.39 (s, 3H).

NMR data was in accordance with previously reported values.²²⁷

4.4.2 General glycosylation procedure

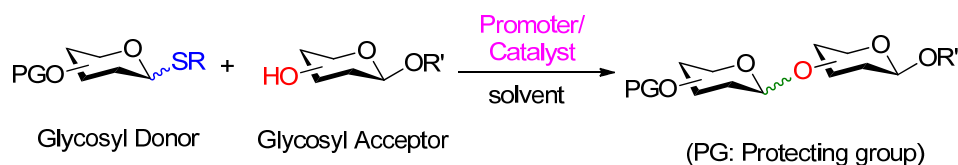

Both donor (51 μmol) and acceptor (43 μmol) were co-evaporated three times with anhydrous toluene and kept under high vacuum for 1 h. The mixture was dissolved in the indicated solvent (3 mL) followed by the addition of activated molecular sieves (AW-300). The solution was stirred for 10 min at room temperature and cooled down to the indicated temperature. DBDMH (37 μmol) and TfOH (0.522 μmol) were added and the mixture was stirred for one hour. Then the reaction was quenched with Et_3N , diluted with dichloromethane and extracted with 10% aq. $\text{Na}_2\text{S}_2\text{O}_3$ solution. The aqueous phase was washed with dichloromethane twice and the combined organic layer was dried over Na_2SO_4 , filtered and concentrated. The residue was purified by flash column chromatography to obtain pure disaccharide.

4.4.3 1,2-*Trans* glycosylation

Table 4.5: 1,2-*Trans* glycosylation activated by DBDMH with a variety of building blocks

Entry	Donor	Acceptor	Product ^a	Solvents for flash column chromatography	Yield (%)
1	30	89	107	50% ethyl acetate in hexanes	91
2	32	89	108	5% acetone in toluene	98
3	35	89	90	20-25% ethyl acetate in hexanes	92
4	37	89	109	30% ethyl acetate in hexanes	95
5	91	89	110	25% ethyl acetate in hexanes	94
6	92	89	111	25% ethyl acetate in hexanes	96
7	93	89	112	20% ethyl acetate in hexanes	91
8	94	89	113	4% acetone in toluene	39
9	30	95	114	20% acetone in toluene	60
10	32	95	115	25% ethyl acetate in hexanes	87
11	35	95	116	25% ethyl acetate in hexanes	88
12	37	95	117	28% ethyl acetate in hexanes	88

13	91	95	118	30% ethyl acetate in hexanes	89
14	92	95	119	25% ethyl acetate in hexanes	89
15	93	95	120	20% ethyl acetate in hexanes	86
16	94	95	121	30% ethyl acetate in hexanes	45

^aFmoc protecting group was cleaved during the quenching process in the presence of triethylamine.

Methyl 2-*O*-benzoyl-4,6-di-*O*-benzyl-β-D-galactopyranosyl-(1→6)-2,3,4-tri-*O*-benzyl-α-D-glucopyranoside (90)

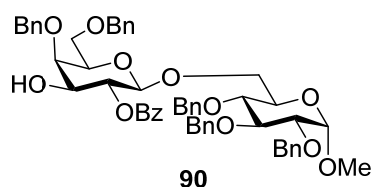

$[\alpha]_D^{25} +7.95$ (c 1.63, CHCl_3); $^1\text{H NMR}$ (400 MHz, CDCl_3) δ 8.00 (dd, $J = 8.2, 1.1$ Hz, 2H), 7.54 – 7.45 (m, 1H), 7.41 – 7.24 (m, 25H), 7.19 – 7.09 (m, 2H), 5.34 (dd, $J = 10.0, 8.0$ Hz, 1H), 4.92 (d, $J = 10.9$ Hz, 1H), 4.78 – 4.68 (m, 4H), 4.62 – 4.50 (m, 5H), 4.48 – 4.42 (m, 2H), 4.13 (d, $J = 9.1$ Hz, 1H), 3.97 (d, $J = 3.5$ Hz, 1H), 3.91 (t, $J = 9.3$ Hz, 1H), 3.83 – 3.64 (m, 6H), 3.48 – 3.34 (m, 2H), 3.19 (s, 3H), 2.44 (d, $J = 10.0$ Hz, 1H); $^{13}\text{C NMR}$ (101 MHz, CDCl_3) δ 166.7, 139.0, 138.4, 138.3, 138.2, 137.8, 133.2, 129.9 (2C), 128.7, 128.6, 128.5, 128.4 (2C), 128.2, 128.1 (2C), 128.0 (3C), 127.7 (2C), 127.6, 101.4 ($^1J_{\text{C-H}} = 168$ Hz), 97.9 ($^1J_{\text{C-H}} = 172$ Hz), 82.1, 80.0, 77.7, 75.7, 74.8, 74.0, 73.7 (2C), 73.5, 73.4, 69.7, 68.3, 68.1, 55.1; HRMS (ESI) calcd for $\text{C}_{55}\text{H}_{58}\text{O}_{12}\text{Na}$ $[\text{M}+\text{Na}]^+$ 933.3826; found: 933.3779.

Methyl 3-*O*-benzyl-6-*O*-levulinoyl-2-*N*-trichloroacetyl-β-D-glucosaminopyranosyl-(1→6)-2,3,4-tri-*O*-benzyl-α-D-glucopyranoside (107)

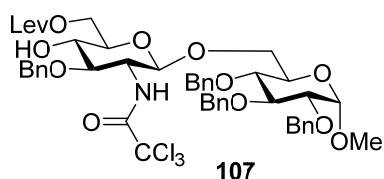

$[\alpha]_D^{25}$ -0.32 (c 1.85, CHCl_3); ^1H NMR (400 MHz, CDCl_3) δ 7.34 – 7.12 (m, 20H), 6.84 (d, $J = 7.6$ Hz, 1H), 4.90 (d, $J = 11.1$ Hz, 1H), 4.79 (d, $J = 11.1$ Hz, 1H), 4.75 – 4.64 (m, 5H), 4.56 (d, $J = 12.2$ Hz, 1H), 4.52 – 4.42 (m, 3H), 4.13 (dd, $J = 12.2, 2.1$ Hz, 1H), 4.01 – 3.84 (m, 3H), 3.69 – 3.62 (m, 1H), 3.58 (dd, $J = 10.9, 4.1$ Hz, 1H), 3.54 – 3.32 (m, 5H), 3.28 (s, 3H), 2.91 (d, $J = 4.2$ Hz, 1H), 2.66 (t, $J = 6.4$ Hz, 2H), 2.49 (t, $J = 6.4$ Hz, 2H), 2.09 (s, 3H); ^{13}C NMR (101 MHz, CDCl_3) δ 206.9, 173.6, 161.9, 139.0, 138.5, 138.2, 138.1, 128.7, 128.6, 128.5, 128.4, 128.2 (3C), 128.0, 127.9, 127.8 (2C), 127.6, 99.6 ($^1J_{\text{C-H}} = 168$ Hz), 98.1 ($^1J_{\text{C-H}} = 172$ Hz), 92.6, 82.1, 79.7, 79.1, 77.6, 75.6, 75.0, 74.9, 74.1, 73.4, 71.1, 69.6, 67.9, 63.2, 58.4, 55.4, 38.1, 29.9, 28.0; HRMS (ESI) calcd for $\text{C}_{48}\text{H}_{54}\text{Cl}_3\text{NO}_{13}\text{Na}$ $[\text{M}+\text{Na}]^+$ 980.2558; found: 980.2511.

Methyl 2,3-di-*O*-benzoyl-6-*O*-benzyl- β -D-glucopyranosyl-(1 \rightarrow 6)-2,3,4-tri-*O*-benzyl- α -D-glucopyranoside (108)

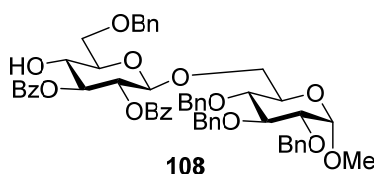

$[\alpha]_D^{25}$ +37.6 (c 1.93, CHCl_3); ^1H NMR (400 MHz, CDCl_3) δ 7.88 (dd, $J = 8.3, 1.2$ Hz, 2H), 7.79 (dd, $J = 8.3, 1.2$ Hz, 2H), 7.48 – 7.37 (m, 1H), 7.28 – 7.07 (m, 23H), 7.01 – 6.91 (m, 2H), 5.47 – 5.34 (m, 2H), 4.81 (d, $J = 10.9$ Hz, 1H), 4.69 – 4.56 (m, 3H), 4.56 – 4.47 (m, 3H), 4.43 – 4.35 (m, 2H), 4.19 (d, $J = 11.1$ Hz, 1H), 4.05 (d, $J = 8.8$ Hz, 1H), 3.86 (t, $J = 9.0$ Hz, 1H), 3.83 – 3.75 (m, 3H), 3.67 – 3.56 (m, 3H), 3.35 (dd, $J = 9.7, 3.5$ Hz, 1H), 3.32 – 3.27 (m, 1H), 3.13 (s, 3H); ^{13}C NMR (101 MHz, CDCl_3) δ 167.2, 165.2, 138.9, 138.3, 137.7, 133.5, 133.2, 130.1, 129.8, 129.4, 129.1, 128.6 (2C), 128.5, 128.4 (2C), 128.2 (2C), 128.1, 128.0, 127.9, 127.7, 127.6, 101.2 ($^1J_{\text{C-H}} = 164$ Hz), 98.1 ($^1J_{\text{C-H}} = 172$ Hz), 82.0, 79.8, 77.5, 76.6, 75.7, 74.8, 74.6, 73.9, 73.5, 71.5 (2C), 70.4, 69.6, 68.3, 55.1; HRMS (ESI) calcd for $\text{C}_{55}\text{H}_{56}\text{O}_{13}\text{Na}$ $[\text{M}+\text{Na}]^+$ 947.3619; found: 947.3572.

Methyl 2,3-di-*O*-benzoyl-4,6-*O*-benzylidene- β -D-galactopyranosyl-(1 \rightarrow 6)-2,3,4-tri-*O*-benzyl- α -D-glucopyranoside (109)

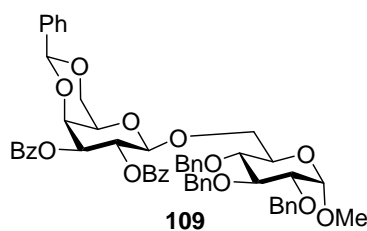

$[\alpha]_D^{25} +94.2$ (c 1.15, CHCl_3); $^1\text{H NMR}$ (400 MHz, CDCl_3) δ 7.95 – 7.80 (m, 4H), 7.46 – 7.07 (m, 26H), 5.83 (dd, $J = 10.4, 8.0$ Hz, 1H), 5.46 (s, 1H), 5.26 (dd, $J = 10.4, 3.6$ Hz, 1H), 4.82 (d, $J = 10.9$ Hz, 1H), 4.68 – 4.58 (m, 3H), 4.56 – 4.45 (m, 3H), 4.39 – 4.23 (m, 3H), 4.12 (d, $J = 9.1$ Hz, 1H), 4.06 – 3.98 (m, 1H), 3.82 (t, $J = 9.2$ Hz, 1H), 3.71 – 3.59 (m, 2H), 3.52 (s, 1H), 3.34 – 3.22 (m, 2H), 3.10 (s, 3H); $^{13}\text{C NMR}$ (101 MHz, CDCl_3) δ 166.4, 165.2, 139.0, 138.4, 138.3, 137.6, 133.5, 133.1, 130.1, 129.8 (2C), 129.2, 129.0, 128.5 (2C), 128.4 (2C), 128.2 (2C), 128.0 (2C), 127.8, 127.7, 127.6, 126.4, 101.8 ($^1J_{\text{C-H}} = 156$ Hz), 100.9, 97.8 ($^1J_{\text{C-H}} = 168$ Hz), 82.1, 80.0, 77.8, 75.6, 74.8, 73.7, 73.4, 72.9, 69.8, 69.2, 69.0, 68.2, 66.7, 55.1; HRMS (ESI) calcd for $\text{C}_{55}\text{H}_{54}\text{O}_{13}\text{Na}$ $[\text{M}+\text{Na}]^+$ 945.3462; found: 945.3466.

Methyl 3,4,6-tri-*O*-benzyl-2-*O*-levulinoyl- β -D-glucopyranosyl-(1 \rightarrow 6)-2,3,4-tri-*O*-benzyl- α -D-glucopyranoside (110)

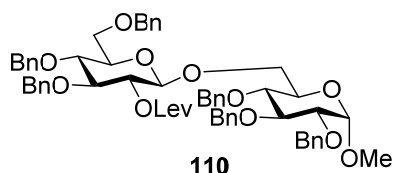

$[\alpha]_D^{25} +13.1$ (c 2.02, CHCl_3); $^1\text{H NMR}$ (400 MHz, CDCl_3) δ 7.29 – 7.17 (m, 28H), 7.09 (dd, $J = 7.1, 2.5$ Hz, 2H), 4.97 (td, $J = 7.9, 2.3$ Hz, 1H), 4.89 (d, $J = 10.9$ Hz, 1H), 4.76 (d, $J = 10.9$ Hz, 1H), 4.74 – 4.66 (m, 4H), 4.62 (d, $J = 11.4$ Hz, 1H), 4.58 (d, $J = 12.1$ Hz, 1H), 4.53 – 4.41 (m, 5H), 4.32 (d, $J = 8.0$ Hz, 1H), 4.00 (dd, $J = 10.7, 1.6$ Hz, 1H), 3.89 (t, $J = 9.3$ Hz, 1H), 3.73 – 3.64 (m, 1H), 3.64 – 3.53 (m, 5H), 3.45 (dd, $J = 9.6, 3.5$ Hz, 1H), 3.43 – 3.33 (m, 2H), 3.27 (s, 3H), 2.59 – 2.50 (m, 1H), 2.49 – 2.38 (m, 1H), 2.34 (td, $J = 6.8, 3.3$ Hz, 2H), 1.96 (s, 3H); $^{13}\text{C NMR}$ (101 MHz, CDCl_3) δ 206.1, 171.4, 138.9, 138.4, 138.3, 138.2, 138.0, 128.6, 128.5, 128.5, 128.2, 128.1 (2C), 128.0 (2C), 127.9, 127.8 (2C), 127.7, 101.0 ($^1J_{\text{C-H}} = 156$ Hz), 98.1 ($^1J_{\text{C-H}} = 168$ Hz), 83.1, 82.1, 80.0, 78.1,

77.9, 75.8, 75.5, 75.1, 74.9, 73.6, 73.5 (2C), 69.9, 68.9, 68.1, 55.2, 37.9, 29.9, 28.1; HRMS (ESI) calcd for $C_{60}H_{66}O_{13}Na$ $[M+Na]^+$ 1017.4401; found: 1017.4335.

Methyl 2-*O*-benzoyl-3,4-di-*O*-benzyl- α -D-mannopyranosyl-(1 \rightarrow 6)-2,3,4-tri-*O*-benzyl- α -D-glucopyranoside (111)

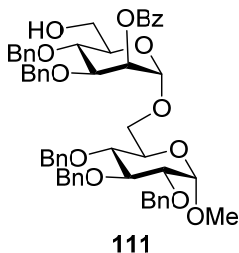

$[\alpha]_D^{25} +21.3$ (c 1.77, $CHCl_3$); 1H NMR (400 MHz, $CDCl_3$) δ 8.11 – 8.02 (m, 2H), 7.63 – 7.54 (m, 1H), 7.46 (t, $J = 7.7$ Hz, 2H), 7.40 – 7.15 (m, 25H), 5.60 (dd, $J = 3.1, 1.9$ Hz, 1H), 5.02 – 4.94 (m, 2H), 4.93 – 4.86 (m, 2H), 4.79 (d, $J = 11.4$ Hz, 2H), 4.75 (d, $J = 11.6$ Hz, 1H), 4.69 (d, $J = 12.1$ Hz, 1H), 4.65 – 4.58 (m, 2H), 4.55 (d, $J = 11.6$ Hz, 1H), 4.49 (d, $J = 11.2$ Hz, 1H), 4.05 – 3.90 (m, 3H), 3.79 (dd, $J = 11.2, 4.6$ Hz, 1H), 3.75 – 3.60 (m, 5H), 3.56 (dd, $J = 9.6, 3.5$ Hz, 1H), 3.44 (dd, $J = 9.9, 8.9$ Hz, 1H), 3.32 (s, 3H); ^{13}C NMR (101 MHz, $CDCl_3$) δ 165.7, 138.8, 138.5, 138.3, 138.2, 137.9, 133.4, 130.0 (2C), 128.6 (2C), 128.5 (2C), 128.3, 128.2 (3C), 128.1 (2C), 127.8 (3C), 127.7, 98.2 ($^1J_{C-H} = 176$ Hz), 98.0 ($^1J_{C-H} = 172$ Hz), 82.2, 80.2, 77.7, 77.6, 75.9, 75.3, 75.1, 74.0, 73.5, 72.1, 71.5, 69.8, 69.0, 66.3, 62.1, 55.3; HRMS (ESI) calcd for $C_{55}H_{58}O_{12}Na$ $[M+Na]^+$ 933.3826; found: 933.3831.

Methyl 2-*O*-benzoyl-4-*O*-benzyl- α -L-rhamnopyranosyl-(1 \rightarrow 6)-2,3,4-tri-*O*-benzyl- α -D-glucopyranoside (112)

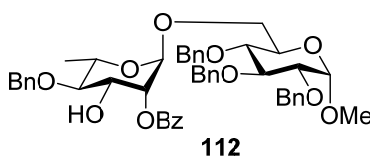

$[\alpha]_D^{25} +30.9$ (c 1.36, CHCl_3); $^1\text{H NMR}$ (400 MHz, CDCl_3) δ 8.05 – 8.00 (m, 2H), 7.63 – 7.53 (m, 1H), 7.49 – 7.43 (m, 2H), 7.38 – 7.16 (m, 20H), 5.30 (dd, $J = 3.5, 1.7$ Hz, 1H), 4.98 (d, $J = 10.9$ Hz, 1H), 4.90 (d, $J = 11.1$ Hz, 1H), 4.84 – 4.79 (m, 2H), 4.79 – 4.75 (m, 2H), 4.72 (d, $J = 11.1$ Hz, 1H), 4.66 (d, $J = 12.1$ Hz, 1H), 4.60 – 4.53 (m, 2H), 4.18 (dd, $J = 9.4, 3.5$ Hz, 1H), 3.98 (t, $J = 9.2$ Hz, 1H), 3.86 – 3.76 (m, 2H), 3.73 (ddd, $J = 10.1, 5.3, 1.7$ Hz, 1H), 3.55 – 3.48 (m, 2H), 3.46 (d, $J = 9.3$ Hz, 1H), 3.42 (d, $J = 9.6$ Hz, 1H), 3.37 (s, 3H), 1.33 (d, $J = 6.3$ Hz, 3H); $^{13}\text{C NMR}$ (101 MHz, CDCl_3) δ 166.3, 138.8, 138.3 (2C), 138.2, 133.5, 130.0, 129.9, 128.7, 128.6 (3C), 128.5, 128.3, 128.2, 128.1 (2C), 127.9, 127.7, 98.0 ($^1J_{C-H} = 172$ Hz), 97.8 ($^1J_{C-H} = 172$ Hz), 82.2, 81.8, 80.1, 77.8, 75.9, 75.4, 75.2, 73.5, 73.3, 70.6, 70.1, 67.6, 66.5, 55.3, 18.2; HRMS (ESI) calcd for $\text{C}_{48}\text{H}_{52}\text{O}_{11}\text{Na}$ $[\text{M}+\text{Na}]^+$ 827.3407; found: 827.3413.

Methyl (benzyl 3,4-di-*O*-benzyl-2-*O*-levulinoyl- β -D-glucopyranosyluronate)-(1 \rightarrow 6)-2,3,4-tri-*O*-benzyl- α -D-glucopyranoside (113)

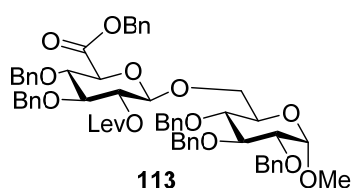

$[\alpha]_D^{25} +2.79$ (c 1.28, CHCl_3); $^1\text{H NMR}$ (400 MHz, CDCl_3) δ 7.27 – 7.15 (m, 28H), 7.02 (dd, $J = 6.5, 3.0$ Hz, 2H), 5.12 – 5.03 (m, 2H), 4.98 (dd, $J = 9.0, 7.7$ Hz, 1H), 4.89 (d, $J = 10.9$ Hz, 1H), 4.76 (d, $J = 10.9$ Hz, 1H), 4.73 – 4.63 (m, 3H), 4.62 – 4.55 (m, 3H), 4.50 (d, $J = 3.5$ Hz, 1H), 4.45 (d, $J = 11.0$ Hz, 1H), 4.41 – 4.33 (m, 2H), 3.95 (dd, $J = 10.7, 1.5$ Hz, 1H), 3.92 – 3.84 (m, 3H), 3.71 – 3.63 (m, 1H), 3.55 (td, $J = 11.1, 10.0, 4.9$ Hz, 2H), 3.44 (dd, $J = 9.6, 3.5$ Hz, 1H), 3.36 – 3.28 (m, 1H), 3.25 (s, 3H), 2.59 – 2.51 (m, 1H), 2.51 – 2.40 (m, 1H), 2.37 – 2.28 (m, 2H), 1.97 (s, 3H); $^{13}\text{C NMR}$ (101 MHz, CDCl_3) δ 206.0, 171.3, 168.1, 138.9, 138.3, 138.0, 137.8, 135.1, 128.7, 128.6 (4C), 128.5 (2C), 128.2, 128.1 (2C), 128.0 (2C), 127.9 (3C), 127.7, 101.4 ($^1J_{C-H} = 164$ Hz), 98.0 ($^1J_{C-H} = 172$ Hz), 82.1, 80.1, 79.3, 77.9, 75.8, 75.1, 75.0, 74.9 (2C), 73.5, 73.1, 69.9, 68.4, 67.5, 55.2, 37.8, 29.9, 28.0; HRMS (ESI) calcd for $\text{C}_{60}\text{H}_{64}\text{O}_{14}\text{Na}$ $[\text{M}+\text{Na}]^+$ 1031.4194; found: 1031.4114.

Methyl 3-*O*-benzyl-6-*O*-levulinoyl-2-*N*-trichloroacetyl- β -D-glucosaminopyranosyl-(1 \rightarrow 4)-2,3,6-tri-*O*-benzyl- α -D-glucopyranoside (114)

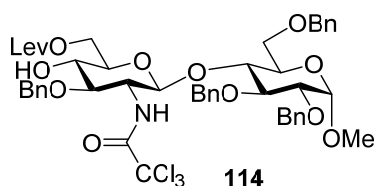

$[\alpha]_D^{25}$ -22.2 (c 1.51, CHCl_3); ^1H NMR (400 MHz, CDCl_3) δ 7.32 – 7.18 (m, 20H), 6.42 (d, $J = 8.1$ Hz, 1H), 4.92 (d, $J = 11.4$ Hz, 1H), 4.74 (d, $J = 11.2$ Hz, 1H), 4.70 – 4.59 (m, 4H), 4.57 (d, $J = 8.2$ Hz, 1H), 4.53 – 4.47 (m, 2H), 4.44 – 4.34 (m, 2H), 3.96 (dd, $J = 12.2$, 2.1 Hz, 1H), 3.88 (t, $J = 9.3$ Hz, 1H), 3.76 (t, $J = 9.2$ Hz, 1H), 3.63 – 3.36 (m, 7H), 3.27 (s, 3H), 3.09 (dt, $J = 9.5$, 3.1 Hz, 1H), 2.99 (d, $J = 4.2$ Hz, 1H), 2.68 – 2.51 (m, 2H), 2.47 – 2.29 (m, 2H), 2.06 (s, 3H); ^{13}C NMR (101 MHz, CDCl_3) δ 207.0, 173.8, 161.7, 139.7, 138.4, 138.2, 138.0, 128.8, 128.7 (2C), 128.5, 128.3, 128.2, 128.1, 128.0, 127.9, 127.6, 127.2, 98.7 ($^1J_{\text{C-H}} = 164$ Hz), 98.5 ($^1J_{\text{C-H}} = 168$ Hz), 92.7, 80.4, 79.4, 79.0, 76.0, 75.3, 74.7, 73.9, 73.6, 73.5, 71.1, 69.6, 68.4, 63.2, 58.6, 55.5, 38.1, 29.9, 28.0; HRMS (ESI) calcd for $\text{C}_{48}\text{H}_{54}\text{Cl}_3\text{NO}_{13}\text{Na}$ $[\text{M}+\text{Na}]^+$ 980.2558; found: 980.2564.

Methyl 2,3-di-*O*-benzoyl-6-*O*-benzyl- β -D-glucopyranosyl-(1 \rightarrow 4)-2,3,6-tri-*O*-benzyl- α -D-glucopyranoside (115)

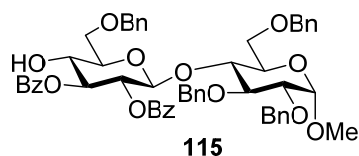

$[\alpha]_D^{25}$ +20.2 (c 1.44, CHCl_3); ^1H NMR (400 MHz, CDCl_3) δ 7.97 – 7.90 (m, 2H), 7.87 – 7.79 (m, 2H), 7.51 – 7.21 (m, 26H), 5.32 (dd, $J = 9.9$, 7.8 Hz, 1H), 5.25 (dd, $J = 9.9$, 8.9 Hz, 1H), 4.99 (d, $J = 11.3$ Hz, 1H), 4.81 (d, $J = 11.3$ Hz, 1H), 4.75 (d, $J = 12.2$ Hz, 1H), 4.70 – 4.62 (m, 2H), 4.59 (d, $J = 12.2$ Hz, 1H), 4.52 (d, $J = 3.7$ Hz, 1H), 4.44 (d, $J = 11.9$ Hz, 1H), 4.38 (d, $J = 11.9$ Hz, 1H), 4.28 (d, $J = 12.1$ Hz, 1H), 3.92 – 3.78 (m, 3H), 3.64 – 3.50 (m, 3H), 3.49 – 3.38 (m, 3H), 3.35 (dd, $J = 10.7$, 2.0 Hz, 1H), 3.25 (s, 3H); ^{13}C NMR (101 MHz, CDCl_3) δ 166.9, 165.1, 139.7, 138.4, 137.9, 137.7, 133.4, 133.3, 130.0, 129.8,

129.4, 129.3, 128.9, 128.6, 128.5 (3C), 128.3, 128.2, 128.0, 127.9, 127.8, 127.6, 127.2, 100.4 ($^1J_{C-H} = 164$ Hz), 98.5 ($^1J_{C-H} = 172$ Hz), 80.2, 79.0, 77.1, 76.4, 75.3, 73.9, 73.7 (3C), 72.3, 72.1, 70.9, 69.6, 67.7, 55.4; HRMS (ESI) calcd for $C_{55}H_{56}O_{13}Na$ $[M+Na]^+$ 947.3619; found: 947.3624.

Methyl 2-*O*-benzoyl-4,6-di-*O*-benzyl- β -D-galactopyranosyl-(1 \rightarrow 4)-2,3,6-tri-*O*-benzyl- α -D-glucopyranoside (116)

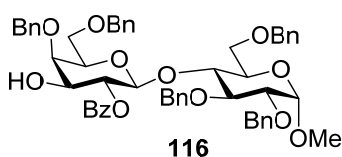

$[\alpha]_D^{25} +2.89$ (c 1.55, $CHCl_3$); 1H NMR (400 MHz, $CDCl_3$) δ 7.84 (dd, $J = 8.2, 1.1$ Hz, 2H), 7.52 – 7.43 (m, 1H), 7.39 – 7.12 (m, 27H), 5.12 (dd, $J = 10.0, 8.0$ Hz, 1H), 4.94 (d, $J = 10.9$ Hz, 1H), 4.71 (d, $J = 11.8$ Hz, 2H), 4.63 (d, $J = 11.8$ Hz, 1H), 4.59 (d, $J = 11.8$ Hz, 1H), 4.57 (d, $J = 5.0$ Hz, 1H), 4.55 – 4.49 (m, 2H), 4.45 (d, $J = 3.7$ Hz, 1H), 4.33 (d, $J = 11.7$ Hz, 1H), 4.27 – 4.18 (m, 2H), 3.86 – 3.70 (m, 3H), 3.59 (dd, $J = 10.7, 3.3$ Hz, 1H), 3.52 – 3.29 (m, 7H), 3.20 (s, 3H), 2.18 (d, $J = 10.3$ Hz, 1H); ^{13}C NMR (101 MHz, $CDCl_3$) δ 166.5, 139.7, 138.5, 138.3, 138.1, 138.0, 133.3, 129.9 (2C), 128.7, 128.6 (2C), 128.5 (2C), 128.2, 128.1 (2C), 128.0, 127.9 (3C), 127.2, 100.4 ($^1J_{C-H} = 168$ Hz), 98.5 ($^1J_{C-H} = 172$ Hz), 80.2, 79.2, 76.7, 75.6, 75.4, 74.8, 73.7, 73.6, 73.4, 73.3, 69.7, 68.1, 67.9, 55.4; HRMS (ESI) calcd for $C_{55}H_{58}O_{12}Na$ $[M+Na]^+$ 933.3826; found: 933.3832.

Methyl 2,3-di-*O*-benzoyl-4,6-*O*-benzylidene- β -D-galactopyranosyl-(1 \rightarrow 4)-2,3,6-tri-*O*-benzyl- α -D-glucopyranoside (117)

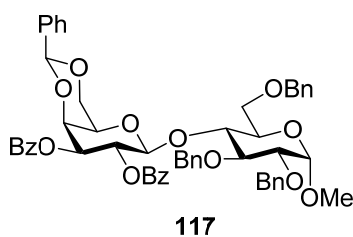

$[\alpha]_D^{25} +58.6$ (c 1.77, CHCl_3); $^1\text{H NMR}$ (400 MHz, CDCl_3) δ 7.90 – 7.84 (m, 2H), 7.84 – 7.77 (m, 2H), 7.40 – 7.14 (m, 26H), 5.72 (dd, $J = 10.4, 8.1$ Hz, 1H), 5.42 (s, 1H), 5.08 (d, $J = 10.8$ Hz, 1H), 5.00 (dd, $J = 10.4, 3.7$ Hz, 1H), 4.77 (d, $J = 10.8$ Hz, 1H), 4.73 (d, $J = 12.2$ Hz, 1H), 4.69 (d, $J = 8.1$ Hz, 1H), 4.60 – 4.50 (m, 2H), 4.45 (d, $J = 3.6$ Hz, 1H), 4.40 (d, $J = 3.5$ Hz, 1H), 4.22 – 4.15 (m, 2H), 3.90 – 3.82 (m, 3H), 3.59 (dd, $J = 10.7, 3.3$ Hz, 1H), 3.48 – 3.40 (m, 2H), 3.33 (dd, $J = 10.7, 1.7$ Hz, 1H), 3.20 (s, 3H), 3.18 (s, 1H); $^{13}\text{C NMR}$ (101 MHz, CDCl_3) δ 166.3, 165.1, 139.4, 138.5, 138.2, 137.8, 133.4, 133.3, 130.0, 129.8, 129.6, 129.3, 128.9, 128.7, 128.5 (2C), 128.3, 128.2 (3C), 128.1, 127.9, 127.3, 126.4, 100.9 ($^1J_{\text{C-H}} = 160$ Hz), 98.4 ($^1J_{\text{C-H}} = 168$ Hz), 80.4, 79.3, 77.6, 75.9, 73.7, 73.6, 73.1, 70.0, 69.6, 68.8, 68.1, 66.6, 55.4; HRMS (ESI) calcd for $\text{C}_{55}\text{H}_{54}\text{O}_{13}\text{Na}$ $[\text{M}+\text{Na}]^+$ 945.3462; found: 945.3466.

Methyl 3,4,6-tri-*O*-benzyl-2-*O*-levulinoyl- β -D-glucopyranosyl-(1 \rightarrow 4)-2,3,6-tri-*O*-benzyl- α -D-glucopyranoside (118)

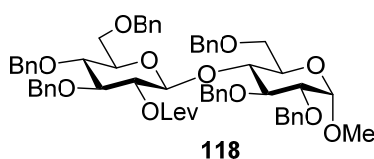

$[\alpha]_D^{25} +10.1$ (c 1.88, CHCl_3); $^1\text{H NMR}$ (400 MHz, CDCl_3) δ 7.29 – 7.10 (m, 30H), 4.98 (d, $J = 11.4$ Hz, 1H), 4.85 (dd, $J = 9.5, 8.1$ Hz, 1H), 4.71 – 4.62 (m, 5H), 4.57 – 4.48 (m, 3H), 4.45 (d, $J = 11.0$ Hz, 1H), 4.39 – 4.30 (m, 3H), 4.25 (d, $J = 12.1$ Hz, 1H), 3.84 – 3.70 (m, 3H), 3.65 – 3.51 (m, 4H), 3.46 – 3.32 (m, 3H), 3.29 (s, 3H), 3.22 (ddd, $J = 9.8, 4.5, 1.7$ Hz, 1H), 2.65 – 2.57 (m, 1H), 2.57 – 2.46 (m, 1H), 2.39 – 2.29 (m, 1H), 2.27 – 2.17 (m, 1H), 2.05 (s, 3H); $^{13}\text{C NMR}$ (101 MHz, CDCl_3) δ 206.2, 171.4, 139.8, 138.5 (3C), 138.2, 138.0, 128.7, 128.5, 128.4 (2C), 128.3, 128.2, 128.1, 128.0 (2C), 127.9, 127.8, 127.7, 127.5, 127.1, 100.2 ($^1J_{\text{C-H}} = 164$ Hz), 98.5 ($^1J_{\text{C-H}} = 172$ Hz), 83.2, 80.4, 79.0, 78.2, 75.5, 75.4, 75.1, 74.9, 74.2, 73.8, 73.7, 73.5, 69.9, 68.9, 68.1, 55.4, 37.8, 30.0, 28.0; HRMS (ESI) calcd for $\text{C}_{60}\text{H}_{66}\text{O}_{13}\text{Na}$ $[\text{M}+\text{Na}]^+$ 1017.4401; found: 1017.4410.

Methyl 2-*O*-benzoyl-3,4-di-*O*-benzyl- α -D-mannopyranosyl-(1 \rightarrow 4)-2,3,6-tri-*O*-benzyl- α -D-glucopyranoside (119)

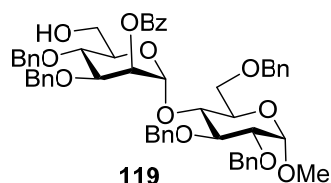

$[\alpha]_D^{25}$ -3.44 (c 1.68, CHCl_3); ^1H NMR (400 MHz, CDCl_3) δ 8.02 – 7.91 (m, 2H), 7.62 – 7.51 (m, 1H), 7.44 (t, $J = 7.7$ Hz, 2H), 7.35 – 7.17 (m, 22H), 7.14 – 7.01 (m, 3H), 5.66 (t, $J = 2.4$ Hz, 1H), 5.50 (d, $J = 1.9$ Hz, 1H), 5.02 (d, $J = 10.9$ Hz, 1H), 4.86 (d, $J = 10.9$ Hz, 1H), 4.76 (d, $J = 10.9$ Hz, 1H), 4.73 – 4.67 (m, 2H), 4.61 – 4.55 (m, 3H), 4.53 (d, $J = 1.5$ Hz, 2H), 4.45 (d, $J = 11.3$ Hz, 1H), 4.01 – 3.91 (m, 2H), 3.87 (td, $J = 9.2, 2.9$ Hz, 2H), 3.76 – 3.60 (m, 6H), 3.53 (dd, $J = 9.5, 3.5$ Hz, 1H), 3.38 (s, 3H); ^{13}C NMR (101 MHz, CDCl_3) δ 165.4, 138.4, 138.3, 138.1, 138.0, 133.3, 130.0 (2C), 128.6, 128.5 (2C), 128.4 (2C), 128.3 (2C), 128.1, 128.0, 127.9, 127.7 (4C), 127.5, 99.0 ($^1J_{\text{C-H}} = 176$ Hz), 98.0 ($^1J_{\text{C-H}} = 172$ Hz), 81.9, 80.3, 78.2, 75.6, 75.4, 75.0, 74.0, 73.7, 73.4, 72.9, 71.6, 69.8, 69.3, 68.8, 62.0, 55.5; HRMS (ESI) calcd for $\text{C}_{55}\text{H}_{58}\text{O}_{12}\text{Na}$ $[\text{M}+\text{Na}]^+$ 933.3826; found: 933.3833.

Methyl 2-*O*-benzoyl-4-*O*-benzyl- α -L-rhamnopyranosyl-(1 \rightarrow 4)-2,3,6-tri-*O*-benzyl- α -D-glucopyranoside (120)

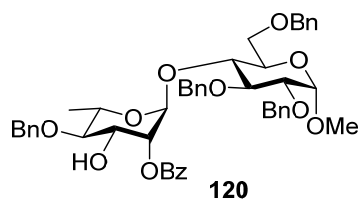

$[\alpha]_D^{25}$ +17.2 (c 1.26, CHCl_3); ^1H NMR (400 MHz, CDCl_3) δ 7.98 (dd, $J = 8.3, 1.4$ Hz, 2H), 7.59 – 7.53 (m, 1H), 7.46 – 7.41 (m, 2H), 7.35 – 7.12 (m, 20H), 5.23 (dd, $J = 3.4, 1.7$ Hz, 1H), 5.09 – 5.03 (m, 2H), 4.75 – 4.69 (m, 3H), 4.66 (d, $J = 11.3$ Hz, 1H), 4.60 – 4.52 (m, 3H), 4.49 (d, $J = 11.9$ Hz, 1H), 4.14 (dd, $J = 9.5, 3.4$ Hz, 1H), 3.99 (dd, $J = 9.6, 6.2$ Hz, 1H), 3.92 – 3.76 (m, 3H), 3.73 – 3.64 (m, 2H), 3.58 (dd, $J = 9.2, 3.6$ Hz, 1H), 3.42 – 3.36

(m, 1H), 3.35 (s, 3H), 0.97 (d, $J = 6.2$ Hz, 3H); ^{13}C NMR (101 MHz, CDCl_3) δ 166.4, 138.9, 138.4, 138.1, 137.9, 133.5, 130.0, 129.9, 128.6 (2C), 128.5, 128.4, 128.3 (2C), 128.2, 128.1 (2C), 128.0 (3C), 127.6, 127.4, 98.1 ($^1J_{\text{C-H}} = 172$ Hz), 97.2 ($^1J_{\text{C-H}} = 176$ Hz), 82.0, 80.5, 79.9, 75.7, 75.0, 74.8, 73.7, 73.5, 73.4, 70.2, 70.1, 68.5, 68.1, 55.4, 18.0; HRMS (ESI) calcd for $\text{C}_{48}\text{H}_{52}\text{O}_{11}\text{Na}$ $[\text{M}+\text{Na}]^+$ 827.3407; found: 827.3409.

Methyl (benzyl 3,4-di-*O*-benzyl-2-*O*-levulinoyl- β -D-glucopyranosyluronate)-(1 \rightarrow 4)-2,3,6-tri-*O*-benzyl- α -D-glucopyranoside (121)

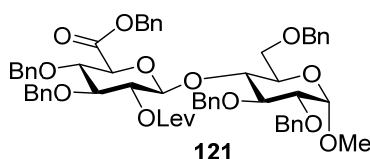

$[\alpha]_{\text{D}}^{25}$ -7.40 (c 0.84, CHCl_3); ^1H NMR (400 MHz, CDCl_3) δ 7.45 – 7.40 (m, 2H), 7.36 – 7.25 (m, 26H), 7.15 – 7.10 (m, 2H), 5.08 – 4.94 (m, 4H), 4.80 – 4.69 (m, 4H), 4.67 – 4.58 (m, 4H), 4.50 (d, $J = 8.1$ Hz, 1H), 4.46 – 4.40 (m, 2H), 3.96 – 3.77 (m, 5H), 3.71 (dt, $J = 9.8, 1.8$ Hz, 1H), 3.64 (dd, $J = 10.9, 1.9$ Hz, 1H), 3.50 (dd, $J = 9.2, 3.7$ Hz, 1H), 3.43 (t, $J = 9.1$ Hz, 1H), 3.40 (s, 3H), 2.79 – 2.68 (m, 1H), 2.65 – 2.54 (m, 1H), 2.48 – 2.37 (m, 1H), 2.33 – 2.25 (m, 1H), 2.15 (s, 3H); ^{13}C NMR (101 MHz, CDCl_3) δ 206.1, 171.2, 168.0, 139.5, 138.5, 138.2, 137.9, 137.8, 135.2, 128.8, 128.7 (2C), 128.6 (2C), 128.5, 128.4 (2C), 128.3, 128.2 (2C), 128.1 (3C), 127.9, 127.8 (2C), 127.7, 127.2, 100.6 ($^1J_{\text{C-H}} = 164$ Hz), 98.5 ($^1J_{\text{C-H}} = 172$ Hz), 82.1, 80.2, 79.7, 79.1, 77.3, 75.6, 75.0, 74.9, 74.6, 73.8, 73.7, 73.5, 69.7, 67.9, 67.3, 55.4, 37.8, 30.0, 27.9; HRMS (ESI) calcd for $\text{C}_{60}\text{H}_{64}\text{O}_{14}\text{Na}$ $[\text{M}+\text{Na}]^+$ 1031.4194; found: 1031.4199.

4.4.4 1,2-*Cis* glycosylation

Table 4.6: 1,2-*Cis* glycosylation activated by DBDMH

Entry	Donor	Solvent	T (°C)	Product	Yield (%)	α/β ratio
1	96	DCM/Et ₂ O	-78	122	94	1:1.4
2	96	DCM	-78	122	94	1:2.7

3	96	DCM/MeCN	-78	122	93	1:11.7
4	96	DCM	-40	122	67	1:1.3
5	97	DCM	-78	123	72	4.6:1
6	97	DCM	-40	123	50	11.8:1
7	98	DCM	-78	124	76	1:1.1
8	98	DCM	-40	124	69	1:1

Methyl 2,3,4,6-tetra-*O*-benzyl-D-galactopyranosyl-(1→6)-2,3,4-tri-*O*-benzyl- α -D-glucopyranoside (122)

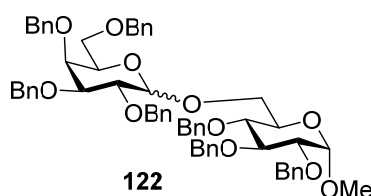

Purification: flash column chromatography with 15% ethyl acetate in hexanes. ^1H NMR (400 MHz, CDCl_3) δ 7.41 – 7.19 (m, 35H), 5.04 – 4.93 (m, 3H), 4.89 (d, $J = 12.0$ Hz, 0.5H), 4.85 – 4.66 (m, 6.5H), 4.64 – 4.51 (m, 3.5H), 4.49 – 4.37 (m, 2H), 4.34 (d, $J = 7.7$ Hz, 0.5H), 4.18 (dd, $J = 10.8, 2.0$ Hz, 0.5H), 4.04 – 3.73 (m, 6H), 3.67 – 3.42 (m, 5.5H), 3.33 (d, $J = 1.9$ Hz, 3H); ^{13}C NMR (101 MHz, CDCl_3) δ 139.0, 138.9, 138.6, 138.5, 138.3 (2C), 138.2, 138.0, 128.6, 128.5 (4C), 128.4 (3C), 128.3 (2C), 128.1 (2C), 128.0 (2C), 127.9, 127.8 (3C), 127.7, 127.6 (2C), 127.5, 104.3 ($^1J_{\text{C-H}} = 160$ Hz), 98.1 ($^1J_{\text{C-H}} = 168$ Hz), 98.0 (2C, $^1J_{\text{C-H}} = 172$ Hz), 82.4, 82.2, 82.1, 80.3, 80.0, 79.4, 78.4, 78.2, 78.1, 76.6, 75.8 (2C), 75.3, 75.2, 75.0, 74.9, 74.7, 73.6 (2C), 73.5 (2C), 73.0, 72.9, 72.7, 70.4, 70.0, 69.5, 69.0, 68.7 (2C), 66.5, 55.3, 55.2; HRMS (ESI) calcd for $\text{C}_{62}\text{H}_{66}\text{O}_{11}\text{Na}$ $[\text{M}+\text{Na}]^+$ 1009.4503; found: 1009.4510.

Methyl 4-*O*-benzoyl-2,3,6-tri-*O*-benzyl-D-galactopyranosyl-(1→6)-2,3,4-tri-*O*-benzyl- α -D-glucopyranoside (123)

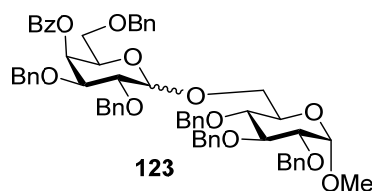

Purification: flash column chromatography with 17% ethyl acetate in hexanes. ^1H NMR (400 MHz, CDCl_3) δ 8.11 – 7.94 (m, 2H), 7.56 (t, $J = 7.4$ Hz, 1H), 7.51 – 7.02 (m, 32H), 5.79 (d, $J = 3.5$ Hz, 1H), 5.06 (d, $J = 3.5$ Hz, 1H), 4.96 (d, $J = 10.7$ Hz, 1H), 4.85 – 4.42 (m, 11H), 4.40 – 4.30 (m, 1H), 4.17 (t, $J = 6.5$ Hz, 1H), 4.05 – 3.93 (m, 2H), 3.88 (dd, $J = 10.0, 3.5$ Hz, 1H), 3.82 – 3.67 (m, 3H), 3.62 – 3.39 (m, 4H), 3.34 – 3.25 (m, 3H); ^{13}C NMR (101 MHz, CDCl_3) δ 165.9, 139.0, 138.8, 138.5, 138.3, 138.2, 137.9, 133.1, 130.2, 130.0, 128.6 (2C), 128.5 (2C), 128.4 (3C), 128.3 (2C), 128.2, 128.1 (3C), 128.0, 127.9 (2C), 127.8, 127.7 (2C), 127.6, 127.5, 104.5 ($^1J_{\text{C-H}} = 160$ Hz), 98.2 ($^1J_{\text{C-H}} = 168$ Hz), 98.1 ($^1J_{\text{C-H}} = 172$ Hz), 98.0 ($^1J_{\text{C-H}} = 172$ Hz), 82.2, 80.2, 79.9, 79.6, 78.8, 78.1, 78.0, 75.8, 75.6, 75.4, 75.1, 75.0, 73.8, 73.6, 73.5, 73.0, 72.5, 72.0, 71.6, 70.4, 70.1, 68.8, 68.7, 68.3, 68.1, 67.4, 66.4, 55.4, 55.2; HRMS (ESI) calcd for $\text{C}_{62}\text{H}_{64}\text{O}_{12}\text{Na}$ $[\text{M}+\text{Na}]^+$ 1023.4295; found: 1023.4296.

Methyl 4,6-di-O-benzoyl-2,3-di-O-benzyl-D-glucopyranosyl-(1→6)-2,3,4-tri-O-benzyl- α -D-glucopyranoside (124)

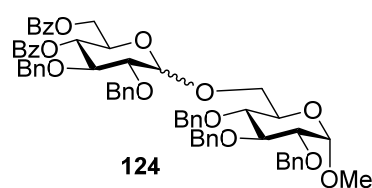

Purification: flash column chromatography with 18% ethyl acetate in hexanes. ^1H NMR (400 MHz, CDCl_3) δ 8.04 – 7.92 (m, 4H), 7.62 – 7.50 (m, 2H), 7.45 – 7.25 (m, 23H), 7.21 (dd, $J = 7.6, 1.9$ Hz, 1H), 7.16 – 7.07 (m, 5H), 5.49 – 5.35 (m, 1H), 5.04 – 4.94 (m, 2H), 4.87 – 4.59 (m, 9H), 4.58 – 4.47 (m, 2H), 4.39 (dd, $J = 12.1, 5.4$ Hz, 1H), 4.28 – 4.22 (m, 1H), 4.19 (dd, $J = 8.0, 2.0$ Hz, 0.5H), 4.02 (t, $J = 8.0$ Hz, 0.5H), 4.02 (td, $J = 9.3, 3.6$ Hz, 1H), 3.90 – 3.65 (m, 4.5H), 3.61 – 3.50 (m, 1H), 3.43 – 3.38 (m, 2H), 3.35 (s, 1.5H); ^{13}C NMR (101 MHz, CDCl_3) δ 166.3, 165.4, 165.3, 138.9 (2C), 138.5 (2C), 138.2 (2C), 138.0, 137.8, 133.4, 133.3, 133.1, 130.0, 129.9 (2C), 129.8, 129.7, 129.6, 128.6, 128.5

(2C), 128.4 (2C), 128.3 (3C), 128.2, 128.1 (2C), 128.0 (2C), 127.9 (2C), 127.8 (2C), 127.7 (2C), 127.6, 104.0 ($^1J_{C-H} = 160$ Hz), 98.2 ($^1J_{C-H} = 172$ Hz), 98.0 ($^1J_{C-H} = 172$ Hz), 97.1 ($^1J_{C-H} = 172$ Hz), 82.2, 82.1, 82.0, 81.6, 80.2, 80.0, 79.9, 78.2, 78.0, 75.9, 75.8, 75.4, 75.3, 75.2, 75.1, 75.0, 73.5, 73.4, 72.9, 72.0, 71.2, 70.9, 70.4, 69.8, 68.9, 67.9, 66.3, 63.6, 63.3, 55.4, 55.2; HRMS (ESI) calcd for $C_{62}H_{62}O_{13}Na$ $[M+Na]^+$ 1037.4088; found: 1037.4095.

4.4.5 Solid-phase automated glycan assembly

Building block solution: The building block **92** was co-evaporated with toluene three times, dissolved in dichloromethane under argon and transferred to the vial which was placed on the corresponding port in the synthesizer. For each glycosylation, building block **92** (6.5 equivalents, 0.08 mmol) was dissolved in 1 mL dichloromethane.

Acidic TMSOTf wash solution: 450 μ L TMSOTf was dissolved in 40 mL dichloromethane.

Activator solution: DBDMH (0.86 g) was dissolved in a 2:1 (v/v) mixture of anhydrous dichloromethane and dioxane (40 mL) followed by the addition of TMSOTf (54 μ L).

Fmoc deprotection solution: The solution was 20% (v/v) piperidine in DMF.

Preparation of the resin: The functionalized resin **21**⁹⁶ (40 mg, 0.0125 mmol linker) was loaded into the reaction vessel of the synthesizer and swollen in 2 mL dichloromethane for 20 min.

Module a-Acidic TMSOTf wash: The resin is washed with 1 mL acidic solution of TMSOTf in dichloromethane for three minutes at -20 °C.

Module b-Glycosylation using thioglycoside: For glycosylation the acidic solution is drained and thioglycoside building block (1 mL) is delivered to the reaction vessel. After the set temperature -20 °C is reached, the reaction starts with the addition of 1 mL of activator solution. The glycosylation is performed for 5 min at -20 °C and 20 min from -20 °C to 0 °C Then the solution is drained and the resin is washed with dioxane (2 mL for 20 s)

and dichloromethane (two times each with 2 mL for 25 s). The temperature of the reaction vessel is increased to 25 °C for the next module.

Module c-Fmoc deprotection: The resin is washed with DMF and then 2 mL solution of 20% piperidine in DMF for 5 min. The reaction solution was drained and the resin was washed with DMF (three times with 3 mL for 25 s) and dichloromethane (five times each with 2 mL for 25 s).

Cleavage from Solid Support: After automated synthesis, the oligosaccharides were cleaved from the solid support using a continuous-flow photoreactor as described previously.⁹⁶

Analytical HPLC of the crude after UV-cleavage: YMC-Diol-300-NP 5 μ m (150 \times 4.60 mm) column; flow rate: 1.0 mL; elution gradient: 20% ethyl acetate in hexanes for 5 min, increased to 55% at 40 min, then 100% at 45 min; detection: ELSD and UV light.

Purification: flash column chromatography with 30% ethyl acetate in hexanes

***N*-Benzyloxycarbonyl-5-amino-pentanyl 2-*O*-benzoyl-3,4-di-*O*-benzyl- α -D-mannopyranosyl-(1 \rightarrow 6)-2-*O*-benzoyl-3,4-di-*O*-benzyl- α -D-mannopyranoside (99)**

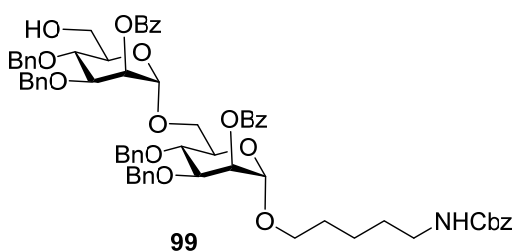

$[\alpha]_D^{25} +9.10$ (c 0.91, CHCl_3); $^1\text{H NMR}$ (400 MHz, CDCl_3) δ 8.12 (dd, $J = 8.1, 1.7$ Hz, 2H), 8.07 (dd, $J = 8.3, 1.4$ Hz, 2H), 7.62 – 7.56 (m, 1H), 7.54 – 7.44 (m, 5H), 7.33 – 7.21 (m, 23H), 7.17 – 7.11 (m, 2H), 5.73 (dd, $J = 3.2, 1.9$ Hz, 1H), 5.62 (dd, $J = 3.3, 1.8$ Hz, 1H), 5.16 – 5.05 (m, 3H), 4.94 – 4.80 (m, 5H), 4.74 (d, $J = 11.4$ Hz, 1H), 4.63 (d, $J = 11.1$ Hz, 1H), 4.56 (d, $J = 11.0$ Hz, 1H), 4.49 (d, $J = 11.2$ Hz, 1H), 4.47 (d, $J = 11.2$ Hz, 1H), 4.09 (dd, $J = 9.4, 3.1$ Hz, 2H), 4.01 – 3.60 (m, 10H), 3.47 – 3.38 (m, 1H), 3.18 (q, $J = 7.0$ Hz, 2H), 1.59 – 1.54 (m, 2H), 1.54 – 1.47 (m, 2H), 1.40 – 1.34 (m, 2H); $^{13}\text{C NMR}$ (101 MHz,

CDCl₃) δ 166.0, 165.7, 138.4 (2C), 138.0, 137.8, 133.4, 130.0 (2C), 129.9, 128.7, 128.6 (2C), 128.5 (2C), 128.4, 128.3, 128.2 (3C), 128.1, 127.9, 127.8 (3C), 98.0, 97.9, 78.7, 78.0, 75.3, 74.4, 74.0, 72.2, 71.8, 71.5, 70.7, 69.1, 68.9, 67.9, 66.7, 66.3, 62.1, 41.1, 29.9, 29.2, 23.6; HRMS (ESI) calcd for C₆₇H₇₁O₁₅NNa [M+Na]⁺ 1152.4721; found: 1152.4727.

4.4.6 Hydrolysis of glycosyl selenide

Phenyl 2-azido-2-deoxy-4-*O*-fluorenylmethoxycarbonyl-6-*O*-levulinoyl-3-*O*-(2-naphthalenylmethyl)-1-seleno- α -D-galactopyranoside (**100**)

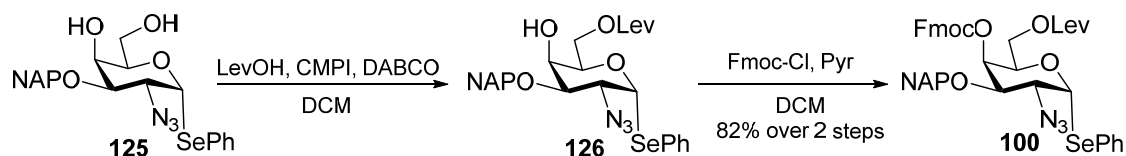

To a solution of phenyl 2-azido-2-deoxy-3-*O*-(2-naphthalenylmethyl)-1-seleno- α -D-galactopyranoside²³⁶ **125** (280 mg, 0.58 mmol) in dichloromethane (4 mL) was added levulinic acid (0.35 mL, 3.47 mmol) followed by 2-chloro-1-methylpyridinium iodide (CMPI, 369 mg, 1.44 mmol). 1,4-Diazabicyclo[2.2.2]octane (DABCO, 246 mg, 2.2 mmol) was added after 15 min. The reaction mixture was stirred at room temperature for 24 h and then diluted with ethyl acetate, filtered through Celite and concentrated to give the crude **126**. The residue was dissolved in dichloromethane (5 mL), followed by the addition of 9-fluorenylmethyl chloroformate (299 mg, 1.16 mmol) and pyridine (0.14 mL, 1.74 mmol). The mixture was stirred overnight at room temperature. Then the reaction was quenched with 1M aq. HCl solution and diluted with dichloromethane. The organic layer was dried over Na₂SO₄, filtered and concentrated. The residue was purified by flash column chromatography to afford **100** (380 mg, 0.47 mmol, 82%) as a slightly yellow foam.

$[\alpha]_D^{25} +157.77$ (c 1.26, CHCl₃); ¹H NMR (400 MHz, CDCl₃) δ 7.83 (d, *J* = 1.6 Hz, 1H), 7.79 – 7.69 (m, 5H), 7.68 – 7.62 (m, 2H), 7.57 (d, *J* = 7.5 Hz, 1H), 7.50 (dd, *J* = 8.4, 1.7 Hz, 1H), 7.47 – 7.38 (m, 4H), 7.35 – 7.28 (m, 5H), 7.23 (td, *J* = 7.5, 1.1 Hz, 1H), 6.03 (d, *J* = 5.4 Hz, 1H), 5.54 (dd, *J* = 3.2, 1.2 Hz, 1H), 4.98 (d, *J* = 10.9 Hz, 1H), 4.81 (d, *J* = 10.9 Hz, 1H), 4.68 (t, *J* = 6.5 Hz, 1H), 4.42 (dd, *J* = 10.4, 7.1 Hz, 1H), 4.36 – 4.26 (m,

2H), 4.21 (dd, $J = 6.5, 1.6$ Hz, 2H), 4.14 (t, $J = 7.5$ Hz, 1H), 3.90 (dd, $J = 10.3, 3.1$ Hz, 1H), 2.74 (t, $J = 6.5$ Hz, 2H), 2.55 (t, $J = 6.2$ Hz, 2H), 2.20 (s, 3H); ^{13}C NMR (101 MHz, CDCl_3) δ 206.6, 172.4, 154.9, 143.5, 143.0, 141.3, 141.2, 134.8, 134.3, 133.2, 133.1, 129.3, 128.3 (2C), 128.0, 127.9, 127.8, 127.7, 127.4, 127.2 (2C), 126.1 (3C), 125.4, 125.1, 120.1, 120.0, 84.6, 72.2, 70.5, 70.3, 69.1, 62.1, 60.5, 46.5, 38.0, 30.0, 27.8; HRMS (ESI) calcd for $\text{C}_{43}\text{H}_{39}\text{N}_3\text{O}_8\text{SeNa}$ $[\text{M}+\text{Na}]^+$ 828.1795; found: 828.1811.

***N*-Phenyltrifluoroacetimidate 2-azido-2-deoxy-4-*O*-(9-fluorenylmethoxycarbonyl)-6-*O*-levulinoyl-3-*O*-(2-naphthalenylmethyl)- α -D-galactopyranoside (**102**)**

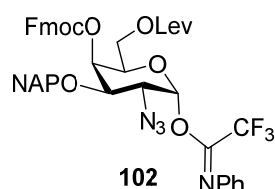

To a solution of monosaccharide **100** (80 mg, 0.099 mmol) in THF-water (4.2 mL, 5:1 v/v) was added DBDMH (45.5 mg, 0.16 mmol) at 0 °C. The reaction mixture was stirred at room temperature for 2 h. Then the mixture was diluted with dichloromethane and washed with 10% aq. $\text{Na}_2\text{S}_2\text{O}_3$ solution. The organic layer was dried over Na_2SO_4 , filtered and concentrated to get crude **101**. The residue **101** was dissolved in dichloromethane (4 mL) followed by the addition of (*E*)-2,2,2-trifluoro-*N*-phenylacetimidoyl chloride (47 μL , 0.298 mmol) and Cs_2CO_3 (97 mg, 0.298 mmol) at 0 °C. After 2 h, the reaction mixture was filtered and concentrated. The residue was purified by flash column chromatography to give imidate **102** (70 mg, 0.083 mmol, 84%) as a colorless oil.

^1H NMR (400 MHz, CDCl_3) δ 7.85 – 7.66 (m, 6H), 7.60 (d, $J = 7.5$ Hz, 1H), 7.52 – 7.22 (m, 10H), 7.11 (t, $J = 7.4$ Hz, 1H), 6.83 (d, $J = 7.9$ Hz, 2H), 5.50 (brs, 1H), 5.42 (s, 1H), 4.94 (d, $J = 11.5$ Hz, 1H), 4.76 (d, $J = 11.4$ Hz, 1H), 4.47 – 4.15 (m, 5H), 3.99 (t, $J = 9.4$ Hz, 1H), 3.84 (s, 1H), 3.57 (d, $J = 10.2$ Hz, 1H), 2.80 – 2.41 (m, 4H), 2.12 (s, 3H); ^{13}C NMR (101 MHz, CDCl_3) δ 206.6, 172.3, 155.0, 143.5, 143.2, 143.1, 141.4, 141.3, 134.2, 133.2, 129.0, 128.4, 128.0, 127.9, 127.8, 127.5, 127.3 (3C), 126.2, 126.1, 125.4, 125.2, 124.7, 120.1 (2C), 119.3, 95.4, 77.6, 72.3, 71.6, 70.7, 69.2, 61.7, 61.5, 46.6, 38.0, 29.8, 28.0; HRMS (ESI) calcd for $\text{C}_{45}\text{H}_{39}\text{F}_3\text{N}_4\text{O}_9\text{Na}$ $[\text{M}+\text{Na}]^+$ 859.2561; found: 859.2566.

Chapter 5

Catching elusive glycosyl oxocarbenium ions via cold-ion infrared spectroscopy

5.1 Introduction

5.1.1 Glycosyl oxocarbenium ions

Over the past few decades, a large amount of sophisticated methods have been developed to stereoselectively assemble oligosaccharides.^{58, 77, 237, 238} But the lack of a universal glycosylation method has pointed to the necessity to gain more insights into mechanism of this reaction.

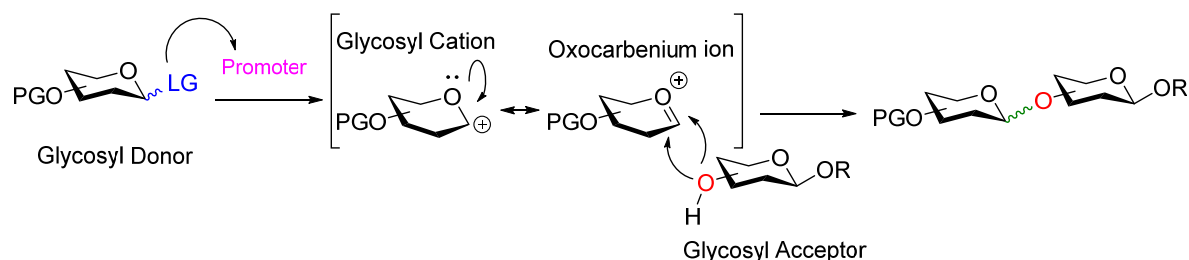

Figure 5.1: Generally accepted mechanism for glycosylation. PG: protecting group.

It is generally accepted that glycosylation involves and is strongly affected by key transient ionic species named glycosyl oxocarbenium ions (Figure 5.1). Extensive efforts have been made to support this hypothesis.²³⁹⁻²⁴¹ Particularly, low-temperature NMR has been used to investigate reactive intermediates²⁴², such as glycosyl triflates^{80, 243} and glycosyl dioxolenium ions.^{244, 245} Although many different reactive intermediates (shown in blue in Figure 5.2) have been described, it is still very difficult to predict whether these intermediates are indeed involved in the product-forming step or merely serve as a reservoir for a more reactive oxocarbenium ion-like species (shown in red in Figure 5.2), which have so far not been observed by low temperature NMR in organic solvents.

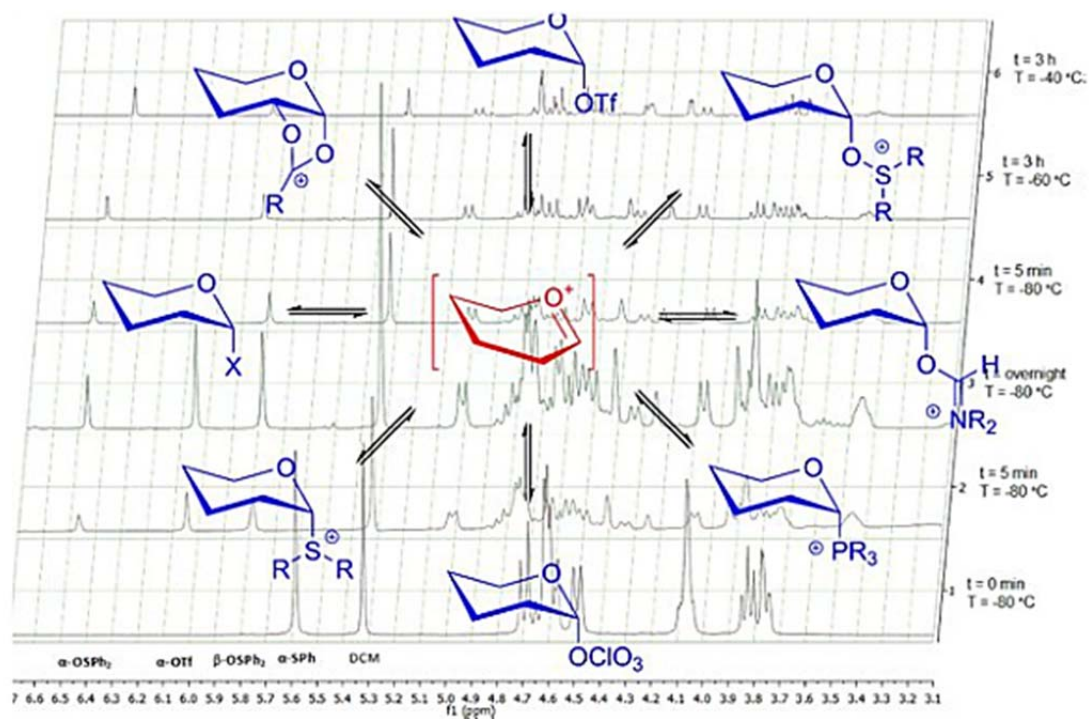

Figure 5.2: Reactive intermediates studied by low-temperature NMR in organic solvents.²⁴² (Reprinted from ref. 242)

Recently, superacid HF/SbF_5 ^{246, 247} has been used to generate and stabilize glycosyl cations derived from peracetylated 2-deoxy and 2-bromoglycopyranose, allowing access to their NMR signature and conformation in a condensed phase (Figure 5.3).²⁴⁸ Extensive NMR analysis of the crude reaction mixture resulting from the treatment of the sugar derivative with HF/SbF_5 at $-40\text{ }^\circ\text{C}$ provided strong evidence for the formation of the 2-deoxyglucosyl oxocarbenium ion as the main species (anomeric proton at $\delta = 8.89$ ppm and anomeric carbon at $\delta = 229.1$ ppm). However, as there are marked differences between superacid medium and organic solvents, it is impossible to transpose the data obtained in superacid to classical glycosylation conditions. Therefore, some new methods are highly needed to access the observation and analysis of glycosyl oxocarbenium ions.

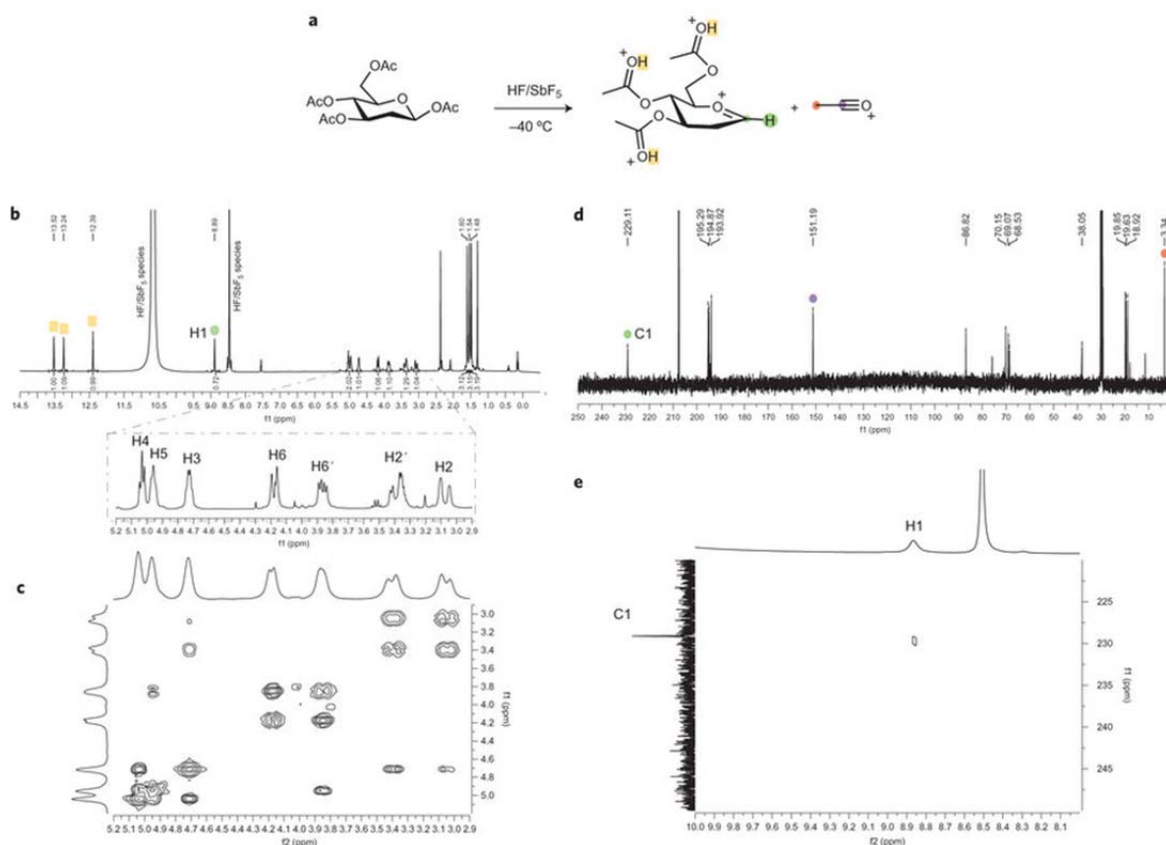

Figure 5.3: NMR spectra including the signals at 8.89 ppm for the anomeric proton and at 229.1 ppm for the anomeric carbon unambiguously confirm the generation of the 2-deoxyglycosyl oxocarbenium ion. (a) Generation of ion in HF/SbF₅; (b) ¹H NMR spectrum of ion; (c) ¹H-¹H COSY (homonuclear correlated spectroscopy) NMR spectrum; (d) ¹³C NMR spectrum; (e) ¹H-¹³C HSQC (heteronuclear single quantum correlation) NMR spectrum.²⁴⁸ (Reprinted from ref. 248)

5.1.2 Cold-ion infrared spectroscopy and its experimental setup

Combining mass spectrometry (MS) and infrared (IR) spectroscopy provides a very sensitive alternative by interrogating the vibrational modes of mass-selected gas-phase molecular ions. The ions are stored and isolated in a quadrupole ion trap where they are investigated with infrared multiple photon dissociation (IRMPD) spectroscopy using a free electron laser (FEL). Over the past two decades, gas-phase IR spectroscopy has been explored for glycan analysis.²⁴⁹⁻²⁵¹ However, spectral congestion due to peak broadening²⁵² has limited the informational content of the resulting signatures. Resolution of carbohydrate-ion IR spectra obtained at around 300 K by IRMPD was very limited, even at the mono- and disaccharide level.

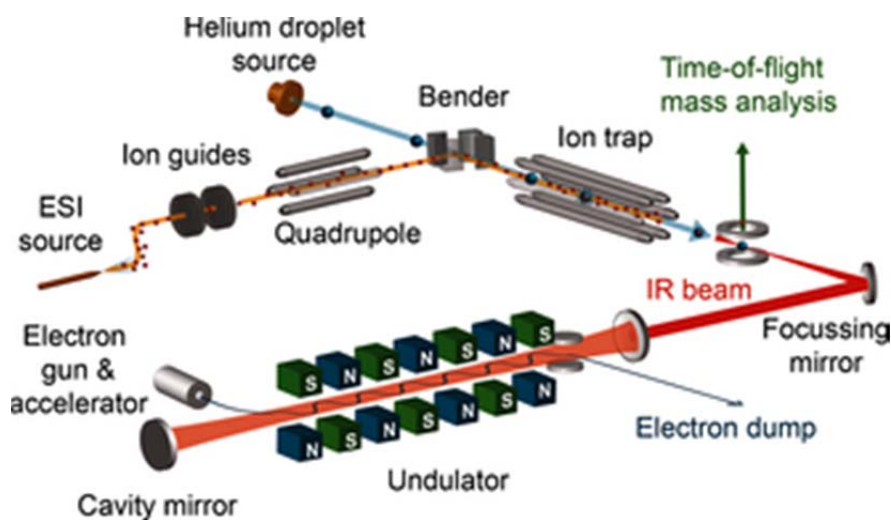

Figure 5.4: Schematic diagram of the experimental setup for cold-ion IR spectroscopy.²⁵³ (Reprinted from ref 253)

To overcome this limitation, nanoelectrospray ionization (nESI), mass spectrometry and ultra-cold gas phase IR spectroscopy have been combined (Figure 5.4). Molecular ions are generated using nanoelectrospray ionization, which allows for the ionization of large molecules. These ions are mass-to-charge selected and accumulated in a linear ion trap. Superfluid helium droplets with an average size of 10^5 helium atoms are subsequently guided through the trap to pick up molecular ions, which are rapidly cooled down to ca. 0.37 K, the equilibrium temperature of the droplet. While the droplet itself is optically transparent, irradiation with intense, narrow-bandwidth IR radiation can lead to the ejection of ions from the droplet if the wavelength is in resonance with a vibrational excitation of the ion. Monitoring the ejection efficiency as a function of the wavelength yields a highly reproducible IR spectrum of ultra-cold molecular ions. Using this experimental set-up, cold-ion IR spectra of a series of mono- and oligosaccharides have been recorded.²⁵⁴ Each spectrum exhibits a unique absorption pattern with a variety of well-resolved bands (Figure 5.5).

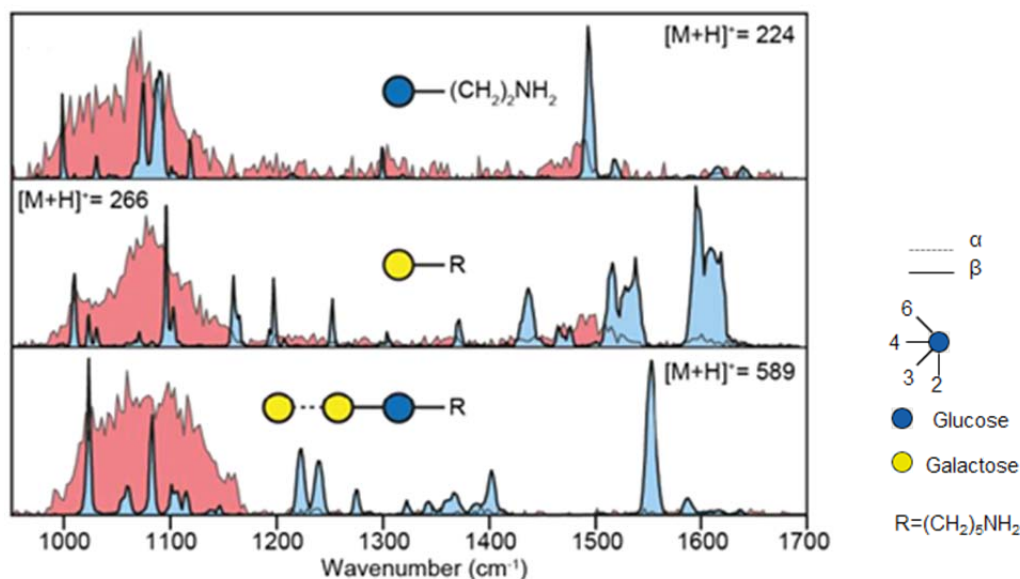

Figure 5.5: The characteristic spectra using established cold-ion spectroscopy method are depicted in blue, while IR spectra depicted in red were recorded using an in house constructed drift-tube ion mobility instrument.²⁴⁸ (Reprinted from ref. 248)

With this established cold-ion IR spectroscopy technique, glycosyl cations generated from various glycosyl donors will be explored to get a deeper insight into the mechanism of glycosylation reactions.

5.2 Results and discussion

5.2.1 Design of monosaccharide library

A series of monosaccharide thioglycoside donors with various protecting group patterns (Figure 5.6) has been devised to study their glycosyl oxocarbenium ion using cold-ion IR spectroscopy. To simplify the IR spectra, the methyl group was chosen as the ether protecting group while acetyl group was selected to be the ester protecting group. Glucosyl substrates **127** to **131** are meant to illustrate the electron-withdrawing effect on glycosyl cations. Monosaccharides **128**, **132** and **133**, bearing acetyl group at C-2 position, will be synthesized to study the participating effect on the formation of glycosyl cations. Galac-

tosyl donor **134** will be investigated to get empirical evidence for C-4 remote participating effect of galactose.⁷⁷

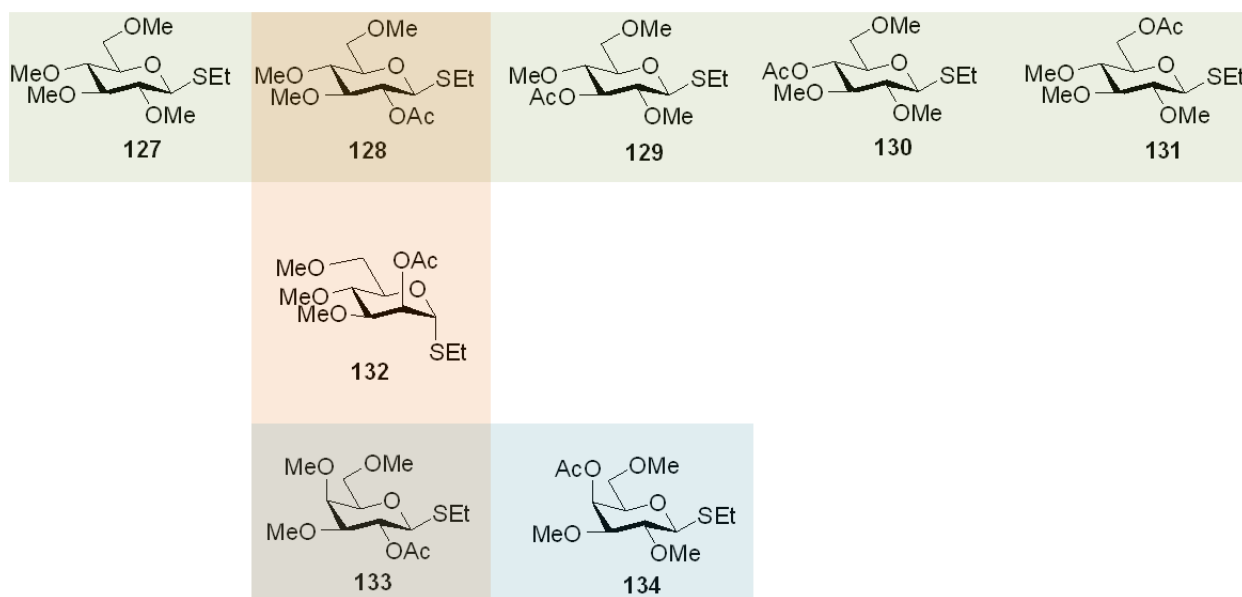
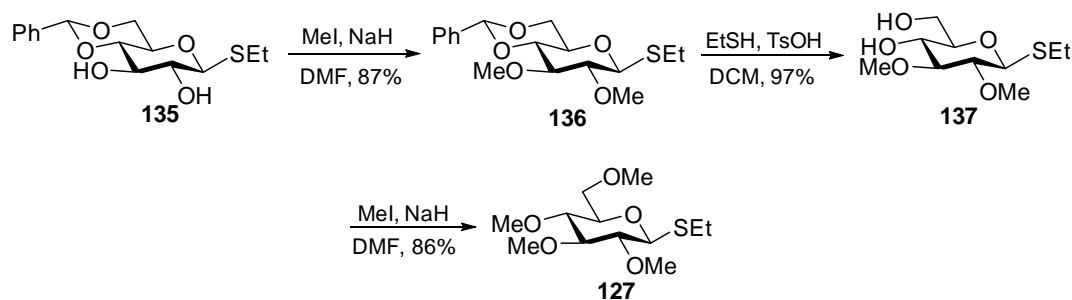

Figure 5.6: Monosaccharides with different protecting-group patterns to be studied by cold-ion IR spectroscopy.

5.2.2 Synthesis of monosaccharides

The synthesis of monosaccharide **127** started with ethyl 4,6-*O*-benzylidene-1-thio- β -D-glycopyranoside²⁵⁵ **135** (Scheme 5.1). Methylation of **135** followed by cleavage of benzylidene acetal with ethanethiol afforded diol **137**, which was further treated with methyl iodide and sodium hydride to produce thioglycoside **127**.



Scheme 5.1: Synthesis of thioglycoside **127**.

Commercial available 1,2-orthoester of D-glucose²⁵⁶ **138** was chosen to commence the synthesis of compound **128** (Scheme 5.2). After removal of all the acetyl groups under Zemplén conditions²⁵⁷ (catalytic amount of sodium methoxide in methanol), methyl groups were introduced using methyl iodide and sodium hydride in DMF to give **139**. Treatment with TMSOTf in the presence of ethanethiol converted glucosyl orthoester **139** into thioglycoside **128**. Monosaccharides **132** and **133** were obtained using the same procedure described above for donor **128**, starting from 1,2-orthoesters **140** and **142**, respectively.

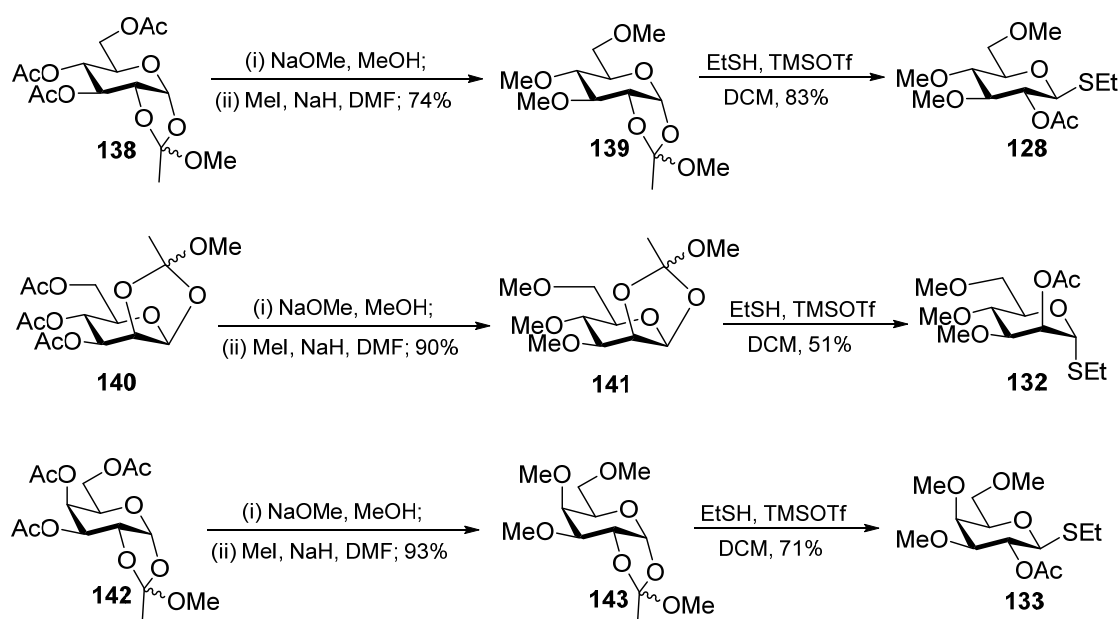

Scheme 5.2: Synthesis of monosaccharides **128**, **132** and **133** bearing a C-2 participating group.

Tin-mediated regioselective protection²⁵⁸ of diol **135** with 2-bromomethylnaphthalene gave C-3 protected sugar **144**, which was further treated with ethanethiol and TsOH to afford **145**. Methylation of **145** followed by removal of 2-naphthylmethyl ether (NAP) group with DDQ yielded alcohol **147**. Acetylation of the free hydroxyl group was accomplished with acetic anhydride catalyzed by DMAP, producing substrate **129** (Scheme 5.3).

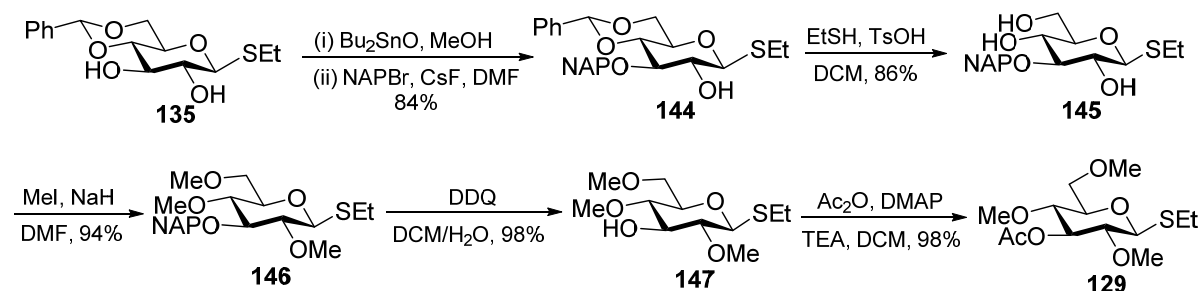
Scheme 5.3: Synthesis of monosaccharide **129**.

To obtain thioglycoside **130**, diol **137** was regioselectively protected with 4,4'-dimethoxytrityl (DMT) chloride to afford **148**. NAP protecting group was then installed at C-4 position, followed by removal of temporary DMT protecting group to give **149**. Subsequent methylation, cleavage of NAP group and acetylation produced substrate **130**. On the other hand, the hydroxyl group of **148** was methylated with methane iodide to produce **152**, which was further treated with trifluoroacetic acid to give alcohol **153**. Final installation of acetyl group resulted in **131** (Scheme 5.4).

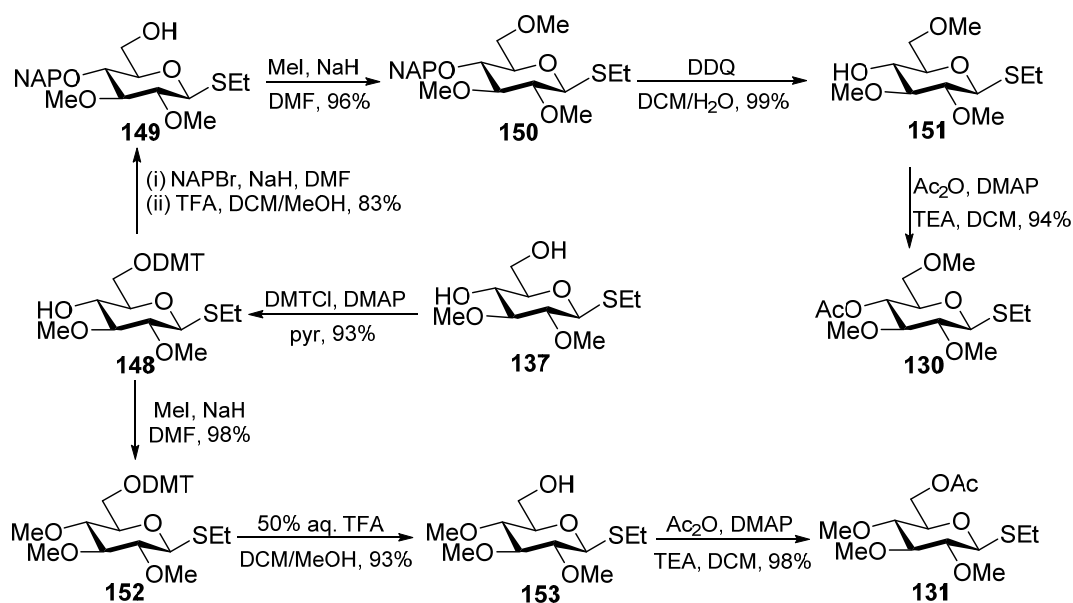
Scheme 5.4: Synthesis of compounds **130** and **131**.

The synthesis of galactosyl derivative **134** was achieved in four steps, starting with ethyl 4,6-O-benzylidene-1-thio- β -D-galactopyranoside²⁵⁹ **36** (Scheme 5.5). Regioselective opening of the benzylidene acetal with borane and TMSOTf gave the C-4 benzylated triol, which was methylated to give **154**. Birch reduction²⁶⁰ was carried out to remove benzyl group due to the existence of sulfur. Then **155** was treated with acetic anhydride to yield galactosyl substrate **134**.

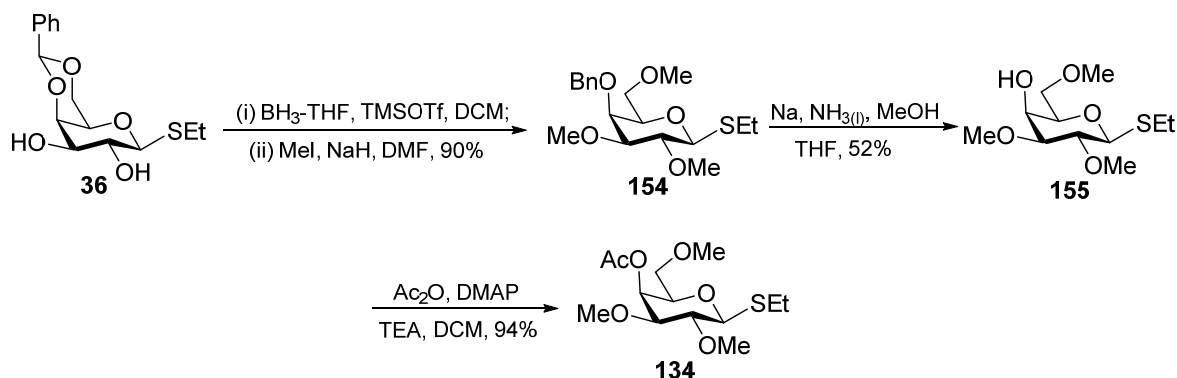

Scheme 5.5: Synthesis of compound **134**.

5.2.3 Cold-ion infrared spectra^{**}

With all the substrates in hand, the stage was set to access the cold-ion IR spectra of glycosyl oxocarbenium ions. In order to get empirical evidence for participating effect, gluco- and galactosyl thioglycoside **128** was firstly studied to see which ion is preferred (Scheme 5.6).

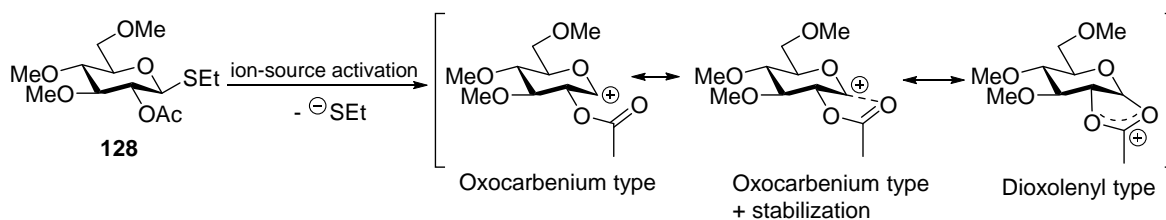

Scheme 5.6: Glycosyl cations for substrate **128**.

^{**} The cold-ion IR study was carried out by Eike Mucha, Fritz-Haber-Institut der Max-Planck-Gesellschaft and Institute of Chemistry and Biochemistry, Freie Universität Berlin, Germany.

The IR spectrum of glycosyl ion generated from **128** exhibits a well-resolved pattern (Figure 5.7). Compared with calculated IR spectra, the IR pattern suggested that the closed structure (dioxolenyl type ion) is formed, illustrating the existence of participating effect. The conformation of this ion is heavily distorted from 4S_1 .

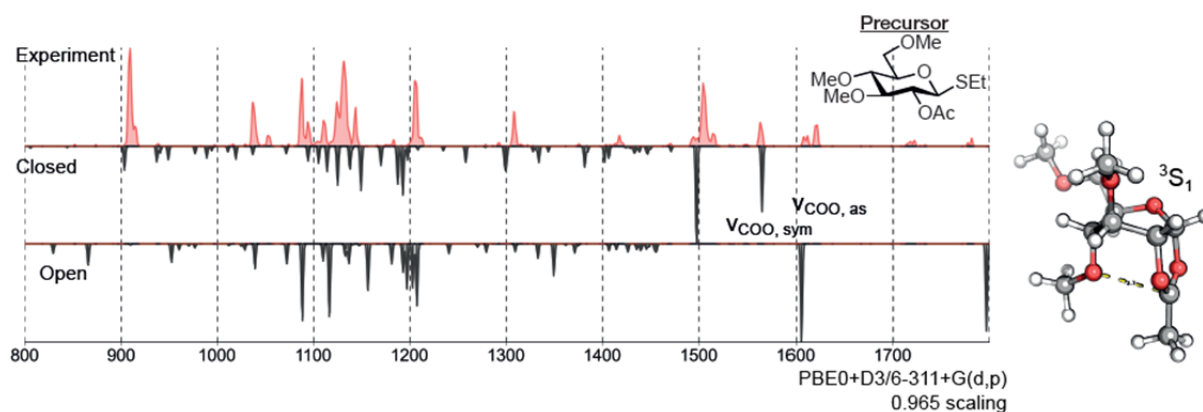

Figure 5.7: Cold-ion IR spectrum of glycosyl ions generated from **128** and calculated spectra of oxocarbenium type ion and dioxolenyl ion.

5.3 Conclusion

A library of monosaccharide thioglycoside donors with different protecting-group patterns has been synthesized to study their glycosyl cations with cold-ion IR spectroscopy technique. The IR spectrum of ions generated from glucosyl donor **128**, which has a participating group at C-2 position, has provided empirical evidence for the formation of dioxolenyl ion. Further analysis of glycosyl cations generated from the other glycosyl donors is still ongoing.

5.4 Experimental section

Ethyl 4,6-*O*-benzylidene-2,3-di-*O*-methyl-1-thio- β -D-glucopyranoside (**136**)

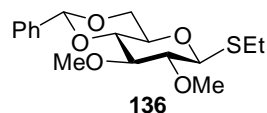

Sodium hydride (205 mg, 5.12 mmol, 60% wt) was added to a solution of ethyl 4,6-*O*-benzylidene- β -D-glucopyranoside **135** (400 mg, 1.28 mmol) in DMF (5 mL) at 0 °C. The reaction was stirred for 15 min at room temperature. MeI (0.32 mL, 5.12 mmol) was added and the mixture was stirred for 2 h. The reaction was quenched with aq. NH₄Cl solution and extracted three times with ethyl acetate. The combined organic layer was washed with brine, dried over Na₂SO₄ and concentrated. The residue was purified by flash chromatography with 25% ethyl acetate in hexanes to give product **136** (380 mg, 1.12 mmol, 87%).

$[\alpha]_D^{25}$ -61.8 (c 0.81, CHCl₃); ¹H NMR (400 MHz, CDCl₃) δ 7.51 – 7.44 (m, 2H), 7.41 – 7.33 (m, 3H), 5.54 (s, 1H), 4.45 (d, J = 9.8 Hz, 1H), 4.33 (dd, J = 10.5, 5.0 Hz, 1H), 3.75 (t, J = 10.3 Hz, 1H), 3.66 (s, 3H), 3.63 (s, 3H), 3.57 (t, J = 9.4 Hz, 1H), 3.48 – 3.35 (m, 2H), 3.07 (dd, J = 9.8, 8.3 Hz, 1H), 2.83 – 2.68 (m, 2H), 1.31 (t, J = 7.4 Hz, 3H); ¹³C NMR (101 MHz, CDCl₃) δ 137.4, 129.1, 128.4, 126.2, 101.3, 85.8, 84.8, 83.2, 81.5, 70.3, 68.8, 61.5, 61.2, 25.3, 15.2; HRMS (ESI) calcd for C₁₇H₂₄O₅SNa [M+Na]⁺ 363.1236; found: 363.1227.

Ethyl 2,3-di-*O*-methyl-1-thio- β -D-glucopyranoside (**137**)

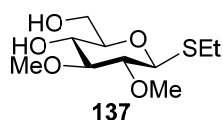

Ethanethiol (1.63 mL, 22.0 mmol) and TsOH (27.9 mg, 0.15 mmol) were added to a solution of compound **136** (250 mg, 0.73 mmol) in dichloromethane (5 mL). The reaction mixture was then stirred for 1 h. Triethylamine was added to quench the reaction. The solvent was removed *in vacuo* and the residue was purified by flash chromatography with 33% hexanes in ethyl acetate to obtain compound **137** (180.6 mg, 0.716 mmol, 97%).

$[\alpha]_D^{25}$ -62.6 (c 0.86, CHCl₃); ¹H NMR (400 MHz, CDCl₃) δ 4.39 (d, J = 9.7 Hz, 1H), 3.88 (dd, J = 11.9, 3.5 Hz, 1H), 3.76 (dd, J = 11.9, 5.0 Hz, 1H), 3.66 (s, 3H), 3.59 (s, 3H), 3.50 (t, J = 9.3 Hz, 1H), 3.37 – 3.30 (m, 1H), 3.16 (t, J = 8.9 Hz, 1H), 2.99 (t, J = 9.2 Hz, 1H), 2.80 – 2.68 (m, 2H), 1.30 (t, J = 7.4 Hz, 3H); ¹³C NMR (101 MHz, CDCl₃) δ 87.9, 85.3,

83.5, 79.1, 70.5, 62.8, 61.3, 60.8, 25.3, 15.2; HRMS (ESI) calcd for $C_{10}H_{20}O_5SNa$ $[M+Na]^+$ 275.0923; found: 275.0903.

Ethyl 2,3,4,6-tetra-*O*-methyl-1-thio- β -D-glucopyranoside (**127**)

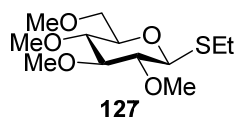

Sodium hydride (19.2 mg, 0.476 mmol, 60% wt) was added to a solution of **137** (30 mg, 0.119 mmol) in DMF (2 mL) at 0 °C. The reaction was stirred for 15 min at room temperature. MeI (0.03 mL, 0.476 mmol) was added and the mixture was stirred for 2 h. The reaction was quenched with aq. NH_4Cl solution and extracted three times with ethyl acetate. The combined organic layer was washed with brine, dried over Na_2SO_4 and concentrated. The residue was purified by flash chromatography with 15% ethyl acetate in hexanes to yield product **127** (28.6 mg, 0.102 mmol, 86%).

$[\alpha]_D^{25}$ -39.4 (c 0.87, $CHCl_3$); 1H NMR (400 MHz, $CDCl_3$) δ 4.27 (d, $J = 9.8$ Hz, 1H), 3.63 (s, 3H), 3.60 (dd, $J = 10.8, 2.0$ Hz, 1H), 3.57 (s, 3H), 3.55 – 3.50 (m, 4H), 3.37 (s, 3H), 3.25 (ddd, $J = 9.5, 4.9, 2.0$ Hz, 1H), 3.17 (t, $J = 8.7$ Hz, 1H), 3.14 – 3.07 (m, 1H), 2.95 (dd, $J = 9.8, 8.5$ Hz, 1H), 2.77 – 2.65 (m, 2H), 1.27 (t, $J = 7.4$ Hz, 3H); ^{13}C NMR (101 MHz, $CDCl_3$) δ 88.6, 84.9, 83.5, 79.6, 78.9, 71.6, 61.0, 60.9, 60.6, 59.4, 25.1, 15.0; HRMS (ESI) calcd for $C_{12}H_{24}O_5SNa$ $[M+Na]^+$ 303.1236; found: 303.1229.

3,4,6-Tri-*O*-methyl- α -D-glucopyranose 1,2-(methyl orthoacetate)²⁵⁶ (**139**)

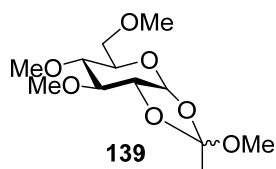

MeONa (8.9 mg, 0.16 mmol) was added to a solution of 3,4,6-tri-*O*-acetyl- α -D-glucopyranose 1,2-(methyl orthoacetate) **138** (200 mg, 0.55 mmol) in methanol (4 mL).

The reaction mixture was stirred at room temperature for 2 h. After removal of solvent, the residue was dissolved in DMF (4 mL) followed by the addition of sodium hydride (132 mg, 3.3 mmol, 60% wt) at 0 °C. The reaction was stirred for 15 min at room temperature. MeI (0.21 mL, 3.3 mmol) was added and the mixture was stirred for 2 h. The reaction mixture was quenched with aq. NH₄Cl solution and extracted three times with ethyl acetate. The combined organic layer was washed with brine, dried over Na₂SO₄ and concentrated. The residue was purified by flash chromatography with 25% ethyl acetate in hexanes to give product **139** (113 mg, 0.406 mmol, 74%).

$[\alpha]_D^{25} +103.94$ (c 2.02, CHCl₃); ¹H NMR (400 MHz, CDCl₃) δ 5.69 (d, *J* = 5.2 Hz, 1H), 4.37 (ddd, *J* = 5.3, 3.2, 1.0 Hz, 1H), 3.70 – 3.64 (m, 1H), 3.62 – 3.56 (m, 3H), 3.48 (s, 3H), 3.45 (s, 3H), 3.40 (s, 3H), 3.33 – 3.26 (m, 4H), 1.67 (s, 3H); ¹³C NMR (101 MHz, CDCl₃) δ 121.3, 97.6, 79.7, 77.0, 74.4, 72.2, 69.8, 59.4, 58.4, 57.9, 50.9, 20.7; HRMS (ESI) calcd for C₁₂H₂₂O₇Na [M+Na]⁺ 301.1258; found: 301.1244.

Ethyl 2-*O*-acetyl-3,4,6-tri-*O*-methyl-1-thio-β-*D*-glucopyranoside (**128**)

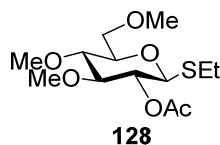

Ethanethiol (0.13 mL, 1.8 mmol) and 4Å molecular sieves were added to a solution of compound **139** (20 mg, 0.072 mmol) in dichloromethane (3 mL). The mixture was stirred for 20 min at room temperature and then cooled down to 0 °C followed by the addition of trimethylsilyl triflate (2.6 μL, 14 μmol). After 2 h, triethylamine was added to quench the reaction. The reaction was diluted with dichloromethane, washed with aq. NaHCO₃ solution, brine, dried over Na₂SO₄ and concentrated. The residue was purified by flash chromatography with 20% ethyl acetate in hexanes to afford product **128** (18.5 mg, 0.06 mmol, 83%).

$[\alpha]_D^{25} -11.0$ (c 1.12, CHCl₃); ¹H NMR (400 MHz, CDCl₃) δ 4.88 (dd, *J* = 10.0, 8.8 Hz, 1H), 4.31 (d, *J* = 10.1 Hz, 1H), 3.66 – 3.58 (m, 2H), 3.53 (s, 6H), 3.39 (s, 3H), 3.36 – 3.21 (m, 3H), 2.75 – 2.61 (m, 2H), 2.11 (s, 3H), 1.23 (t, *J* = 7.4 Hz, 3H); ¹³C NMR (101 MHz,

CDCl₃) δ 169.8, 86.2, 83.5, 79.4, 79.3, 71.7, 71.5, 60.7, 60.6, 59.5, 24.0, 21.2, 14.9; HRMS (ESI) calcd for C₁₃H₂₄O₆SNa [M+Na]⁺ 331.1185; found: 331.1171.

3,4,6-Tri-*O*-methyl- β -D-mannopyranose 1,2-(methyl orthoacetate)²⁶¹ (**141**)

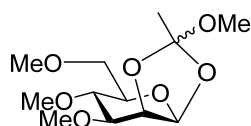

141

Sodium methoxide (8.9 mg, 0.16 mmol) was added to a solution of 3,4,6-tri-*O*-acetyl- β -D-mannopyranose 1,2-(methyl orthoacetate) **140** (200 mg, 0.55 mmol) in methanol (4 mL). The reaction was stirred at room temperature for 2 h. After removal of solvent, the residue was dissolved in DMF (4 mL) followed by the addition of sodium hydride (132 mg, 3.3 mmol, 60% wt) at 0 °C. The reaction was stirred for 15 min at room temperature and MeI (0.21 mL, 3.3 mmol) was added. After 2 h, the reaction was quenched with aq. NH₄Cl solution and extracted three times with ethyl acetate. The combined organic layer was washed with brine, dried over Na₂SO₄ and concentrated. The residue was purified by flash chromatography with 25% ethyl acetate in hexanes to yield **141** (138 mg, 0.496 mmol, 90%).

$[\alpha]_D^{25}$ -3.18 (c 2.24, CHCl₃); ¹H NMR (400 MHz, CDCl₃) δ 5.40 (d, J = 2.6 Hz, 1H), 4.56 (t, J = 2.7 Hz, 1H), 3.62 – 3.59 (m, 2H), 3.57 (s, 3H), 3.54 (s, 3H), 3.45 – 3.41 (m, 2H), 3.40 (s, 3H), 3.35 – 3.28 (m, 4H), 1.71 (s, 3H); ¹³C NMR (101 MHz, CDCl₃) δ 124.0, 97.7, 81.4, 76.3, 76.0, 74.1, 71.7, 60.8, 59.5, 58.1, 50.0, 24.4; HRMS (ESI) calcd for C₁₂H₂₂O₇Na [M+Na]⁺ 301.1258; found: 301.1246.

Ethyl 2-*O*-acetyl-3,4,6-tri-*O*-methyl-1-thio- α -D-mannopyranose (**132**)

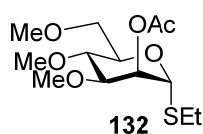

Ethanethiol (0.13 mL, 1.8 mmol) and 4Å molecular sieves were added to a solution of compound **141** (20 mg, 0.072 mmol) in dichloromethane (3 mL). The mixture was stirred for 20 min at room temperature and then cooled down to 0 °C followed by the addition of trimethylsilyl triflate (2.6 µL, 14 µmol). After 2 h, triethylamine was added to quench the reaction. The reaction was diluted with dichloromethane, washed with aq. NaHCO₃ solution, brine, dried over Na₂SO₄ and concentrated. The residue was purified by flash chromatography with 20% ethyl acetate in hexanes to get product **132** (11.2 mg, 0.036 mmol, 51%).

$[\alpha]_D^{25} +103.2$ (c 0.33, CHCl₃); ¹H NMR (400 MHz, CDCl₃) δ 5.34 (t, *J* = 1.9 Hz, 1H), 5.27 (d, *J* = 1.9 Hz, 1H), 3.99 (qd, *J* = 4.3, 1.8 Hz, 1H), 3.66 (dd, *J* = 10.6, 4.3 Hz, 1H), 3.57 (dd, *J* = 10.5, 2.0 Hz, 1H), 3.53 (s, 3H), 3.52 – 3.49 (m, 2H), 3.41 (s, 3H), 3.40 (s, 3H), 2.71 – 2.52 (m, 2H), 2.14 (s, 3H), 1.27 (d, *J* = 8.0 Hz, 3H); ¹³C NMR (101 MHz, CDCl₃) δ 170.6, 82.5, 80.4, 76.2, 71.5, 71.3, 70.3, 60.9, 59.3, 57.7, 25.6, 21.3, 15.0; HRMS (ESI) calcd for C₁₃H₂₄O₆SNa [M+Na]⁺ 331.1185; found: 331.1170.

3,4,6-Tri-*O*-methyl- α -D-galactopyranose 1,2-(methyl orthoacetate) (**143**)

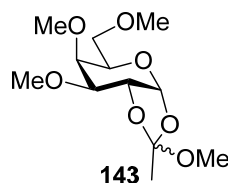

Sodium methoxide (8.9 mg, 0.16 mmol) was added to a solution of 3,4,6-tri-*O*-acetyl- α -D-galactopyranose 1,2-(methyl orthoacetate) **142** (200 mg, 0.55 mmol) in methanol (4 mL). The reaction mixture was stirred at room temperature for 2 h. After removal of solvent, the residue was dissolved in DMF (4 mL) followed by the addition of sodium hydride (132 mg, 3.3 mmol, 60 % wt) at 0 °C. The reaction was stirred for 15 min at room temperature and MeI (0.21 mL, 3.3 mmol) was added. After 2 h, the reaction was quenched with aq. NH₄Cl solution and extracted three times with ethyl acetate. The combined organic layer was washed with brine, dried over Na₂SO₄ and concentrated. The residue was purified by flash chromatography with 30% ethyl acetate in hexanes to afford product **143** (142.8 mg, 0.513 mmol, 93%).

$[\alpha]_D^{25} +95.8$ (c 1.02, CHCl_3); ^1H NMR (400 MHz, CDCl_3) δ 5.68 (d, $J = 4.5$ Hz, 1H), 4.30 (dd, $J = 6.2, 4.5$ Hz, 1H), 4.00 (td, $J = 6.6, 2.6$ Hz, 1H), 3.72 (t, $J = 2.6$ Hz, 1H), 3.54 – 3.50 (m, 8H), 3.40 – 3.34 (m, 4H), 3.26 (s, 3H), 1.64 (s, 3H); ^{13}C NMR (101 MHz, CDCl_3) δ 122.1, 97.6, 82.7, 79.2, 74.6, 73.0, 70.5, 61.1, 59.4, 57.7, 49.8, 24.5; HRMS (ESI) calcd for $\text{C}_{12}\text{H}_{22}\text{O}_7\text{Na}$ $[\text{M}+\text{Na}]^+$ 301.1257; found: 301.1241.

Ethyl 2-*O*-acetyl-3,4,6-tri-*O*-methyl-1-thio- β -D-galactopyranoside (**133**)

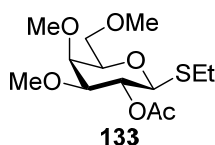

Ethanethiol (0.26 mL, 3.6 mmol) and 4Å molecular sieves were added to a solution of compound **143** (40 mg, 0.14 mmol) in dichloromethane (3 mL). The mixture was stirred for 20 min at room temperature. Then the system was cooled down to 0 °C followed by the addition of trimethylsilyl triflate (5.2 μL , 28 μmol). After 2 h, triethylamine was added to quench the reaction. The mixture was diluted with dichloromethane, washed with aq. NaHCO_3 solution, brine, dried over Na_2SO_4 and concentrated. The residue was purified by flash chromatography with 20% ethyl acetate in hexanes to obtain product **133** (30.9 mg, 0.10 mmol, 71%) as a colorless oil.

$[\alpha]_D^{25} -13.2$ (c 1.26, CHCl_3); ^1H NMR (400 MHz, CDCl_3) δ 5.22 (t, $J = 9.8$ Hz, 1H), 4.31 (d, $J = 9.9$ Hz, 1H), 3.74 (d, $J = 2.9$ Hz, 1H), 3.62 – 3.51 (m, 6H), 3.44 (s, 3H), 3.38 (s, 3H), 3.28 (dd, $J = 9.7, 2.9$ Hz, 1H), 2.78 – 2.59 (m, 2H), 2.08 (s, 3H), 1.22 (t, $J = 7.5$ Hz, 3H); ^{13}C NMR (101 MHz, CDCl_3) δ 169.9, 83.7, 83.6, 76.8, 74.5, 70.8, 69.5, 61.4, 59.3, 58.0, 23.6, 21.2, 14.8; HRMS (ESI) calcd for $\text{C}_{13}\text{H}_{24}\text{O}_6\text{SNa}$ $[\text{M}+\text{Na}]^+$ 331.1185; found: 331.1168.

Ethyl 4,6-*O*-benzylidene-3-*O*-(2-naphthylmethyl)-1-thio- β -D-glucopyranoside (**144**)

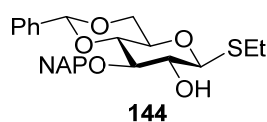

Dibutyltin oxide (438 mg, 1.76 mmol) was added to a solution of compound **135** (500 mg, 1.60 mmol) in methanol (5 mL). The reaction mixture was refluxed at 70 °C for 6 h. The reaction mixture was then cooled down, concentrated in *vacuo* and co-evaporated with toluene twice. After being under high vacuum overnight, the residue was dissolved in DMF (5 mL). 2-Naphthylmethyl bromide (531 mg, 2.40 mmol) and cesium fluoride (316 mg, 2.08 mmol) were added and the mixture was stirred for 6 h at 50 °C. The solvent was removed and the residue was dissolved in dichloromethane, washed with brine, dried over Na₂SO₄ and concentrated in *vacuo*. The residue was purified by flash chromatography with 20% ethyl acetate in hexanes to get product **144** (610 mg, 1.35 mmol, 84%) as a white solid.

NMR data is in accordance with previously reported values.²⁶²

Ethyl 3-O-(2-naphthylmethyl)-1-thio-β-D-glucopyranoside (145)

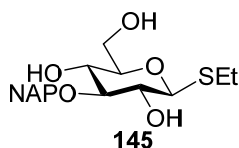

Ethanethiol (0.84 mL, 11.3 mmol) and TsOH (14.4 mg, 0.076 mmol) were added to a solution of compound **144** (171 mg, 0.378 mmol) in dichloromethane (4 mL). The reaction mixture was stirred for 1 h and then triethylamine was added to quench the reaction. The solvent was removed *in vacuo* and the residue was purified by flash chromatography with 33% hexanes in ethyl acetate to give compound **145** (119 mg, 0.327 mmol, 86%).

$[\alpha]_D^{25}$ -65.4 (c 2.01, CHCl₃); ¹H NMR (400 MHz, CDCl₃) δ 7.88 – 7.77 (m, 4H), 7.55 – 7.43 (m, 3H), 5.16 (d, *J* = 11.8 Hz, 1H), 4.94 (d, *J* = 11.8 Hz, 1H), 4.35 (d, *J* = 9.5 Hz, 1H), 3.87 (dd, *J* = 12.0, 3.4 Hz, 1H), 3.75 (dd, *J* = 12.0, 5.0 Hz, 1H), 3.62 (t, *J* = 10.2 Hz, 1H), 3.53 (t, *J* = 8.8 Hz, 1H), 3.45 (t, *J* = 8.7 Hz, 1H), 3.36 (ddd, *J* = 9.7, 5.0, 3.4 Hz, 1H), 2.80 – 2.64 (m, 2H), 1.31 (t, *J* = 7.5 Hz, 3H); ¹³C NMR (101 MHz, CDCl₃) δ 135.9, 133.4, 133.2, 128.7, 128.1, 127.9, 127.0, 126.4, 126.2, 126.0, 86.7, 85.1, 79.5, 74.9, 73.3, 70.2, 62.8, 24.8, 15.5; HRMS (ESI) calcd for C₁₉H₂₄O₅SNa [M+Na]⁺ 387.1236; found: 387.1223.

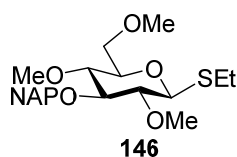
Ethyl 2,4,6-tri-*O*-methyl-3-*O*-(2-naphthylmethyl)-1-thio- β -D-glucopyranoside (146)

Sodium hydride (30.9 mg, 0.772 mmol, 60% wt) was added to a solution of **145** (67 mg, 0.184 mmol) in DMF (3 mL) at 0 °C. The reaction was stirred for 15 min at room temperature. MeI (0.048 mL, 0.772 mmol) was added and the mixture was stirred for 2 h. The reaction was quenched with aq. NH₄Cl solution and extracted three times with ethyl acetate. The combined organic layer was washed with brine, dried over Na₂SO₄ and concentrated. The residue was purified by flash chromatography with 15% ethyl acetate in hexanes to afford product **146** (70.5 mg, 0.173 mmol, 94%) as a white solid.

$[\alpha]_D^{25}$ -18.9 (c 0.93, CHCl₃); ¹H NMR (400 MHz, CDCl₃) δ 7.89 – 7.78 (m, 4H), 7.57 – 7.44 (m, 3H), 5.04 (d, *J* = 11.3 Hz, 1H), 4.99 (d, *J* = 11.3 Hz, 1H), 4.34 (d, *J* = 9.8 Hz, 1H), 3.67 – 3.61 (m, 4H), 3.59 – 3.51 (m, 5H), 3.40 (s, 3H), 3.34 – 3.29 (m, 1H), 3.27 (dd, *J* = 9.8, 8.5 Hz, 1H), 3.11 (dd, *J* = 9.8, 8.8 Hz, 1H), 2.75 (qd, *J* = 7.5, 3.7 Hz, 2H), 1.31 (t, *J* = 7.5 Hz, 3H); ¹³C NMR (101 MHz, CDCl₃) δ 136.3, 133.4, 133.1, 128.2, 128.0, 127.8, 126.6, 126.2, 126.1, 126.0, 86.7, 85.1, 83.6, 79.8, 79.1, 75.6, 71.6, 61.2, 60.9, 59.5, 25.2, 15.1; HRMS (ESI) calcd for C₂₂H₃₀O₅SNa [M+Na]⁺ 429.1706; found: 429.1702.

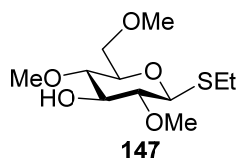
Ethyl 2,4,6-tri-*O*-methyl-1-thio- β -D-glucopyranoside (147)

DDQ (51 mg, 0.225 mmol) was added to a solution of **146** (61 mg, 0.150 mmol) in DCM/H₂O (2.2 mL, 10/1 v/v) at 0 °C. The reaction was stirred for 2 h at room temperature and then diluted with dichloromethane. The mixture was washed with aq. NaHCO₃ solution, brine, dried over Na₂SO₄ and concentrated. The residue was purified by flash

chromatography with 35% ethyl acetate in hexanes to give product **147** (39 mg, 0.146 mmol, 98%) as a colorless oil.

$[\alpha]_D^{25}$ -39.0 (c 0.99, CHCl₃); ¹H NMR (400 MHz, CDCl₃) δ 4.32 (d, *J* = 9.7 Hz, 1H), 3.67 – 3.61 (m, 4H), 3.60 – 3.53 (m, 5H), 3.39 (s, 3H), 3.30 (ddd, *J* = 9.7, 4.7, 2.0 Hz, 1H), 3.19 (dd, *J* = 9.7, 8.9 Hz, 1H), 2.99 (dd, *J* = 9.7, 8.8 Hz, 1H), 2.74 (qd, *J* = 7.4, 2.5 Hz, 2H), 1.30 (t, *J* = 7.5 Hz, 3H); ¹³C NMR (101 MHz, CDCl₃) δ 84.7, 83.2, 79.3, 78.8, 78.5, 71.6, 61.2, 60.7, 59.5, 25.2, 15.0; HRMS (ESI) calcd for C₁₁H₂₂O₅SNa [M+Na]⁺ 289.1080; found: 289.1063.

Ethyl 3-*O*-acetyl-2,4,6-tri-*O*-methyl-1-thio-β-D-glucopyranoside (**129**)

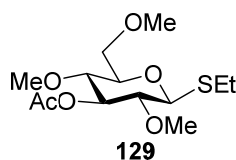

Triethylamine (42 μL, 0.304 mmol), Ac₂O (29 μL, 0.304 mmol) and DMAP (2.5 mg, 0.02 mmol) were added into a solution of **147** (27 mg, 0.101 mmol) in dichloromethane (2 mL). After 2 h, the mixture was diluted with dichloromethane, washed with aq. NaHCO₃ solution, brine, dried over Na₂SO₄ and concentrated *in vacuo*. The crude was further purified by flash chromatography with 30% ethyl acetate in hexane to afford product **129** (30.7 mg, 0.1 mmol, 98%) as a colorless oil.

$[\alpha]_D^{25}$ -16.0 (c 1.37, CHCl₃); ¹H NMR (400 MHz, CDCl₃) δ 5.10 (t, *J* = 9.1 Hz, 1H), 4.38 (d, *J* = 9.8 Hz, 1H), 3.64 (dd, *J* = 10.8, 1.9 Hz, 1H), 3.57 (dd, *J* = 10.8, 4.1 Hz, 1H), 3.48 (s, 3H), 3.41 (s, 3H), 3.39 (s, 3H), 3.36 (dd, *J* = 4.1, 1.9 Hz, 1H), 3.32 (t, *J* = 10.2 Hz, 1H), 3.09 (t, *J* = 9.5 Hz, 1H), 2.74 (qd, *J* = 7.5, 3.5 Hz, 2H), 2.14 (s, 3H), 1.30 (t, *J* = 7.4 Hz, 3H); ¹³C NMR (101 MHz, CDCl₃) δ 170.2, 84.8, 81.3, 78.6, 77.6, 77.5, 71.2, 60.4, 60.1, 59.4, 25.3, 21.2, 15.0; HRMS (ESI) calcd for C₁₃H₂₄O₆SNa [M+Na]⁺ 331.1185; found: 331.1173.

Ethyl 6-*O*-(4,4'-dimethoxytrityl)-2,3-di-*O*-methyl-1-thio-β-D-glucopyranoside (**148**)

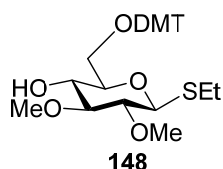

DMAP (7.8 mg, 0.063 mmol) and pyridine (0.128 mL, 1.59 mmol) were added to a solution of **137** (80 mg, 0.317 mmol) in dichloromethane (5 mL), followed by the addition of DMTC1 (118 mg, 0.349 mmol). The reaction was stirred for 3 h at room temperature and quenched by saturated aq. NaHCO₃ solution. The aqueous layer was then extracted three times with dichloromethane. The combined organic layer was dried over Na₂SO₄ and concentrated *in vacuo*. The residue was purified by flash chromatography with 25% ethyl acetate in hexanes to yield **148** (163 mg, 0.294 mmol, 93%) as a pale yellow oil.

Two rotamers: ¹H NMR (400 MHz, CDCl₃) δ 7.49 – 7.42 (m, 1H), 7.37 – 7.28 (m, 6H), 7.26 – 7.15 (m, 2H), 6.90 – 6.81 (m, 4H), 4.41 (dd, *J* = 11.7, 9.7 Hz, 1H), 3.96 – 3.85 (m, 1H), 3.82 (d, *J* = 4.9 Hz, 6H), 3.69 (d, *J* = 3.2 Hz, 3H), 3.63 (d, *J* = 1.5 Hz, 3H), 3.58 – 3.48 (m, 1H), 3.45 – 3.33 (m, 2H), 3.18 (td, *J* = 8.8, 3.7 Hz, 1H), 3.09 – 2.98 (m, 1H), 2.87 – 2.69 (m, 2H), 1.34 (td, *J* = 7.4, 3.5 Hz, 3H).

Ethyl 2,3-di-*O*-methyl-4-*O*-(2-naphthylmethyl)-1-thio-β-D-glucopyranoside (**149**)

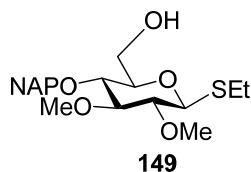

Sodium hydride (19.8 mg, 0.494 mmol, 60% wt) was added to a solution of **148** (137 mg, 0.247 mmol) in DMF (3 mL) at 0 °C. The reaction was stirred for 15 min at room temperature. NAPBr (109 mg, 0.494 mmol) was added and the mixture was stirred for 2 h. The reaction was quenched with aq. NH₄Cl solution and extracted with ethyl acetate three times. The combined organic layer was washed with brine, dried over Na₂SO₄ and concentrated. The residue was dissolved in DCM/MeOH (4.5 mL, 8:1 v/v) followed by the addition of 50% aq. TFA solution (21 μL, 0.272 mmol). The reaction was stirred at room temperature for 2 h and quenched with aq. NaHCO₃ solution. The aqueous layer was ex-

tracted three times with dichloromethane and the combined organic layer was washed by brine, dried over Na₂SO₄ and concentrated. The residue was purified by flash chromatography with 25% ethyl acetate in hexanes to give product **149** (81 mg, 0.25 mmol, 83%) as a colorless oil.

$[\alpha]_D^{25}$ -26.7 (c 0.99, CHCl₃); ¹H NMR (400 MHz, CDCl₃) δ 7.88 – 7.73 (m, 4H), 7.54 – 7.39 (m, 3H), 5.01 (d, *J* = 11.2 Hz, 1H), 4.81 (d, *J* = 11.2 Hz, 1H), 4.38 (d, *J* = 9.8 Hz, 1H), 3.87 (dd, *J* = 12.0, 2.7 Hz, 1H), 3.71 (s, 3H), 3.70 – 3.66 (m, 1H), 3.63 (s, 3H), 3.49 (dd, *J* = 9.7, 9.0 Hz, 1H), 3.40 – 3.31 (m, 2H), 3.01 (dd, *J* = 9.8, 8.7 Hz, 1H), 2.74 (qd, *J* = 7.4, 3.1 Hz, 2H), 1.31 (t, *J* = 7.5 Hz, 3H); ¹³C NMR (101 MHz, CDCl₃) δ 135.6, 133.4, 133.1, 128.4, 128.1, 127.8, 127.0, 126.3, 126.1, 126.1, 88.7, 85.2, 83.8, 79.2, 77.6, 75.2, 62.4, 61.3, 61.1, 25.3, 15.2; HRMS (ESI) calcd for C₂₁H₂₈O₅SNa [M+Na]⁺ 415.1549; found: 415.1541.

Ethyl 2,3,6-tri-*O*-methyl-4-*O*-(2-naphthylmethyl)-1-thio-β-D-glucopyranoside (**150**)

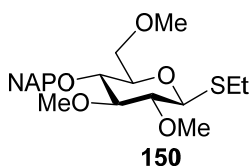

Sodium hydride (14.6 mg, 0.364 mmol, 60% wt) was added to a solution of **149** (71.5 mg, 0.182 mmol) in DMF (3 mL) at 0 °C. The reaction was stirred for 15 min at room temperature. MeI (0.023 mL, 0.364 mmol) was then added and the mixture was stirred for 2 h. The reaction was quenched with aq. NH₄Cl solution and extracted three times with ethyl acetate. The combined organic layer was washed with brine, dried over Na₂SO₄ and concentrated. The residue was purified by flash chromatography with 25% ethyl acetate in hexanes to afford product **150** (72 mg, 0.18 mmol, 97%) as a white solid.

$[\alpha]_D^{25}$ -25.0 (c 0.82, CHCl₃); ¹H NMR (400 MHz, CDCl₃) δ 7.88 – 7.76 (m, 4H), 7.54 – 7.42 (m, 3H), 5.00 (d, *J* = 11.2 Hz, 1H), 4.78 (d, *J* = 11.2 Hz, 1H), 4.32 (d, *J* = 9.8 Hz, 1H), 3.69 (s, 3H), 3.66 – 3.60 (m, 4H), 3.57 (dd, *J* = 8.0, 4.0 Hz, 1H), 3.52 (t, *J* = 10.2 Hz, 1H), 3.41 – 3.36 (m, 1H), 3.36 – 3.29 (m, 4H), 3.04 (dd, *J* = 9.8, 8.6 Hz, 1H), 2.81 – 2.67 (m, 2H), 1.30 (t, *J* = 7.4 Hz, 3H); ¹³C NMR (101 MHz, CDCl₃) δ 135.9, 133.4, 133.1,

128.3, 128.0, 127.8, 126.8, 126.3, 126.2, 126.1, 88.8, 85.1, 83.8, 78.9, 77.7, 75.1, 71.6, 61.3, 61.0, 59.5, 25.2, 15.1; HRMS (ESI) calcd for C₂₂H₃₀O₅SNa [M+Na]⁺ 429.1706; found: 429.1704.

Ethyl 2,3,6-tri-*O*-methyl-1-thio-β-D-glucopyranoside (**151**)

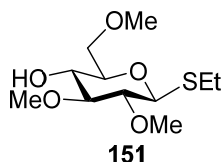

DDQ (52 mg, 0.23 mmol) was added to a solution of **150** (62 mg, 0.153 mmol) in DCM/H₂O (2.2 mL, 10/1 v/v) at 0 °C. The reaction mixture was stirred for 2 h at room temperature and then diluted with dichloromethane. The mixture was washed with aq. NaHCO₃ solution, brine, dried over Na₂SO₄ and concentrated. The residue was purified by flash chromatography with 35% ethyl acetate in hexanes to yield product **151** (40.8 mg, 0.153 mmol, 99%) as a colorless oil.

[α]_D²⁵ -71.8 (c 1.63, CHCl₃); ¹H NMR (400 MHz, CDCl₃) δ 4.35 (d, *J* = 9.7 Hz, 1H), 3.66 (s, 3H), 3.63 (dd, *J* = 4.6, 3.5 Hz, 2H), 3.59 (s, 3H), 3.49 (t, *J* = 9.2 Hz, 1H), 3.42 – 3.34 (m, 4H), 3.15 (t, *J* = 8.8 Hz, 1H), 3.00 (dd, *J* = 9.7, 8.7 Hz, 1H), 2.86 (s, 1H), 2.72 (qd, *J* = 7.4, 4.6 Hz, 2H), 1.29 (t, *J* = 7.5 Hz, 3H); ¹³C NMR (101 MHz, CDCl₃) δ 87.9, 85.1, 83.2, 77.8, 73.0, 71.7, 61.2, 60.8, 59.7, 25.2, 15.1; HRMS (ESI) calcd for C₁₁H₂₂O₅SNa [M+Na]⁺ 289.1080; found: 289.1065.

Ethyl 4-*O*-acetyl-2,3,6-tri-*O*-methyl-1-thio-β-D-glucopyranoside (**130**)

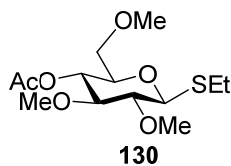

Triethylamine (39 μL, 0.28 mmol), Ac₂O (26 μL, 0.28 mmol) and DMAP (2.3 mg, 0.019 mmol) were added into a solution of **151** (25 mg, 0.093 mmol) in dichloromethane (2

mL). After 2 h, the mixture was diluted with dichloromethane, washed with aq. NaHCO₃ solution, brine, dried over Na₂SO₄ and concentrated *in vacuo*. The crude was purified by flash chromatography with 30% ethyl acetate in hexanes to get product **130** (27.2 mg, 0.093 mmol, 94%) as a colorless oil.

$[\alpha]_D^{25}$ -36.3 (c 1.71, CHCl₃); ¹H NMR (400 MHz, CDCl₃) δ 4.83 (t, *J* = 9.6 Hz, 1H), 4.34 (d, *J* = 9.8 Hz, 1H), 3.59 (s, 3H), 3.53 (s, 3H), 3.49 – 3.43 (m, 1H), 3.43 – 3.38 (m, 2H), 3.32 (s, 3H), 3.27 (t, *J* = 9.0 Hz, 1H), 3.06 (dd, *J* = 9.8, 8.7 Hz, 1H), 2.73 (qd, *J* = 7.4, 4.0 Hz, 2H), 2.09 (s, 3H), 1.30 (t, *J* = 7.4 Hz, 3H); ¹³C NMR (101 MHz, CDCl₃) δ 169.9, 85.8, 85.0, 83.0, 77.4, 72.3, 70.9, 61.0, 60.8, 59.6, 25.1, 21.1, 15.1; HRMS (ESI) calcd for C₁₃H₂₄O₆SNa [M+Na]⁺ 331.1185; found: 331.1170.

Ethyl 6-*O*-(4,4'-dimethoxytrityl)-2,3,4-tri-*O*-methyl-1-thio-β-D-glucopyranoside (152)

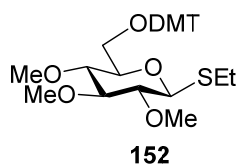

Sodium hydride (20.6 mg, 0.516 mmol, 60% wt) was added to a solution of **148** (143 mg, 0.258 mmol) in DMF (3 mL) at 0 °C. The reaction was stirred for 15 min at room temperature. MeI (0.032 mL, 0.516 mmol) was added and the mixture was stirred for 2 h. The reaction was quenched with aq. NH₄Cl solution and extracted three times with ethyl acetate. The combined organic layer was washed with brine, dried over Na₂SO₄ and concentrated. The residue was purified by flash chromatography with 20% ethyl acetate in hexanes to afford product **152** (144 mg, 0.253 mmol, 98%) as a colorless oil.

¹H NMR (400 MHz, CDCl₃) δ 7.53 – 7.45 (m, 2H), 7.40 – 7.32 (m, 4H), 7.28 – 7.24 (m, 2H), 7.21 – 7.10 (m, 1H), 6.79 (d, *J* = 8.5 Hz, 4H), 4.35 (d, *J* = 9.6 Hz, 1H), 3.77 (s, 6H), 3.63 (s, 3H), 3.62 (s, 3H), 3.40 (dd, *J* = 10.2, 1.8 Hz, 1H), 3.35 (t, *J* = 9.4 Hz, 1H), 3.31 (s, 3H), 3.22 (ddd, *J* = 9.9, 4.2, 1.7 Hz, 1H), 3.15 (t, *J* = 8.7 Hz, 1H), 3.10 – 3.01 (m, 2H), 2.90 – 2.71 (m, 2H), 1.36 (t, *J* = 7.4 Hz, 3H); ¹³C NMR (101 MHz, CDCl₃) δ 158.5, 145.1, 136.5, 136.2, 130.3, 130.2, 129.3, 128.4, 128.0, 127.8, 126.8, 113.3, 113.1, 113.1,

88.7, 85.8, 84.3, 83.6, 79.9, 78.8, 62.6, 61.2, 61.0, 60.6, 55.3, 24.6, 15.4; HRMS (ESI) calcd for $C_{32}H_{40}O_7SNa$ $[M+Na]^+$ 591.2386; found: 591.2411.

Ethyl 2,3,4,-tri-*O*-methyl-1-thio- β -D-glucopyranoside (**153**)

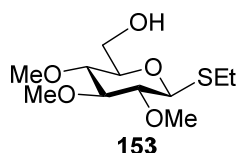

Compound **152** (92 mg, 0.162 mmol) was dissolved in DCM/MeOH (4 mL, 8:1 v/v) followed by the addition of 50% aq.TFA solution (14 μ L, 0.178 mmol). The reaction was stirred for 2 h at room temperature and quenched with aq NaHCO₃ solution. The aqueous layer was extracted three times with dichloromethane and the combined organic layer was washed by brine, dried over Na₂SO₄ and concentrated. The residue was purified by flash chromatography with 28% ethyl acetate in hexanes to give product **153** (40 mg, 0.15 mmol, 93%) as a colorless oil.

$[\alpha]_D^{25}$ -44.3 (c 1.03, CHCl₃); ¹H NMR (400 MHz, CDCl₃) δ 4.33 (d, J = 9.9 Hz, 1H), 3.85 (dd, J = 12.0, 2.7 Hz, 1H), 3.69 (dd, J = 12.0, 4.7 Hz, 1H), 3.65 (s, 3H), 3.59 (s, 3H), 3.55 (s, 3H), 3.26 – 3.18 (m, 2H), 3.16 – 3.10 (m, 1H), 2.94 (t, J = 9.2 Hz, 1H), 2.77 – 2.65 (m, 2H), 1.30 (t, J = 7.4 Hz, 3H); ¹³C NMR (101 MHz, CDCl₃) δ 88.5, 85.1, 83.5, 79.7, 79.2, 62.3, 61.1, 61.0, 60.7, 25.3, 15.2; HRMS (ESI) calcd for $C_{11}H_{22}O_5SNa$ $[M+Na]^+$ 289.1080; found: 289.1065.

Ethyl 6-*O*-acetyl-2,3,4,-tri-*O*-methyl-1-thio- β -D-glucopyranoside (**131**)

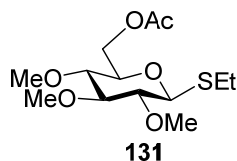

Triethylamine (30 μ L, 0.214 mmol), Ac₂O (20 μ L, 0.214 mmol) and DMAP (1.7 mg, 0.014 mmol) were added into a solution of **153** (19 mg, 0.071 mmol) in dichloromethane

(2 mL). After 2 h, the mixture was diluted with dichloromethane, washed with aq. NaHCO₃ solution, brine, dried over Na₂SO₄ and concentrated *in vacuo*. The crude was purified by flash chromatography with 20% ethyl acetate in hexanes to yield **131** (21.6 mg, 0.070 mmol, 98%) as a colorless oil.

$[\alpha]_D^{25}$ -33.5 (c 0.84, CHCl₃); ¹H NMR (400 MHz, CDCl₃) δ 4.34 – 4.27 (m, 2H), 4.17 (dd, *J* = 11.9, 6.0 Hz, 1H), 3.65 (s, 3H), 3.59 (s, 3H), 3.51 (s, 3H), 3.37 (ddd, *J* = 9.9, 6.0, 2.2 Hz, 1H), 3.21 (t, *J* = 8.8 Hz, 1H), 3.06 (dd, *J* = 9.9, 8.9 Hz, 1H), 2.97 (dd, *J* = 9.8, 8.7 Hz, 1H), 2.77 – 2.64 (m, 2H), 2.07 (s, 3H), 1.30 (t, *J* = 7.4 Hz, 3H); ¹³C NMR (101 MHz, CDCl₃) δ 171.0, 88.6, 85.1, 83.5, 79.9, 76.9, 63.7, 61.1, 61.0, 60.7, 25.3, 21.0, 15.2; HRMS (ESI) calcd for C₁₃H₂₄O₆SNa [M+Na]⁺ 331.1185; found: 331.1174.

Ethyl 4-*O*-benzyl-2,3,6-tri-*O*-methyl-1-thio-β-D-galactopyranoside (**154**)

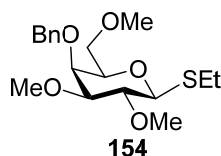

Borane tetrahydrofuran complex solution (4.8 mL, 4.8 mmol, 1 M in THF) and TMSOTf (26 μL, 0.14 mmol) were added to a solution of ethyl 4,6-*O*-benzylidene-β-D-galactopyranoside **36** (300 mg, 0.96 mmol) in dichloromethane (5 mL). The reaction mixture was stirred for 1 h at room temperature. Triethylamine was then added to quench the reaction followed by the addition of methanol. The solvent was removed *in vacuo* and the residue was used directly in the next step without further purification.

Sodium hydride (173 mg, 4.32 mmol, 60% wt) was added to a solution of crude in DMF (5 mL) at 0 °C. The reaction was stirred for 15 min at room temperature. MeI (0.27 mL, 4.32 mmol) was added and the mixture was stirred for 2 h. The reaction was quenched with aq. NH₄Cl solution and extracted three times with ethyl acetate. The combined organic layer was washed with brine, dried over Na₂SO₄ and concentrated. The residue was purified by flash chromatography with 15% ethyl acetate in hexanes to give product **154** (307.4 mg, 0.86 mmol, 90% over two steps) as a colorless oil.

^1H NMR (400 MHz, CDCl_3) δ 7.41 – 7.30 (m, 5H), 4.90 (d, $J = 11.8$ Hz, 1H), 4.61 (d, $J = 11.8$ Hz, 1H), 4.31 (d, $J = 9.6$ Hz, 1H), 3.91 (dd, $J = 3.0, 0.8$ Hz, 1H), 3.61 (s, 3H), 3.49 (s, 3H), 3.49 – 3.44 (m, 3H), 3.42 (t, $J = 9.4$ Hz, 1H), 3.27 (s, 3H), 3.20 (dd, $J = 9.2, 2.9$ Hz, 1H), 2.72 (qt, $J = 7.3, 5.8$ Hz, 2H), 1.28 (t, $J = 7.4$ Hz, 3H); ^{13}C NMR (101 MHz, CDCl_3) δ 138.8, 128.3, 128.2, 127.6, 86.4, 85.3, 80.0, 74.4, 72.4, 71.2, 61.3, 59.2, 58.4, 24.9, 15.0; HRMS (ESI) calcd for $\text{C}_{18}\text{H}_{28}\text{O}_5\text{SNa}$ $[\text{M}+\text{Na}]^+$ 379.1549; found: 379.1534.

Ethyl 2,3,6-tri-*O*-methyl-1-thio- β -D-galactopyranoside (**155**)

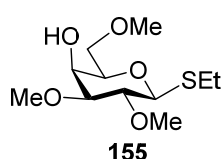

Ammonia ($_{\text{g}}$) was liquefied at -78 $^{\circ}\text{C}$ to get 30 mL NH_3 ($_{\text{l}}$) in a 50 mL two-neck flask with a stirring bar inside. Compound **154** (100 mg, 0.28 mmol) was dissolved in 1 mL THF and 2 drops of MeOH, which was transferred into the NH_3 ($_{\text{l}}$). A thin piece of Na ($_{\text{s}}$) was added into the flask and the color of the mixture turned dark blue. No more sodium was added if the reaction mixture stayed dark blue. The mixture was stirred for 30 min at -78 $^{\circ}\text{C}$. Then MeOH (1 mL) was added dropwise to quench the reaction and the solution turned to transparent immediately. The reaction system was warmed to room temperature, diluted with ethyl acetate, washed with aq. NH_4Cl solution, brine, dried over Na_2SO_4 and concentrated. The residue was purified by flash column chromatography with 30% acetone in hexanes to obtain compound **155** (39 mg, 0.146 mmol, 52 %).

$[\alpha]_{\text{D}}^{25}$ -24.9 (c 0.71, CHCl_3); ^1H NMR (400 MHz, CDCl_3) δ 4.30 (d, $J = 9.6$ Hz, 1H), 4.09 (dd, $J = 3.3, 1.1$ Hz, 1H), 3.67 (dd, $J = 9.9, 5.8$ Hz, 1H), 3.60 (dd, $J = 10.0, 5.6$ Hz, 1H), 3.57 (s, 3H), 3.50 (dd, $J = 5.8, 1.1$ Hz, 1H), 3.49 (s, 3H), 3.38 (s, 3H), 3.26 (t, $J = 9.3$ Hz, 1H), 3.18 (dd, $J = 8.9, 3.2$ Hz, 1H), 2.73 (m, 2H), 1.28 (t, $J = 7.5$ Hz, 3H); ^{13}C NMR (101 MHz, CDCl_3) δ 85.0, 84.6, 79.4, 76.7, 71.9, 66.2, 61.3, 59.6, 57.6, 24.9, 15.0; HRMS (ESI) calcd for $\text{C}_{11}\text{H}_{22}\text{O}_5\text{SNa}$ $[\text{M}+\text{Na}]^+$ 289.1080; found: 289.1057.

Ethyl 4-*O*-acetyl-2,3,6-tri-*O*-methyl-1-thio- β -D-galactopyranoside (**134**)

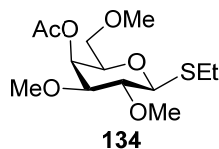

Triethylamine (46 μL , 0.329 mmol), Ac_2O (30 μL , 0.329 mmol) and DMAP (2.7 mg, 0.022 mmol) were added into a solution of **155** (29.2 mg, 0.110 mmol) in dichloromethane (2 mL). After 2 h, the mixture was diluted with dichloromethane, washed with aq. NaHCO_3 solution, brine, dried over Na_2SO_4 and concentrated *in vacuo*. The crude was purified by flash chromatography with 20% acetone in hexanes to afford product **134** (31.8 mg, 0.103 mmol, 94%) as a colorless oil.

$[\alpha]_D^{25}$ -25.5 (c 1.24, CHCl_3); ^1H NMR (600 MHz, CDCl_3) δ 5.47 (dd, $J = 3.4, 1.0$ Hz, 1H), 4.36 (d, $J = 9.5$ Hz, 1H), 3.63 (td, $J = 6.0, 1.1$ Hz, 1H), 3.57 (s, 3H), 3.47 (dd, $J = 9.9, 6.2$ Hz, 1H), 3.41 (s, 3H), 3.37 (dd, $J = 10.0, 5.9$ Hz, 1H), 3.32 (s, 3H), 3.24 (dd, $J = 9.1, 3.3$ Hz, 1H), 3.19 (t, $J = 9.3$ Hz, 1H), 2.75 (qd, $J = 7.5, 5.7$ Hz, 2H), 2.13 (s, 3H), 1.30 (t, $J = 7.4$ Hz, 3H); ^{13}C NMR (151 MHz, CDCl_3) δ 170.5, 85.4, 83.5, 79.5, 76.1, 71.3, 66.8, 61.4, 59.5, 57.9, 25.2, 21.0, 15.0; HRMS (ESI) calcd for $\text{C}_{13}\text{H}_{24}\text{O}_6\text{SNa}$ $[\text{M}+\text{Na}]^+$ 331.1185; found: 331.1172.

Chapter 6

Conclusion and outlook

Cell surface polysaccharides of bacteria are playing important roles in the interactions between pathogens, their hosts and the environment. Identifying and harnessing their structural and functional features offers excellent opportunities for the diagnosis of infections and their prevention. In this dissertation, using the tool of organic chemistry, various oligosaccharide derivatives have been synthesized to investigate bacterial capsular polysaccharides (CPSs) and teichoic acids (TAs) to find possible solutions to combat the harmful bacteria.

Semisynthetic glycoconjugate vaccines, comprising a synthetic oligosaccharide antigen derived from CPS and a carrier protein, have emerged as an attractive option with great potential to understand glycan immunology and rationally design efficacious vaccines against bacteria. Since glycosylation reactions are laborious and making higher oligomers is still challenging, a unique design concept was considered to develop novel semisynthetic glycoconjugates as vaccine candidates wherein RUs of CPS were bridged using an aliphatic spacer through amide linkage formation, thereby eliminating the glycosidic linkages between RUs.

Based on this concept, a branched tetrasaccharide RU of CPS from *S. pneumoniae* serotype 14, which has been identified as the smallest oligosaccharide fragment required to induce specific Pn14PS antibodies, was chosen to synthesize the spacer bridged oligosaccharide derivatives. All the synthetic glycan derivatives were conjugated to carrier protein CRM197 using homobifunctional reagent, adipate 4-nitro phenyl diester, under mild condition. The conjugates formulated with adjuvant aluminum hydroxide were immunologically evaluated in mice. Both glycan array and ELISA analysis of the immune sera demonstrated that the aliphatic spacer did not decrease the antigenicity and immunogenicity. Interestingly, the specific Pn14PS antibody response raised against these derivatives were significantly higher after only two immunizations when compared with the branched tetrasaccharide RU only.

In a broader sense, this strategy reported in this dissertation is of relevance for the future design of semisynthetic glycoconjugate vaccines, making the synthesis of carbohydrate antigens simpler and more efficient. It also offers an efficient way to co-deliver multiple glycan antigens by bridging different glycotopes with spacer, thereby reducing the number of biomolecules in the formulation of multivalent vaccines. Furthermore, fine-tuning spacers of various length and rigidity might help to decipher the interaction between glycan epitopes and recognition receptors on APCs, uncovering the process of glycan immunology.

As anionic glycopolymers, TAs account for as much as 60% of the total cell wall mass in some Gram-positive organisms. Due to their role in antibiotic resistance, there has been a growing interest in TAs as targets for new therapeutics to overcome resistant bacterial infections. In order to better understand their structures and functions, efforts have been made in this thesis to decipher their biosynthesis process. A fragment of the WTA from *S. aureus*, D-ribitol-5-phosphate trimer, was synthesized and soaked into the crystal structure of glycosyltransferase TarP, which modifies WTA with *N*-GlcNAc, to characterize their binding domain. Site-directed mutagenesis of TarP revealed the critical residues for enzyme activity. The structure and catalytic mechanism of TarP therefore provide a valuable platform for rational therapeutic design in the treatment of methicillin-resistant *S. aureus* (MRSA), which causes life-threatening infections worldwide.

As described in this dissertation, synthetic oligosaccharides are useful tools to investigate the biological process of the pathogen, thereby fighting against the harmful infections. Despite the progress that has been achieved in carbohydrate chemistry, the assembly of large complex oligosaccharides still remains a time-consuming task reserved for specialists. Still very little is known about controlling glycosylation reactions as the reaction conditions developed for one substrate are not amenable or general enough for others as would be in the case of peptide or oligonucleotide synthesis. Further efforts in this dissertation were focused on glycosylation reactions from two different angles. The inexpensive reagent, 1,3-dibromo-5,5-dimethylhydantoin, has been demonstrated as a powerful promoter for thioglycosides, which are versatile glycosyl donors commonly used in oligosaccharide assembly, both in solution and automated glycan assembly on solid support. A variety of glycosyl donors have been investigated with promising yields. Compared with

previously reported promoters, this promoter offers a better option due to its ready availability, high solubility and shelf-stability.

The challenge in synthetic carbohydrate chemistry has pointed to the necessity to gain insights into the in-depth mechanism of glycosylation reaction. It is generally accepted that the mechanism involves and is strongly affected by the key transient ionic species, glycosyl oxocarbenium ions, which have not been observed experimentally. Attempt has been made in this thesis to catch and characterize glycosyl cations using cold-ion infrared spectroscopy to get empirical evidence for the mechanism. Various monosaccharide donors with different protecting-group patterns were synthesized for this purpose. A comprehensive knowledge of glycosylation was gained by generation and conformational analysis of the glycosyl cations, based on which a universal method might be able to be developed to facilitate the development of glycoscience field.

7 Appendix

Synthesis of building blocks for semisynthetic glycoconjugate vaccine candidate against *S. pneumoniae* serotype 5^{††}

7.1 Introduction

S. pneumoniae serotype 5 is the fifth most prevalent serotype of *S. pneumoniae*, causing invasive pneumococcal disease among young children globally (see Figure 2.2 in chapter 2).¹⁰⁶ The CPS of ST-5 contains a branched pentasaccharide repeating unit (Figure 7.1).^{10, 11, 263} In this repeating unit, a central *N*-acetyl-L-fucosamine (L-FucNAc) is linked to D-glucose at C4 and to D-glucuronic acid at the C-3 position. Two rare sugars, the ketoamino sugar 2-acetamido-2,6-dideoxy-D-xylose-hexos-4-ulose (*Sugp*) and *N*-acetyl-L-pneumosamine (L-PneuNAc), are included.

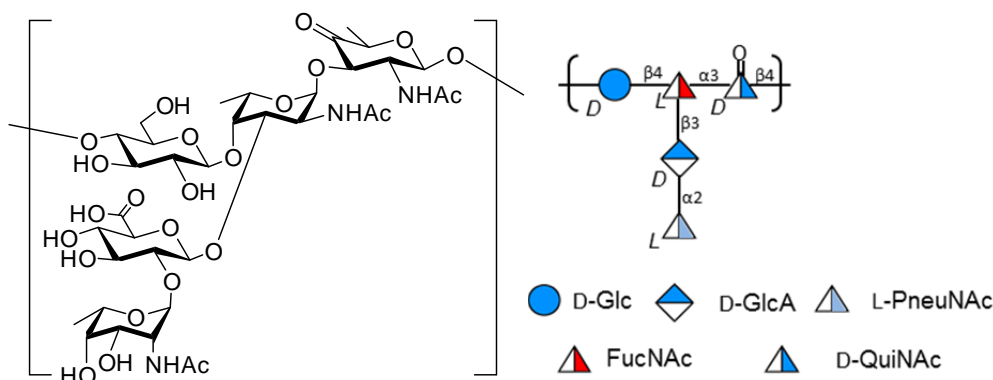

Figure 7.1: Repeating unit of ST-5 CPS.

Marketed glycoconjugate vaccines, which are manufactured from either native or depolymerized CPS, are not fully efficacious in preventing ST-5 infections. The keto group presented in the rare sugar *Sugp* is partially or fully reduced to form a mixture of ST5 CPS components and degrades during ST-5 glycoconjugation production, leading to

^{††} Lisboa, M. P.; Khan, N.; Martin, C.; **Xu, F.-F.**; Reppe, K.; Geissner, A.; Govindan, S.; Witzenrath, M.; Pereira, C. L.; Seeberger, P. H., *Proc. Natl. Acad. Sci. USA* **2017**, *114*, 11063-11068.

manufacturing issues²⁶⁴ and decreased immunogenicity compared with the native ST-5 CPS.

To solve this issue, synthetic oligosaccharides with defined structures are explored to develop semisynthetic glycoconjugate vaccines against ST-5.

7.2 Results and discussion

A retrosynthetic analysis of ST-5 repeating unit equipped with a reducing end linker **156**, which could be conjugated to carrier protein CRM197, revealed the need for five different monosaccharide building blocks **91**, **94**, **157** to **159** (Figure 7.2).

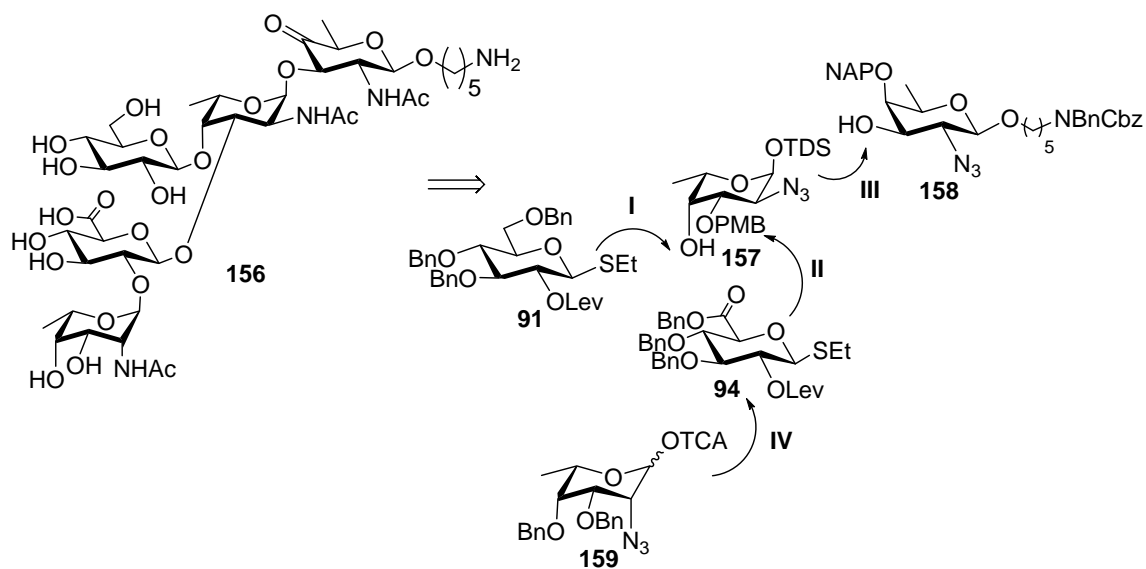
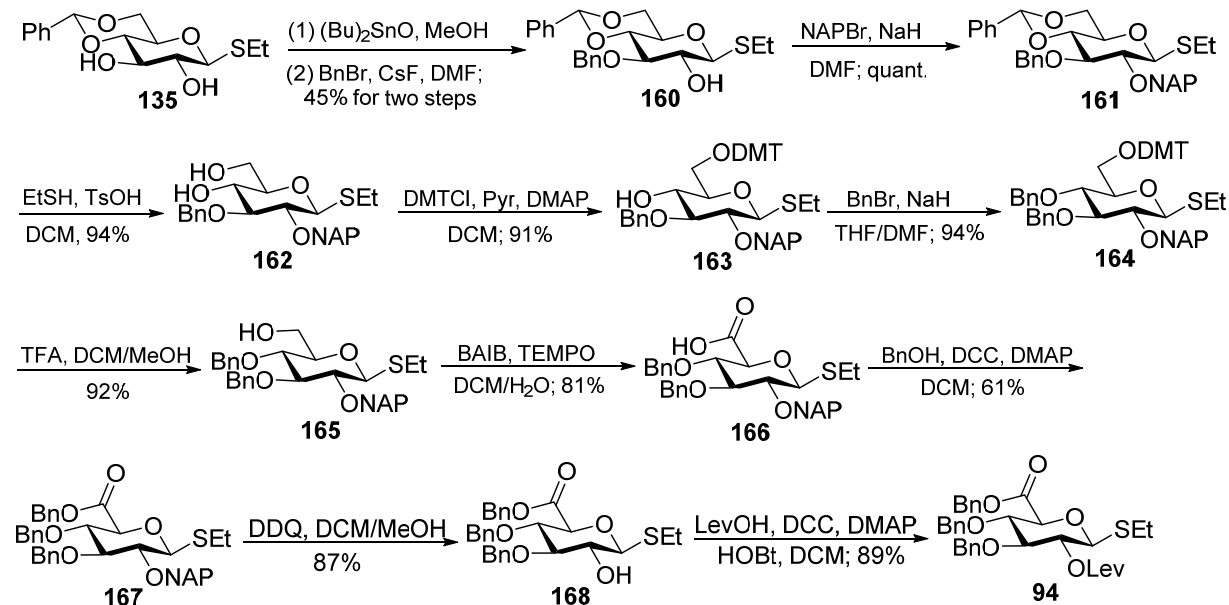

Figure 7.2: Retrosynthetic analysis of ST-5 repeating unit **156**.

Glucosyl building block **91** was prepared by following the established procedure.²²⁵

The synthesis of building block **94** commenced with ethyl 4,6-*O*-benzylidene-1-thio- β -D-glycopyranoside²⁵⁵ **135** (Scheme 7.1). Benzyl group was regioselectively installed at the C-3 position of the diol **135** using tin-mediated method to produce **160**²⁶⁵, which was treated with NAPBr in the presence of sodium hydride to obtain **161**. Attempts to open benzylidene acetal with borane and TMSOTf to get **165** directly failed due to the impurity

of commercial reagent borane in THF. Therefore a circuitous strategy using DMT as temporary protecting group was applied to furnish **165** in four steps. TEMPO-mediated oxidation of primary C6 hydroxyl group resulted in the carboxylic acid derivative **166**, which was further coupled with benzyl alcohol to yield **167**. Building block **94** was achieved by conversion of NAP group into with levulinoyl group at the C-2 position.



Scheme 7.1: Synthesis of building block **94**.

Further studies of this project were mainly carried out by Dr. Marilda P. Lisboa and Dr. Naeem Khan. This study was published in journal of *Proceedings of the National Academy of Sciences of the United States of America* (see appendix).²⁶⁶

7.3 Experimental section

Ethyl 3-*O*-benzyl-4,6-*O*-benzylidene-2-*O*-(2-naphthylmethyl)-1-thio- β -D-glucopyranoside (161**)**

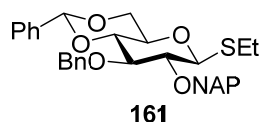

Sodium hydride was added to a solution of compound **160** (1.0 g, 2.48 mmol) in DMF (20 mL) at 0 °C. The reaction mixture was stirred for 15 min at room temperature followed by the addition of 2-naphthylmethyl bromide (824 mg, 3.73 mmol). The mixture was stirred for 2 h, quenched with saturated aqueous NH₄Cl solution and extracted three times with ethyl acetate. The combined organic layer was washed with brine, dried over Na₂SO₄, filtered and concentrated in *vacuo*. The residue was purified by flash column chromatography with 15% ethyl acetate in hexanes to get compound **161** (1.31 g, 2.42 mmol, 97%) as a pale yellow solid.

$[\alpha]_D^{25}$ -10.04° (*c* 1.02, CHCl₃); ¹H NMR (400 MHz, CDCl₃) δ 7.90 – 7.67 (m, 4H), 7.58 – 7.42 (m, 5H), 7.42 – 7.21 (m, 8H), 5.59 (s, 1H), 5.04 (d, *J* = 10.4 Hz, 1H), 5.01 – 4.92 (m, 2H), 4.82 (d, *J* = 11.3 Hz, 1H), 4.60 (d, *J* = 9.8 Hz, 1H), 4.37 (dd, *J* = 10.4, 4.8 Hz, 1H), 3.89 – 3.66 (m, 3H), 3.58 – 3.37 (m, 2H), 2.89 – 2.64 (m, 2H), 1.33 (t, *J* = 7.3 Hz, 3H); ¹³C NMR (100 MHz, CDCl₃) δ 138.5, 137.4, 135.6, 133.4, 133.2, 129.1, 128.5, 128.4, 128.2, 128.1, 127.9, 127.8, 127.1, 126.5, 126.1 (2C), 126.0, 101.2, 86.0, 82.9, 81.7, 81.4, 76.2, 75.4, 70.4, 68.8, 25.3, 15.3; HMRS (ESI) calcd for C₃₃H₃₄O₅SK [M+K]⁺ 581.1764; found: 581.1744.

Ethyl 3-*O*-benzyl-2-*O*-(2-naphthylmethyl)-1-thio-β-D-glucopyranoside (**162**)

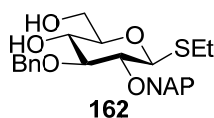

Ethanethiol (8.5 mL, 115 mmol) and *p*-toluenesulfonic acid (219 mg, 1.15 mmol) were added to a solution of thioglycoside **161** (3.13 g, 5.77 mmol) in dichloromethane (20 mL) at 0 °C. The reaction mixture was stirred for 30 min, quenched with triethylamine and concentrated under vacuum. The residue was purified by flash column chromatography with 60% ethyl acetate in hexanes to afford compound **162** (2.48 g, 5.45 mmol, 94%) as a white solid.

$[\alpha]_D^{25}$ -17.78° (*c* 1.17, CHCl₃); ¹H NMR (400 MHz, CDCl₃) δ 7.86 – 7.73 (m, 4H), 7.52 (d, *J* = 8.4 Hz, 1H), 7.49 – 7.41 (m, 2H), 7.39 – 7.25 (m, 5H), 5.10 (d, *J* = 10.4 Hz, 1H), 4.98 (d, *J* = 11.6 Hz, 1H), 4.87 (d, *J* = 10.4 Hz, 1H), 4.72 (d, *J* = 11.6 Hz, 1H), 4.54 (d, *J* = 9.5 Hz, 1H), 3.87 (dd, *J* = 11.9, 3.4 Hz, 1H), 3.75 (dd, *J* = 11.9, 5.1 Hz, 1H), 3.58 (t, *J* = 9.1 Hz, 1H), 3.51 (t, *J* = 8.7 Hz, 1H), 3.44 (t, *J* = 9.0 Hz, 1H), 3.39 – 3.29 (m, 1H), 2.86 – 2.63 (m, 2H), 2.07 (s, 2H), 1.33 (t, *J* = 7.4 Hz, 3H); ¹³C NMR (100 MHz, CDCl₃) δ 138.5, 135.4, 133.4, 133.2, 128.9, 128.3, 128.2, 128.1, 128.0, 127.8, 127.2, 126.4, 126.2, 126.1, 86.0, 85.5, 81.7, 79.2, 75.6, 75.5, 70.7, 62.9, 25.4, 15.3; HMRS (ESI) calcd for C₂₆H₃₀O₅SK [M+K]⁺ 493.1451; found: 493.1448.

Ethyl 3,4-di-*O*-benzyl-2-*O*-(2-naphthylmethyl)-1-thio-β-D-glucopyranoside (**165**)

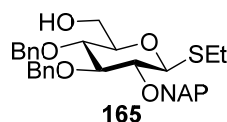

To a solution of compound **162** (500 mg, 1.1 mmol) in dichloromethane (10 mL) were added DMAP (27 mg, 0.22 mmol) and pyridine (0.45 mL, 5.5 mmol). The reaction mixture was stirred for 5 min, and then DMTCl (373 mg, 1.0 mmol) was added and the reaction was stirred for another 2 h. The reaction mixture was quenched with saturated aqueous NaHCO₃ solution, and extracted three times with dichloromethane. The combined organic layer was washed with brine, dried over Na₂SO₄, filtered and concentrated. The crude residue was purified by flash column chromatography using 20-25% ethyl acetate in hexanes to yield compound **163** (754 mg, 0.99 mmol, 91%) as a slightly yellow solid.

NaH (155 mg, 3.89 mmol, 60% in mineral oil) was added to a solution of **163** (735 mg, 0.97 mmol) in a mixture of THF (15 mL) and DMF (6 mL) at 0 °C. After 10 min, benzyl bromide (350 μL, 2.91 mmol) was added and the reaction mixture was stirred at room temperature for 30 min. The reaction was quenched with water at 0 °C, and the aqueous layer was extracted three times with dichloromethane. The combined organic layer was washed with brine, dried over Na₂SO₄, filtered and concentrated. The crude residue was purified by flash column chromatography using 10-20% ethyl acetate in hexanes to obtain compound **164** (773 mg, 0.91 mmol, 94%) as a white solid.

Compound **164** (660 mg, 0.78 mmol) was dissolved in a mixture of dichloromethane (8 mL) and methanol (1 mL) followed by the addition of TFA (66 μ L, 0.86 mmol). The reaction mixture was stirred for 2 h and quenched with saturated aqueous NaHCO₃ solution. The reaction mixture was extracted three times with dichloromethane. The combined organic layer was washed with brine, dried over Na₂SO₄, filtered and concentrated. The crude residue was purified by flash column chromatography using 20-25% ethyl acetate to afford the compound **165** (392 mg, 0.72 mmol, 92%) as a white solid.

$[\alpha]_D^{25}$ 24.84° (*c* 12.5, CHCl₃); ¹H NMR (400 MHz, CDCl₃) δ 7.87 – 7.70 (m, 4H), 7.57 – 7.40 (m, 3H), 7.39 – 7.19 (m, 10H), 5.07 (d, *J* = 10.4 Hz, 1H), 4.99 – 4.82 (m, 4H), 4.66 (d, *J* = 10.9 Hz, 1H), 4.53 (d, *J* = 9.8 Hz, 1H), 3.87 (dd, *J* = 12.0, 2.4 Hz, 1H), 3.77 – 3.66 (m, 2H), 3.59 (t, *J* = 9.4 Hz, 1H), 3.46 (t, *J* = 9.3 Hz, 1H), 3.41 – 3.34 (m, 1H), 2.92 – 2.61 (m, 2H), 1.81 (s, 1H), 1.33 (t, *J* = 7.4 Hz, 3H); ¹³C NMR (100 MHz, CDCl₃) δ 138.5, 138.0, 135.5, 133.4, 133.2, 128.7, 128.6, 128.3, 128.2, 128.1, 128.0, 127.9, 127.8 (2C), 127.2, 126.4, 126.2, 126.1, 86.6, 85.4, 81.9, 79.4, 75.9, 75.8, 75.3, 62.3, 25.4, 15.3; HMRS (ESI) calcd for C₃₃H₃₆O₅SNa [M+Na]⁺ 567.2181; found: 567.2196.

Ethyl 3,4-di-*O*-benzyl-2-*O*-(2-naphthylmethyl)-1-thio- β -D-glucopyranosiduronic acid (**166**)

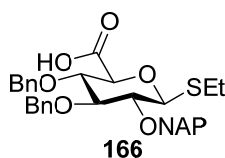

Compound **165** (392 mg, 0.72 mmol) was dissolved in dichloromethane (5 mL) and water (1 mL). 2,2,6,6-Tetramethylpiperidine 1-oxyl (TEMPO) (11 mg, 0.07 mmol) was added followed by (diacetoxyiodo)benzene (BAIB) (370 mg, 1.15 mmol) at 0 °C. The reaction mixture was warmed to room temperature after 15 minutes. Additional BAIB (105 mg, 0.33 mmol) and TEMPO (11 mg, 0.07 mmol) were added. After 4 h, the reaction mixture was concentrated under vacuum and the residue was purified by flash column chromatography with 20-25% ethyl acetate in hexanes (5% acetic acid) to obtain compound **166** (326 mg, 0.58 mmol, 81%) as a white solid.

$[\alpha]_D^{25}$ -14.32° (*c* 0.7, CHCl₃); ¹H NMR (400 MHz, CDCl₃) δ 7.89 – 7.69 (m, 4H), 7.56 – 7.40 (m, 3H), 7.37 – 7.14 (m, 10H), 5.06 (d, *J* = 10.5 Hz, 1H), 4.94 – 4.73 (m, 4H), 4.65 (d, *J* = 10.7 Hz, 2H), 3.98 (d, *J* = 9.2 Hz, 1H), 3.85 (t, *J* = 9.0 Hz, 1H), 3.74 (t, *J* = 8.5 Hz, 1H), 3.54 (t, *J* = 8.9 Hz, 1H), 2.81 (brs, 2H), 1.33 (t, *J* = 7.3 Hz, 3H); ¹³C NMR (100 MHz, CDCl₃) δ 172.8, 138.2, 137.4, 135.3, 133.4, 133.2, 128.6, 128.6, 128.3, 128.2, 128.1, 127.9, 127.86 (2C), 127.2, 126.4, 126.2, 126.1, 85.7, 85.4, 81.2, 78.8, 75.8, 75.7, 75.2, 25.4, 15.3; HMRS (ESI) calcd for C₃₃H₃₄O₆SK [M+K]⁺ 597.1713; found: 597.1901.

Benzyl (ethyl 3,4-di-*O*-benzyl-2-*O*-(2-naphthylmethyl)-1-thio-β-D-glucopyranosid) urinate (167)

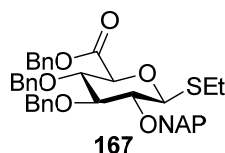

To a solution of **166** (500 mg, 0.89 mmol) in dichloromethane (5 mL) were added benzyl alcohol (190 μL, 1.79 mmol), dicyclohexylcarbodiimide (DCC) (277 mg, 1.34 mmol), DMAP (22 mg, 0.18 mmol) and hydroxybenzotriazole (HOBt) (274 mg, 1.79 mmol) at 0 °C. The reaction mixture was slowly warmed to room temperature and stirred overnight. The reaction was quenched with water and extracted three times with dichloromethane. The combined organic layer was dried over Na₂SO₄, filtered, and concentrated. The residue was purified by flash column chromatography using 5-10% ethyl acetate in hexanes to afford compound **167** (580 mg, 0.89 mmol, quantitative) as a white solid.

$[\alpha]_D^{25}$ 1.59° (*c* 2.77, CHCl₃); ¹H NMR (400 MHz, CDCl₃) δ 7.92 – 7.66 (m, 4H), 7.57 – 7.38 (m, 3H), 7.38 – 7.17 (m, 13H), 7.15 – 7.03 (m, 2H), 5.24 – 5.10 (m, 2H), 5.06 (d, *J* = 10.4 Hz, 1H), 4.94 – 4.79 (m, 3H), 4.72 (d, *J* = 10.7 Hz, 1H), 4.53 (d, *J* = 9.7 Hz, 1H), 4.48 (d, *J* = 10.7 Hz, 1H), 3.94 (d, *J* = 9.7 Hz, 1H), 3.87 (t, *J* = 9.3 Hz, 1H), 3.70 (t, *J* = 8.8 Hz, 1H), 3.53 (t, *J* = 9.2 Hz, 1H), 2.90 – 2.62 (m, 2H), 1.31 (t, *J* = 7.4 Hz, 3H); ¹³C NMR (100 MHz, CDCl₃) δ 168.3, 138.4, 137.9, 135.4, 135.2, 133.4, 133.2, 128.7, 128.7, 128.6, 128.6, 128.5, 128.3, 128.1, 128.0, 127.9, 127.8 (2C), 127.2, 126.4, 126.2, 126.1, 86.0, 85.9, 81.3, 79.5, 78.3, 76.0, 75.8, 75.2, 67.5, 25.3, 15.2; HMRS (ESI) calcd for C₄₀H₄₀O₆SNa [M+Na]⁺ 671.2443; found: 671.2404.

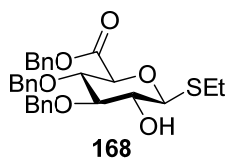
Benzyl (ethyl 3,4-di-*O*-benzyl-1-thio- β -D-glucopyranosid) urinate (168)

2,3-Dichloro-5,6-dicyano-1,4-benzoquinone (DDQ) (2.2 g, 9.71 mmol) was added to a solution of compound **167** (2.1 g, 3.24 mmol) in a mixture of dichloromethane (28 mL) and methanol (7 mL) at 0 °C. The reaction was slowly warmed to room temperature and stirred for 2 h. Then, the reaction was washed with saturated aqueous NaHCO₃ solution until it was clear. The organic layer was dried over Na₂SO₄, filtered and concentrated. The residue was purified by flash column chromatography with 25% ethyl acetate in hexanes to yield compound **168** (1.35 g, 2.65 mmol, 82%) as a white solid.

$[\alpha]_D^{25}$ -31.33° (*c* 1.48, CHCl₃); ¹H NMR (400 MHz, CDCl₃) δ 7.49 – 7.16 (m, 13H), 7.15 – 7.03 (m, 2H), 5.24 – 5.07 (m, 2H), 4.90 (d, *J* = 11.3 Hz, 1H), 4.82 (d, *J* = 11.3 Hz, 1H), 4.73 (d, *J* = 10.7 Hz, 1H), 4.46 (d, *J* = 10.7 Hz, 1H), 4.38 – 4.27 (m, 1H), 3.94 (d, *J* = 9.8 Hz, 1H), 3.88 – 3.76 (m, 1H), 3.64 – 3.48 (m, 2H), 2.82 – 2.58 (m, 2H), 1.28 (t, *J* = 7.4 Hz, 3H); ¹³C NMR (100 MHz, CDCl₃) δ 168.2, 138.4, 137.8, 135.1, 128.7, 128.7, 128.6 (2C), 128.5, 128.1, 128.0, 127.9, 86.9, 85.2, 79.0, 78.6, 75.4, 75.2, 72.9, 67.5, 24.6, 15.4; HMRS (ESI) calcd for C₂₉H₃₂O₆SK [M+K]⁺ 547.1556; found: 547.1514.

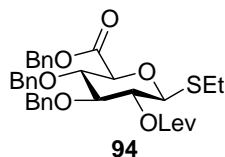
Benzyl (ethyl 3,4-di-*O*-benzyl-2-*O*-levulinoyl-1-thio- β -D-glucopyranosid) urinate (94)

To a solution of compound **168** (1.3 g, 2.56 mmol) in dichloromethane (15 mL) were added DMAP (62 mg, 0.511 mmol), levulinic acid (0.53 mL, 5.11 mmol), and DCC (791 mg, 3.83 mmol). The mixture was stirred for 2 h at room temperature, filtered and concentrated under vacuum. The residue was purified by flash column chromatography with

25% ethyl acetate in hexanes to obtain building block **94** (1.4 g, 2.31 mmol, 90%) as a white solid.

$[\alpha]_D^{25}$ -42.85° (c 0.22, CHCl_3); ^1H NMR (400 MHz, CDCl_3) δ 7.52 – 7.17 (m, 13H), 7.16 – 7.00 (m, 2H), 5.16 (s, 2H), 5.05 (t, $J = 9.5$ Hz, 1H), 4.76 (d, $J = 11.4$ Hz, 1H), 4.73 – 4.63 (m, 2H), 4.45 (d, $J = 10.7$ Hz, 1H), 4.40 (d, $J = 10.0$ Hz, 1H), 3.95 (d, $J = 9.7$ Hz, 1H), 3.89 (t, $J = 9.2$ Hz, 1H), 3.68 (t, $J = 8.9$ Hz, 1H), 2.80 – 2.57 (m, 4H), 2.57 – 2.39 (m, 2H), 2.15 (s, 3H), 1.22 (t, $J = 7.4$ Hz, 3H); ^{13}C NMR (100 MHz, CDCl_3) δ 206.2, 171.6, 167.9, 138.0, 137.6, 135.1, 128.7, 128.6 (2C), 128.5, 128.4, 128.1, 128.0, 127.9, 127.8, 84.2, 83.4, 79.3, 78.5, 75.3, 75.2, 71.6, 67.5, 37.9, 30.0, 28.1, 24.0, 14.9; HMRS (ESI) calcd for $\text{C}_{34}\text{H}_{38}\text{O}_8\text{SK}$ $[\text{M}+\text{K}]^+$ 645.1925; found: 645.1935

References

1. Schmidt, M. A.; Riley, L. W.; Benz, I., *Trends Microbiol.* **2003**, *11*, 554-561.
2. Ryder, C.; Byrd, M.; Wozniak, D. J., *Curr. Opin. Microbiol.* **2007**, *10*, 644-648.
3. Weintraub, A., *Carbohydr. Res.* **2003**, *338*, 2539-2547.
4. Chapot-Chartier, M.-P., *Front Microbiol.* **2014**, *5*, 236.
5. Heidelberger, M.; Avery, O. T., *J. Exp. Med.* **1923**, *38*, 73-79.
6. Adlam, C.; Knights, J. M.; Mugridge, A.; Williams, J. M.; Lindon, J. C., *FEMS Microbiol. Lett.* **1987**, *42*, 23-25.
7. Bhattacharjee, A. K.; Jennings, H. J.; Kenny, C. P.; Martin, A.; Smith, I. C., *J. Biol. Chem.* **1975**, *250*, 1926-32.
8. Dmitriev, B. A.; Knirel, Y. A.; Kochetkov, N. K.; Hofman, I. L., *Eur. J. Biochem.* **1976**, *66*, 559-566.
9. Zamenhof, S.; Leidy, G.; Fitzgerald, P. L.; Alexander, H. E.; Chargaff, E., *J. Biol. Chem.* **1953**, *203*, 695-704.
10. Barker, S. A.; Bick, S. M.; Brimacombe, J. S.; How, M. J.; Stacey, M., *Carbohydr. Res.* **1966**, *2*, 224-233.
11. Jansson, P.-E.; Lindberg, B.; Lindquist, U., *Carbohydr. Res.* **1985**, *140*, 101-110.
12. Tillett, W. S.; Francis, T., *J. Exp. Med.* **1929**, *50*, 687-701.
13. Finland, M.; Dowling, H. F., *J. Immunol.* **1935**, *29*, 285-299.
14. Heidelberger, M.; Dilapi, M. M.; Siegel, M.; Walter, A. W., *J. Immunol.* **1950**, *65*, 535-541.
15. Astronomo, R. D.; Burton, D. R., *Nat. Rev. Drug Discov.* **2010**, *9*, 308-324.
16. Robbins, J. B.; Austrian, R.; Lee, C. J.; Rastogi, S. C.; Schiffman, G.; Henrichsen, J.; Makela, P. H.; Broome, C. V.; Facklam, R. R.; Tiesjema, R. H.; Parke, J. J. C., *J. Infect. Dis.* **1983**, *148*, 1136-1159.
17. Co., M., *Merck website* **1986**.
18. Ada, G.; Isaacs, D., *Clin. Microbiol. Infect.* **2003**, *9*, 79-85.
19. Duan, J.; Avci, F. Y.; Kasper, D. L., *Proc. Natl. Acad. Sci. USA* **2008**, *105*, 5183-5188.
20. Coutinho, A.; Moller, G., *Nature: New biology* **1973**, *245*, 12-4.

21. Wessels, M. R.; Paoletti, L. C.; Rodewald, A. K.; Michon, F.; Difabio, J.; Jennings, H. J.; Kasper, D. L., *Infect. Immun.* **1993**, *61*, 4760-4766.
22. Beuvery, E. C.; Vanrossum, F.; Nagel, J., *Infect. Immun.* **1982**, *37*, 15-22.
23. Schneerson, R.; Barrera, O.; Sutton, A.; Robbins, J. B., *J. Exp. Med.* **1980**, *152*, 361-376.
24. Mitchison, N. A., *Eur. J. Immunol.* **1971**, *1*, 10-17.
25. Mitchison, N. A., *Eur. J. Immunol.* **1971**, *1*, 18-27.
26. Trotter, C. L.; McVernon, J.; Ramsay, M. E.; Whitney, C. G.; Mulholland, E. K.; Goldblatt, D.; Hombach, J.; Kieny, M. P.; Subgrp, S., *Vaccine* **2008**, *26*, 4434-4445.
27. Malito, E.; Bursulaya, B.; Chen, C.; Surdo, P. L.; Picchianti, M.; Balducci, E.; Biancucci, M.; Brock, A.; Berti, F.; Bottomley, M. J.; Nissum, M.; Costantino, P.; Rappuoli, R.; Spraggon, G., *Proc. Natl. Acad. Sci. USA* **2012**, *109*, 5229-5234.
28. Avci, F. Y.; Li, X.; Tsuji, M.; Kasper, D. L., *Nat. Med.* **2011**, *17*, 1602.
29. Berti, F.; Adamo, R., *ACS Chem. Biol.* **2013**, *8*, 1653-1663.
30. Tree, J. A.; Richardson, C.; Fooks, A. R.; Clegg, J. C.; Looby, D., *Vaccine* **2001**, *19*, 3444-3450.
31. Gonçalves, V. M.; Zangirolami, T. C.; Giordano, R. L. C.; Raw, I.; Tanizaki, M. M.; Giordano, R. C., *Appl. Microbiol. Biotechnol.* **2002**, *59*, 713-717.
32. Pujar, N. S.; Huang, N. F.; Daniels, C. L.; Dieter, L.; Gayton, M. G.; Lee, A. L., *Biopolymers* **2004**, *75*, 71-84.
33. Sturgess, A. W.; Rush, K.; Charbonneau, R. J.; Lee, J. I.; West, D. J.; Sitrin, R. D.; Hennessey, J. P., *Vaccine* **1999**, *17*, 1169-1178.
34. Wessels, M. R.; Paoletti, L. C.; Guttormsen, H.-K.; Michon, F.; D'Ambra, A. J.; Kasper, D. L., *Infect. Immun.* **1998**, *66*, 2186-2192.
35. Vince, P., *Curr. Top. Med. Chem.* **2008**, *8*, 126-140.
36. Verez-Bencomo, V.; Fernández-Santana, V.; Hardy, E.; Toledo, M. E.; Rodríguez, M. C.; Heynngnezz, L.; Rodriguez, A.; Baly, A.; Herrera, L.; Izquierdo, M.; Villar, A.; Valdés, Y.; Cosme, K.; Deler, M. L.; Montane, M.; Garcia, E.; Ramos, A.; Aguilar, A.; Medina, E.; Toraño, G.; Sosa, I.; Hernandez, I.; Martínez, R.; Muzachio, A.; Carmenates, A.; Costa, L.; Cardoso, F.; Campa, C.; Diaz, M.; Roy, R., *Science* **2004**, *305*, 522-525.
37. Huang, Y.-L.; Wu, C.-Y., *Expert Rev. Vaccines.* **2010**, *9*, 1257-1274.
38. Anish, C.; Schumann, B.; Pereira, C. L.; Seeberger, P. H., *Chem. Biol.* **2014**, *21*, 38-50.

39. Geissner, A.; Anish, C.; Seeberger, P. H., *Curr. Opin. Chem. Biol.* **2014**, *18*, 38-45.
40. Wang, D.; Liu, S.; Trummer, B. J.; Deng, C.; Wang, A., *Nat. Biotechnol.* **2002**, *20*, 275.
41. Wu, C.-Y.; Liang, P.-H.; Wong, C.-H., *Org. Biomol. Chem.* **2009**, *7*, 2247-2254.
42. Rillahan, C. D.; Paulson, J. C., *Annu. Rev. Biochem.* **2011**, *80*, 797-823.
43. Anish, C.; Guo, X.; Wahlbrink, A.; Seeberger, P. H., *Angew. Chem., Int. Ed.* **2013**, *52*, 9524-9528.
44. Martin, C. E.; Broecker, F.; Eller, S.; Oberli, M. A.; Anish, C.; Pereira, C. L.; Seeberger, P. H., *Chem. Commun.* **2013**, *49*, 7159-7161.
45. Martin, C. E.; Broecker, F.; Oberli, M. A.; Komor, J.; Mattner, J.; Anish, C.; Seeberger, P. H., *J. Am. Chem. Soc.* **2013**, *135*, 9713-9722.
46. Martin, C. E. Chemical Synthesis and Biological Evaluation of Cell Surface Carbohydrate Antigens for Rational Vaccine Design. Dissertation, Freie Universität Berlin, Germany, 2014.
47. Pozsgay, V.; Kubler-Kielb, J., Conjugation Methods toward Synthetic Vaccines. In *Carbohydrate-Based Vaccines*, American Chemical Society 2008; Vol. 989, pp 36-70.
48. Davis, B. G., *Chem. Rev.* **2002**, *102*, 579-602.
49. Joseph, M. L.; Jon, S. T., *Curr. Org. Synth.* **2005**, *2*, 59-81.
50. Tietze, L. F.; Arlt, M.; Beller, M.; Gl üsenkamp, K.-H.; Jähde, E.; Rajewsky, M. F., *Chem. Ber.* **1991**, *124*, 1215-1221.
51. Kamath, V. P.; Diedrich, P.; Hindsgaul, O., *Glycoconjugate J.* **1996**, *13*, 315-319.
52. Nitz, M.; Bundle, D. R., *J. Org. Chem.* **2001**, *66*, 8411-8423.
53. Wu, X.; Ling, C.-C.; Bundle, D. R., *Org. Lett.* **2004**, *6*, 4407-4410.
54. Safari, D.; Dekker, H. A. T.; Rijkers, G.; Snippe, H., *Vaccine* **2011**, *29*, 849-854.
55. Organization, W. H., *WHO Tech. Rep. Ser.* **2005**, *927*, 32-62.
56. Schumann, B.; Hahm, H. S.; Parameswarappa, S. G.; Reppe, K.; Wahlbrink, A.; Govindan, S.; Kaplonek, P.; Pirofski, L.-a.; Witzenrath, M.; Anish, C.; Pereira, C. L.; Seeberger, P. H., *Sci. Transl. Med.* **2017**, *9*.
57. Koenigs, W.; Knorr, E., *Ber. Dtsch. Chem. Ges.* **1901**, *34*, 957-981.
58. Zhu, X.; Schmidt, R. R., *Angew. Chem., Int. Ed.* **2009**, *48*, 1900-1934.
59. Das, R.; Mukhopadhyay, B., *ChemistryOpen* **2016**, *5*, 401-433.
60. Fischer, E.; Armstrong, E. F., *Ber. Dtsch. Chem. Ges.* **1901**, *34*, 2885-2900.
61. Paulsen, H., *Angew. Chem., Int. Ed. Engl.* **1982**, *21*, 155-173.

62. Teruaki, M.; Yoshiyuki, M.; Shin-ichiro, S., *Chem. Lett.* **1981**, *10*, 431-432.
63. Ferrier, R. J.; Hay, R. W.; Vethaviasar, N., *Carbohydr. Res.* **1973**, *27*, 55-61.
64. Schmidt, R. R.; Michel, J., *Angew. Chem., Int. Ed. Engl.* **1980**, *19*, 731-732.
65. Lee, J.-C.; Pan, G.-R.; Kulkarni, S. S.; Luo, S.-Y.; Liao, C.-C.; Hung, S.-C., *Tetrahedron Lett.* **2006**, *47*, 1621-1624.
66. Hotha, S.; Kashyap, S., *J. Am. Chem. Soc.* **2006**, *128*, 9620-9621.
67. Kondo, H.; Ichikawa, Y.; Wong, C. H., *J. Am. Chem. Soc.* **1992**, *114*, 8748-8750.
68. Hashimoto, S.-i.; Honda, T.; Ikegami, S., *J. Chem. Soc., Chem. Commun.* **1989**, 685-687.
69. Ferrier, R. J.; Overend, W. G.; Ryan, A. E., *J. Chem. Soc.* **1962**, 3667-3670.
70. Codee, J. D. C.; Litjens, R. E. J. N.; van den Bos, L. J.; Overkleeft, H. S.; van der Marel, G. A., *Chem. Soc. Rev.* **2005**, *34*, 769-782.
71. Zhang, Z.; Ollmann, I. R.; Ye, X.-S.; Wischnat, R.; Baasov, T.; Wong, C.-H., *J. Am. Chem. Soc.* **1999**, *121*, 734-753.
72. Lian, G.; Zhang, X.; Yu, B., *Carbohydr. Res.* **2015**, *403*, 13-22.
73. Frihed, T. G.; Pedersen, C. M.; Bols, M., *Angew. Chem., Int. Ed.* **2014**, *53*, 13889-13893.
74. Boons, G.-J., *Contemp. Org. Synth.* **1996**, *3*, 173-200.
75. Goodman, L., Neighboring-Group Participation in Sugars. In *Advances in Carbohydrate Chemistry*, Wolfrom, M. L.; Tipson, R. S., Eds. Academic Press 1967; Vol. 22, pp 109-175.
76. Nukada, T.; Berces, A.; Zgierski, M. Z.; Whitfield, D. M., *J. Am. Chem. Soc.* **1998**, *120*, 13291-13295.
77. Demchenko, A. V.; Rousson, E.; Boons, G.-J., *Tetrahedron Lett.* **1999**, *40*, 6523-6526.
78. Yasomanee, J. P.; Demchenko, A. V., *J. Am. Chem. Soc.* **2012**, *134*, 20097-20102.
79. Imamura, A.; Ando, H.; Ishida, H.; Kiso, M., *Org. Lett.* **2005**, *7*, 4415-4418.
80. Baek, J. Y.; Lee, B.-Y.; Jo, M. G.; Kim, K. S., *J. Am. Chem. Soc.* **2009**, *131*, 17705-17713.
81. Andersson, F.; Fúgedi, P.; Garegg, P. J.; Nashed, M., *Tetrahedron Lett.* **1986**, *27*, 3919-3922.
82. Kafle, A.; Liu, J.; Cui, L., *Can. J. Chem.* **2016**, *94*, 894-901.
83. Manabe, S.; Ito, Y.; Ogawa, T., *Synlett* **1998**, *1998*, 628-630.
84. Ishiwata, A.; Munemura, Y.; Ito, Y., *Tetrahedron* **2008**, *64*, 92-102.

85. Demchenko, A.; Stauch, T.; Boons, G.-J., *Synlett* **1997**, *1997*, 818-820.
86. Chao, C.-S.; Lin, C.-Y.; Mulani, S.; Hung, W.-C.; Mong, K.-k. T., *Chem. Eur. J.* **2011**, *17*, 12193-12202.
87. Seeberger, P. H.; Haase, W.-C., *Chem. Rev.* **2000**, *100*, 4349-4394.
88. Schuerch, C.; Frechet, J. M., *J. Am. Chem. Soc.* **1971**, *93*, 492-496.
89. Yan, L.; Taylor, C. M.; Goodnow, R.; Kahne, D., *J. Am. Chem. Soc.* **1994**, *116*, 6953-6954.
90. Kononov, L. O.; Ito, Y.; Ogawa, T., *Tetrahedron Lett.* **1997**, *38*, 1599-1602.
91. Doi, T.; Sugiki, M.; Yamada, H.; Takahashi, T.; Porco, J. A., *Tetrahedron Lett.* **1999**, *40*, 2141-2144.
92. Nukada, T.; Berces, A.; Whitfield, D. M., *J. Org. Chem.* **1999**, *64*, 9030-9045.
93. Danishefsky, S.; McClure, K.; Randolph, J.; Ruggeri, R., *Science* **1993**, *260*, 1307-1309.
94. Plante, O. J.; Palmacci, E. R.; Seeberger, P. H., *Science* **2001**, *291*, 1523-1527.
95. Krock, L.; Esposito, D.; Castagner, B.; Wang, C.-C.; Bindschadler, P.; Seeberger, P. H., *Chem. Sci.* **2012**, *3*, 1617-1622.
96. Eller, S.; Collot, M.; Yin, J.; Hahm, H. S.; Seeberger, P. H., *Angew. Chem., Int. Ed.* **2013**, *52*, 5858-5861.
97. Naresh, K.; Schumacher, F.; Hahm, H. S.; Seeberger, P. H., *Chem. Commun.* **2017**, *53*, 9085-9088.
98. AlonsoDeVelasco, E.; Verheul, A. F.; Verhoef, J.; Snippe, H., *Microbiol Rev* **1995**, *59*, 591-603.
99. Inostroza, J.; Vinet, A. M.; Retamal, G.; Lorca, P.; Ossa, G.; Facklam, R. R.; Sorensen, R. U., *Clin. Diagn. Lab. Immunol.* **2001**, *8*, 556-559.
100. Hausdorff, W. P.; Bryant, J.; Paradiso, P. R.; Siber, G. R., *Clin. Infect. Dis.* **2000**, *30*, 100-21.
101. Boulnois, G. J., *Microbiology* **1992**, *138*, 249-259.
102. Walker, C. L. F.; Rudan, I.; Liu, L.; Nair, H.; Theodoratou, E.; Bhutta, Z. A.; O'Brien, K. L.; Campbell, H.; Black, R. E., *The Lancet* **2013**, *381*, 1405-1416.
103. Ovodov, Y. S., *Biochemistry (Moscow)* **2006**, *71*, 937.
104. Bentley, S. D.; Aanensen, D. M.; Mavroidi, A.; Saunders, D.; Rabinowitsch, E.; Collins, M.; Donohoe, K.; Harris, D.; Murphy, L.; Quail, M. A.; Samuel, G.; Skovsted, I. C.; Kalltoft, M. S.; Barrell, B.; Reeves, P. R.; Parkhill, J.; Spratt, B. G., *PLoS Genet.* **2006**, *2*, e31.

105. Hausdorff, W. P.; Feikin, D. R.; Klugman, K. P., *Lancet. Infect. Dis.* **2005**, *5*, 83-93.
106. Johnson, H. L.; Deloria-Knoll, M.; Levine, O. S.; Stoszek, S. K.; Freimanis Hance, L.; Reithinger, R.; Muenz, L. R.; O'Brien, K. L., *PLoS Med* **2010**, *7*, e1000348.
107. Watson, D. A.; Musher, D. M., *Infect. Immun.* **1990**, *58*, 3135-3138.
108. Avery, O. T.; Dubos, R., *J. Exp. Med.* **1931**, *54*, 73-89.
109. AlonsoDeVelasco, E.; Verheul, A. F.; Verhoef, J.; Snippe, H., *Microbiol. Rev.* **1995**, *59*, 591-603.
110. van Dam, J. E.; Fleer, A.; Snippe, H., *Antonie Van Leeuwenhoek* **1990**, *58*, 1-47.
111. Bridy-Pappas, A. E.; Margolis, M. B.; Center, K. J.; Isaacman, D. J., *Pharmacother.* **2005**, *25*, 1193-1212.
112. Jauneikaite, E.; Jefferies, J. M.; Hibberd, M. L.; Clarke, S. C., *Vaccine* **2012**, *30*, 3503-3514.
113. Moore, C. E.; Giess, A.; Soeng, S.; Sar, P.; Kumar, V.; Nhoung, P.; Bousfield, R.; Turner, P.; Stoesser, N.; Day, N. P.; Parry, C. M., *PloS one* **2016**, *11*, e0159358.
114. Kim, C. J.; Song, J.-S.; Choi, S.-J.; Song, K. H.; Choe, P. G.; Park, W. B.; Bang, J. H.; Kim, E. S.; Park, S. W.; Kim, H. B.; Kim, N.-J.; Kim, E.-C.; Oh, M.-d., *J. Korean Med. Sci.* **2016**, *31*, 715-723.
115. Mehr, S.; Wood, N., *Paediatr. Respir. Rev.* **2012**, *13*, 258-264.
116. Lindberg, B.; Lonngren, J.; Powell, D. A., *Carbohydr. Res.* **1977**, *58*, 177-186.
117. Laferriere, C. A.; Sood, R. K.; de Muys, J.-M.; Michon, F.; Jennings, H. J., *Infect. Immun.* **1998**, *66*, 2441-2446.
118. Verheul, A. F.; Versteeg, A. A.; De Reuver, M. J.; Jansze, M.; Snippe, H., *Infect. Immun.* **1989**, *57*, 1078-1083.
119. Verheul, A. M.; Versteeg, A. A.; Westerdaal, N. A. C.; Van Dam, G. J.; Jansze, M.; Snippe, H., *J. Immunol. Methods* **1990**, *126*, 79-87.
120. Mawas, F.; Niggemann, J.; Jones, C.; Corbel, M. J.; Kamerling, J. P.; Vliegenthart, J. F. G., *Infect. Immun.* **2002**, *70*, 5107-5114.
121. Safari, D.; Dekker, H. A. T.; Joosten, J. A. F.; Michalik, D.; de Souza, A. C.; Adamo, R.; Lahmann, M.; Sundgren, A.; Oscarson, S.; Kamerling, J. P.; Snippe, H., *Infect. Immun.* **2008**, *76*, 4615-4623.
122. Kurbatova, E. A.; Akhmatova, N. K.; Akhmatova, E. A.; Egorova, N. B.; Yastrebova, N. E.; Sukhova, E. V.; Yashunsky, D. V.; Tsvetkov, Y. E.; Gening, M. L.; Nifantiev, N. E., *Front. Immunol.* **2017**, *8*.

123. Kurbatova, E. A.; Vorob'ev, D. S.; Akhmatov, E. A.; Akhmatova, N. K.; Egorova, N. B.; Tsvetkov, Y. E.; Sukhova, E. V.; Yashunskii, D. V.; Nifant'ev, N. E., *Bull. Exp. Biol. Med.* **2014**, *157*, 612-615.
124. Deng, S.; Bai, L.; Reboulet, R.; Matthew, R.; Engler, D. A.; Teyton, L.; Bendelac, A.; Savage, P. B., *Chem. Sci.* **2014**, *5*, 1437-1441.
125. Kurbatova, E.; Akhmatova, E.; Akhmatova, N.; Egorova, N.; Yastrebova, N.; Romanenko, E.; Leonova, A. Y.; Poddubikov, A.; Tsvetkov, Y. E.; Sukhova, E., *Russ. Chem. Bull.* **2016**, *65*, 1608-1616.
126. Safari, D.; Marradi, M.; Chiodo, F.; Dekker, H. A. T.; Shan, Y.; Adamo, R.; Oscarson, S.; Rijkers, G. T.; Lahmann, M.; Kamerling, J. P.; Penadés, S.; Snippe, H., *Nanomedicine* **2012**, *7*, 651-662.
127. Vetro, M.; Sfari, D.; Fallarini, S.; Salsabila, K.; Lahmann, M.; Penadés, S.; Lay, L.; Marradi, M.; Compostella, F., *Nanomedicine* **2017**, *12*, 13-23.
128. Bertozzi, C. R.; Kiessling, L., *Science* **2001**, *291*, 2357-2364.
129. Kim, E. Y. L.; Gronewold, C.; Chatterjee, A.; von der Lieth, C.-W.; Kliem, C.; Schmauser, B.; Wiessler, M.; Frei, E., *ChemBioChem* **2005**, *6*, 422-431.
130. François-Heude, M.; Méndez-Ardoy, A.; Cendret, V.; Lafite, P.; Daniellou, R.; Ortiz Mellet, C.; García Fernández, J. M.; Moreau, V.; Djedaïni-Pilard, F., *Chem. Eur. J.* **2015**, *21*, 1978-1991.
131. Sasaki, K.; Nishida, Y.; Tsurumi, T.; Uzawa, H.; Kondo, H.; Kobayashi, K., *Angew. Chem.* **2002**, *114*, 4643-4647.
132. Crich, D.; Yang, F., *Angew. Chem., Int. Ed.* **2009**, *48*, 8896-8899.
133. Cheshev, P.; Marra, A.; Dondoni, A., *Org. Biomol. Chem.* **2006**, *4*, 3225-3227.
134. Lo Conte, M.; Marra, A.; Chambery, A.; Gurcha, S. S.; Besra, G. S.; Dondoni, A., *J. Org. Chem.* **2010**, *75*, 6326-6336.
135. Cendret, V.; Francois-Heude, M.; Mendez-Ardoy, A.; Moreau, V.; Garcia Fernandez, J. M.; Djedaïni-Pilard, F., *Chem. Commun.* **2012**, *48*, 3733-3735.
136. Pieters, R. J., *Org. Biomol. Chem.* **2009**, *7*, 2013-2025.
137. Wittmann, V.; Pieters, R. J., *Chem. Soc. Rev.* **2013**, *42*, 4492-4503.
138. Kale, R. R.; McGannon, C. M.; Fuller-Schaefer, C.; Hatch, D. M.; Flagler, M. J.; Gamage, S. D.; Weiss, A. A.; Iyer, S. S., *Angew. Chem., Int. Ed.* **2008**, *47*, 1265-1268.
139. Braun, P.; Nägele, B.; Wittmann, V.; Drescher, M., *Angew. Chem., Int. Ed.* **2011**, *50*, 8428-8431.
140. Pertici, F.; Pieters, R. J., *Chem. Commun.* **2012**, *48*, 4008-4010.

141. Beckmann, H. S. G.; Möller, H. M.; Wittmann, V., *Beilstein J. Org. Chem* **2012**, *8*, 819-826.
142. Oosta, G. M.; Gardner, W. T.; Beeler, D. L.; Rosenberg, R. D., *Proc. Natl. Acad. Sci. USA* **1981**, *78*, 829-833.
143. Grootenhuis, P. D. J.; Westerduin, P.; Meuleman, D.; Petitou, M.; van Boeckel, C. A. A., *Nat. Struct. Biol.* **1995**, *2*, 736.
144. Westerduin, P.; Basten, J. E. M.; Broekhoven, M. A.; de Kimpe, V.; Kuijpers, W. H. A.; van Boeckel, C. A. A., *Angew. Chem., Int. Ed. Engl.* **1996**, *35*, 331-333.
145. Dreef-Tromp, C. M.; Basten, J. E. M.; Broekhoven, M. A.; van Dinther, T. G.; Petitou, M.; van Boeckel, C. A. A., *Bioorg. Med. Chem. Lett.* **1998**, *8*, 2081-2086.
146. Petitou, M.; van Boeckel, C. A. A., *Angew. Chem., Int. Ed.* **2004**, *43*, 3118-3133.
147. Hahm, H. S.; Broecker, F.; Kawasaki, F.; Mietzsch, M.; Heilbronn, R.; Fukuda, M.; Seeberger, P. H., *Chem* **2017**, *2*, 114-124.
148. Toshiaki, N.; Hiroaki, T.; Akito, S.; Takayuki, N.; Jun-ichi, Y., *Chem. Lett.* **2008**, *37*, 942-943.
149. Hahm, H. S.; Liang, C.-F.; Lai, C.-H.; Fair, R. J.; Schuhmacher, F.; Seeberger, P. H., *J. Org. Chem.* **2016**, *81*, 5866-5877.
150. MacMillan, D. S.; Murray, J.; Sneddon, H. F.; Jamieson, C.; Watson, A. J. B., *Green Chemistry* **2013**, *15*, 596-600.
151. Sabatino, G.; Mulinacci, B.; Alcaro, M. C.; Chelli, M.; Rovero, P.; Papini, A. M., *Lett. Pept. Sci.* **2002**, *9*, 119-123.
152. Salta, J.; Dervedde, J.; Reissig, H.-U., *Beilstein J. Org. Chem* **2015**, *11*, 638-646.
153. Lai, C.-H.; Hahm, H. S.; Liang, C.-F.; Seeberger, P. H., *Beilstein J. Org. Chem* **2015**, *11*, 617-621.
154. Marie-Pierre, C.-C., *Front Microbiol.* **2014**, *5*, 1-10.
155. Armstrong, J. J.; Baddiley, J.; Buchanan, J. G.; Davison, A. L.; Kelemen, M. V.; Neuhaus, F. C., *Nature* **1959**, *184*, 247-248.
156. Brown, S.; Santa Maria, J. P.; Walker, S., *Annu. Rev. Microbiol.* **2013**, *67*, 313-336.
157. Ward, J. B., *Microbiol. Rev.* **1981**, *45*, 211-243.
158. Neuhaus, F. C.; Baddiley, J., *Microbiol. Mol. Biol. Rev.* **2003**, *67*, 686-723.
159. Reichmann, N. T.; Gründling, A., *FEMS Microbiol. Lett.* **2011**, *319*, 97-105.
160. D'Elia, M. A.; Millar, K. E.; Beveridge, T. J.; Brown, E. D., *J. Bacteriol.* **2006**, *188*, 8313-8316.

161. Neuhaus, F. C.; Baddiley, J., *Microbiol. Mol. Biol. Rev.* **2003**, *67*, 686-723.
162. Weidenmaier, C.; Kokai-Kun, J. F.; Kristian, S. A.; Chanturiya, T.; Kalbacher, H.; Gross, M.; Nicholson, G.; Neumeister, B.; Mond, J. J.; Peschel, A., *Nat. Med.* **2004**, *10*, 243-245.
163. D'Elia, M. A.; Pereira, M. P.; Chung, Y. S.; Zhao, W.; Chau, A.; Kenney, T. J.; Sulavik, M. C.; Black, T. A.; Brown, E. D., *J. Bacteriol.* **2006**, *188*, 4183-4189.
164. Fedtke, I.; Mader, D.; Kohler, T.; Moll, H.; Nicholson, G.; Biswas, R.; Henseler, K.; Götz, F.; Zähringer, U.; Peschel, A., *Mol. Microbiol.* **2007**, *65*, 1078-1091.
165. Swoboda, J. G.; Campbell, J.; Meredith, T. C.; Walker, S., *ChemBioChem* **2010**, *11*, 35-45.
166. Araki, Y.; Ito, E., *Crit. Rev. Microbiol.* **1989**, *17*, 121-135.
167. Kojima, N.; Araki, Y.; Ito, E., *J. Bacteriol.* **1985**, *161*, 299-306.
168. Endl, J.; Seidl, P. H.; Fiedler, F.; Schleifer, K. H., *Arch. Microbiol.* **1984**, *137*, 272-80.
169. Vinogradov, E.; Sadovskaya, I.; Li, J.; Jabbouri, S., *Carbohydr. Res.* **2006**, *341*, 738-43.
170. Endl, J.; Seidl, H. P.; Fiedler, F.; Schleider, K. H., *Arch. Microbiol.* **1983**, *135*, 215-223.
171. Naumova, I. B.; Shashkov, A. S.; Tul'skaya, E. M.; Streshinskaya, G. M.; Kozlova, Y. I.; Potekhina, N. V.; Evtushenko, L. I.; Stackebrandt, E., *FEMS Microbiol. Rev.* **2001**, *25*, 269-283.
172. Mirelman, D.; Beck, B. D.; Shaw, D. R., *Biochem. Biophys. Res. Commun.* **1970**, *39*, 712-7.
173. Baddiley, J.; Buchanan, J. G.; Rajbhandary, U. L.; Sanderson, A. R., *Biochem. J.* **1962**, *82*, 439-48.
174. Bernal, P.; Zloh, M.; Taylor, P. W., *J. Antimicrob. Chemother.* **2009**, *63*, 1156-62.
175. Brown, S.; Xia, G.; Luhachack, L. G.; Campbell, J.; Meredith, T. C.; Chen, C.; Winstel, V.; Gekeler, C.; Irazoqui, J. E.; Peschel, A.; Walker, S., *Proc. Natl. Acad. Sci. U. S. A.* **2012**, *109*, 18909-14.
176. Jenni, R.; Berger-Bächi, B., *Arch. Microbiol.* **1998**, *170*, 171-178.
177. Nathenson, S. G.; Ishimoto, N.; Anderson, J. S.; Strominger, J. L., *J. Biol. Chem.* **1966**, *241*, 651-658.
178. van der Es, D.; Hogendorf, W. F. J.; Overkleeft, H. S.; van der Marel, G. A.; Codee, J. D. C., *Chem. Soc. Rev.* **2017**, *46*, 1464-1482.

179. Allison, S. E.; D'Elia, M. A.; Arar, S.; Monteiro, M. A.; Brown, E. D., *J. Biol. Chem.* **2011**, *286*, 23708-23716.
180. Xia, G.; Maier, L.; Sanchez-Carballo, P.; Li, M.; Otto, M.; Holst, O.; Peschel, A., *J. Biol. Chem.* **2010**, *285*, 13405-13415.
181. Sobhanifar, S.; Worrall, L. J.; Gruninger, R. J.; Wasney, G. A.; Blaukopf, M.; Baumann, L.; Lameignere, E.; Solomonson, M.; Brown, E. D.; Withers, S. G.; Strynadka, N. C. J., *Proc. Natl. Acad. Sci. U. S. A.* **2015**, *112*, E576-E585.
182. Koç, C.; Gerlach, D.; Beck, S.; Peschel, A.; Xia, G.; Stehle, T., *J. Biol. Chem.* **2015**, *290*, 9874-9885.
183. Brown, S.; Xia, G.; Luhachack, L. G.; Campbell, J.; Meredith, T. C.; Chen, C.; Winstel, V.; Gekeler, C.; Irazoqui, J. E.; Peschel, A.; Walker, S., *Proc. Natl. Acad. Sci. U. S. A.* **2012**, *109*, 18909-18914.
184. Beaucage, S. L.; Caruthers, M. H., *Tetrahedron Lett.* **1981**, *22*, 1859-1862.
185. Elie, C. J. J.; Muntendam, H. J.; van den Elst, H.; van der Marel, G. A.; van Boom, J. H.; Hoogerhout, P., *Rec. Trav. Chim. Pays-Bas* **1989**, *108*, 219-223.
186. Fekete, A.; Hoogerhout, P.; Zomer, G.; Kubler-Kielb, J.; Schneerson, R.; Robbins, J. B.; Pozsgay, V., *Carbohydr. Res.* **2006**, *341*, 2037-2048.
187. Sonveaux, E., *Bioorg. Chem.* **1986**, *14*, 274-325.
188. Dreef, C. E.; Elie, C. J. J.; Hoogerhout, P.; van der Marel, G. A.; van Boom, J. H., *Tetrahedron Lett.* **1988**, *29*, 6513-6515.
189. Caruthers, M. H.; Barone, A. D.; Beaucage, S. L.; Dodds, D. R.; Fisher, E. F.; McBride, L. J.; Matteucci, M.; Stabinsky, Z.; Tang, J. Y., Chemical synthesis of deoxyoligonucleotides by the phosphoramidite method. In *Methods Enzymol.*, 1987; Vol. 154, pp 287-313.
190. Veeneman, G. H.; van Leeuwen, S. H.; van Boom, J. H., *Tetrahedron Lett.* **1990**, *31*, 1331-1334.
191. Nicolaou, K. C.; Seitz, S. P.; Papahatjis, D. P., *J. Am. Chem. Soc.* **1983**, *105*, 2430-2434.
192. Petitou, M.; Duchaussoy, P.; Lederman, I.; Choay, J.; Sinaÿ, P.; Jacquinet, J.-C.; Torri, G., *Carbohydr. Res.* **1986**, *147*, 221-236.
193. Ercegovic, T.; Meijer, A.; Magnusson, G.; Ellervik, U., *Org. Lett.* **2001**, *3*, 913-915.
194. Crich, D.; Smith, M., *J. Am. Chem. Soc.* **2001**, *123*, 9015-9020.
195. Durón, S. G.; Polat, T.; Wong, C.-H., *Org. Lett.* **2004**, *6*, 839-841.

196. Tatai, J.; Fügedi, P., *Org. Lett.* **2007**, *9*, 4647-4650.
197. Nokami, T.; Shibuya, A.; Tsuyama, H.; Suga, S.; Bowers, A. A.; Crich, D.; Yoshida, J.-i., *J. Am. Chem. Soc.* **2007**, *129*, 10922-10928.
198. Wever, W. J.; Cinelli, M. A.; Bowers, A. A., *Org. Lett.* **2013**, *15*, 30-33.
199. Goswami, M.; Ellern, A.; Pohl, N. L. B., *Angew. Chem., Int. Ed.* **2013**, *52*, 8441-8445.
200. Vibhute, A. M.; Dhaka, A.; Athiyarath, V.; Sureshan, K. M., *Chem. Sci.* **2016**, *7*, 4259-4263.
201. Basu, N.; Maity, S. K.; Chaudhury, A.; Ghosh, R., *Carbohydr. Res.* **2013**, *369*, 10-13.
202. Tsai, T. Y. R.; Jin, H.; Wiesner, K., *Can. J. Chem.* **1984**, *62*, 1403-1405.
203. Garegg, P. J.; Henrichson, C.; Norberg, T., *Carbohydr. Res.* **1983**, *116*, 162-165.
204. Lönn, H., *Carbohydr. Res.* **1985**, *139*, 105-113.
205. Reddy, G. V.; Kulkarni, V. R.; Mereyala, H. B., *Tetrahedron Lett.* **1989**, *30*, 4283-4286.
206. Fügedi, P.; Garegg, P. J., *Carbohydr. Res.* **1986**, *149*, C9-C12.
207. Dasgupta, F.; Garegg, P. J., *Carbohydr. Res.* **1988**, *177*, c13-c17.
208. Dasgupta, F.; Garegg, P. J., *Carbohydr. Res.* **1990**, *202*, 225-238.
209. Veeneman, G. H.; van Boom, J. H., *Tetrahedron Lett.* **1990**, *31*, 275-278.
210. Veeneman, G. H.; Van Leeuwen, S. H.; Zuurmond, H.; Van Boom, J. H., *J. Carbohydr. Chem.* **1990**, *9*, 783-796.
211. Lear, M. J.; Yoshimura, F.; Hiramata, M., *Angew. Chem., Int. Ed.* **2001**, *40*, 946-949.
212. Hahm, H. S.; Hurevich, M.; Seeberger, P. H., *Nat. Commun.* **2016**, *7*, 12482.
213. Fair, R. J.; Hahm, H. S.; Seeberger, P. H., *Chem. Commun.* **2015**, *51*, 6183-6185.
214. Dasgupta, F.; Garegg, P. J., *Carbohydr. Res.* **1988**, *177*, c13-c17.
215. Martichonok, V.; Whitesides, G. M., *J. Org. Chem.* **1996**, *61*, 1702-1706.
216. Huang, X.; Huang, L.; Wang, H.; Ye, X.-S., *Angew. Chem., Int. Ed.* **2004**, *43*, 5221-5224.
217. Virgil, S. C. In *1,3-Dibromo-5,5-dimethylhydantoin* 2001 John Wiley & Sons, Ltd.; pp 1-2.
218. Kolvari, E.; Ghorbani-Choghamarani, A.; Salehi, P.; Shirini, F.; Zolfigol, M. A., *J. Iran. Chem. Soc.* **2007**, *4*, 126-174.
219. Madhusudan, S. K.; Misra, A. K., *Carbohydr. Res.* **2005**, *340*, 497-502.

220. Madhusudan, S. K.; Misra, A. K., *Eur. J. Org. Chem.* **2005**, *2005*, 3196-3205.
221. Bai, Y.; Lowary, T. L., *J. Org. Chem.* **2006**, *71*, 9658-9671.
222. El Hadri, A.; Petitou, M. Synthetic pentasaccharides having short half-life and high activity. WO2012172104A1, 2012.
223. Viuff, A. H.; Besenbacher, L. M.; Kamori, A.; Jensen, M. T.; Kilian, M.; Kato, A.; Jensen, H. H., *Org. Biomol. Chem.* **2015**, *13*, 9637-9658.
224. Lindberg, J.; Svensson, S. C. T.; Pålsson, P.; Konradsson, P., *Tetrahedron* **2002**, *58*, 5109-5117.
225. Watt, G. M.; Boons, G.-J., *Carbohydr. Res.* **2004**, *339*, 181-193.
226. Lisboa, M. P.; Khan, N.; Martin, C. E.; Xu, F.-F.; Reppe, K.; Geissner, A.; Witzernath, M.; Govindan, S.; Pereira, C. L.; Seeberger, P. H., *Proc. Natl. Acad. Sci. USA* **2017**, *Submitted*.
227. DeNinno, M. P.; Etienne, J. B.; Duplantier, K. C., *Tetrahedron Lett.* **1995**, *36*, 669-672.
228. Chassaing, C.; Haudrechy, A.; Langlois, Y., *Tetrahedron Lett.* **1997**, *38*, 4415-4416.
229. Ekholm, F. S.; Ardá, A.; Eklund, P.; André, S.; Gabius, H.-J.; Jiménez-Barbero, J.; Leino, R., *Chem. Eur. J.* **2012**, *18*, 14392-14405.
230. Braccini, I.; Derouet, C.; Esnault, J.; du Penhoat, C. H.; Mallet, J. M.; Michon, V.; Sinaÿ, P., *Carbohydr. Res.* **1993**, *246*, 23-41.
231. Kalikanda, J.; Li, Z., *J. Org. Chem.* **2011**, *76*, 5207-5218.
232. Seeberger, P. H., *Acc. Chem. Res.* **2015**, *48*, 1450-1463.
233. Martin, C. E.; Weishaupt, M. W.; Seeberger, P. H., *Chem. Commun.* **2011**, *47*, 10260-10262.
234. Kapoor, M.; Srinivas, H.; Kandiah, E.; Gemma, E.; Ellgaard, L.; Oscarson, S.; Helenius, A.; Surolia, A., *J. Biol. Chem.* **2003**, *278*, 6194-6200.
235. Dhenin, S. G. Y.; Moreau, V.; Nevers, M.-C.; Creminon, C.; Djedaini-Pilard, F., *Org. Biomol. Chem.* **2009**, *7*, 5184-5199.
236. van der Es, D.; Groenia, N. A.; Laverde, D.; Overkleeft, H. S.; Huebner, J.; van der Marel, G. A.; Codée, J. D. C., *Bioorg. Med. Chem.* **2016**, *24*, 3893-3907.
237. Carmona, A. T.; Moreno-Vargas, A. J.; Robina, I., *Adv. Org. Synth.* **2013**, *6*, 238-295.
238. Nigudkar, S. S.; Demchenko, A. V., *Chem. Sci.* **2015**, *6*, 2687-2704.
239. Bohé, L.; Crich, D., *Carbohydr. Res.* **2015**, *0*, 48-59.

240. Capon, B., *Chem. Rev.* **1969**, *69*, 407-498.
241. Bohé, L.; Crich, D., *C. R. Chim.* **2011**, *14*, 3-16.
242. Frihed, T. G.; Bols, M.; Pedersen, C. M., *Chem. Rev.* **2015**, *115*, 4963-5013.
243. Crich, D., *Acc. Chem. Res.* **2010**, *43*, 1144-1153.
244. Crich, D.; Dai, Z.; Gastaldi, S., *J. Org. Chem.* **1999**, *64*, 5224-5229.
245. Bock, K.; Pedersen, C., *Acta Chem. Scand.* **1973**, *27*, 2701-2709.
246. Olah, G. A.; Baker, E. B.; Evans, J. C.; Tolgyesi, W. S.; McIntyre, J. S.; Bastien, I. J., *J. Am. Chem. Soc.* **1964**, *86*, 1360-1373.
247. Olah, G. A.; Bollinger, J. M., *J. Am. Chem. Soc.* **1967**, *89*, 2993-2996.
248. Martin, A.; Arda, A.; Désiré, J.; Martin-Mingot, A.; Probst, N.; Sinaÿ, P.; Jiménez-Barbero, J.; Thibaudeau, S.; Blériot, Y., *Nat. Chem.* **2015**, *8*, 186-191.
249. Rudić, S.; Xie, H.-b.; Gerber, R. B.; Simons, J. P., *Mol. Phys.* **2012**, *110*, 1609-1615.
250. Sagar, R.; Rudic, S.; Gamblin, D. P.; Scanlan, E. M.; Vaden, T. D.; Odell, B.; Claridge, T. D. W.; Simons, J. P.; Davis, B. G., *Chem. Sci.* **2012**, *3*, 2307-2313.
251. Polfer, N. C.; Valle, J. J.; Moore, D. T.; Oomens, J.; Eyler, J. R.; Bendiak, B., *Anal. Chem.* **2006**, *78*, 670-679.
252. Oomens, J.; Sartakov, B. G.; Meijer, G.; von Helden, G., *Int. J. Mass spectrom.* **2006**, *254*, 1-19.
253. González Flórez, A. I.; Mucha, E.; Ahn, D.-S.; Gewinner, S.; Schöllkopf, W.; Pagel, K.; von Helden, G., *Angew. Chem., Int. Ed.* **2016**, *55*, 3295-3299.
254. Mucha, E.; González Flórez, A. I.; Marianski, M.; Thomas, D. A.; Hoffmann, W.; Struwe, W. B.; Hahm, H. S.; Gewinner, S.; Schöllkopf, W.; Seeberger, P. H.; von Helden, G.; Pagel, K., *Angew. Chem., Int. Ed.* **2017**, *56*, 11248-11251.
255. Cancogni, D.; Lay, L., *Synlett* **2014**, *25*, 2873-2878.
256. Lin, Y. H.; Ghosh, B.; Tony Mong, K.-K., *Chem. Commun.* **2012**, *48*, 10910-10912.
257. Zemplén, G.; Kunz, A., *Ber. Dtsch. Chem. Ges.* **1923**, *56*, 1705-1710.
258. Qin, H.; Grindley, T. B., *J. Carbohydr. Chem.* **1996**, *15*, 95-108.
259. Calosso, M.; Tambutet, G.; Charpentier, D.; St-Pierre, G.; Vaillancourt, M.; Bencheqroun, M.; Gratton, J.-P.; Prévost, M.; Guindon, Y., *ACS Med. Chem. Lett.* **2014**, *5*, 1054-1059.
260. Birch, A. J., *J. Chem. Soc.* **1944**, 430-436.
261. Bhattacharjee, S. S.; Gorin, P. A. J., *Carbohydr. Res.* **1970**, *12*, 57-68.

-
262. Angles d'Ortoli, T.; Widmalm, G., *Tetrahedron* **2016**, *72*, 912-927.
263. Cooper, G.; Edwards, M.; Rosenstein, C., *J. Exp. Med.* **1929**, *49*, 461-474.
264. Ravenscroft, N.; Jones, C., *Curr. Opin. Drug Discov Dev.* **2000**, *3*, 222-231.
265. Arungundram, S.; Al-Mafraji, K.; Asong, J.; Leach, F. E.; Amster, I. J.; Venot, A.; Turnbull, J. E.; Boons, G.-J., *J. Am. Chem. Soc.* **2009**, *131*, 17394-17405.
266. Lisboa, M. P.; Khan, N.; Martin, C.; Xu, F.-F.; Reppe, K.; Geissner, A.; Govindan, S.; Witzernath, M.; Pereira, C. L.; Seeberger, P. H., *Proc. Natl. Acad. Sci. USA* **2017**, *114*, 11063-11068.